

THE KW107 SUPERMATCH ATU

manual, courtesy of Barry – G0DWZ

I've copied the following directly from the KW107 manual without alteration. To clear up one or two ambiguous points, I have added my own comments at the end of the manual. My thanks to Barry G0DWZ for photocopying the manual. 73 de G4NSJ – Ray.



The KW107 Supermatch is a combination of the following KW products, all in one cabinet.

- 1/ KW E-Z Match ATU.
- 2/ KW103 SWR/Watt meter.
- 3/ KW Antenna switch.
- 4/ KW Dummy load.

The cabinet is the same as used for the KW2000A/B AC power supply and exactly matches the KW2000A/B/D/E, KW Vespa, KW204, KW1000, KW202, etc. The KW107 Supermatch enables the output of a transmitter to be matched to an antenna system and provides additional protection against TVI, over the bands 10-80 metres. Standing Wave Ratio on the antenna can be compared with the purely resistive dummy load or the dummy load can be used to load the transmitter before the antenna is connected for matching by means of the E-Z Match circuitry.

The Watt meter is calibrated in two ranges, 0-100 and 0-1000 Watts. The selector switch provides output from the transmitter, through the E-Z Match, to two different antennas. In addition to the coaxial sockets at the rear of the unit, there are two pairs of sockets for use with balanced feeders; these sockets are NOT switched.

A popular arrangement for the KW107 Supermatch is the permanent connection of the KW Trap Doublet for 80 and 40 metre operation and a tri-band beam for 10, 15 and 20 metres. The correct antenna can be switched to the appropriate band by means of the selector switch. These positions can be used for transmission if required.

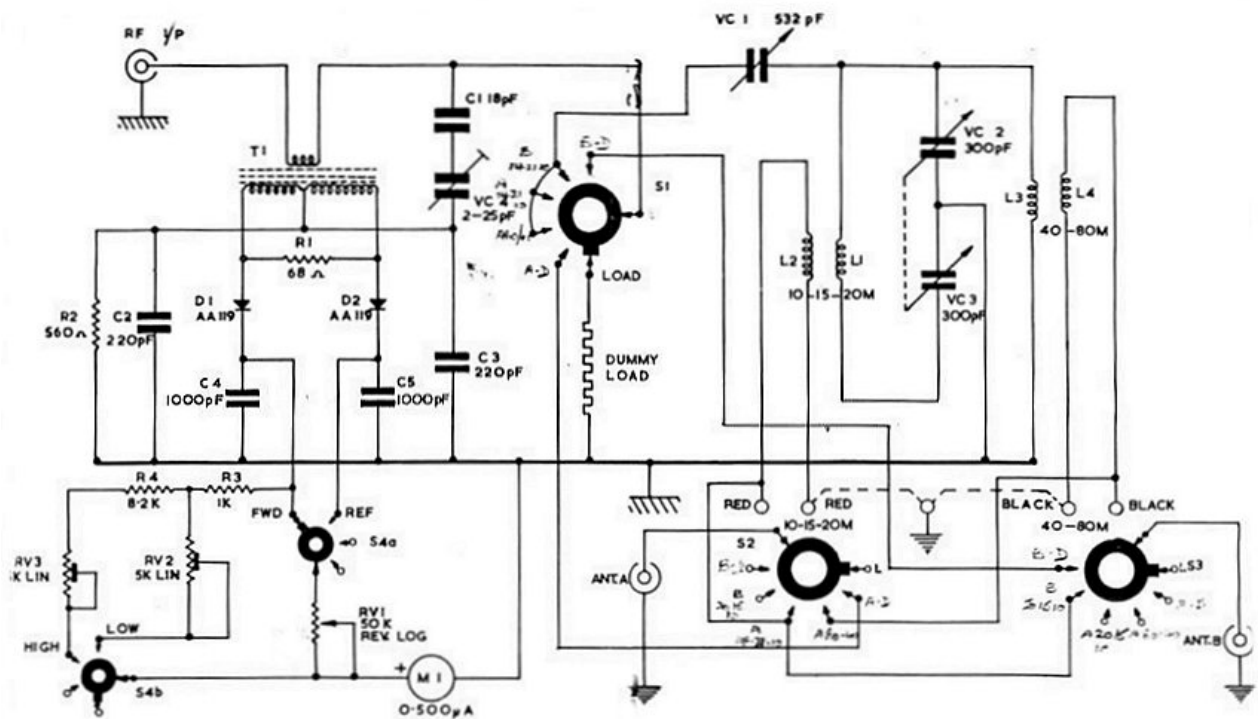

KW 107 SUPERMatch Circuit Diagram

FRONT PANEL

The controls on the front panel are METER SENSITIVITY for setting the SWR meter to full scale when meter switch is in FWD position. FWD-REFL-HIGH-LOW for switching the meter to SWR forward voltage, SWR reverse voltage, Watt meter high power and Watt meter low power. The meter is 3-1/4" square, directly calibrated in standing wave ratio and Watts with two ranges – 0-100 Watts and 0-1000 Watts. The two tuning controls used for tuning the E-Z Match are equipped with slow-motion drives. The main switch is a six-way three-pole heavy duty ceramic switch with the following positions – ANT. A DIRECT – ANT. A 80/40 – ANT. A 20/15/10 – ANT. B 20/15/10 – ANT. B DIRECT.

REAR PANEL

All coaxial sockets are SO239 (UHF) type and require PL259 matching connectors (not supplied). Mounted on the rear panel are three SO239 sockets for the antenna connections including one for the input socket to which the output of the transmitter is connected. A square hole is provided for an extra socket, if required. Two pairs of terminals are also provided for use with balance feeders.

FREQUENCY RANGE

Amateur bands are covered in two ranges, 80-40 metres and 20, 15 and 10 metres. The

internal and external connections of the KW107 must be arranged so that the appropriate antenna is connected to the antenna tuner proper output terminals. Other possible arrangements for using more than two antenna systems can be accommodated by the simple modification to the circuits provided.

GENERAL CHARACTERISTICS

The KW107 Supermatch will match an antenna feed impedance of approx. 30-2500 ohms on 10, 15 and 20 metres and 30-1000 ohms on 40 and 80 metres. Power restrictions on the unit apply mainly to the E-Z Match ATU. This part of the unit is suitable for transmitters with 1KW PEP and at the other end of the scale, 50 Watts PEP minimum for full-scale indication. The selector switch wafers are ceramic and are operated well within their ratings when the other limitations are observed. It is recommended that reduced power be used when adjusting the E=Z Match until a good SWR is achieved.

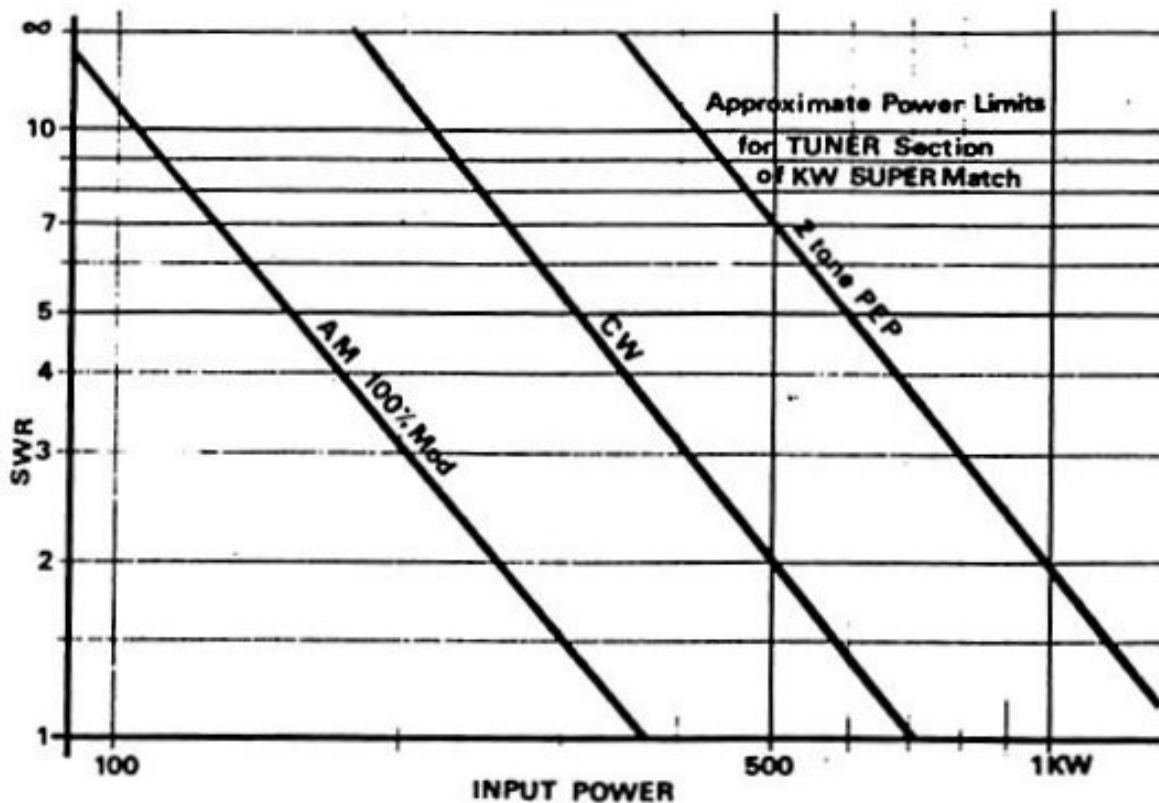

OPERATING INSTRUCTIONS

- 1/ Turn selector switch to LOAD.
- 2/ Turn meter switch to HIGH POWER or LOW POWER depending on the transmit power of your equipment.
- 3/ Tune up transmitter into the LOAD observing limitations described in the paragraph on the DUMMY LOAD.

- 4/ Adjust transmitter to about 15 Watts output and go back the receive.
- 5/ Turn selector switch to desired antenna using E-Z Match – ANT. A 80/40 – ANT. A 20/15/10 or ANT. B 20/15/10.
- 6/ Tune the receiver to a signal near the operating frequency.
- 7/ Adjust the two tuning controls for maximum receive signal.
- 8/ Turn meter switch to SWR-FWD.
- 9/ Turn on transmitter and adjust SWR sensitivity control to give full scale on meter.
- 10/ Turn meter switch to SWR REFL.
- 11/ Carefully adjust tuning controls to give minimum SWR (in most cases an SWR of 1:1 should be possible).
- 12/ Record the position of the tuning controls for easy reference.

NOTE: 1

When first tuning the Supermatch on a new frequency or new antenna, ALWAYS adjust the transmitter into the dummy load as a first step. This ensures that the transmitter is tuned and loaded correctly.

NOTE: 2

If the antenna SWR is high, and it is not possible to achieve a 1:1 SWR through the tuner, lengthening or shortening the feed line may make a match possible.

USE OF BALANCED FEED LINES

If 400-600 ohm balanced feeders are used for both 80/40 metre antenna and the 10/15/10 metre antenna, appropriate knife switches (DPST) must be used to disconnect the unused feeders. DO NOT OPERATE the KW107 Supermatch with CONNECTIONS MADE TO BOTH OUTPUTS. When a coaxial feeder is used for one antenna and balanced feeders are also used ON THE SAME RANGE, a DPST knife switch must be used so that the appropriate terminal can be grounded for the coax line. The knife switch must be mounted CLOSE to the Supermatch so that the ground lead is SHORT.

Should an antenna be employed using 75 ohm twin feeder, we recommend a balun (such as the KW Balun 75/75 ohm) be used and mounted immediately behind the KW107 Supermatch. Connection by about 6 inches coax cable between input to balun and SO239 sockets A or B at rear of KW107. The twin feeder is terminated at the balun “antenna” connections.

USE OF MORE THAN TWO ANTENNAE

Up to three additional antennas can be switched on the 20/15/10M or 40/80M outlets provided on the KW107 Supermatch by employing a KW ANTENNA SWITCH.

INSTRUCTIONS FOR REMOVING CABINET

Carefully remove the unit from the cabinet as follows:

- 1/ Remove front feet.
- 2/ Remove two screws at the bottom rear of the cabinet.
- 3/ Remove the nickel-plated screw on the top front of the cabinet (take care not to damage the cabinet). Use the correct size screwdriver which is not blunted to remove this screw.
- 4/ Slowly and carefully slide the unit out of the front of the cabinet taking care not to scratch the painted cast escutcheon ring.
- 5/ Set the cabinet aside and away from the work area so it will not get scratched.

DUMMY LOAD

The power limitation of the dummy load is in the temperature rise of the “skin” of the resistor which must not exceed 300C. This means that 1KW can be applied for 5 seconds max time. 100 Watts raises the temperature to the limit in about 6 minutes, and 50 Watts can be run for 20 minutes.

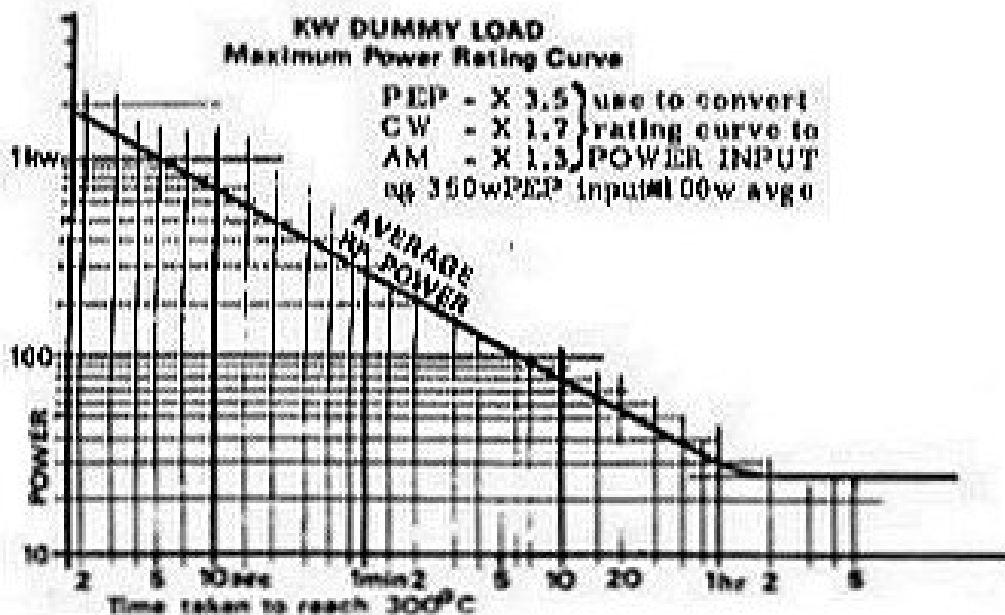

ADDITIONAL NOTES

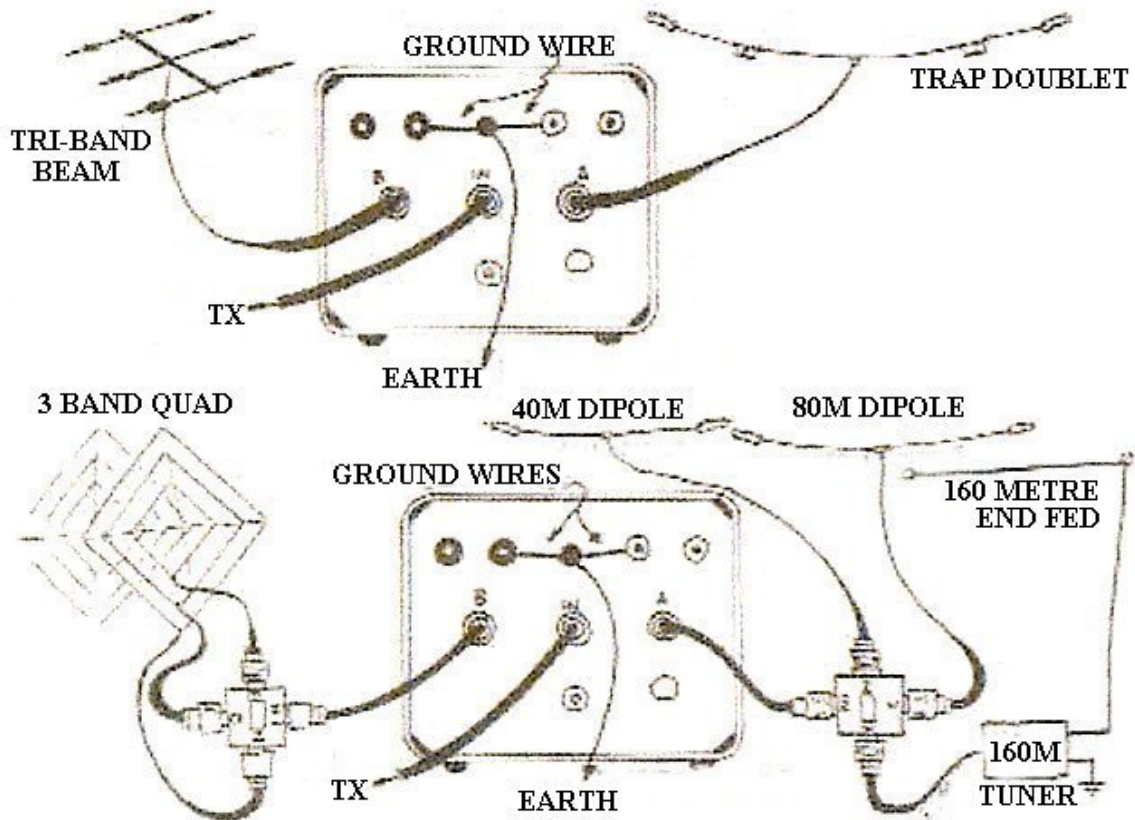

BACK PANEL - SUGGESTED AERIAL CONNECTIONS

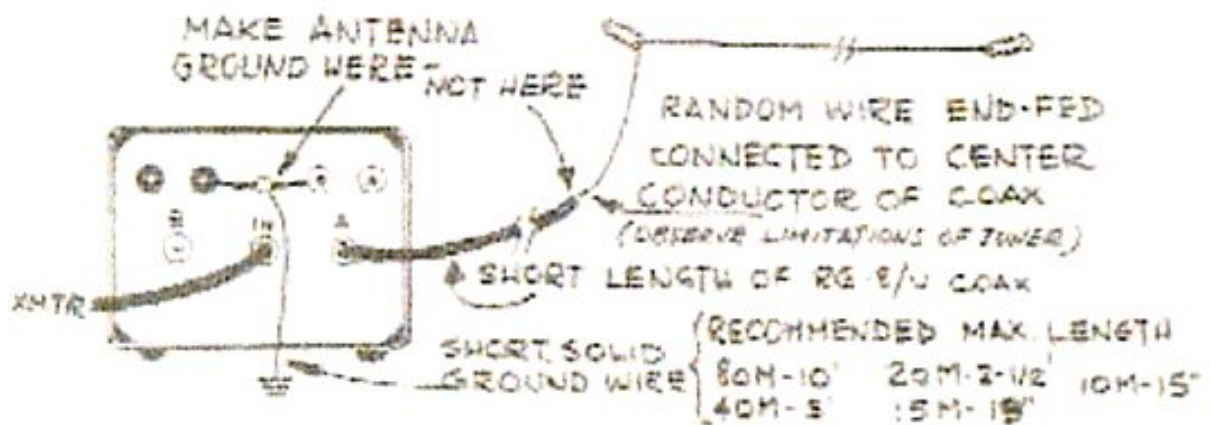

I'm not sure that I agree with the short length of coax in the above diagram. However, this is what KW suggest so I suppose it's worth trying. Personally, I'd connect the end of the wire aerial to one of the balanced terminals and earth the other terminal. In other words, leave things as they are in the above diagram but take the end fed wire to the right or left hand balanced terminals.

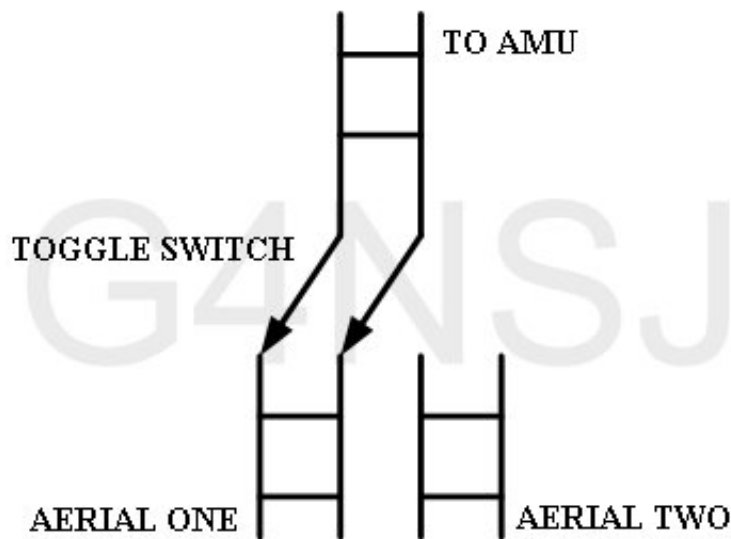

MY ARRANGEMENT FOR SWITCHING BETWEEN TWO AERIALS

Above is the arrangement I've used for switching between two 300 ohm balanced feeders. I used a mains-type DPDT toggle switch, which seems to take 100 Watts without burning up. This saves a lot of arsing about behind the KW when changing aerials.

AMU BALANCED OUTPUT

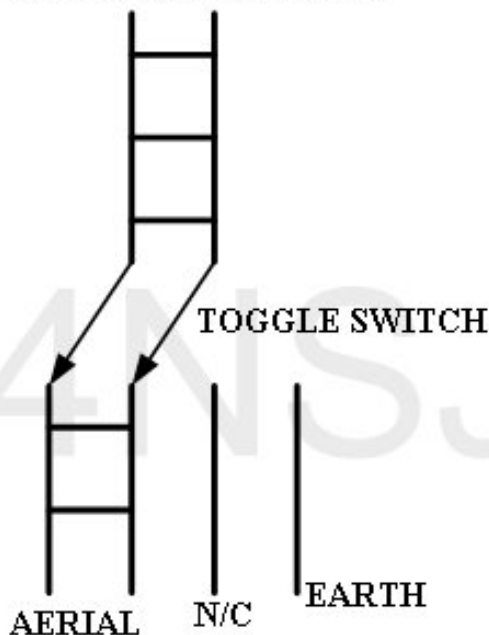

THIS IS HOW I SWITCH THE BALANCED LINE IN AND OUT

When using a coax-fed aerial, I disconnect the 300 ohm balanced feeder and earth the inner balanced output terminal by using a mains-type toggle switch, as in the diagram above. Again, this saves diving behind the KW when changing aerials.

A GOOD DESIGN FOR BUILDING YOUR OWN BALANCED AMU

The basic circuit of the KW107, minus switching etc, is shown below. This is a good basis for designing and building your own aerial matching unit. You'll notice that there are no lossy baluns in the design. Also, the SWR and POWER meter circuit is useful.

