

# ELECRAFT®

## KAT500 AUTOMATIC ANTENNA TUNER



## OWNER'S MANUAL

Revision C6, March 8, 2017

E740183

Copyright © 2017, Elecraft, Inc.

All Rights Reserved

# Contents

Introduction.....	1
Quick Start.....	1
Customer Service and Support .....	1
Technical Assistance.....	1
Repair / Alignment Service.....	1
Specifications.....	2
Setup .....	3
Elecraft K3 Transceiver and KPA500 Amplifier.....	3
Placement.....	3
Firmware.....	3
Cabling.....	3
Icom Transceivers with AH-4 ATU Interface.....	8
Cabling.....	8
Other Transceiver and Amplifier or Stand-Alone Transceiver.....	11
Operation .....	14
Front Panel Controls and Indicators.....	14
Key Line Hot Switching.....	15
Tune Operation and Memories.....	16
Tune Operation .....	16
Memories .....	16
Bandswitching.....	17
Elecraft K3 and KPA500 Amplifier Combination.....	17
Non-Elecraft Amplifiers .....	17
Operating Tips.....	18
Rapid QSY After Antenna Change:.....	18
Automatic Bypass on Selected Bands:.....	18
Fault Conditions .....	19
Utility Program .....	20
KAT500 Configuration .....	20
Amplifier Key Interrupt Power .....	20
Antennas.....	20
VSWR Thresholds .....	21
Erase Memories.....	21

Saving Configuration .....	21
Reset to Factory Default .....	21
Updating Firmware .....	21
<i>Forcing a Firmware Load</i> .....	22
Kit Assembly Procedure .....	23
Preventing Electrostatic Discharge Damage .....	23
Tools Required .....	23
Assembly Procedure.....	24
Appendix A Parts List .....	42
KAT500 Cable Set .....	42
KAT500 Circuit Board.....	42
KAT500 Core Assembly – E850561 .....	43
Wrapped Covers E850565 .....	43
Wrapped Panels E850564 .....	43
Miscellaneous Bag E850562.....	44
Ant 1 SO-239 Assembly E850553.....	46
Ant 2 SO-239 Assembly E850560.....	46
Ant 3 SO-239 Assembly E850559.....	46
XMTR SO-239 Assembly E850554 .....	47



Elecraft manuals with color images may be downloaded from

[www.elecraft.com](http://www.elecraft.com).

# Introduction

The KAT500 Automatic Antenna Tuner is designed to be closely integrated with the Elecraft K3 transceiver and the Elecraft KPA500 amplifier although it may be easily used with other transceivers and amplifiers. Features include:

- Automatic band switching, covering the spectrum from 1.8 through 54 MHz.
- Automatic antenna switching to connect one of three antennas according to the band selected.
- L and C settings for lowest SWR are stored in memory for extremely rapid frequency and band changes.
- Robust self-protection circuits that guard against damage from switching high-power RF or trying to match loads outside of its tuning range.
- Static bleed resistor built in to avoid damage from normal static buildup on antennas.
- Low profile enclosure that matches the footprint of the KPA500 and K3, allowing the KAT500 to be placed on top or under either unit (the KAT500 is designed to support the weight of the KPA500).

**⚠ If you purchased your KAT500 as a kit, turn to page 23 for assembly instructions.**

## Quick Start

To quickly set up and get started with your KAT500 Automatic Antenna Tuner, turn to page 3 to hook up the unit and page 14 for operating instructions.

## Customer Service and Support

### *Technical Assistance*

You can send e-mail to [k3support@elecraft.com](mailto:k3support@elecraft.com) and we will respond quickly - typically the same day Monday through Friday. Telephone assistance is available from 9 A.M. to 5 P.M. Pacific time (weekdays only) at 831-763-4211. Please use e-mail rather than calling when possible since this gives us a written record of the details of your problem and allows us to handle a larger number of requests each day.

### *Repair / Alignment Service (We want to make sure everyone succeeds!)*

If necessary, you may return your Elecraft product to us for repair or alignment. (Note: We offer unlimited email and phone support to get your kit running, so please try that route first as we can usually help you find the problem quickly.)

**IMPORTANT: You must contact Elecraft before mailing your product** to obtain authorization for the return, what address to ship it to and current information on repair fees and turnaround times. (Frequently we can determine the cause of your problem and save you the trouble of shipping it back to us.) Our repair location is different from our factory location. We will give you the address to ship your kit to at the time of repair authorization. *Packages shipped to Elecraft without authorization will incur an additional shipping charge for reshipment to our repair depot.*

## Elecraft's 1-Year Limited Warranty

This warranty is effective as of the date of first consumer purchase (or if shipped from the factory, the date the product is shipped to the customer). It covers both our kits and fully assembled products. For kits, before requesting warranty service, you should fully complete the assembly, carefully following all instructions in the manual.

**Who is covered:** This warranty covers the original owner of the Elecraft product as disclosed to Elecraft at the time of order. Elecraft products transferred by the purchaser to a third party, either by sale, gift, or other method, who is not disclosed to Elecraft at the time of original order, are not covered by this warranty. If the Elecraft product is being bought indirectly for a third party, the third party's name and address must be provided at time of order to ensure warranty coverage.

**What is covered:** During the first year after date of purchase, Elecraft will replace defective or missing parts free of charge (post-paid). We will also correct any malfunction to kits or assembled units caused by defective parts and materials. Purchaser pays inbound shipping to us for warranty repair; we pay shipping to return the repaired equipment to you by UPS ground service or equivalent to the continental USA and Canada. For Alaska, Hawaii, and other destinations outside the U.S. and Canada, actual return shipping cost is paid by the owner.

**What is not covered:** This warranty does not cover correction of kit assembly errors. It also does not cover misalignment; repair of damage caused by misuse, negligence, battery leakage or corrosion, or builder modifications; or any performance malfunctions involving non-Elecraft accessory equipment. The use of acid-core solder, water-soluble flux solder, or any corrosive or conductive flux or solvent will void this warranty in its entirety. Also not covered is reimbursement for loss of use, inconvenience, customer assembly or alignment time, or cost of unauthorized service.

**Limitation of incidental or consequential damages:** This warranty does not extend to non-Elecraft equipment or components used in conjunction with our products. Any such repair or replacement is the responsibility of the customer. Elecraft will not be liable for any special, indirect, incidental or consequential damages, including but not limited to any loss of business or profits.

## Specifications

<b>Frequency Range</b>	1.8 to 54 MHz, continuous.								
<b>Supply Voltage and Current</b>	11 to 15 VDC, 1.0 A max (200 mA typical).								
<b>Weight</b>	4.6 lbs (2.1 kg).								
<b>Size</b>	Enclosure only, 1.5 x 10.8 x 10.0 in., HWD (3.8 x 27.4 x 25.4 cm). With projections, 1.75 x 10.8 x 11.8 in. (4.4 x 28.4 x 30.0 cm). The projections are the bottom feet and the cable connectors on the rear.								
<b>Typical Matching Range and Power Limits</b>	<table border="0" style="width: 100%;"> <tr> <td style="width: 30%;">3 — 30 MHz</td> <td>600 W into 5 Ω to 500 Ω (10:1 SWR).</td> </tr> <tr> <td></td> <td>1000 W into 16 Ω to 150 Ω (3:1 SWR).</td> </tr> <tr> <td>1.8 — 2 MHz</td> <td>600 W into 10 Ω to 500 Ω (5:1 Low Impedance, 10:1 High Impedance SWR).</td> </tr> <tr> <td>30 — 60 MHz</td> <td>500 W into 5:1 SWR (10 Ω to 250 Ω).</td> </tr> </table> <p style="margin-left: 20px;"><i>Matching specified to a 1.0:1 to 1.6:1 output SWR. Power rating is ICAS (Intermittent Commercial and Amateur Service: equal time on and off, 5 min., max. at full power.)</i></p>	3 — 30 MHz	600 W into 5 Ω to 500 Ω (10:1 SWR).		1000 W into 16 Ω to 150 Ω (3:1 SWR).	1.8 — 2 MHz	600 W into 10 Ω to 500 Ω (5:1 Low Impedance, 10:1 High Impedance SWR).	30 — 60 MHz	500 W into 5:1 SWR (10 Ω to 250 Ω).
3 — 30 MHz	600 W into 5 Ω to 500 Ω (10:1 SWR).								
	1000 W into 16 Ω to 150 Ω (3:1 SWR).								
1.8 — 2 MHz	600 W into 10 Ω to 500 Ω (5:1 Low Impedance, 10:1 High Impedance SWR).								
30 — 60 MHz	500 W into 5:1 SWR (10 Ω to 250 Ω).								
<b>Autotune Power Range</b>	<p>7 W —100 W.</p> <p><i>For better matching accuracy, tune with &gt;20 W.</i></p>								

# Setup

To provide maximum flexibility and the most convenient operation with your existing equipment, there are several ways you can connect the KAT500 to your station.

The following cabling diagrams show how to use the KAT500 with any transceiver and amplifier in the 20 to 1,000 watt output range. Choose the one that fits your station needs:

- Elecraft K3 transceiver and KPA500 amplifier.
- Icom transceiver and amplifier equipped with the Icom AH-4 ATU interface.
- Other transceiver and any amplifier.

**⚠ NOTE: Although the KAT500 works equally well with either a transceiver or a stand-alone transmitter, transceiver is used throughout this manual for simplicity.**

Three cables are supplied with your KAT500:

- Computer interface cable, either the KXUSB (USB port) or KXSER (serial port) cable chosen when you ordered your KAT500. The KXSER cable may be in a bag marked E850369.
- Power cable.
- Key Line cable with RCA type male connectors.

## Elecraft K3 Transceiver and KPA500 Amplifier

### *Placement*

The KAT500 may be placed under or above either the Elecraft K3 transceiver or the KPA500 amplifier. The KAT500 can easily handle the weight of the KPA500 amplifier.

Although the KAT500's feet do not provide the full clearance recommended in the KPA500 Owner's manual, they provide adequate clearance for cooling air to enter the KPA500 for typical operation with low duty-cycle modes (e.g. CW or voice SSB). Operation at higher duty-cycles (e.g. contesting, RTTY, etc.) will cause the amplifier temperature to increase, resulting in higher speed cooling fan operation. For those cases we recommend placing the KAT500 underneath or alongside the KPA500.

### *Firmware*

We strongly recommend that you update your K3 and KPA500 with the latest firmware available from [www.elecraft.com](http://www.elecraft.com). Details about how to do this are in your K3 and KPA500 Owner's manuals. This may not be necessary in every case, but it will help avoid the possibility of some functions not working as expected.

### *Cabling*

The Elecraft K3 and KPA500 amplifier normally use the E850463 Aux interface cable that communicates band selection and other information between the K3 and KPA500. The KAT500 can be included in the E850463 Aux interface path and use the data to switch to the correct band along with the K3 and KPA500. Although not strictly required, the E850463 Aux cable provides the best integration of the KAT500, KPA500 and K3 equipment.

In addition to the supplied cables, you will need two E850463 Aux cables. Normally you will have one already connected between your K3 and KPA500, so you may need one additional cable. This is the same cable included in the KPAK3AUX cable set. You can purchase the cable from Elecraft (order E850463) or, you can construct your own cable using male and female DB-15 connectors wired as follows.

**⚠ IMPORTANT**

**Do not use standard VGA cables. The E850463 Aux cables are wired differently.**

Table 1. E850463 Aux Cable Wiring.

CONNECTOR PINS		SIGNAL
2	2	AUXBUS
3	3	BAND 1
5	5	GND
9	9	BAND 2
10	10	PTT (or KEY)
11	11	Inhibit
12	12	GND
13	13	BAND0
14	14	BAND3
15	15	ALC (Normally not used. See your KPA500 Owner's Manual)

The basic E850463 Aux cabling setup is shown in Figure 1. If your station setup requires that other equipment (e.g. SteppIR controller) have access to the key line to inhibit the amplifier, use the cabling described in Figure 2.

**① 50-ohm coaxial RF cables with PL-259 connectors.**

- Be sure you select the antenna output on the K3 that connects to the KPA500.
- The KAT500 allows up to three antenna connections, selected from the front panel (See *Operation*, page 14).

**② Two wire power cable with a female 2.1 mm coaxial connector.**

- Connect to the station 11 to 15 VDC power supply with the white striped lead to the positive terminal.

**③ Computer interface cable.**

- Not required, but used for controlling the KAT500 from a personal computer, customizing the KAT500's operation or for updating firmware (see *Utility Program* on page 20).

**④ E850463 Aux interface cables with male and female connectors.**

- Do not use common VGA cables; they are not wired correctly for this use. You can order E850463 from Elecraft or you can make your own (See *E850463 Aux Cable Wiring*, above).

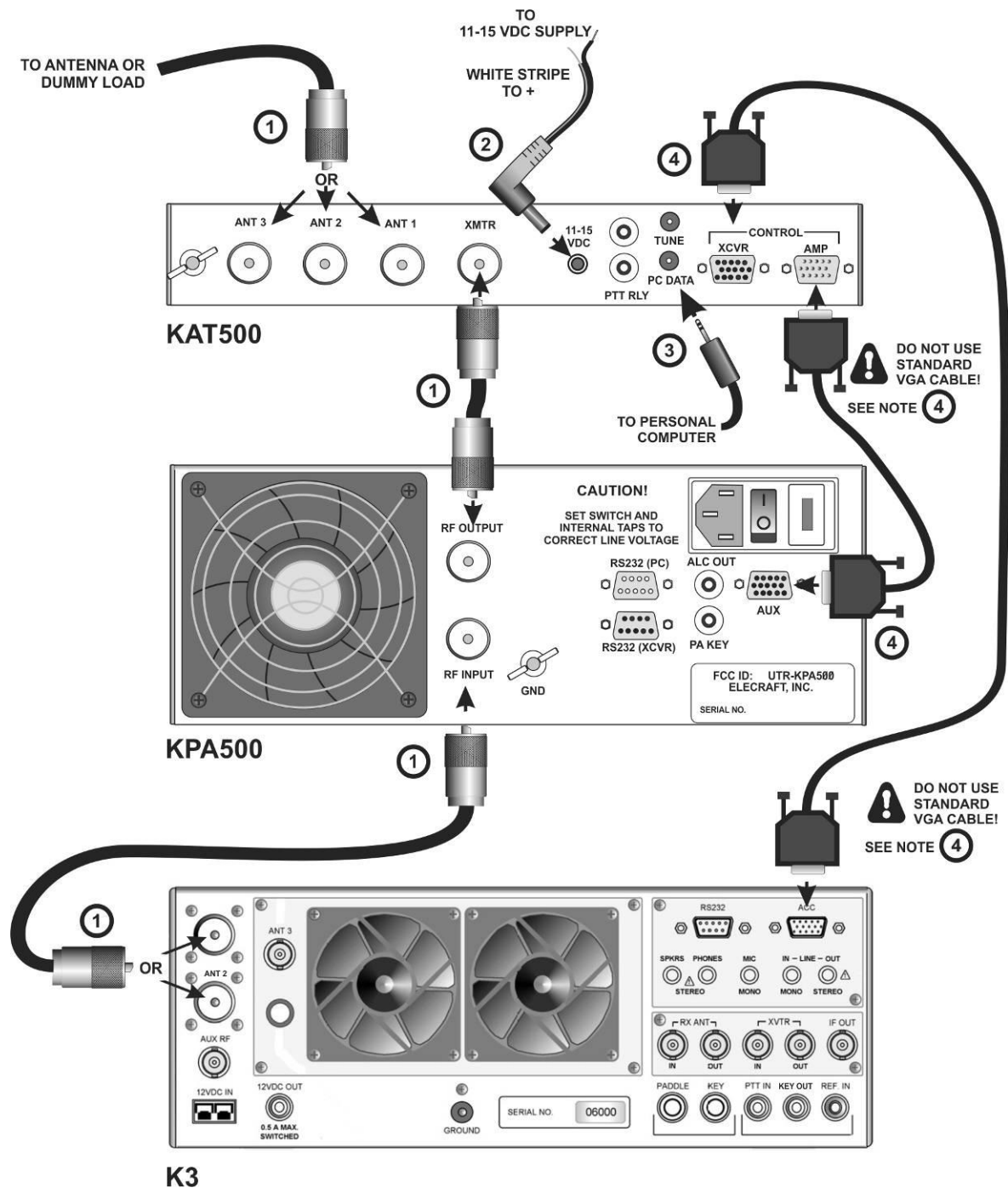

Figure 1. Cabling Diagram: Elecraft K3, KPA500 and KAT500 Using E850463 Aux Interface Cables.



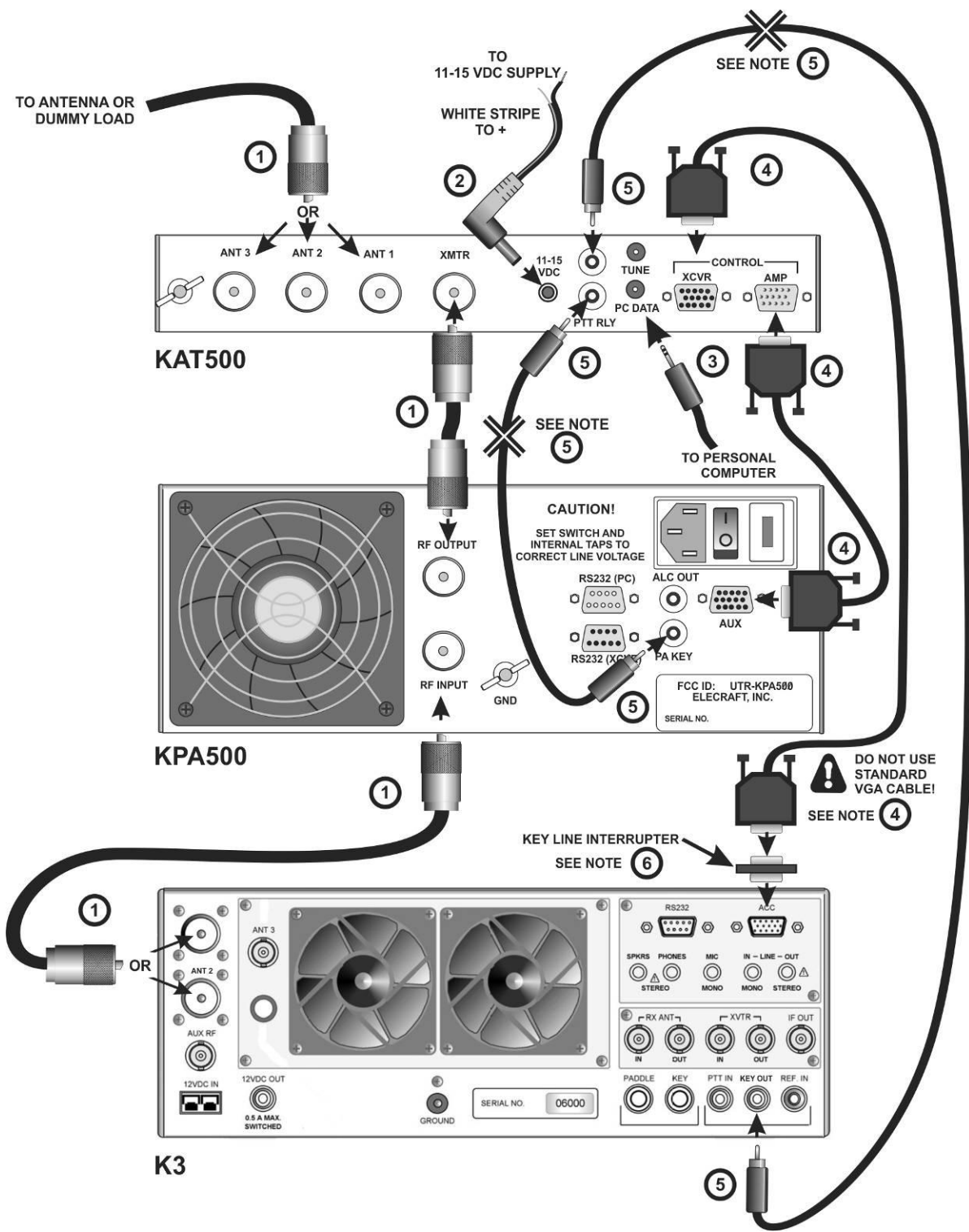



Figure 2. Cabling Diagram: Elecraft K3, KPA500 and KAT500 Using E850463 Aux Interface Cables with Separate Key Line.

## ⑤ Key Line Cables

- The Key Line (sometimes called a PTT line) controls the amplifier, enabling it for normal transmission and inhibiting it when necessary to protect the amplifier other equipment. The key line consists of a two conductor (center wire and shield) cable and connects to the Elecraft equipment using RCA-type male connectors.
- The K3 transceiver grounds the Key line to enable the KPA500 amplifier. Opening this line anywhere between the K3 and the KPA500 will inhibit the amplifier. If you have an external device that must control the key line, such as a SteppIR controller, you may insert it series with the key line in either place indicated with the  using connectors that match those on the external device.
- If you need additional cables, you can make your own or order additional cables from Elecraft (part number E100416). The Elecraft cables use RG59 coaxial cable for optimum shielding against incidental RF pickup.

### IMPORTANT

**When using a separate Key Line cable, you must:**

- 1. Interrupt the key line in the E850463 Aux cable as described in note ⑥ below.**
- 2. Use a separate key line cable between the transceiver and between the KAT500 and between the KAT500 and the amplifier. You cannot use an E850463 Aux cable in one location and a separate key line cable in the other.**

## ⑥ Key Line Interrupter

- The E850463 Aux cable includes the key line that inhibits the amplifier when needed to protect other equipment. This circuit must be broken when using an external key line cable or the key line in the E850463 Aux cable will bypass the external cable and the external equipment will not be able to inhibit the amplifier. If you purchased the Elecraft Aux cable as part of the KPAK3AUX cable set, you received with it a small device called the Key Line Interrupter that opens the key line. The key line is cut inside the Inhibiter so you do not need to modify your E850463 Aux cable in any way. If you only purchased the E850463 Aux cables you can order a key line interrupter separately. Order E850462 from [parts@elecraft.com](mailto:parts@elecraft.com)
- If using a homemade cable, you can cut the circuit at pin 10 (see *Table 1. E850463 Aux Cable Wiring.* on page 4)

## Icom Transceivers with AH-4 ATU Interface

Icom transceivers equipped with the interface connector for the Icom AH-4 ATU can operate the KAT500 through the AH-4 interface.

Icom transceivers not equipped with the AH-4 interface can use the KAT500 as described under *Other Transceiver and Amplifier or Stand-Alone Transceiver* on page 11.

### Cabling

Cables with the proper connectors is required wired as follows.

Table 2. Icom AH-4 Interface Cable Wiring.

MOLEX CONNECTOR TO ICOM TRANSCEIVER	SIGNAL	T-R-S CONNECTOR TO KAT500	POWER CONNECTOR TO KAT500
Pin 1	Key	Tip	NC
Pin 2	Start	Ring	NC
Pin 3	+12 VDC	NC	Center
Pin 4	Ground	Shield	Outer Shell

#### NOTES:

- Molex Connector: Pin 1 is at the triangular end of the connector.
- T-R-S is tip, ring and shield on a 3.5mm “stereo” plug. NC = No connection.
- Power Connector is a 2.1mm barrel type connector. NC = No connection.

Table 3. Icom Key Line Cable Wiring.

DIN CONNECTOR TO ICOM TRANSCEIVER	SIGNAL	RCA TYPE CONNECTOR TO KAT 500	POWER CONNECTOR TO KAT500
Pin 3	HSEND	Tip	NC
Pin 2	Ground	Shell	NC

#### NOTES:

- The DIN connector varies with the model of Icom transceiver. See your owner’s manual for the specific connector required.

Connect the equipment as described in Figure 3 and the associated notes.

**① 50-ohm coaxial RF cables with PL-259 connectors.**

- Be sure your transceiver is configured to deliver power to the antenna output that connects to the KPA500.
- The KAT500 allows up to three antenna connections, selected from the front panel (See *Operation*, page 14).

**② AH-4 Interface Cable.**

- Wire the cable as shown in Table 2, *Icom AH-4 Interface Cable Wiring*, above.
- The Interface Cable includes the Key Line (sometimes called a PTT line) which controls the amplifier, enabling it for normal transmission and inhibiting it when necessary to protect other equipment.
- The transceiver grounds the Key line to enable the KPA500 amplifier. Opening this line anywhere between the transceiver and the KPA500 will inhibit the amplifier.

**③ Key Line Cables**

- The Key Line (sometimes called a PTT line) controls the amplifier, enabling it for normal transmission and inhibiting it when necessary to protect the amplifier other equipment.
- The key line between the KPA500 and the KAT500 consists of a two conductor (center wire and shield) cable and connects to the Elecraft equipment using RCA-type male connectors.
- The key line between the KAT500 and the Icom transceiver must be wired as shown in Table 3. *Icom Key Line Cable Wiring*.

**④ External Device Controlling the Key Line.**

- If you have an external device that must control the key line, you may insert it series with the key line an either place indicated with the  using the appropriate connectors to match the external device.

**⑤ Computer interface cable.**

- Not required, but used for controlling the KAT500 from a personal computer, customizing the KAT500's operation or for updating firmware (see *Utility Program* on page 20).

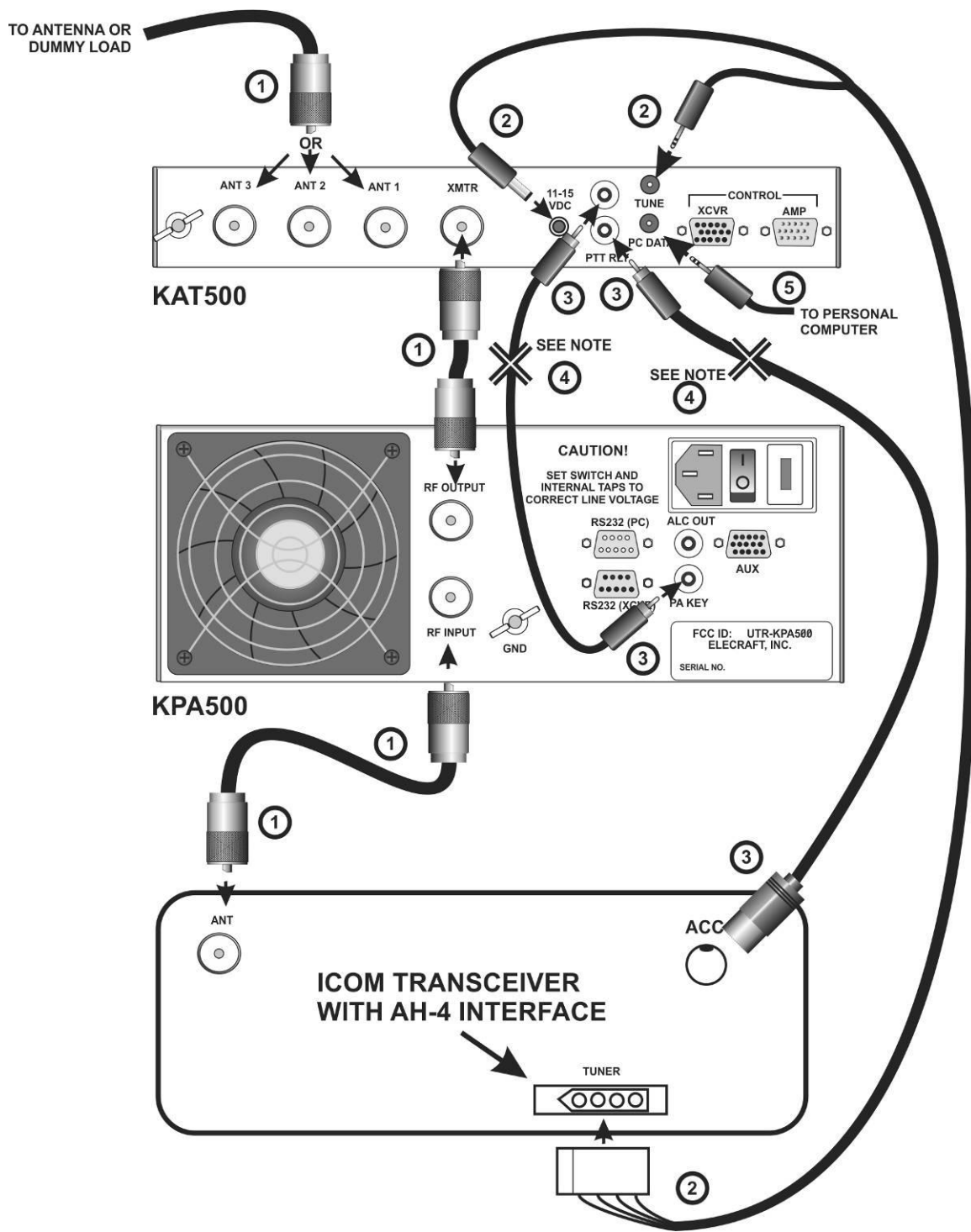

Figure 3. Cabling Diagram: Icom Transceiver with AH-4 Tuner Interface.

## Other Transceiver and Amplifier or Stand-Alone Transceiver

The KAT500 works well with any H.F. transceiver covering 1.8 through 54 MHz and amplifier delivering up to 1,000 watts output (see *Specifications*, page 2). If you have an Elecraft K3 transceiver and KPA500 amplifier you can connect them to the KAT500 as shown here. However, for best integration of the K3 equipment, we recommend that you use the E850463 Aux interface cable as shown on page 3 and Figure 1.

The basic cabling requirements for a transceiver and amplifier combination are shown in Figure 4. Figure 5 shows the basic cabling for a stand-alone transceiver. Refer to the following notes for details of the connections.

### ① 50-ohm coaxial RF cables with PL-259 connectors.

- The KAT500 allows up to three antenna connections, selected from the front panel (See *Operation*, page 14).

### ② Two wire power cable with a female 2.1 mm coaxial connector.

- Connect to the station 11 to 15 VDC power supply with the white striped lead to the positive terminal.

### ③ Computer interface cable.

- Not required, but used for controlling the KAT500 from a personal computer, customizing the KAT500's operation or for updating firmware (see *Utility Program* on page 20).

### ④ Key Line Cables

- The Key Line (sometimes called a PTT line) controls the amplifier, enabling it for normal transmission and inhibiting it when necessary to protect other equipment. The key line consists of a two conductor (center wire and shield) cable and connects to the KPA500 using RCA-type male connectors. You'll need to equip your cables with whatever connector types are used on the transceiver and amplifier.
- If you have an external device that must control the key line, you may insert it series with the key line an either place indicated with the  using the appropriate connectors to match the external device.

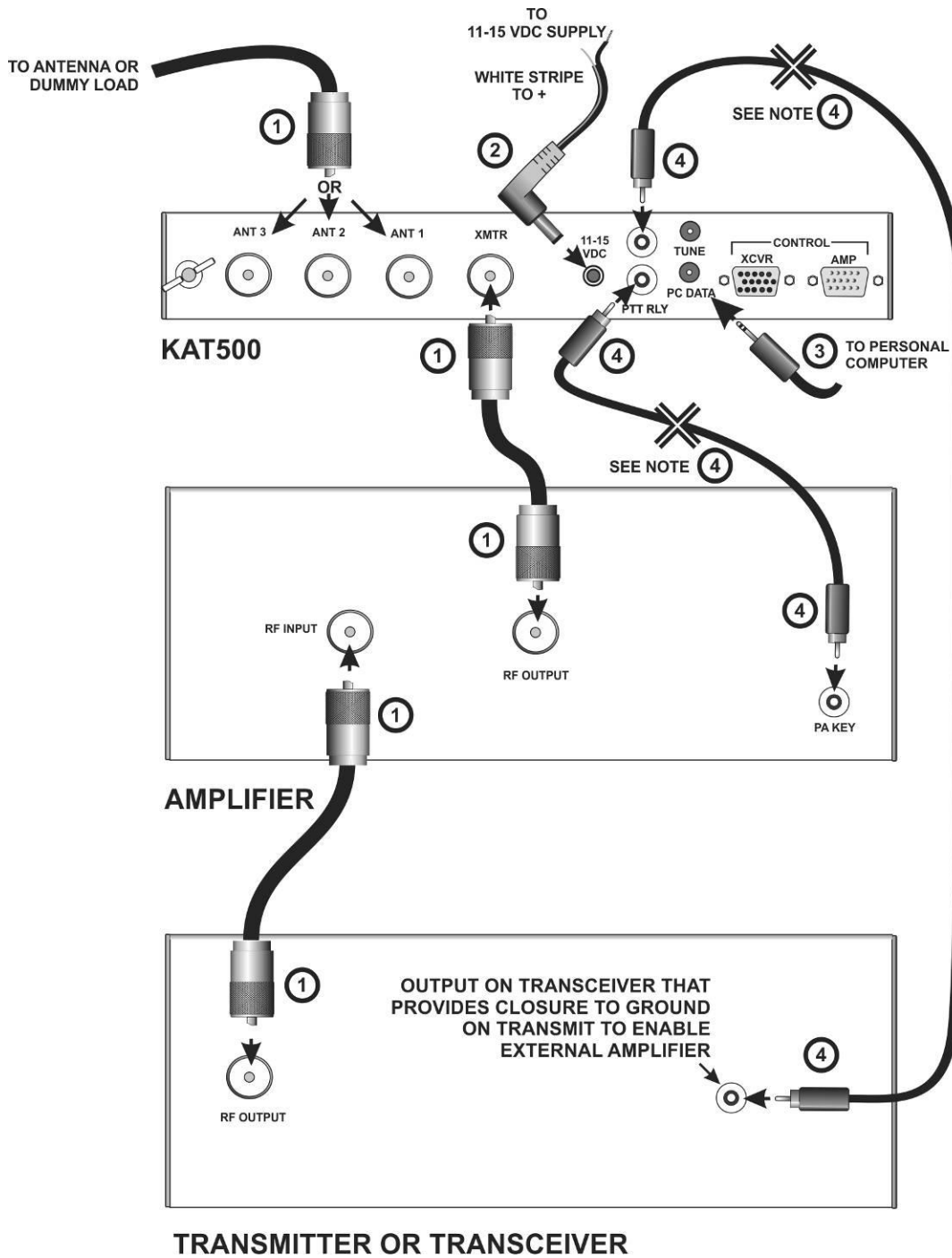

Figure 4. General Cabling for Transceiver and Amplifier.

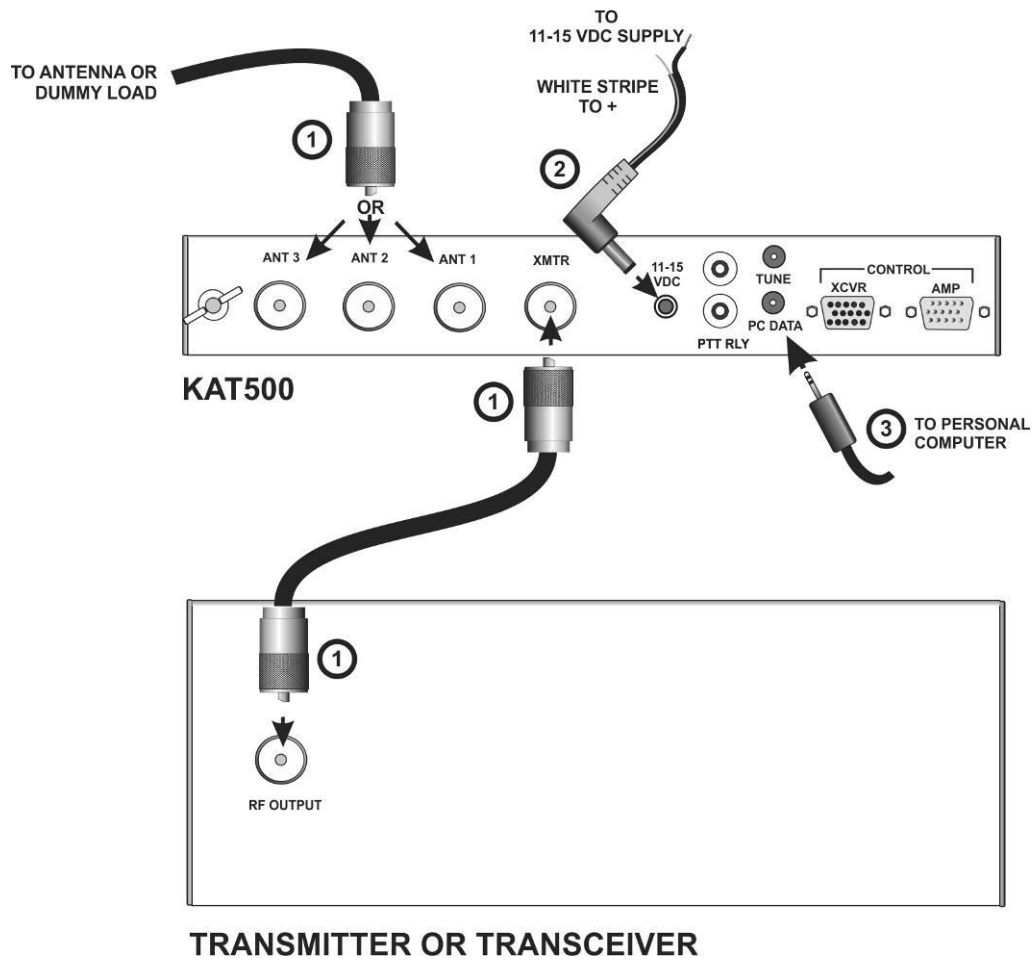

Figure 5. General Cabling Requirements - Stand-Alone Transmitter or Transceiver.



# Operation

The KAT500 turns on automatically when power is applied. You can turn the KAT500 off from the front panel by holding the MODE switch. A brief tap on the MODE switch will turn the KAT500 on again.

## ⚠ IMPORTANT!

- **IF YOUR TRANSCEIVER OR AMPLIFIER HAS A BUILT-IN ATU**, be sure it is in bypass before attempting to use the KAT500.
- **IF YOU ARE USING THE KAT500 WITH A K3 CONNECTED USING THE E850463 AUX CABLE** (Setup Figure 1 or Figure 2): Apply power to the KAT500 before or at the same time you turn the K3 on. If you turn the K3 on first the K3 may not initialize until you apply power to the KAT500.
- Front Panel Controls and Indicators

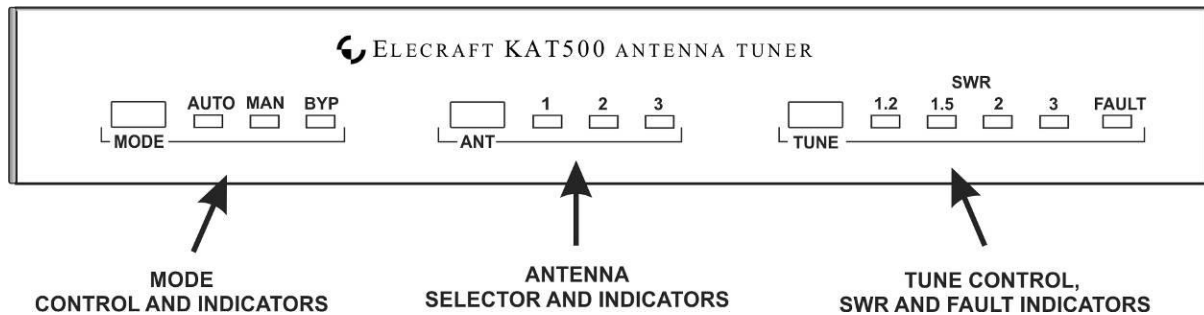

Figure 6. KAT500 Front Panel Controls.

The KAT500 is normally operated using the simple front panel controls (see Figure 6). Optionally, it can be operated using the Utility program (See *Utility Program* on page 20).

- **Mode Control and Indicators.** Tap the MODE switch to select:
  1. **AUTO** (Automatic): When at least 7 watts of RF is present and the SWR is greater than a predetermined limit, the KAT500 automatically initiates a tune cycle to find a setting that produces a low SWR. (See *Tune Operation* on page 16 for a description of what happens during the tune cycle) The predetermined SWR limit at which an automatic tune cycle begins can be chosen using the *Utility Program* (page 20). The default SWR value is 1.8:1.
  2. **MAN** (Manual): The KAT500 does not initiate a tune cycle automatically, regardless of the SWR. If the SWR is dangerously high, the KAT500 will open the key line to disable the amplifier. A tune cycle can be initiated manually as described under *Tune Control, SWR and FAULT Indicators* below.
  3. **BYP** (Bypass): RF is passed straight through the KAT500, bypassing the tuning elements in the matching network. The RF does pass through the SWR bridge so the SWR seen at the input to the antenna feed line is displayed. Also, the KAT500 will switch to the antenna chosen for each band (see *Antenna Selector and Indicators* below). Whenever power is off, the KAT500 switches to BYP and antenna 1.

- **Antenna Selector and Indicators.** Until you choose a different antenna, the KAT500 uses antenna 1 on all bands.
  1. Tap the ANT switch to select the desired rear panel antenna connection: 1 (ANT 1), 2 (ANT 2), and 3 (ANT 3):
  2. The antenna selection is remembered for each band, so the KAT500 will automatically return to the chosen antenna when the KAT500 returns to that band.
  3. The KAT500 switches to ANT 1 whenever the power is off.
  4. Unused antenna connections have bleeder resistors that drain off accumulated static from rain, wind, etc.
- **Tune Control, SWR and FAULT Indicators.** Tap the TUNE switch to manually initiate a tune operation that will search for the settings needed to produce a low SWR. To cancel a tune operation, tap the TUNE switch a second time. When initiating a tune operation:
  1. The indicator for the mode selected (AUTO or MAN) flashes.
  2. If the KAT500 was in BYP mode, it will automatically switch to MAN mode.
  3. The KAT500 opens the key line to disable the external amplifier provided the RF power present is less than the limit specified for hot-switching (see *Key Line Hot Switching* below)
  4. The tune operation begins when 7 watts or more of RF is applied (see *Tune Operation* below for details of what happens during tuning).
  5. The SWR lights indicate how well the KAT500 has matched the antenna to the transceiver. Typically an indication of 1.5 or lower is considered a good match. The FAULT indicator will light if an abnormal condition occurs (see *Fault Conditions* on page 18).
  6. The KAT500 closes the key line to enable the amplifier provided the RF power is below the limit specified for Key Line Switching (see below) and the SWR is below 2.0. If the SWR is above 2.0 the KAT500 will hold the key line open to protect the amplifier.

Optionally you can initiate a tune operation through the rear panel TUNE jack with a transceiver using the AH-4 protocol or by momentarily shorting the ring to ground. Also, a tune operation can be initiated through the RS232 port using the KAT500 *Utility Program* (page 18).

## Key Line Hot Switching

The Elecraft KPA500 is designed to have its key line switched to disable or enable the amplifier even while it is producing full RF power, but many other amplifiers may be damaged doing that. To protect those amplifiers, the KAT500 is supplied configured so that the key line will not be switched if 30 watts or more of RF power is present. This value may be changed to match the key line switching capability of any amplifier using the *Utility Program* (see page 20).

## Tune Operation and Memories

### *Tune Operation*

A tune operation begins when RF power between 7 and 100 watts is applied and the SWR is above the tuning threshold in AUTO mode, or when the TUNE switch is tapped in either AUTO or MAN modes. The RF power must be below the key line hot switching limit (see *Key Line Hot Switching*, above) so the KAT500 can disable the amplifier. The KAT500 will not respond to less than 7 watts of drive and over 100 watts will cause a fault condition (see *Fault Conditions* on page 18)

Relays in the KAT500 operate to search for values of inductance (L) and capacitance (C) that match the impedance of the antenna to 50 ohms non-reactive for the transceiver.

The SWR lights indicate how close the antenna impedance is matched to the transceiver. The L and C values switched in will provide a good match for most situations, but if you feel the resultant SWR is high you can tap TUNE again within 3 seconds to initiate a second, fine tuning process in which smaller changes in L and C values are tried. That may result in a lower SWR. You can also manually adjust the L and C values using the KAT500 Utility Program (page 20).

If you have a high-Q (narrow bandwidth) antenna that benefits from a fine tune operation on certain bands, you can configure the KAT500 to automatically do a fine tune operation without pressing the TUNE switch again with the Utility Program (see *Auto Fine Tune*, page 21).

If the SWR is 1.2 or less when a tune operation begins, the KAT500 bypasses the matching network without searching for a tuning solution. The KAT500 remains in either AUTO or MAN mode but the matching network is switched out of the RF path (bypassed). The bypass setting will be stored as the tuning solution so the matching network will be bypassed whenever you return to that frequency. This SWR threshold can be changed with the Utility Program (see *Automatic Bypass on Selected Bands* on page 18 and *VSWR Thresholds* page 21).

### *Memories*

After successfully tuning, the KAT500 stores the L and C settings or the bypass setting in memory. They will be recalled almost instantly when returning to that frequency later. The entire spectrum from 1.8 through 60 MHz is divided into frequency segments and tuning information is stored for each segment in which you have successfully completed a tune operation.

When starting a tune operation for a frequency segment that has no previously stored L and C values, the KAT500 first tries the settings in the nearest frequency segment that has tuning data.

Since retuning is normally required over a narrower frequency range on the lower frequencies to maintain a low SWR, the lower frequencies have narrower segments assigned as follows:

- Below 3 MHz the segments are 10 kHz wide.
- From 3 MHz through 26 MHz the segments are 20 kHz wide.
- From 26 MHz to 38 MHz the segments are 100 kHz wide.
- From 38 MHz to 60 MHz the segments are 200 kHz wide.

The KAT500 also stores the antenna output that you selected for each band.

## ***Frequency Tracking with an Elecraft K3 Transceiver***

When the KAT500 is used with an Elecraft K3 transceiver, the K3 can be configured to cause the KAT500 to follow changes in the K3's VFO frequency during receive. The KAT500 will change to the tuning solution for each frequency segment as the K3's VFO frequency is tuned across the band. To use frequency tracking:

- Connect the KAT500 and K3 using the Aux interface cable as shown in Figure 1 (page 5) or Figure 2 (page 6).
- Ensure that your K3 is equipped with firmware revision 4.82 or later. See Firmware Upgrades in your K3 Owner's Manual for instructions about how to upgrade your firmware, if needed.
- Enable the frequency tracking function at the K3: select *CONFIG:KAT3* and then tap the **1** switch to toggle between *KAT500N* (no KAT500) and *KAT500Y* (KAT500 connected and frequency tracking enabled).

## **Bandswitching**

### ***Elecraft K3 and KPA500 Amplifier Combination***

When using the KAT500 with an Elecraft K3 transceiver and KPA500 amplifier connected with the E850463 Aux interface cable (*Setup* Figure 1 or Figure 2), the KAT500 changes bands when you change bands at the K3. The mode selected (AUTO, MAN or BYP) applies to all bands. Only the ANT selection and the L/C settings are stored in memory and recalled for each band.

### ***Non-Elecraft Amplifiers***

Change bands as follows to avoid damage to your amplifier:

- Switch the transceiver to the new band.
- Switch the amplifier to the new band.
- Apply RF power between 7 and 30 watts (see note 1 below). This will cause the KAT500 to change bands, switch to the last used antenna on that band (see note 2 below), switch to the tuning values for that frequency stored in memory or perform a tune cycle, if in AUTO mode. If a tune cycle is performed, 20 watts or more will produce more accurate tuning.
- If your amplifier requires manual tuning, connect it to a suitable dummy load. (You can attach the dummy load to one of the KAT500 antenna connectors, switch the KAT500 to BYP and select that connector with the ANT switch.)
- Tune up your amplifier into the dummy load per the manufacturer's instructions.
- When finished return the KAT500 mode to AUTO or MAN and, if needed, change back to the original antenna selection.

#### **Notes:**

1. At 30 watts and above the KAT500 will refuse to open the key line to protect amplifiers that cannot be "hot switched". That is the default value. If your amplifier is capable of handling higher powers you can change this value using the *Utility Program* (page 20). The KAT500 will not respond to less than 7 watts of RF power.
2. If you are not using a K3 with an E850463 Aux cable connected between your K3 and the KAT500, you must make the KAT500 change bands by applying RF power. Only a very

brief pulse of RF is needed. Failing to make the KAT500 change bands before selecting a different antenna can produce surprising behavior. For example, if you are using ANT 1 on 80 meters and then switch your transceiver to 40 meters where you want to use ANT 2. You see ANT 1 is still selected on the KAT500 so you change it manually. And then, when you transmit you see the KAT500 jump back to ANT 1. That happens because the KAT500 did not change bands until you transmitted, and then it reverted to the last ANT position used on 40 meters (or to ANT 1 if no other antenna position has been used on that band).

If you use different antennas on different bands without the E850463 Aux cable interface, we recommend that you first set up the KAT500 for the antenna you want to use on each band as follows. Optionally you can assign antenna ports using the *Utility Program* (see page 20).

- Select the desired band on your transceiver or transmitter.
- Tap MODE, if necessary, to select MAN.
- Send a brief pulse of RF at a power level of at least 7watts such as a “dah” with paddles at a CW speed under 25 WPM. That switches the KAT500 to the current band.
- Tap ANT to select the desired antenna for that band.
- Continue on to the next band until you have covered all the bands. Note that you do not need to do this on bands using ANT 1 since the KAT500 defaults to ANT 1 if you have not selected another antenna position.

## **Operating Tips**

### ***Rapid QSY After Antenna Change:***

For rapid changes between favorite frequencies without a delay to do a tune operation after installing the KAT500 or after making an antenna change, move to each frequency and do a tune operation as part of your setup procedure. When you return to one of those frequencies later, the KAT500 will recall the settings from memory almost instantly; you will hear only a brief relay click as it recalls and switches to the proper settings.

In the extreme case you could do a tune operation in each frequency segment shown above in each band so that the KAT500 will memorize the settings in advance. Otherwise as you operate the KAT500 in AUTO mode, it will tune automatically as you visit different bands and frequencies for the first time. It will not need to do a tune operation again when you return to that frequency unless you change your antenna.

### ***Automatic Bypass on Selected Bands:***

The mode (AUTO, MAN, or BYP) selected for each band is not stored in memory, however you can cause the KAT500 to effectively switch to bypass on certain bands. The mode does not change, but the KAT500 completely bypasses the matching network. This may be desirable if you have antennas for certain bands that are tunable (such as a SteppIR) or that otherwise show a low SWR across the band.

The KAT500 bypasses the matching L/C network when no values are stored in memory and the SWR it presents is below the VSWR thresholds set for each band. You can change these thresholds and erase any L/C settings already memory for those bands using the Utility Program (page 20) as follows:

- In the Utility program under *Configuration/Edit Configuration*, click on the VSWR Thresholds tab and set the *Autotune* and *Bypass VSWR* thresholds above that which your antenna will present on each band. Typical values are 2.5: or 3.0:1.
- Click on the *Erase Memories* tab and erase the memory for each band.
- Be sure your antenna is connected and, if necessary, tuned for the band, and then select the desired ANT and perform a Tune operation (see page 16). The KAT500 will perform a brief search and, noting that the SWR the antenna presents is below the threshold you set above, bypass the matching network. The antenna selection and bypass setting will be stored in memory. The next time you return and transmit that band, you will hear a brief click as the matching network is bypassed automatically, even if you are in AUTO mode, as long as the antenna presents an SWR below the thresholds you set above.
- You can verify that the KAT500 matching network is bypassed using the Utility program. Click on the *Operate* tab and note that a check appears next to *Bypassed* when you transmit even though the KAT500 is in AUTO or MAN mode.

### ***Signal Audible at 28004.5 MHz:***

In some installations a 28004.5 MHz signal may be heard from an oscillator in the KAT500. If this is an issue, you can cause the KAT500 oscillator to shut down when it is not needed with a setting in the Utility program. See *Idle Sleep* on page 20.

## **Fault Conditions**

A fault will occur if:

- The RF drive power exceeds 110 watts during a tune operation. This protects the relays from damage due to excessive RF power while switching. If this fault occurs, be sure you have the PA Key circuit installed, either through the E850463 Aux cable or using separate key line cables (see *Setup*, page 3). As supplied, your KAT500 will not open the key line if 30 watts or more of RF drive is applied. If your amplifier is capable of switching its key line at greater powers, you can increase the limit using the Utility program (see *Amplifier Key Interrupt Power*, page 17).
- The impedance of your antenna is outside of the tuning range so an acceptable SWR cannot be found.
- The impedance of your antenna is outside of the normal tuning range but the KAT500 is able to match it. In that case, the allowable power is reduced as needed to protect the KAT500. You can safely operate at any power less than that at which the fault occurs.

Reset a fault by tapping the any switch on the KAT500 or by switching the KAT500 power off, then on again with the MODE switch.

# Utility Program

To use the Utility Program you will need:

- A personal computer.
- The KAT500 Utility Program available free from Elecraft at [www.elecraft.com](http://www.elecraft.com).
- The RS-232 cable with a USB connector supplied with your KAT500.

Connect your computer to the KAT500 using the interface cable connected to the PC DATA jack and load the Utility Program. Click on the PORT tab and select the port your computer is using to communicate with the KAT500. Click on TEST COMMUNICATIONS and you will see a pop-up stating that the Utility program is communicating with the KAT500 if everything is working properly.

Detailed operating instructions for the Utility program are provided in the Utility Help screens.

The following assumes that you have KAT500 Utility program version 1.13.5.12 or later installed.

## KAT500 Configuration

You can configure the KAT500 to best support your installation. Click on the Utility program CONFIGURATION tab and then on the Edit Configuration button. After making your choices, click on the APPLY button at the bottom.

### *Amplifier Key Interrupt Power*

Selects the RF power level applied above which the KAT500 will not open or close the key line to disable or enable an external amplifier or other equipment. The default is 30 watts to protect those amplifiers that cannot have the key line switched while they are producing full power without damage. At any setting up to 1499, the KAT500 will open the key line immediately as long as the RF power is below that level, and then close the key line when transmit power drops to zero. The Elecraft KPA500 amplifier is designed to both open and close the key line at full power without damage. A setting of 1500 will both open and close the key line immediately. Clicking on Optimize for the KPA500 automatically selects that setting. Before using this setting with other amplifiers, be sure to review your owner's manual carefully to ensure it can withstand having the key line opened and closed at full power.

### *Idle Sleep*

In some installations a 28004.5 MHz signal may be heard from an oscillator in the KAT500. If this is an issue, you can cause the KAT500 oscillator to shut down when it is not needed. Click on Idle Sleep to put a check in the radio button. The oscillator will stop running shortly after the last key press or the last data communication with other equipment and restart automatically when needed.

### *Initial Power*

Normally the KAT500 powers on when dc power is applied. Optionally you can remove the check from the Power On when DC Power Applied radio button to command the KAT500 to remain off until the MODE switch is tapped.

## ***Antennas***

You can select which antenna connectors are active (Enabled) on each band. Antenna connectors are disabled by clicking on the check mark to clear it. Disabling antenna connectors will cause them to be skipped over when cycling through the options with the front panel ANT switch or in the Utility Operate tab. You can also select which ANT connector you prefer to use on each band and it will be automatically selected when you return to that band. You can change the selection to any other antenna connector provided it has not been disabled.

## ***VSWR Thresholds***

You can set the SWR thresholds above which a tuning cycle will be started in AUTO mode, or below which the KAT500 will bypass the tuning network. Also, you can set an SWR threshold at which the key line will not close to enable the external amplifier to protect it from excessive SWR.

These thresholds can be set the same for all bands, or individual values can be entered for each band. In most installations the length of coax between the transmitter or amplifier and KAT500 will be too short for the SWR to make a significant difference. The main concern is to provide an acceptable match to the transmitter or amplifier. The Elecraft KPA500 amplifier works efficiently into a load SWR of 1.5:1. Suggested values are 1.8:1 to launch an automatic tuning operation and 1.2:1 for bypass.

## ***Erase Memories***

You can erase all of the stored tuning memory data for the entire KAT500, or just the memories associated with a particular ANT selection and band.

## ***Auto Fine Tune***

Selects bands on which the KAT500 will always do a fine tune operation. This is helpful when you use an antenna with a high-Q (narrow SWR bandwidth) on certain bands to avoid needing to press the MODE switch a second time whenever the KAT500 does a tune operation.

## ***Saving Configuration***

You can save the configuration to a file on your computer so that you can restore it quickly without needing to re-enter the data.

## ***Reset to Factory Default***

It is possible, though rare, for parameters to become altered in such a way as to prevent the firmware from running correctly. If you suspect this, you can reinitialize parameters to defaults. If you have saved your configuration, you can restore it quickly by clicking on the *Restore Configuration* button.

## **Updating Firmware**

Although the KAT500 is shipped with current firmware installed, from time to time updated and improved firmware may become available.

To update firmware, connect your KAT500 to your computer and launch the KAT500 Utility program.

Updated firmware may be obtained in two ways.

1. Click on Firmware tab and then the Click on Copy Firmware Files from Elecraft to download the latest production released firmware or,



2. Download the new file from the Elecraft web site manually and place it in a local folder, then click on **Browse...** to locate the folder on your computer. This is the way to access the latest Beta firmware available from Elecraft.

To install new firmware in your KAT500, click on the utility **Send Firmware to the KAT500** button to start the transfer. Follow any on-screen instructions.

Be sure to check the notes supplied with the new firmware. They may include changes that affect the instructions in this manual.

If you don't have Internet access, you can obtain a firmware upgrade on CD. If you don't have a computer, you can send your KAT500 to Elecraft to be upgraded. See *Customer Service and Support*, page 1.

### ***Forcing a Firmware Load***

If you accidentally load an old or incompatible firmware version and find the KAT500 unresponsive, do the following:

- Switch off the power supply or disconnect the KAT500 from its power supply for at least 30 seconds. The delay is important because the KAT500 microcontroller may continue to function with very low voltage and current draw so capacitors need time to fully discharge before continuing.
- In the Utility program, click **Close Port**.
- Press and hold the KAT500 front panel **MODE** switch.
- Reconnect the DC power supply.
- Continue to hold the KAT500 **MODE** switch until the **MAN LED** begins to blink (about 10 seconds).
- Release the **MODE** switch.
- If the Utility program is running, click **Test Communications**. You should see a status message indicating that the KAT500 is waiting for firmware load:
- In the Utility program, select **Send Firmware** on the **Firmware** tab.

# Kit Assembly Procedure

## Preventing Electrostatic Discharge Damage

Sensitive components in your KAT500 may be damaged by Electrostatic Discharge (ESD) in any location or climate unless you take specific steps to prevent such damage. Many components can be damaged by static discharges of only a few volts: far too little for you to notice.

ESD damage may not be apparent at first. The damaged components may not fail completely. Instead, the damage may result in below-normal performance for an extended period of time before you experience a total failure.

We strongly recommend you take the following anti-static precautions (listed in order of importance) to ensure there is no voltage difference between the components and any object that touches them:

- Leave ESD-sensitive parts in their anti-static packaging until you install them. The packaging may be a special plastic bag that allow static charges to flow harmlessly over their surface, or the component's leads may be inserted in conductive foam that keep them at the same potential. Parts which are especially ESD-sensitive are identified in the parts list and in the assembly procedures.
- Wear a conductive wrist strap with a series 1-megohm resistor that will constantly drain off any static charge that accumulates on your body. If you do not have a wrist strap, touch a ground briefly before touching any sensitive parts to discharge your body. Do this frequently while you are working. You can collect a destructive static charge on your body just sitting at the work bench.

### **WARNING**

**DO NOT attach a ground directly to yourself without a current-limiting resistor as this poses a serious shock hazard. A wrist strap must include a 1-megohm resistor to limit the current flow. If you choose to touch an unpainted, metal ground to discharge yourself, do it only when you are not touching any live circuits with any part of your body.**

- Use a grounded anti-static mat on your work bench.
- If you choose to use a soldering iron to work on your KAT500 for any reason, be sure your iron has an ESD-safe grounded tip tied to the same common ground used by your mat or wrist strap.

## Tools Required

1. #0 and #1 size Phillips screwdrivers. Use the screwdriver that best fits the screw in each step. To avoid damaging screws and nuts, a power screwdriver is *not* recommended.
2. Needle-nose pliers.

The following tools are strongly recommended:

1. ESD wrist strap.
2. Static dissipating work pad.

## Assembly Procedure

- ❑ Before starting construction, do a complete inventory, comparing the parts in your kit with the parts list in Appendix A, to familiarize yourself with all of the parts and to ensure the kit is complete. If any parts are missing contact Elecraft for a replacement (see *Customer Service and Support*, page 1).
- ❑ Taking ESD precautions remove the printed circuit board from its ESD-safe envelope and install six 2-D fasteners as shown in Figure 7. Be careful not to disturb any of the inductors on the top side, especially the air wound coils, or the position of the resistor mounted on the bottom.

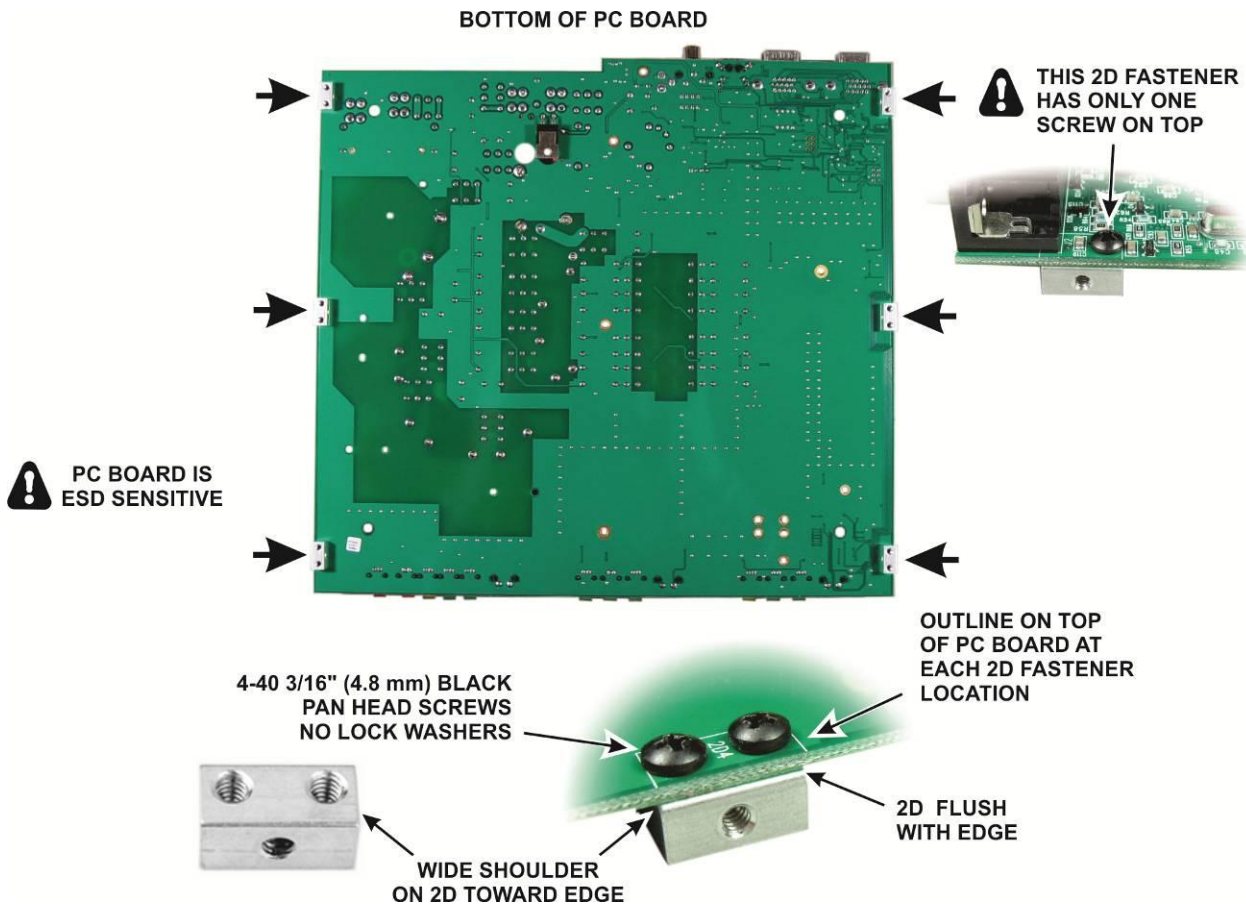

Figure 7. Installing the 2D Fasteners.

□ Install a cable tie to secure each of the four large toroidal inductors to the pc board as shown below. Note how the locking heads are positioned below the pc board. If a toroid is far enough out of position to obstruct a hole in the pc board, gently reposition it as needed. Ideally each toroid will be inside the circle silk-screened on the board. Do not over-tighten the ties. Tighten them only enough to remove any slack and provide a small amount of tension.

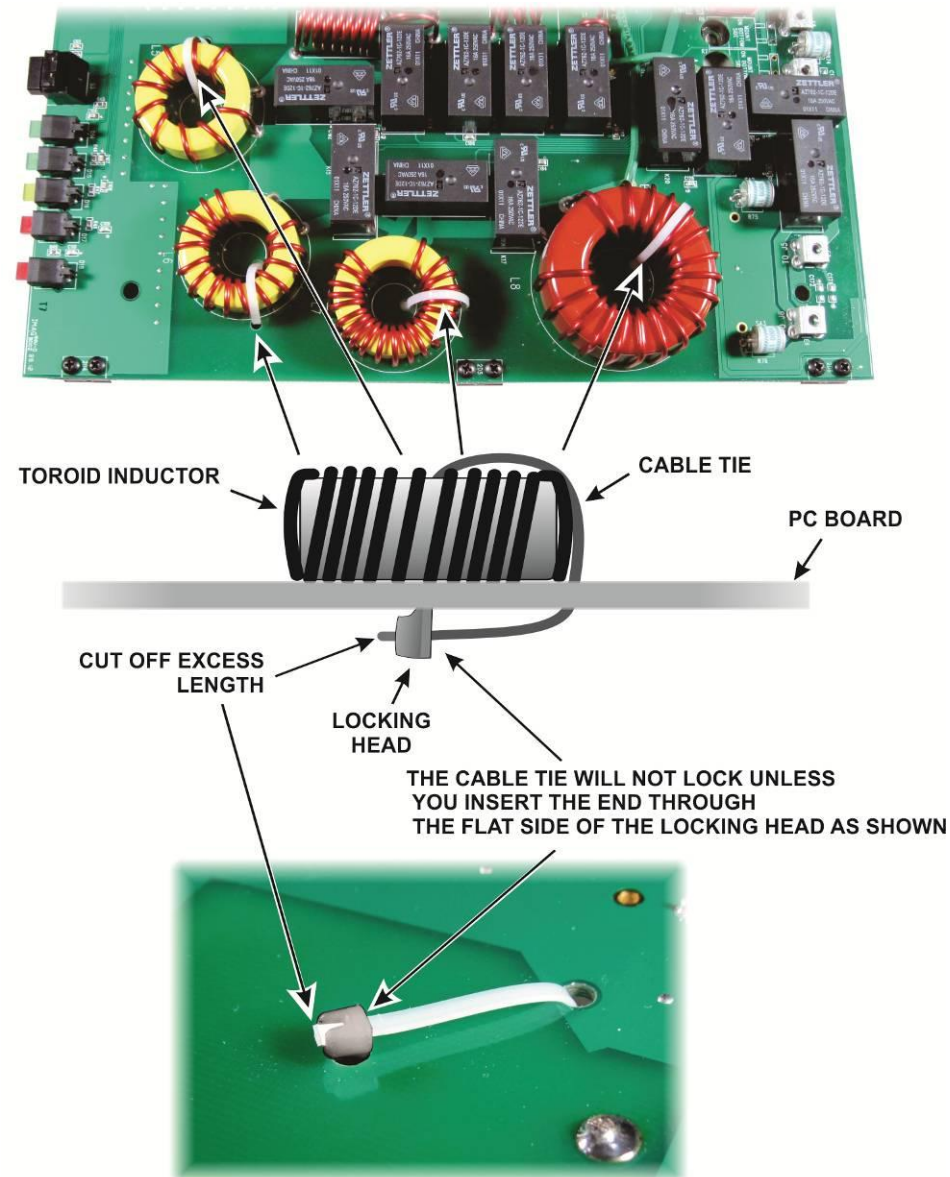

Figure 8. Installing Cable Ties on Toroids.

□ Install the three pairs of standoffs on the pc board shown in

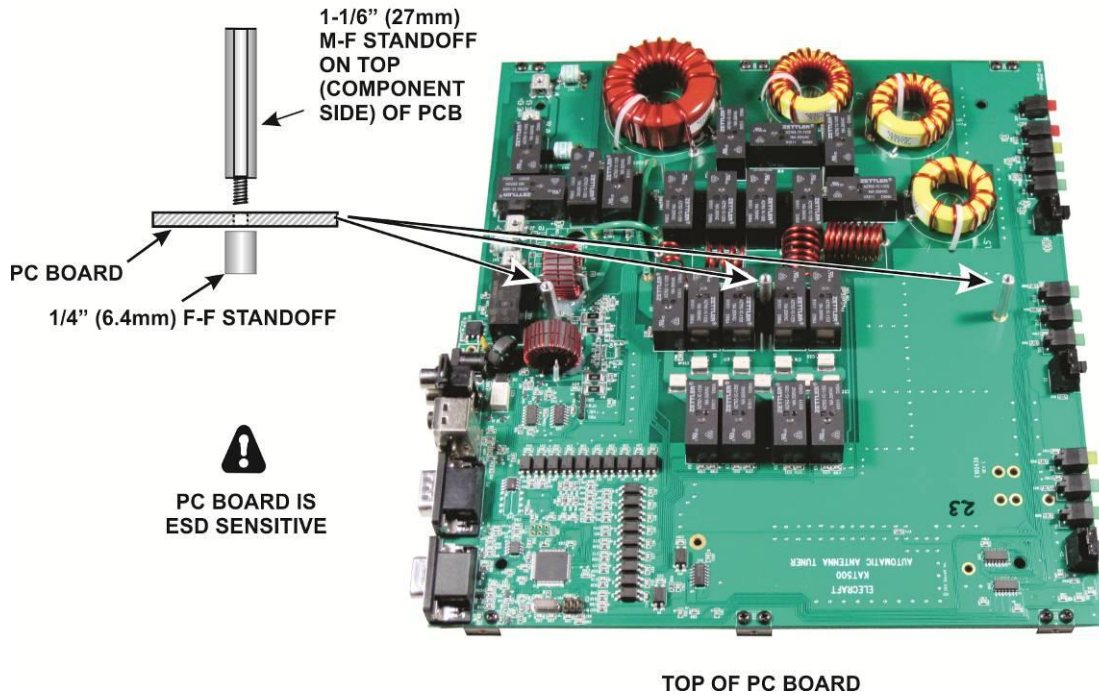

Figure 9. Do not use lock washers. The standoffs alone establish the right height.

⚠ Do not over-tighten or you may twist the threaded section off of the standoff.

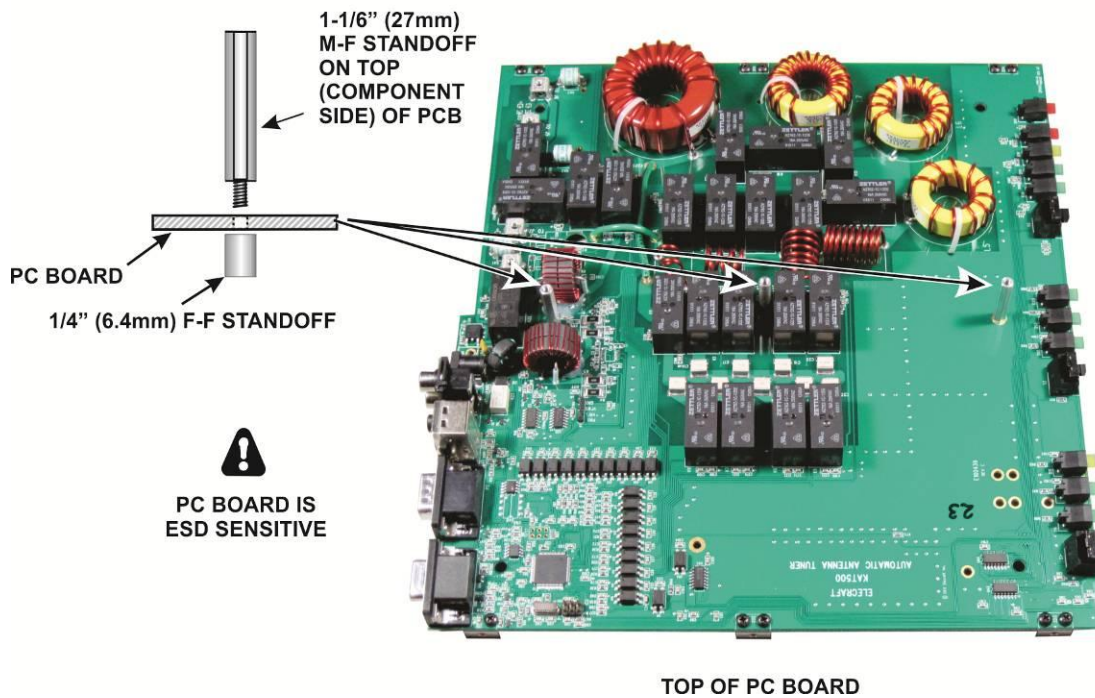

Figure 9. Installing Standoffs on the PC Board.

- Locate the outline marked LB1 on the pc board. It is on the connector edge of the board next to the power connector (see Figure 10).

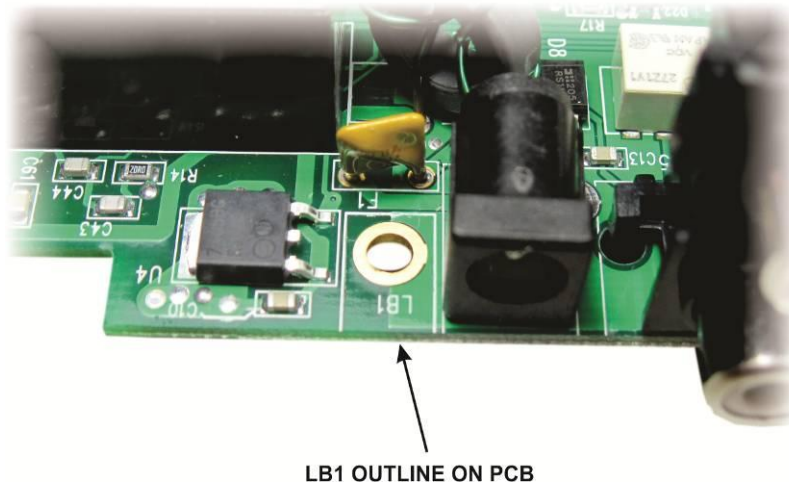

Figure 10. Angle Bracket LB1 Mounting Location

- Mount the angle bracket at LB1 on the pc board as shown in Figure 11. Note that it has a long and short side. Be sure the long side is against the pc board as shown.

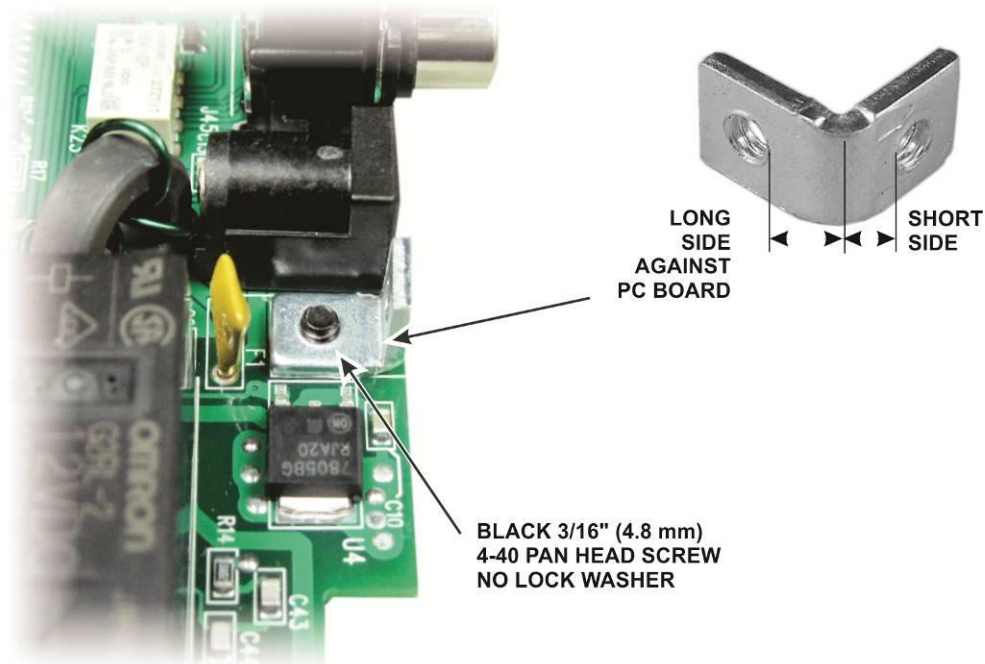

Figure 11. Installing the Angle Bracket.

- Locate the bottom cover. It is the same size as the top cover, but you can identify it by the hole pattern. Check the **inside** surface and remove any tape or other residue to ensure clean, bare metal at the locations shown in Figure 12. This is important for proper grounding of the enclosure panels.

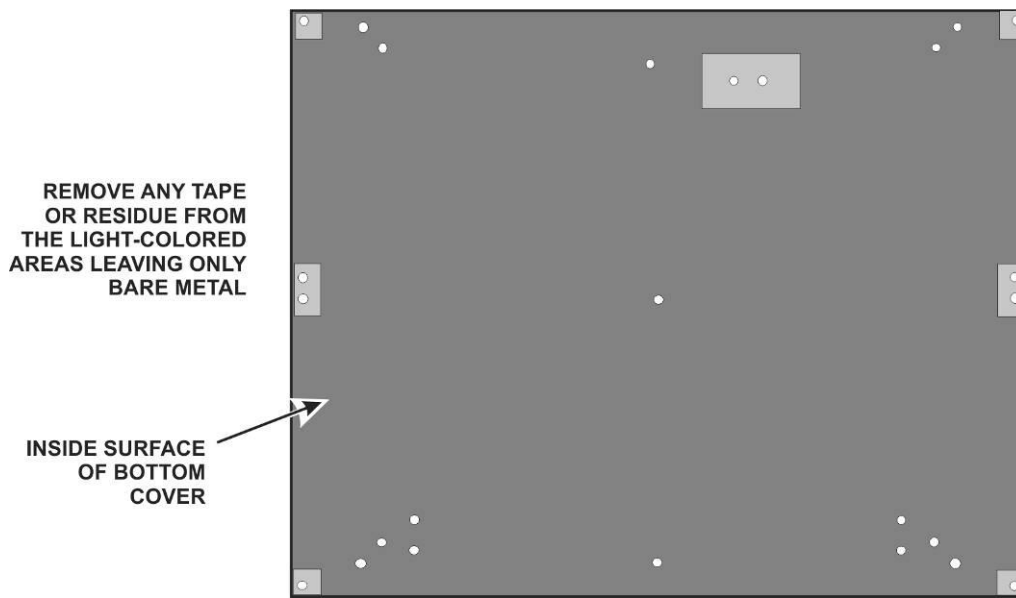

Figure 12. Preparing Bottom Cover for Installation.

- ☐ Turn the bottom cover over and place the four self-stick feet on the cover in the locations shown in Figure 13. Do not cover any of the holes in the bottom cover with the feet. The screw hole indicated will be used in the next step.

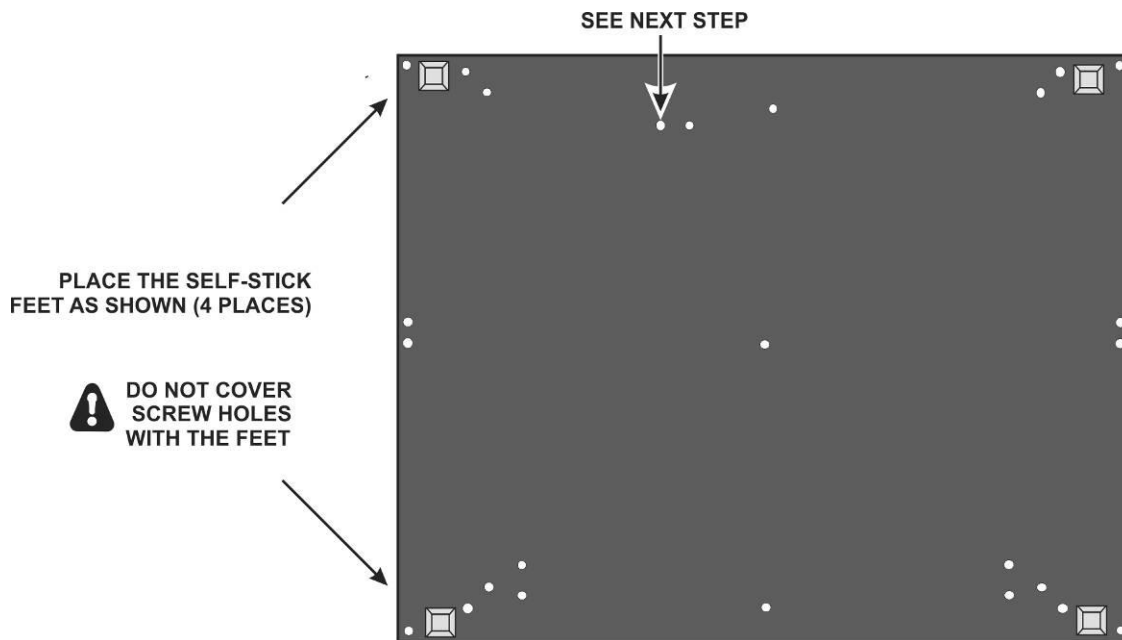

Figure 13. Placing Feet on the Bottom Cover.

- ☐ Install a screw, lock washer and nut in the hole indicated in Figure 13 as shown in Figure 14 with the screw head on the outside of the bottom cover. This hole is unused. The hardware is provided to fill it.

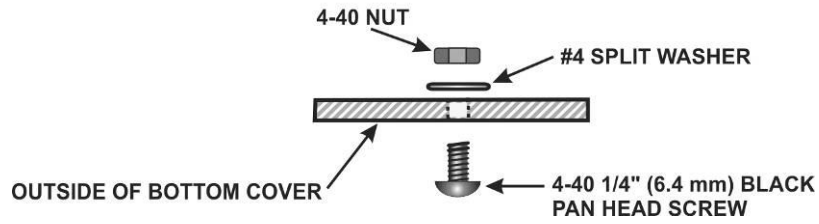

Figure 14. Installing Hardware on Bottom Cover.

Place the circuit board component side down on your work table and attach the thermal pad to resistor R6 as shown in Figure 15.



Figure 15. Placing Thermal Pad on R6.



□ Attach the bottom cover as shown in Figure 16. Note that the bottom cover only fastens to one of the two screw holes in each of the 2D fasteners mounted at the corners of the circuit board. The remaining screw holes in those 2D fasteners will be used to secure the front and rear panels. When positioning the bottom cover, be sure the open hole shown in Figure 16 lines up with the hole in the tab for R6 mounted on the circuit board.

**⚠** When assembling the cabinet pieces, start each screw in the threads before tightening any screws. When adding more cabinet sections in future steps, you may need to loosen the screws for other sections so they can be adjusted slightly as needed to fit properly. Once you have done that and finished assembling your KAT500, you can remove and replace individual cabinet sections easily without further adjustments.

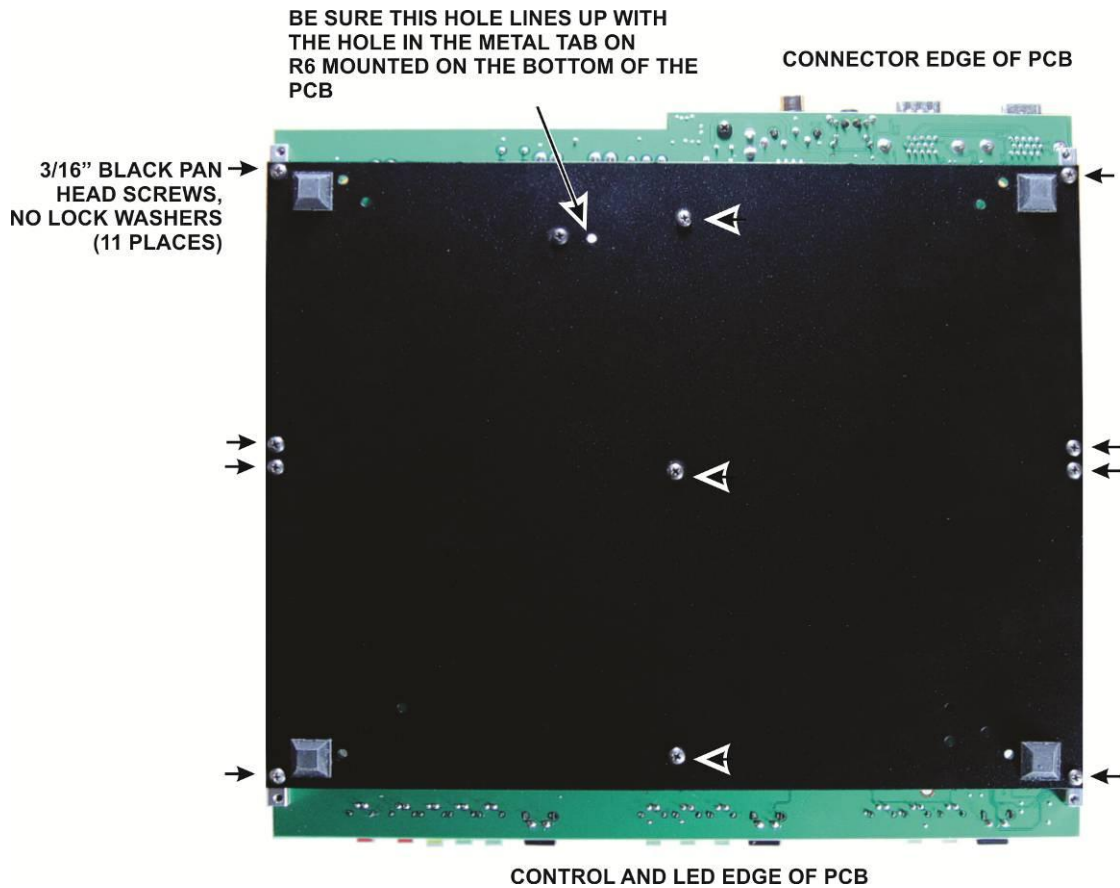
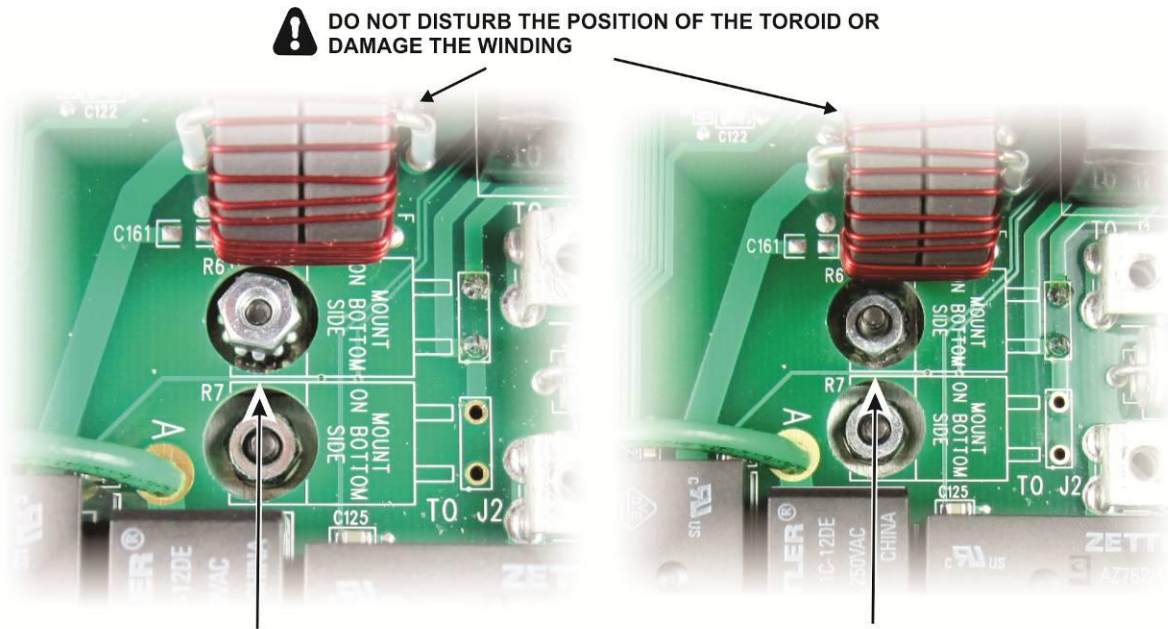

Figure 16. Installing the Bottom Cover.

Turn the assembly over so the pc board is on top and install the R6 mounting hardware as shown in Figure 17 to secure R6 against the bottom cover.



1. PLACE A 4-40 3/8" (9.5 mm) BLACK PAN HEAD SCREW (NO LOCK WASHER) THROUGH THE BOTTOM COVER AND HOLD IT ABOUT LEVEL WITH THE TOP OF THE PC BOARD.
2. PLACE A 4-40 NUT WITH CAPTIVE STAR WASHER ON THE SCREW. YOU CAN PLACE THE NUT ON THE PC BOARD AND SLIDE IT INTO PLACE WITH THE SCREW HELD AT THE RIGHT HEIGHT. HOLD THE NUT WITH YOUR FINGER TIP WHILE TURNING THE SCREW TO START IT IN THE THREADS.

3. TURN THE SCREW FROM THE BOTTOM OR SPIN THE NUT FROM THE TOP UNTIL IT TOUCHES THE TAB ON R6.
4. ONCE IN CONTACT WITH THE TAB ON R6 THE STAR WASHER WILL HOLD THE NUT. TIGHTEN THE SCREW FROM THE BOTTOM UNTIL R6 IS FIRMLY SECURED AGAINST THE BOTTOM COVER. NO WRENCHES OR PLIERS ARE REQUIRED TO HOLD THE NUT.

Figure 17. Installing the R6 Mounting Hardware.

- Set the pc board and bottom cover assembly aside temporarily in a safe place.
- Locate the rear panel and the four SO-239 connector assemblies. **Leave the SO-239 connector assemblies in their packages until needed and do not bend or move the wire attached to each connector. The wires have been carefully pre-formed to fit in the KAT500.**

- Inspect the inside surface of the rear panel and remove any tape or residue to provide a clean metal surface where shown in Figure 18.

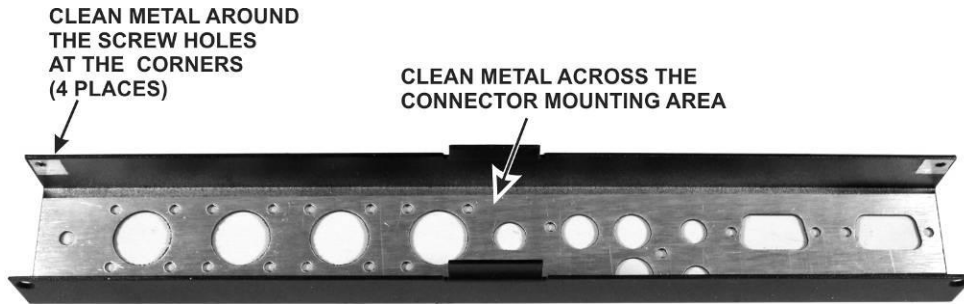

Figure 18. Preparing the Rear Panel.

- Remove the protective backing from the serial number label and press it onto the rear panel as shown in Figure 19. Be careful not to cover the screw holes or lettering on the rear panel.

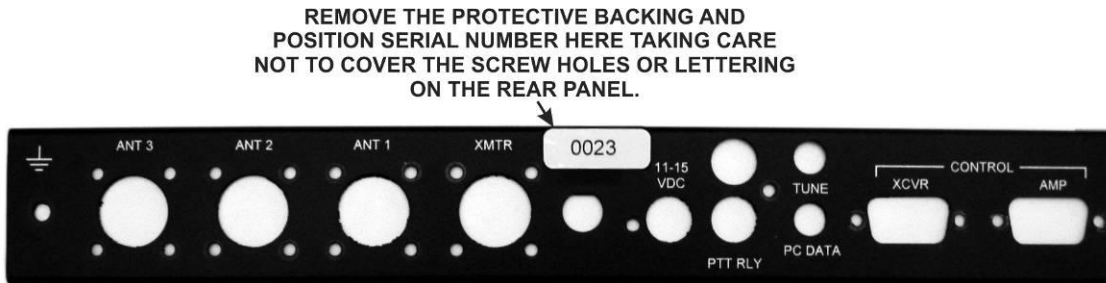

Figure 19. Attaching Serial Number to Rear Panel.

□ Install the XMTR SO-239 connector in the rear panel opening marked XMTR as shown in Figure 20. Take care not to bend the wire or move the solder lug. Place the flange of the connector inside the rear panel, and orient the connector so the lug on the wire points toward the ANT1 connector opening as shown.

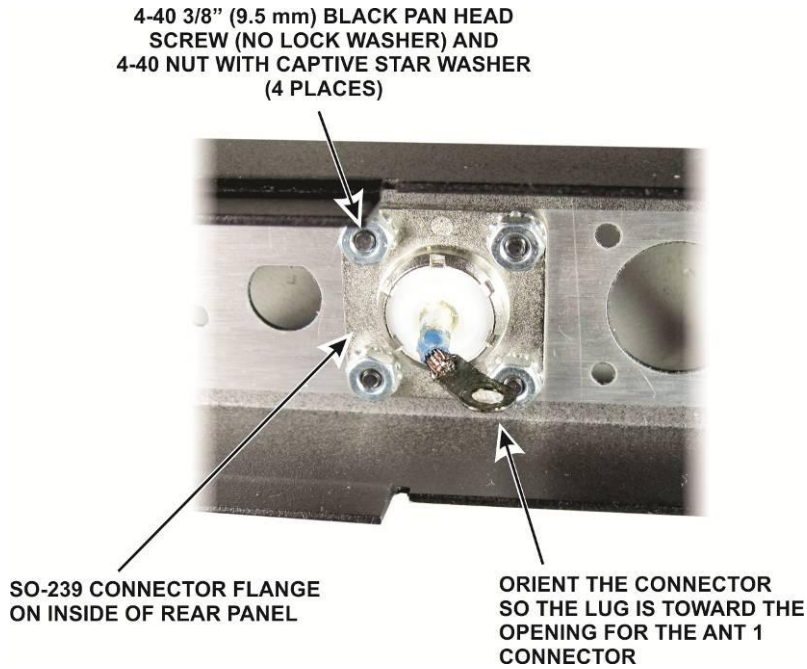

Figure 20. Installing the XMTR SO-239 Connector in the Rear Panel.

□ In the same manner, install the remaining SO-239 connectors on the rear panel, starting with the ANT3 connector at the end. Orient the connectors so the leads are as shown in Figure 21 and with the connector flanges on the inside of the rear panel.

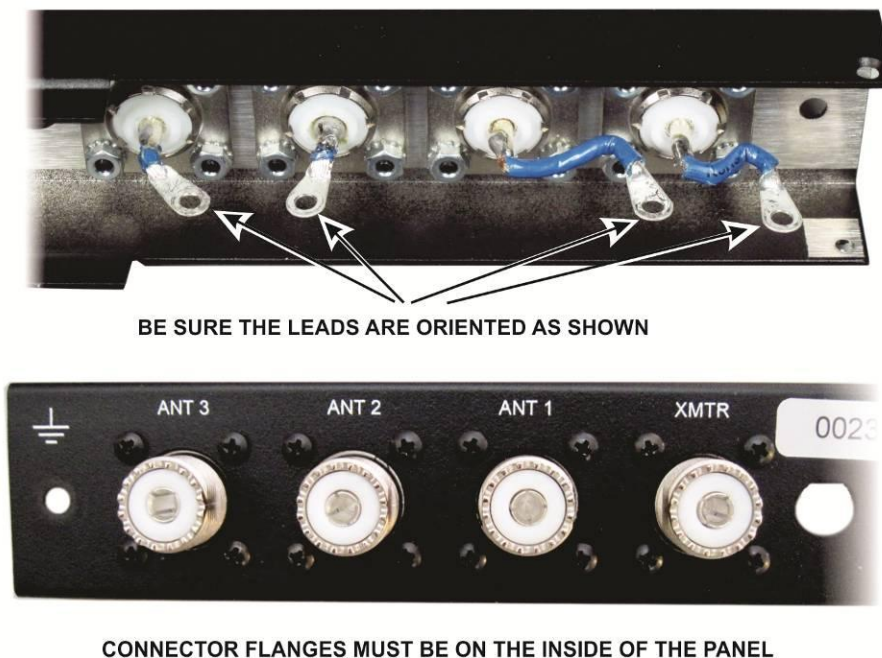

Figure 21. SO-239 Connectors Installed.

□ Mount the ground terminal at the end of the rear panel next to the ANT 3 connector as shown in Figure 22. Install the screw, lock washer and nut first and secure the nut so the screw cannot turn. Then add the two flat washers and the wing nut.

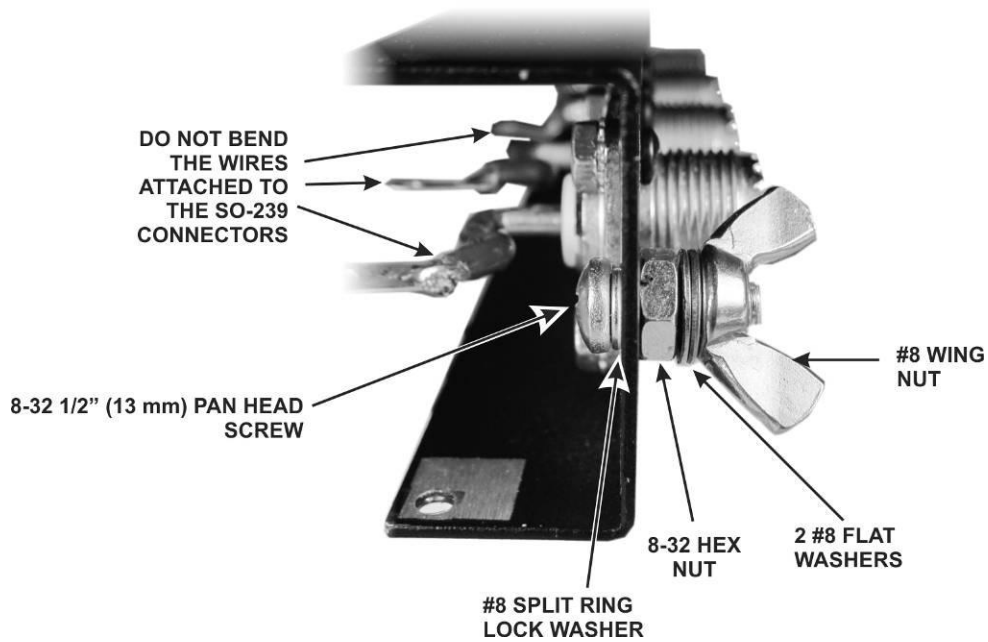
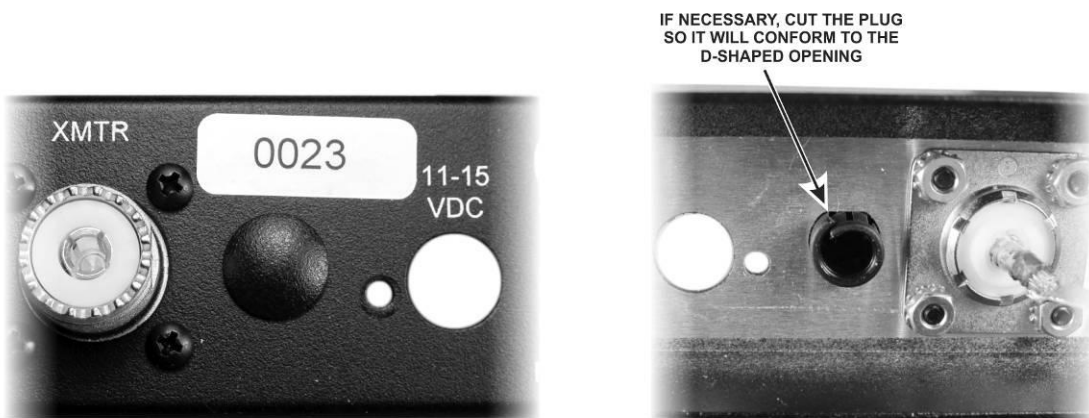

Figure 22. Installing the Ground Terminal.

□ If there is an opening next to the XMTR SO-239 connector as shown in Figure 23, install the BNC hole cover in the opening. Press the cover in until the ears on the plug lock it into place. This opening is “D” shaped. If needed, cut the plug section as shown to fit in the hole.



**!** NOT ALL UNITS HAVE THIS OPENING OR REQUIRE THE PLUG

Figure 23. Installing the BNC Hole Cover.

☐ Position the rear panel on the pc board/bottom cover assembly you assembled earlier as shown in Figure 24. Be sure the tab at the center of the rear panel fits inside the bottom cover as shown.

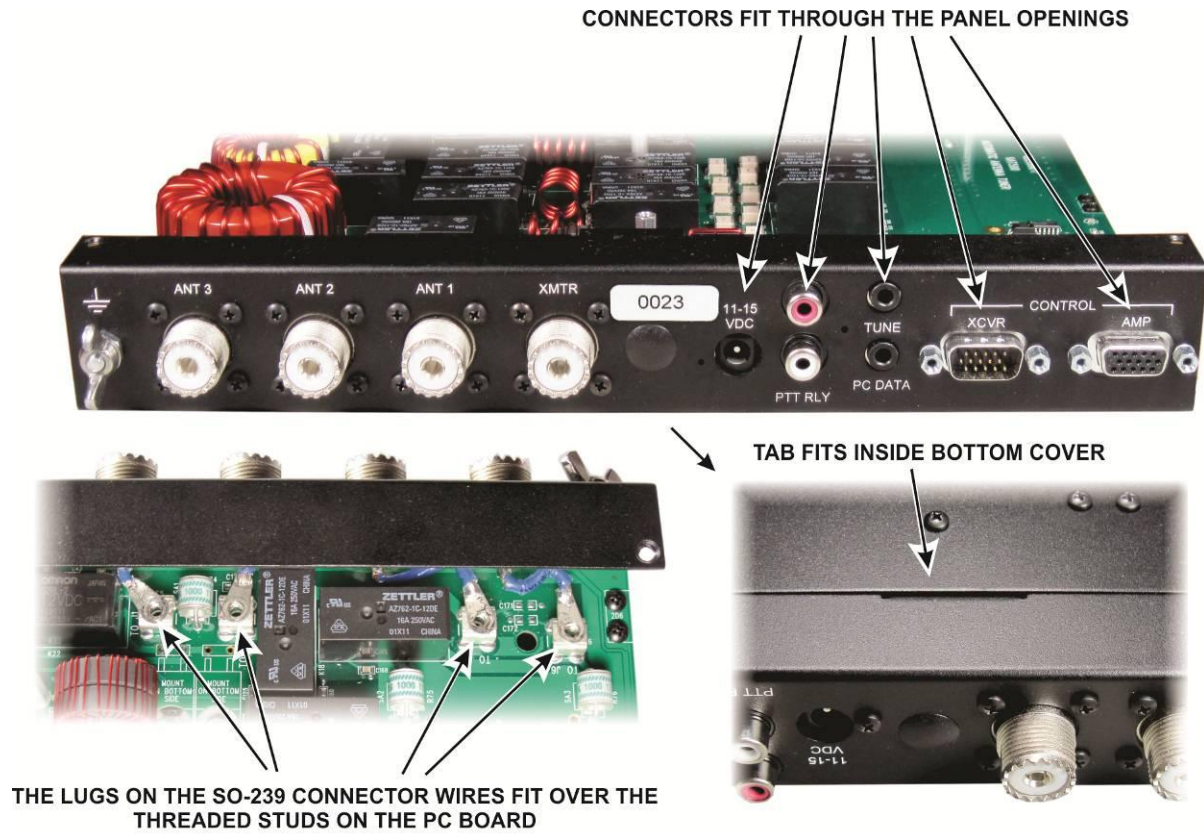

Figure 24. Positioning the Rear Cover on the PC Board and Bottom Cover Assembly.

☐ Begin securing the rear panel to the pc board assembly with four jack screw nuts on the XCVR and AMP connectors as shown in Figure 25.



**⚠ CAUTION: DO NOT OVER-TIGHTEN THE NUTS. IT IS EASY TO TWIST THE NUT OFF OF THE THREADED SHAFT.**

Figure 25. Installing Jackscrew Nuts on XCVR and AMP Connectors.

- Install the two pan head screws shown in Figure 26. **Stop turning the screw indicated when the head reaches the rear panel. It threads into plastic and the threads will easily strip.**

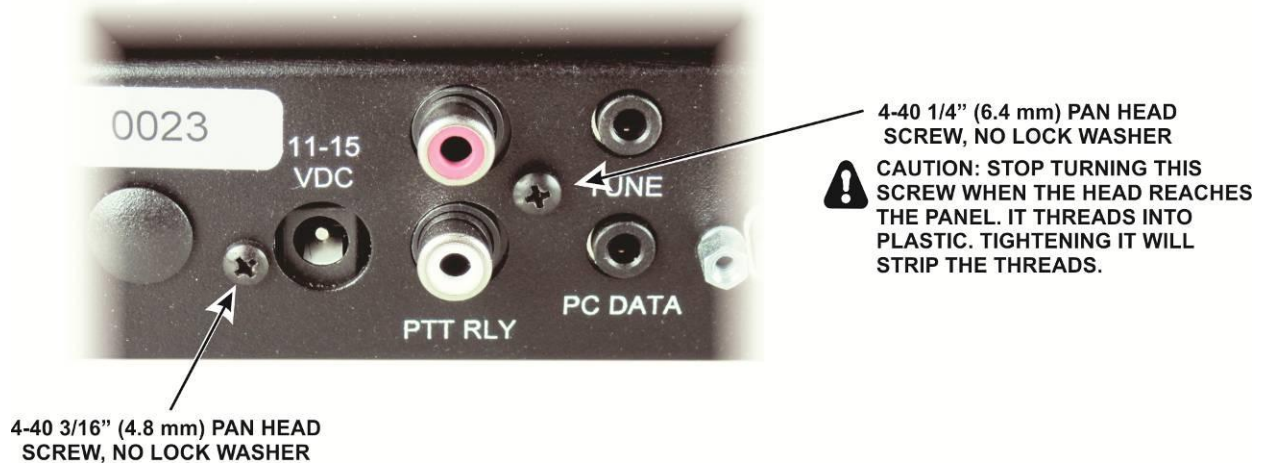

Figure 26. Installing Rear Panel Pan Head Screws.

- Attach the wires leading to each of the SO-239 connectors to the screw posts on the pc board as shown in Figure 27.

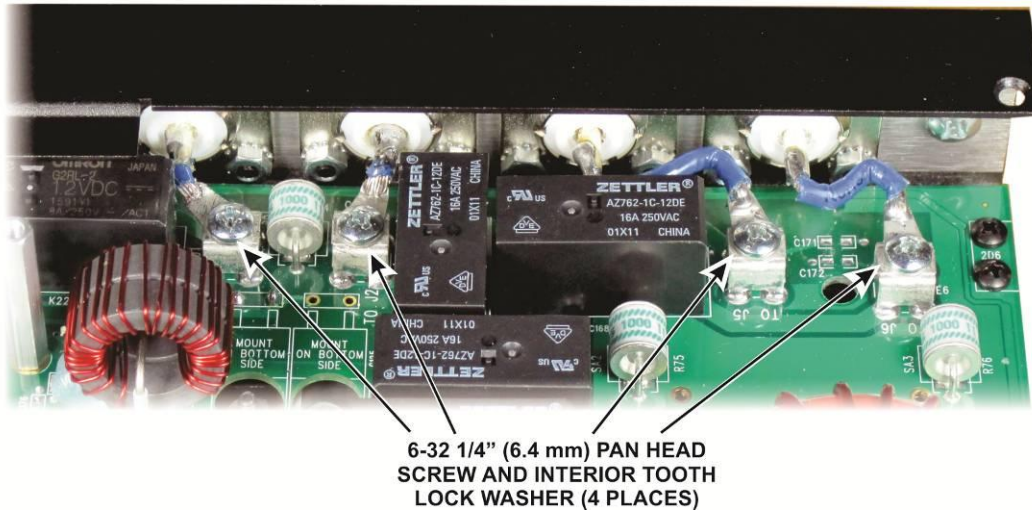

Figure 27. Securing SO-239 Wires to the PC Board Screw Posts.

☐ Turn the assembly over and secure the bottom lip of the rear panel to the 2D fasteners as shown in Figure 28.

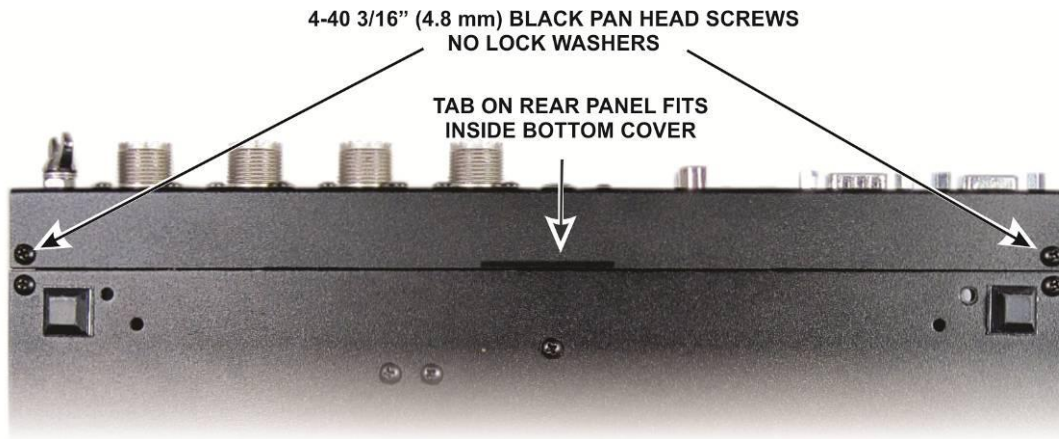

Figure 28. Installing Screws in Rear Panel Bottom Lip.

☐ Install the four standoffs shown in Figure 29. The standoffs pass through large holes in the pc board and mount on the bottom cover as shown.

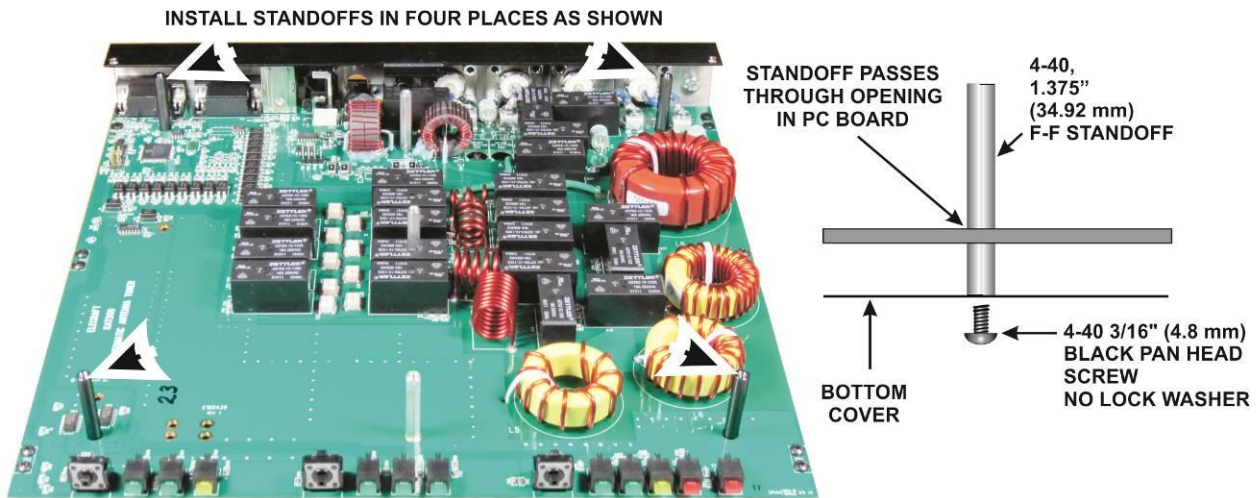

Figure 29. Installing Through-Board Standoffs.



☐ On the edge of the pc board that has the rows of LEDs, install key caps on the three switches (S1, S2 and S3) as shown in Figure 30. Be sure you orient the key caps horizontally (parallel with the pc board).

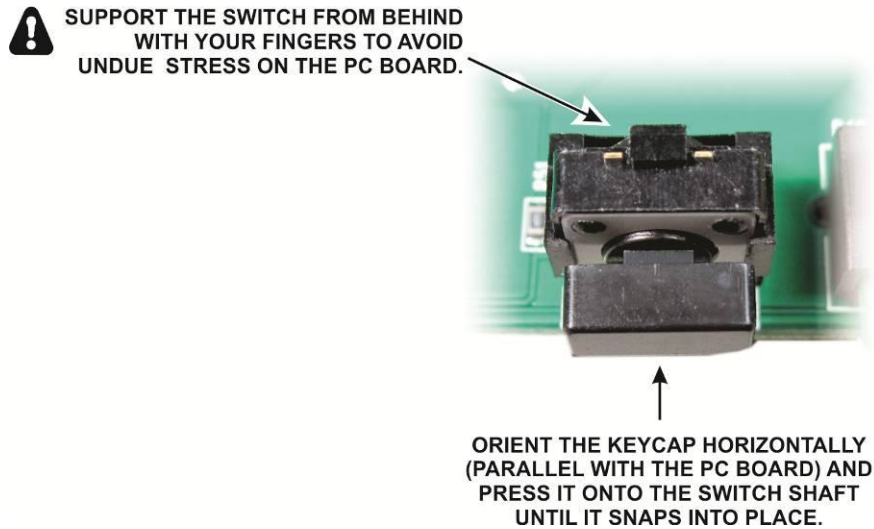

Figure 30. Installing Key Caps on the Switches.

☐ Locate the front panel and inspect the inside surface around the four screw holes (see Figure 31). Remove any tape or residue to provide a clean metal surface.

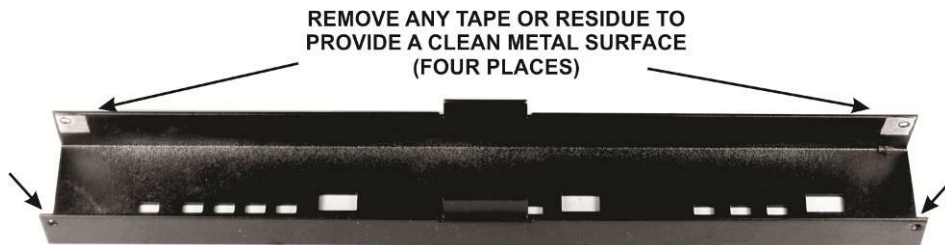

Figure 31. Preparing the Front Panel for Installation.

☐ Turn the KAT500 upside down on your table and mount the front panel as shown in Figure 32. Be sure that all of the LEDs and switches pass through the openings in the front panel and that the tab at the center of the front panel fits under the bottom cover, just as on the rear panel.



Figure 32. Mounting the Front Panel.

Set the KAT500 on its feet and confirm that all three switches operate smoothly and that all of the LEDs are in the front panel cutouts. The LEDs should protrude slightly so you can feel them by running your finger across the panel.

Locate the side panels and clean any tape or residue from the areas around the screw holes on the inside surface as shown in Figure 33. Check and clean both side panels.

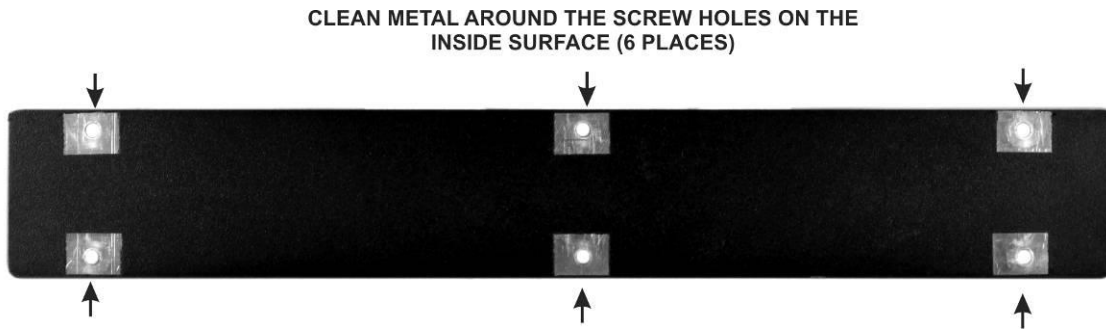

Figure 33. Preparing Side Panels for Installation.

Place a side panel on the KAT500, lining up the three holes along the bottom with the 2D fasteners between the pc board and the bottom cover. Be sure all three holes line up. If they do not line up, turn the side panel over to line up the other three holes. Attach the side panel with three screws as shown in Figure 34 (1).

Mount three 2D fasteners along the top edge of the side pane as shown in Figure 34 (2). Be sure the widest side is toward the side panel as shown. You may need to loosen the screws along the bottom edge to allow the panel to move to properly align the holes.

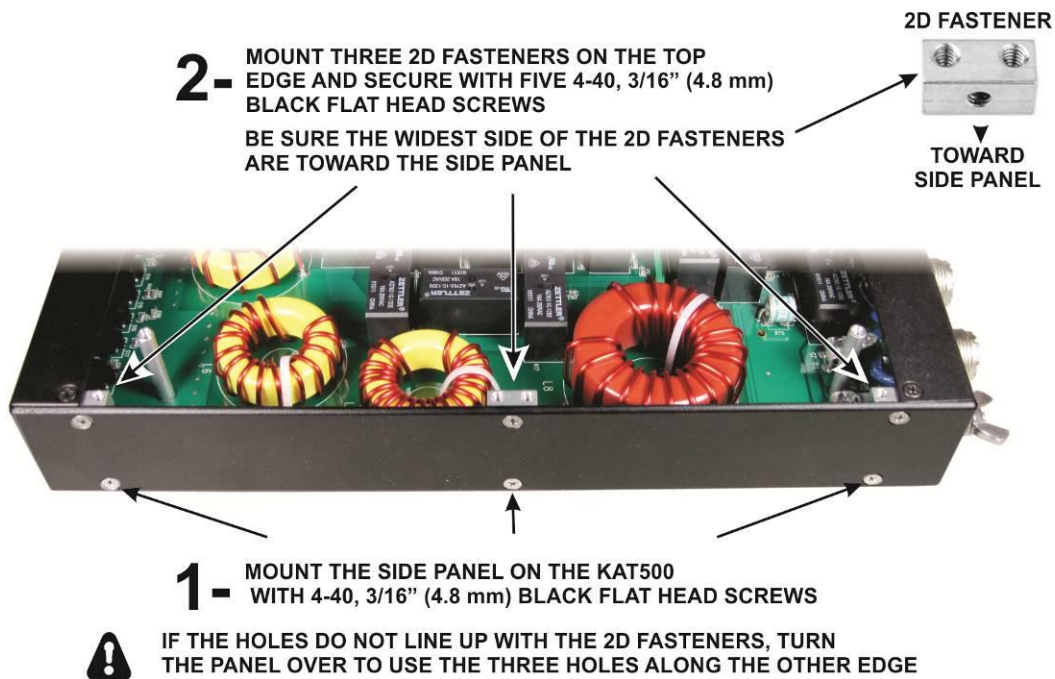

Figure 34. Installing the Side Panels.

Install the second side panel in the same manner as the first.

In the following steps you will prepare and install the top cover. But before you do, check to ensure the screws inside the KAT500 are tight without over-tightening them:

- The 11 screws along the sides of the pc board (Figure 7, page 24).
- The four screws securing the SO-239 connector leads to the standoffs on the pc board (Figure 27, page 36).

Locate the top cover and clean any tape or residue from around the holes on the inside surface along the sides as shown in Figure 35. Note that not all of the screw holes have bare metal around them. Only those shown need to be checked.

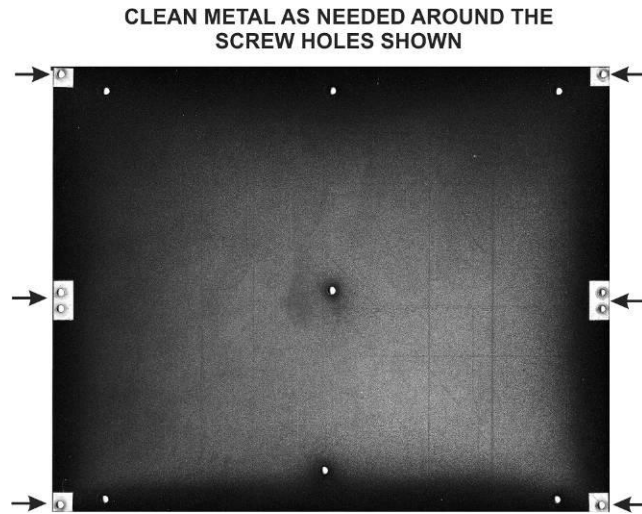

Figure 35. Preparing the Top Cover for Installation.

□ Place the top cover on the KAT500 and secure it as shown in Figure 36. The cover sits on top of the tabs at the center of the front and rear panels. If all of the screw holes do not line up, rotate it a half turn. It only fits one way. You may need to loosen some of the other enclosure screws for the cover to fit properly. That is normal. The top cover should fit flush with the surrounding panels. Once you have loosened and tightened the screws as needed for all of the panels to fit together, you will be able to remove and replace individual panels in the future, if needed, without having to repeat that process.

4-40 3/16" (4.8 mm) BLACK FLAT HEAD SCREWS WHERE INDICATED  
(15 PLACES)

**!** LOOSEN SURROUNDING PANEL SCREWS AS NEEDED TO ADJUST THE POSITION OF THE ADJACENT PANELS FOR A SMOOTH FIT. THE TOP COVER SHOULD BE FLUSH WITH THE SURROUNDING PANELS.



Figure 36. Installing the Top Cover.



**!** **IMPORTANT:** The enclosure screws, including all of the top cover screws, are important to the structural strength KAT500. Always be sure that all the screws are in place and tight.

That completes the assembly of your KAT500. Turn to page 3 for setup and operating instructions.

# Appendix A Parts List

## KAT500 Cable Set

The following cables are supplied with both factory-built and kit KAT500s.

ILLUSTRATION	DESCRIPTION	QTY.	ELECRAFT PART NO.
	<p>Data Cable Assembly: Either RS232 or USB, chosen at the time order is placed.</p> <p><b>NOTE:</b> If you chose the KXSER cable, the bag may be marked E850369.</p>	1	KXUSB (USB) Or KXSER (RS232)
	<p>Power Cable                      This cable will be found in the Core Assembly package in kits.</p>	1	E850775
	<p>RCA Male-to- Male (Key Line) Cable                      This cable will be found in the Core Assembly package in kits.</p>	1	E100416

## KAT500 Circuit Board

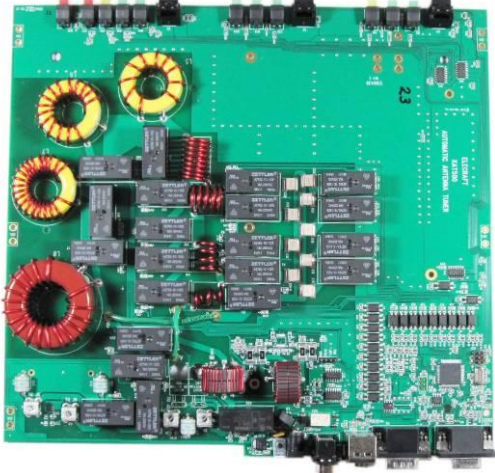
ILLUSTRATION	DESCRIPTION	QTY.	ELECRAFT PART NO.
	<p>KAT500 PCB Assembly</p> <p><b>⚠</b> ESD Sensitive. Do not remove from its ESD-Safe packaging without first taking ESD precautions (see page 23).</p>	1	E850551

## Serial Number Envelope E850549

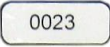

ILLUSTRATION	DESCRIPTION	QTY.	ELECRAFT PART NO.
	Serial Number Label	1	E980236

## KAT500 Core Assembly – E850561

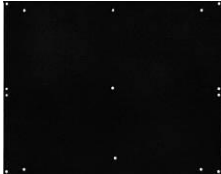
### Wrapped Covers E850565





ILLUSTRATION	DESCRIPTION	QTY.	ELECRAFT PART NO.
	Bottom Cover	1	E100437
	Top Cover	1	E100438

### Wrapped Panels E850564

ILLUSTRATION	DESCRIPTION	QTY.	ELECRAFT PART NO.
	Front Panel	1	E100434SS
	Rear Panel	1	E100435SS
	Side Panel	2	E100436

**Miscellaneous Bag E850562**

ILLUSTRATION	DESCRIPTION	QTY.	ELECRAFT PART NO.
	Lock Washer, #6, Interior Tooth	4	E700095
	4-40 Nut, Hex, Zinc	1	E700011
	8-32 Nut, Hex, Zinc	1	E700202
	4-40 Nut with Captive Star Washer	1	E700191
	Wing Nut, 8-32, Stainless Steel	1	E700193
	2-D Fastener	12	E100078
	L-Bracket	1	E700073
 (Typical)	4-40 Screw, 3/8" (9.5 mm) Black Pan Head	1	E700175
	4-40 Screw, 1/4" (6.4 mm) Black Pan Head	2	E700174
	4-40 Screw, 3/16" (4.8 mm) Black Pan Head	32	E700172
	4-40 Screw, 3/16" (4.8 mm) Black Flat Head	31	E700173
 (Typical)	8-32 Screw, 1/2" (13 mm) Zinc Pan Head	1	E700192
	6-32 Screw, 1/4" (6.4 mm) Zinc Pan Head	4	E700281
	Lock Washer, #8 Split Ring	1	E700203
	Lock Washer, #4, Split Ring	5	E700004
	BNC Hole Cover Not supplied with all units. See Figure 23 on page 33.	1	E980136
	Washer, #8 Flat	2	E700194
	1/2 X 1/2 (13 mm X 13 mm), Rubber Foot, Self-Adhesive	4	E700024
	Jackscrew Nut, 4-40	4	E700078



ILLUSTRATION	DESCRIPTION	QTY.	ELECRAFT PART NO.
	Keycap, Rectangular	3	E980000
	Thermal Pad	1	E700002
 <p data-bbox="316 609 430 640">(Typical)</p>	4-40 F-F Standoff, 1.375" (34.92 mm)	4	E700275
	4-40 F-F Standoff, 1/4" (6.4 mm)	3	E700026
	4-40 M-F Standoff, 1-1/16" (27 mm)	3	E700276
	Cable Tie, Plastic, 4" (10.2 cm)	4	E980245





**⚠ IMPORTANT:** The following SO-239 Assemblies have wires pre-formed to fit in your KAT500. Each connector is different.

- Do not mix them up.
- Do not bend or reshape the wires.



*Ant 1 SO-239 Assembly E850553*

ILLUSTRATION	DESCRIPTION	QTY.	ELECRAFT PART NO.
	Ant 1 SO-239 Assembly	1	E850553
	4-40 Screw, 1/4" (6.4 mm) Black Pan Head	4	E700174
	4-40 Nut with Captive Star Washer	4	E700191



*Ant 2 SO-239 Assembly E850560*

ILLUSTRATION	DESCRIPTION	QTY.	ELECRAFT PART NO.
	Ant 2 SO-239 Assembly	1	E850560
	4-40 Screw, 1/4" (6.4 mm) Black Pan Head	4	E700174
	4-40 Nut with Captive Star Washer	4	E700191

*Ant 3 SO-239 Assembly E850559*

ILLUSTRATION	DESCRIPTION	QTY.	ELECRAFT PART NO.
	Ant 3 SO-239 Assembly	1	E850559
	4-40 Screw, 1/4" (6.4 mm) Black Pan Head	4	E700174
	4-40 Nut with Captive Star Washer	4	E700191

***XMTR SO-239 Assembly E850554***

<b>ILLUSTRATION</b>	<b>DESCRIPTION</b>	<b>QTY.</b>	<b>ELECRAFT PART NO.</b>
	XMTR SO-239 Assembly	1	E850554
	4-40 Screw, 1/4" (6.4 mm) Black Pan Head	4	E700174
	4-40 Nut with Captive Star Washer	4	E700191