

Users Manual

200W HF/50MHz Band
Auto Antenna Tuner

Model HC-200AT



Caution

1. Never remove or open the tuner cover while transmitting.
When there is RF in the circuits of the tuner, there will be high voltage RF on the components and you can get an RF burn. Please use caution !!
2. You must reduce power to no more than 20 watts while tuning.
3. Never touch the antenna output especially when using a wire antenna.
There is a high voltage at that point.
4. Do not transmit unless you are connected to an antenna or dummy load.
5. Never exceed the maximum designed power of 200 watts into the tuner.

Features

1. HC-200AT is a compact 200W HF/6m auto antenna tuner . It works with any radio having a frequency coverage of 1.8~54MHz, and power output of 2-200W.
2. With a wire antenna of 7.5m (25 feet) or longer, the tuner will tune from 3.5 through 54MHz. For 1.8MHz (160M), a minimum length wire of 30m (95 feet) is recommended.
3. The advanced 16 bit MPU (micro processor) calculates the ratio of forward and reflected power. Our newly developed computing algorithm will produce a world class tuning speed.
4. 256 capacitors (C) and inductors (L) are combined to form the inverted L-shape circuit. Depending on antenna, capacitances may be switched from one end of inductors to the other to form the reversed inverted -L shape circuit. There are 131,072 combinations of L & C.
5. Tuned data of L and C are stored in the ten channel memory. Tuning under memory mode using the same antenna on the same frequency is finished within 0.2 second after the initial tuning.
6. High current capacity relays are used in the L and C tuning network.
7. Tuning will be accomplished by tapping the “TUNE” button, and or pressing the “TUNER” (or “TUNE”) button of the radio, if the tuner is connected to the Radio Interface” cable. (See Connection Section.)
8. Analog meter monitors the forward power (PF) and SWR. SWR is indicated automatically with the modern processor IC.

Front Panel Description

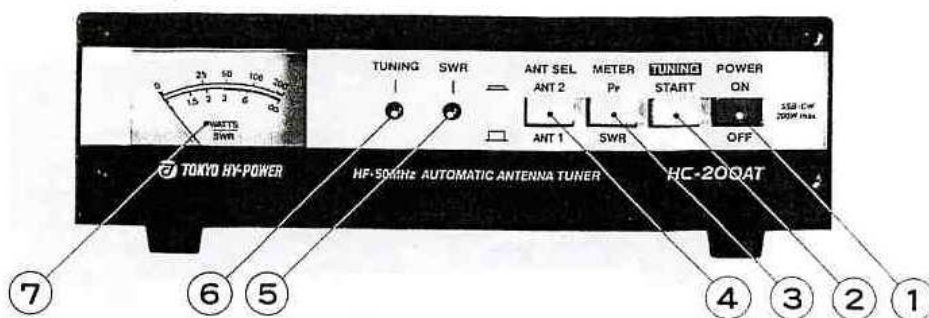

TUNING Red LED lights while the tuner is working to match the antenna and goes off when tuning is finished. LED will flash for a few seconds., if SWR is over 2.5 after tuning is completed.

SWR The green LED lights if SWR is less than 1.5 after the tuning. And it flashes for a few seconds when SWR after the tuning is 1.5~2.5 .

TUNE (Button) If this switch is tapped (for less than 0.3 second), t tuner will enter into **by-pass (through) mode**. And if pressed for 0.3 second or longer, tuning will automatically start. By pressing “TUNER (TUNE)” button on the radio, tuning may be initiated when radio interface cable is connected from the tuner to the TUNER socket on the radio.

METER (PF / SWR Select Switch) Switches between forward power (PF) and SWR of PF / SWR meter.

PF / SWR METER Power meter to read the forward power and SWR.

ANT SEL (Antenna 1, Antenna 2/ Wire Select) This switch selects three types of your antennas, or two coax cable antennas and one wire antenna.

POWER (Switch) If this switch is pressed, DC power will be turned on. Also the power meter will be lighted and it is useful in dark areas. Pressing the switch to unlock, DC power will be turned off. At this time the tuner network will be connected to **Antenna 1**.

Rear Panel Description

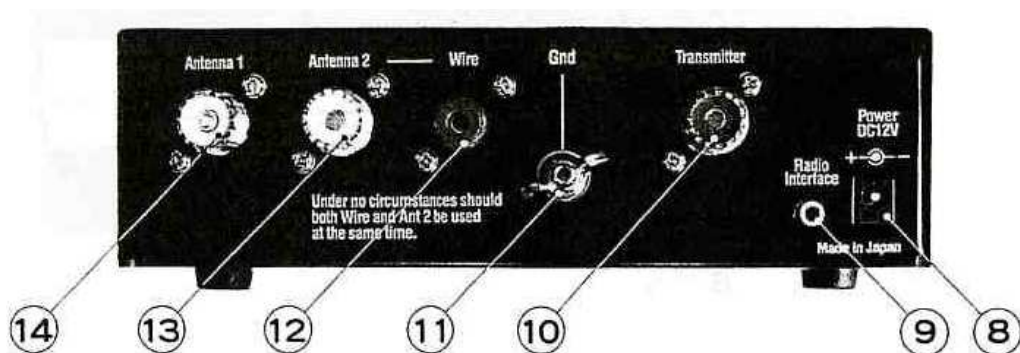

Antenna 1 & 2 (UHF Connectors, SO-239) Connect a 50 ohm coax antenna cable.

Wire (Terminal) Hook an antenna wire here. Balun such as 1:4 for ladder type feeder may be connected to this terminal.

Under no circumstance should both the wire antenna and a coax cable (to Antenna 2) be used at the same time.

GND (Bolt with butterfly nut) Connect the shortest possible grounding wire to the earth. Or the counterpoise (wire) can be hooked here instead of grounding when the antenna is a wire type.

Transmitter Connect a coax cable from the ANT of the radio.

Radio Interface (Jack) Connect a tuner control cable from the radio. (In some ICOM radios, the 4 pin TUNER socket is available on the rear panel.) (See Connection Section of this manual as well as the radio manual.)

Power DC 12V DC power socket to receive DC12V (12~13.8V, 0.5A max.)

Connection

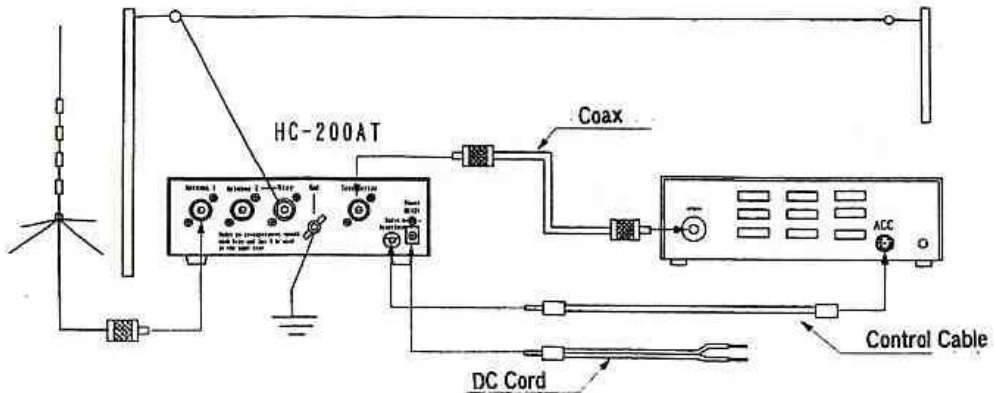

1. Connect a coax jumper cable from the radio to **Transmitter**.
2. Connect the plug of the DC power cord (supplied in the package) to **Power 12V** and the other end to the DC power supply or battery (12~13.8V). (When this connection is made, **the tuner is on.**)
3. Either connect a coax cable from the antenna to “**Antenna**”, the SO-239 output connector, or if using a long wire, connect the wire to the “**Wire**” output with the thumbnut.
4. If the external tuner control function is available with your radio, and you wish to use it, connect a radio interface cable. (Illustration shows the example for ICOM radios ; IC-703, -706, -746, -756, and so on.) If this function is not available with your radio, follow the instruction per the Operation Section, 2) Tuning A).

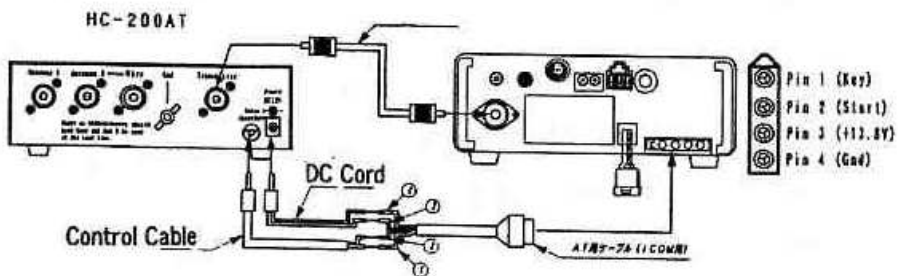

About Antennas

1. Coax Fed Antenna

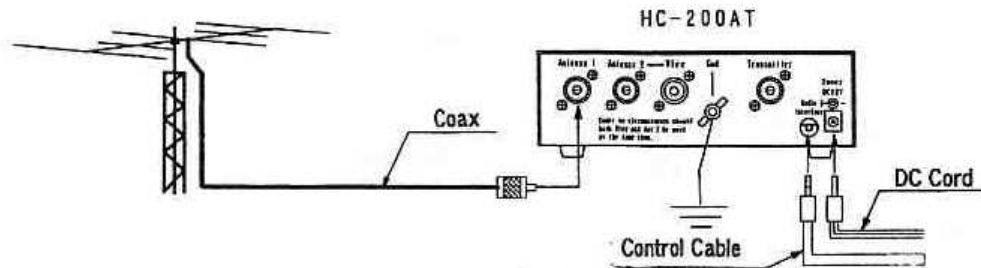

Antennas with coax feeders such as dipole, Yagi, vertical ground plane, must be connected using 50 ohm coax to “**Antenna**” connector.

2. Long Wire Antenna

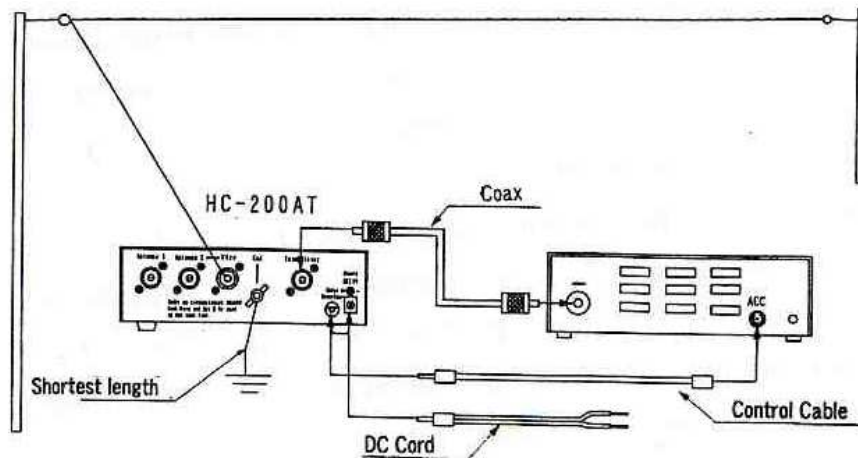

Connect the antenna wire to “**Wire**”. Also connect a grounding wire to **GND**. The connection to a ground should be as short as possible and with a heavy gauge copper wire, or wide braided wire used for grounding. If a ground is not available, use a sufficient counterpoise of wire lengths such as 3 meter (10 feet), 10 meter (33 feet), and 30 meter (100 feet) being connected in parallel and laid on the ground.

3. Whip Antenna

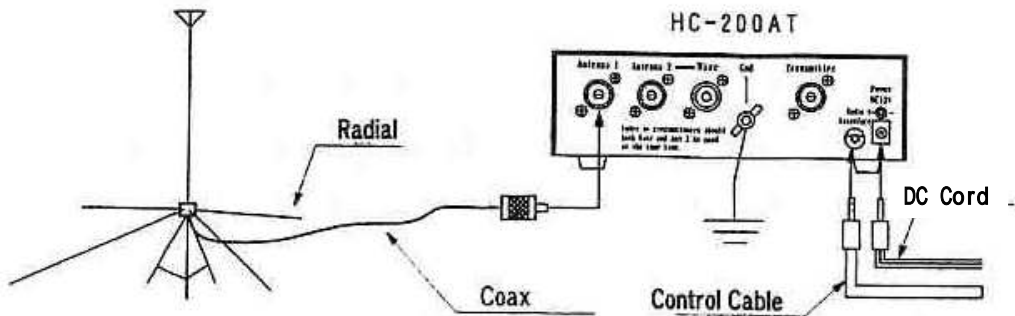

With the portable whip antenna of approximately 2.5m (8.3 feet) long, tuner will work well between 7 through 54MHz.

4. Multi Band Antenna with Ladder Feeder

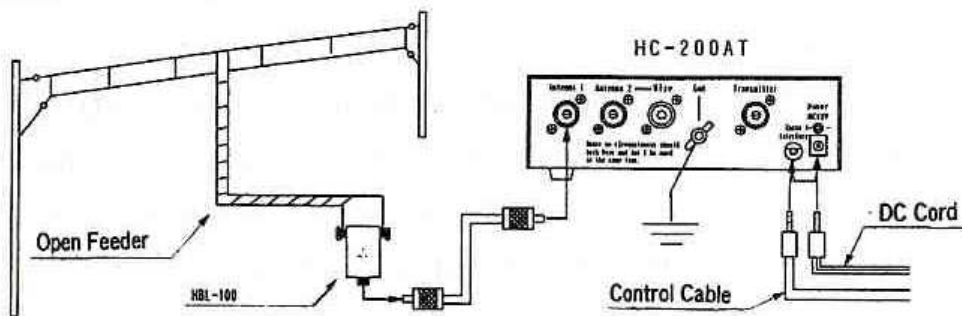

To feed the multi-band dipole or the loop antenna with the balanced ladder line , use a 1 : 4 balun such as our optional HBL-100 which makes a tuning smooth.

Operation

1. Through If **TUNE** button is tapped (for less than 0.3 second), the tuner will go into “ **Through (By-pass)**” state. Red LED lamp of **TUNING** lights when button is tapped. Also, green LED of **SWR** lights for several seconds.

2. Tuning This tuner will make an auto tuning when the antenna SWR is 1.5 or higher. If SWR is less than 1.5 and the antenna is in a good match, an auto tuning will not be made. The red LED of **TUNING** will simply flash in this case.

A) When the external **TUNER CONTROL** function (of radio) not used.

Drive less than 20W in CW/RTTY mode from the radio (or a half of maximum output power for the QRP radio), and press the **TUNE** button for longer than 0.3second, and automatic tuning will start. When tuning is finished, the red **LAMP** will light. (Instead of driving CW/RTTY carrier, you may as well whistle in SSB mode for several seconds till tuning is finished.)

B) When the external **TUNER CONTROL** function (of your radio) is used.

Press the “ **TUNE (or TUNER)** “ button for longer than 0.3 second, and auto tuning will start.

With a SWR of 1.5 or less achieved after tuning, the green LED will light. And the tuning data is stored in the memory. Now you may start operating the QSO with up to 200 watts. If SWR of 1.5 ~ 2.5 is achieved after the tuning, the green LED will flash. Should the SWR be 2.5 or higher, the red LED will flash.

3) Power Measurement Transmitting output power and SWR can be read using the **METER** . Use the switch to select **PF (forward)** and **SWR**.

4) Antenna Select Pressing the switch button, either the Antenna 1 or the Antenna 2/ Wire can be selected. When the DC power is not turned on, the tuner network is always connected to Antenna 1.

Trouble Shooting

- 1) **If A Low SWR Is not Achieved** Depending on the antenna , if a satisfactory match is not achieved, try the tune process again. If then you still can not get the desired result after the repeated tuning, it is possible that antenna length is not proper for that frequency, or that output of QRP radio is too low (less than 2 watt). Extend , or shorten the antenna wire. When using a long wire or whip, try to increase the number of counterpoise with different lengths, especially if good ground is not available.
- 2) **Tuning Failure on Low Band** For 160m band (1.8MHz) operation, a long wire antenna should be at least 30 meter (98 feet). If the wire length can not be extended over 20m (67 feet), it is suggested that a coil of approximately 10uH is inserted somewhere in the antenna wire. Grounding must be checked as well.
- 3) **RFI** When the antenna is working under voltage feeding mode rather than current feeding, an RF interference to the nearby FM radio and TV may be induced. If this should happen, try moving the radio and antenna to a different location usually further away from the effected devices. Also check the ground.

Optional Balun, HBL-100

Optional Balun, HBL-100



Model HC-200AT / Specifications

Parameter	Description	Remarks
Frequency Range	1.8 - 54MHz	
Output Impedance Range	5 - 500 ohms (3.5 - 54MHz)	
	15 - 500 ohms (1.8 MHz)	
Maximum Handling Power	200W (P.E.P. / CW)	
Input Impedance	50 ohms	
Tuning Power	2 - 20W	Minimum and most adequate power
Tuning Time	1.5 sec.(typ.) for initial tuning	For SWR= 3.5 : 1
	4 sec.(max.)	
	0.2 sec. for memory mode	
DC Power Voltage	DC 12V - 14V	
Current Drain	0.8A max.	
Quiescent Current	0.1A	
DC Power Polarity	Negative ground	
Operating Temp. Range	-10 deg. to + 60 deg. C	
VSWR (Max.)	1.5 (typ.) or lower *	After tuning
Number of Memory	10 ch.	
Dimension	195 x 60 x 242 mm (W x H x D)	7.7 x 2.4 x 9.5 inches
Weight	Approx. 1kg. (2.2 lbs.)	
Accessories	DC power cable, 3.5mm dia. Plug ***	*** Ear-phone plug
Optional Parts	1: 4 Unbal. To Bal. Balun	Model HBL-100
	Remote control Cable for ICOM Radio	HTC-100AT/ICOM5 (5meter)
	Remote control Cable for ICOM Radio	HTC-100AT/ICOM10 (10meter)
* This tuner does not tune to wire antenna length of multiples of half a lamda or its vicinity.		

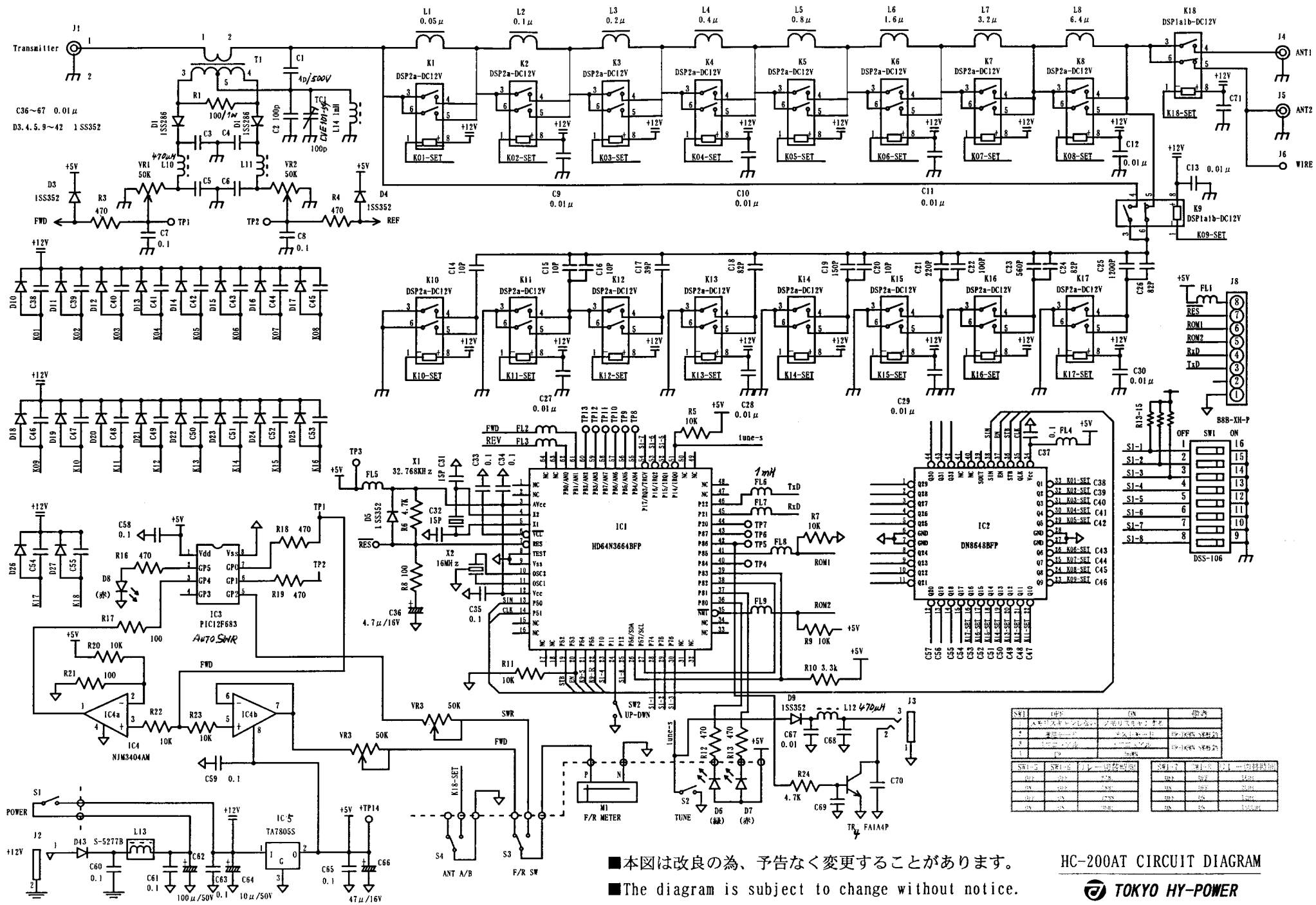

部品名	仕様	数量	備考
1	トランス	1	
2	トランス	1	
3	トランス	1	
4	トランス	1	
5	トランス	1	
6	トランス	1	
7	トランス	1	
8	トランス	1	
9	トランス	1	
10	トランス	1	
11	トランス	1	
12	トランス	1	
13	トランス	1	
14	トランス	1	
15	トランス	1	
16	トランス	1	
17	トランス	1	
18	トランス	1	
19	トランス	1	
20	トランス	1	
21	トランス	1	
22	トランス	1	
23	トランス	1	
24	トランス	1	
25	トランス	1	
26	トランス	1	
27	トランス	1	
28	トランス	1	
29	トランス	1	
30	トランス	1	
31	トランス	1	
32	トランス	1	
33	トランス	1	
34	トランス	1	
35	トランス	1	
36	トランス	1	
37	トランス	1	
38	トランス	1	
39	トランス	1	
40	トランス	1	
41	トランス	1	
42	トランス	1	
43	トランス	1	
44	トランス	1	
45	トランス	1	
46	トランス	1	
47	トランス	1	
48	トランス	1	
49	トランス	1	
50	トランス	1	
51	トランス	1	
52	トランス	1	
53	トランス	1	
54	トランス	1	
55	トランス	1	
56	トランス	1	
57	トランス	1	
58	トランス	1	
59	トランス	1	
60	トランス	1	
61	トランス	1	
62	トランス	1	
63	トランス	1	
64	トランス	1	
65	トランス	1	
66	トランス	1	
67	トランス	1	
68	トランス	1	
69	トランス	1	
70	トランス	1	

部品名	仕様	数量	備考
1	トランス	1	
2	トランス	1	
3	トランス	1	
4	トランス	1	
5	トランス	1	
6	トランス	1	
7	トランス	1	
8	トランス	1	
9	トランス	1	
10	トランス	1	
11	トランス	1	
12	トランス	1	
13	トランス	1	
14	トランス	1	
15	トランス	1	
16	トランス	1	
17	トランス	1	
18	トランス	1	
19	トランス	1	
20	トランス	1	
21	トランス	1	
22	トランス	1	
23	トランス	1	
24	トランス	1	
25	トランス	1	
26	トランス	1	
27	トランス	1	
28	トランス	1	
29	トランス	1	
30	トランス	1	
31	トランス	1	
32	トランス	1	
33	トランス	1	
34	トランス	1	
35	トランス	1	
36	トランス	1	
37	トランス	1	
38	トランス	1	
39	トランス	1	
40	トランス	1	
41	トランス	1	
42	トランス	1	
43	トランス	1	
44	トランス	1	
45	トランス	1	
46	トランス	1	
47	トランス	1	
48	トランス	1	
49	トランス	1	
50	トランス	1	
51	トランス	1	
52	トランス	1	
53	トランス	1	
54	トランス	1	
55	トランス	1	
56	トランス	1	
57	トランス	1	
58	トランス	1	
59	トランス	1	
60	トランス	1	
61	トランス	1	
62	トランス	1	
63	トランス	1	
64	トランス	1	
65	トランス	1	
66	トランス	1	
67	トランス	1	
68	トランス	1	
69	トランス	1	
70	トランス	1	

■本図は改良の為、予告なく変更することがあります。
 ■The diagram is subject to change without notice.

HC-200AT CIRCUIT DIAGRAM

