

DM330MVC Adjustment and Testing manual

Explanation

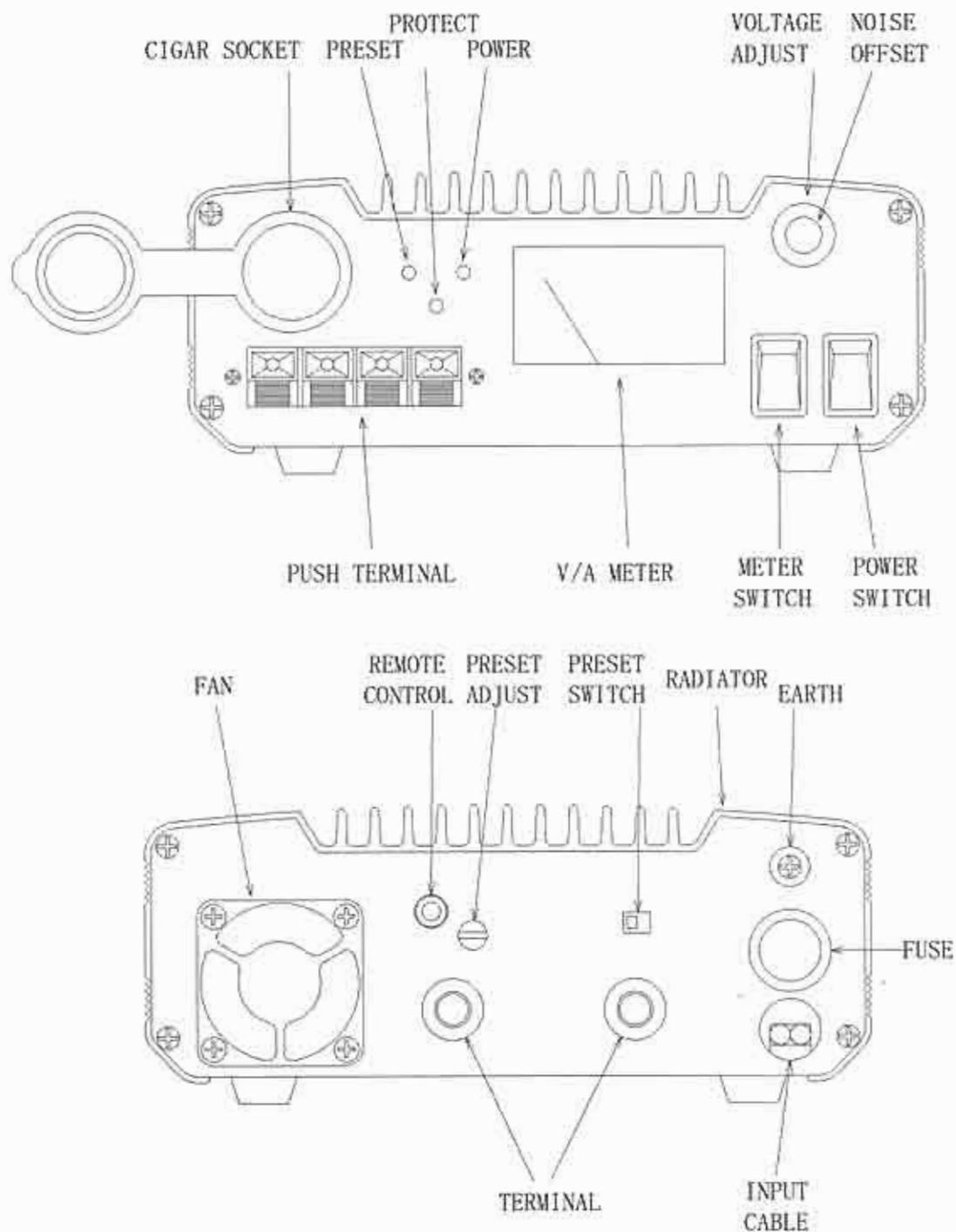

Setting

DM3 3 0 MV

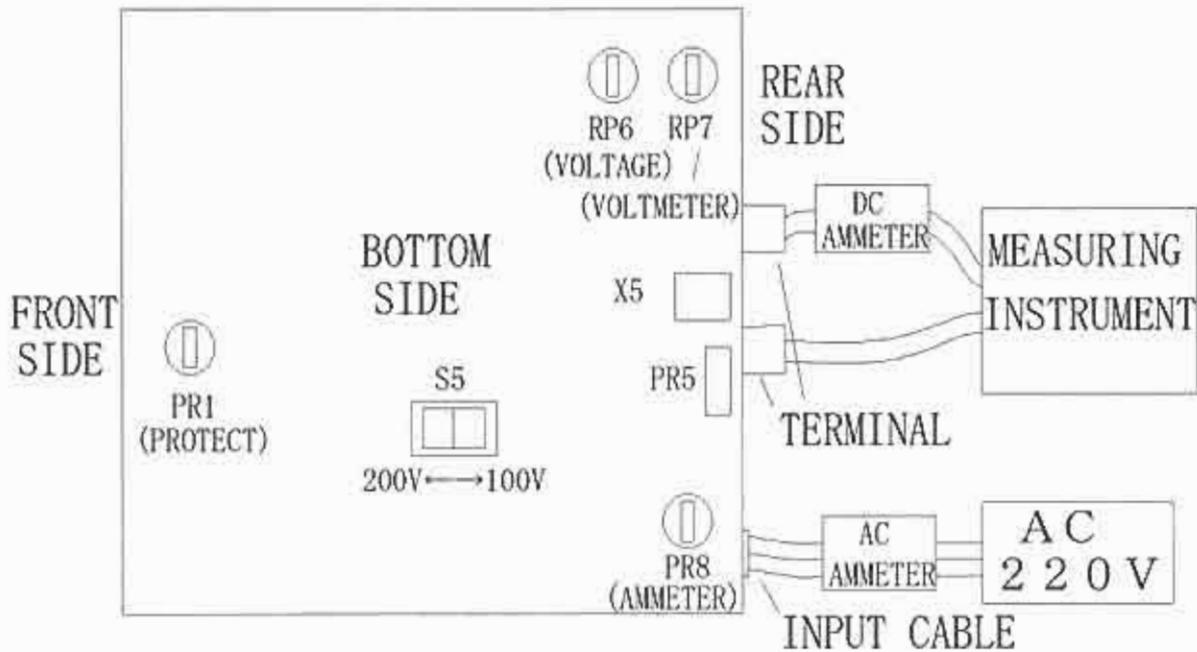

Looking check

Check the below items before supply the AC voltage. It's possible to blast the electric parts, if mistake to put on it.

- 1) Check if the direction of the S5 is correct side.
- 2) Check if the direction of the diodes and the capacitors are right side.
- 3) Check if there is no shorting between primarily side and secondly side.
- 4) Check if the wires aren't touching the blade of fan-motor.
- 5) Check if thermistor is touched the heat sink.

Output Voltage adjustment

- 1) Turn on the test unit. Then check if turn on the power indicator and the meter back light.
- 2) Adjust the PR3 to the center position.
- 3) Adjust the PR6 at the no loading condition to output voltage become $13.8 \pm 0.05V$.

Meter Adjustment

- 1) Set the meter switch to "V" side.
- 2) Adjust the PR7 to the needle of the meter indicate 13.8V.

- 3) Set the meter switch to "A" side.
- 4) Load the 28A current by the loader machine.
- 5) Adjust the PR8 to the needle of the meter indicate 28A.

Output Voltage confirmation

- 1) Check if it's possible to adjust the voltage from $4.5 \pm 1.0V$ to $15.2 \pm 0.5V$ by PR3.
- 2) Adjust the PR3 to the center (13.8V), and load the current to 28A. Then check the below things.
 - 1) Check if out put voltage is $13.8 \pm 0.5V$.
 - 2) Check if the indication of the voltage meter is stable.
 - 3) Check if the voltage display in the oscilloscope is stable.
 - 4) Check if the output voltage is keeping stable by shock.
 - 5) Check if input current is less than 4A.

Over Current Protection adjustment

Over current protection

- 1) Adjust the PR1 to the end of counterclockwise side.
- 2) Load the 30.5A current by loader machine.
- 3) Adjust the PR1 clockwise to output voltage down around 0.3V.

Over heat protection

- 4) When heat thermistor by heat-gun at the above condition, check if output voltage decrease from above condition.
- 5) When heat R103 by heat-gun, check if fan motor is working.
- 6) Return normal condition.

Shortage protection

- 7) When short the output terminal between positive and negative, check if output voltage and current become around 0.
- 8) Check if turn on the protect indicator at the above condition.
- 9) Return to normal condition.

Other Terminal confirmation

- 1) When adjust the PR3 to the center, check if the cigar terminal voltage and push terminal voltage is $13.8 \pm 0.5V$.

Noise Offset Volume confirmation

- 1) Check if output voltage is stable when adjust PR3(noise offset side) from side to side.

Preset Function confirmation

- 1) Set the preset switch of S3 to ON side.
- 2) Check the below things at the above condition.
 - 1) Check if turn on the preset indicator.
 - 2) Check if it's possible to adjust output voltage from $5 \pm 1.5V$ to $15 \pm 1.5V$ by PR5.
 - 3) Check if cannot adjust output voltage by PR3.
- 3) After checking adjust the PR5 to 13.8V.

Isolation confirmation

Connect the test unit and the isolation machine like the picture.

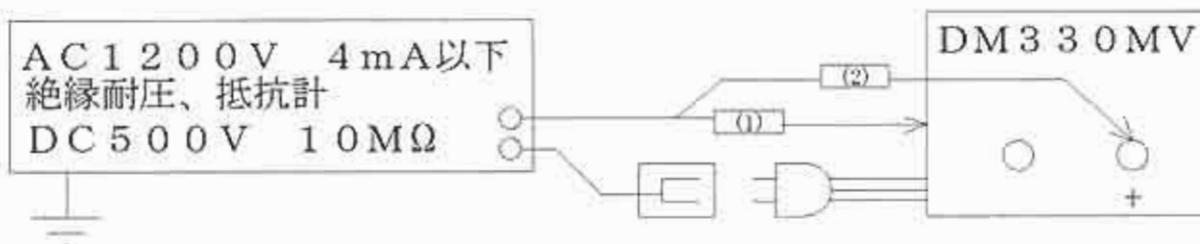

- (1) Connect to output terminal.
 - (2) Connect to body earth (heart sink).
- 1) Set the value of isolation machine like the below. Then check if pass the below specifications.

Setting

Voltage Isolation 絶縁耐圧計		Resistance Isolation 絶縁抵抗計	
Setting Voltage	AC 1200V	Setting Voltage	DC 500V
Current 漏洩電流	4mA	Resistance 抵抗	10MΩ
Time	1sec.	Time	1sec.

Shipment confirmation

- 1) Check if the power switch of S1 is "OFF" side.
- 2) Check if the preset switch of S3 is "OFF" side.
- 3) Check if the meter switch of S4 is "V" side.
- 4) Check if the voltage volume and noise offset volume of RP3 are setting center.
- 5) Check if the cigar socket is closed by cap.
- 6) Check if there are no abnormal things like scratch or defect on the outside appearance.

Specification

Input Voltage	230VAC 50/60Hz (200 ~ 240VAC Variable) 100VAC 50/60Hz (80 ~ 140VAC Variable)
Output	13.8V (5 ~ 15VDC Variable)
Circuit System	Half Bridge System
Output Voltage Regulation	Less than 2%
Protection	Short-circuit, Automatic current limiting 31A, Over-temperature
Output Current	30A(max), 25A(continuous)
Ripple	Less than 15mVp·p at rated load
Fuse	4A
Meter	Single Volt / Current Meter, Back-light
Switching Frequency	25KHz (20 ~ 30KHz Variable)
Function	Noise Offset Function, Preset Function
Dimensions	190(W) × 69(H) × 181(D)mm (The volume and the terminal are not included.)
Weight	Approx. 2.3Kg

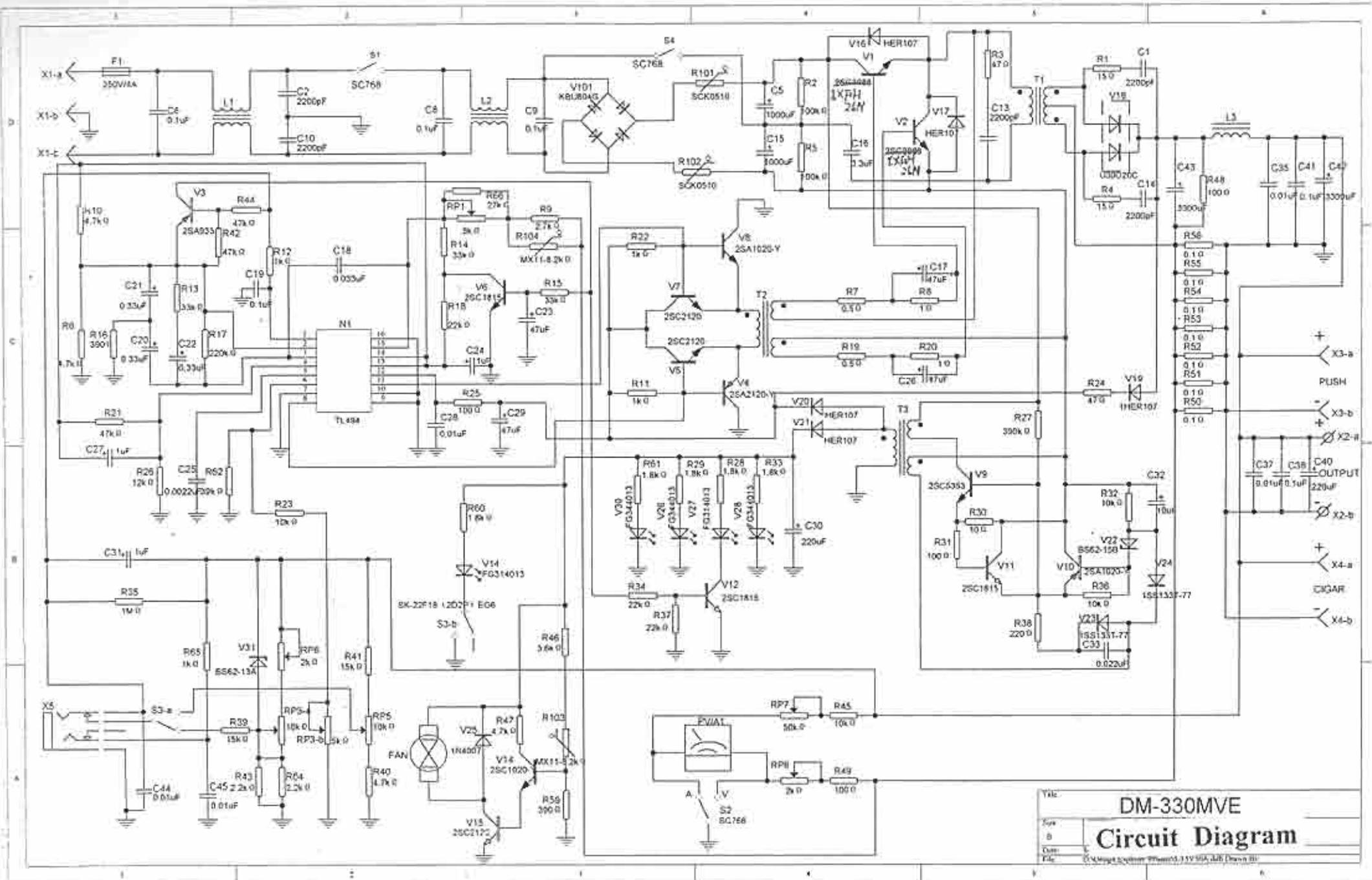

Title: **DM-330MVE**
 Type: _____
 Date: _____
 File: _____
Circuit Diagram
© Magma Systems, Phoenix, AZ 85004, All Rights Reserved

DM-330MVE

ITEM	PART NO.	DESCRIPTION	QTY	LOCATION
33		Resistor RJ13-1/6-39k Ω	1	R62
34		Resistor RJ13-1/6-47k Ω	3	R21、R42、R44
35		Resistor RJ13-1/6-220k Ω	1	R17
36		Resistor RJ13-1/6-390k Ω	1	R27
37		Resistor RJ13-1/6-1M Ω	1	R35
38		Resistor RJ14-F-0.25-22 Ω	2	R80、R81
39		Resistor RJ20-2-0.1 Ω	7	R52、R53、R54、R55、R56、R57、R58
40		Resistor RJ20-2-15 Ω	2	R1、R4
41		Resistor RJ20-2-47 Ω	2	R3、R24
42		Resistor RJ20-2-120k Ω	2	R2、R5
43		Resistor RX27-1-5-100 Ω	1	R48
44		Thermistor SCK0510	2	R101、R102
45		Thermistor MX11-8.2k Ω	1	R103
46		Thermistor MF52E103G338	1	R104
47		Poter WIB06-1-10k Ω	1	RP5
48		Poter WH112-2A-200 Ω	1	RP8
49		Poter WH112-2A-2k Ω	1	RP6
50		Poter WH112-2A-5k Ω	1	RP1
51		Poter WH112A-2A-50k Ω	1	RP7
52		Poter RDP12D-20-25F-018-6003D (同轴)	1	RP3
53		Capacitor CBB22-250V-3.3 μ F	1	C16
54		Capacitor CC1-1-b-D-63-1000pF	1	C19
55		Capacitor CD11-25-4700 μ F 16 \times 32	2	C42、C43
56		Capacitor CD11-200V-1000 μ F	1	C15
57		Capacitor CL21X-63-2200pF	1	C25
58		Capacitor CL21X-63-0.022 μ F	1	C33
59		Capacitor CL21X-63-0.033 μ F	1	C18
60		Capacitor CT1-63-0.1 μ F	2	C28、C41
61		Capacitor CT1-06-63-0.01 μ F	3	C35、C44、C45
62		Capacitor CT4-63-0.33 μ F	1	C22
63		Capacitor LT-200-1000 μ F ST 35X35	1	C5
64		Capacitor PY222M-400-2200pF	5	C1、C2、C10、C13、C14

DM-330MVE

ITEM	PART NO.	DESCRIPTION	QTY	LOCATION
65		Capacitor MPX-275V-0.22 μ F 18 \times 15 \times 8	1	C6
66		Capacitor MPX-275V-0.22 μ F 26 \times 7 \times 17	2	C8、C9
67		Capacitor TK-35-10 μ F	1	C32
68		Capacitor TK-35-47 μ F	2	C23、C29
69		Capacitor TK-35-220 μ F	1	C30
70		Capacitor TK-50-1 μ F	3	C24、C27、C31
71		Switch SC768 三脚	2	S1、S2
72		Switch SK-22F18-EG7	1	S3
73		Switch KND-4 MR-11 (768) UL Black	1	S5
74		Fuse BGXP-4A-20mm(UL)	1	F1
75		Socket ST-35061	1	X1
76	AQF4.704.7683	Transformer	1	T1
77	AQF4.704.7684	Transformer	1	T2
78	AQF4.704.7685	Transformer	1	T3
79	AQF4.773.771	Inductor	1	L3
80	AQF4.773.772	Inductor	1	L2
81	AQF4.773.773	Inductor	1	L1
82		4-pin clip KJ4-3	1	
83		Clip STV2	1	
84		Post 999E Red	1	
85		Post 999E Black	1	
86		P1244010HSIN fan	1	
87		DPB55-2 650 μ A/680n Yellow-panel meter	1	
88		Smoking socket made of metal	1	
89		Socket DZS single inline	1	
90		Plug TJC3B-2T	1	
91		Connection terminal OT4-4	4	
92		Fuse holder LS-PTF-35 (VDE)	1	
93		Oblate sectional 2-wire cord	1	
94		Screw BT3 \times 8	21	
95	GB818-85	Screw M2 \times 16 Black	2	
96	GB818-85	Screw M3 \times 8 Black	1	

DM-330MVE

ITEM	PART NO.	DESCRIPTION	QTY	LOCATION
97	GB818-85	Screw M3×12 Black	3	
98	GB818-85	Screw M3×16 Black	4	
99	GB6170-86	Nut M2	2	
100	GB93-87	Washer 3	8	
101	GB848-85	Washer 3-140HV Black	8	
102	GB862.1-87	Washer 4	4	
103				
104				
105				
106				
107				
108				
109				
110				
111				
112				
113				
114				
115				
116				
117				
118				
119				
120				
121				
122				
123				
124				
125				
126				
127				
128				

AQF2.932.7373WX

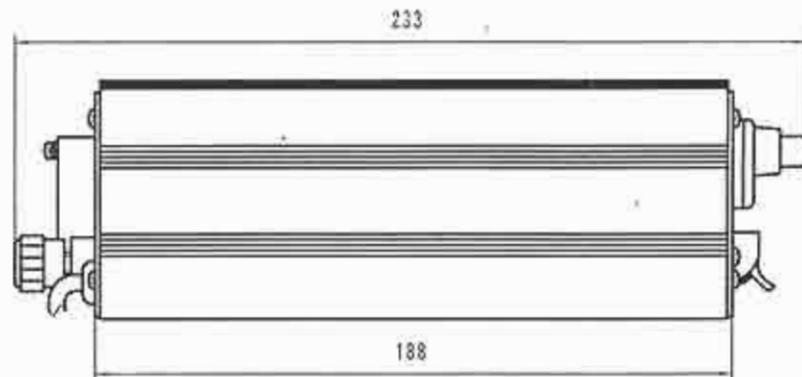
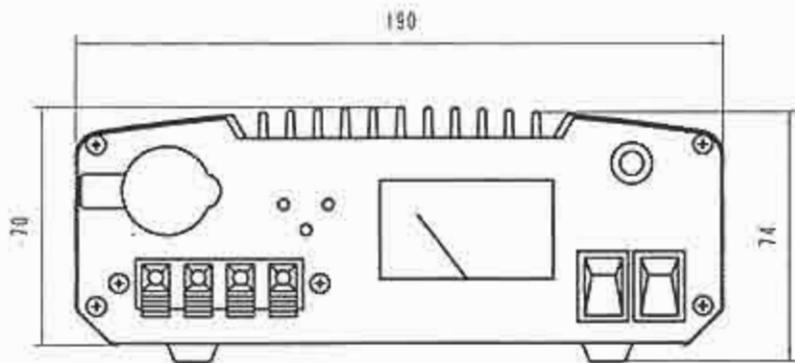

媒体编号

底图总号

底图总号

3号 签名

未注公差尺寸按GB1804-m

鍍涂

DF1794-1S30
外型图

Outline

AQF2.932.7373WX

单	位	图	号	重	量	比	例
						1:	1.5

第	1	号	共	1	号
---	---	---	---	---	---

数量	更改单号	姓名	日期
设计			
审核			
工艺			
新增			
删除			

插图-成图表

插图

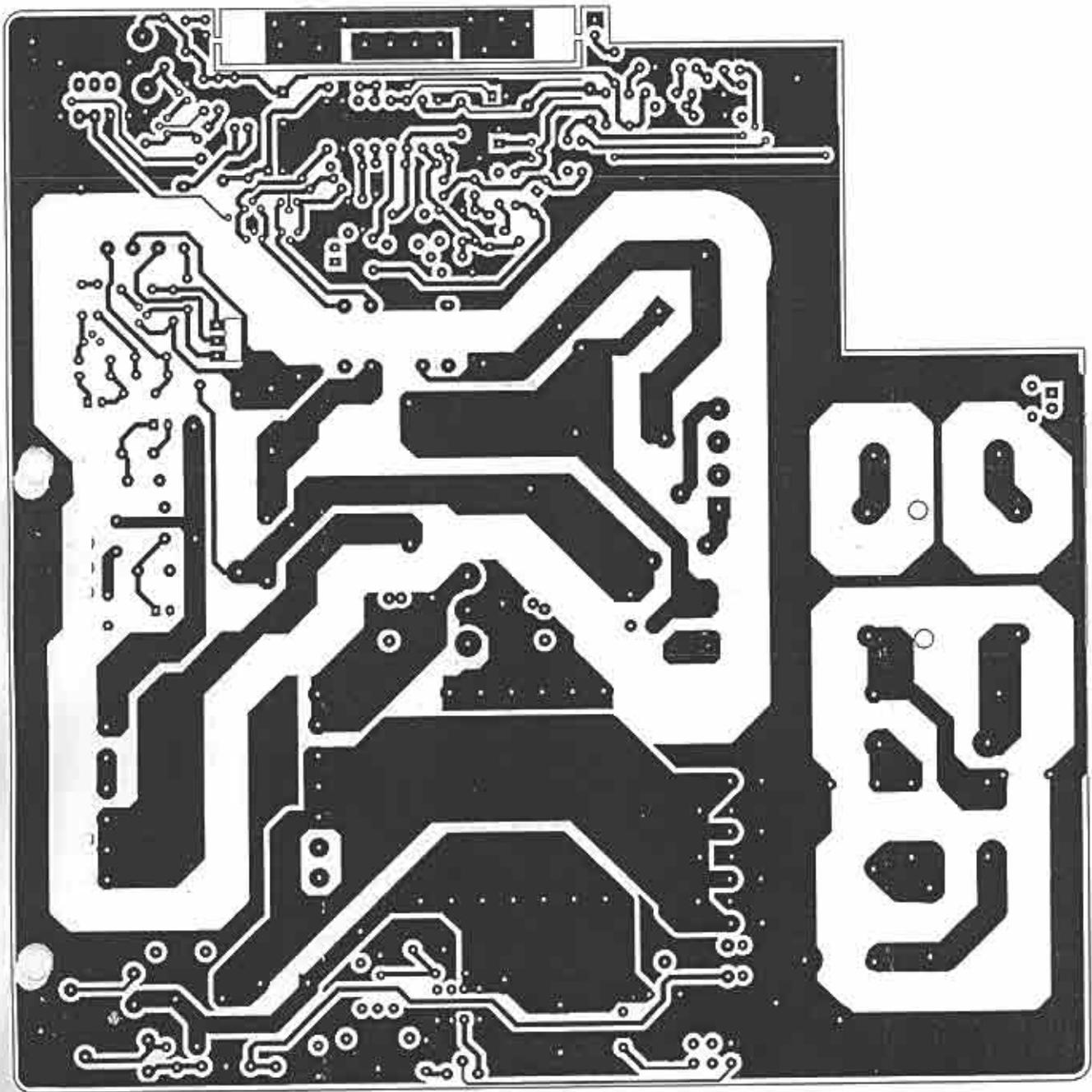

PCB

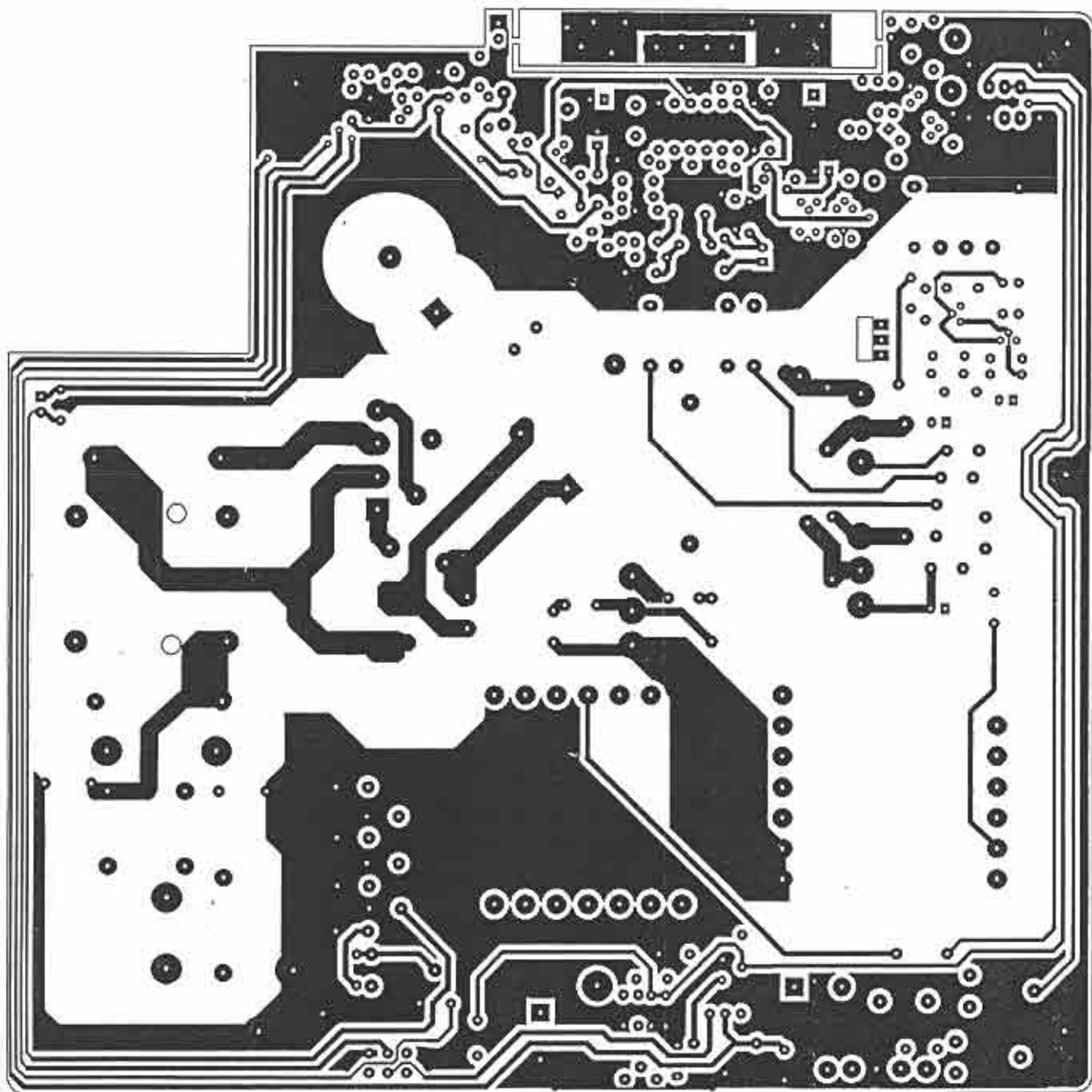

PCB

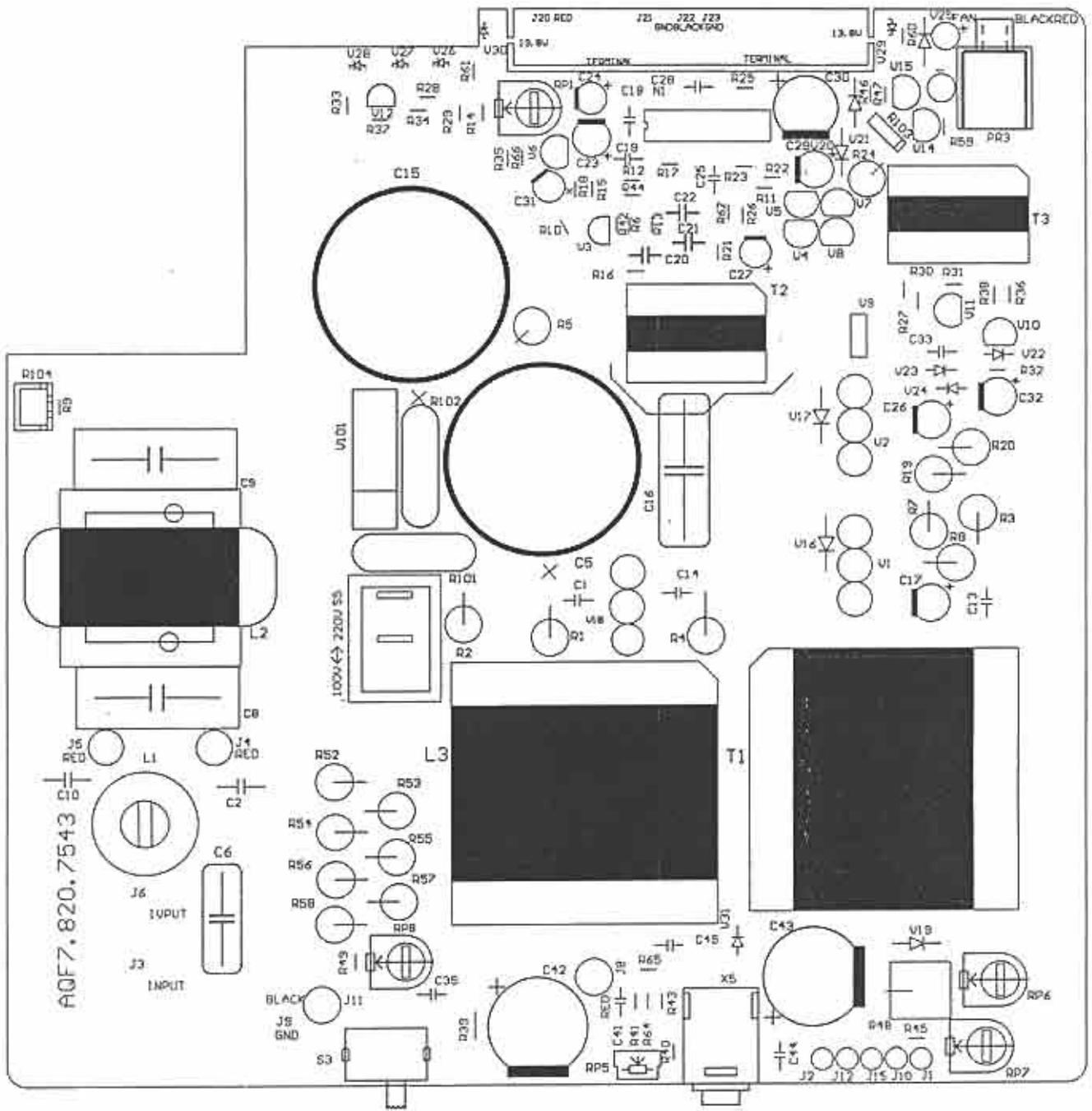

INTRODUCTION

Alinco's **DM-330MVE** is a high efficiency, compact, lightweight, high performance switching mode power supply. It is also engineered to minimize the switching noise specifically for communication use. Even when noise occurs, it may be eliminated with the Noise-Offset function. Also convenient functions like pre-set voltage, remote control and a highly visible back lit meter are standard in this power supply.

CAUTION

1. Even though the chassis of the unit is negatively grounded, use the correct terminals to connect cable.
2. When plugging the unit into a wall outlet, it must be turned off.
3. Place the unit in a dry and well-ventilated area.
4. Never touch the unit while in use. Even though it is designed for high efficiency, the unit will still get hot. If the unit reaches a certain temperature, the "extreme temperature protection" function will protect the unit by automatically dropping the current down to a safe level and the protection indicator will light up.
5. A current limiting system will protect the unit from overloading.
6. If a short circuit occurs at the output, the unit is protected by a short circuit protection function. Immediately turn off the unit and repair the cause of the short circuit, then turn it back on.
7. Do not use the unit for devices that require high current input at the start, such as motorized equipment. Do not use the unit to charge a car battery.
8. Do not use a car cigarette lighter in the cigarette plug socket on the unit.
9. Before replacing a fuse make sure the unit is turned off. Be sure to use the specified type of fuse.
10. Make sure the product is always suitably grounded to prevent electric shock and to reduce noise. (The unit can be grounded by connecting a grounding cable to the appropriate screw)
11. Never disassemble, modify, or touch the inside of the unit unnecessarily. This could cause damage to the product and will void the warranty.

PRESET FUNCTION

When this function is activated, a preset voltage will be supplied regardless of the current voltage setting. To store the preset voltage, turn the switch to the preset position and adjust the preset voltage to the desired output level. When this function is selected the voltage adjustment control on the front panel will be deactivated to protect from over voltage.

SPECIFICATIONS

Input voltage:	230VAC
Output voltage:	5-15VDC variable
Output voltage regulation:	less than 2%
Protection:	short-circuit, Automatic current limiting over 30A over-temperature
Output current:	30A (max), 25A (continuous)
Ripple:	less than 15mVp-p at rated load
Fuse:	4A
Meter:	single volt / current meter, back-lit
Dimensions:	190(W) × 69(H) × 181(D)mm (Projections not included)
Weight:	approx. 2.3kg

PART NAMES AND FUNCTIONS

Front View

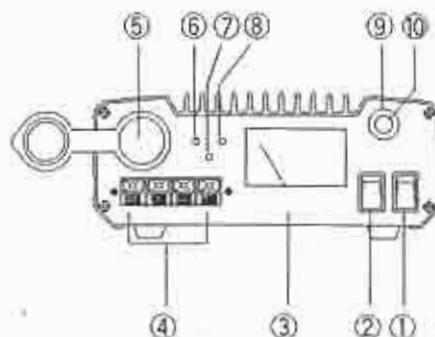

Rear View

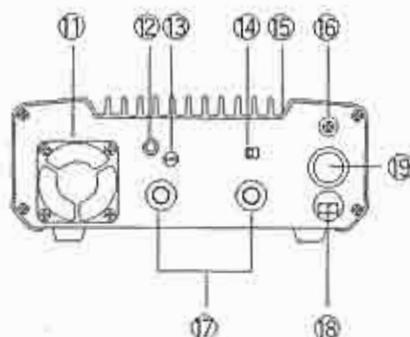

- ① Power switch: Turns the unit on and off.
- ② Meter switch: Select the position to indicate voltage (V) or current (A).
- ③ Meter: Displays the voltage or current.
- ④ Snap in output terminal: 5A max. Red positive, black negative.
- ⑤ Cigarette plug terminal: 10A max.
- ⑥ Preset indicator: Lights up when preset function is activated.
- ⑦ Protection indicator: Lights up as a warning when the current limiting system is activated.
- ⑧ Power indicator: Lights up when the unit is turned on.
- ⑨ Voltage adjustment: Adjusts voltage between 5.0 and 15.0 volts. Turn clockwise to increase and counter clockwise to decrease the voltage. When it is set at the center position it will supply 13.8 volts.
- ⑩ Noise off-set volume control: Adjust to eliminate the pulse noise of the switching circuit. This patent pending function is specially designed for communication use. (It's effectiveness may vary depending on the frequency and mode.)
- ⑪ Cooling fan: The fan turns on and off automatically.
- ⑫ Remote control terminal: By connecting a remote controller, the output voltage can be remote controlled. *Note: When the remote control is connected to the unit, the unit must be turned off. When the remote control is being used the voltage adjustment knob and preset function will be deactivated.
- ⑬ Preset volume: see ⑬
- ⑭ Preset switch: To store the preset voltage, turn this switch to the preset position and adjust the preset volume to the desired output level.
- ⑮ Heat sink: Do not touch the surface when the unit is in use. Let the unit cool down completely before touching it.
- ⑯ Grounding screw: Used to connect the Earth grounding cable to the unit.
- ⑰ Output terminal: 30A max. Red positive, black negative.
- ⑱ Power cable: 230VAC
- ⑲ Fuse: 4A