

Transverter HG 70-K

INTERNAL TRANSVERTER'S FOR 70 MHZ FOR ELECRAFT K3



The transverter **HG 70-K** (70 Mhz) has designed for internal use on Elecraft K3, using the 28 Mhz like IF ..

In reception mode, the amplifier has a low noise factor, <1 db and the IP3 >+29 dbm.

No need external power supply and no need tuned.

The installation of the transverter HG 70-K into the Elecraft K3 ,is very easy and fast.Only you need solder 3 wires , connect 2 coaxial wires and install connector for 70 MHZ Antenna Mhz.You need 30 minutes of work.The transverters is fully assembled and ajusted..

As option can be installed precision crystal heater with temperature $40.8\text{ }^{\circ}\text{C} \pm 1.5\text{ }^{\circ}\text{C}$ in 42 Mhz Oscillator.**This transverters is designed only for Elecraft K3.** For other transceiver,please ask me.

REQUIREMENTS OF ELECRAFT K3:

K3 WITH INTERFACE TRANSVERTER KXV3A...The KXV3 is not valid.

NO INTERNAL TRANSVERTER INSTALED LIKE K144XV.

IF YOU HAVE INSTALLED THE K144XV TRANSVERTER YOU CAN NOT INSTALL THE HG70-K TRANSVERTER.

ELECRAFT K3, KXV3, KXV3A,KRX3 and K144XV is a registered trademark of Elecraft ,Inc.

Transverter HG 70-K

Specifications:

Installation : Internal (Inside ELECRAFT K3)

Full QSK

Measures : 73mmX73mmX30 mm

Supply Voltage: 12 VDC (Get of ELECRAFT K3 internally)

Current Drain :

Received : 100 mA...130 With the precision crystal heater

Transmit: <3 A

Frequency Range:70,000-72,000 MHZ...Optimized 69,800 to 70,400 Mhz

TRANSMITTER

Power output (50 Ohm load) : About 8W at 1.1:1 SWR on Bird 43

Operatinf modes : SBB,FM,CW,Digital,etc

IF range :28,000-30,000 Mhz

TX RF Mixer Mini Circuits ADEX-10H (+17dbm)

IF input powe range :1mW

Full QSK

RECEIVER

Noise Figure : <1 dB

Conversion gain :Typical

RX RF Mixer Mini Circuits ADEX-10H(+17dbm)

3rd-Order Intercept :>+29 dbm

OPTIONAL : Precision Crystal Heater for 42 Mhz

REQUIREMENTS OF ELECRAFT K3:

K3 WITH INTERFACE TRANSVERTER KXV3A...The KXV3 is not valid.

NO INTERNAL TRANSVERTER INSTALLED LIKE K144XV.

IF YOU HAVE INSTALLED THE K144XV TRANSVERTER YOU CAN NOT INSTALL THE HG70-K TRANSVERTER.

ELECRAFT K3, KXV3, KXV3A,KRX3 and K144XV is a registered trademark of Elecraft ,Inc.



VERY IMPORTANT

REQUIREMENTS OF ELECRAFT K3:

K3 WITH INTERFACE TRANSVERTER KXV3A...The KXV3 is not valid.****

NO INTERNAL TRANSVERTER INSTALLED LIKE K144XV.

IF YOU HAVE INSTALLED THE K144XV TRANSVERTER YOU CAN NOT INSTALL THE HG70-K TRANSVERTER.

PLEASE :

Preventing Electrostatic Discharge Damage see your K3 Manual.

NOTICE

I do not take responsibility of any damages that you produce in your transceiver for the installation of this transverter .

ELECRAFT K3, KXV3, KXV3A,KRX3 and K144XV is a registered trademark of Elecraft ,Inc.

Transverter HG 70-K

INSTALLATION OF TRANSVERTER INSIDE ELECRAF K3

The installation of transverter inside of Elecraft K3 is easy. Only need solder 3 wires for power supply and control, connect to coaxial wire in KXV3A and install antenna connector in rear part of K3.

FIRST :

Disconnect power and all cables from your K3.

SECOND :

Remove the forward section of K3's bottom cover. See next picture.

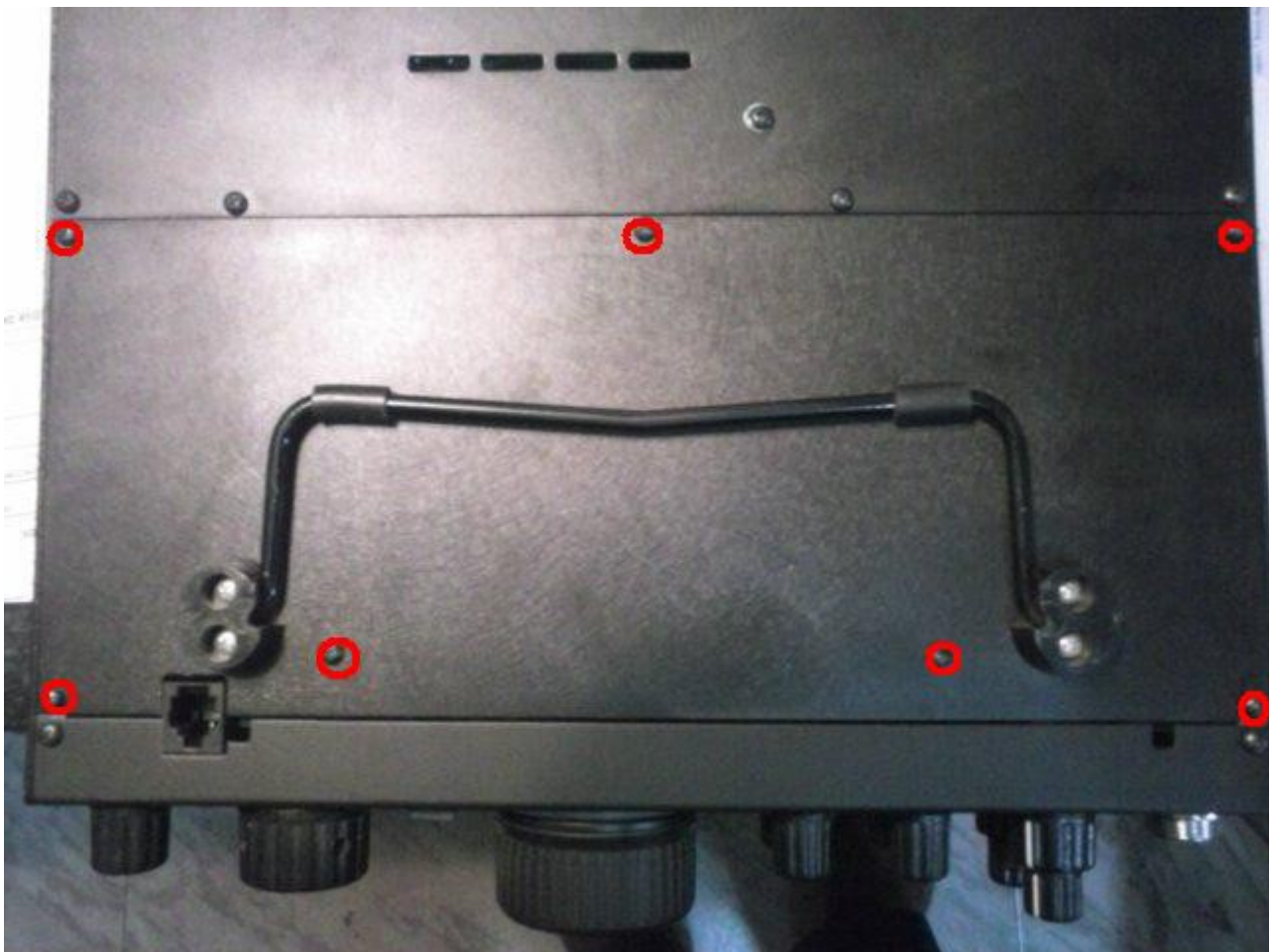

Transverter HG 70-K

THIRD :

Remove the 9 screws of top cover. See next picture.

After the cover is free of 9 screws, lift it gently to reach the speaker wire connector.

Unplug the speaker connector's.

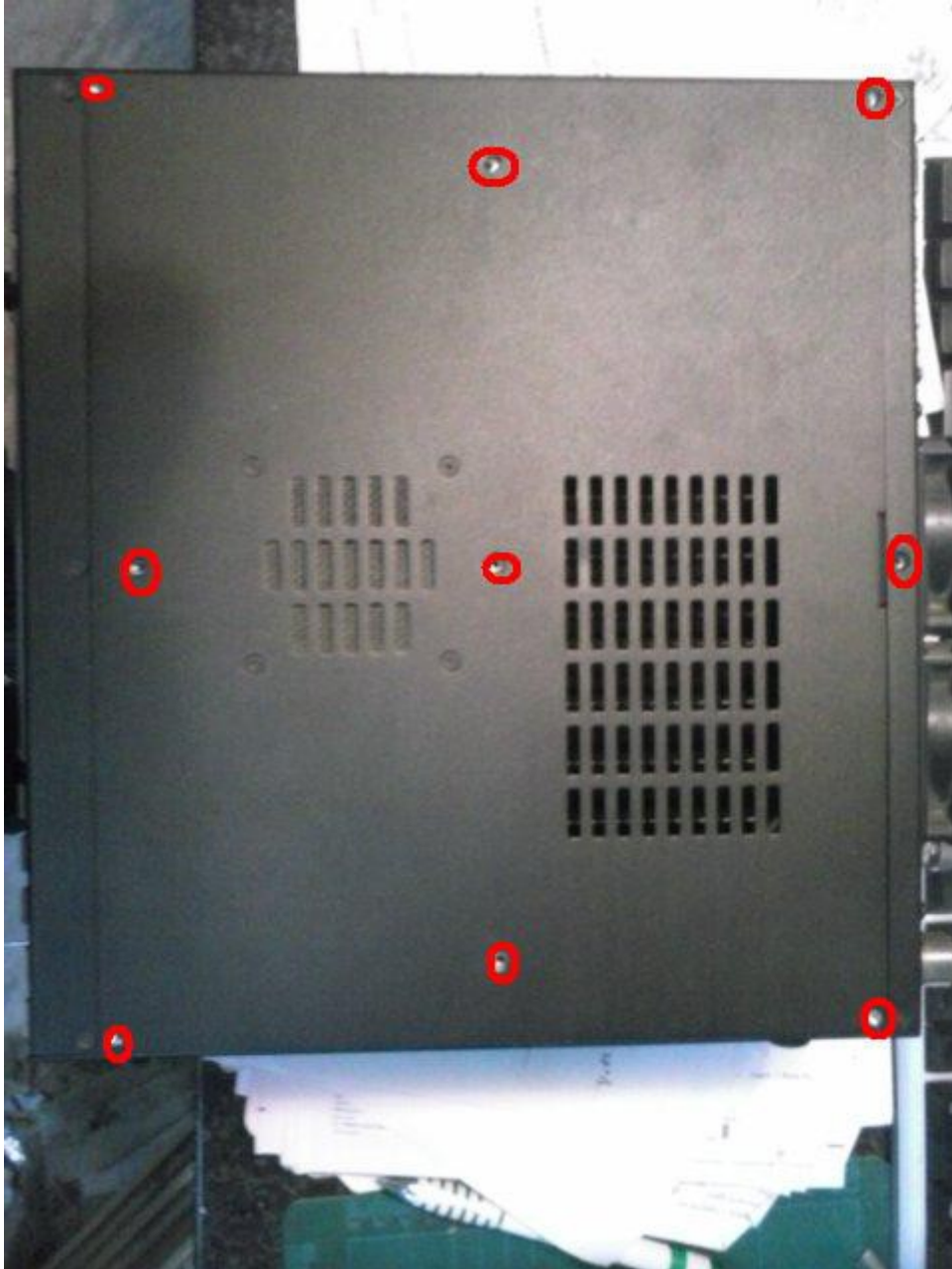

Transverter HG 70-K

FOURTH :

If you have installed the KRX3 (SUB receiver), please your manual to remove this.
Locate this part in your K3 in the next picture. (red square)

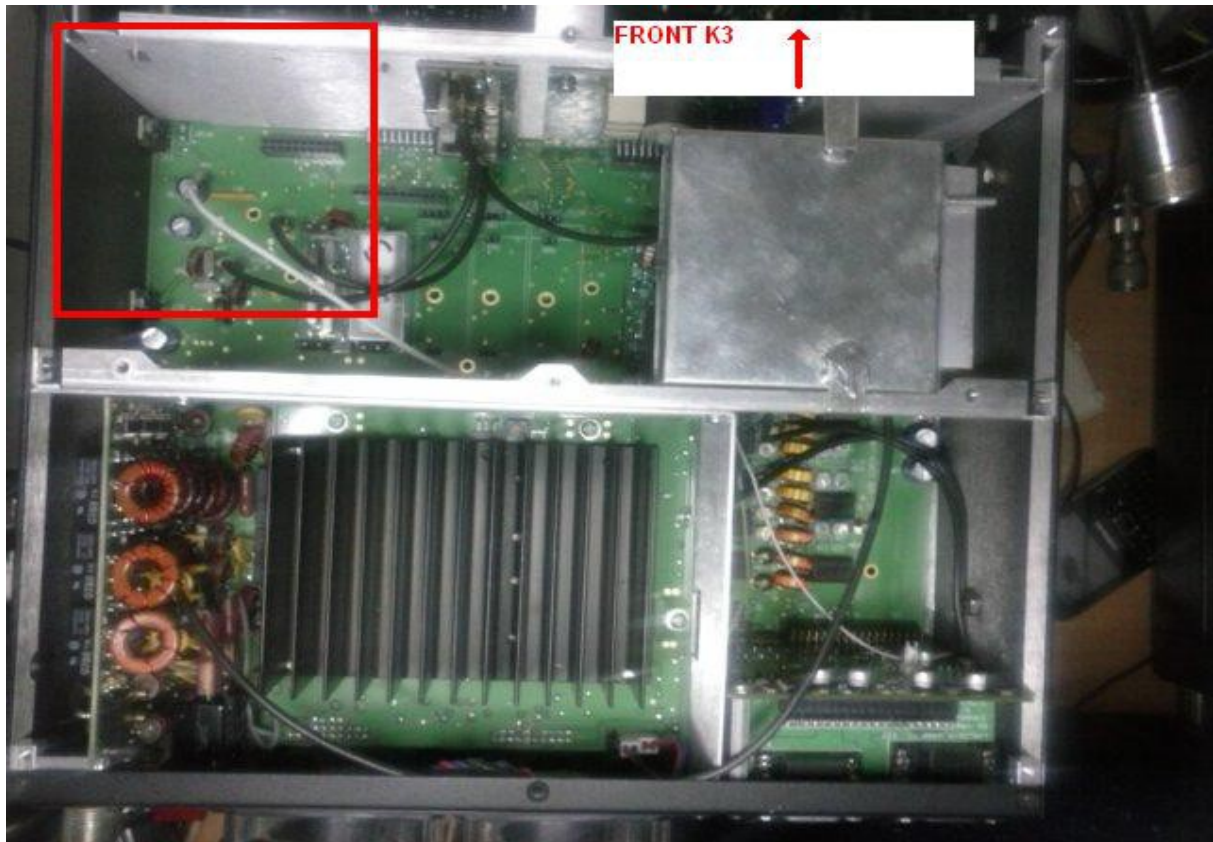

Locate the next picture in right side panel of your k3

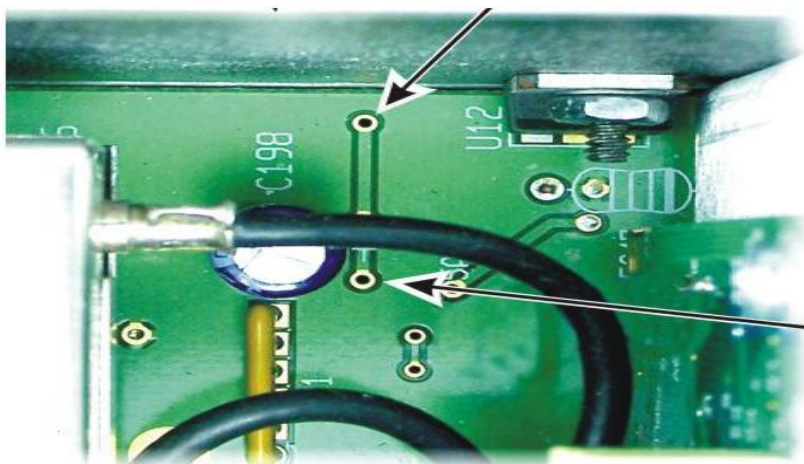

ARROW.....PIN INSTALLATION

Transverter HG 70-K

Get the pin to solder in one of the two positions marked by arrows in the previous picture and solder the pin carefully by the bottom .

Pin picture :



When you have soldered the pin , put the forward section bottom cover and put the 7 screws . In some K3 this pin is installed from factory. See next picture. Later in this pin solder the red wire from the transverter HG70K on top part of K3.

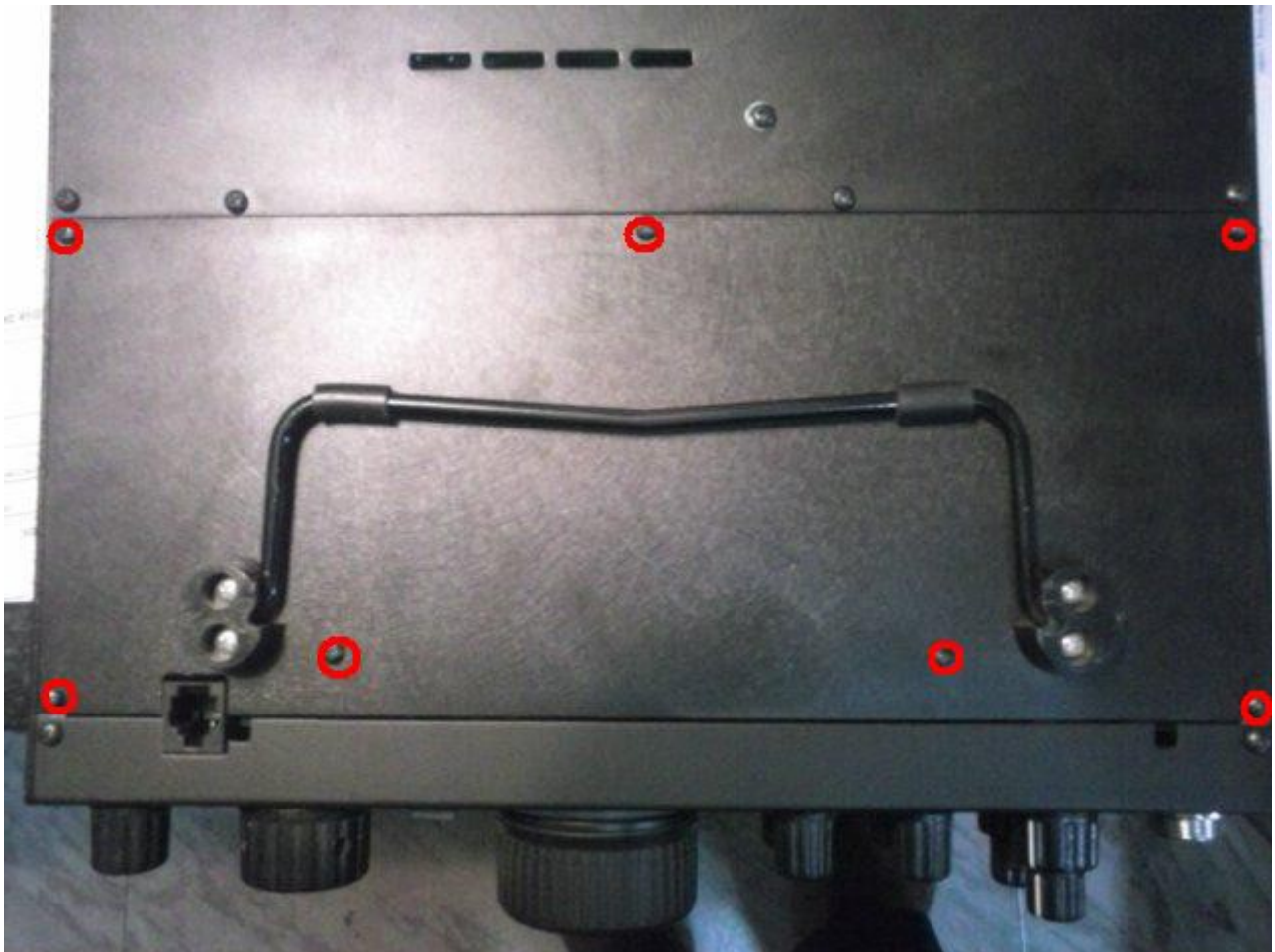

Transverter HG 70-K

FIFTH :

Remove the 7 screws of lateral .See picture.



Transverter HG 70-K

SIXTH :

Remove the screws like next picture and remove KIO3 Board.



KPA3 AMPLIFIER MODULE AND SHIELD (IF INSTALLED)

KRX3 AUX ANTENNA CABLE (IF USED)

KRX3 RF MODULE (IF INSTALLED)

2 REMOVE THE UPPER STANDOFF, SCREW AND LOCK WASHER.

3 LIFT THE KIO3 MAIN BOARD UP, UNPLUGGING IT FROM THE MAIN RF BOARD. TILT AS NEEDED FOR THE REMOTE AUDIO MODULE AND LOWER STANDOFF TO CLEAR THE REAR PANEL.

1 PRESS ON THE BACKS OF J24 AND J23 TO UNPLUG THE KIO3 REMOTE I/O MODULE AND REMOVE IT THROUGH THE REAR OPENING. SUPPORT THE RIGHT CORNER OF THE KIO3 BOARD TO AVOID BENDING IT.

Transverter HG 70-K

Now, we have the KVV3A board ready to solder 2 wires from the transverter HG70K. The yellow wire of the transverter HG70K must be soldered on the pin 7 of the P66 connector. Pin 1 is on the left of P66. See picture.



Transverter HG 70-K

The white or gray wire of the transverter HG70K must be soldered on the pin of relay near OUT RF connector .Soldering pin is the first from the left .See picture

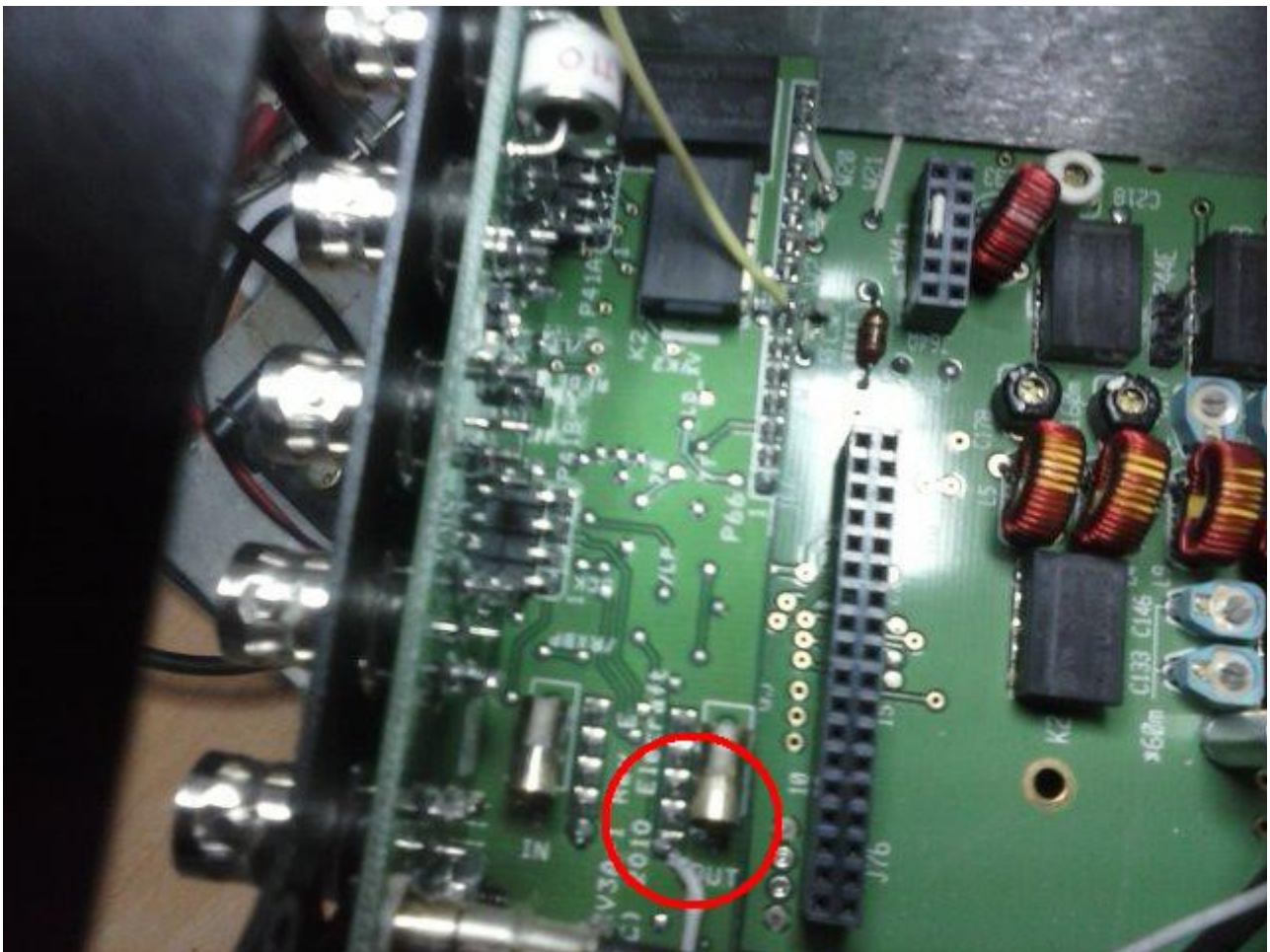

Transverter HG 70-K

Now we reassembling the KIO3 board. Once mounted we connect the 2 coaxial cables on KXV3A female connector.

The coaxial cables are black but one of them has a red ring.

The all black coaxial cable must be connected to the female connector marked IN in KXV3A board. The coaxial cable with the red ring must be connected to the female connector marked OUT in KXV3A. Install them carefully.

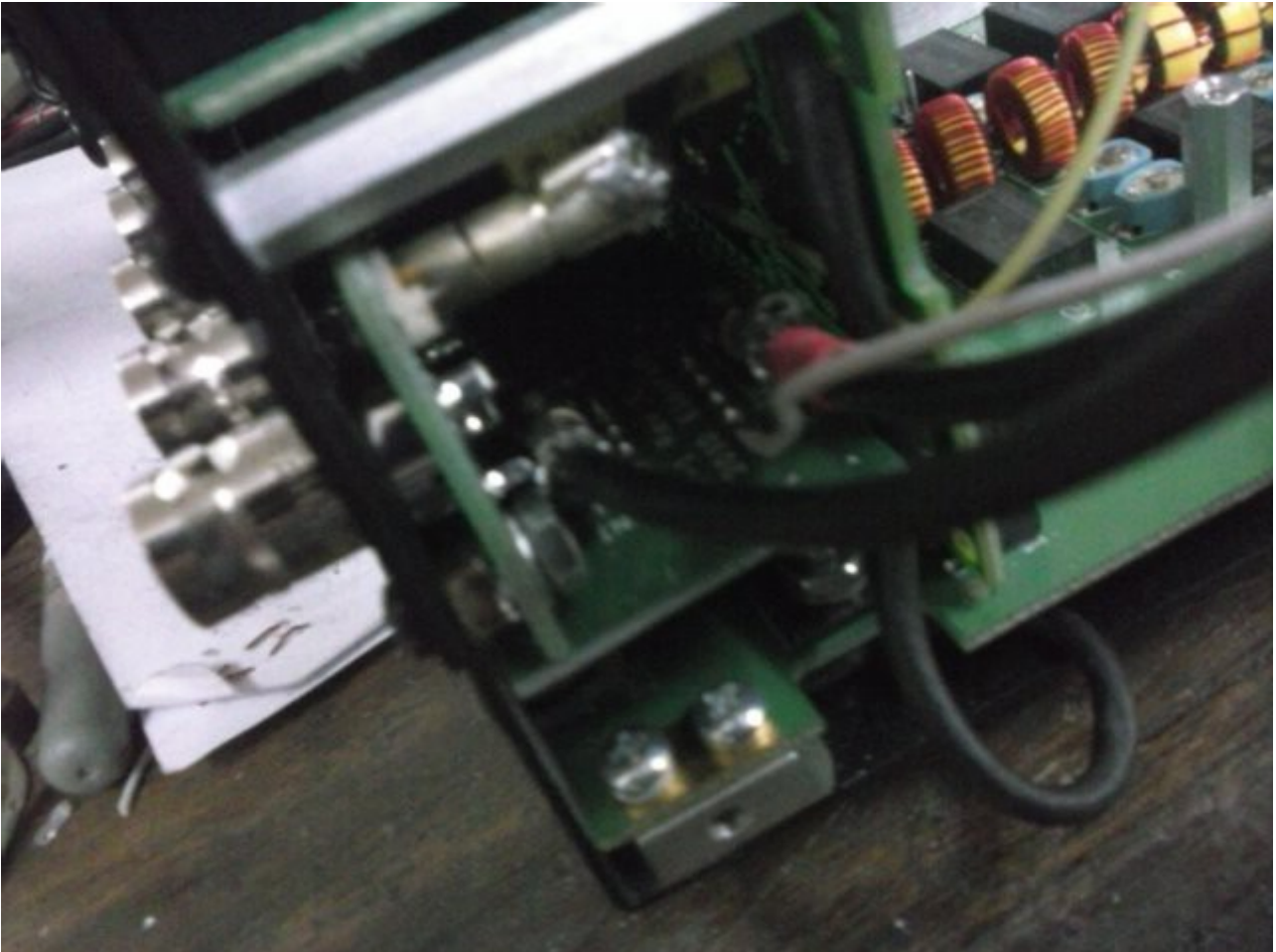

Transverter HG 70-K

Place the transverter HG70K in the bracket as shown in the image

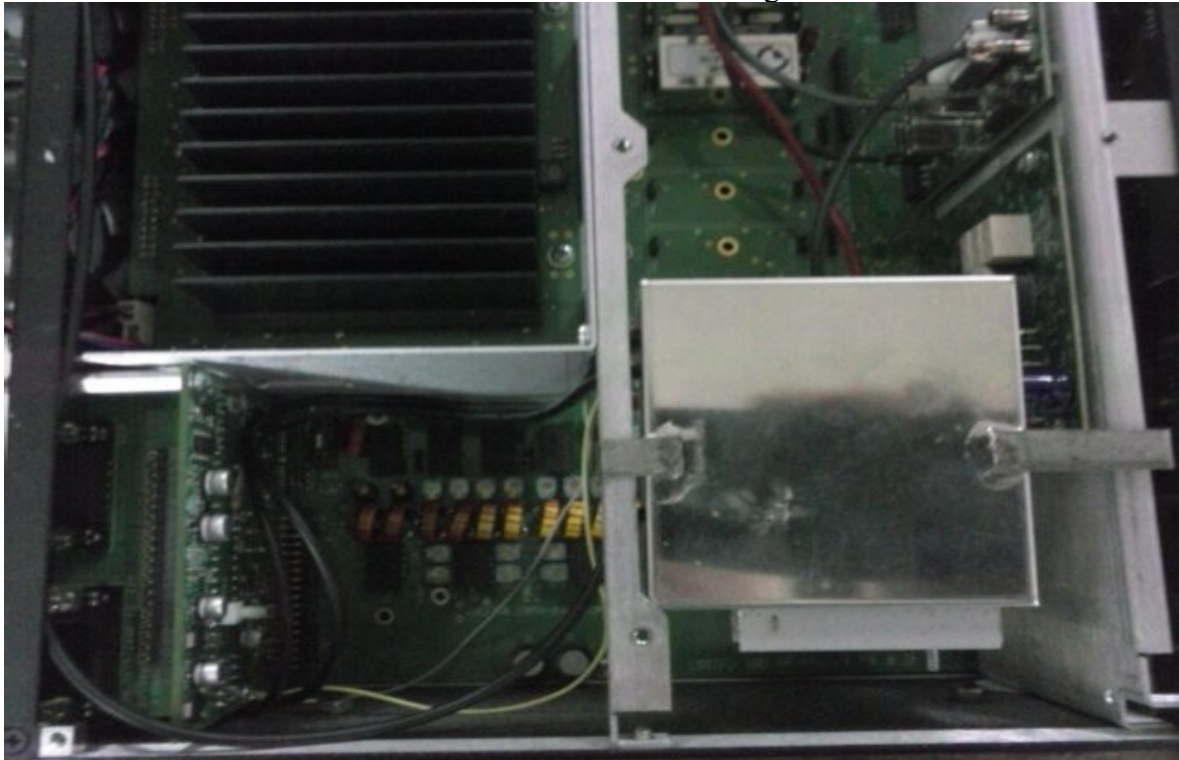

Mount the lateral panel with the 7 screws and beware with all cables from KXV3A.



Transverter HG 70-K

Now, solder the red wire of transverter HG70K on pin solder above in fourth step.Near of U12 and C198 on board.After this,if you have the KRX3 Sub receiver,please reassembling it.

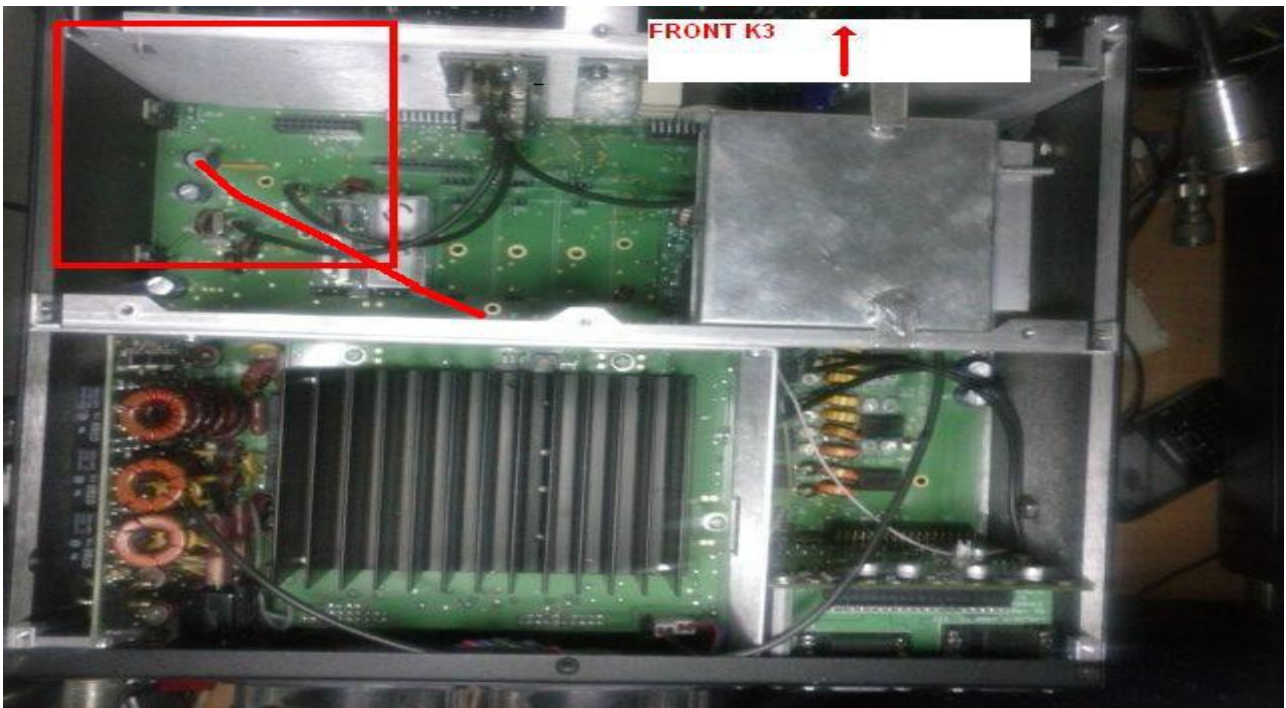

Transverter HG70K installed with the KRX3 Sub receiver.



Transverter HG 70-K

IF YOU HAVE A NEW K3 WITH THE HOLE CONNECTOR FOR 144MHZ.USE THE BNC OF THE TRANSVERTER WITHOUT HOLES TO INSTALL.

IF YOU HAVE A OLD K3 WITHOUT HOLE CONNECTOR FOR 144MHZ.USE BNC WITH 4 HOLE OF THE TRANSVERTERS.

Remove the 4 screws of Fan panel and remove it.Disconnect the wires of fan carefully.

Install BNC Female Connector for 70 Mhz Antenna at the rear of K3.

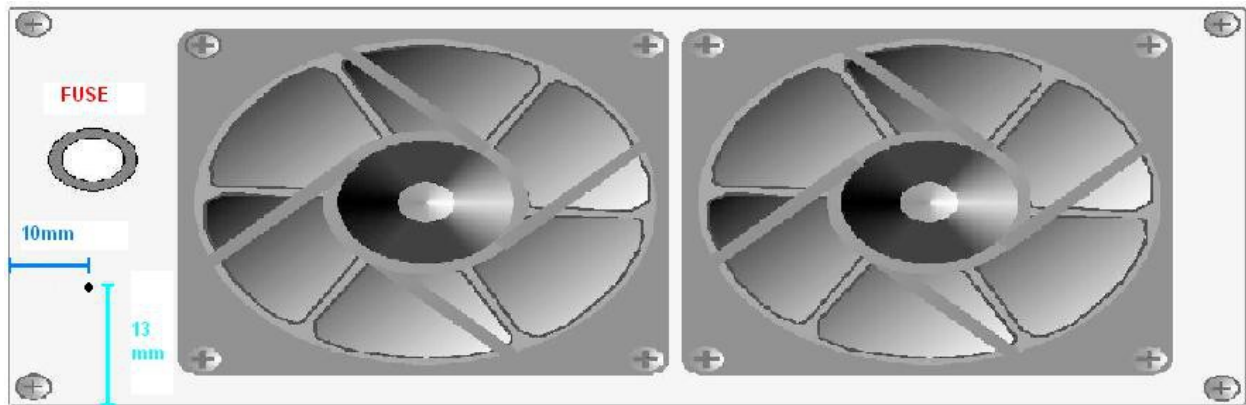

Make a hole of 11mm of diameter in fan panel K3.See you the distances.After 2 hole of 3mm for screws of connector.

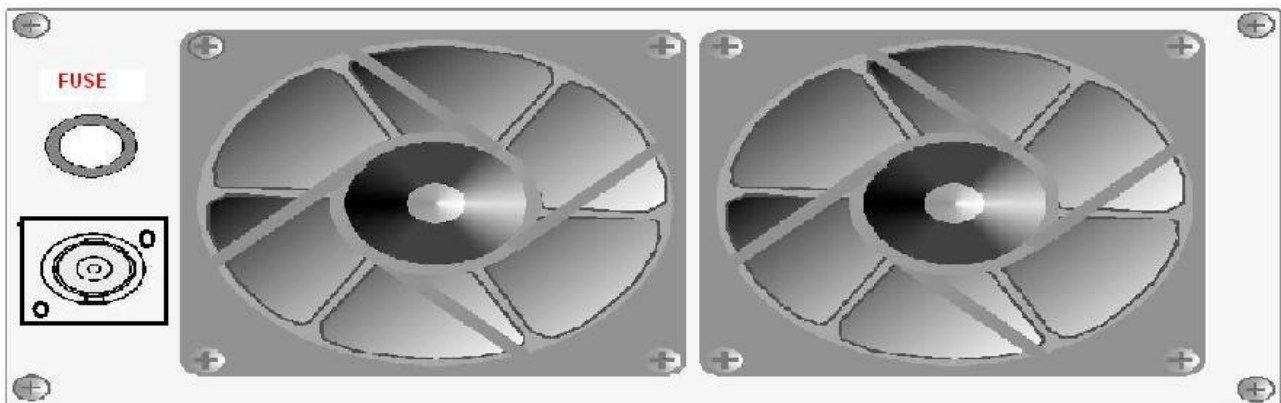

Scrape the paint in hole of 3mm in rear part of fan panel for better contact and screws the BNC female connector.

Transverter HG 70-K

Scrape the paint in hole of 3mm in rear part of fan panel for better contact and screws the BNC female connector.

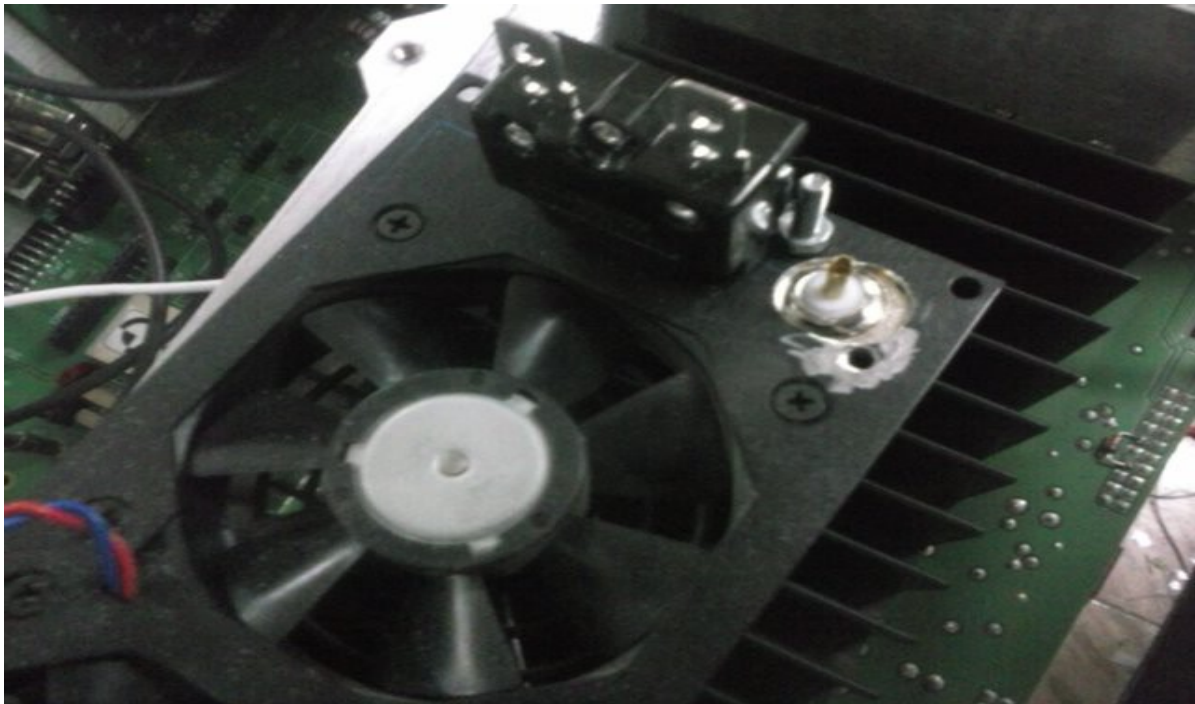

And solder de coaxial cable on BNC Female connector for 70 Mhz Antenna

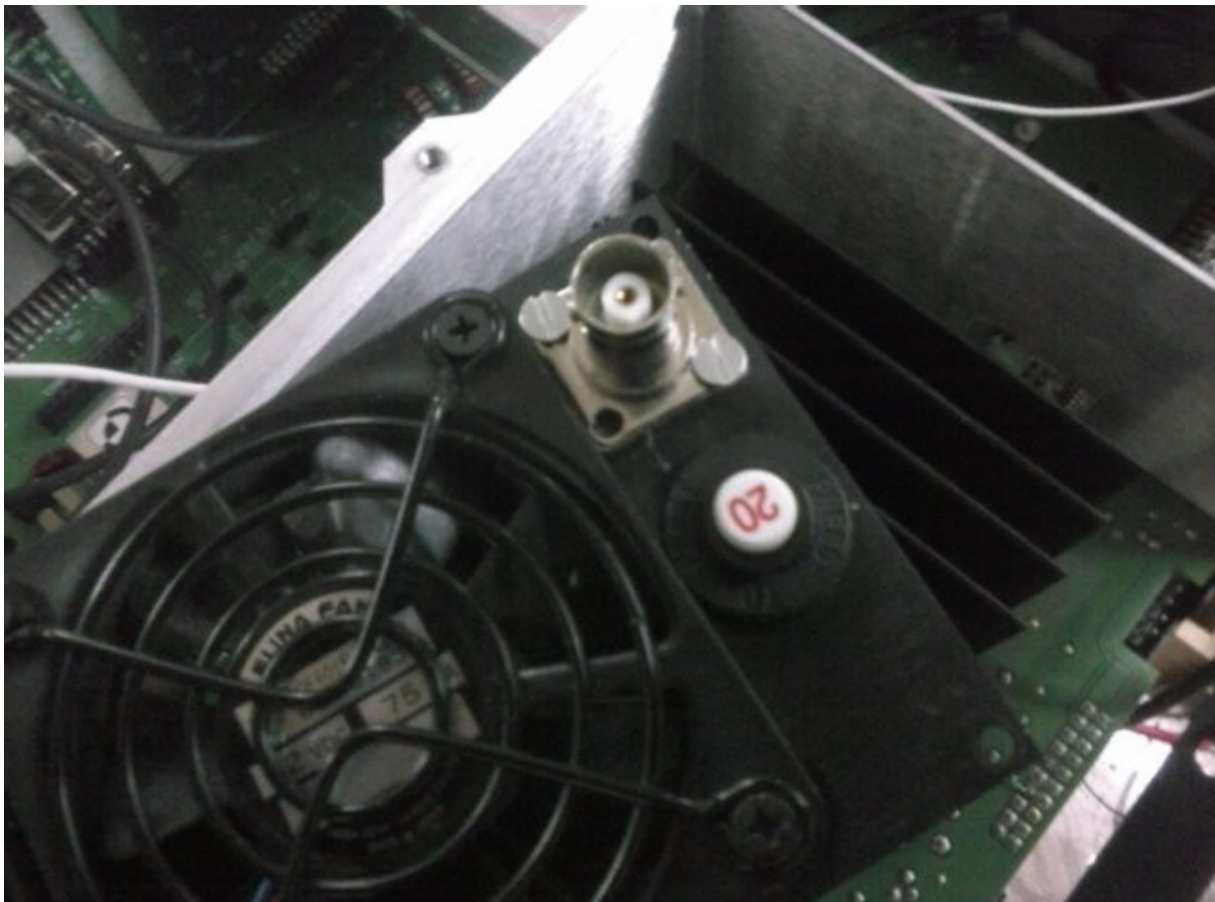

Transverter HG 70-K

Now connect the fan wires and fuse wire and reassembling the fan panel.



Transverter HG 70-K

IF YOU HAVE A NEW K3 WITH THE HOLE CONNECTOR FOR 144MHZ AND HOLES TO INSTALL THE SCREWS TRANSVERTERS 144MHZ OF ELECRAFT, PLEASE CHANGE OF METAL HOOK OF TRANSVERTER BY OF FIGURE.

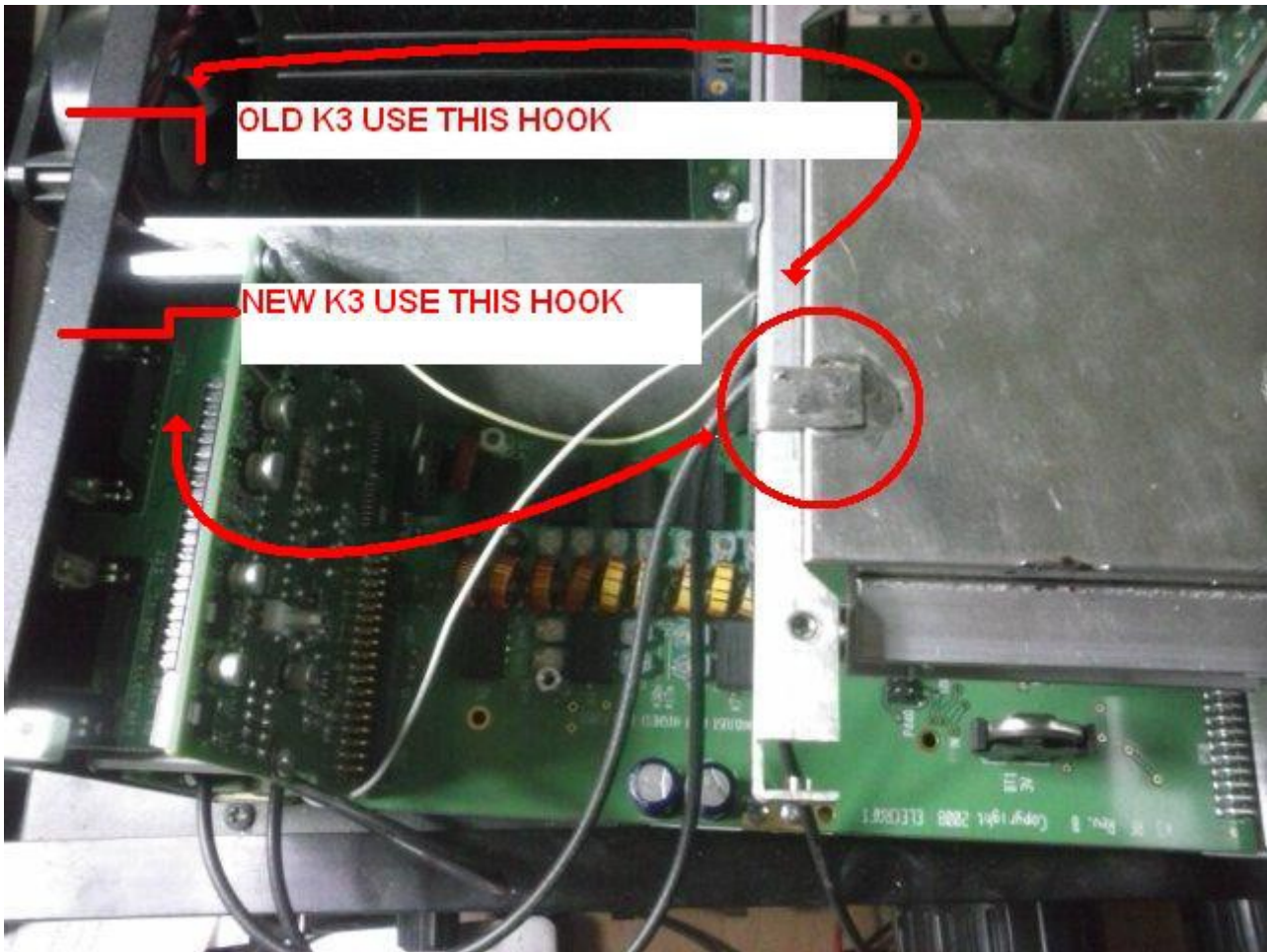

Transverter HG 70-K

Check all installation one more time.

Pass the speaker wire below the transverter HG70K and connect it on KIO3 board and close and screws the top cover. Your transverter is installed.

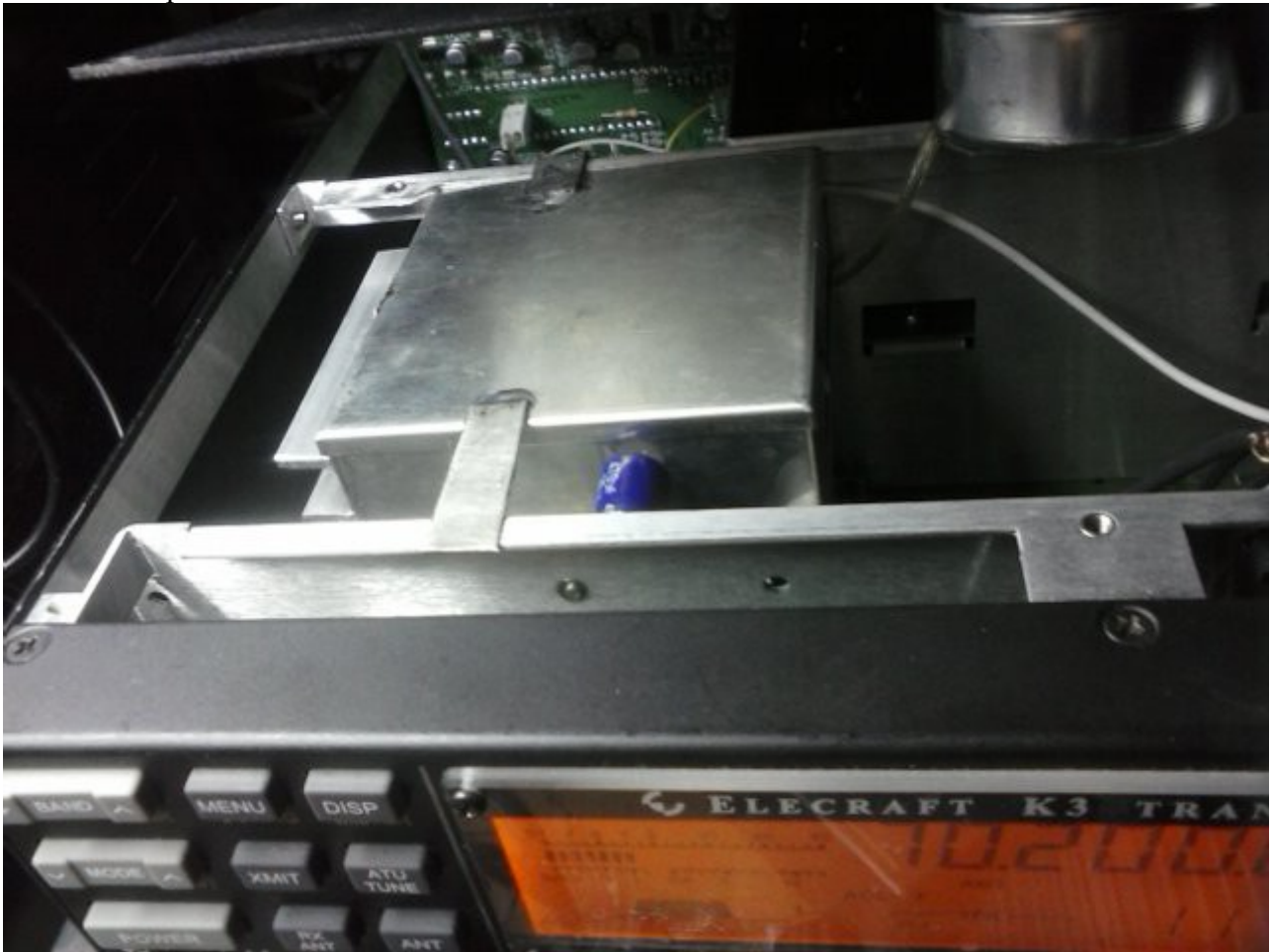

Transverter HG 70-K

K3 SETUP FOR HG70-K TRANSVERTER

MENU :

XV1 ON YES
XV1 RF 70
XV1 IF 28
XV1 PWR..... L 1.00
XV1 OFS 0.00
XV1 ADR..... Int. Trn0

When you select by band button and change for transverter you have 70 Mhz and the transverter is power on.If you change of band for example at 50 Mhz the transverter is power off.
CONNECT YOUR ANTENNA AND ENJOY ON 70 MHZ.

Transverter HG 70-K

Some measures in spectrum analyser: NOT SIMULATION... REAL MEASURES
42 Mhz oscillator out Span 0 to 1GHZ

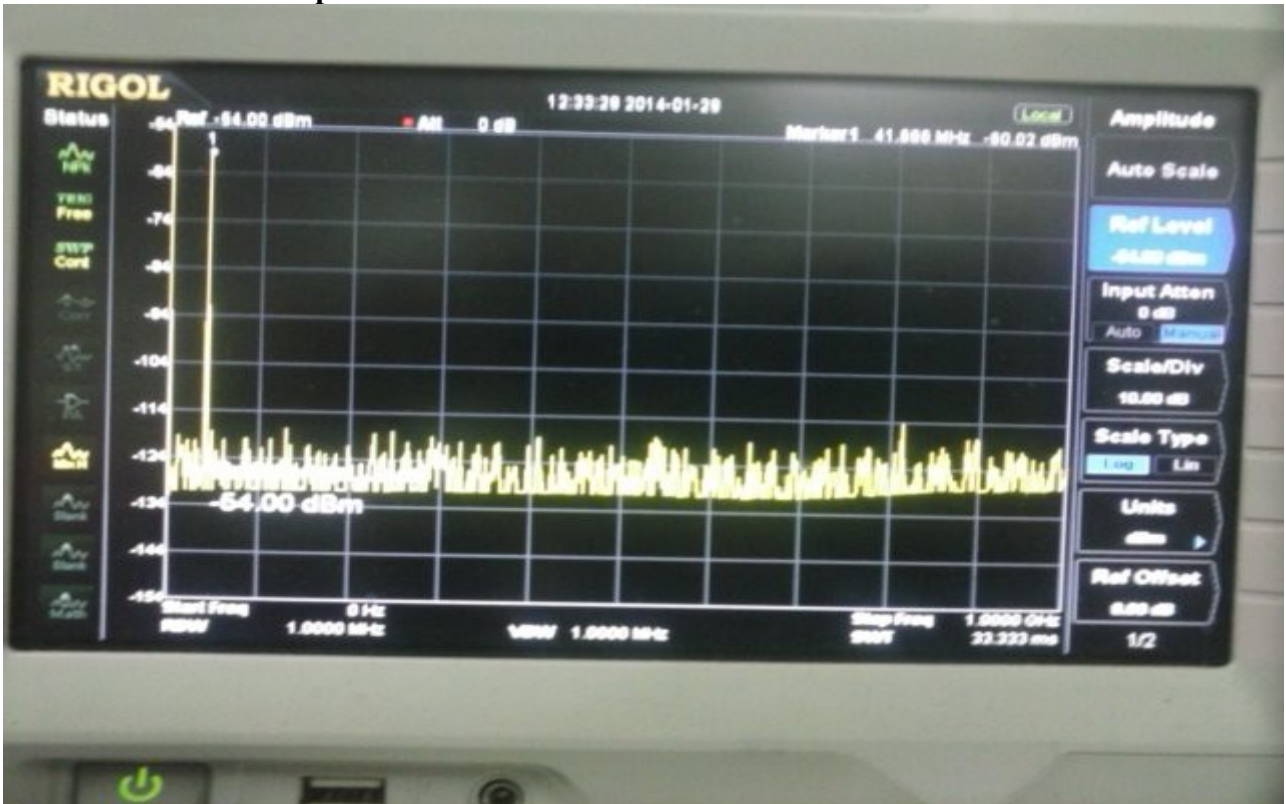

70 Mhz output transverter Span 0 to 1 GHZ

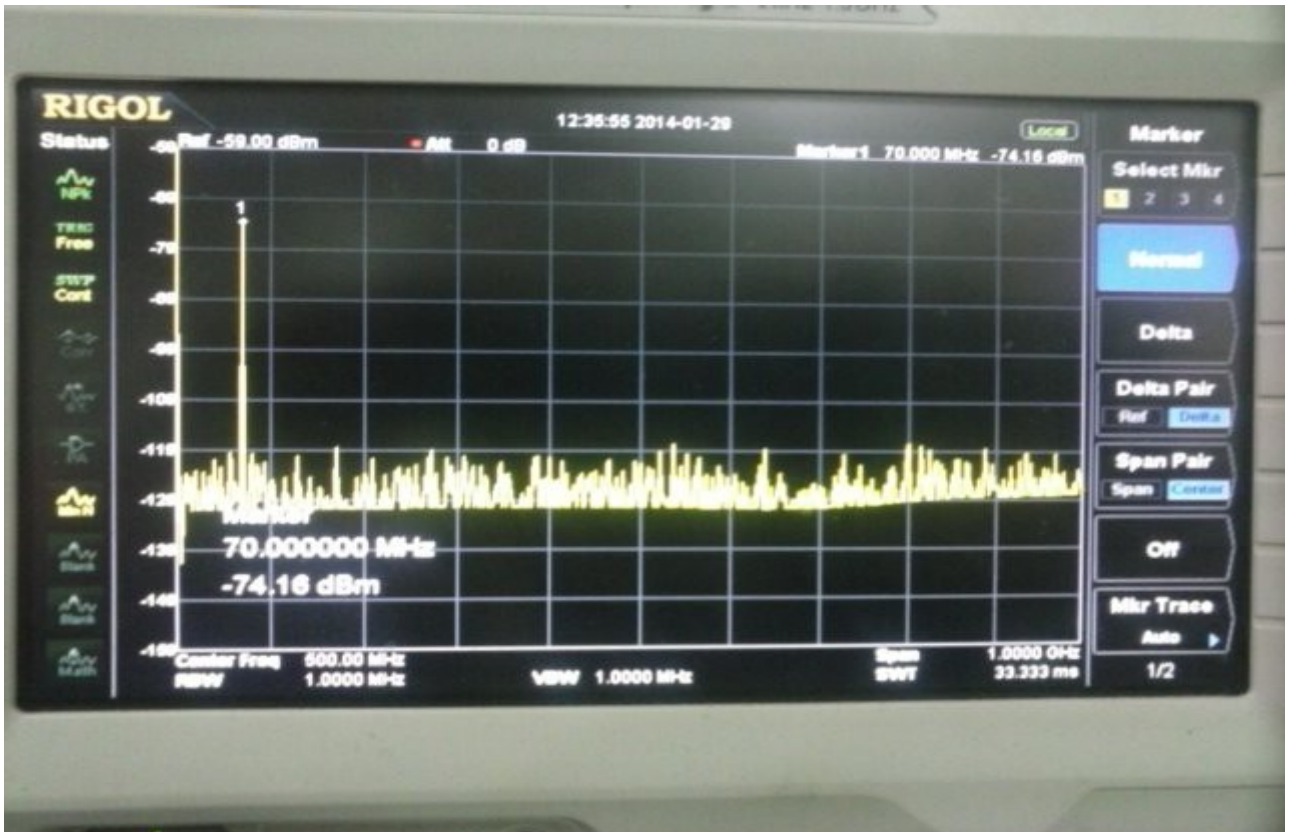

Transverter HG 70-K

LPF 70 MHZ

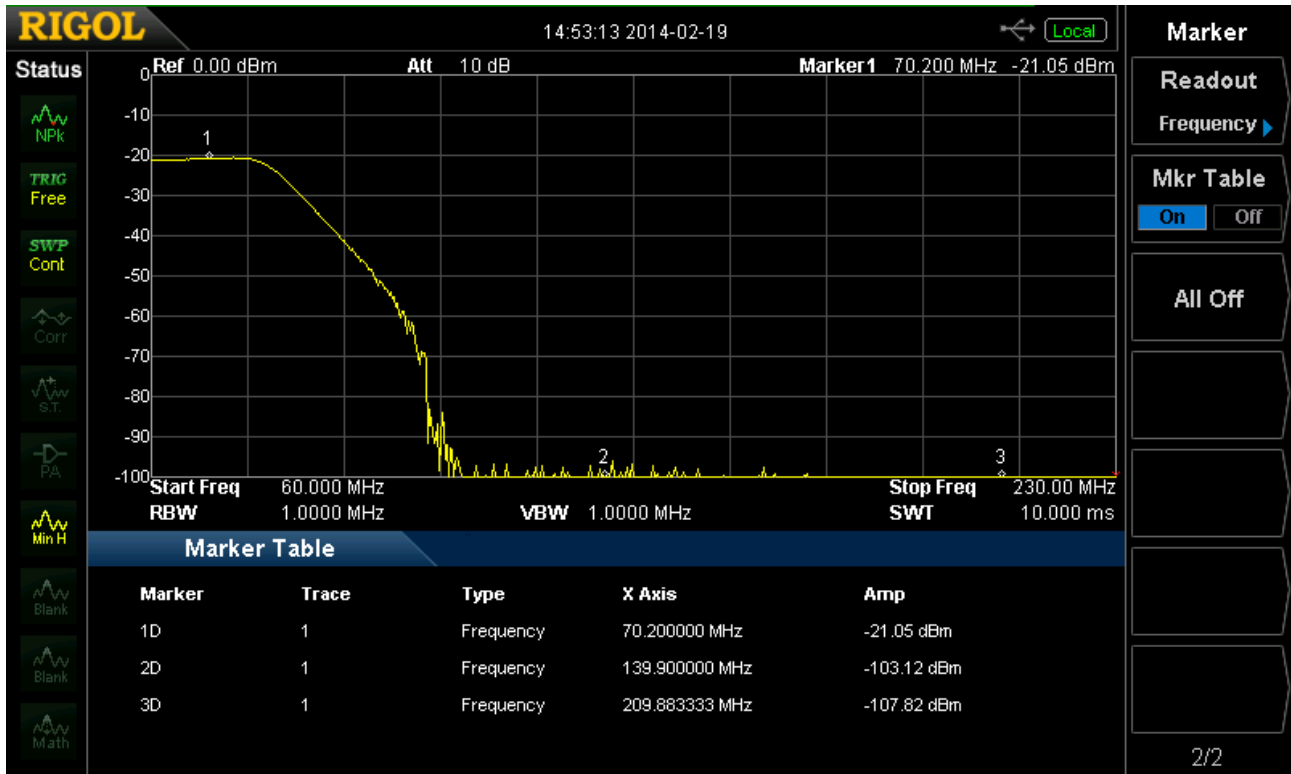

LPF 42 MHZ

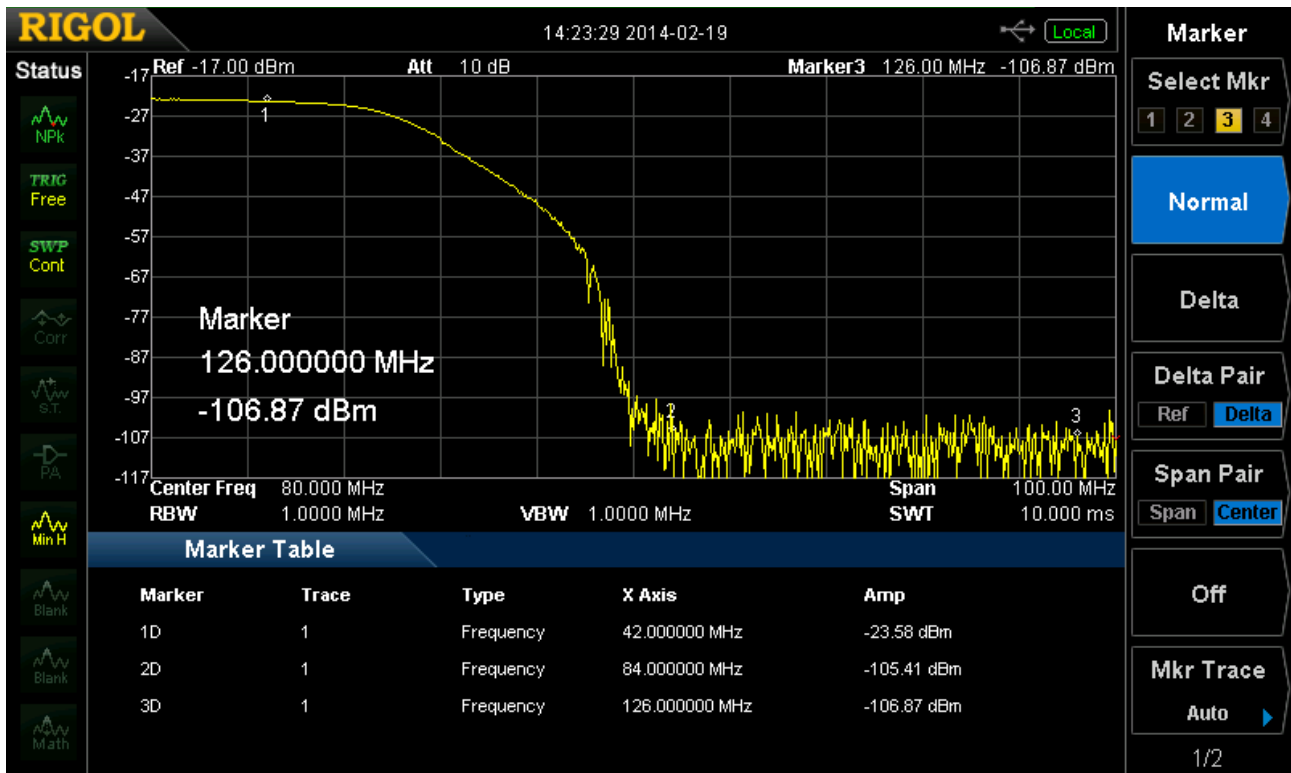

Transverter HG 70-K

BPF 70 MHZ

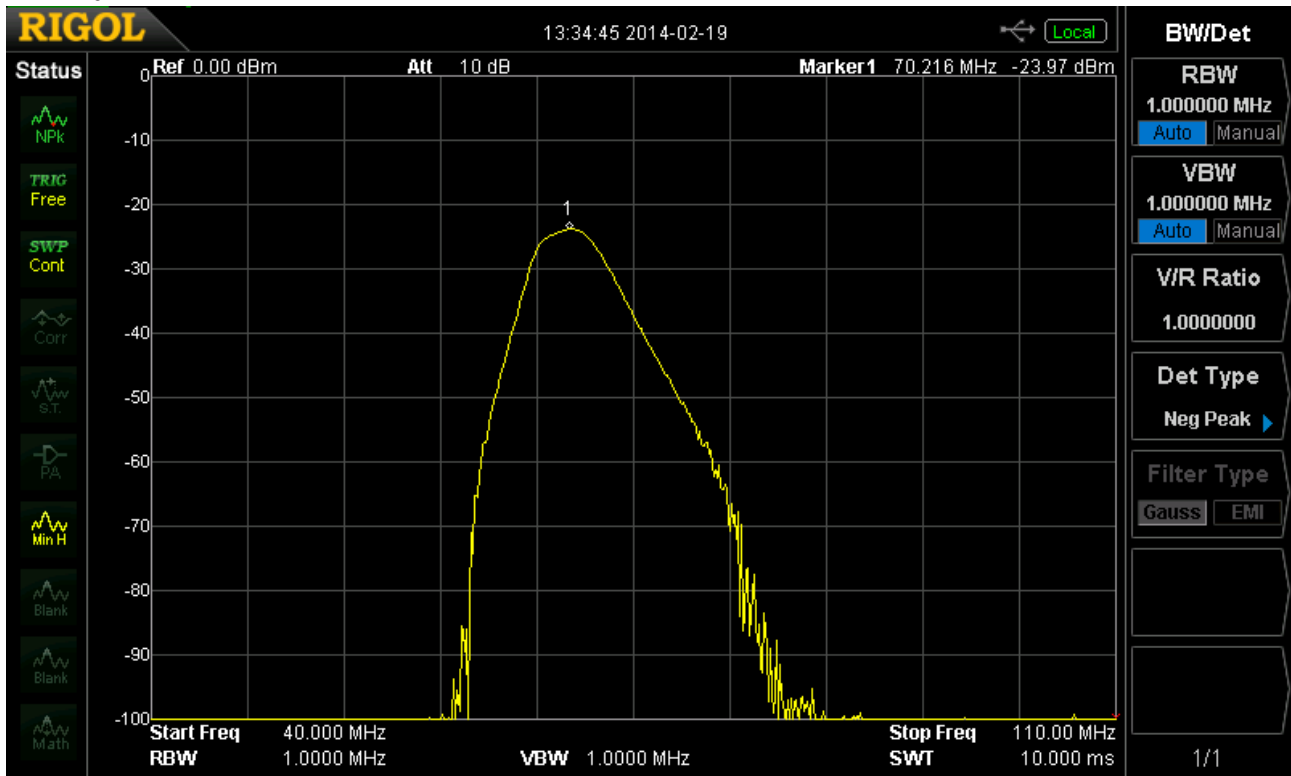

BPF 28 MHZ

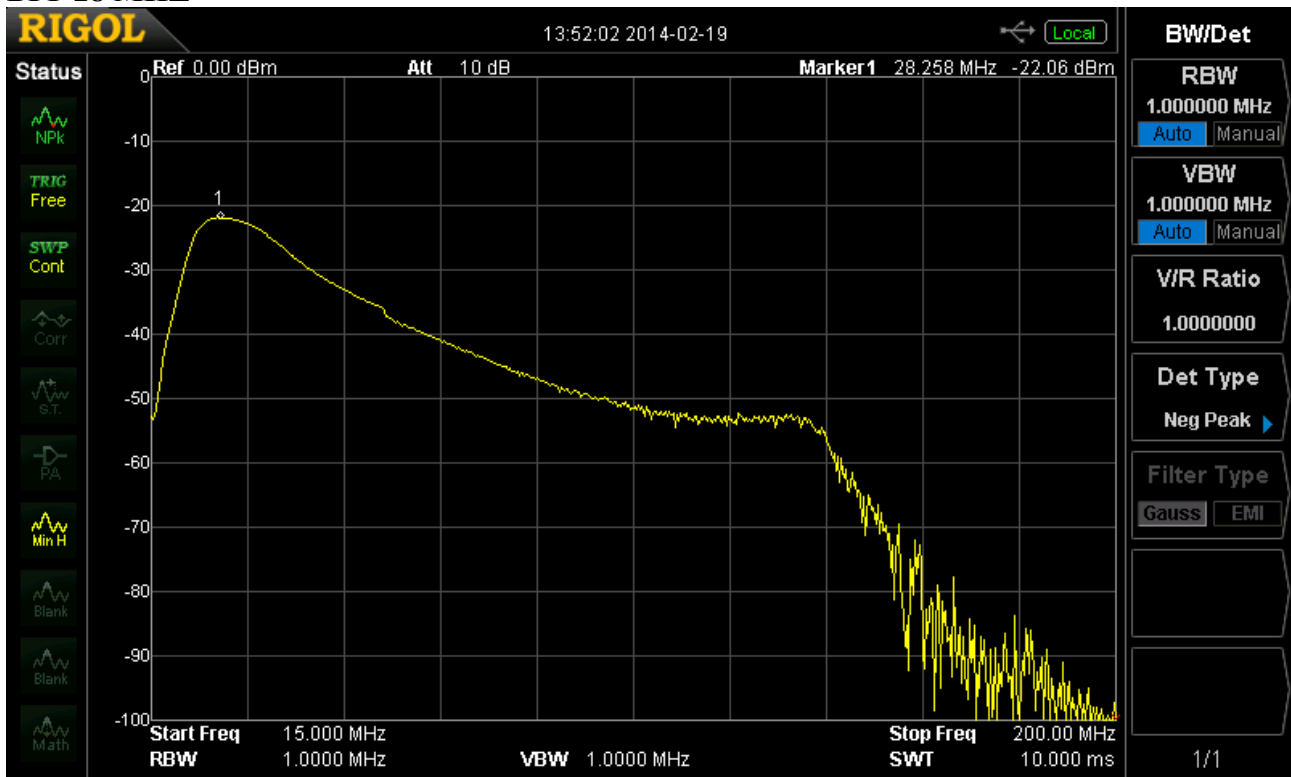

Transverter HG 70-K

See video on youtube..... <http://www.youtube.com/watch?v=DIBGHQF5hp0>

more info:

EA7HG

Eugenio F.Medina Morales

C/Obispo Aguilar,17 3º

23001 JAEN

SPAIN

ea7hg@hotmail.com

MANUAL Rev 1.2

© EA7HG,2014-15