

Package and Product Designed in U.S.A.

MADE IN CHINA

**AnyToneTech.com**



Copyright © 2015 by AnyTone Tech

All rights reserved. No part of this publication may be reproduced, distributed, or transmitted in any form or by any means without the permission of AnyTone Tech

**AnyTone**<sup>®</sup>  
*tech*

**OBLTR-8R**

THE OBLITERATOR

**TERMN-8R**

THE TERMINATOR

**USER'S MANUAL**





## THANK YOU FOR TRUSTING US WITH YOUR RADIO NEEDS !

*AnyTone*<sup>tech</sup> transceivers provide you with reliable, clear, and precise communications. This transceiver includes innovative DSP (digital signal processing) technology - allowing for easy integration into all environments. We encourage you to read through the manual to understand the various functions to get the most from your handset.

The transceiver includes 200 programmable channels, as well as UU, VV, UV, VU, Mono U or Mono V standby modes. The transceiver also allows for Dual PTT functions, 51 groups of CTCSS encode/decode, 1 group of user-defined CTCSS encode/decode, 1024 groups of DCS encode/decode, DTMF encode/decode, built-in FM radio, and many more features.

This radio is a meticulously built and a functional hand-held intended for every radio operator

### Radio Versions

**OBLTR-8R:** Dual Band, Dual Frequency, Dual Standby, Dual Display, Semi-Duplex, 2TONE/5Tone Encode Decode

**RX & TX:** 136-174 & 400-520 MHz

**RX:** 64-108 FM (FM Radio)

**TERMN-8R:** Dual Band, Dual Frequency, Dual Standby, Dual Display, Full Duplex, Cross-band Repeater, MSK Encode/Decode (Text), 2TONE/5Tone Encode/Decode, Frequency Hopping (FHSS)

**RX & TX:** 136-174 & 400-520 MHz

**RX:** 64-108 (FM Radio) FM, 108-136 MHz AM, 2.3-29.99 (Shortwave) MHz AM, 520-1710 (AM Radio) kHz AM.

## **THIS MANUAL IS FOR:**

### **OBLTR-8R**

OBLTR-8R Programming Software: OBLTR-8R\_Setup\_1.01.exe

### **TERMN-8R**

TERMN-8R Programming Software: TERMN\_8R\_Setup\_1.01.exe

## **USB PROGRAMMING PRECAUTION**

When programming the transceiver, first read from the radio, before modifying the frequencies data and settings. This will prevent errors caused from incompatible files.

## WARNINGS

*AnyTone<sup>®</sup>*<sub>tech</sub> transceivers are intelligently designed with advanced technologies. The following tips are required to prevent voiding warranty and understanding the safety of transceiver usage.

1. Keep the transceiver and all accessories away from children.
2. Do not try to open or modify the transceiver without permission. Irresponsible operation of the transceiver may also cause damage.
3. Use only *AnyTone<sup>®</sup>*<sub>tech</sub> approved batteries and chargers.
4. Use the provided antenna for communication.
5. Avoid exposing the radio to excess heat (such as direct sunlight) for extended periods or storing your transceiver in a hot location. High temperatures do shorten the life of electronic devices.
6. Do not store the radio in dusty, dirty, or damp areas.
7. Keep the radio dry. Do not wash radio with chemicals or detergents.
8. Do not transmit without the provided antenna.
9. When using this transceiver, we recommend transmitting for 1 minute then receiving for 1 minute. Continuous transmissions for a long time may over-heat the transceiver. If the transceiver is warm to the touch; do not set it by objects (such as plastic) that could melt.
10. If any abnormal smell or smoke comes from the transceiver, immediately shut off the power and remove the battery from the radio body. Then contact your local *AnyTone<sup>®</sup>*<sub>tech</sub> dealer.

### NOTE:

The above tips apply to your *AnyTone<sup>®</sup>*<sub>tech</sub> transceiver's accessories as well. If your accessories don't operate normally, please contact your local *AnyTone<sup>®</sup>*<sub>tech</sub> dealer for assistance.

Use of third-party/ after-market accessories are not guaranteed by *AnyTone<sup>®</sup>*<sub>tech</sub> and may void the warranty and/or safety of the transceiver

# ◦ TABLE OF CONTENTS

<b>UNPACKING</b> .....	01
Supplied Accessories .....	01
<b>STANDARD ACCESSORIES/ADDITIONAL ACCESSORIES</b> .....	02
Standard Accessories.....	02
Additional Accessories.....	02
<b>USER MODE SETUP:AMATEUR OR COMMERCIAL RADIO</b> .....	03
<b>BATTERY INFORMATION</b> .....	05
Charging Operation.....	05
Battery Charger Type.....	05
Notice for Charging Battery.....	05
How to Charge.....	06
Charging Prompts Explained.....	08
How to Store the Battery.....	08
<b>INSTALLATION &amp; CONNECTION</b> .....	09
Installing / Removing the Battery.....	09
Installing / Removing the Antenna.....	09
Installing / Removing the Belt Clip.....	10
Installing Optional Speaker / Microphone(Optional) .....	10
<b>GETTING ACQUAINTED</b> .....	11
LCD Display.....	11
<b>BASIC OPERATIONS</b> .....	14
Turn the Radio On & OFF .....	14
Adjusting Volume.....	14
Switch between Main band and Sub band .....	15
Switch between Channel mode and VFO mode.....	15

## ◦ TABLE OF CONTENTS

Channel Adjusting .....	15
Frequency Adjusting.....	16
Receiving.....	16
Transmitting.....	17
Emergency Alarm .....	17
Side Key [PF1] Setup and Use.....	17
Side Key [PF2] Setup and Use.....	19
Add a channel .....	20
Delete a channel.....	20
Limit VFO frequency scanning range .....	21
<b>SHORTCUT OPERATIONS</b> .....	<b>22</b>
Keypad reference chart .....	22
Turn On/ Off FM Radio.....	25
Add/Cancel Optional signal decode function .....	26
CTCSS/DCS Scan .....	27
Offset Frequency Direction Setup .....	27
Frequency/Channel Scan.....	28
Channel Scan Skip .....	29
Frequency Reverse .....	29
TX Power selection.....	30
Talk Around function.....	30
DTMF code Transmit and Enquiry .....	30
Keypad lock.....	31
Single-band Switching.....	32
CTCSS/DCS Encode and Decode.....	32
Cross-Band Repeater(TERMN-8R ONLY).....	32



## o TABLE OF CONTENTS

NOAA .....	33
MSK (Text) Signal Sending (TERMN-8R ONLY) .....	34
<b>Function Menu Setup(OBLTR-8R)</b> .....	35
<b>Function Menu Setup(TERMN-8R)</b> .....	42
<b>Function Menu Setup</b> .....	49
CTCSS/DCS Encode Setup .....	49
CTCSS/DCS Decode Setup .....	49
CTCSS/DCS Encode/Decode Synchronous Setup .....	50
5TONE encode group selection .....	51
2TONE encode group selection .....	51
Optional signaling setup .....	52
2TONE decode group selection .....	53
MSK encode group selection(TERMN-8R ONLY) .....	53
Squelch mode setup .....	54
Frequency step size setup .....	55
Wide / Narrow Band Selection .....	55
Frequency Reverse .....	56
Talk Around ON/OFF .....	56
Offset Frequency setup .....	57
Editing Channel name .....	57
Busy Channel Lockout .....	58
TX OFF .....	58
Single Band Mode (VHF/UHF) (VFO) .....	59
Sub band display setup .....	60
Keypad Voice prompt setup .....	60
Time-Out-Timer (TOT) .....	61

## ◦ TABLE OF CONTENTS

Voice Operated Transmission (VOX) Setup.....	61
VOX Delay Setup .....	62
Automatic Power Off Time setup .....	62
DTMF Transmitting Time Setup.....	63
Squelch level setup .....	63
Scanning Resume Time Setup.....	64
Scan Speed.....	65
Function Icon Stay Time Setup.....	66
LCD Backlight Setup.....	67
LCD Backlight Color Setup.....	67
Self ID inquiry.....	68
Tone Pulse Frequency Selection .....	68
Battery Save Setup.....	69
FM radio.....	70
FM Radio Functions.....	70
PF1 key Function Setup.....	71
PF2 key Function Setup.....	72
AMSQL(TERMN-8R ONLY).....	72
Sub-Radio Volume Setting(TERMN-8R ONLY).....	73
Mute Setup (TERMN-8R ONLY).....	73
<b>ADVANCED FUNCTION OPERATIONS.....</b>	<b>75</b>
Display Mode Setup.....	75
Resume Factory Default .....	75
Public Usage Frequency Mode (FCC Part 95).....	76
Programming a Duplex Channel Example.....	78

## ◦ TABLE OF CONTENTS

Optional Signaling (DTMF) .....	79
2TONE Calling .....	81
Optional signal (5TONE) .....	82
Communication Note (Caller ID/PTTID List) (ANI) .....	85
MSK ENCODE / DECODE and FHSS-Frequency Hopping (TERMN-8R ONLY) .....	85
Cloning Cable .....	87
<b>Memory Bank</b> .....	89
Memory Bank Switch .....	89
Memory Bank Exit .....	90
Bank Linking .....	90
<b>Programming software starting (Takes Windows XP system for example)</b> .....	92
<b>TECHNICAL SPECIFICATION</b> .....	93
<b>TROUBLE SHOOTING GUIDE</b> .....	96
<b>ATTACHED CHART</b> .....	98
CTCSS Frequency Chart .....	98
1024 groups DCS Frequency Chart .....	99
<b>FCC COMPLIANCE</b> .....	102
Usage of Your Transceiver on Part 90 (Commercial) and Part 97 (Amateur) Frequencies .....	102
Usage of Your Transceiver on Part 95 (Public) Frequencies .....	102
<b>LIMITED WARRANTY (UNITED STATES)</b> .....	103
<b>ANYONE TECH'S LETTER TO YOU</b> .....	104

## ○ UNPACKING

Carefully unpack the transceiver. We recommend that you identify the items listed in the following table before discarding the packaging.

If any items are missing or have been damaged during shipment, please contact your dealer immediately.

### ((( Supplied Accessories

Item	Number	Quantity
Antenna	QA09UV1	1
Li-ion Battery	QB-35L	1
Battery Charger	QBC-35L	1
AC Adaptor	QPS-01	1
Earpiece	HS03	1
Belt Clip	BC07	1
Instruction Manual		1

## ◦ STANDARD ACCESSORIES/ADDITIONAL ACCESSORIES

### Standard Accessories



Antenna\*1  
QA09UV1  
155/435MHz



Li-ion Battery  
QB-35L



Battery Charger  
QBC-35L



AC Adaptor  
(12V/500mA)  
QPS-01



Earphone  
HS03



Belt Clip  
BC07



Instruction  
Manual

**\*1.Note: For frequency band of antenna, please refer to label indicated in the bottom of the antenna.**

### Additional Accessories



USB Programming  
Cable PC03



Programming Software  
OBLTR-8R/TERMN-8R\_USA



Car Charger  
CPL03



Battery Pack for Car  
Charger CPS02

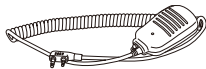

Handheld Microphone  
QHM22



Telescopic antenna  
QA10UV



Cloning Cable  
CP04

## o USER MODE SETUP: AMATEUR OR COMMERCIAL RADIO

The transceiver is a high performance amateur and professional radio with dual band, dual standby, dual display and other advanced features. According to your specific application, you can set the radio to operate as an Amateur Transceiver or as a Professional (Commercial) Transceiver. There are 3 operating modes - and you can pick the mode best suited for your needs at anytime.

### 1. Modes of Operation:

**A. By programming software:** In the PC software's "General Setting (Function Setup)" menu, choose the "Display Mode" drop down menu. Frequency and Name modes will display the channels by frequency or name accordingly and still allow amateur usage and access. Channel mode will restrict access to amateur options (such as VFO).

**B. By manual setup:** Please refer to "Display Mode" in Page 75.

**2. Amateur Transceiver Mode:** Unless your setting is Channel mode, Frequency and Name are considered as Amateur transceiver modes. Under these modes, you can press the " " key to switch between Channel mode and VFO.

**A. Frequency + Channel mode:** When you set the operating mode as "FREQ", it enters into Frequency+Channel mode. This mode allows editing settings of channels and the shortcut operation can also be used. Once the radio is turned off or switched to another channel, the temporary settings will be erased and changed back to the initial settings. (As pic 1)

**B. Name Tag + Channel Mode:** When you set the operating mode as "NAME", it enters into Name Tag + Channel Mode. In this mode, it will display the corresponding channel name (if you have give a Channel name in the memory). If no name is given, it will display the frequency + channel number.

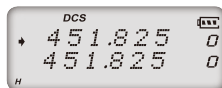

(Pic 1)



(Pic 2)

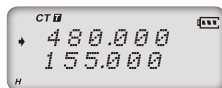

(Pic 3)

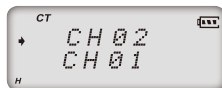

(Pic 4)

## ◦ USER MODE SETUP:AMATEUR OR COMMERCIAL RADIO

channel operations are the same as described in frequency + channel mode. (As pic 2)

C. **VFO Mode(Frequency mode):** This mode shows only frequency on the display. You can enter this mode by simple pressing the " " key, while you are in both **FREQ** and **NAME** Channel Modes. Shortcut operations and Channel settings are able to changed & stored as the latest values. Even if the radio is turned off, the settings remain the same until the next VFO change. (or if it is changed to a new VFO frequency).(As pic 3)

3. **Professional Transceiver Mode:** When setting the display mode as "CH" (Channel), it will enter into the Professional Transceiver mode. In this mode all functions (except scan, DTMF encode or editing, and keypad lock) should be set by PC software (As pic 4).

**NOTE:If the transceiver is PC programmed to channel mode and locked,you can not return it to the amateur transceiver modes manually .**

4. Under every mode, background operations still can be changed and saved. (unless the menu access is blocked by the programming software)

**NOTE:To use the radio on Public frequencies. Please refer to "ADVANCED FUNCTION OPERATIONS – Public Usage Frequency Mode (FCC Part 95)"**

### ((( Charging Operation

The battery is not charged at the factory, please charge it before your initial use. Charging the battery for the first time or charging it after extended storage (more than 2 months) may not bring the battery to its maximum operating capacity after the first charge. It may take repeating a full charge/discharge cycle for two or three times before the operating capacity reaches its maximum performance. It is recommended that you replace the battery pack when the battery can no longer hold a charge (even when you have it fully and correctly charged). Properly dispose of the expired battery pack.

### ((( Battery Charger Type

Please use our company's designated charger, after-market chargers could cause battery damage and in some cases could even explode the battery.

### ((( Notice for Charging Battery

- ▲ Do not short-circuit the charger. Never attempt to remove the casing from the battery. Tampering or modifying the battery and charger is not allowed and we are not responsible for anything that occurs from modification.
- ▲ The ambient temperature should be between 40°F and 100°F during charging.
- ▲ Always switch off the transceiver equipped with a battery before charging. A transceiver left on, will interfere with correct charging.
- ▲ To avoid interfering the charging procedure, do not cut off the power or take out the battery during a charge.



## ○ BATTERY INFORMATION

- ▲ Do not recharge the battery if it is already fully charged. This could shorten the life of the battery or damage the battery.
- ▲ Do not charge the battery or transceiver if it is damp or wet. Dry it before charging to avoid any danger.

**WARNING:**When keys, ornamental chains, or other metals contact or short the battery terminals, the battery could cause a shock or injury. If the battery terminals are allowed to short circuit, they will generate a lot of heat. Be careful when you bring or use a spare battery. Put the battery or radio into an insulated container. Do not put them into metal containers.

### (((How to Charge



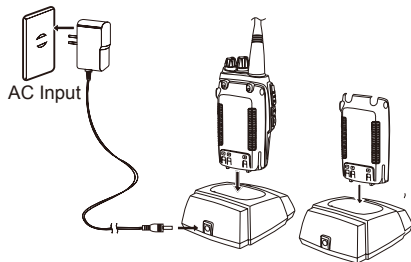

1. Plug the AC adapter into the AC outlet(100V-240V), then plug the cable of AC adapter into the DC jack, the indicator will light GREEN--- this means it is waiting to charge.
2. Slide the battery or transceiver with battery into the charger; make sure the battery terminals are in contact with the charging terminals well. The LED may begin flashing--- pre-charging begins.
3. It may pre-charge for about 5 minutes, in which once the LED stops flashing and turns into a solid RED--- the full charging has begun.
4. It may take about 5-6 hours to fully charge the battery, when the LED turns GREEN— it is fully charged.



## ◦ BATTERY INFORMATION

**NOTE:** When charging a powered on transceiver equipped with battery, the LED will not turn to green to show the full charge status. Only when you turn off the transceiver, will the LED indicate normally. If the transceiver is powered on, it will continually consume energy. The charger cannot detect when the battery has been fully charged and will fail to indicate correctly.

### 5. Charging Process:

Status	LED
Standby (self-examine orange lights 1second when power on)	 Green light
Pre-charging (pre-charging stage)	 Red light flashes for about 5 minutes
Charging	 RED light for about 5.5 hours
Full charged (charge in constant voltage)	 Green light

### 6. LED Indicator:

STATUS	self-examine when power on	(No battery)	Pre-charging	Charge normally	Full Charged	Error
LED	Orange (for 1 second)	Green	Red light flashes for 5 minutes	Red	Green	Red flashes for a long time

**NOTE:** An Error means the battery is too hot or cold, the battery has short-circuited, or the charger has short-circuited.

## ○ BATTERY INFORMATION

### ((( Charging Prompts Explained

1. Self-examination: When plugging in your charger, the ORANGE light may flash for 1 second and go out. This means that the charger has passed its self-examination and it can charge the battery normally. If the light remains orange or the red light flashes this means the charger cannot pass its self-examination test and it will not charge the battery.
2. Trickle pre-charging: When the battery has been inserted into the charger and the RED light begins flashing, this means that the remaining voltage is very low. The charger will trickle charge the battery (pre-charging status), until the battery reaches a minimum charge. The charger will then automatically start the normal charging cycle. If the red light stops flashing immediately, this means that the remaining voltage is high enough to allow the charger to charge the battery normally.

**NOTE:** The time for Trickle pre-charging should not exceed 30 minutes. After 30 minutes, if the red indicator is still flashing, it means it is unable to charge battery. Check both the battery and charger for any issues.

### ((( How to Store the Battery

1. If the battery needs to be stored, the battery should be kept in the status of 50% discharge.
2. It should be kept in a cool and dry environment.
3. Keep away from hot places and direct sunlight.

#### **WARNING**

- ▲ Do not short circuit battery terminals.
- ▲ Never attempt to remove the casing from the battery pack.
- ▲ Never attach the battery to the radio in dangerous.
- ▲ Do not put the battery in a hot environment or throw it into fire.

### ((( Installing / Removing the Battery

#### ■ Installing the Battery:

1. Lay the battery to face the back of the radio.
2. Press the bottom of the battery, the latch in the bottom of the transceiver lock will release. After hearing a "click", the battery has been locked.

#### ■ Removing the Battery:

According to "▼" on the battery release, push the battery lock release tab to remove the battery.

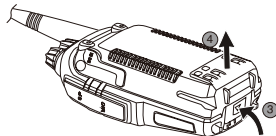

### ((( Installing / Removing the Antenna

#### ■ Installing the Antenna:

Screw the antenna into the connector on the top of the transceiver by holding the antenna at its base and turning it clockwise until secure.

#### ■ Removing the Antenna:

To remove it: Turn the antenna counterclockwise until the antenna has been removed from the threads of the transceiver.

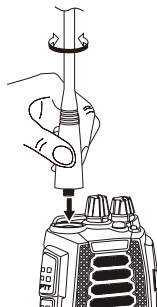

## ○ INSTALLATION & CONNECTION

### ((( Installing / Removing the Belt Clip

#### ■ Installing the Belt Clip:

Place the belt clip to the grooves on the back of the transceiver, and then install the screws, turning clockwise.

#### ■ Removing the Belt Clip:

Remove the screws turning counterclockwise, allowing you to remove the belt clip.

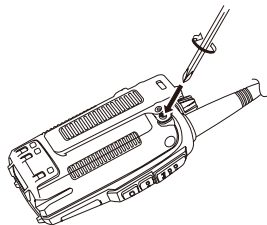

### ((( Installing the Additional Speaker/ Microphone (Optional)

Unveil the MIC-SP jack cover and then insert the Speaker/Microphone plug into MIC-SP jack.

**Note: The transceiver is not completely waterproof while using the Speaker/Microphone.**

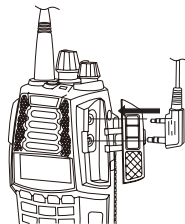

## Ⓕ LCD Display

On the LCD display screen, you will see various icons appear which stand for the functions you may have enabled. In order to thoroughly understand the icons and their meanings an overview is provided below:

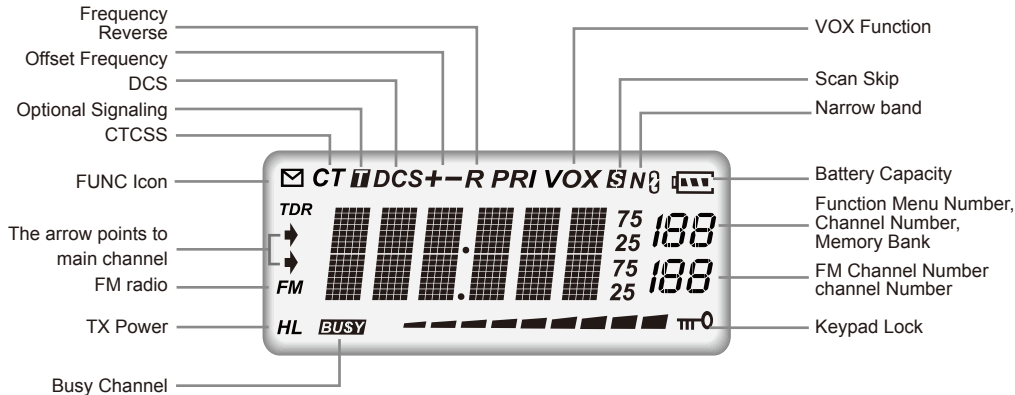

### NOTE:

- Battery capacity indicator(full)     No power, replace battery pack or charge battery
- Remaining battery capacity     Real time display receiving signal strength/Power Indicator

## ◦ GETTING ACQUAINTED

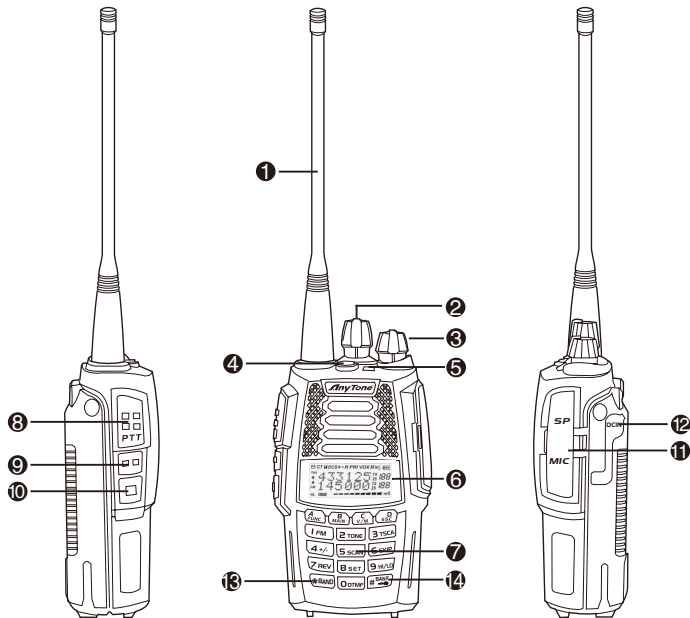

## ◦ GETTING ACQUAINTED

**1** Antenna

**2** Channel Selector Knob

**3** Power / Volume Knob

Rotate it clockwise to turn on the transceiver, rotate it counterclockwise until you hear the "click" to turn off the transceiver.

When the transceiver is powered on, turn the knob clockwise to increase volume, or turn the knob counterclockwise to reduce the volume.

**4** Emergency Alarm

Hold 3 seconds to activate the alarm, cycle the radio's power to turn off Alarm.

**5** TX/RX indicator, RX is GREEN (Upper Band) or BLUE (Lower Band), TX is RED, Tone Received is PURPLE.

**6** LCD display

Displays current frequency/channel and operations

**7** Keypad

Enters desired frequency/channel or operations by keypad

**8** PTT key

Press PTT key to talk, release this key to receive.

**9** PF1 key

**10** PF2 key

**11** Speaker/Microphone jack, programming software jack

**12** Car charging port

**13** Single-band Switching

**14** Memory Bank Operation



## ◦ BASIC OPERATIONS

### ☞ Turn the Radio On & OFF



When the radio is off turn **[POWER]/ [VOLUME]** clockwise to turn on the transceiver.



When the radio is on, turn **[POWER]/ [VOLUME]** counterclockwise to turn off the transceiver.

### ☞ Adjusting Volume



When the radio is on, turn **[POWER] / [VOLUME]** to adjust volume. The volume increases when you turn the knob clockwise and decreases when you turn the knob counterclockwise.

**NOTE:** Press the side key programmed as Squelch Off to monitor the background noise. You can turn the **[POWER]/[VOLUME]** knob to control the volume.

**NOTE:INDIVIDUAL CHANNEL SQUELCH LEVEL:** While holding the Key Set as 'SQELCH OFF', turn the **[Selector Knob]** to adjust squelch level for current channel (this will set the squelch level on the individual channel). Turn **[Selector Knob]** to adjust squelch level for current channel.

### ⌘ Switch between Main band and Sub band

While in standby press  key to switch between Main band and Sub band. The Display Arrow will point to the current operating channel.

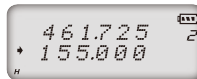

### ⌘ Switch between Channel mode and VFO mode

While in standby, press  key to set the selected band into channel mode or frequency mode(VFO).

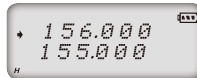

**NOTE:When the transceiver is in channel mode the right side of the frequency will display the channel (or memory bank) number.**

### ⌘ Channel Adjusting

#### 1. Input channel number by scrolling

When the transceiver is in Channel mode or in the FM radio channel mode, rotate the channel knob to go through channels. Rotate the channel switch clockwise to increase the channel number, or rotate it counterclockwise to decrease the channel number. If there is a blank channel between two channels, the radio will automatically skip the blank channel and go onto the next channel.

#### 2. Input channel number by keypad

When the transceiver is in Channel mode or in the FM radio channel mode, the user can input any number (000-199) to switch to the desired channel. If the channel number entered is an un-programmed channel, the radio will audibly let you know an empty channel has been selected and return to the previously tuned channel. Example Channel Entry: 001 is channel 1, 030 is channel 30, 125 is channel 125.

## ◦ BASIC OPERATIONS

### ((( Frequency Adjusting

When the transceiver is in VFO frequency mode or is in FM radio frequency mode, rotate the channel knob to adjust the frequency, or you can input the frequency by the keypad.

1. Enter the desired frequency by increments.

Rotate the channel knob clockwise to increase the frequency, rotate it counterclockwise to decrease the frequency. The frequency amount changed depends on the chosen frequency step. It will add or reduce the frequency by the chosen step value.

**NOTE: Channel step increments: 2.5K, 5K, 6.25K, 10K, 12.5K, 20K, 25K, 30K and 50KHz. The FM radio step increment is 50K. AM/SW/LW radio step frequency is 10K.**

2. Enter the desired frequency by keypad.

**VFO mode:** if you want input frequency 145.150MHz, please press [1], [4], [5], [1], [5], [0] on the keypad.

**FM mode:** if you want input frequency 101.50MHz, please press [1], [0], [1], [5] on the keypad.

**NOTE: The frequency input of the main channel or FM radio is relevant to the channel step and frequency range. If the frequency entered is beyond range – the frequency entered will not be accepted. In FM mode, the keypad input frequency channel step is 100K.**

### ((( Receiving

When your transceiver receives a transmission, the LED light will light up (it will light green if the main band

## ◦ BASIC OPERATIONS

is receiving and will light blue if the sub band is receiving) and the arrow icon will flash, and if the volume is up high enough you will also hear the transmission.

**NOTE: You may not receive the call if your transceiver is set at a high squelch level. If the current channel is programmed with a mandatory decode (RX) tone (CTCSS, DCS, etc), the selected tone also must be present for the call to be heard.**

### ((( Transmitting

According to how the [PF1] or the [PF2] key is setup in the programming software, hold the key programmed as Squelch Off to monitor the channel to ensure it is not in use, Then press the [PTT] key and talk into the microphone. Keep the distance between your mouth and the microphone about 1-2 inches. Speak in your normal voice (don't whisper and don't yell into the mic) for the best audio clarity.

**NOTE: When pressing and holding the PTT key, the radio will transmit (and will be indicated by the red LED light). Release the [PTT] key to receive calls.**

### ((( Emergency Alarm

When the transceiver is in standby, press and hold the [ALARM] key until the LCD displays "ALARM". The emergency alarm has now started. This transceiver has 4 Alarm modes. You can set up which mode works best for you in the programming software. Power off the transceiver to exit Alarm.

### ((( Side Key [PF1] Setup and Use

[PF1] key can be customized to suit your needs, the available options are below:

## o BASIC OPERATIONS

1. **VOLT:** Battery capacity inquiry: Under standby, press [PF1] key, LCD displays current battery capacity, press this key again to exit.
2. **CALL:** Transmit the prestored DTMF/5TONE/2TONE/MSK Encode signal in channel.
3. **FHSS (TERMN-8R Only):** Frequency hopping function. Press the [PF1] key to activate the frequency hopping function, The LCD display will "FHSS", and the transceiver will communicate on the frequency in the pre-set hopping frequency range (set by software).

**NOTE: The Receiver and the Sender must have the same hopping frequency, and must setup the MSK decode signaling. Using FHSS may cause interference to sub band receive depending on frequency or setting of Menu 51 (sub-band mute).**

4. **ALARM:** Activated by a long press of the [PF1]/[PF2] key. The LCD will display "**ALARM**" and the transceiver will enable the preset alarm function.
5. **SUBPTT:** Press [PF1] key, transceiver will transmit on the sub-band frequency (use this function to enable "Dual PTT").
6. **MONI:** Depending how you set up the programming software this will activate 'Squelch off' or 'Squelch off Momentary'. Press the [PF1] key, which will open the squelch, you will hear any noise on the frequency. (If you have it set to 'Squelch off' you must press the [PF1] key again to re-enable the squelch - if you have it set to 'Squelch off Momentary' the squelch will only be open as long as you have the [PF1] key pressed).
7. **Transmit tone pulse frequency:** Press and hold [PTT] key, then press [PF1] key to transmit selected tone pulse frequency.  
**NOTE: The tone pulse frequency can be set to 1750Hz, 1450Hz, 1000Hz or 2100Hz .**
8. **Clone Mode:** Press and hold the [PF1] key as you turn on the transceiver, to begin and activate the cloning function (see the 'Cloning Cable' Section in this manual for more details)

### ((( Side Key [PF2] Setup and Use

The [PF2] key can be customized to suit your needs, the available options are below:





1. **VOLT:** Battery capacity inquiry: Under standby, press [PF2] key, LCD displays current battery capacity, press this key again to exit.
2. **CALL:** Transmit the prestored DTMF/5TONE/2TONE/MSK Encode signal in channel.
3. **FHSS (TERMN-8R Only):** Frequency hopping function. Press the [PF2] key to activate the frequency hopping function, The LCD display will "FHSS", and the transceiver will communicate on the frequency in the pre-set hopping frequency range (set by software).

**Note :** The Receiver and the Sender must have the same hopping frequency, and must setup the MSK decode signaling. Using FHSS may cause interference to sub band receive depending on frequency or setting of Menu 51 (sub-band mute).





4. **ALARM:** Activated by a long press of the [PF1]/[PF2] key. The LCD will display "**ALARM**" and the transceiver will enable the preset alarm function.
5. **SUBPTT:** Press [PF2] key, transceiver will transmit on the sub-band frequency (use this function to enable "Dual PTT").
6. **MONI:** Depending how you set up the programming software this will activate 'Squelch off' or 'Squelch off Momentary'. Press the [PF2] key, which will open the squelch, you will hear any noise on the frequency. (If you have it set to 'Squelch off' you must press the [PF2] key again to re-enable the squelch - if you have it set to 'Squelch off Momentary' the squelch will only be open as long as you have the [PF2] key pressed).
7. **General Function Setup:** Press and hold the [PF2] key as you turn on the transceiver, to enter the general function setup (see the 'Display Mode Setup' or the 'PART 95' Sections in this manual for more details).

## ◦ BASIC OPERATIONS

### ((( Add a channel

1. Under frequency mode (VFO), after you have set up your desired frequency and settings (read through the Function Menu Setup in order to understand how to set your desired frequency settings), Press the  key, the top left corner of LCD will display the "✉" icon, then press the  key to enter the manual channel programming mode, the channel number will begin flashing.
2. Rotate the channel knob until the Channel number displays the channel you would like to program(000-199).
3. Press the  key, the top left corner of LCD displays the "✉" icon, and hold the  key until the transceiver emits the confirmation beep. Your new channel has been programmed successfully.





### ((( Delete a channel

1. While your radio is in standby, Press the  key, the top left corner of LCD will display the "✉" icon, then press the  key to enter the manual channel programming mode, the channel number will begin flashing.
2. Rotate the channel knob until the Channel number displays the channel you would like to remove(000-199).
3. Press the  key, the top left corner of LCD displays the "✉" icon, and hold the  key until the transceiver emits a confirmation beep. Your channel has been successfully deleted.

**Note :** This process can be used for FM radio channels as well.

### ((( Limit VFO frequency scanning range

Setting the frequency of L1 channel, U1 channel, L2 channel, and U2 channel will set a VFO frequency scanning border (channels are found before channel 0 and after channel 199). L1 and U1 must be used on the same frequency band. L2 and U2 must also be used on the same frequency band, When the VFO frequency is between L1 and U1 or L2 and U2, the radio will scan between them when scanning is activated. When the VFO frequency is outside of L1 and U1 or L2 and U2, the radio will scan the whole frequency range of the radio.









1. In VFO mode, enter your frequency range "lower border limit". Press the  key, the top left corner of LCD will display the "✉" icon, then press the  key to enter the manual channel programming mode, the channel number will begin flashing.
2. Rotate the channel knob until the Channel number displays the "lower border limit" channels (either L1 or L2) (They are found in the channel menu after Channel 199 and Before Channel 0)
3. Press the  key, the top left corner of LCD displays "✉" icon, and hold the  key until the transceiver emits confirmation beep. Your "lower border limit" channel has been programmed successfully.
4. Repeat the above steps to enter the "upper border limit" channel (either U1 or U2) .

**NOTE: In order for the borders to operate correctly, L1 and U1 must be in same band (VHF or UHF) and L2 and U2 must be in same band (VHF or UHF). You can set both borders in the same band and when you start scanning from a frequency that is within the current border the scanning will stay within that border. When you start scanning outside of either border the scanning will go through the entire radio frequency range..**













## ◦ SHORTCUT OPERATIONS

### ⌘ Keypad reference chart

	When Pressed			
KEY	Entering a Frequency or Recalling a Memory Channel (Or FM Mode)	Inputting an Alpha Tag Inputting CTCSS / DCS Tone	The Key is Pressed after "  " is Pressed	The Key is Pressed and held when power on
	Enters Function Mode	--	--	--
	Switch Indicator between Main and Sub Band FM Mode: On / Off	(TERMN-8R)MSK message:Scrolls Upward	Add / Remove Channel See Explanation under "BASIC OPERATIONS - Delete a Channel"	(TERMN8R) <b>PF1+</b>  Cross-Band Repeater
	Switch from Frequency to Channel Mode on selected Channel (FM Mode Too)	(TERMN-8R)MSK message:Scrolls Downward	Add / Remove Channel See Explanation under "BASIC OPERATIONS - Add a Channel"	--
	--	Exit Menu	Exit Function Mode	<b>PF2+</b>  Reset Factory Default
	Number "1"	NAME Alpha Tag: Next Character <b>CTCSS / DCS:</b> Select Mode (CTCSS, DCS, OFF)	Enable / Disable: FM Mode	--
	Number "2"	--	Enable / Disable: DTMF/2TONE/5TONE/MSK	--

## ◦ SHORTCUT OPERATIONS

	Number "3"	--	Enable / Disable: CTCSS / DCS Tone Scan (on active selected tone mode)	--
	Number "4"	NAME Alpha Tag: Previous Character	Enable / Disable: Offset Direction	--
	Number "5"	--	Enable Scan	--
	Number "6"	--	Enable / Disable: Channel Skip	--
	Number "7"	--	Enable / Disable: Frequency Reverse	--
	Number "8"	--	Enter Function Menu / Background Menu	--
	Number "9"	--	Set Transmit Power	--
	Number "0"	--	DTMF Memory Bank	--
	Single Band Switching	DCS: Select positive code or inverted code	Enable / Disable: Talk Around	--
	Memory/Channel Bank See Explanation under "Memory Bank"	Exit Menu	Enter NOAA <b>Long Press:</b> Keypad Lock	--
<b>PTT</b>	PTT (if TX is enabled) <b>FM Mode:</b> Listen to FM in Background	Exit Menu	--	--

## o SHORTCUT OPERATIONS

<b>PF1</b>	Programmed PF 1 Function	(TERMN-8R) MSK message Alpha Tag: Next Character	(TERMN-8r) MSK signal (text) edit function	Cloning Cable See Explanation in Guide
<b>PF2</b>	Programmed PF 2 Function	(TERMN-8R)MSK message Alpha Tag: Previous Character	--	Enters Advanced Function Mode See Explanation in Guide
<b>Channel Selector Knob</b>	Change Channel, Frequency, or Setting	Change / Scroll through Alpha Characters	Memory Bank Remove Channel: After A is Pressed, Press B, Than Rotate Channel Selector Knob to Confirm. See Explanation in Guide	--

## ◦ SHORTCUT OPERATIONS

### ((( Turn On/ Off FM Radio

When in standby, press **[A FUNC]** key, the top left corner of the LCD will display "✉" icon, then press **[I FM]** key. The LCD will displays "FM ON" and the current FM radio frequency, The FM radio is now on. When the FM radio is on, press **[B MAIN]** key, LCD displays "FM OFF", The FM radio is now muted.

When FM radio is on, press **[A FUNC]** key, the top left corner of LCD displays "✉" icon. Press **[I FM]** key to turn off the FM radio and to return to the transceiver state.

Powering the transceiver off and back on will also exit the FM radio function. You can listen to the FM radio in the background (any incoming call will silence the FM radio) - and can return to the the Amateur or Professional Screen by pressing the **[D ESC]** or the PTT button.

#### For TERMN-8R

TERMN-8R also has FM/AM (Aviation Frequencies)/SW (Shortwave)/LW (AM Radio Frequencies) for a total of 4 additional RX radio bands. Press **[A FUNC]** key then press **[I FM]** key to turn on the FM radio. In the AM/FM Mode you can press the **[A FUNC]** key and then **[\* BAND]** to switch between FM/AM (Aviation Frequencies)/SW (Shortwave)/LW (AM Radio Frequencies) bands, pressing the B key will mute /un-mute the radio functions.

FM: 64~108MHz(RX)(100 memory channels CH00~CH99 by software or manual programming)

AM (Aviation Frequencies): 118~136MHz(RX)(100 memory channels CH00~CH99 by software or manual programming)

SW (Shortwave): 2.3~29.99MHz(RX)

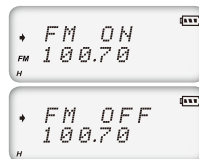

LW (AM Radio Frequencies): 0.52~1.71MHz(RX)







## ◦ SHORTCUT OPERATIONS

**NOTE:** AM/SW/LW require another antenna (For Optimal Performance). Also when you are in an AM mode (AM/LW/SW), the sub-band UHF/VHF channel will be occupied for the AM monitoring.

### (((Add/Cancel Optional signal decode function

When in standby, press  key, the top left corner of LCD displays "✉" icon, press  key.

1. The LCD displays "DTMF" and "", DTMF signaling has been added in the current channel.
2. Repeat the above operation, the LCD displays "5STONE" and "", the 5TONE signaling has been added in current channel.
3. Repeat the above operation, the LCD displays "2TONE" and "", the 2TONE signaling has been added in the current channel.
4. (TERMN-8R ONLY) Repeat the above operation, the LCD displays "MSK" and "", MSK signaling has been added in the current channel.
5. Repeat the above operation, the LCD displays "OFF", the "" icon disappears, and no optional signaling has been added in current channel.

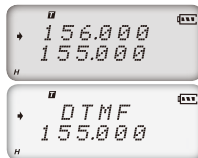

**NOTE:** When this function is on, the user must setup the SIGNAL menu to use the TONE option, then DTMF/5STONE/2TONE/MSK can be used (For decoding). The programming software is required to set the tones needed if you require specific optional signaling.

### ((( CTCSS/DCS Scan

Press key, the top left corner of LCD displays "✉" icon, press key to enter into CTCSS/DCS scan. Under this state, rotate the channel knob to change the scanning direction. When the scan receives CTCSS/DCS signaling, it will stay 5seconds and then continue scanning. Rotate the channel selector knob to change the scanning direction. When scan the matching CTCSS/DCS signaling, it will stay 5seconds and then continue scanning. Press any other keys except , , key to exit.

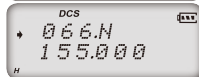
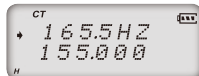

**NOTE:** This function will not work when the transceiver is set up in the professional mode or the current selected channel does not have any CTCSS/DCS signal first set up. If your current channel has its tone signaling set as CTCSS, it will scan CTCSS, if its tone signaling is set as DCS, it will scan DCS.

### ((( Offset Frequency Direction Setup

When in standby, press key, the top left corner of LCD displays "✉" icon, press key to choose offset frequency direction. There are 3 options, Plus offset, Minus offset, remove offset.

1. **(+) Plus offset:** Indicates TX frequency is higher than RX frequency. If the reverse function is enabled, the RX frequency is higher than TX frequency.
2. **(-) Minus offset:** Indicates that the TX frequency is lower than the RX frequency. If the reverse function is enabled, the RX frequency is lower than TX frequency.
3. **None:** Indicates that the offset is off.

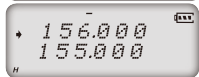
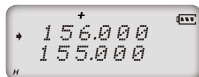

## ◦ SHORTCUT OPERATIONS

Under frequency mode (VFO) or channel mode, press  key then press  key to choose plus offset direction(+), minus offset direction (-) ,remove offset (Please refer to offset frequency setup).

**NOTE: This function is unavailable in professional transceiver mode.**

### ((( Frequency/Channel Scan

Under the corresponding mode, press  key, the top left corner of LCD displays "☑" icon, then press  key to start frequency scan or channel scan.

#### 1. Frequency Scan

Under VFO mode, frequency scanning is available. The frequencies will be scanned by the transceiver's 'step' setup, press any numeric key or  key to exit.

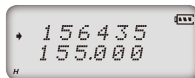

#### 2. Channel Scan

Under channel mode, channel scanning is available. The channels will be scanned in order of the channel setup as long as they are not programmed to "Skip" during scanning, Press numeric key or the  key to exit.

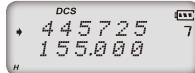



#### NOTE:

- ▼ Frequency scan will go through all bands, it will scan upwards in increments that you have set the STEP setting to.
- ▼ In channel scan, skipped channels will not be scanned. It will scan upwards through channels. (please refer to channel scan skip).

## ◦ SHORTCUT OPERATIONS

- ▼ Frequency/channel scan can change the scanning direction by rotating the channel knob, If a signal is found the transceiver will stay 5 seconds then continue scanning. (Please refer to scan setup)
- ▼ Frequency scan can be limited to UHF / VHF if you have the single band mode enabled (See: Function Menu – Single Band Mode (VHF/UHF))
- ▼ Frequency Scan can also be limited to your pre-set scanning border limits (See: Limit VFO frequency scanning range)
- ▼ If turn off radio in scan mode, when re-power on, radio will resume scanning automatically.

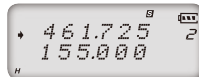

### ⏪ Channel Scan Skip

Under channel mode, press  key, the top left corner of LCD displays "✉" icon, then press  key to set current selected channel as Channel scan skip. Repeat above operation to cancel channel scan skip.



1. LCD displayed "S" means the current channel will not be scanned.
2. "S" icon disappeared means the current channel will be scanned.

### ⏪ Frequency Reverse

When in standby, press  key, the top left corner of LCD displays "✉" icon, then press  key to set arrow directed channel as frequency reverse, repeat above operation to turn off frequency reverse.

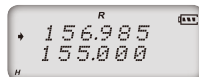

1. When LCD displays "R" icon, it means current selected channel has the frequency reverse function enabled, the TX frequency and RX frequency are reversed, if CTCSS/DCS signaling is





## ◦ SHORTCUT OPERATIONS

set, they will also interchange.

2. When "R" icon disappears, it means that the channel is normal and is not reversed.

### ((( TX Power selection

When in standby, press  key, the top left corner of LCD displays "✉" icon, then press  key to choose High/Middle/Low power for the current selected channel.



1. When LCD displays "L" icon, it means low power has been chosen.

2. When LCD displays NO icon, it means middle power has been chosen.

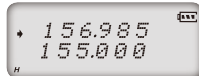
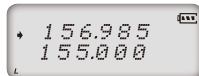
3. When LCD displays "H" icon, it means high power has been chosen.



### ((( Talk Around function



When in standby, press  key, the top left corner of LCD displays "✉" icon, then press  key, the current selected channel will enable talk around, repeat the above operation to close talk around.

1. **TX=RX**: Enable talk around, current channel transmit at RX frequency, if CTCSS/DCS signaling is set, it will interchange decoding CTCSS/DCS as encoding.

2. **OFF**: Close talk around.



### ((( DTMF code Transmit and Enquiry

1. Press  key, the top left corner of LCD displays "✉" icon, then press  key, LCD displays DTMF data and group number (total 16 groups) of current group.

## ◦ SHORTCUT OPERATIONS





2. Rotate channel selector knob to choose desired group and DTMF data, press [PTT] key to transmit selected DTMF signaling. If the current group has no entered DTMF data, the LCD will display the current group number and "EMPTY".
3. When the current group displays "EMPTY", Press  key, the top left corner of the LCD will display " " icon, then press and hold 0 key until you hear a responsive beep to get the transceiver to enter into the DTMF edit state. The LCD now displays " \_\_\_\_\_ ", now you can enter desired DTMF data by keypad.
4. When finished editing, press side key [PF2] to save DTMF signaling.



### ((( Keypad lock

Keypad lock operation can be done by software programming or radio keypad.

#### 1) Radio keypad operation

Press  key, the top left corner of LCD displays "  " icon, then press and hold  key until you hear a responsive beep and the LCD displays "  ". This means the keypad is now locked. Repeat the above procedure and the "  " icon will disappears. The keypad lock function is now off and the keypad is responsive again.

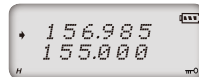
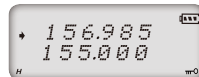

#### 2) Software Programming

**ON:** Keypad lock option tick on.

**OFF:** Keypad lock option tick off.

**NOTE: When keypad lock is turned on by software programming the keypad lock operation is invalid.**

## ◦ SHORTCUT OPERATIONS

### ((( Single-band Switching

To avoid interference from the sub channels when the main channel is in use, you can use the single band function to turn off the sub channel band quickly.

Continuous pressing of **[\* BAND]** will cycle LCD display to show Main + Sub-Band / Sub-Band Only / Main-Band Only.

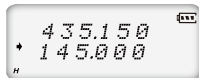

### ((( CTCSS/DCS Encode and decode

1. Press **[A FUNC]** key then press [PF2] to enter into setup.
2. Press [PF2] key to choose CTCSS, DCS or OFF, if you choose DCS, press **[\* BAND]** key to select positive or negative code.
3. Rotate the channel knob to choose your desired CTCSS/DCS encode and decode.
4. Press **[D ESC]** key or **[# BANK]** key to confirm and exit.

### ((( Cross-Band Repeater (TERMN-8R ONLY)

First set the main-band and sub-band to your desired VHF & UHF frequencies, then you are now set to begin the cross band repeater function.



1. Turn the power off on the radio.
2. Press [PF1] and press **[B MAIN]** together and power radio the radio on (while holding both buttons) until the

## ◦ SHORTCUT OPERATIONS

LCD shows "RPT ON". LCD shows the "☑" flashing in the top left corner.

3. Repeat the above operation and the LCD will display "RPT OFF" which means that you have turned off the cross band repeater function.

### ((( NOAA

Under standby, press  key then press  key to enter the NOAA Weather Radio, and then press  key to switch "WE OFF", "WE ON" or "WE ALT".

#### 1. WE OFF:

Weather Radio is OFF, Radio will operate normally

#### 2. WE ON:

(1) Weather Radio is ON, the Radio will only RX Weather

(2) Use the Channel Knob to Rotate through Channel 1–7 to RX the NOAA frequency for your area.

#### 3. WE ALT :

(1) The radio will monitor the chosen NOAA frequency in the background for NOAA Alerts.

(2) Use the Channel Knob to Rotate through Channel 1-7 to select which Frequency to monitor for the alert (use WE ON to determine the correct Channel for your location)

(3) Press the  key, the NOAA mode will replace the sub band frequency and show "NOAA". It will monitor for any NOAA alerts. This allows you to communicate on your main band and still be able to monitor for any NOAA Alerts.







**NOTE: On the OBLTR-8R since it is a semi-duplex radio. It can only monitor one live frequency at a time. The Main and Sub band will be muted if you activate the NOAA ALT. (You can still TX on the main band – but will NOT be able to RX other transmissions in the NOAA ALT Mode).**

**The TERMN-8R since it is a duplex radio – will be able to monitor the main band and NOAA ALT simultaneously.**

## ◦ SHORTCUT OPERATIONS

**NOTE: If the ALT is activated (noted as it will display on your sub-band) – the receiver will automatically turn on the radio when an emergency ALT message is received! The receiver will turn off after 3 minutes – or if it is canceled manually.**

### ((( **MSK (Text) Signal Sending (TERMN-8R ONLY)**







1. When in standby, press  key then press [PF1] key to enter the MSK signal edit function, the LCD will display "\_MSG\_".
2. Turn the channel knob to choose the desired alpha numeric character.
3. Press [PF1] to go to the next character input. Press [PF2] key to go back to the previous character input. You can press the numeric keys to quickly input 0-9, and the next character will automatically be chosen.
4. Once you have chosen your message, press  key, the LCD will display "CAL ID" which will allow you to input the receiver's ID then press  key or [PTT] key to send your message.
5. Alternatively after you have composed your message, press the  key, and the LCD will display "CAL ID" then press  /  key and you can choose: Call All "CAAL" or Group Calling "CAL GR" (which you will need to input the group ID) and then press  key or [PTT] key to send.

**NOTE: Please refer to the MSK ENCODE/DECODE Setup Options to learn more about the basic setup – found in the ADVANCED FUNCTION OPERATIONS.**

### OBLTR-8R

Menu 1-16 of this transceiver are channel operations. Channel operations will temporarily change the functions of the current channel. When the power is off or the channel has been changed, the relevant setup will be erased. Only under VFO mode, will the channel operations will be saved until your next change. Menu 17-48 (menu 35-46 are memory bank setup, please refer to page 89-91) are background operations, and they are valid for all channels, the relevant setup will be saved until next change.

The operating methods are as follows:

1. Press  key, the top left corner of LCD displays "✉" icon, then press  key to enter function menu.
2. Press  /  key to choose desired function.
3. Rotate the channel selector knob to choose desired setting.
4. Press  key or  key to confirm and exit.

**NOTE:** When setting a CTCSS/DCS setting, Press  to select CTCSS, DCS or OFF. When you select DCS press  to switch between positive and inverse codes. When you edit a alpha-numeric name, press  to move to the next character, press  to move to the previous character.

## ○ FUNCTION MENU SETUP(OBLTR-8R)

Menu No.	LCD Display	Function	Options	Description
1	T-CDC	CTCSS/DCS Encode	OFF	No CTCSS/DCS Encode
			62.5HZ-254.1Hz+Self defined	51 groups fixed CTCSS encode+1 group selfdefined encode
			000N-777I	1024 groups DCS Encode
2	R-CDC	CTCSS/DCS Decode	OFF	No CTCSS/DCS Decode
			62.5HZ-254.1Hz+Self defined	51 groups fixed CTCSS decode+1 group selfdefined decode
			000N-777I	1024 groups DCS decode
3	RT-CDC	CTCSS/DCS Encode/Decode Synchronous	OFF	No CTCSS/DCS encode/decode
			62.5HZ-254.1Hz+Self defined	51 groups fixed CTCSS encode/decode + 1 group self-defined CTCSS encode/decode
			000N-777I	1024 group DCS encode/decode
4	5T-ENC	5TONE Encode list	CALL00-99	100 groups 5TONE encode list (programmable by software)
5	2T-ENC	2TONE Encode list	CALL00-31	32 groups 2TONE encode list (programmable by software)
6	TONDEC	Optional signaling setup	DTMF/5TONE/2TONE	Current optional signal is DTMF/5TONE/2TONE

## FUNCTION MENU SETUP(OBLTR-8R)

7	2T-DEC	2TONE Decode list	DEC 00-15	16 groups 2TONE decode list(programmable by software)
8	SIGNAL	Squelch mode setup	SQ	When current channel received matching RF signals, transceiver can hear the talking from the other party.
			CTCSS/DCS	When current channel received matching RF signals and matching CTCSS/DCS signaling, transceiver can hear the talking from the other party.
			TONE	When current channel received matching RF signals and matching optional signaling, transceiver can hear the talking from the other party.
			CT&TO	When current channel received matching RF signals + matching optional signaling + matching CTCSS/DCS signaling, transceiver can hear the talking from the other party.
			CT/TO	When current channel received matching RF signals, or matching optional signaling, or matching CTCSS/DCS signaling, transceiver can hear the talking from the other party.
9	STEP	Frequency step size setup	2.5K-50K	9 options in total
10	W/N	Wide / Narrow Band Selection	25K/12.5K	Wide band/Narrow band
11	REV	Frequency Reverse	ON	Turn on Frequency reverse function, TX and RX frequency of current channel will be interchanged.
			OFF	Close Frequency reverse function



## FUNCTION MENU SETUP(OBLTR-8R)

12	TALKAR	Talk Around	TX=RX	Turn on Talk Around function, current channel will transmit at RX frequency, if CTCSS/DCS signaling is set, it will interchange decoding CTCSS/DCS as encoding.
			OFF	Close Talk Around function.
13	OFFSET	Offset Frequency setup	0-70MHz	Note: It is available to setup in Programming software. RX:UHF, TX:VHF or RX:VHF, TX:UHF
14	NAME	Editing Channel name	a-Z, 0-9	In channel name display mode, will display the edited channel name.
15	RPLOCK	Busy Channel Lockout	BUSY	Carrier wave lock, transmitting is prohibited when received matching carrier wave.
			REPEAT	Signaling lock, transmitting is prohibited when received matching carrier but with mismatching CTCSS/DCS
			OFF	Close BCLO function
16	TX	TX OFF	ON/OFF	TX function is enabled/disabled in current channel.
17	BAND	Single Band Mode (VFO) (VHF/UHF)	ON/OFF	Turn on/off band limit function
18	DSPSUB	(VHF/UHF)	FREQ	Display sub band frequency or channel
			VOLT	Display current battery voltage
			OFF	Sub band display is disabled
19	BEEP	Keypad Voice prompt setup	ON/OFF	Turn on/off keypad voice prompt function

## FUNCTION MENU SETUP(OBLTR-8R)

20	TOT	Time-Out-Timer	OFF	Turn off time-out timer
			1-27MIN	Total 27 levels for optional, each level step 1minute
21	VOX	Voice Operated Transmission (VOX) Setup	OFF	Turn off VOX function
			1--10	Total 10 VOX levels for optional
22	VDELAY	VOX Delay Setup	0.5S-3S	Total 27 levels for optional, each interval is 0.1S
23	APO	Automatic Power Off Setup	OFF	Disable the Automatic power off function
			30MIN-2HOUR	30minutes ~ 2hours: Total 3 levels for optional
24	DTMF	DTMF Transmitting Time	50MS-500MS	Total 5 kinds of DTMF transmitting time for optional.
25	SQL	Squelch level Setup	00-09	10 levels of squelch in total for optional, "00" is minimum setup value (normally open)
26	SCAN	Scanning Resume Time Setup	5ST-15ST	When scanning matched signal, transceiver will stop scanning for 5-15seconds then resume.
			2SP	When scanning matched signal, transceiver will stop scanning, 2seconds after signal disappeared, then resume.
27	SPEED	Scan speed setup	QUICK	Fast Scan
			NORMAL	Normal Scan
28	FTIME	Function Icon Stay Time	FUNCT	When finished function setting or enter into function menu, icon disappeared
			1SEC-3SEC	When finished function setting or enter into function menu, icon stay 1-3seconds then disappeared
			ALWAYS	Function icon is always display, only when pressing function key again, the icon will disappear

## ○ FUNCTION MENU SETUP(OBLTR-8R)

29	LIGHT	LCD Backlight	ON/OFF	Always on/off
			AUTO	Backlight will automatic closed after a period.
30	COLOR	LCD Backlight Color	BLUE/ORG/PUR	Blue/Orange/Purple
31	ID	Self ID inquiry	001/12345	LCD displays radio self ID, DTMF ID is 3 digits. 5STONE ID is 5 digits.
32	TBST	Tone Pulse Frequency Selection	1750Hz/2100Hz /1450Hz/ 1000Hz	Tone plus frequency is 1750Hz/2100HZ/1450Hz/1000Hz
33	SAVE	Battery Save Setup	OFF	Turn off battery save function
			1:2-1:8	Battery save time is 1:2-1:8
			AUTO	Battery save ratio is adjusting automatically
34	RADIO	FM radio	ON/OFF	Allow/Prohibit using FM radio
35	BAK --	Group Selection	0-9	Display current working group
36	BALK	Group linking	OFF	Turn off group linking, menu 37-46 will hide
			ON	Turn on group linking, menu 37-46 will display
37	BLK 1	Link Group 1	OFF/ON	Add or remove the group 1 in group linking
38	BLK 2	Link Group 2	OFF/ON	Add or remove the group 2 in group linking
39	BLK 3	Link Group 3	OFF/ON	Add or remove the group 3 in group linking
40	BLK 4	Link Group 4	OFF/ON	Add or remove the group 4 in group linking
41	BLK 5	Link Group 5	OFF/ON	Add or remove the group 5 in group linking
42	BLK 6	Link Group 6	OFF/ON	Add or remove the group 6 in group linking

## FUNCTION MENU SETUP(OBLTR-8R)







43	BLK 7	Link Group 7	OFF/ON	Add or remove the group 7 in group linking
44	BLK 8	Link Group 8	OFF/ON	Add or remove the group 8 in group linking
45	BLK 9	Link Group 9	OFF/ON	Add or remove the group 9 in group linking
46	BLK 0	Link Group 0	OFF/ON	Add or remove the group 0 in group linking
47	PF1	Self define PF1/ PF2 key function	VOLT	Displays current battery capacity.
			CALL	Call function.
			ALARM	Emergency alarm function
48	PF2		SUBPTT	Sub band PTT
			OFF	No function.
			MONI	Squelch off Momentary or Squelch off function





## ◦ FUNCTION MENU SETUP(TERMN-8R)

### TERMN-8R

Menu 1-17 of this transceiver are channel operations. Channel operations temporarily changed the functions of current channel. When power off or the channel has been changed, the relevant setup will be erased. Only under VFO mode, the channel operations will be saved until next change. Menu 18-52 are background operations (menu 20-29 are memory bank setup, please refer to page 89-91), and they are valid for all channels, the relevant setup will be saved until next change.

The operating methods are as follows:

1. Press  key, the top left corner of LCD displays "✉" icon, then press  key to enter function menu.
2. Press  /  key to choose desired function.
3. Rotate the channel selector knob to choose desired setting.
4. Press  key or  key to confirm and exit.

**NOTE:** When setting a CTCSS/DCS setting, Press  to select CTCSS, DCS or OFF. When you select DCS press  to switch between positive and inverse codes. When you edit a alpha-numeric name, press  to move to the next character, press  to move to the previous character.

## FUNCTION MENU SETUP(TERMN-8R)

Menu No.	LCD Display	Function	Options	Description
1	T-CDC	CTCSS/DCS Encode	OFF	No CTCSS/DCS Encode
			62.5HZ-254.1Hz+Self defined	51 groups fixed CTCSS encode+1 group selfdefined encode
			000N-777I	1024 groups DCS Encode
2	R-CDC	CTCSS/DCS Decode	OFF	No CTCSS/DCS Decode
			62.5HZ-254.1Hz+Self defined	51 groups fixed CTCSS decode+1 group selfdefined decode
			000N-777I	1024 groups DCS decode
3	RT-CDC	CTCSS/DCS Encode/Decode Synchronous	OFF	No CTCSS/DCS encode/decode
			62.5HZ-254.1Hz+Self defined	51 groups fixed CTCSS encode/decode + 1 group self-defined CTCSS encode/decode
			000N-777I	1024 group DCS encode/decode
4	2T-ENC	2TONE Encode list	CALL00-31	32 groups 2Tone encode list(programmable by software)
5	5T-ENC	5TONE Encode list	CALL00-99	100 groups 5Tone encode list(programmable by software)
6	2T-DEC	2TONE Decode list	DEC 00-15	16 groups 2Tone decode list(programmable by software)
7	MSKENC	MSK Encode list	CALL00-31	32 groups MSK encode list(programmable by software)
8	TONDEC	Optional signaling setup	DTMF/5TONE/ 2TONE/MSK	Current optional signal is DTMF/5TONE/2TONE/MSK

## ○ FUNCTION MENU SETUP(TERMN-8R)

9	SIGNAL	Squelch mode setup	SQ	When current channel received matching RF signals, transceiver can hear the talking from the other party.
			CTCSS/DCS	When current channel received matching RF signals and matching CTCSS/DCS signaling, transceiver can hear the talking from the other party.
			TONE	When current channel received matching RF signals and matching optional signaling, transceiver can hear the talking from the other party.
			CT&TO	When current channel received matching RF signals + matching optional signaling + matching CTCSS/DCS signaling, transceiver can hear the talking from the other party.
			CT/TO	When current channel received matching RF signals, or matching optional signaling, or matching CTCSS/DCS signaling, transceiver can hear the talking from the other party.
10	STEP	Frequency step size setup	2.5K-50K	9 options in total
11	W/N	Wide / Narrow Band Setup	25K/12.5K	Wide band/Narrow band
12	REV	Frequency Reverse	ON	Turn on Frequency reverse function, TX and RX frequency of current channel will be interchanged.
			OFF	Close Frequency reverse function.

## FUNCTION MENU SETUP(TERMN-8R)

13	TALKAR	Talk Around	TX=RX	Turn on Talk Around function, current channel will transmit at RX frequency, if CTCSS/DCS signaling is set, it will interchange decoding CTCSS/DCS as encoding.
			OFF	Close Talk Around function.
14	OFFSET	Offset Frequency setup	0-70MHz	Note: It is available to setup in Programming software. RX:UHF, TX:VHF or RX:VHF, TX:UHF
15	NAME	Editing Channel name	a-Z, 0-9	In channel name display mode, will display the edited channel name.
16	RPLOCK	Busy Channel Lockout	BUSY	Carrier wave lock, transmitting is prohibited when received matching carrier wave.
			REPEAT	Signaling lock, transmitting is prohibited when received matching carrier but with mismatching CTCSS/DCS.
			OFF	Close BCLO function.
17	TX	TX OFF	ON/OFF	TX function is enabled in current channel.
18	BAK --	Group Selection	0-9	Display current working group
19	BALK	Group linking	OFF	Turn off group linking, menu 20-29 will hide
			ON	Turn on group linking, menu 20-29 will display
20	BLK 1	Link Group 1	OFF/ON	Add or remove the group 1 in group linking
21	BLK 2	Link Group 2	OFF/ON	Add or remove the group 2 in group linking
22	BLK 3	Link Group 3	OFF/ON	Add or remove the group 3 in group linking
23	BLK 4	Link Group 4	OFF/ON	Add or remove the group 4 in group linking



## ○ FUNCTION MENU SETUP(TERMN-8R)

24	BLK 5	Link Group 5	OFF/ON	Add or remove the group 5 in group linking
25	BLK 6	Link Group 6	OFF/ON	Add or remove the group 6 in group linking
26	BLK 7	Link Group 7	OFF/ON	Add or remove the group 7 in group linking
27	BLK 8	Link Group 8	OFF/ON	Add or remove the group 8 in group linking
28	BLK 9	Link Group 9	OFF/ON	Add or remove the group 9 in group linking
29	BLK 0	Link Group 0	OFF/ON	Add or remove the group 0 in group linking
30	PF1	Self define PF1/ PF2 key function	VOLT	Displays current battery capacity.
			CALL	Call function
			FHSS	Frequency hopping
			ALARM	Emergency alarm function
31	PF2		SUBPTT	Sub band PTT
			OFF	No function
			MONI	Squelch off Momentary or Squelch off function
32	BAND	Single Band Mode (VFO) (VHF/UHF)	ON/OFF	Turn on/off band limit function
33	DSPSUB	Sub band display setup	FREQ	Display sub band frequency or channel
			VOLT	Display current battery voltage
			OFF	Sub band display is disabled
34	BEEP	Keypad Voice prompt setup	ON/OFF	Turn on/off keypad voice prompt function
35	TOT	Time-Out-Timer	OFF	Turn off time-out timer
			10-270S	Total 27 levels for optional, each level step 10seconds.

## ◦ FUNCTION MENU SETUP(TERMN-8R)

36	VOX	Voice Operated Transmission (VOX) Setup	OFF	Turn off VOX function
			1--10	Total 10 VOX levels for optional
37	VDELAY	VOX Delay Setup	0.5S-3S	Total 27 levels for optional, each interval is 0.1S
38	APO	Automatic Power Off Setup	OFF	Disable the Automatic power off function
			30MIN-2HOUR	30minutes ~ 2hours: Total 3 levels for optional.
39	DTMF	DTMF Transmitting Time	50MS-500MS	Total 5 kinds of DTMF transmitting time for optional.
40	SQL	Squelch level Setup of each channel	00-09	10 levels of squelch in total for optional, "00" is minimum setup value (normally open)
41	SCAN	Scanning Resume Time Setup	5ST-15ST	When scanning matched signal, transceiver will stop scanning for 5-15seconds then resume.
			Time Setup	When scanning matched signal, transceiver will stop scanning, 2seconds after signal disappeared, then resume.
42	SPEED	Scan Speed Setup	QUICK	Fast scan speed
			NORMAL	Normal scan speed
43	FTIME	Function Icon Stay Time	FUNCT	When finished function setting or enter into function menu, icon disappeared.
			1SEC-3SEC	When finished function setting or enter into function menu, icon stay 1-3seconds then disappeared.
			ALWAYS	Function icon is always display, only when pressing function key again, the icon will disappear.

## ○ FUNCTION MENU SETUP(TERMN-8R)

44	LIGHT	LCD Backlight	ON/OFF	Always on/off
			AUTO	Backlight will automatic closed after a period
45	COLOR	LCD Backlight Color	BLUE/ORG/PUR	Blue/Orange/Purple
46	ID	Self ID inquiry	001/12345	LCD displays radio self ID, DTMF ID is 3 digits, 5TONE ID is 5 digits.
47	TBST	Tone Pulse Frequency Selection	1750Hz/2100Hz /1450Hz/ 1000Hz	Tone plus frequency is 1750Hz/2100Hz/ 1450Hz/1000Hz
48	SAVE	Battery Save Setup	OFF	Turn off battery save function
			1:2/1:3/1:5/1:8	Battery save time is 1:2/1:3/1:5/1:8
			AUTO	Battery save ratio is adjusting automatically.
49	RADIO	FM radio	ON/OFF	Allow/Prohibit using FM radio.
50	AMSQL	AM Squelch level	Setup 00-09	10 levels of squelch in total for optional
51	SUBVOL	Sub-Radio Volume Setting	1--8	Adjust main band receive, at the same time Sub band output volume
52	MUTE	RPT mute setup	ON	In UV or VU mode, mute the RX sub band when main band is TX.
			OFF	Sub band is not mute when main band is TX.

### CTCSS/DCS Encode Setup

1. Press **[A FUNC]** key, the top left corner of LCD displays "✉" icon, then press **[8 SET]** key to enter into function menu.
2. Press **[B MAIN]** / **[C V/M]** key to choose NO.01 function item, it shows "T-CDC" on LCD.
3. Press **[I FM]** key to choose CTCSS, DCS or OFF, when DCS signaling is selected, press **[\* BAND]** key to choose DCS positive or inverse code.
4. Rotate channel selector knob to choose desired CTCSS/DCS code.

**CTCSS:** 62.5HZ-254.1HZ, 51groups in total, and 1 group user-defined code.

**DCS:** 000N-777I, 1024 groups in total. "N" stands for positive code, "I" stands for inverse code.

5. Press **[D ESC]** or **[# BANK 20]** key to confirm and exit.

**Note:** User-defined CTCSS encode must be setup by programming software.



### CTCSS/DCS Decode Setup

If this function is enabled, you can ignore (can not hear) other unrelated call at the same frequency.

1. Press **[A FUNC]** key, the top left corner of LCD displays "✉" icon, then press **[8 SET]** key to enter into function menu.
2. Press **[B MAIN]** / **[C V/M]** key to choose NO. 02 function item, it shows "R-CDC" on LCD.



## ○ FUNCTION MENU SETUP

3. Press **[I FM]** key to choose CTCSS,DCS or OFF, when DCS signaling is selected, press **[\* BAND]** key to choose DCS positive or inverse code.
4. Rotate channel selector knob to choose desired CTCSS/DCS code.  
**CTCSS:**62.5HZ~254.1HZ,51 groups in total, and 1 group user-defined code.  
**DCS:** 000N-777I, 1024 groups in total. "N" stands for positive code, "I" stands for inverse code.
5. Press **[D ESC]** or **[# BANK]** key to confirm and exit.



**Note: User-defined CTCSS decode must be setup by programming software.**

### ((( CTCSS/DCS Encode/Decode Synchronous Setup

This function is for adjusting CTCSS/DCS encode/decode synchronous.  
(simultaneous changes Menu NO 01 and 02).

1. Press **[A FUNC]** key, the top left corner of LCD displays "✉" icon, then press **[B SET]** key to enter into function menu.
2. Press **[B MAIN]** / **[C V/M]** key to choose NO. 03 function item, it shows "RT-CDC" on LCD.
3. Press **[I FM]** key to choose CTCSS, DCS or OFF, when DCS signaling is selected, press **[\* BAND]** key to choose DCS positive or inverse code.
4. Rotate channel selector knob to choose desired CTCSS/DCS encode/decode.  
**CTCSS:** 62.5HZ~254.1HZ, 51groups in total, and 1 group user-defined code.



## ○ FUNCTION MENU SETUP

*AnyTone*  
tech

**DCS:** 000N-777I, 1024 groups in total. "N" stands for positive code, "I" stands for inverse code.



5. Press or key to confirm and exit.

**Note: User-defined CTCSS decode must be setup by programming software.**

### ((( 5TONE encode group selection

1. Press key, the top left corner of LCD displays "✉" icon, then press key to enter into function menu.



2. Press / key to choose NO.04(OBLTR-8R)/NO.05(TERMN-8R) function item, it shows "5T-ENC" on LCD.

3. Rotate channel selector knob to choose desired 5TONE encode group.

CALL00~CALL99, 100 groups in total for optional.





4. Press [PTT] key to transmit selected 5TONE encode, press key or key to confirm and exit.

**5TONE encode must be programmed by software, only the groups that have edited 5TONE can be selected. When 5TONE encode has a name, transceiver will display name, otherwise will display "CALL XX".**

### ((( 2TONE encode group selection

1. Press key, the top left corner of LCD displays "✉" icon, then press key to enter into function menu.

## ○ FUNCTION MENU SETUP

2. Press  /  key to choose NO.05(OBLTR-8R)/NO.04(TERMN-8R) function item, it shows "2T-ENC" on LCD.
3. Rotate channel selector knob to choose desired 2TONE encode group. CALL00~CALL31, 32 groups in total for optional.
4. Press [PTT] key to transmit selected 2TONE encode, press  key or  key to confirm and exit.







2T-ENC  
CALL00 05

**2TONE encode must be programmed by software, only the groups that have edited 2TONE can be selected. When 2TONE encode has a name, transceiver will display name, otherwise will display "CALL XX".**

## ((( Optional signaling setup

DTMF, 2TONE (Paging), 5TONE, MSK (TERMN-8R Only) functions are similar to CTCSS/DCS, it has special call functions, such as ANI, PTT ID, All call, Alarm, remotely kill, remotely stun and remotely waken, etc. (MSK gives the capabilities of Message sending and FHSS - TERMN-8R Only).

1. Press  key, the top left corner of LCD displays "✉" icon, then press  key to enter into function menu.
2. Press  /  key to choose NO.06(OBLTR-8R)/NO.08(TERMN-8R) function item, it shows "TONDEC" on LCD.
3. Rotate channel selector knob to choose desired optional signaling.



TONDEC  
DTMF 06



TONDEC  
5TONE 06



TONDEC  
OFF 06

**DTMF:** Current optional signaling is DTMF.

**5TONE/2TONE/MSK:** Current optional signaling is 5TONE/2TONE/MSK.

**OFF:** Close optional signaling.

4. Press key or key to confirm and exit.

### ((( 2TONE decode group selection

1. Press key, the top left corner of LCD displays " " icon, then press key to enter into function menu.

2. Press / key to choose NO.07(OBLTR-8R)/NO.06(TERMN-8R) function item, it shows "2T-DEC" on LCD.

3. Rotate channel selector knob to choose desired 2TONE decode group. DEC 00~DEC 15, 16 groups in total for optional (programmed by software).

4. Press key or key to confirm and exit.



### ((( MSK encode group selection(TERMN-8R ONLY)

1. Press key, the top left corner of LCD displays " " icon, then press key to enter into function menu.

2. Press / key to choose NO.07 function item, it shows "**MSKENC**" on LCD.

3. Rotate channel selector knob to choose desired MSK encode group.CALL 00~CALL31, 32 groups in total for optional (programmed by software).



4. Press key or key to confirm and exit.





## ○ FUNCTION MENU SETUP

### ((( Squelch mode setup

This function is used for setting squelch mode to prevent receiving unrelated signals.

1. Press  key, the top left corner of LCD displays "✉" icon, then press  key enter into function menu.

2. Press  /  key to choose NO.08(OBLTR-8R)/NO.09(TERMN-8R) function item, it shows "SIGNAL" on LCD.

3. Rotate channel selector knob to choose desired squelch mode.

**SQ:** When current channel receives matching RF signals, transceiver can hear the talking from the other party.

**CT/DCS:** When current channel receives matching RF signals and matching CTCSS/DCS signaling, transceiver can hear the talking from the other party.

**TONE:** When current channel receives matching RF signals and matching optional signaling, transceiver can hear the talking from the other party.

**CT&TO:** When current channel receives matching RF signals+matching optional signaling + matching CTCSS/DCS signaling, transceiver can hear the talking from the other party.

**CT/TO:** When current channel receives matching RF signals, or matching optional signaling, or matching CTCSS/DCS signaling, transceiver can hear the talking from the other party.

4. Press  key or  key to confirm and exit.



### Frequency step size setup

1. Press **A FUNC** key, the top left corner of LCD displays "✉" icon, then press **B SET** key enter into function menu.
2. Press **B MAIN** / **C V/M** key to choose NO.09(OBLTR-8R)/NO.10(TERMN-8R) function item, it shows "**STEP**" on LCD.
3. Rotate channel selector knob to choose desired step size.  
**Stepping:** 2.5K, 5K, 6.25K, 10K, 12.5K, 20K, 25K, 30K, 50K, 9 options in total.
4. Press **D ESC** key or **# BANK** key to confirm and exit.



**NOTE: This function item will hide automatically when main band and sub main band are under channel mode.**

### Wide / Narrow Band Selection

- According to the laws of various countries on frequency spectrum, you can set communication for (25k) wide band or (12.5k) narrow band.
1. Press **A FUNC** key, the top left corner of LCD displays "✉" icon, then press **B SET** key enter into function menu.
  2. Press **B MAIN** / **C V/M** key to choose NO.10(OBLTR-8R)/NO.11(TERMN-8R) function item, it shows "**W/N**" on LCD.
  3. Rotate channel selector knob to choose desired setup.  
**25K:** Wide band; **12.5K:** Narrow band.
  4. Press **D ESC** key or **# BANK** key to confirm and exit.



## ○ FUNCTION MENU SETUP

### ((( Frequency Reverse

1. Press **A FUNC** key, the top left corner of LCD displays "✉" icon, then press **B SET** key enter into function menu.
2. Press **B MAIN** / **C V/M** key to choose NO.11(OBLTR-8R)/NO.12(TERMN-8R) function item, it shows "REV" on LCD.
3. Rotate channel selector knob to choose desired setup.

**ON:** Turn on Frequency reverse function, TX and RX frequency of current channel will be interchanged. If CTCSS/DCS signaling is set, it also will be interchanged.

**OFF:** Close Frequency reverse function.

4. Press **D ESC** key or **# BACK** key to confirm and exit.



### ((( Talk Around ON/OFF

When this function is is turned on, the transceiver will stop communication with a repeater (it will remove the Offset).

1. Press **A FUNC** key, the top left corner of LCD displays "✉" icon, then press **B SET** key enter into function menu.
2. Press **B MAIN** / **C V/M** key to choose NO.12(OBLTR-8R)/NO.13(TERMN-8R) function item, it shows "TALKAR" on LCD.
3. Rotate channel selector knob to choose desired setup.

**TX=RX:** Turn on Talk Around function, current channel will transmit at RX frequency, if CTCSS/DCS signaling is set, it will interchange decoding CTCSS/DCS as encoding.



**OFF:** Close Talk Around function.

4. Press **[D ESC]** key or **[# BANK]** key to confirm and exit.

### Offset Frequency setup

This function will allow your radio to communicate through a repeater. When the repeater receives signals at one frequency, it will transmit them on another frequency. The difference between these two frequencies is called the offset frequency.

1. Press **[A FUNC]** key, the top left corner of LCD displays "✉" icon, then press **[8 SET]** key enter into function menu.
2. Press **[B MAIN] / [C V/M]** key to choose NO.13(OBLTR-8R)/NO.14(TERMN-8R) function item, it shows "OFFSET" on LCD.
3. Rotate channel selector knob to choose desired offset frequency.  
Frequency range is 00-70MHz.
4. Press **[D ESC]** key or **[# BANK]** key to confirm and exit.



### Editing Channel name





1. Press **[A FUNC]** key, the top left corner of LCD displays "✉" icon, then press **[8 SET]** key enter into function menu.
2. Press **[B MAIN] / [C V/M]** key to choose NO.14(OBLTR-8R)/NO.15(TERMN-8R) function item, it shows "-" on LCD.
3. Rotate channel selector knob to choose desired character, press **[I FM]** key to confirm current character and move shift to next character. Press **[4 +/-]** key back to the previous character.
4. Press **[D ESC]** key or **[# BANK]** key to confirm and exit.



## ○ FUNCTION MENU SETUP

### ((( Busy Channel Lockout

BCLO function is used to prohibit transmitting on a busy channel, it can prevent disturbing other transceivers operating on the same frequency. If you press PTT, the radio will beep as warning and go back to a receiving state.

1. Press  key, the top left corner of LCD displays "✉" icon, then press  key enter into function menu.
2. Press  /  key to choose NO.15(OBLTR-8R)/NO.16(TERMN-8R) function item, it shows "RPLOCK" on LCD.
3. Rotate channel selector knob to choose desired setup.

**BUSY:** Carrier wave lock, transmitting is prohibited when received matching frequency and tone wave.

**REPEAT:** Signal lock, transmitting is prohibited when received matching carrier (frequency) (CTCSS and DCS tones are ignored in this setting).

**OFF:** No BCLO function.

4. Press  key or  key to confirm and exit.



RPLOCK 15  
BUSY



RPLOCK 15  
REPEAT



RPLOCK 15  
OFF







### ((( TX OFF

When this function is on, the [PTT] key is not allowed on the current channel. Current channel of transceiver only works as a receiver and not a transmitter.



TX 16  
ON







## FUNCTION MENU SETUP

1. Press  key, the top left corner of LCD displays "✉" icon, then press  key enter into function menu.
2. Press  /  key to choose NO.16(OBLTR-8R)/NO.17(TERMN-8R) function item, it shows "TX" on LCD.
3. Rotate channel selector knob to choose desired setup.  
**ON:** TX OFF is enabled.  
**OFF:** TX OFF is disabled.
4. Press  key or  key to confirm and exit.



## Single Band Mode (VHF/UHF) (VFO)

When this function is on, inputting frequency or Scanning frequency under VFO is limited in current VFO frequency band.

1. Press  key, the top left corner of LCD displays "✉" icon, then press  key enter into function menu.
2. Press  /  key to choose NO.17(OBLTR-8R)/NO.32(TERMN-8R) function item, it shows "BAND" on LCD.
3. Rotate channel selector knob to choose desired setup.  
**ON:** Band limit is enabled.  
**OFF:** Band limit is disabled.
4. Press  key or  key to confirm and exit.



## ○ FUNCTION MENU SETUP

### ⌘ Sub Band Display Setup

1. Press **A FUNC** key, the top left corner of LCD displays "✉" icon, then press **B SET** key enter into function menu.
2. Press **B MAIN** / **C V/M** key to choose NO.18(OBLTR-8R)/NO.33(TERMN-8R) function item, it shows "DPSUB" on LCD.
3. Rotate channel selector knob to choose desired setup.  
**FREQ:** Display sub band frequency or channel.  
**VOLT:** Display current battery voltage.  
**OFF:** Sub band display is disabled.
4. Press **D ESC** key or **# BANK** key to confirm and exit.



### ⌘ Keypad Voice Prompt Setup

1. Press **A FUNC** key, the top left corner of LCD displays "✉" icon, then press **B SET** key enter into function menu.
2. Press **B MAIN** / **C V/M** key to choose NO.19(OBLTR-8R)/NO.34(TERMN-8R) function item, it shows "BEEP" on LCD.
3. Rotate channel selector knob to choose desired setup.  
**ON:** Keypad Beep Prompt is enabled.  
**OFF:** Keypad Beep Prompt is disabled.
4. Press **D ESC** key or **# BANK** key to confirm and exit.



### Time-Out-Timer (TOT)

The purpose of Time-out-Timer is to restrict the transceiver from accidental long-term transmissions. If the transmission time goes beyond the preset time limit, the transceiver is forced to stop transmitting and warn the user and make a beep sound.

1. Press **[A FUNC]** key, the top left corner of LCD displays "✉" icon, then press **[B SET]** key enter into function menu.
2. Press **[B MAIN]** / **[C V/M]** key to choose NO.20(OBLTR-8R)/NO.35(TERMN-8R) function item, it shows "TOT" on LCD.
3. Rotate channel selector knob to choose desired setup.  
OBLTR-8R: 1~27 minutes, total 27minutes of TOT for optional, each interval is 1minute.  
TERMN-8R:10-270S,total 27 levels for options each level step 10seconds.
4. Press **[D ESC]** key or **[# BANK 20]** key to confirm and exit.



### Voice Operated Transmission (VOX) Setup

When this function is enabled, the transmitting can be started by your voice (generally used with an earpiece), When it is enabled there is no need to press the [PTT] key.

1. Press **[A FUNC]** key, the top left corner of LCD displays "✉" icon, then press **[B SET]** key enter into function menu.
2. Press **[B MAIN]** / **[C V/M]** key to choose NO.21(OBLTR-8R)/NO.36(TERMN-8R) function item, it shows "VOX" on LCD.
3. Rotate channel selector knob to choose desired setup.





## ○ FUNCTION MENU SETUP(VERSION D)

**1~10:** Total 10 VOX levels for optional.



**OFF:** VOX function is disabled.

4. Press  key or  key to confirm and exit.

### ((( VOX Delay Setup

In order to prevent the transceiver from returning back to the receive mode during a VOX initiated call, (which may cause some of the transmission to be missed) the user can set a suitable delay time before the VOX transmission is ended.



1. Press  key, the top left corner of LCD displays "✉" icon, then press  key enter into function menu.

2. Press  /  key to choose NO.22(OBLTR-8R)/NO.37(TERMN-8R) function item, it shows "VDELAY" on LCD.

3. Rotate channel selector knob to choose desired setup.



**0.5S-3S:** Total 27 levels for optional, each interval is 0.1S

4. Press  key or  key to confirm and exit.

### ((( Automatic Power Off Time setup

When this function is on, transceiver will automatic power off when reach the preset time.

1. Press  key, the top left corner of LCD displays "✉" icon, then press  key enter into function menu.

2. Press  /  key to choose NO.23(OBLTR-8R)/NO.38(TERMN-8R) function item, it shows "APO" on LCD.

## ○ FUNCTION MENU SETUP

*AnyTone*  
tech

3. Rotate channel selector knob to choose desired setup.

30minutes ~ 2hours: Total 3 levels for optional.



**OFF:** Automatic Power Off Time is disabled.

4. Press  key or  key to confirm and exit.



## (((DTMF Transmitting Time Setup

1. Press  key, the top left corner of LCD displays "✉" icon, then press  key enter into function menu.

2. Press  /  key to choose NO.24(OBLTR-8R)/NO.39(TERMN-8R) function item, it shows "DTMF" on LCD.

3. Rotate channel selector knob to choose desired setup.

**50MS:** Each DTMF signal transmits 50ms, interval 50ms.

**100MS:** Each DTMF signal transmits 100ms, interval 100ms.

**200MS:** Each DTMF signal transmits 200ms, interval 200ms.

**300MS:** Each DTMF signal transmits 300ms, interval 300ms.

**500MS:** Each DTMF signal transmits 500ms, interval 500ms.

4. Press  key or  key to confirm and exit.



## (((Squelch level setup

This function is used to setup open the squelch of receiving signals, the transceiver will only allow calls

## FUNCTION MENU SETUP

**NOTE: Individual Squelch levels per channel can be set if you have a PF1/PF2 key programmed as Squelch off. While the Squelch is off – turn the channel selector knob which will allow a Per-Channel Squelch change.**

when the receiving signal strength hits a minimum strength clarity, otherwise, the transceiver will remain muted.

1. Press **A FUNC** key, the top left corner of LCD displays "✉" icon, then press **B SET** key enter into function menu.
2. Press **B MAIN** / **C V/M** key to choose NO.25(OBLTR-8R)/NO.40(TERMN-8R) function item, it shows "SQL" on LCD.
3. Rotate channel selector knob to choose desired setup.  
**00-09**: 10 levels of squelch in total for optional, "00" is minimum setup value (normally open).
4. Press **D ESC** key or **# BANK** key to confirm and exit.



## Scanning Resume Time Setup

There are four kinds of scanning dwell time.

1. Press **A FUNC** key, the top left corner of LCD displays "✉" icon, then press **B SET** key enter into function menu.
2. Press **B MAIN** / **C V/M** key to choose NO.26(OBLTR-8R)/NO.41(TERMN-8R) function item, it shows "SCAN" on LCD.
3. Rotate channel selector knob to choose desired setup.



## ○ FUNCTION MENU SETUP

**5ST:** When scanning matched signal, transceiver will stop scanning for 5seconds then resume.

**10ST:** When scanning matched signal, transceiver will stop scanning for 10seconds then resume.



**15ST:** When scanning matched signal, transceiver will stop scanning for 15seconds then resume.

**2SP:** When scanning matched signal, transceiver will stop scanning, 2seconds after signal disappears, scanning will resume.

4. Press  key or  key to confirm and exit.

### ((( Scan Speed

1. Press  key, the top left corner of LCD displays "✉" icon, then press key enter into function menu.

2. Press  /  key to choose NO.27(OBLTR-8R)/NO.42(TERMN-8R) function item, it shows "SPEED" on LCD.

3. Rotate channel selector knob to choose desired setup.

**QUICK:** Fast scan speed.

**NORMAL:** Normal scan speed.





4. Press  key or  key to confirm and exit.



**NOTE:** Fast scan speed may not stop on all signals present. Some weak signals may be skipped.

## ○ FUNCTION MENU SETUP

### ((( Function Icon Stay Time Setup

1. Press  key, the top left corner of LCD displays "✉" icon, then press  key enter into function menu.
2. Press  /  key to choose NO.28(OBLTR-8R)/NO.43(TERMN-8R) function item, it shows "FTIME" on LCD.
3. Rotate channel switch to choose desired setup.

**FUNCT:** After you finish your function setting or enter into function menu, the icon will disappear

**1SEC:** After you finish your function setting or enter into function menu, the icon stay on the display for 1 second and then will disappear.

**2SEC:** After you finish your function setting or enter into function menu, the icon stay on the display for 2 seconds and then will disappear.

**3SEC:** After you finish your function setting or enter into function menu, the icon stay on the display for 3 seconds and then will disappear.

**ALWAYS:** The function icon will always display, only when you press the function key again, will the icon will disappear.

4. Press  key or  key to confirm and exit.

**NOTE:** When the function icon is set to stay, the user can set the desired functions continuously, without a need to press the function key every time.



### LCD Backlight Setup

1. Press **A FUNC** key, the top left corner of LCD displays "✉" icon, then press **8 SET** key enter into function menu.
2. Press **B MAIN** / **C V/M** key to choose NO.29(OBLTR-8R)/NO.44(TERMN-8R) function item, it shows "**LIGHT**" on LCD.
3. Rotate channel selector knob to choose desired setup.  
**AUTO**: Backlight will automatic turn off after a period.  
**OFF**: Always off.  
**ON**: Always on.
4. Press **D ESC** key or **# BANK** key to confirm and exit.



### LCD Backlight Color Setup

There are three backlight colors that you can choose from to be the default color.

1. Press **A FUNC** key, the top left corner of LCD displays "✉" icon, then press **8 SET** key enter into function menu.
2. Press **B MAIN** / **C V/M** key to choose NO.30(OBLTR-8R)/NO.45(TERMN-8R) function item, it shows "**COLOR**" on LCD.
3. Rotate channel selector knob to choose desired setup.  
**BLUE**: Blue backlight.  
**ORG**: Orange backlight.  
**PUR**: Purple backlight.
4. Press **D ESC** key or **# BANK** key to confirm and exit.



## ○ FUNCTION MENU SETUP

### ((( Self ID inquiry

1. Press **A FUNC** key, the top left corner of LCD displays "✉" icon, then press **B SET** key enter into function menu.
2. Press **B MAIN** / **C V/M** key to choose NO.31(OBLTR-8R)/NO.46(TERMN-8R) function item, it shows "ID" on LCD.
3. Rotate channel selector knob to choose desired setup.  
The ID code displaying on LCD is transceiver self ID code.
4. Press **D ESC** key or **# BANK** key to confirm and exit.



**NOTE: When current channel add 5TONE to be optional signaling, LCD displays 5TONE self ID code, otherwise displays DTMF self ID code.**

### ((( Tone Pulse Frequency Selection

This function is used for waking up a repeater that requires a tone burst. You will need to know if your repeater requires a tone burst and the tone required. In general, as long as the repeater has been activated, there is no need to transmit the Tone Pulse again until a preset time has expired.

1. Press **A FUNC** key, the top left corner of LCD displays "✉" icon, then press **B SET** key enter into function menu.
2. Press **B MAIN** / **C V/M** key to choose NO.32(OBLTR-8R)/NO.47(TERMN-8R) function item, it shows "TBST" on LCD.
3. Rotate channel selector knob to choose desired setup.  
1750HZ, 2100HZ, 1450HZ, 1000HZ - These are the 4 settings you can set as required by your local repeater.
4. Press **D ESC** key or **# BANK** key to confirm and exit.



### ((( Battery Save Setup

You can set a battery save ratio according to your requirements. The standby time can be extended if you enable the battery save function, but if you set the ratio setting too high, it may cause you to miss the beginning of a transmission. When the transceiver receives a matching signal or make start an operation it will automatically exit this function.

1. Press **[A FUNC]** key, the top left corner of LCD displays "✉" icon, then press **[8 SET]** key enter into function menu.



2. Press **[B MAIN]** / **[C V/M]** key to choose NO.33(OBLTR-8R)/NO.48(TERMN-8R) function item, it shows "SAVE" on LCD.



3. Rotate channel selector knob to choose desired setup.

**OFF:** Battery Save is disabled.

**1:2:** The standby time between normal working state and battery saving mode is 1:2

**1:3:** The standby time between normal working state and battery saving mode is 1:3

**1:5:** The standby time between normal working state and battery saving mode is 1:5

**1:8:** The standby time between normal working state and battery saving mode is 1:8

**AUTO:** Battery save ratio is adjusting automatically.



4. Press **[D ESC]** key or **[# BAND]** key to confirm and exit.







**Suggestion:** If you use your radio in a single band set-up (UHF or VHF ), the recommended setup is 1:8. If you use your radio in a dual band set-up (UHF and VHF), the recommended setup is 1:2.



## ○ FUNCTION MENU SETUP

### ((( FM radio





FM Radio Mode allows listening to FM Broadcast stations.

1. Press  key, the top left corner of LCD displays "✉" icon, then press  key enter into function menu.
2. Press  /  key to choose NO.34(OBLTR-8R)/NO.49(TERMN-8R) function item, it shows "RADIO" on LCD.
3. Rotate Selector Knob to choose desired setup.  
**ON:** FM Radio Mode is enabled.  
**OFF:** FM Radio Mode is disabled.
4. Press  key to dismiss or  key to confirm and exit.



**NOTE: Only when this function is setting ON, can the FM radio be used.**

### ((( FM Radio Functions

1. Press  +  to turn on FM Radio. Press again to turn off. ON/OFF cycle of radio will end FM Radio reception. Also when FM Radio is on, quick press of  key will mute / un-mute FM Radio.
2. FM Radio activates in either VFO Mode and Channel Mode. In Channel Mode, LCD shows received frequency with saved channel number to right hand side. In VFO Mode, only received frequency will show. Press  to cycle between these two modes.
3. Depending on mode, the keypad can be used to directly enter the number of a saved channel or the

frequency of a desired FM Broadcast station.

4. Depending on mode, rotating Selector Knob will step through saved channels or through VFO frequencies.
5. Press **[A FUNC]** + **[S SCAN]** to scan FM frequencies. Press **[D ESC]** to end scan when desired station is found.
6. TERMN-8R ONLY: Use **[A FUNC]** + **[\* BAND]** to Switch RX Bands - FM/AM (Aircraft)/SW/LW (AM Radio).







### ((( PF1 key Function Setup

1. Press **[A FUNC]**, the top left corner of LCD display "✉" icon, then press **[B SET]** key to enter into function menu.
2. Press **[B MAIN]** / **[C V/M]** key to choose NO.47(OBLTR-8R)/NO.30(TERMN-8R) function item, it shows "PF1" on LCD.
3. Turn channel switch to choose desired setup.
  - VOLT:** Display current battery voltage.
  - CALL:** Calling.
  - FHSS:** Frequency hopping
  - ALARM:** Emergency alarm.
  - SUBPTT:** Sub band PTT
  - MONI:** Squelch off Momentary or Squelch off function
  - OFF:** Close the key function.
4. Press **[D ESC]** or **[# BANK]** to confirm and exit.



## ○ FUNCTION MENU SETUP(TERMN-8R)

### ((( PF2 key Function Setup

- 1.Press , the top left corner of LCD display "  " icon, then press  key to enter into function menu.
- 2.Press  /  key to choose NO.48(OBLTR-8R)/NO.31(TERMN-8R) function item, it shows "**PF2**" on LCD.
- 3.Turn channel selector knob to choose desired setup.  
**VOLT:** Display current battery voltage.  
**CALL:** Calling  
**FHSS:** Frequency hopping  
**ALARM:** Emergency alarm.  
**SUBPTT:** Sub band PTT  
**MONI:**Squelch off Momentary or Squelch off function  
**OFF:** Close the key function.
- 4.Press  or  to confirm and exit.



### ((( AMSQL(TERMN-8R ONLY)

When the AM Radio is on,we can setup the squelch level for receiving signals, the transceiver will hear calls when receiving signal is stronger than the selected squelch level, otherwise, transceiver will keep mute.

- 1.Press , LCD shows "  " icon, then press  to enter into function menu.



## ◦ FUNCTION MENU SETUP(TERMN-8R)

2. Press **[B MAIN]** / **[C V/M]** o choose No.50 function item, it shows "**AMSQ**" on LCD.
3. Turn channel knob to select your desired setting.  
Total is 10 SQL levels for choice.
4. Press **[D ESC]** or **[# BANK]** to confirm and exit.

## ((( Sub-Radio Volume Setting(TERMN-8R ONLY)

Because of the duplex option - when your main band and sub band both receive a signal at the same time, you can set the sub band volume to be adjusted quieter to avoid confusion.

1. Press **[A FUNC]**, LCD shows "✉" icon, then press **[B SET]** to enter into function menu.
2. Press **[B MAIN]** / **[C V/M]** to choose NO.51 function item, it shows "**SUBVOL**" on LCD.
3. Turn channel knob to select your desired setting.  
Total is 8 volume levels for choice.
4. Press **[D ESC]** or **[# BANK]** to confirm and exit.







## ((( Mute Setup (TERMN-8R ONLY)

Because of the Duplex option - when you are In UV or VU mode, when one band RX, and you are TX on the other band, turn on this function to mute the speaker of RX band. (When you transmit it will restrict incoming signals). The radio will automatically mute the incoming signal when you are in UU or VV.

1. Press **[A FUNC]** key, LCD shows "✉" icon, then press **[B SET]** key to enter into function menu.



## ○ FUNCTION MENU SETUP (TERMN-8R)

2. Press  /  key to choose NO.52 item, LCD displays "**MUTE**".
3. Rotate channel switch to choose desired setup.  
ON: Mute RX when TX.  
OFF: Not mute RX when TX.
4. Press  key or  key to confirm and exit.

## ADVANCED FUNCTION OPERATIONS

### Display Mode Setup

There are three kinds of display (user) modes.

1. Press [PF2] key as you turn on the radio, continue holding the [PF2] key until the transceiver emits a beep.
2. Press **B** / **C** key to choose No.01 function item, it shows "DSP" on LCD.
3. Rotate channel switch to choose desired setup.

**FREQ:** Frequency+Channel mode, transceiver displays current channel number + frequency, press **C** key to switch into VFO mode.

**CH:** Channel mode (for commercial use), 1~24 items of function menu will be disabled, the user can only operate some functions. The VFO Mode is disabled. With this mode, radio can be used as commercial radio.

**NAME:** Channel+Name Tag mode, transceiver displays current channel number +channel name, press **C** key to switch into VFO mode.

4. Press **D** key or **#** key to confirm and exit.







**NOTE: The display mode will can not switch to other mode when transceiver in GMRS/MURS mode.**

### Resume Factory Default

You can make all the settings of transceiver return back to the factory default settings when the transceiver does not work normally (possible due to bad settings)

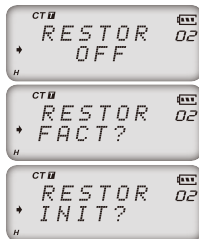

## o ADVANCED FUNCTION OPERATIONS

1. Press [PF2] key to turn on radio, hold [PF2] key until transceiver emits beep.
2. Press  /  key to choose No.02 function item, it shows "RESTOR" on LCD.
3. Rotate channel switch to choose desired setup.  
**OFF:** No operations.  
**FACT:** Resume all items to factory default, including channel and background settings.  
**INIT:** Resume background settings to factory default, channel operations are keeping.
4. Press  key to exit current selection.
5. Press  key to confirm current selection.



### ((( Public Usage Frequency Mode (FCC Part 95)

There are three kinds of modes for optional. NORMAL ,GMRS and MURS.

1. Press [PF2] key as you turn on the radio, continue holding the [PF2] key until the transceiver emits a beep.
2. Press  /  key to choose No.03 function items, it shows "PART95" on LCD.
3. Rotate channel switch to choose desired setup

**NORMAL:**Normal channel mode

**GMRS:**General Mobile Radio Service .The General Mobile Radio Service (GMRS) is a licensed radio service that uses channels around 462 MHz and 467 MHz, The most common use of GMRS channels is for short-distance, two-way communications using hand-held radios similar to walkie-talkies.

## ◦ ADVANCED FUNCTION OPERATIONS

**MURS:**Multi-Use Radio Service .The Multi-Use Radio Service (MURS) uses channels in the 151 – 154 MHz spectrum range. The most common use of MURS channels is for short-distance, two-way communications using small, portable hand-held radios that function similar to walkie-talkies.

4. Press  or  key to confirm current selection.

### **NOAA and FM Radio Note:**

NOAA and FM Radio will function the same as normal in the GMRS/MURS mode.Please refer to how to use these additional functions in the user manual.

### **NOTE GMRS Repeaters:**

The channels that are labeled "REPT" run through repeaters that are set up for GMRS usage. Use these channels if you have permission from those that run your local repeater for GMRS channels.

### **NOTE GMRS and MURS:**

Most frequency modifying operations are not available in GMRS or MURS (you can still set scanning options and background function menu operations). You can scan for CTCSS and DCS tones and set signaling as needed.

### **NOTE GMRS LICENSE:**











The radio operates on the General Mobile Radio Service (GMRS) frequencies when using GMRS Channels. You must have a GMRS license issued by the Federal Communications Commission to legally use these channels. For licensing information and application forms, visit the FCC online at: [www.fcc.gov/wtb/uls](http://www.fcc.gov/wtb/uls) or call the FCC hotline at 1-800-418-3676. If you have any questions, you can contact the FCC direct at 1-888-225-5322.











## ◦ ADVANCED FUNCTION OPERATIONS

### ((( Programming a Duplex Channel Example

This example is for: 146.700MHz 600kHz minus offset into channel 99 CTCSS tone 123.0 (optional).

1. Set radio to VFO Mode (Frequency Mode)
  - a.) Press  button switch VFO/MR
2. Select Display A (select the Upper Display)
  - a.) Press  button and select the Upper Display.
3. Disable TDR (Dual Watch/Dual RX) which toggles between A and B
  - a.) press  button switch between A and B
4. Enter RX frequency
  - a.) Enter 1/4/6/7/0/0 or enter 1/4/6/7/#
5. Set 600kHz offset
  - a.) Press  button and then press  button
  - b.) Press  /  button select Menu NO.13(OBLTR-8R)/NO.14(TERMN-8R) OFFSET
  - c.) Rotate channel switch to set 600kHz offset
  - d.) Press  exit Menu
6. Offset Frequency Direction Setup
  - a.) Press  button and then press  button
  - b.) LCD display "-" icon. Minus offset is settled.
7. Set CTCSS or DCS codes for Transmit. (if needed) ( example = CTCSS TX tone 123.0Hz )

## ◦ ADVANCED FUNCTION OPERATIONS

- a.) Press  button and then press PF2 button
  - b.) Press  or PF2 button to choose CTCSS, DCS or OFF, when DCS signaling is selected, press  button to choose DCS positive or inverse code
  - c.) Rotate channel switch to select 123.0HZ,when CTCSS display 88.5HZ(default )
  - d.) Press  exit menu
8. Store Memory Channel 99
- a.) Press  button and then press  button
  - b.) Rotate channel switch to select Channel 99
  - c.) Press  button and then press and hold  button
  - d.) Press  to MR mode and check Channel 99 (enter 0/9/9 to select Channel 99)
9. The split is now programmed.

### ((( Optional Signaling (DTMF)

Users can enable or disable the "Optional Signaling" in each channel by programming software. DTMF tones are similar to CTCSS/DCS tones and can be used in conjunction with them. You can set the squelch level to require DTMF and/or CTCSS/DCS. DTMF tones can also allow for Selective Calling, Group Calling, All Call, PTT ID, Remotely Stun, Remote Kill and Remote Waking.

1. PTT ID (ANI): If you set your current channel to transmit your PTT ID, the transceiver will send its transmitting ID by pressing or releasing the PTT key according to how you set it up.
2. If you decide to assign radios to groups with DTMF tones - You can set a group call "wildcard" for each group by programming software. (DTMF character A, B, C, D, "\*" or "#").

## o ADVANCED FUNCTION OPERATIONS

a. The caller can call different groups by sending different group call codes. When the receiving party receives a valid ID code, wildcard characters can replace one or all of the characters and the receiving party can: call all, group call, or selectively call. It is easy and flexible to utilize DTMF tones.

**For example:**

**Group code: "C"**

	<b>Radio A</b>	<b>Radio B</b>	<b>Radio C</b>	<b>Radio D</b>
<b>ID Code</b>	123	223	235	355

If the calling party uses "C23" to call, Radio A and Radio B will receive the call.

If the calling party uses "CC5" to call, Radio C and Radio D will receive the call.

If the calling party uses "CCC" to call, All Radios will receive the call.

3. This transceiver is set with 16 groups of DTMF codes (you can individually set what the programmed "CALL" (PF1/PF2) does for each channel)
4. Remote Stun, Remote Kill and Remote Wake.
  - a. Remote Stun: When the radio receives the DTMF that will "Remote Stun" it - it can no longer transmit and will receive only.
  - b. Remote Kill: When the radio receives the DTMF that will "Remote Kill" it - it can no longer transmit or receive.
  - c. Remote Wake: The only way to bring a radio out of 'Remote Kill' or 'Remote Stun' is by special dealer programming software --- or you can wake it by sending the 'Remote Wake' DTMF tone. The 'Remote Wake' DTMF tone is activated by: sending the original DTMF 'Kill/Stun' Code + the '#'  
Tone.

## ◦ ADVANCED FUNCTION OPERATIONS

**NOTE: Radios must be set up to 'Decode' optional signaling (DTMF), otherwise they will ignore the DTMF tones being received.**

### ((( **2TONE Calling**

Two-tone sequential, also known as 1+1, is a selective calling method (2 Tones received to set off the pager function). Many companies have their own names for two-tone sequential options. General Electric Mobile Radio ® called it Type 99. Motorola ® called it Quik-Call II. For example, the encoder sends a single tone followed by 50 to 1,000 milliseconds of silence and then a second tone.[3] Decoders look for a valid first tone followed by a valid second tone. If no valid second tone is decoded within 2 seconds, the decoder resets and waits for another valid first tone.

To set up the 2TONE needed to encode (send) or decode (receive) you need to set it up through programming software. You can set up to 32 Encode options and 16 Decode.

**NOTE: To set your radio to open for calls only after receiving a 2TONE sequence – set up the channel decode option as needed – and then apply it to the frequency needed. YOU WILL NEED TO SET THE SQUELCH MODE AS "OPTIONAL SIGNALING" to receive the call. Refer to "Function Menu Setup – Squelch mode setup" for more details.**

**NOTE: Radios must be set up to 'Decode' optional signaling (2TONE), otherwise they will ignore the 2TONE tones being received.**

## ◦ ADVANCED FUNCTION OPERATIONS

### (((Optional signal (5TONE)

Users can set the "Optional Signaling" as 5Tone in each channel by programming software. 5Tone has similar functions to CTCSS/DCS and DTMF, it allows for Selective Calling, Group Calling, All Call, PTT ID, Remote Stun, Remote Kill, Data Transmission (Text), Alarm, ANI etc.

First setup your radios encode (sending) and decoding (receiving) options on your radio via programming software

1. Selective Calling: Call the receiver's self ID directly – If you set up an encode memory to call another user directly (their 5 Digit PTTID encode) you can Access the 5TONE encode menu (NO.04(OBLTR-8R)/NO.05(TERMN-8R)) to choose your saved signaling (Memory Group) then press PTT key. Receiver can hear the calling after receive matching ID. (According to how they have their Squelch setup (see Squelch options))
2. Group Calling/ All Call: Call by Group or Call All ID – To Group Call (or Call All) you need to use a Wild Card Character: A – to repeat Characters (In this case the wild card character) you use the Repeat Character: E.

Replace one of the 5 Digits of the Encode setup with the Wild Card Character (A) to call by group. after the receiver receive 5Tone encode. If you set up an encode memory to call by group/all (their 5 Digit PTTID encode) you can Access the 5TONE encode menu (NO.04(OBLTR-8R)/NO.05(TERMN-8R)) to choose your saved signaling (Memory Group) then press PTT key. Receiver/s can hear the calling after receive matching ID. (According to how they have their Squelch setup (see Squelch options))

**Example:**

## ◦ ADVANCED FUNCTION OPERATIONS

	Radio A	Radio B	Radio C	Radio D	Radio E
ID Code	78125	79225	68125	69225	65125

If the calling party uses "A8125" to call, Radio A and Radio C will receive the call.

If the calling party uses "AE125" to call, Radio A, Radio C and Radio E will receive the call.

If the calling party uses "7AE25" to call, Radio A and Radio B will receive the call.

If the calling party uses "6AEA5" to call, Radio C, Radio D and Radio E will receive the call.

If the calling party uses "AEAEA" to call, All Radios will receive the call.

**NOTE: You can also set up a custom group not dependent on the user's ANI/Self ID. Under the Information ID section – set up a Decode option for your Group's 5TONE decode. (Example: 12345, 45676543, etc...)**

3. This transceiver can set desired PTT ID by programming software, when you press Call using 5TONE the channel set PTT ID, the transceiver will transmitting ID by pressing or releasing the PTT key (it will default to your selected "SELF ID"). You can also initiate a "Special Call" PTTID which (depending on the receiver's squelch set up) will only display your ID on the receivers display without opening the squelch.
4. Remote Stun, Remote Kill and Remote Wake (this is found in your 5TONE Decode (Receive) Options via programming software)
  - a. Remote Stun: When the radio receives the 5TONE that will "Remote Stun" it - it can no longer transmit and will receive only.
  - b. Remote Kill: When the radio receives the 5TONE that will "Remote Kill" it - it can no longer transmit or receive.

## ◦ ADVANCED FUNCTION OPERATIONS

- c. Remote Wake: Set the 5TONE wake code by programming software, the only way to bring a radio out of 'Remote Kill' or 'Remote Stun' is by receiving the 5TONE wake code.
- 5. Data transmission: You can setup 5TONE Messages to be sent by your 5TONE Encode Function. You need to pre-set up the receiver (by ID or Group) and the message to be sent – so you can access it from 5TONE encode menu (NO.04(OBLTR-8R)/NO.05(TERMN-8R)).
- 6. Emergency alarm: It will turn on alarm function after transceiver receive matching encode
- 7. ANI: It is show the other party's ID if your transceiver receive ANI call. It will also display the caller's name when you have the caller's name set up in programming software.
  - a. To set up a contact list find it under "Communication Note" – and set the values for the ID and corresponding name. It will show the other party's name when they use ANI or Special Call PTTID. Example: You could set up "35356" as "Andy".
- 8. The transceiver can program and save 100 groups of 5Tone encode,.

**NOTE:When you use 5Tone, the receiver and sender must use same encode method. (Selectable by software)  
Such as: The sender use ZVEI1, the receiver must use ZVEI1.**

**NOTE:Radios must be set up to 'Decode' optional signaling (5TONE), otherwise they will ignore the 5TONE tones being received. The 5TONE self ID has to be 5 digits and you should avoid repeating 'characters' when setting your self ID. If you do repeat characters, the repeated character will be replaced by "E". Example: If your ID is '21125' – it will actually be '21E25'.**

### ((( Communication Note (Caller ID/PTTID List) (ANI)

Use the programming software to setup a database of Names and PTTIDs. When a PTTID /ANI is received and matches a name in your contact list – it will display the coordinating alpha numeric “Name” instead of the ANI/PTTID.

### ((( MSK ENCODE / DECODE and FHSS-Frequency Hopping (TERMN-8R ONLY)

1. Program PF1/PF2 to operate the FHSS Function
2. From your programming software or the radio insure that you set your optional signaling as MSK (and choose the MSK decode needed for your channel)
3. From the Programming Software - Program your Encode and Decode Information.

**NOTE: DECODE TIPS: Each radio should have a different Self ID. You can also set up groups IDs (which should be the same on radios that are in the same 'group')**

**NOTE: ENCODE TIPS: You can set your encode groups to call by: ALL, Group (Set it to call the Group ID needed), Individual (Set it to call the Individual PTT ID Needed). The Information Code will tell others who you are (a name or call sign is common). The Name field is so you can set a Name for the New MSK Call you just set up.**

**NOTE: When you set an encode memory for your radio – you can also set a message default in the "information field" to send to the selected receivers. You can send the preset "encode" functions from the Function Menu (refer to Function Menu – MSK)**



## ◦ ADVANCED FUNCTION OPERATIONS

4. Set up your frequency hopping. When you set a frequency it will have a frequency within 1 Mhz of the base frequency. (Insure it is the same frequency on the radios you want to communicate on via FHSS).
5. Ensure that the Encode and Decode information you want is correct and double check the decode MSK group you set up.
6. You can now activate FHSS by the PF1/PF2 button you have set up and securely communicate on a randomized frequency with your party.

**NOTE: Radios must be set up to 'Decode' optional signaling (MSK), otherwise they will ignore the MSK tones being received.**

### ((( Cloning Cable

This feature will copy the programmed data and parameters from the master unit to slave units. It copies the parameters and memory program settings.

Connection: Use optional CP04 cloning cable, connect Read/write frequency port on both master and slave, setting and programing as the requirement below.

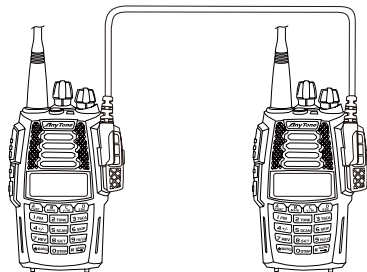

[Settings: Master side]

1. Press the [PF1] side key to Power on, the display shows "CLONE", the master unit enters into copy mode .
2. Press [PF1] key, the display appears "CLONE XX" XX stands for the data amount being cloned.
3. When the data transfer is completed, slave unit restarts, the master unit displays "CLONE 04".
4. Master unit will remain in the cloning mode to prepare for the next cloning session, if you reboot the master radio - it will exit the cloning mode and return back to the normal mode.

CLONE

CLONE  
A5

CLONE  
04

## o ADVANCED FUNCTION OPERATIONS

[Settings: Slave side]

1. In the standby mode, when the slave receives the data, the display shows "CLONE XX" XX stands for the data being cloned.
2. When data reception is complete, the slave unit returns to normal mode and restarts automatically.
3. Turn off the slave's power, remove the cable, insert another slave that you want to copy.



CLONE  
A5



If the data is not successfully transmitted, turn off the master and slave, check if the cable connections are correct, and then repeat the whole process again.

## ○ MEMORY BANK

**Memory Bank Basics:** There are 10 memory banks 0-9 that are available for the OBLTR-8R/TERMN-8R. Bank 0 includes all edited channels (all channels are in Bank 0).



Bank 1-9 can be assigned maximum 32 channels, a channel can be assigned to more than 1 group by either software programming or the radio itself.

### Assign channel to memory bank:



1. In Memory channel mode, choose a memory channel, press  key, bank number show in the channel number position as "-X" flashing.
2. Turn Channel selector knob to choose desired memory bank, press  key, the memory channel will be assigned to the bank.
3. If the bank already has 32 channels, the new assigned channel will replace the last channel in bank.





### Remove a channel from memory bank:

While you are in a memory bank, choose a memory channel (that you want to remove from the bank). Press  key and then press  key. then rotate the channel selector knob clockwise to confirm removal from the memory bank.

## 📡 Memory Bank Switch

In Channel mode, press  key twice to enter memory bank mode, press  key then press  key to enter into function menu.

1. Press  /  key to choose menu 35(OBLTR-8R )/18(TERMN-8R), LCD show "BAK--".
2. Turn Channel switch to choose bank 0--9, press  key confirm
3. Rotate the channel switch clockwise to enter into desired memory bank.





## ○ MEMORY BANK

**Note:** When the bank linking is on, if no channel in the selected bank, radio will enter into the next linking bank. When the bank linking is off, if no channel in the selected bank, current channel will be assigned to this bank.

### ((( Memory Bank Exit

When transceiver in memory bank mode, press  key twice to exit and return to channel mode.

### ((( Bank linking

In channel mode, press  key twice to enter into memory bank mode, press  key then press  key to enter into function menu.

Press  /  key to choose menu36(OBLTR-8R )/19(TERMN-8R), LCD show "BALK".

**ON:** Turn on Bank linking.

The following menus allow adding or deleting banks.

OBLTR-8R	TERMN-8R	LCD display	Funtion	Option
Menu37	Menu20	BLK1	Link Group 1	OFF/ON
Menu38	Menu21	BLK2	Link Group 2	OFF/ON
Menu39	Menu22	BLK3	Link Group 3	OFF/ON
Menu40	Menu23	BLK4	Link Group 4	OFF/ON
Menu41	Menu24	BLK5	Link Group 5	OFF/ON
Menu42	Menu25	BLK6	Link Group 6	OFF/ON
Menu43	Menu26	BLK7	Link Group 7	OFF/ON
Menu44	Menu27	BLK8	Link Group 8	OFF/ON
Menu45	Menu28	BLK9	Link Group 9	OFF/ON
Menu46	Menu29	BLK0	Link Group 10	OFF/ON



## ◦ MEMORY BANK

**OFF:** Turn off Bank linking, hide menu 37-46(OBLTR-8R)/20-29(TERMN-8R).

When bank linking is on, one or more banks can be added into scan list. In memory bank mode, enable the scanning function, transceiver will scan the channels in current bank. During scanning, long pressing key 0-9 will add or delete the corresponding memory bank.

**NOTE: If you have BLK0 on in Bank linking, all channels will be scanned. It is recommended to only scan certain memory banks that you remove BLK0 from your Bank linking.**

## ○ Programming software starting (Takes Windows XP system for example)

**AnyTone**  
We only do best radio!

1. Double Click "OBLTR-8R/TERMN-8R.exe", then follow through with the installation.
2. Please plug the programming cable into the USB port of the PC device, then connect to transceiver. (A Genuine FTDI cable from **AnyTone** tech is recommended)
3. Double click "OBLTR-8R/TERMN-8R" shortcut icon, or click OBLTR-8R/TERMN-8R item in "START" menu to open programming software interface.
4. Choose your "COM Port", then click "OK" to start programming software. (the COM Port number can be found under device manager, it will display by the cable driver).

**NOTE: When moving the programming cable to a different USB port, the COM port assignment will change.**

Before programming, insure that your transceiver is powered on. Do not turn on or turn off the transceiver when it is connecting with computer, otherwise it may cause the transceiver not to properly read or write data. If this situation has happened, please shut down the programming software, remove programming cable from the computer. Then re-plug the cable into the computer, re-start the programming software, re-choose the COM Port, and the programming should work normally.

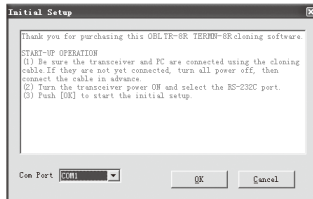

(picture 1)

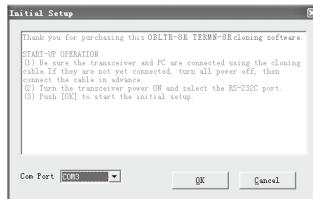

(picture 2)

**NOTE: The programming software has an automatic product identifying system. In order to run it for the first time, the transceiver should be connected to computer, otherwise the software can not run.**

## TECHNICAL SPECIFICATION

General			
Frequency Range	OBLTR-8R	USA version(FCC market)	European Version(CE market)
		VHF:136~174MHz UHF:400~480MHz(Ex:400~520MHz) FM:76~108MHz(RX)	VHF:144~146MHz UHF:430~440MHz FM:76~108MHz(RX)
	TERMN-8R	VHF:136~174MHz UHF:400~480MHz(Ex:400~520MHz)	VHF:144~146MHz UHF:430~440MHz
		FM:64~108MHz(RX) AM: 108~136M Hz(RX) SW: 2.3~29.99MHz(RX) LW: 0.52~1.71MHz(RX)	
Channel Capacity	200 channels		
Channel Spacing	25KHz (wide band) 12.5KHz (narrow band)		
Phase-locked Step	0.1KHz		
Operation Voltage	7.4V DC $\pm$ 20%		
Battery Life	More than 18 Hours(2200mAh), by 5-5-90 working cycle		
Frequency Stability	$\pm$ 2.5ppm		
Operation Temperature	-20 $^{\circ}$ C~ +55 $^{\circ}$ C		
Size	123 $\times$ 66 $\times$ 39mm (with battery)		
Weight	285g (with battery, antenna, belt clip)		



## TECHNICAL SPECIFICATION

Receiving Part		
	Wide band	Narrow band
Sensitivity (12dB SINAD)	$\leq 0.25\mu\text{V}$	$\leq 0.35\mu\text{V}$
Adjacent Channel Selectivity	$\geq 65\text{dB}$	$\geq 60\text{dB}$
Intermodulation	$\geq 60\text{dB}$	$\geq 60\text{dB}$
Spurious Rejection	$\geq 70\text{dB}$	$\geq 70\text{dB}$
Hum & Noise	$\geq 45\text{dB}$	$\geq 40\text{dB}$
Audio Distortion	$\leq 5\%$	
Audio Power Output	1000mW/10%	

Transmitting Part		
	Wide band	Narrow band
Power Output	VHF:6W/2W/1W	UHF:5W/2W/1W
Modulation	16K $\Phi$ F3E	11K $\Phi$ F3E
Adjacent Channel Power	$\geq 65\text{dB}$	$\geq 60\text{dB}$
Hum & Noise	$\geq 40\text{dB}$	$\geq 40\text{dB}$
Spurious Emission	$\leq -36\text{dB}$	$\leq -36\text{dB}$
Audio Distortion	$\leq 5\%$	

## ◦ TECHNICAL SPECIFICATION

GMRS FREQUENCY CHART (MHz)						
CH. No	CH. Freq.	CH. No	CH. Freq.	CH. No	CH. Freq.	Offset
<b>GMRS01</b>	462.5625	<b>GMRS15</b>	462.5500	<b>REPT15</b>	462.5500	+5.0000
<b>GMRS02</b>	462.5875	<b>GMRS16</b>	462.5750	<b>REPT16</b>	462.5750	+5.0000
<b>GMRS03</b>	462.6125	<b>GMRS17</b>	462.6000	<b>REPT17</b>	462.6000	+5.0000
<b>GMRS04</b>	462.6375	<b>GMRS18</b>	462.6250	<b>REPT18</b>	462.6250	+5.0000
<b>GMRS05</b>	462.6625	<b>GMRS19</b>	462.6500	<b>REPT19</b>	462.6500	+5.0000
<b>GMRS06</b>	462.6875	<b>GMRS20</b>	462.6750	<b>REPT20</b>	462.6750	+5.0000
<b>GMRS07</b>	462.7125	<b>GMRS21</b>	462.7000	<b>REPT21</b>	462.7000	+5.0000
		<b>GMRS22</b>	462.7250	<b>REPT22</b>	462.7250	+5.0000

NOAA FREQUENCY CHART (MHz)	
CH. NO	CH. Freq.
<b>WX 1</b>	162.5500
<b>WX 2</b>	162.4000
<b>WX 3</b>	162.4750
<b>WX 4</b>	162.4250
<b>WX 5</b>	162.4500
<b>WX 6</b>	162.5000
<b>WX 7</b>	162.5250

MURS FREQUENCY CHART (MHz)		
CH. No	CH. Freq.	CH. Name
<b>MURS1</b>	151.8200	
<b>MURS2</b>	151.8800	
<b>MURS3</b>	151.9400	
<b>MURS4</b>	154.5700	Blue Dot
<b>MURS5</b>	154.6000	Green Dot

## ◦ TROUBLE SHOOTING GUIDE

<b>Problem</b>	<b>Corrective Action</b>
No power	A.The battery may be depleted. Recharge or replace the battery. B.The battery may not be installed correctly. Remove the battery and install it again. C.The power switch is broken; Contact local dealer for repair. D.Battery tabs or the connection is broken; Contact local dealer for repair.
Battery power dies shortly after charging.	The battery life is finished. Replace the battery pack with a new one.
Transceiver cannot scan	The channels are not in scan list.
All bands pick up static and are noisy	Adjust the squelch settings during programming. Non-professionals are advised not to adjust this function.
No sound after removing earphone	Contact local dealer for repair.
Communication distance becomes short, and Low sensitivity	A.Check whether the antenna is making good contact and the antenna base and has not come loose. B. Antenna connector is broken. (this can happen if you carry the radio by the antenna) (Contact local dealer for repair)
Cannot talk or hear other members in your group	A.Different frequency or channel, please change it. B.Different CTCSS / DCS /DTMF, please reset it. C.Out of communication range.

## ◦ TROUBLE SHOOTING GUIDE

Can not power on or frequent power off	Check if the battery is making good contact and is locked in place.
The transmitting audio gets low or intermittent	Check if the MIC hole is plugged. If you cannot diagnose the issue –contact local dealer for repair.
Receiving is intermittent with too much noise	A. Out of communication range or obstructed by tall buildings. B. The 450 filter is broken, Contact local dealer for repair.
Loudspeaker is quieter or has crackling sound	Check whether the loudspeaker is broken, or if there is powder or dust in the loudspeaker. Contact local dealer for repair.
Receive voice from the other party but can not transmit	Check [PTT] key.
Receiving indicator with green light but no sound	A. Low volume, please turn the VOLUME knob clockwise. B. Loudspeaker is broken, Contact local dealer for repair. C. Earphone jack is broken, Contact local dealer for repair D. Volume switch is broken.

## o ATTACHED CHART

### ((( CTCSS Frequency Chart

1	62.5	12	94.8	23	136.5	34	177.3	45	218.1
2	67.0	13	97.4	24	141.3	35	179.9	46	225.7
3	69.3	14	100.0	25	146.2	36	183.5	47	229.1
4	71.9	15	103.5	26	151.4	37	186.2	48	233.6
5	74.4	16	107.2	27	156.7	38	189.9	49	241.8
6	77.0	17	110.9	28	159.8	39	192.8	50	250.3
7	79.7	18	114.8	29	162.2	40	196.6	51	254.1
8	82.5	19	118.8	30	165.5	41	199.5	52	user-defined
9	85.4	20	123.0	31	167.9	42	203.5		
10	88.5	21	127.3	32	171.3	43	206.5		
11	91.5	22	131.8	33	173.8	44	210.7		

(((1024 groups DCS frequency chart

000	001	002	003	004	005	006	007
010	011	012	013	014	015	016	017
020	021	022	023	024	025	026	027
030	031	032	033	034	035	036	037
040	041	042	043	044	045	046	047
050	051	052	053	054	055	056	057
060	061	062	063	064	065	066	067
070	071	072	073	074	075	076	077
100	101	102	103	104	105	106	107
110	111	112	113	114	115	116	117
120	121	122	123	124	125	126	127
130	131	132	133	134	135	136	137
140	141	142	143	144	145	146	147
150	151	152	153	154	155	156	157
160	161	162	163	164	165	166	167
170	171	172	173	174	175	176	177
200	201	202	203	204	205	206	207
210	211	212	213	214	215	216	217
220	221	222	223	224	225	226	227
230	231	232	233	234	235	236	237
240	241	242	243	244	245	246	247

## o ATTACHED CHART

250	251	252	253	254	255	256	257
260	261	262	263	264	265	266	267
270	271	272	273	274	275	276	277
300	301	302	303	304	305	306	307
310	311	312	313	314	315	316	317
320	321	322	323	324	325	326	327
330	331	332	333	334	335	336	337
340	341	342	343	344	345	346	347
350	351	352	353	354	355	356	357
360	361	362	363	364	365	366	367
370	371	372	373	374	375	376	377
400	401	402	403	404	405	406	407
410	411	412	413	414	415	416	417
420	421	422	423	424	425	426	427
430	431	432	433	434	435	436	437
440	441	442	443	444	445	446	447
450	451	452	453	454	455	456	457
460	461	462	463	464	465	466	467
470	471	472	473	474	475	476	477
500	501	502	503	504	505	506	507
510	511	512	513	514	515	516	517
520	521	522	523	524	525	526	527
530	531	532	533	534	535	536	537

## o ATTACHED CHART

540	541	542	543	544	545	546	547
550	551	552	553	554	555	556	557
560	561	562	563	564	565	566	567
570	571	572	573	574	575	576	577
600	601	602	603	604	605	606	607
610	611	612	613	614	615	616	617
620	621	622	623	624	625	626	627
630	631	632	633	634	635	636	637
640	641	642	643	644	645	646	647
650	651	652	653	654	655	656	657
660	661	662	663	664	665	666	667
670	671	672	673	674	675	676	677
700	701	702	703	704	705	706	707
710	711	712	713	714	715	716	717
720	721	722	723	724	725	726	727
730	731	732	733	734	735	736	737
740	741	742	743	744	745	746	747
750	751	752	753	754	755	756	757
760	761	762	763	764	765	766	767
770	771	772	773	774	775	776	777

**NOTE: N stands for positive code. I stands for inverted code. 1024 groups of DCS in total.**



## ◦ FCC COMPLIANCE

### Usage of Your Transceiver on Part 90 (Commercial) and Part 97 (Amateur) Frequencies

1. Changes or modifications to this device not expressly approved by ANYTONE could void the user's authorization to operate this device.
2. This device complies with part 90 of the FCC Rules. Operation is subject to the following two conditions:(1)This device may not cause harmful interference, and (2) this device must accept any interference including received, interference that may cause undesired operation.

Changes or modifications to this device not expressly approved by ANYTONE could void the user's authorization to operate this device.



### Usage of Your Transceiver on Part 95 (Public) Frequencies

This radio has been type accepted and certified by the FCC for GMRS and MURS Radio Service operation. Any adjustments or alterations which might alter the performance of the transceiver or the method of determining frequency are strictly prohibited.

If you replace or substitute any unique parts (including crystals, transistors, IC's, regulator diodes, etc.) with parts other than those recommended by AnyTone Tech, you may be in violation of FCC technical regulations (in Part 95) or type acceptance requirements of the FCC rules.

Please Refer to PART 95 Subpart A - for more information regarding GMRS Use

Please Refer to PART 95 Subpart J - for more information regarding MURS Use

## ◦ LIMITED WARRANTY (UNITED STATES)



**You MUST file your warranty information online at: [AnyToneTech.com](http://AnyToneTech.com) within 45 days of purchase.**

*AnyToneTech* will repair or replace, at its option without charge, subject to the exclusions set forth below, any *AnyToneTech* Two-Way -Radio transceiver which fails due to a defect in material or workmanship within ONE year following the initial consumer purchase.

This warranty does not apply to water damage, battery leak or misuse, use of unauthorized accessories, unauthorized service or modification or altered products. Accessories have a 90 day warranty from date of purchase, including antennas, batteries, chargers, and earphones.

ANY IMPLIED WARRANTIES, INCLUDING WITHOUT LIMITATION THE IMPLIED WARRANTIES OF MERCHANTABILITY AND FITNESS FOR A PARTICULAR PURPOSE, SHALL BE LIMITED AS SET FORTH HEREIN AND TO THE DURATION OF THIS LIMITED WARRANTY, OTHERWISE THE REPAIR OR REPLACEMENT AS AND IS PROVIDED UNDER THIS EXPRESS LIMITED WARRANTY IS THE EXCLUSIVE REMEDY OF THE CONSUMER AND IS PROVIDED IN LIEU OF ALL OTHER WARRANTIES, EXPRESS OR IMPLIED. IN NO EVENT SHALL *AnyToneTech* BE LIABLE, WHETHER IN CONTRACT OR TORT (INCLUDING BUT NOT LIMITED TO NEGLIGENCE, BODILY INJURY, PROPERTY DAMAGE AND DEATH) FOR DAMAGES IN EXCESS OF THE PURCHASE PRICE OF THE PRODUCT OR ACCESSORY, OR FOR ANY INDIRECT, INCIDENTAL, SPECIAL OR CONSEQUENTIAL DAMAGES OF ANY KIND, OR LOSS OF REVENUE OF PROFITS, LOSS OF BUSINESS, LOSS OF INFORMATION OR DATA OR OTHER FINANCIAL LOSS ARISING OUT OF OR IN CONNECTION WITH THE ABILITY OR INABILITY TO USE THE PRODUCTS OR ACCESSORIES TO THE FULL EXTENT THESE DAMAGES MAY BE DISCLAIMED BY LAW.

## o ANYTONE TECH'S LETTER TO YOU:

*AnyTone*<sub>tech</sub> specializes in communication equipment, but even more important than communication with others - is your communication with God.

To become a Christian and receive salvation is the greatest step you can take with God. To be real it must be a personal commitment from the heart. Here are three steps to eternal salvation.

1. Admit you are a sinner. "All have sinned and come short of the glory of God" (Roman 3:23).
2. Receive Jesus Christ as Savior. "But as many as received him, to them gave he power to become the sons of God" (John 1:12).
3. Confess your faith. "That if thou shalt confess with thy mouth the Lord Jesus, and shalt believe in thine heart that God hath raised him from the dead, thou shalt be saved." (Romans 10:9).

To believe on Jesus Christ as Savior means to believe that He died for you, believe that He paid the price for your sin, and believe that He is the only way to Heaven. You can express your belief on Jesus by calling on Him in prayer.

Trusting God as your savior is the most important item we promote at *AnyTone*<sub>tech</sub>. We would like to help you learn more if you have accepted Christ as your personal Savior - contact us today at: [AnyToneTech.com](http://AnyToneTech.com) to let us know and we will send you a one time package of literature.