

AZDEN®

2m FM TRANSCEIVER

PCS-2000

INSTRUCTION MANUAL



Downloaded by RadioAmateur.EU

JAPAN PIEZO CO., LTD.

CONTENTS

○ Major Features	2
○ Cautions Before Use.....	3
○ • Names of Component Parts, Operations and Usage (control unit)	4
• Details of Keyboard	7
• Names of Component Parts, Operations and Usage (main unit)	10
○ Backup of Microcomputer Memory	12
○ Microphone PCM-2000 (standard accessory)	13
○ How to Operate	14
○ How to Load and Replace Silver Oxide Cells	17
○ How to Make Your Own Control Box.....	18
○ Optional Parts.....	20
○ Block Diagram.....	21
○ Specifications and List of Accessories	22

CAUTIONS BEFORE USE

Before connecting to a power supply, check that the antenna is securely connected. Check the outside antenna circuit for short-circuiting using an ohmmeter. Ensure that it is not short-circuited, and then firmly screw it into the connector on the rear side of the unit. (See page 11)

★ **Check that the cable used is of 50-ohm impedance**

We recommend RG-58/U or RG-8/U or equivalent cable for the antenna circuit.

★ **Rated voltage of the unit is 13.8V**

Be careful not to connect the unit to an improper power source, as this may cause damage. For mobile use connect the power cable directly to the battery, being careful to observe the proper polarity.

★ **Check that power supply voltage is 12 to 14V and each lead wire is connected to correct polarity**

The red lead is for positive + and the black lead for negative -, with maximum rating of $13.8V \pm 15\%$. The unit is designed for negative ground circuits only.

★ **Be sure the unit is properly located**

When using this transceiver as a fixed station, it should not be located in a place directly exposed to sunlight or with excessively high humidity.

When using this unit as a mobile station, avoid locating it where it comes in direct contact with the air flow from the vehicle heater. If a vehicle is parked for a long period under the hot sun, the inside temperature becomes very high. Do not start transmitting until the temperature lowers. Since this unit is to be grounded with the negative terminal, it must not be used in a vehicle that is grounded with the positive terminal without taking proper measures for insulation.

NAMES OF COMPONENT PARTS, OPERATION AND USE

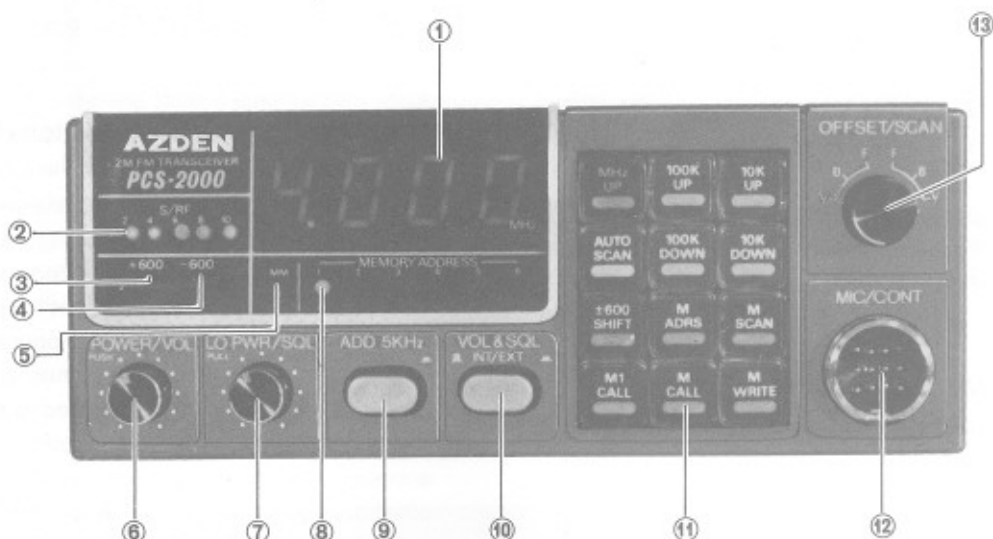

(1) Frequency Indicator

This indicator displays the lower four digits of the transmitting or receiving frequency on large LEDs. The example shows 4.000 which are the lower four digits of 144.000 MHz.

(2) Signal Indicator S/R/F

This indicator displays the input signal strength during reception and relative output power during transmission using five LEDs. The indicating level will be affected by the SWR of the antenna system. Therefore, 25 watts output does not necessarily mean that all five LEDs must be illuminated.

(3) + 600 kHz Indicator

When transmitting while this indicator is lit, the transmitting frequency is 600 kHz higher than the receiving frequency. Under these conditions, the Frequency Display will show a frequency 600 kHz higher than the receiving frequency while transmitting.

(4) - 600 kHz Indicator

When transmitting while this indicator is lit, the transmitting frequency is 600 kHz lower than the receiving frequency. Under these conditions, the Frequency Display will show a frequency 600 kHz lower than the receiving frequency while transmitting.

(5) Memory Mode Indicator

This serves to indicate that the unit is operating under Memory Mode (with M CALL, M1 CALL or M SCAN key depressed). For further details, see the section entitled "Details of Keyboard."

(6) Power Switch/Volume Control

Pushing this switch will turn the power ON and OFF. Rotating it clockwise with the power switch in the ON position will turn up the volume.

(7) Squelch Control/Power Level Switch

The Squelch is used to eliminate background noise under no signal conditions. With this knob turned fully counter-clockwise, the receiver hiss may be offensive. In this case, turn this knob gradually clockwise, and the noise will disappear at a certain point. By setting the knob just beyond this point, the receiver will be silent unless a signal is being received. Rotating the knob further clockwise will reduce the sensitivity of the receiver. Weak signals will then fail to open the Squelch. Pulling this knob toward you will reduce the transmitting output power from 25 watts to 5 watts.

(8) Memory Address Indicator

This unit has six memory channels. The memory address indicator shows which channel is being used in the Memory Mode. For further details, refer to "Details of Keyboard."

(9) 5 kHz Addition Knob

Pushing this knob will add 5 kHz to the transmitting and receiving frequency. The LED frequency readout will then show 5 as the lowest figure.

(10) Volume and Squelch Internal/External Select Switch

With this switch, volume and squelch control can be done by using either the incorporated control knob or the external control microphone PCM-2000. When this switch is in the UP position, volume and squelch control are made with the knobs on the transceiver front panel. When this switch is pushed into the DWN position, volume and squelch control are made by means of the external microphone.

(11) Keyboard

The keyboard is used to select the operating mode. For details see page 7.

(12) Control Microphone Connector

This is a 12-pin connector used for connecting the control microphone (standard accessory). For arrangement of pins and their corresponding functions, see page 18. For details of the control microphone PCM-2000, refer to page 13.

(13) Offset/Scan Select Switch (US Version)

This switch has six positions. With the switch in any of the three positions on the right side, the transceiver will be operating normally. With the switch in any of the three positions on the left side, the transceiver will be operating with an accessory offset determined by a crystal. (The PCS-2000 is supplied with a crystal providing + 1 MHz offset.) The accessory offset as determined by the offset/scan switch will occur in addition to the +600 kHz or -600 kHz offset. For example, with the offset/scan position set for +1 MHz offset and the transceiver set for +600 kHz shift, the resulting offset will be +1.6 MHz.

With the offset/scan switch in one of the three positions on the left, the Digital Frequency Display will not show the accessory offset. Therefore, it is necessary to remember the required frequency difference.

(13) Scan Mode (European Version)

The Scan Mode is provided with the two capabilities, Slow Scan and Normal Scan. The 3 positions on the right hand are for Normal Scan mode and those on the left are for Slow Scan mode. The normal scanning speed is approx. 4 channels/sec. and the slow scanning speed approx. 1 channel/2 sec. Each scanning function, i.e., Free, Busy and Vacant is as follows.

(Free):

Scanning is carried out over every channel independently of input signal and squelch control until a stop command key is pressed. For function of the stop command key, see page 7.

(Scanning for a Busy Channel):

When scanning is carried out in this position under squelching state, it automatically stops at a channel receiving an input signal. When the signal disappears, scanning is resumed. To conduct a QSO in the channel at which scanning stops, push a stop command key. Then, scanning will not be resumed when the signal disappears.

Note: Under no squelching state (with the SQL knob rotated fully counter-clockwise), scanning does not occur regardless of channel status.

(Scanning for a Vacant Channel):

When scanning is carried out in this position under squelching state, it skips over channels that are busy and will automatically stop at the first vacant channel encountered. Once a signal enters a vacant channel, scanning is resumed until the next vacant channel is encountered.

Note: Under no squelching state, scanning will occur regardless of channel status.



DETAILS OF KEYBOARD

★ Channel changing

- When pushing the 10K UP key or the 10K DOWN key once, the operating frequency is moved up or down by 10 kHz.
- When pushing the 100K UP key or the 100K DOWN key once, the operating frequency is moved up or down by 100 kHz. None of the four keys 10K UP, 10K DOWN, 100K UP or 100K DOWN will affect the MHz figure.
- When the MHz UP key is pushed, the MHz frequency changes from 4 to 5, 5 to 6, 6 to 7 or 7 to 4. However, the figures for 100 kHz and 10 kHz are not changed.

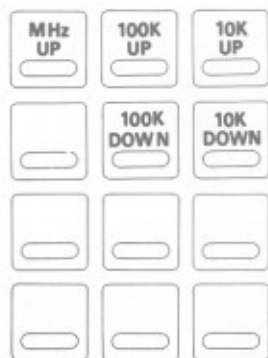

★ Rapid channel change

By holding down the 10K UP or the 10K DOWN key for more than a half-second, the frequency will automatically be moved up or down at a rate of eight channels per second. As the desired frequency is approached, release this key. The key may then be actuated two or three times as necessary to reach the desired frequency.

★ How to stop scanning

The 10K UP, 10K DOWN, 100K UP and 100K DOWN keys are provided with the following functions: Autoscanning, Memory scan stop, and Return from Memory mode.

When scanning is carried out in a specified mode, it will be stopped by pushing one of the above four keys. Actuating the key again will perform the function indicated on its face.

When you push another function key such as M1CALL (used to call the content of M1) while scanning, scanning stops immediately and the frequency indicator displays the content of M1. Thus, you are ready to communicate immediately using this channel.



★ How to write in memory

This unit is provided with six memories M1 to M6. The M WRITE key is used to store memory. By pushing this key, the upper three figures displayed on the frequency indicator (1) can be stored in the memory channel displayed on the memory address indicator. The memory address is changed by pushing the M ADRES key.

Example: Store 145.560 MHz in M3.

First, display 5.560 on the frequency indicator in accordance with procedure for "Frequency Change." Second, light up M3 on the memory address indicator by means of the M ADRS key.

Then, depress the M WRITE key.

As a result, 145.560 MHz is stored in M3, with an indication of 5.560.

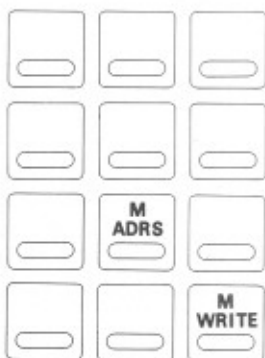

● ± 600 kHz shift

This key is used to determine the transmitting frequency offset. Pushing this key will change the offset to +600 kHz, -600 kHz, and simplex, in this order. For +600 kHz offset, indicator (3) lights up. For -600 kHz offset, indicator (4) lights up. For simplex operation, neither indicator lights up.



★ Calling memory

The Memory Address key is used to select one frequency from among the six memory channels stored. Pushing this key will adv-

ance the memory address from 1 to 6 one at a time, lighting the LED corresponding to the memory address. Then, by pushing the M CALL key, the channel stored in the memory is called and displayed on the frequency indicator (1).

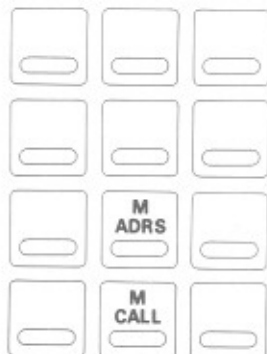

Once the M CALL or M1 CALL key has been depressed, pushing the memory address key will advance the memory address one at a time, with an indication of the content of each memory. That is, merely pushing the memory address key until the desired memory is reached will call the contents of that memory.



Such state continues until a return key from the memory mode is depressed.

Downloaded by
RadioAmateur.EU

★ **Return from memory mode (see "how to stop scanning")**

To return the memory mode to the UP-DOWN mode, push one of the four keys 10K UP, 10K DOWN, 100K UP or 100K DOWN.

After the key is depressed twice, the channel can be changed by the UP-DOWN operation.

★ **Quick memory 1 call**

By pushing this key, the content of Memory Channel 1 can be called and indicated at once, independently of the frequency being used at the time or the memory address and scanning.

It is therefore very convenient to store a priority frequency in Memory Channel 1. Note that the memory address indicator may not necessarily show M1 after Channel 1 has been called with the Memory 1 call button. Pushing the M CALL key will immediately call the content of whatever memory address is displayed by the memory address indicator.

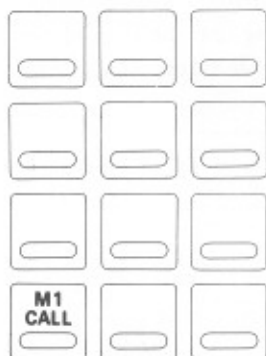

★ **Memory scanning**

Pushing this key will start scanning of the memory address. Scanning starts directly after the address which is displayed on the memory address indicator.

To stop memory scanning, push one of the four return keys 10K UP, 10K DOWN, 100K UP or 100K DOWN.

To start UP-DOWN operation, it is necessary to push the key twice more. The frequency given by these key operations is the

frequency which has been used just prior to shifting to the memory mode.



★ **Automatic scanning**

When the AUTO SCAN key is pushed while the unit is operating in the UP-DOWN mode, scanning is started from the frequency indicated at that time in the specified scanning mode (F, B or V). When the unit is operating in the memory mode, pushing this key will cause the unit to return from this mode and then start scanning from the returned frequency in the specified scanning mode. In either case, step width is 10 kHz UP and scanning range is 000 to 990 (1 MHz at a time). Therefore, figures are not shifted in the MHz range. The MHz figure may be changed with the MHz UP key while autoscanning, without stopping the scan. Scanning is stopped by pushing one of the four return keys. This returns operation to the UP-DOWN Mode.



★ REAR SIDE OF CONTROL UNIT

(14) External Speaker Jack

An external speaker to be located in any desired position can be connected with this 3.5mm jack. The speaker is activated by setting the speaker output select switch located at the rear of the main unit to the EXT position. This feature is especially convenient when the main unit is located in an out-of-the-way place.

(15) Connecting Board

This edge connector fits into the Control Connector of the main unit. When separating the control unit from the main unit, a remote-control cable (option) must be used.

(16) Bracket Support and Screws for Mounting the Control Unit for Mobile Use

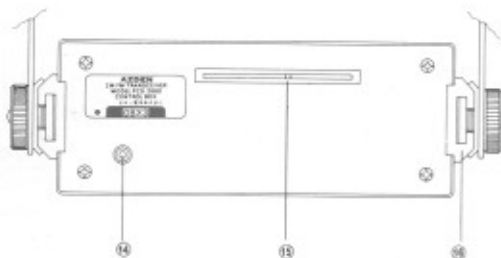

★ FRONT SIDE OF MAIN UNIT

(17) Control Connector

This part connects with the edge connector of the control unit.

When separating the control unit from the main unit, the optional remote cable must be used.

Note: DO NOT REMOVE THE CONTROL HEAD FROM THE MAIN UNIT WHILE THE POWER IS ON.

(18) Hanging Bracket for Mobile Unit

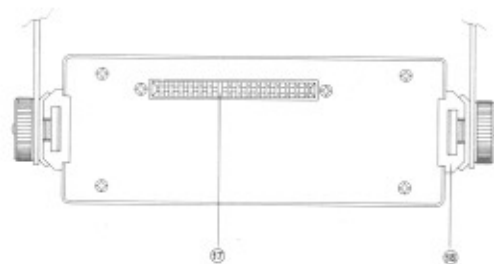

★ REAR SIDE OF MAIN UNIT

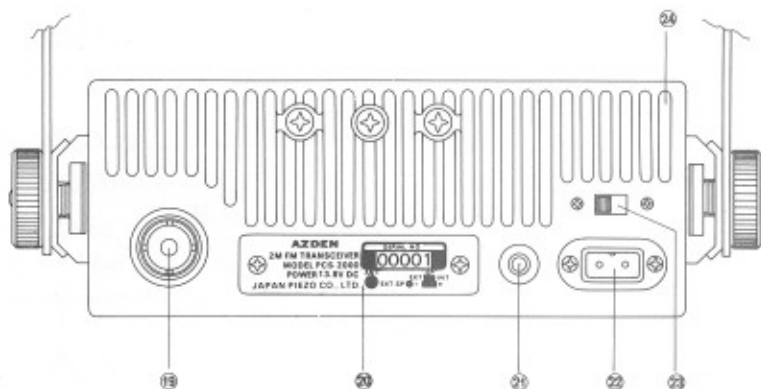

(19) Antenna Connector

The antenna connector is an SO239 type designed to mate with a PL259 connector. The impedance of the antenna and cable used should be 50 ohms. Some degree of mismatch is tolerable, but a severe mismatch will reduce the power output of the PCS 2000. The feedline length should be kept as short as possible to minimize power dissipation.

(20) Name Plate

(21) External Speaker Jack

An external speaker (option with 3.5mm plug) is connected with this jack. With the speaker output select switch in the INT position the internal speaker is activated. When it is set to the EXT position, speaker output is supplied to the speaker jack (14) on the rear side of the control unit.

By inserting the speaker cable plug into this jack with the select switch to INT, the internal speaker is automatically disconnected.

(22) Power Connector

The PCS-2000 is to be supplied with 13.8V \pm 15% at 5A or more. The red lead of the power cord is positive and the black is negative (ground).

When connecting the power cord to the power supply, be careful not to reverse the polarity.

Should the polarity be connected incorrectly, a 10A fuse will blow to protect the main unit. Never use a fuse other than the specified one.

(23) Speaker Output Select Switch

See (14) and (21).

(24) Heat Sink

The heat sink is made of die-cast aluminum for sufficient capacity for prolonged transmission at 25W output.

★ BOTTOM OF MAIN UNIT

(25) Internal Speaker

Since the sound holes face downward, the main unit should be located so as not to block these holes. The speaker is 8 ohms impedance.

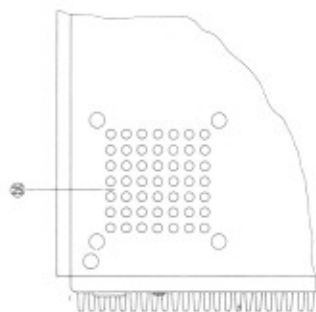

★ BACKUP OF MICROCOMPUTER MEMORY

A C-MOS microcomputer (A) is employed in this unit. To take advantage of the power-saving characteristics of C-MOS, this unit is provided with silver-oxide cells (B). These serve to back up the memory stored by the user. Suitable types are **S76, MS76, RS76 or 76SO**. These cells are supplied separately and are not installed prior to dispatch.

By use of these cells, the memory, which has been stored before turning off the power or removing the power supply, is retained and can be recalled when the power is returned.

If the cells are used over their service life (approximately six months) or the power cord is loose, memory will not be retained. This condition is indicated by partly broken figures or false figures in the display. First, check that the power cord is securely connected with the power supply. If so, you should replace the old cells with three new silver-oxide cells available at camera or electric goods stores. The transceiver can be used without cells for powering the memory. But the existing memory will be erased in this case when the power is turned off, and the memory contents must be rewritten when using the unit the next time.

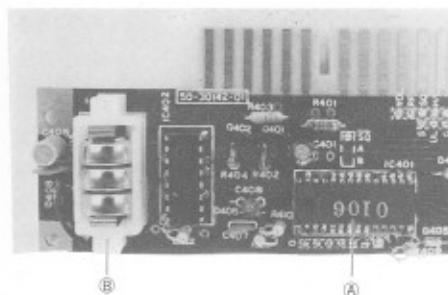

The unit can be used with an entirely consumed memory back-up battery, but there is some danger that the battery fluid will leak. Therefore, spent cells should be removed or replaced.

MICROPHONE PCM-2000

A multifunctional microphone is provided as a standard accessory. Your own radio microphone can be used for this transceiver using an optional microphone connector.

(1) M1 CALL (US version)

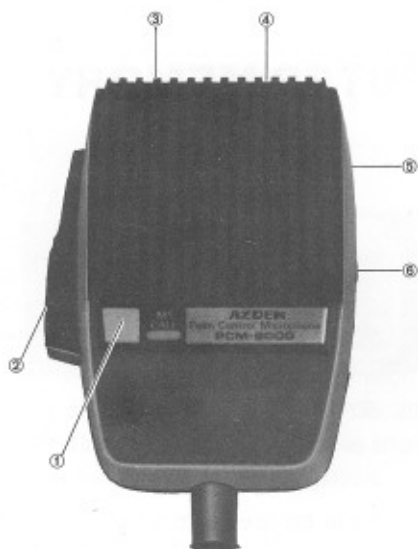

M1.

The M1 CALL button has the same function as the M1 CALL key of the control unit. Refer to "Details of Keyboard."

This facilitates quick and easy recall of the contents of memory channel 1.

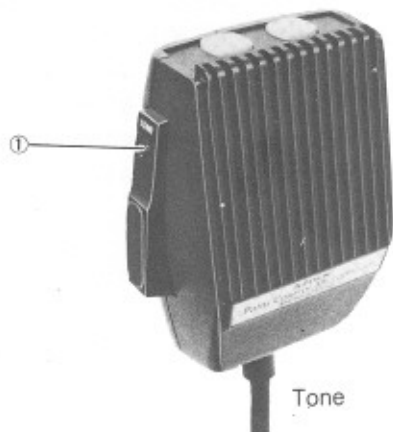

(1) Tone CALL Key (European version)

The unit incorporates the 1750 Hz oscillation circuit. You can activate the circuit by pressing (1) button and this enables the unit to transmit the carrier frequency modulated by 1750 Hz for repeater operation. Thus, you can start QSOing by pressing the PTT lever in a specified period of time.

(2) Push to Talk Switch Lever

Pushing this lever puts the unit in the transmit mode. Speak at a normal level while bringing the microphone near your mouth. Releasing the lever will return unit to the receive mode.

(3) 10K UP Key and (4) 10K DOWN Key

These keys have the same function as the 10K UP key and the 10K DOWN keys of the control unit. By holding these keys down, each MHz range can be scanned, just as is the case with the front panel control keys.

(5) Volume and (6) Squelch

When the volume and squelch switch on the front panel of the control unit is set to the external position, the volume and squelch are controlled by these two controls on the microphone.

OPERATION

● Reception

● Before activating the unit with the power switch, set the knobs and switches of the control unit as follows, and check that the antenna is connected correctly:

VOL	Turned fully counter-clockwise
SQL	Turned fully counter-clockwise
VOL/SQL	Internal/external to internal ("UP position")
SCAN MODE	NORMAL F

- Firmly plug the microphone connector into the microphone jack on the unit.
- Set the speaker output select on the rear side of the main unit to INT position.
- Turn on the power switch. With no power connected to the radio, it is impossible to tell whether the power switch is on or off; however, the power connector may be attached

without harm to the unit if the power switch is on.

- If the LED readout seems to malfunction, turn off the power switch and after several seconds, turn it on again.
- Lighting up the LEDs indicates power is on. Turn the volume control knob clockwise until noise comes from the speaker. Then set the volume at the desired level.
- At this point, the unit is ready for reception at a frequency displayed on the frequency indicator.
- When no signal is being received, the noise from the speaker may be offensive. Turn the squelch knob slowly clockwise until the noise disappears. Then set it slightly beyond this point. In mobile applications, the squelch control sometimes becomes unstable, and it may become necessary to readjust it.

● How to program the memory

Suppose you want to write the following frequencies in the memory: M1, 5.500; M2, 5.220; M3, 5.330; M4, 5.440; M5, 5.550; M6, 5.660.

- (1) Assume that 5.000 is stored in all memories.
- (2) Push Memory Address key.
- (3) Push Memory Address key until memory address LED indicates memory Channel 1.
- (4) Dial 5.500 by means of the keyboard.
- (5) Push Memory WRITE. Thus, 145.500 MHz has been written into memory No. 1.
- (6) Push Memory Address to Advance Memory Address to Channel 2.
- (7) Dial up 5.220 by means of the front panel keyboard.
- (8) Push Memory WRITE key. This enters the frequency 145.220 into Memory Channel 2.
- (9) Repeat the process for the appropriate frequencies for Channels 3 through 6.

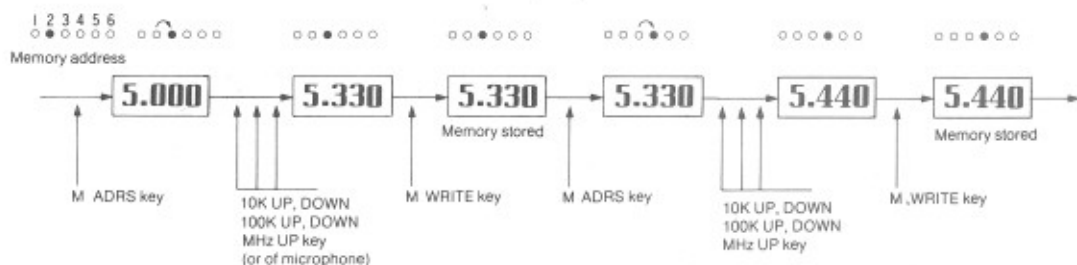

● How to use M1 CALL, M ADRS and M CALL keys

Pushing M1 CALL key while operating the unit will immediately call the contents of Memory Channel 1 independently of reception mode.

Example 1: Assume that 5.500 is stored in Memory Channel 1 and 5.330 is stored in Memory Channel 3.

Call them according to the procedure illustrated below. These memories can be alternately called by pushing the M1 CALL key and M CALL key, when M3 is lit in advance by means of the Memory Address key.

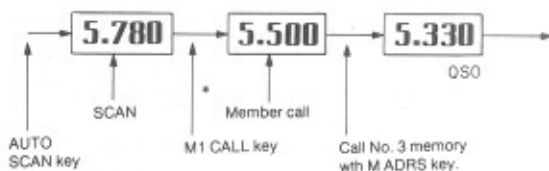

Note: * In this case, memory address indicator does not change indication.

Example 2: Call Memory Channel 3 from among ordinary channels.

Assume that 5.660 is displayed and Memory Address indicator shows Memory No.6. The procedure is illustrated below.

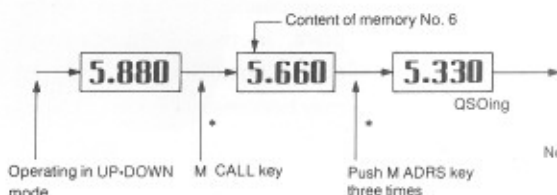

Note: * Any of operation may be done first.

● How to use MEMORY SCAN key

Example:

- (1) Rotate SQL knob clockwise to set at squelching state.
- (2) Set SCAN knob at B (BUSY).
- (3) M4 is being used by Mr. A and M6 is being used by Mr. B.
- (4) Suppose that the memory channels are programmed as follows: M1, 5.500; M2, 5.220; M3, 5.330; M4, 5.440; M5, 5.550; M6, 5.660. Suppose that M2 address indicator is lit. The procedure is illustrated below.

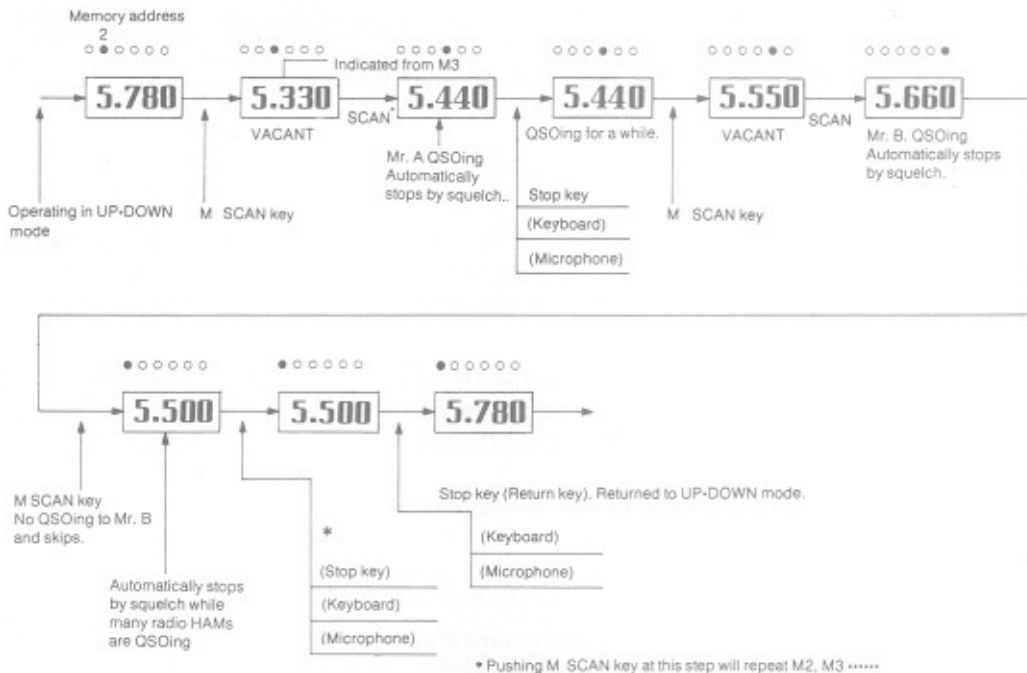

● How to use AUTO SCAN key

Example 1: Set the SCAN mode at B (BUSY). Scanning will begin when the AUTO SCAN key is pushed, and automatically stops at a channel being used for a QSO.

Note: The squelch knob must be rotated clockwise to be set in the squelching state.



Example 2: To search for a vacant channel from among busy channels, set SCAN key at V (VACANT). Press the AUTO SCAN key, and scanning will automatically stop at the first vacant channel encountered. The squelch must be set to the squelching state.

★ HOW TO LOAD AND REPLACE SILVER OXIDE CELLS

The silver oxide cells used for retaining the memory of the built-in microcomputer should be replaced about every six months. To replace them, separate the main unit from the control unit as illustrated below and then remove the clamping nut (A) on both sides. Remove the set screw (B) of the control unit cover with a Phillips head screwdriver and take off the cover (C). Three cells (D) are contained inside the left end of the control unit.

Replace them with new ones (S76, MS76, RS76 or 76SO) paying attention to the polarity of the cells, and reassemble the unit. Since the cells are held in place by the soft plastic sheet inside the cover (C), do not remove this plastic sheet. If it is difficult to take out the cells, pull up the green tape.

Separate main unit from control unit and unscrew control unit.
Remove cover and replace cells.

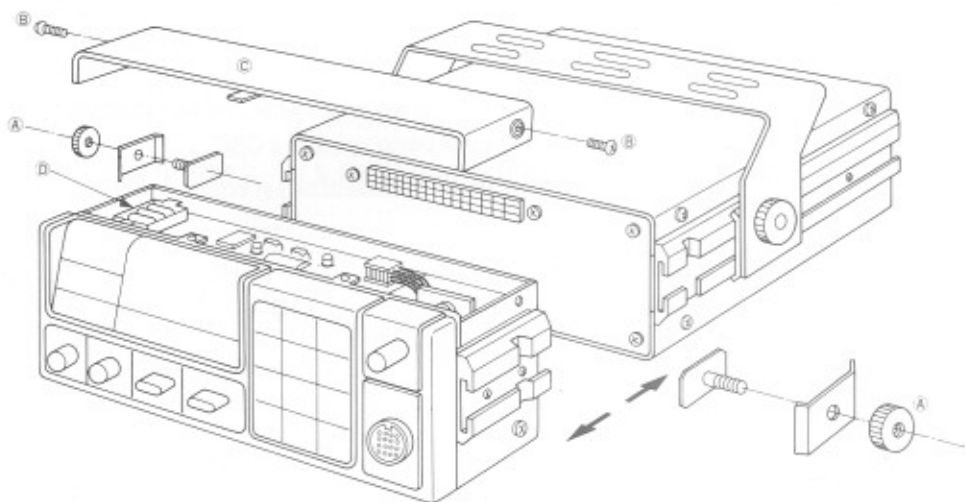

Downloaded by
RadioAmateur.EU

★ HOW TO MAKE YOUR OWN CONTROL BOX

The connector of control microphone for this unit is supplied with a portion of the input-output matrix circuit of the microcomputer. The circuit diagram for the available signals is shown below. You can make a variety of your own control boxes using these signals in combination with optional control microphone connector plug (with cord).

Lead wires corresponding to signals:

- | | | | |
|-----------|--------------------------|------------|----------------------|
| 1. Green | (K2) | 7. Black | (R1) |
| 2. Red | GROUND | 8. White | (Eur. version) (R2) |
| 3. Blue | VOL | 8. White | 13.8V (U.S. version) |
| 4. Yellow | (K1) | 9. Brown | PTT |
| 5. Purple | (U.S. version) (K8) | 10. Orange | (R0) |
| 5. Purple | TONE CALL (Eur. version) | 11. Knit | MIC GROUND |
| 6. Grey | SQ | 12. Pink | MIC OUTPUT |

By combining 1, 4 and 5, and 7, 8 and 9 among these 12 lead wires, the microcomputer of the control unit can be controlled.

- Signal 100K UP by contacting R0 to K1
- Signal 100K DOWN by contacting R0 to K2
- Signal M1 CALL by contacting R0 to K8 (U.S. version)
- Signal 10K UP by contacting R1 to K1
- Signal 10K DOWN by contacting R1 to K2
- Signal MEMO CALL by contacting R1 to K8 (U.S. version)
- Signal MHz UP by contacting R2 to K1 (Eur. version)
- Signal AUTO SCAN by contacting R2 to K2 (Eur. version)

PTT, VOL and SQ can be added to the above.

By utilizing this wide range variations you can make a highly original control box such as hand control box.

The most important consideration to be taken when making an original control box is a countermeasure for induced hum.

If sufficient care is taken there will be no problem in making your own control box.

★ HOW TO MOUNT HANGER BRACKET OF MAIN UNIT AND CONTROL UNIT

How to mount main unit

Fit plate screw, plate spring and support metal to hanger vertically or horizontally, and tighten them temporarily with a clamping nut. Push the main unit in direction of the arrow and fix it at a proper position. Then, firmly tighten the clamping nut.

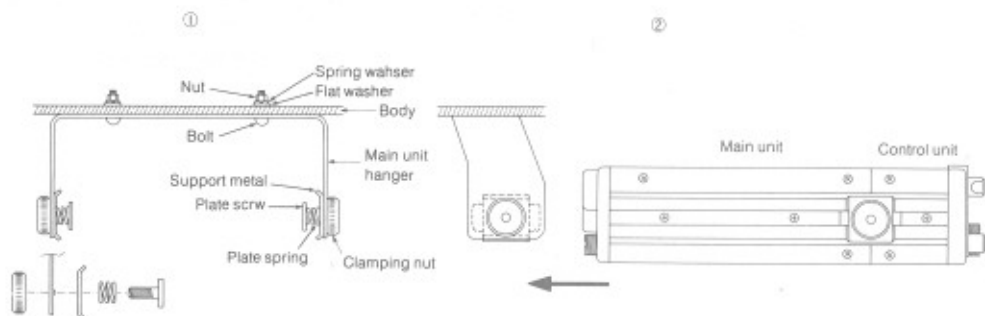

How to remove the control unit

Loosen the clamping nut, remove the plate screw, plate spring and support metal connecting the main unit with the control unit. Then, separate the two units.

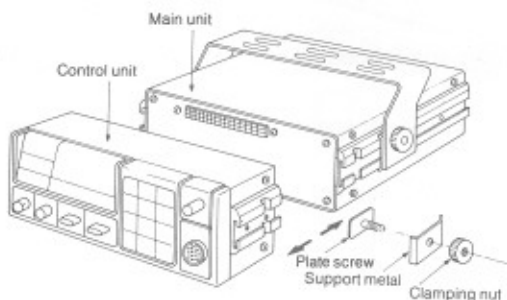

How to mount the control unit

Mount the control unit on the hanger bracket in the same way as with the main unit.

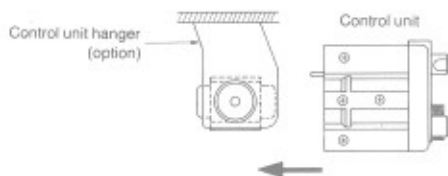

How to install cable connector

The optional parts ECK-90 kit contains a remote cable, hanger, connector holder and screws. Fix the connector holder to two screw holes (A) on the front of the main unit and to two screw holes (B) on the rear of the control unit using a screw M3 x 5 (standard accessory) and a spring washer for M3 illustrated in (C).

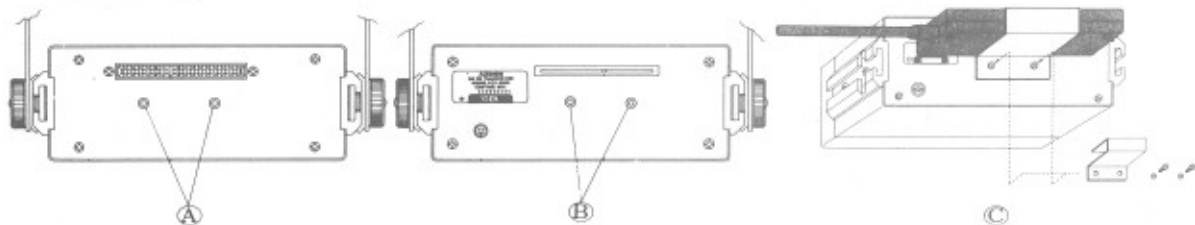

OPTIONAL PARTS

★ Control microphone connector plug with cord: EC-80

This unit is supplied with a multifunctional microphone as a standard accessory. Additional Connectors are available. The wiring scheme is as follows:

	US Version	European Version
Green	10 kHz DOWN	←
Red	GROUND	←
Blue	VOL	←
Yellow	10 kHz UP	←
Purple	M1 CALL	TONE CALL
Grey	SQ	←
Black	Common lead for UP, DOWN	←
White	13.8V	EMPTY
Brown	PTT	←
Orange	Common lead for M1 CALL	←
Knit	Shield	←
Pink	MIC Audio	←

Remote cable kit: ECK-90

Using the remote cable kit, the control unit can be located by itself in the desired place. For instance, if it is inconvenient to stretch your arm to the lower part of the dashboard, you can place the control unit in a visible location and the main unit under the rider's seat. The cable length is 15 feet (5m).

External speaker kit AS-006

This accessory is ideal when you wish to get more audible output. It is also useful if you wish to change the location of the speaker. The speaker is provided with a 6 foot (2m) cord with 3.5mm plug.

Base station microphone DX-2000

This is our highest quality dynamic microphone for use with fixed stations. It features a built-in amplifier, UP-DOWN function, memory 1 call, PTT lever, and locking mechanism.

★ SPECIFICATIONS

(General specifications)

- Semiconductors IC 15 pcs. (including MICON 1)
FET 5 pcs.
Tr 33 pcs. (US version)
37 pcs. (European version)
 - Frequency band Di 56 pcs.
144.000 to 147.995MHz (US version)
144.000 to 145.995MHz (European version)
 - Operating ambient temperature range -10° to +50°C
 - Power supply voltage 13.8V ± 15%
 - Grounding polarity Minus
 - Current consumption 0.7A max. in case of reception
5.0A max. in case of transmission
- (Transmitter)
- Transmitting output 25W (HIGH)
5W (LOW)
 - Modulation method Variable reactance frequency modulation
 - Maximum frequency deviation ±5 kHz

- Spurious -60 dB or less
 - Antenna impedance 50Ω
 - Type of emission F3
 - Microphone used 500Ω dynamic type
- (Receiver)
- Receiving system Double superheterodyne system
 - Intermediate frequency First 16.90 MHz
Second 455 kHz
 - Receiving sensitivity 20 dB Noise suppression sensitivity 0.28μV or less
 - Selectivity ±6 kHz or more / -6 dB
±15 kHz or less / -60 dB
 - Low frequency output 2W or more (in case of 8Ω load and 10% distortion)

(Dimensions and Weight)

- Dimensions 62(H) x 158(W) x 246(D) mm (except projections)
- Weight Approx. 2.5 kg

★ Notice: Specifications are subject to change without notice for further technical improvement.

★ LIST OF ACCESSORIES

Downloaded by
RadioAmateur.EU

- (1) Microphone PCM-2000..... 1
- (2) Microphone hanger..... 1
 - Set screw..... 2
 - Flat washer for above..... 2
- (3) DC power cord (with fuse) 2.0m..... 1
- (4) Spare fuse (10A)..... 2
- (5) Hanger and fixtures..... 1 set
 - Hanger..... 1
 - Clamping nut..... 4
 - Plate screw..... 4
 - Spring for above..... 2
 - Support metal..... 4
 - 2 (with hole)
 - 2 (without hole)
 - Set screw..... 4
 - Nut for above..... 4
 - Flat washer for above..... 4
 - Spring washer for above..... 4
- Instruction Manual (including circuit diagram)
- Silver oxide cell (G-13, S76, MS76, RS76, or 76SO)..... 3