

OPERATION MANUAL

BELCOM LINER 70A



NIHON DENGYO CO., LTD

PRIOR TO USE

We hope that you will peruse the OPERATION MANUAL with utmost care so that you may make the best use of this unit smoothly without any trouble for many years to come. It is extremely important to gain mastery of the operational procedure in order to keep the transceiver always at the best operating condition.

C O N T E N T S

	Page
1. FEATURES -----	
2. PRIOR TO USE -----	2
3. RATING -----	9
4. ACCESSORIES -----	13
5. DESCRIPTION ON PANEL -----	14
6. OPERATING METHOD -----	24
7. ATTACHED CIRCUITS -----	53
8. CIRCUITRY (BLOCK DIAGRAM) -----	56
9. TROUBLE SHOOTING -----	65
10. HOW TO WRITE AN APPLICATION SHEET -----	68
11. WIRING DIAGRAM -----	69

2. PRIOR TO USE

2-1. Installing place

- o LINER 70A is a communication apparatus which has been adjusted accurately by high quality measuring instruments.

Avoid installing this unit in such places as shown hereunder so that it may be operated stably for a very long time.

(1) Very hot and humid place

Near the room cooling and heating place,
or place which is exposed directly to the
wind blown directly from the equipment
or kitchen etc.

(2) Dusty place

(3) Place exposed directly to the sunlight

(4) Place subjected directly to vibration and
shock

(5) Place having poor ventilation

- o Paying attention to the abovementioned points, select such a dry place as having good ventilation. Be sure to separate its back heat sink and bottom from the wall or desk as much as possible in order to improve the heat radiating effects.

CAUTIONS

If the set is installed on its side or with its back

panel side facing downwards, the heat radiating effects will become poor, resulting in unstable operation sometimes.

2-2. Power source

- o LINER 70A may be operated on either of AC 100V, or DC 13.8V.
- o Change-over of AC/DC is effected by replacing the power cords attached to the set.

2-2-1. Operation on AC power

- o Inserting a 6P square type connector of the AC power cord (FIG. 1) into the set, insert 2P plug socket to AC socket (100V±10%, 50Hz or 60Hz).

FIG. 1 AC POWER CORD

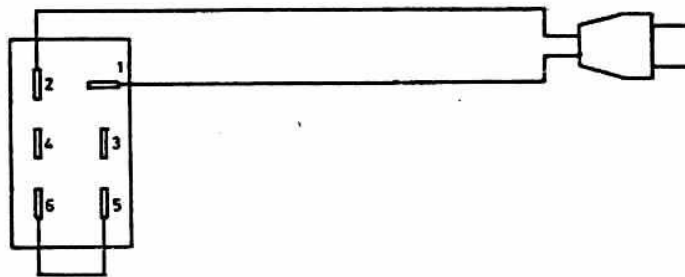

CAUTIONS

- o Be sure to confirm the following points when the power cord is fitted or exchanged.
 - (1) Check whether or not the power switch of the LINER 70A has been turned off.

- (2) Check whether or not SEN-REC switch of the LINER 70A has been placed at position "REC".
- (3) In the case of AC power, check whether or not 2P plug socket has been pulled out from the AC socket.
- (4) In the case of DC power, check whether or not the cord for DC has been disconnected with DC power (battery).

2-2-2. Operation on DC power

- o A (-) earthing system has been adopted for LINER 70A.
- o Inserting a 6P square type connector of the power cord for DC (Fig. 2) into the set, connect the (+) of the DC power with the red cord and (-) with black cord.
- o At mobile operation, a maximum of approx. 5A runs. Therefore, in order to prevent the battery from overdischarging, be sure to operate the unit with the engine at an operating state.

FIG. 2 DC POWER CORD

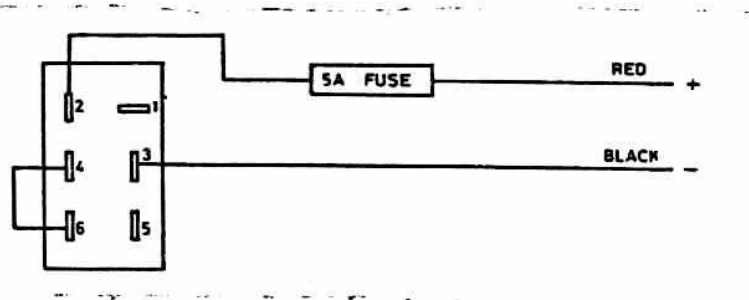

CAUTIONS

o When DC power (battery) is used, be sure to confirm the following points.

(1) Check whether or not the polarity of (+) and (-) is all right.

If the polarity is wrong, the set might be troubled sometimes.

(2) Check whether or not the cord has been fitted to the DC power source (battery) positively.

If fitted loosely, heat will be generated, burning the connection of DC power cord of the battery or breaking out fire.

Special attention must be paid thereto so that such an accident may not develop. At the same time, the transmitting output might drop.

2-3. Antenna

o There are many types of antennas available. UHF band depends specially on the performance of the antenna markedly. Be sure to select a good antenna which is best suited for the intended purpose.

(10MHz covered continuously in LINER 70A)

o At the same time, the height of an antenna exerts influence over UHF band seriously.

The minimum height of the antenna must be higher than 10 m.

- o The antenna impedance of LINER 70A is 50Ω.
The matching with antenna is especially important in UHF band. The antenna and coaxial cable must be of 50Ω and SWR must be as low as possible. (If used at mismatching state, the band pass characteristics of the set will become poor, resulting in poor performance.)
- o The cable loss at UHF band is very large.
The coaxial cable 10D-2V or higher must be used.
- o The antenna connector of LINER 70A is N TYPE.
N type connector must be used.

2-4. Microphone

- o The impedance of the attached microphone is 2 KΩ.
When other microphones than the attached one are used, be sure to select such a microphone as having an impedance nearest to 2KΩ.

CAUTIONS

ALC is applied to the microphone input circuit in LINER 70A. Therefore, if the impedance is different markedly, the operation of ALC will become unstable sometimes.

- o Fig. 3 shows the connection of microphone.
When other microphones than the attached one are used, full attention must be taken so that wiring is provided correctly.

FIG. 3 CONNECTION OF MICROPHONE CONNECTOR

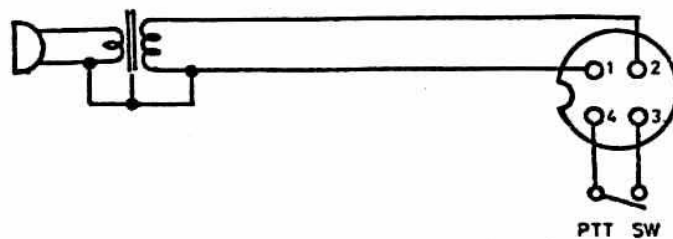

2-5. Key for CW

When the manual key is used, be sure to connect it with the attached plug.

FIG. 4 KEY-PLUG CONNECTION DIAGRAM

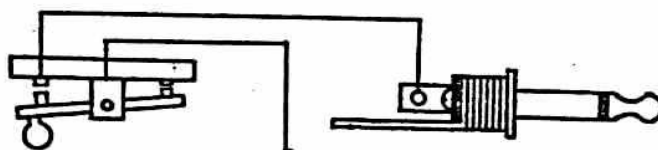

When an electric guitar is used, pay attention to the polarity of the electric guitar.

FIG. 5 POLARITY OF THE SWITCHING TRANSISTOR WHEN ELECTRIC GUITAR IS USED

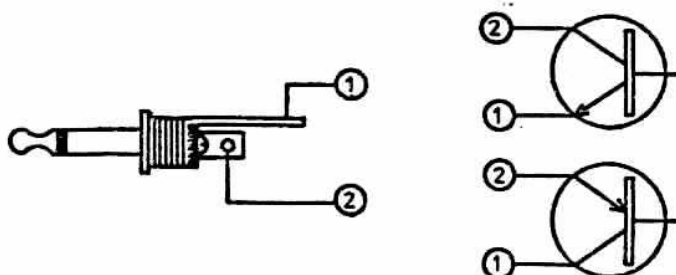

In other modes than CW mode, no keying circuit is operated. With the key inserted to KEY JACK, other modes can be used.

2-6. External speaker

- o A speaker has been incorporated in LINER 70A. EXT SP JACK is provided at the back panel so that an external speaker may be used.
- o External speakers must have an impedance of 8Ω .
- o In order to improve clearness at reception, be sure to use a speaker for communication equipment having a large diameter so far as practicable.
- o When an external speaker is used, the attached small plug must be used and connection, be made with EXT SP. (FIG. 6)
- o When an external speaker is used, the attached small plug must be inserted and the built-in speaker is turned off.

FIG. 6 CONNECTION DIAGRAM OF EXTERNAL SPEAKER

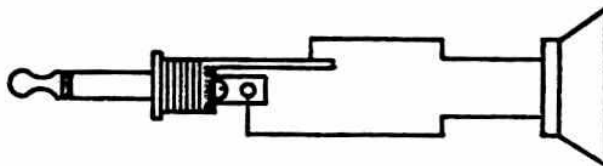

2-7. Head phone

- o Be sure to use a head phone having an impedance from 8 - 16Ω.
- o Be sure to use the attached plug and connect it with the PHONES JACK. (FIG. 7)
- o When the plug is inserted to the PHONES JACK, the incorporated speaker and external speaker will be turned off.

3. Ratings

- o Frequency range ----- 430 - 440MHz
- o Type of radio wave ----- A3J (LSB, USB)
 - A1
 - F3
 - A3
- o Power voltage ----- DC 13.8V±10%
 - AC 100V±10%
- o Antenna impedance ----- 50Ω
- o External dimensions
 - Height ----- 110 mm
 - Width ----- 280 mm
 - Length ----- 355 mm
- o Weight ----- 11.5 Kg

TRANSMITTER SECTION

- o Transmitting output ----- A3J 10W (PEP)
 - A1 10W
 - F3 10W

A3 4W

- o Modulating system ----- A3J balanced modulation
ion
A3 Low power modulation
ion
F3 Variable reactance
frequency modulation
- o FM maximum frequency
deviation ----- $\pm 5\text{KHz}$
- o SSB generating system --- Filter system
- o Unrequired radiation in-
tensity ----- 40 dB or more
- o SSB unrequired side band
wave suppression ratio -- 40 dB or more
- o Microphone impedance ---- $2\text{K}\Omega$
- o Transmitting frequency
characteristics ----- 300 - 2,700Hz ($\pm 3\text{dB}$)
- o Third cross modulation
distortion ----- -25dB or less

RECEIVER SECTION

- o Receiving system ----- SSB double conversion
superheterodyne
AM "
CW "
FM triple conversion
superheterodyne
- o Intermediate frequency--- SSB NO.1 46.7MHz -
47.7 MHz

NO. 2 10.7 MHz
AM "
CW "
FM No.1 46.7 MHz - 47.7 MHz
No.2 10.7 MHz
No.3 455 KHz

- o Sensitivity of reception ----- SSB CW OdB μ input S + N/N
10 dB or more
FM 20 dBQS - 3dB μ or less
AM 6 dB μ input S + N/N
10 dB or more
- o Selectivity ----- SSB CW AM
±1.2KHz or more -6dB
±2.4KHz or less -60 dB
FM ±7.5KHz or more -6 dB
±15KHz or less -60 dB
- o FM squelch sensitivity-- -6dB μ or less
- o Low frequency output ---- 2W or more 8 Ω load
- o Image ratio ----- 60 dB or more
- o Frequency stability ----- ±4KHz or less from 1 minute
after swtiching on to 60
minutes
200Hz or less per 30 minutes
after that

- o Semi-conductors ----- Transistor 85
 - FET 11
 - IC 6
 - Diode 90

- o Power consumption

- AC 100V ----- Max. 100VA

- DC 13.8V ----- Max. 5A

- o Semi-conductors used

- o TRANSISTORS

- 2SB525-C ----- 5
 - 2SC381-0 ----- 3
 - 2SC387-A ----- 17
 - 2SC509-Y ----- 2
 - 2SC710-C ----- 47
 - 2SC1164-0 (or R) ----- 2
 - 2SC1260 ----- 2
 - 2SC1968A ----- 1
 - 2SC1968A ----- 1
 - 2SC2131 ----- 1
 - 2SC2132 ----- 1
 - 2SD114-Y ----- 1
 - 2SD325-0 ----- 2

- o FET

- 2SK19GR ----- 10
 - 3SK48 ----- 1

o IC

TA7063P -----	1
SN7400 -----	1
SN7490 -----	2
uPC577H -----	1
AN315 -----	1

o DIODE

S5VB-20 -----	1
IS1555 -----	58
MI402 -----	2
IN60P -----	16
IS990 -----	5
RD6A -----	3
BZ090 -----	1
MV201 -----	1
MA320B1 -----	3

4. Accessories

LINER 70A has the following accessories.

(1) Microphone (1 pc.)

With press-to-talk switch, dynamic microphone,
with 4P connector

Impedance 2K Ω

(2) Microphone bracket (1 pc.)

Crown washer, 3M tap screw with 2 pcs. each

(3) Power cord for AC 100V (1 pc.)

- (4) Power cord for DC 13.8V (1 pc.)
With 6P connector, fuse holder
- (5) 9-pin plug (1 pc.)
For ACCY (accessory)
- (6) Small type plug 2P (1 pc.)
For EXT. SP
- (7) Plug 2P (2 pcs)
For key, head phone
- (8) Fuse 3A (2-pcs)
For AC power
- (9) Fuse 10A (1 pc)
For DC power

5. Description on panel

5-1. Front panel

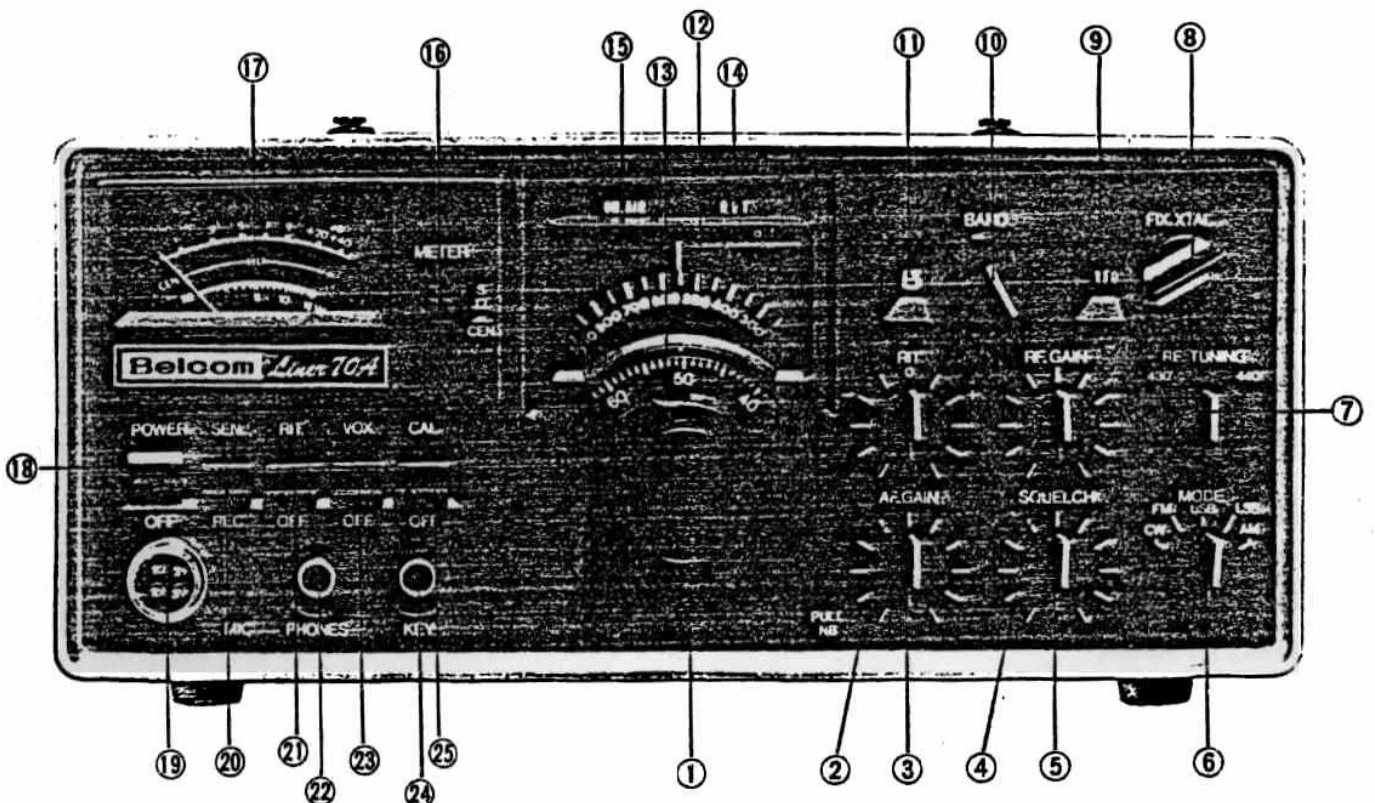

(1) MAIN TUNING KNOB

- o This is a knob for tuning the frequency to a desired value.
- o Double construction
100KHz (OUTSIDE) per revolution and 25KHz (INSIDE)

(2) RIT

- o This is a knob for making fine adjustment on frequency only at the time of reception.
- o The operation of RIT circuit is turned on or off by means of RIT switch of (21).
- o When RIT knob pointer is located at position "0", transmitting and receiving frequencies will be in accord with each other.
- o The receiving frequency can be changed by approx. ± 2 KHz regardless of transmitting frequency.

(3) AF GAIN, PULL NB

- o This is a knob for adjustment on volume at the time of reception.
- o When turned clockwise, the volume will be increased. When turned counterclockwise, it will be decreased.
- o When this knob is pulled out towards the front, the noise blanker will be turned ON.

(4) RF GAIN

- o This is a knob for gain adjustment of amplifiers at RF and IF stages.
- o When turned clockwise, gain will be increased. When turned counterclockwise, it will be decreased.
- o Use it usually by turning it fully in the clockwise direction.

(5) SQUELCH

- o This is a knob for adjustment on operating point of SQUELCH for cutting noise at no-signal time.
- o It is operated only when it is at FM mode.
- o When turned counterclockwise fully, the SQUELCH will be released.
- o When turned clockwise, the squelch will be closed, cutting off noise.
- o Turning it slowly clockwise, be sure to use it at such a position where noise is cut off.

(6) MODE

- o This is a change-over switch for radio wave types.
 - o CW ----- Transmitting and receiving of telegraph (A1)
 - o FM ----- Transmitting and receiving of FM (F3)
 - o USB ----- Transmitting and receiving of UPPER SIDE BAND (A3J)

USB is usually used at 430
MHz band.

- o LSB ----- Transmitting and receiving
of LOWER SIDE BAND (A3J)
- o AM ----- Transmitting and receiving
of AM (A3)

(7) RF tuning

- o This is a knob for adjustment on RF tuning circuit at the time of reception.
- o This unit has used a tuning circuit having BAND PASS characteristics of 10MHz width. The tuning of this knob is broad.
- o When the input signal is small, adjust it to the best point by this knob.

(8) FIX X'TAL (9) Indicating window

- o This is a change-over switch for fixed frequencies (crystals) and incorporated VFO.
- o The position of the switch is indicated in the indicating window (9).
- o When the switch is at VFO:
 - 1) "VFO" is indicated at indicating window (9).
 - 2) The lighting lamp of the frequency indicating scales (12) (13) is lighted.
 - 3) VFO is operated.
- o When the switch is fixed frequency (crystal)

- 1) "1" - "10" is indicated in the display window (9).
- 2) The illuminating lamps of the frequency indicating scales (12) and (13) are put out.
- 3) The fixed crystal oscillating circuit is operated.
- 4) When no crystal pc. is put in the fixed crystal oscillating circuit, the illuminating lamp of the indicating window (9) will be put out.

* FIX X'TAL for 10 channels can be set.

They are operated in common for each band. This unit has 10 bands, resulting in totalling 100 channels.

(10) BAND (11) Indicating window

- o This is a switch for changing over bands.
- o Change-over is effected over 430 MHz - 440MHz in a step of 1 MHz.
- o The frequency of each band is indicated in the indicating window (11) in "0" - "9".
- o The relations between indication and frequency are as follows:

<u>DISPLAY</u>	<u>FREQUENCY</u>
0	430MHz
1	431MHz

2	432MHz
.	.
.	.
.	.
.	.
.	.
8	438MHz
9	439MHz

(12) Main scale for indicating frequencies

- o In a scale of 0 - 1000, frequencies of 100KHz's are shown.

(13) Frequency indicating sub-scale

- o In a scale of 0 - 100, a frequency of 1 KHz's is indicated.

(14) RIT indicator

- o When RIT switch (21) is turned on, it will be lighted.

(15) ON AIR indicator

- o It is lighted at a transmitting state.

(16) METER

- o This is a change-over switch for meters
- o Change-over is effected from center meter to S meter by means of the push switch.
- o This switch is operated only at a FM mode. In other modes, it becomes a S meter (at reception) regardless of switch position.

(17) METER

- o This unit is operated as S meter or center meter when the meter switch (16) is changed over at reception.
- o Intensity of transmitting output signal is indicated at the time of transmission.

(18) POWER

- o This is an ON/OFF switch for power source.
- o AC and DC powers can be turned on or off by this switch.

CAUTIONS

When the power switch is turned OFF, the pilot lamp will be put out a bit delayed. This is attributable to the regulator circuit, not due to the trouble of the set.

(19) MIC

This is a connector for connection of the microphone.

(20) SEN-REC

- o This is a switch for changing over of transmission and reception
- o SEN TRANSMISSION
- o REC RECEPTION
- o When the set is at a receiving state with this switch placed at position "REC" and

the PTT switch of the microphone is pushed, it will be ready for transmission.

CAUTIONS.

When the power switch of the set is turned on, be sure to place this switch at position "REC" (lower side) and turn on the power.

When the power is turned on with the switch located at SEN side (Up side), the power switch will become poor in contact or other troubles will be caused.

(21) RIT

- o This is a switch for turning ON and OFF of the RIT (RECEIVING INCREMENTAL TUNING).
- o With RIT switch at position "ON", only the receiving frequency can be adjusted finely with RIT knob (2).
- o With RIT switch at position "OFF", transmitting and receiving frequencies will be in accord regardless of the position of RIT knob (2).

(22) PHONES

- o Jack for head phone (8 - 16Ω)
- o When the head phone plug is inserted, the speaker will be turned off.

(23) VOX

- o This is a switch for turning on and off the voice

control circuit.

- o When the switch is turned on, transmission and reception by voice can be changed over.
- o When it is at CW mode, it will become a semi-break-in system.
- o With the switch located at OFF position, transmission and reception are changed over by PTT switch of the microphone or SEN switch (20).

(24) KEY

- o At CW mode, this is a jack for connection of the key.

(25) CAL

- o This is an ON/OFF switch for 100KHz calibrator.
- o By bringing down the switch to CAL (upper side), the frequency indication sub-scale is calibrated.

5-2. Back panel

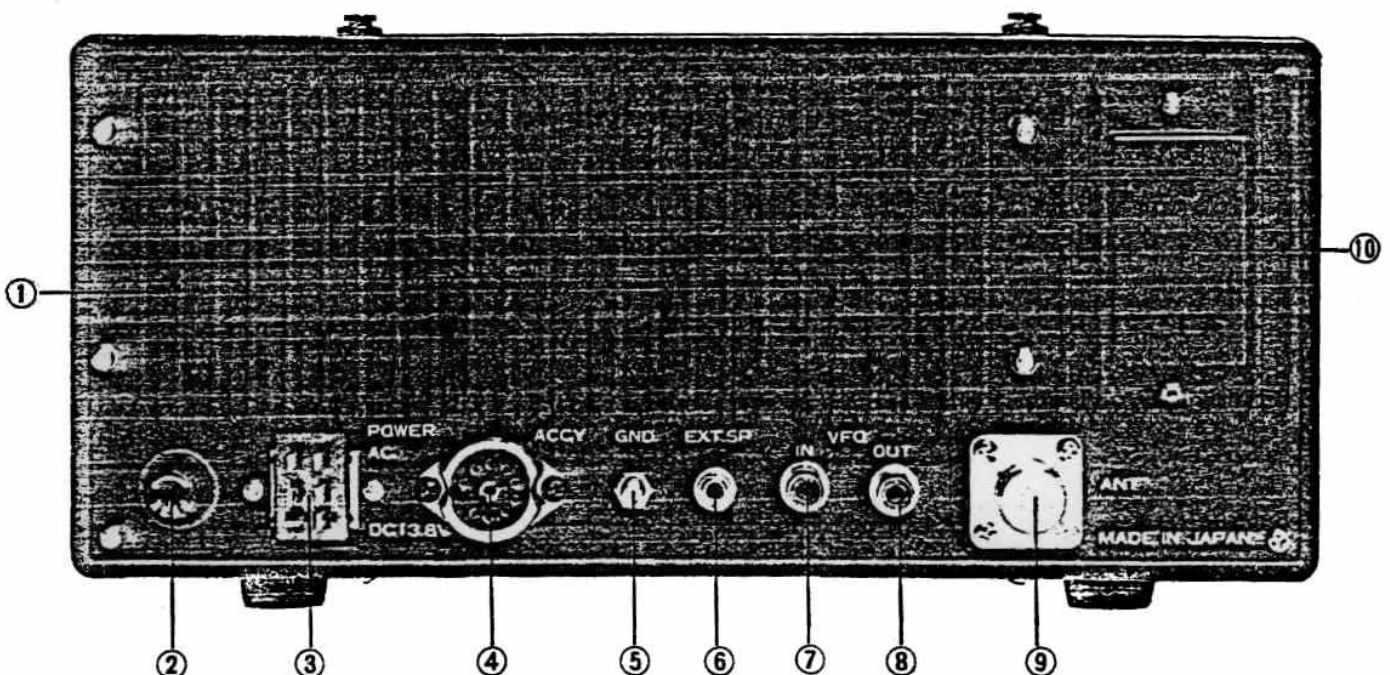

(1) TX PA section heat sink

- o This is a heat sink for heat radiation at transmitting straight heat amplifier section.

(2) Fuse holder

- o AC power fuse holder.
A fuse of 3A is used.

(3) POWER (AC 100V, DC 13.8V)

- o This is a connector for power source.
- o Connect the attached AC power cord or DC power cord.

(4) ACCY

This is a socket for accessories.

(5) GND

This is a terminal for earthing the set.

(6) EXT. SP

- o This is a jack for connection of an external speaker.
- o Use the attached small type plug.

(7) VFO IN

- o When external VFO is used, use this connector.
- o Inputs in a range of 8.5 MHz - 9.5MHz are required.

(8) VFO OUT

- o An output of 8.5 - 9.5 MHz is produced from the incorporated VFO.
- o Use this when the external set is controlled with the incorporated VFO.

- o Usually, VFO IN (7) and VFO OUT (8) are jumpered inside.

(9) ANT

- o This is a N type connector for connecting the antenna.

Read the text for the details of the antenna and cable.

(10) Heat sink for regulator

- o This is a heat sink for 13.8V regulator.

6. OPERATING METHOD

6-1. How to read the frequency.

- o When VFO is used and the unit is operated, read off the frequency as follows:

(MHz's) ----- Read the indicated value in
the band indicating window

(11) (FIG. 8)

- o Relations between indication and frequency

(INDICATION)	(FREQUENCY)
0	430MHz
1	431MHz
.	.
.	.
.	.
8	438MHz
9	439MHz

FIG. 8

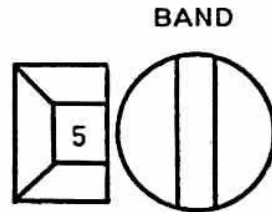

EXAMPLE 435MHz

(100KHz's) ----- Read off the indicated value of the frequency indicating main scale (12).
(FIG. 9)

FIG. 9

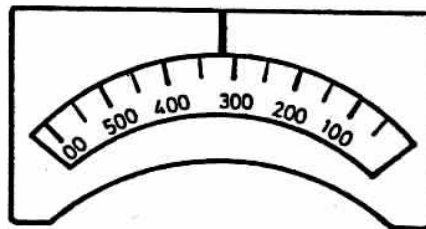

EXAMPLE 300KHz

(KHz's) ----- Read off the indicated value of frequency indicating sub-scale (13).
(FIG.10)

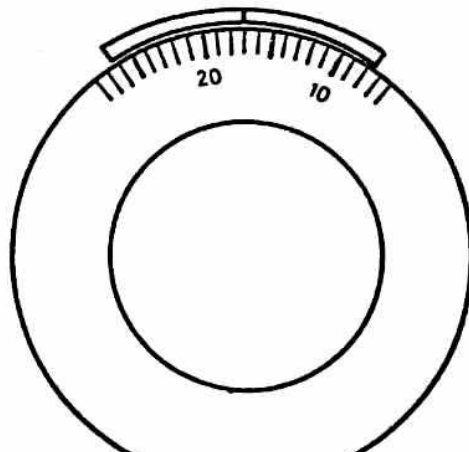

FIG. 10

EXAMPLE 17KHz

o From examples of FIG. 8, FIG. 9 and FIG. 10:

- o MHz's ----- 5
- o 100KHz's ----- 300
- o KHz's ----- 17

When converted to the frequency, it will become
435.317MHz.

6-2. Calibration of frequency indicating scale

6-2-1. Calibration of SSB

- (1) In SSB, the frequency of carrier indicates the frequency.
- (2) Bring down CAL switch (25) to the CAL SIDE.
- (3) Adjusting the frequency indicating main scale to an optional frequency near 100KHz, turn the main tuning knob (1) (INSIDE) slowly and receive a signal of the calibrator in order to make zero beat.

* How to make zero beat.

The beating sound of the calibrator changes from a high pitched tone to a lower one and

changes to a trembling noise just before zero beating. Turn it slightly from that point and find the position where no sound is heard.

- (4) At this state, push the sub-scale (13) and turn it and adjust it to the scale "0". (FIG. 11)

CAUTIONS

After providing a bezo beat, when the sub-scale is turned, hold it with other fingers so that the main tuning knob is not turned.

SCALE CALIBRATION FIG. 11

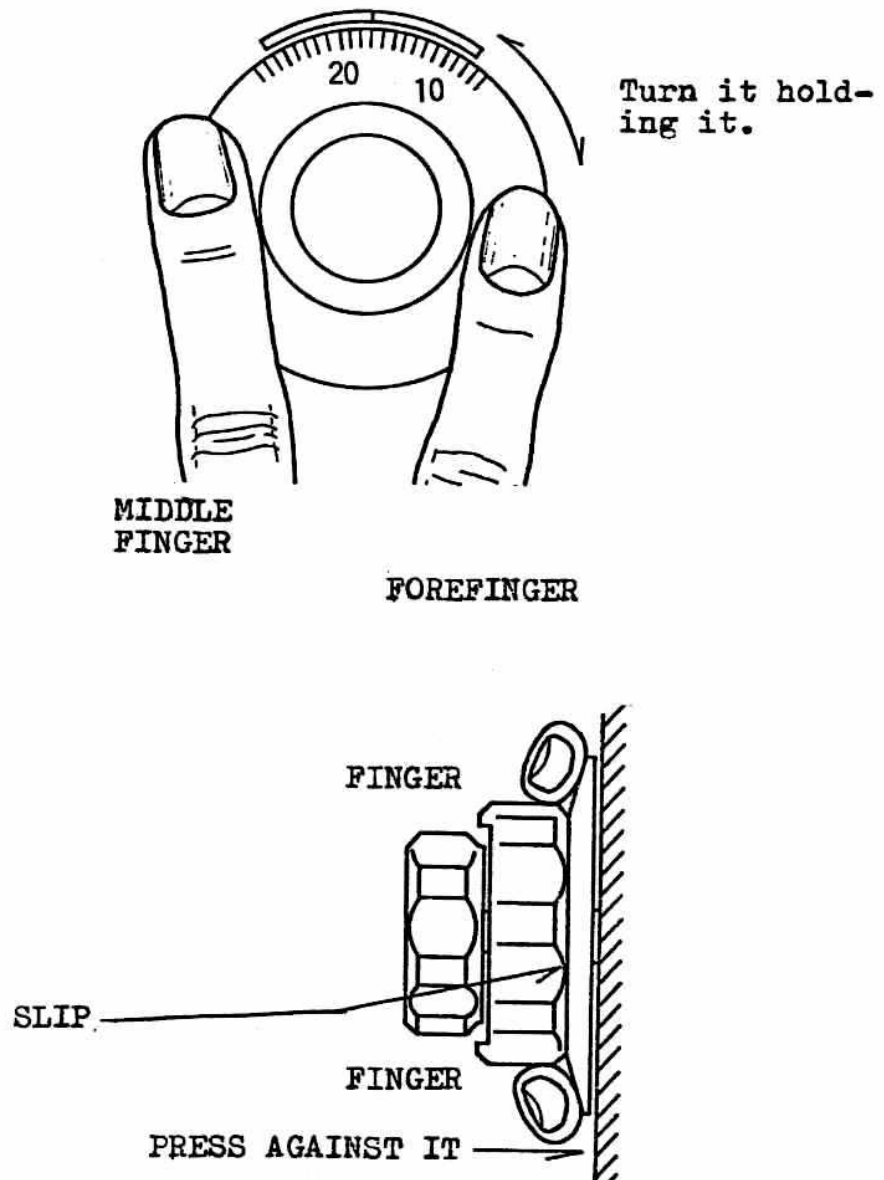

(CAUTIONS)

When zero beating is provided, a slight beating sound might be heard at sides of zero beat sometimes. This phenomenon develops attributable to the following.

That is, in order to use the calibrator up to 430MHz, a slight phase difference is caused between both when 10MHz and 100KHz generated by dividing the frequency of the former are synthesized. For this reason, this phenomenon develops.

For the same reason, there are strong and weak points in beat of 100KHz's. These phenomena are not attributable to the trouble of the receiver.

(CAUTIONS)

Between LSB and USB, the position of carrier deviates by 3KHz. Recalibration must be made separately.

6-2-2. Calibration of CW

(1) The calibration procedure is same as that for SSB. The oscillating frequency of the carrier for transmission is 10.7MHz. The BFO frequency for reception (USB carrier is used) is 10.6985 MHz. It is higher by 1.5 KHz.

(2) Accordingly, in the same way as SSB, after making zero beat calibration, set the sub-scale at the position which is higher 1.5 KHz (1 scale division and 1/2) from "0".

6-2-3. Calibration of AM

- (1) The carrier for transmission of AM is the same frequency as CW.

Calibrate it in the same procedure as CW.

- (2) Different from CW, no beat is produced in CW.

To begin with, place the mode to CW, make zero beat calibration in the same way as CW and return it to AM mode.

6-2-4. Calibration of FM

- (1) No beat is produced in the same way as AM.

Upon receiving a signal from the calibrator, adjust it to the point where the signal is maximum.

- (2) Adjust the meter change-over switch to the center meter. Adjusting to the point where the indicated value of the center meter is CENTER "0", adjust it to the "0" of the sub-scale.

(CAUTIONS)

After completion of calibration, turn off the CAL switch.

6-3. Before operation (Use of UHF band)

- o For operation of 430MHz band, JARL (JAPAN AMATEUR RADIO LEAGUE) has established the regulations

concerning the allocation of use.

- o LINER 70A is an all-mode unit covering 430MHz-440MHz. Therefore, it must be operated according to the established rules, taking care not to interfere other stations or to cause disturbance.

ALLOCATION OF USE OF 430MHz

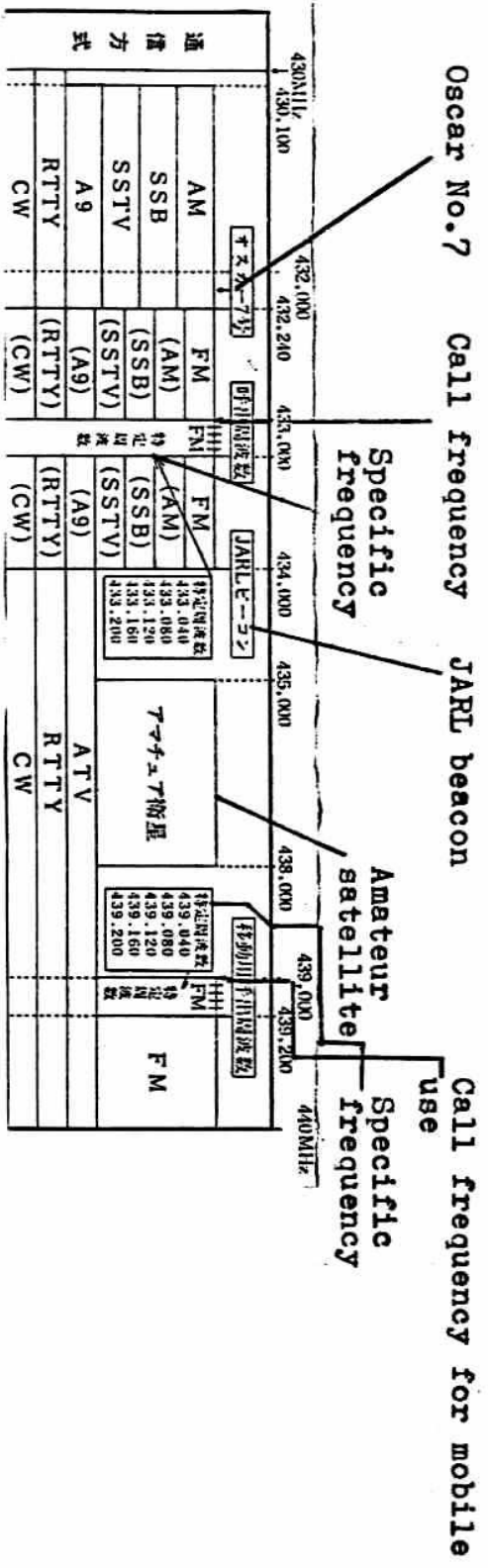

Communication system

Bandwidth

Remarks

2KHz or less 6KHz or less 30KHz or less (In ATV, the standard is less than 6MHz)

Moon surface reflecting communication on FM

Mainly, operated for mobile use

Special for mobile use

Limited to ATV, RTTY, CW and satellite communications. In those systems corresponding to satellite are adopted out of all systems.

Operated mainly on FM

6-4. How to make reception

6-4-1. Preparation

o After preparing the antenna and power, set the switches and knobs in the following procedure.

- (1) POWER switch (18) ----- OFF (LOWER SIDE)
- (2) SEN-REC switch (20) ----- REC (LOWER SIDE)
- (3) RIT switch (21) ----- OFF (LOWER SIDE)
- (4) VOX switch (23) ----- OFF (LOWER SIDE)
- (5) CAL Switch (25) ----- OFF (LOWER SIDE).
- (6) METER switch (16) ----- S
- (7) NB switch (3) ----- OFF (PUSH IN)
- (8) AF GAIN knob (3) ----- Turn fully counterclockwise
- (9) RIT knob (2) ----- Center of indication "0".
- (10) RF GAIN knob (4) ----- Turn fully clockwise
- (11) SQUELCH knob (5) ----- Turn fully counterclockwise

(12) RF TUNING (7) ----- Center of indication, 12 o'clock direction

(13) MODE switch (6) ----- Desired mode

(14) FIX XTAL switch (8) ----- VFO

(15) BAND switch (10) ----- Desired band

o After making the abovementioned preparation, be sure to connect the antenna and power with each connector.

o Turn on the POWER switch (upper side).

The pilot lamps of METER, MAIN SCALE, SUBSCALE, BAND FIX XTAL are lighted, indicating that the LINER 70A is ready for operation.

o After confirming the abovementioned operations, adjust the knobs as follows.

(1) AF GAIN knob ----- Turning clockwise, set it at an appropriate volume.

(2) MODE ----- Adjust it to the mode to be received.

(3) MAIN TUNING KNOB ----- Turning the knob, tune it to a desired signal. Adjust the S meter to the position "MAX" where it can be heard most clearly.

- (4) RF TUNING knob ----- Adjust it in such a way that the maximum sensitivity can be obtained. Not so effective at the time of strong signal. Use it when the signal is weak.
- (5) RF GAIN knob ----- When the signal is very strong, return it counter-clockwise and use it at an appropriate position. Usually, turn it clockwise and use it.

6-4-2. Reception of CW mode

- o Turn off the RIT switch.
 - o Receiving CW radio wave, adjust the main tuning knob in such a way that the beat is 1500Hz.
 - o Then, the receiving frequency is in accord with the transmitting frequency. The frequency is in accord with that of the partner station.
- o USE OF RIT
- (1) After adjusting to the partner station in the abovementioned procedure, if beat is high, turn on the RIT switch and use RIT knob in order to obtain a desired beat. (Generally speaking, 800

- 900Hz are said to be ideal for listening)

- (2) For the call transmitted by your station, if the partner station responds by a beat of 1500Hz, the frequencies of both stations will be in accord. If responded deviating from 1500Hz, turn on the RIT switch without turning the main tuning knob and adjust it by the RIT knob.

6-4-3. Reception of FM mode

- o Turn the METER switch to CEN.

The meter serves for a center meter and the pointer of the meter indicates "0" at center of the meter.

- o Turning the main tuning knob, adjust it to the partner station. Then, the center meter vibrates once at left or right. It indicates "0" at center when the frequency is adjusted.
- o That is, when adjusted to the partner station in such a way that the indication of the center meter is zero at center, the transmitting and receiving frequencies will be in accord with each other.

(CAUTIONS)

If the deviation of the partner station is wide, voice will be distorted at peak sometimes.

This is because LINER 70A FM mode has been designed on a narrow basis ($\pm 5\text{KHz}$ deviation).

Therefore, it is a trouble.

o USE OF SQUELCH

FM gives a unique noise inherent in FM at no signal.

SQUELCH is used for elimination of this noise.

(1) When the SQUELCH knob is turned slowly clockwise at no-signal state, there will be a point where the noise is cut. Turning the knob clockwise slightly from that point, you will find the point where it is operated at a normal operating state.

(2) When the knob is turned clockwise, the squelch will become deep considerably. When no strong signal is applied, it will not open.

(CAUTIONS)

If the deviation of the partner station is wide (e.g. $\pm 15\text{KHz}$ or more), the squelch will be closed sometimes at peak of voice. This is because the FM mode of the LINER 70A has been designed on a narrow basis. It is not a trouble.

6-4-4. Reception of SSB mode

o Turn the MODE switch to USB.

o Upon receiving SSB radio wave, adjust it in such

a way that the demodulated voice is a natural one. Then, the transmitting and receiving frequencies are in accord with each other.

- o If the demodulated voice is not a normal one even in case the main tuning knob is turned, there will be a possibility that it is LSB. Therefore, change over the MODE switch to LSB.

(CAUTIONS)

In other modes than SSB, a beat is heard, resulting in enabling you to distinguish it from SSB. Then, change it over to other modes.

(CAUTIONS)

In SSB mode of 430MHz, it is a prevailing custom to use USB.

- o In SSB mode, the beginner will find it very hard to adjust frequencies. Use the tuning knob (inside) and turn it as slowly as possible and adjust it in such a way that a natural voice is obtained.

- o USE OF RIT

- (1) After being adjusted to the partner station, if the frequency of the partner station has deviated, do not turn the main tuning knob and turn on the RIT switch. Adjust it by utilizing the RIT knob.

(CAUTIONS)

With the RIT switch turned on, if the indicated value

of the RIT knob is other than "0" at center, no transmitting and receiving frequencies will be in accord with each other.

If new communications are made with another station, be sure to turn off the RIT switch and call it.

6-4-5. Reception of AM mode

- o Turn the main tuning knob, adjust it to the point where the voice of the partner station is natural and the vibration of the S meter becomes maximum.
- o In AM reception, the crystal filter in common use for SSB is used. The pass band becomes narrow and high pitched tone is cut.

After adjusting to the partner station once, turn on the RIT switch and turn the RIT knob. Deviate the frequency slightly, resulting in improvement of clearness.

6-5. How to transmit

- o After gaining mastery of receiving operation, carry out the transmitting operation.
- o For transmission, receive the frequency to be transmitted by your station beforehand and confirm that other stations have not made communications with the station.

6-5-1. Transmission of CW mode

- o Connect the key for CW with the KEY JACK at front panel with the attached plug.
- o Turn the MODE switch to CW.
- o Bring down the SEN-REC switch to the position "SEN" (upper side). Then, the ON AIR indicator at the front panel is lighted.
- o No radio wave is transmitted at this state.
- o When the key is brought down, the radio wave will be transmitted. Therefore, carry out the keying operation.
- o The meter vibrates according to keying.
- o A low frequency oscillator for CW monitor has been incorporated in LINER 70A. Therefore, the keying of your own station can be monitored. Voice of the monitor is adjusted with AF GAIN (front panel).

6-5-2. Transmission of FM mode

- o Connect the attached microphone with the MIC connector at front panel.
- o Turn the MODE switch to the position "FM".
- o Bring down the VOX switch to the position "OFF" (lower side).
- o When the press-to-talk switch of the microphone is pushed or SEN-REC switch is turned to SEN,

the ON AIR indicator will be lighted. At the same time, the pointer of the meter will vibrate, resulting in being ready for transmission.

- o When talking to the microphone, FM radio wave will be transmitted.

6-5-3. Transmission of SSB mode

- o Connect the attached microphone with the MIC connector at front panel.
- o Place the MODE switch to the position USB or LSB. (Usually, USB is used in UHF.)
- o When the press to talk switch of the microphone is pushed or SEN-REC switch is turned to SEN, the ON AIR indicator will be lighted, resulting in indicating the transmitting state.
- o When talking to the microphone, SSB radio wave will be transmitted.
- o The pointer of the meter will vibrate according to the voice.

(CAUTIONS)

For adjustment on microphone gain of SSB, open the upper cover of the case and adjust the knob for adjustment on MIC gain. (FIG. 12)

In LINER 70A, there is ALC (AUTO LEVEL CONTROL) for the microphone amplifier. Place it near the center of revolving angle and do not move it in normal operation.

FIG. 12

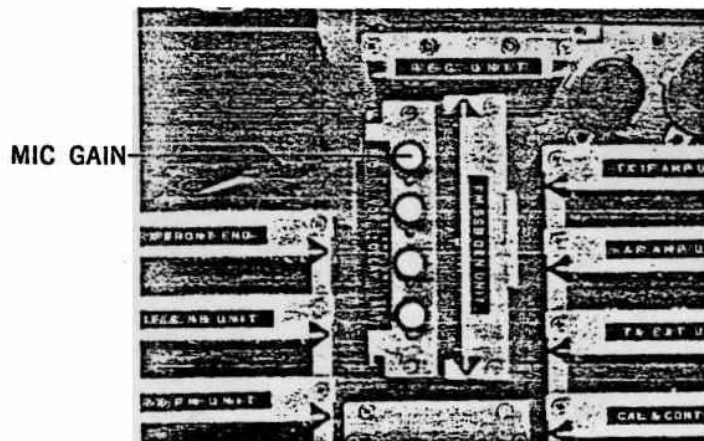

6-5-4. Transmission of AM mode

- o Connect the attached microphone with the MIC connector at front panel.
- o Turn the MODE switch to the position "AM".
- o When the press to talk switch of the microphone is pushed or SEN-REC switch is turned to the position "SEN", the ON AIR indicator will be lighted. At the same time, the pointer of the meter vibrates, indicating the transmitting state.
- o When talking to the microphone, AM radio wave will be transmitted.

(CAUTIONS)

When talked too near the microphone, clearness will become poor.

Separating the microphone 10 - 15 cm from the mouth, talk to it in a normal volume.

(CAUTIONS)

The scale RFO (RF OUT) for indication of the transmitting output of the meter has been adjusted upon connecting with a dummy load before shipment. It is influenced by SWR of the antenna, resulting in poor indication.

Use it for a temporal reference for transmitting output.

6-6. Change-over of transmission and reception

The following methods are available for change-over of transmission and reception of LINER 70A.

6-6-1. SEN-REC switch

o Change-over method by SEN-REC switch (switch (20) at front panel) at front panel

SEN ----- TRANSMISSION
REC ----- RECEPTION

Use it when transmission is made for a very long time or CW is operated.

(CAUTIONS)

When the SEN-REC switch is used, place the VOX switch at lower side.

6-6-2. PTT switch (built-in microphone)

Method by press-to-talk switch of the microphone

PUSH ----- Transmission

RELEASE ----- RECEPTION

Usually, transmission and reception are changed over by this method.

(CAUTIONS)

When PTT switch is used, turn off the VOX switch.

6-6-3. VOX

- o This is a method by which transmission and reception are changed over automatically by voice. The following operations are required.

- o VOX OPERATION OF SSB MODE

To begin with, open the upper cover of the case and there is a knob for adjustment as shown in Fig. 13.

FIG. 13

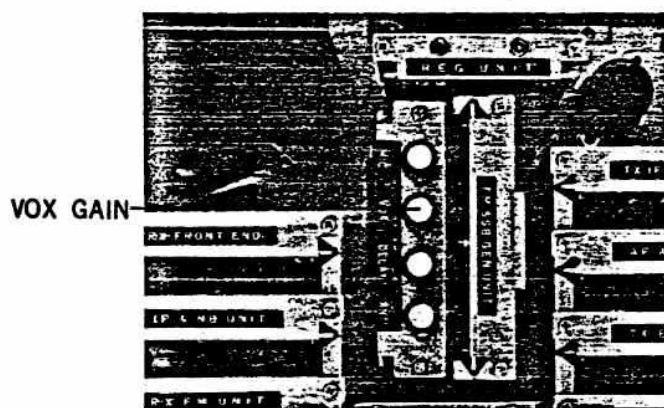

Make adjustment in the following sequence.

- (1) Bring down the VOX switch (front panel) to the position "VOX" (upper side).
- (2) Talk to the microphone in a natural talking volume. Adjust the VOX. GAIN knob in such a way that change-over is effected smoothly without cutting the head of voice.

Separate the microphone approx. 10 - 15 cm from the mouth.

- (3) Stopping talking, adjust the AF GAIN (front panel) in such a way that the volume of the speaker is at normal use condition.
- (4) After finishing the abovementioned adjustment, turn the ANTI knob counterclockwise fully once. (At this state, the sound of speaker enters the microphone and transmission and reception are repeated flappingly.)
Then, when the ANTI knob is turned clockwise slowly, there will be a point where the flapping is stopped. Set the knob at that position.
- (5) Repeating the adjustment mentioned in the abovementioned (2) and (4) several times, adjust it to the best point.
- (6) Finally, adjust the DELAY knob and fix the time for changing to reception after transmission.

Adjust it to the best point in such a way that it is not returned to reception in pauses of words and the head of transmission at partner station is not cut after completion of transmission.

o VOX operation of CW mode (semi-break in)

In the case of CW, change-over is not effected by voice. Transmission is made by keying down. As for adjustment on break-in, adjust the DELAY knob in such a way that it is not returned to reception between letters and words at the time of transmission.

6-6-4. External switch

o Transmission and reception are changed over by the switch mounted on the desk. Connect it with ACCY socket at back panel (FIG. 16).

When the 7-pin and 9pin of ACCY socket are shorted, it will be transmission. When opened, it will be reception.

(CAUTIONS)

When external switch is used, turn off the VOX switch and turn the SEN-REC switch to the position "REC".

6-7. Use of FIX XTAL (fixed frequency)

o An oscillating circuit for use of fixed frequencies

- with crystals has been incorporated in LINER 70A.
- o It displays its full capacity in FM which is used very frequently in the same frequency.
 - o In other club channels and operation on a vehicle and all modes, stable operation can be carried out by crystal control of a desired frequency.

6-7-1. Operating method of FIX XTAL

- o Change over the FIX XTAL switch to a desired channel of "1" - "10" other than "VFO" in the indicating window.
- o By the abovementioned operation, the lamps of MAIN SCALE and SUBSCALE for indication of frequency of VFO are put out and the transmission of VFO is stopped, resulting in indicating that it has been changed over to FIX XTAL.
- o When no crystal has been put in the crystal socket of FIX XTAL, the lamp of the indicating window for indicating the channel will be put out, indicating that no crystal has been put.
- o FIX XTAL channels are in common for each band. Therefore, if 10 channels are fitted, $10 \times 10 = 100$. In a width of 10MHz, 100 channels will be obtained.

(EXAMPLE) When a crystal of 430.35MHz is put, the following 10 channels will be obtained.

430.35MHz

431.35

432.35

⋮

439.35

6-7-2. Calculation of frequency of crystal oscillators for FIX XTAL

o How to fix the desired frequency

The frequencies in MHz's will be those indicated at BAND switch. Therefore, if you fix frequencies lower than 100KHz's, it will be all right.

EXAMPLE

4 3 2 . 1 4 5 MHz

To be selected by the BAND SWITCH MHz. Fix this frequency. With this as X, express it in a unit of MHz.

Make calculation as follows.

o AM, FM, CW

CRYSTAL OSCILLATING FREQUENCY (MHZ) = 8.5 + X

(EXAMPLE)

Desired frequency 432.145 MHz

Crystal oscillating frequency = $8.5 + 0.145 =$
8.645 MHz

- o SSB
- o USB

$\begin{aligned} \text{CRYSTAL OSCILLATING FREQUENCY (MHz)} &= (8.5 + X) \\ &+ 0.0015 \end{aligned}$
--

(EXAMPLE)

Desired frequency 432.145 MHz

Crystal oscillating frequency = $(8.5 + 0.145) +$
 $0.0015 = 8.6465$ MHz

- o LSB

$\begin{aligned} \text{CRYSTAL OSCILLATING FREQUENCY (MHz)} &= (8.5 + X) \\ &- 0.0015 \end{aligned}$
--

(EXAMPLE)

o Desired frequency 432.145 MHz

o Crystal oscillating frequency = $(8.5 + 0.145) -$
 $0.0015 = 8.6435$ MHz

(CAUTIONS)

When band edge frequencies are used, pay special attention to the following points.

(1) In the case of lower end frequencies e.g.

432.000MHz, FIX XTAL uses 8.5MHz. In the case of BAND "0" (430), it will become 430.000MHz.

The side band wave or frequency deviated part is off-band (deviated from the AMATEURE BAND). Take full care for it.

(2) In the case of upper end frequencies e.g. 435.999MHz, FIX XTAL uses 9.499 MHz. In the case of BAND "9" (439), it will become 439.999MHz, resulting in being off-band as mentioned hereabove.

o Crystal oscillator for FIX is an option.

o Your orders are accepted by our company.

When you place an order with us, specify the transmitting and receiving frequencies and mode.

o When you place an order with the crystal manufacturer directly, specify the following beside the frequency calculated in Item 6-7-2.

1. Name of model ----- HC 25/u
2. Load capacity ----- 30PF±0.5PF
3. Actual resistance ----- 20Ω or less
4. Electrostatic capacity ----- 7.0PF±0.5PF
5. Exciting level ----- 5 mW

6-7. Adjustment method on frequencies of FIX XTAL
2ND LO UNIT FIG. 14

- o CH1 - CH10 shown in the above photo correspond to "1" - "10" of FIX XTAL.

- o The indication of each CH in the photo shows the position of parts to be lined up on the pull-out line in the order of 10K Ω resistance, crystal oscillator, socket, trimmer capacitor from the left.
- o Adjustment on the oscillating frequency of crystal oscillator is made in the following procedure.
 - (1) Pull out 2ND LO UNIT from the LINER 70A. Insert the crystal oscillator of a desired frequency into the socket.
 - (2) Connect the power DC 9V (as it is located at ACCY socket PIN 8, use it) with TP1 at photo.
 - (3) Connect a frequency counter by which counting can be made up to 10MHz, with TP2 in Photo.
 - (4) Prepare a lead with a clip at each end of 15 - 20 cm. Hold between the earthing surface of the printed board with a clip at one side. Holding the lead of 10K Ω resistance of CH inserted to the crystal oscillator with a clip at the opposite side, earth it.
 - (5) Adjusting the trimmer capacitor corresponding to the socket inserted into the crystal oscillator, adjust it to a desired frequency.

6-8. OSCAR satellite communications

2 units of amateur radio communication satellites OSCAR NO.6 and OSCAR NO.7 are making their orbits. Taking advantage of B mode of OSCAR NO.7 out of these two satellites, satellite communications can be made by LINER 70A.

- o The frequencies of B mode are as follows:

UP LINK	DOWN LINK
(Oscar No.7 from ground)	(From OSCAR NO.7 to ground)
432.125MHz	145.975MHz
'	'
432.175MHz	145.925MHz

As seen from the abovementioned frequency relations, a signal transmitted in 432 MHz band is turned over (heterodyne of difference) at a repeater of OSCAR NO.7. Then, it is sent back in 145 MHz band.

As the mode is also turned over, when transmitted in USB, it will be sent back in LSB.

- o Take for instance, when uplinked with 432.15MHz USB, it will be down linked in 145.95 MHz LSB.
- o When satellite communications are made taking advantage of B mode of OSCAR NO.7, a receiver of 2 m (by which 145.925 - 145.975 MHz can be received) will be required. (LINER 2DX etc.)
- o OSCAR NO.7 is provided with a repeater and a transmitter for transmitting a beacon.

Upon receiving a beacon radio wave, you can know the condition of the satellite.

BEACON FREQUENCIES OF OSCAR NO.7

29.502 MHz

145.975 MHz

435.10 MHz

- o Referring to the orbit information, satellite communication guide and other reference literature shown in CQ HAM RADIO etc. every month, enjoy satellite communications.

RECOMMENDED REFERENCE LITERATURE:

- o AMATEUR SATELLITE COMMUNICATION

EDITED BY JAPAN AMSAT

Published by CQ Publishing Co.

(CAUTIONS)

- (1) The usable mode of B mode of OSCAR NO.7 is SSB and CW. Do not transmit on other modes.
- (2) The radio wave through the satellite reaches DX. Do not interfere other stations by emitting useless radio waves.

7. Attached circuits

7-1. ACCY socket

FIG. 16

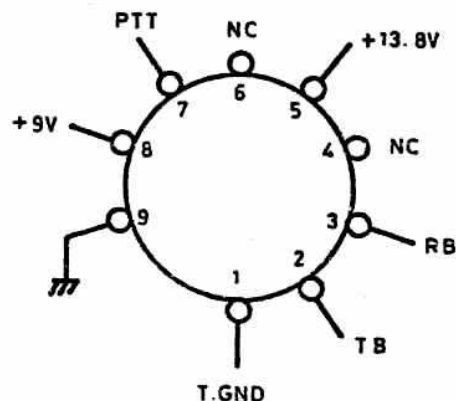

The connection of ACCY socket is as shown in Fig. 16.

- PIN 1. T.GND ----- At transmission, it drops
to the earth. At reception,
it is opened.
- PIN 2. TB ----- At transmission, +9V 100mA
is produced.
At reception, it is 0V.
- PIN 3. RB ----- +9V 100 mA is produced at
reception.
At transmission, it is 0V.
- PIN 4. NC ----- NON-CONNECT
- PIN 5. +13.8V ----- Regardless of transmission
and reception, +13.8V 200mA
is always produced.
- PIN 6. NC ----- NON-CONNECT
- PIN 7. PTT ----- When this pin is earthed,
transmission will be made.
When opened, reception will
be made.
- PIN 8. +9V ----- Regardless of transmission
and reception, +9V 100 mA
is always produced.
- PIN 9 EARTH ----- The chassis is earthed.

7-2. VFO OUT, IN

o VFO OUT

An output of 8.5MHz - 9.5MHz of the built-in VFO is produced.

o VFO IN

An input terminal of VFO

When 8.5 - 9.5 MHz of external VFO etc. is connected with this connector, frequency control can be exercised at outside.

(CAUTIONS)

OUT and IN are jumpered at inside. When this jumper is removed, frequency control can not be exercised at the built-in VFO. When usually used, do not remove the jumper.

7-3. CW monitor

- o A low frequency oscillator for monitoring use has been incorporated in LINER 70A in order to use on CW mode. This oscillator can be used as a CW training apparatus.

When used as a CW training apparatus, carry out the operations as follows.

1. Insert the key into the KEY JACK.
2. Turn the MODE switch to CW.
3. Turn the SEN-REC switch to REC (lower side)
4. Turn off the VOX switch (lower side).
5. Turn the RF GAIN knob counterclockwise fully.

6. Adjust the AF GAIN knob to the best volume.

After finishing the abovementioned operation, key it down and you can hear a sound of "peeee ---".

At this state, only the sound of monitor is emitted without emitting a radio wave.

8-1. Block diagram

Fig. 17 is a block diagram of LINER 70A. Each circuit has been unitized and can be set or removed at connector.

A double conversion system of No.1 intermediate frequencies 46.7 - 47.7 MHz and No.2 intermediate frequencies 10.7 MHz has been adopted for SSB, CW and AM. A triple conversion superheterodyne system adding No.3 intermediate frequency 455 KHz has been adopted for FM.

A crystal filter system of 10.7MHz has been adopted for SSB in the transmitter section. A low power modulation system has been adopted for AM. A variable reactance frequency modulating system has been adopted for FM. A semi-break-in system has been adopted for CW.

Crystal oscillating frequencies

o Carrier oscillation

USB 10.6985 MHz

LSB 10.7015 MHz

FM, AM, CW 10.7 MHz

FM unit	10.245 MHz	
Calibration	10.0 MHz	
2nd local	33.45 MHz	
1st local	430	39.80833 MHz INDICATION X 1
	431	39,89166 X 2
	432	39,97500 X 3
	433	40,05833 X 4
	434	40,14166 X 5
	435	40,22500 X 6
	436	40,30833 X 7
	437	40.39166 X 8
	438	40.47500 X 9
	439	40.55833 X 10

8-1-1. SSB FM GEN

The following circuits have been incorporated.

o Carrier oscillating circuit

At the time of transmission, it is operated as carrier for SSB (USB or LSB).

At the time of reception, it is operated as BFO of SSB, CW.

At CW, USB crystals are oscillated to be BFO.

o Ring modulating circuit

It consists of a ring modulating circuit employing 4 pcs. of diodes and a buffer circuit of FET one stage.

DSB is generated at this circuit.

o 10.7MHz crystal filter circuit

It consists of a crystal filter for SSB of 10.7 MHz and an amplifier of 1 stage of transistors. This circuit is used in common for both transmission and reception. Change-over is effected by the diode switch. At transmission, DSB is made pass through this filter to be SSB.

o AM, CW, FM carrier oscillating circuit

It is a crystal oscillating circuit of 10.7 MHz. It is used as a carrier for AM, CW, FM at the time of transmission. At the time of FM, modulation is applied to this oscillating circuit in order to obtain FM radio waves.

8-1-2. 2ND LO

The following circuits have been incorporated.

o 33MHz crystal oscillating circuit

It consists of a 33.45MHz crystal oscillating circuit and a multiplier circuit for multiplying it to 66.9 MHz. This crystal oscillating circuit uses variable capacitance diodes, resulting in enabling you to make fine adjustment on the oscillating frequency. It is operated as RIT.

o Mixer circuit

Mixing 66.9MHz from the abovementioned circuit

with 8.5 - 9.5 MHz from VFO or FIX XTAL circuit, No.2 local oscillating frequency of 57MHz's is produced at this circuit.

This circuit consists of a mixer and one stage of buffer.

o FIX XTAL oscillating circuit

This circuit consists of FIX XTAL oscillating circuit, a buffer and an oscillating detecting circuit. Crystals are changed over by means of a diode switch.

8-1-3. TX IF AMP

This unit consists of a mixer and an amplifier of one stage of transistors. Mixing a signal of 10.7 MHz from SSB FM GEN with No.2 local oscillating frequency of 57MHz's from 2nd LO, a transmitting intermediate frequency signal of 47MHz's is produced.

8-1-4. TX EXT

This unit consists of one stage of buffer amplifier of No.1 local oscillating frequency, one stage of amplifier of 47MHz's, APC (AUTO POWER CONTROL) and an AM modulating circuit.

The APC is operated with a signal fed back from ANT terminal and transmitting power is controlled.

8-1-5. 1ST LO OSC

This consists of No.1 local oscillating circuit, 10 pcs. of crystal, a diode switch for changing over of them and a multiplier circuit. Oscillating a frequency of 40MHz's, it is multiplied by 4 in order to produce a frequency of 160MHz's.

8-1-6. 1ST LO MULT

This consists of one stage of amplifier of 160MHz's, one stage of multiplier circuit and one stage of amplifier of 480 MHz's.

Multiplying the local oscillating signal of 160MHz's from 1ST LO OSC by 3, a frequency of 480 MHz's is produced and amplified to be No.1 local oscillating signal.

8-1-7. TX PA

This consists of a mixer circuit and 5 stages of straight amplifiers. Mixing No.1 local oscillating frequency from TX EXT with the transmitting intermediate frequency of 46MHz's, a transmitting signal of 430MHz's is produced. Upon amplifying it straightly, an output of 10W is obtained. A strip line is used for the tuning circuit at straight amplifier section, resulting in providing band pass characteristics of 430 - 440MHz.

(CAUTIONS)

PA section is a wide band amplifier of 10 MHz width. Therefore, do not turn the trimmer.

8-1-8. ANT. SW. & B.P.F.

A band pass filter of distributing constant type and a diode switch for changing over the antenna are housed in one case. The case has been silver plated.

The band pass filter is used in common for transmission and reception and has a width of 10 MHz.

8-1-9. RX FRONT

It consists of one stage of high frequency amplifier by dual gate MOS Type FET, a modified balanced mixer and 2 stages of No.1 intermediate frequency amplifiers.

A signal of 430MHz band from the antenna is amplified in one stage and mixed with No.1 local oscillating frequency of 480MHz's, resulting in providing No.1 intermediate frequency of 46MHz. Then, it is amplified in 2 stages furthermore.

8-1-10. IF & NB

This consists of a mixer, 2 stages of 10.7 MHz amplifiers, a noise blanker circuit.

Mixing a No.1 intermediate frequency of 46MHz's from RX FRONT and No.2 local oscillating frequency of 57 MHz's from 2ND LO; a No.2 intermediate

frequency signal of 10.7MHz is produced.

No.2 intermediate frequency signal of 10.7MHz is amplified in two stages and it passes through the noise blanker switching diode.

The noise blanker is turned on and off by an external switch. When a pulse noise like ignition noise is fed, it will synchronize with the pulse noise, resulting in turning on or off the switching diode and removing the noise.

8-1-11. DET & AGC

This consists of one stage of amplifier of 10.7MHz, a balance type demodulating circuit and an AGC circuit.

SSB, CW, AM signals passing through the crystal filter are amplified in one stage and enter the demodulating circuit.

A BFO signal is added at SSB and CW and demodulated as AF. After being amplified in one stage, AGC is rectified and AGC voltage is taken out.

8-1-12. RX FM

This consists of a mixer, a No.3 local oscillating crystal oscillating circuit, a ceramic filter, a 455KHz amplifier circuit, a limiter, a ceramic discriminator and a squelch circuit.

10.7MHz FM wave from IF & NB is converted to 455 KHz at a mixer.

After passing through the ceramic filter, it enters the ceramic discriminator through an amplifier circuit limiter, resulting in being demodulated.

The noise amplifying detection and carrier amplifying detection are used in common for squelch, preventing the squelch from flapping at over deviation.

8-1-13. AF AMP

A low frequency amplifier circuit employing IC and a differential circuit of FM center meter are incorporated.

The output of the low frequency amplifier circuit is 2W at 8Ω load.

8-1-14 VFO

This consists of a transistor oscillating circuit and a FET buffer circuit. 8.5 MHz - 9.5MHz are oscillated.

(CAUTIONS)

A technique of high-level is required for adjustment on VFO such as temperature characteristics, frequency linearity etc. Do not touch internal circuits and parts.

8-1-15. MIC VOX AMP

This consists of a low frequency ALC circuit, a microphone amplifier circuit, FM.IDC circuit, a VOX circuit

and a CW monitor circuit.

There are 4 volumes for adjustment such as MIC GAIN, ANTI, VOX GAIN, DELAY in the printed circuit board.

8-1-16. CAL & CONT

This consists of a change-over circuit for reception and transmission as well as a 100KHz calibration circuit.

The change-over circuit for transmission and reception is controlled with signals from the VOX circuit of MIC VOX AMP and PTT switch.

At transmission, it is changed over to TB (at transmission +9V) and at reception, it is changed over to RB (at reception +9V).

8-1-17. REG

A power stabilizing circuit of 13.8V or 9V has been incorporated. When DC power is used, the stabilizer circuit of 13.8V will not be operated.

9. Trouble shooting

LINER 70A is a finished product, resulting in requiring adjustment. In order to adjust the related sections completely, highly accurate measuring instruments and high technique measurement are required.

Without measuring instruments, be sure to avoid turning the related adjusting points. The following symptoms are not troubles. Be sure to check them well. If no trouble is corrected when countermeasures are taken according to the following TROUBLE SHOOTING TABLE, contact the dealer or the SERVICE SECTION, DOMESTIC ENTERPRISE DIVISION of our company.

o RECEPTION

SYMPTOM	CAUSE	COUNTERMEASURE
When the power switch is turned on, no lamp will be lighted or no sound will be given.	1) Poor connection of power cord. 2) The fuse has blown.	1) Put AC plug into the plug socket completely. 2) Insert the power connector completely. 3) Exchange fuses (if blown again, it is attributable to the trouble of the set itself).

SYMPTOM	CAUSE	COUNTERMEASURE
<p>When connected with the antenna, no signal can be received.</p>	<p>1) The change-over switch for reception and transmission is set at TRANSMITTING SIDE and the set is at transmitting state.</p> <p>2) FIX.CH switch is at empty channel (FIX XTAL lamp is put out)</p> <p>3) Imperfect connection of antenna cable and connector.</p>	<p>1) Place the change-over switch for transmission and reception to the RECEPTION SIDE.</p> <p>2) Place the FIX.CH switch at VFO or at position where the lamp is lighted.</p> <p>3) Connect the antenna cable and connector completely.</p>
<p>At FM, S meter vibrates but no receiving sound is received.</p>	<p>The squelch circuit is operated.</p>	<p>Turn the squelch knob counterclockwise.</p>
<p>When SSB is received, no sound is generated.</p>	<p>Wrong side band.</p>	<p>Change over the MODE change-over switch to USB or LSB.</p>

TRANSMISSION

SYMPTOM	CAUSE	REMEDY
No transmitting output is produced.	FIX XTAL switch is at empty channel	Turn the FIX XTAL switch to VFO or to the position where the lamp is lighted.
In the case of SSB, no output is produced.	1) Poor connection of microphone connector. 2) The MIC GAIN VOLUME has been closed.	1) Connect the microphone completely. 2) Turn the MIC GAIN volume inside set clockwise.