

# Guide to Kit Construction

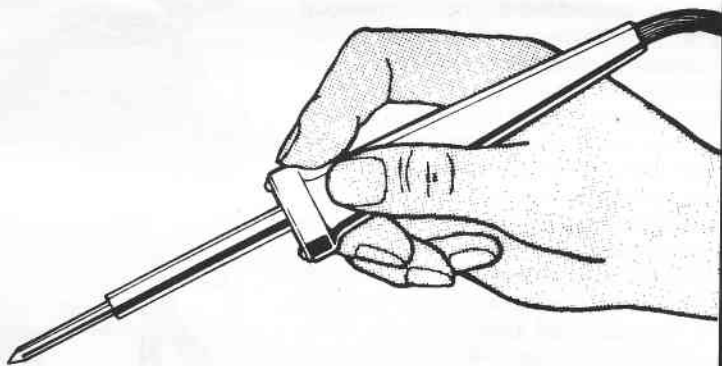

This is a guide for newcomers to kit building. Follow the guidelines given here and your kit will be easier and more enjoyable to assemble and more likely to work first time.

This booklet covers the basics of tools, parts identification, construction methods and trouble-shooting. Details for specific kits are given in each kits' construction manual.

## CONTENTS

Tools .....	2	Schematic Diagrams .....	13
Soldering .....	2	Construction Techniques .....	14
Component Identification .....	4	Using a Multimeter .....	15
Simple Digital Circuits .....	7	Mains Voltages .....	16
Metal Film Resistors .....	8	Missing Parts .....	16
Conversion Charts .....	9/10	Troubleshooting .....	16
Component Identification (cont.) ....	11		

### HANDY HINTS:

#### FOLLOW THE MANUAL

Read each step completely - before starting. Make sure you understand everything that's involved.

#### TAKE YOUR TIME

Allow yourself plenty of time to build the kit. Set aside an area where you can work undisturbed, and can leave the kit between sessions.

#### CHECK YOUR WORK

Refer frequently to the kits' instruction manual, check each step as it is completed.

### TOOLS YOU WILL NEED

Only a minimum of tools are needed for most kits. These are:

- A soldering iron, 10-30 W rating
- Three screwdrivers (one Philipshead)
- A pair of side cutters (small)
- A pair of long nose pliers
- Wire strippers or a knife

Solder is included in the kits. If you buy additional solder make sure that it is 60/40 resin core. Using acid core solders will damage components and invalidate the guarantee. Some kits also involve some metalwork, so access to a drill may be needed. Other tools: spanners, alignment screw-drivers etc. are also needed from time to time. Suitable tools are available from all Dick Smith Electronics stores.

For testing, a multimeter with 20,000 ohms per volt sensitivity is essential.

\*See your nearest Dick Smith store for their latest range of tools and accessories.



### SOLDERING

Poor soldering is the major cause of kits not working. This is simply because most people do not take the time to learn how to solder properly and practise it.

### THE IRON

The soldering iron used should be suited to electronics work. A wattage of from 10 to 30 watts is ideal, with a tip size from 1.5 to 4mm across. A chisel shape is usually best. The tip should be kept clean at all times. The best way

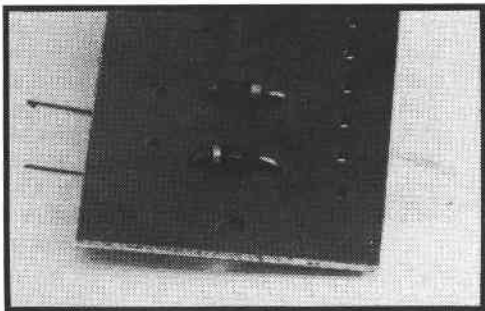

is to keep a damp sponge or cloth handy and wipe the iron on it occasionally. If the tip is pitted it will have to be reshaped by filing (except iron plated tips which must not be filed).

### THE SOLDER

The best solder for general electronics use is 60/40 multicore (60% tin/40% lead with inbuilt resin flux.) SAVBIT is a variation of this type with 2% copper added to improve tip life. 'Acid core' solders must not be used.

### METHOD

The joint must be clean and free from tarnish, lacquers etc. for the solder to adhere properly. If necessary, use sandpaper or a fine file to clean the joint.

Make a good mechanical connection: bend leads of components mounted in printed circuit boards at 45 degrees once inserted: and on wires connecting to switches, terminals etc. at 90 degrees.

Hold the iron as you hold a pencil and apply it to the joint before the solder to pre-heat the joint and the iron. The solder will flow freely when the joint is hot enough. Remove the iron and solder when the solder has flowed across the whole joint. If the solder forms a ball the joint needs more heat.

Don't move anything while the solder is cooling. If you do, re-heat and add a little more solder to ensure a clean joint.

The connection should be shiny and the solder should flow smoothly into it. If it looks cracked or frosty, the joint is dry and must be re-done

If you've never used an iron before, do some practise runs first. Get the feel of the solder flow, and when to apply and remove the solder and the iron.

When soldering semi-conductors and other sensitive components it is a good idea to hold the lead with pliers or a heatsink clip to prevent damage by overheating. This isn't necessary once you can solder fast and reliably.

When it is cool, inspect each joint carefully; look for solder bridges shorting PC tracks, pinholes and cracks in the joints.

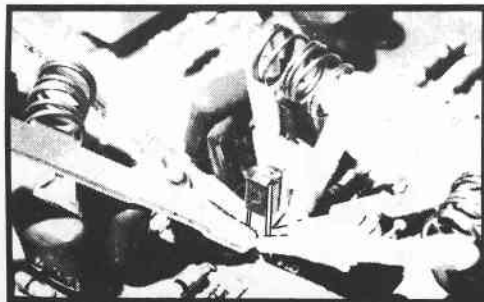
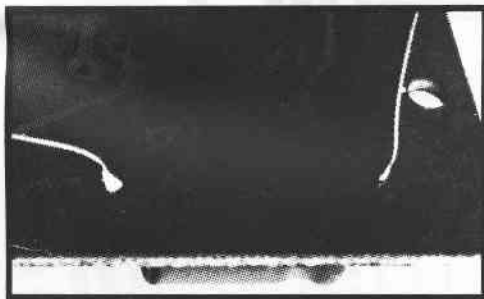
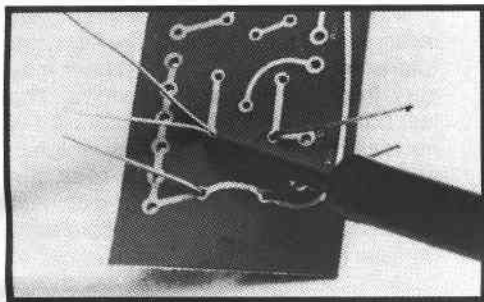

## COMPONENT IDENTIFICATION

One of the biggest problems for the beginner constructor is identifying the components correctly. The main trap is in the maze of numbers put on components by manufacturers. There may be a drawing of the parts in the kit manual, but identifying numbers may not be easy to find on the components themselves. As an example, what is described as a '741' IC may be marked LM741CN, N741T, 741TC, MC1741CP1,

or SN52741N. Confusing, isn't it? Notice though, that there is a '741' somewhere in all the numbers. The other numbers and letters indicate the manufacturer, and various batch and variety codes of the particular manufacturer. All these may be ignored as any of these ICs would work equally well in a circuit.

We will now go through the common components in our kits.

## RESISTORS

So called because they 'resist' the flow of current. They are normally in the form of small cylinders about 10mm long. Some high wattage types are rectangular.

Resistance is measured in ohms, abbreviated to  $\Omega$  or R. Thousands are indicated by 'k', millions by 'M'. Thus a 12k resistor has a resistance of 12,000 ohms.

This value is marked on the resistors using a colour code. The body has

(normally) four stripes. The first three indicate the resistance, the last the tolerance - how much the resistor may vary from its quoted resistance. The last band need not concern us as it is normally gold (5%) in our kits, which is accurate for most uses. To read the colour code, start with the band closest to the end. The first two are the significant figures, and the third is the number of zeros following. The chart below shows the value of the different colours.

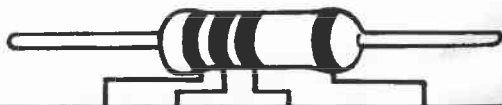
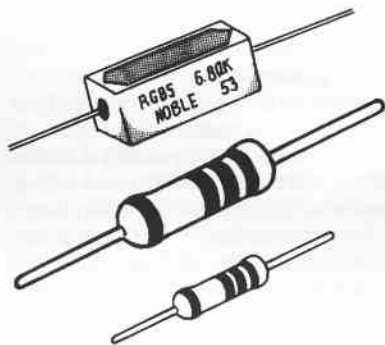

COLOUR	TENS	UNITS	MULTIPLIER	TOLERANCE
BLACK	0	0	1	20% (M)
BROWN	1	1	10	1% (F)
RED	2	2	100	2% (G)
ORANGE	3	3	1000	-
YELLOW	4	4	10000	-
GREEN	5	5	100000	-
BLUE	6	6	1000000	-
VIOLET	7	7	-	-
GREY	8	8	-	-
WHITE	9	9	-	-
GOLD	-	-	0.1	5% (J)
SILVER	-	-	0.01	10% (K)

## POTENTIOMETERS

Potentiometers are variable resistors. There are two main types in kits: normal potentiometers (often called pots) which are used as front panel controls for volume, bass, treble, speed control, etc.; and 'trim pots' which are smaller devices mounted on the circuit board. These are used for initial adjustment of frequencies, levels, etc. and are not normally

adjusted once set.

### TRIMPOT

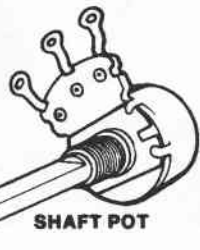

SHAFT POT



CERAMIC



POLYESTER



MYLAR (GREENCAP)



TANTALUM

The positive (+) lead of a tantalum is identified in one or two ways. If colour coded, the right hand lead is positive when facing the dot (see below); or by a row of plus signs (+++) running down the side nearest the positive lead.

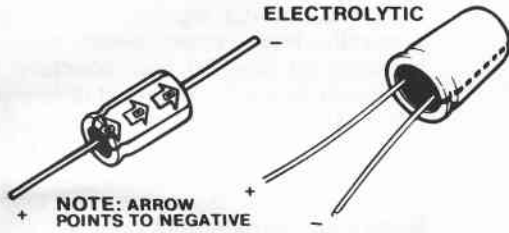

SOLID TANTALUM ELECTROLYTIC

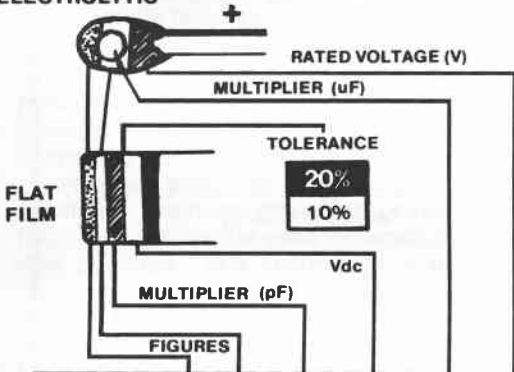

BLACK	0	0	1	-	1	10
BROWN	1	1	1-	1-	-	1.6
RED	2	2	100	250	-	4
ORANGE	3	3	1k	-	-	40
YELLOW	4	4	10k	400	-	6.3
GREEN	5	5	100k	-	-	16
BLUE	6	6	-	630	-	-
VIOLET	7	7	-	-	$10^{-3}$	-
GREY	8	8	0.01	-	$10^{-2}$	25
WHITE	9	9	0.1	-	$10^{-1}$	2.5

## CAPACITORS

Capacitors store a charge. They come in an enormous range of sizes and types with the most confusing identification of all the components.

The most common types are mylar (greencaps), ceramic, electrolytic and tantalum. Some kits also use polystyrene and polyester. Electrolytic and tantalum capacitors are 'polarised', that is, have a positive and negative end which must be installed in the correct direction for the circuit to work.

Capacitance is measured in Farads. This is too large a unit for most uses so various fractions are used: microFarad ( $\mu\text{F}$ ) - a millionth of a Farad; nanoFarad (nF) - a thousandth of a microFarad; PicoFarad (pF) - a thousandth of a nanoFarad. So  $0.01\mu\text{F} = 10\text{nF} = 10,000\text{pF}$ .

Capacitors are marked in all these units - often without indicating which one! Electrolytics and some tantalum capacitors are marked in  $\mu\text{F}$  with the working voltage; ceramics in pF and mylar in pF or  $\mu\text{F}$ .

Many ceramic and mylar capacitors are marked using the IEC capacitor code, a system of three numbers and a letter giving the value and tolerance of a capacitor. The first two numbers are the significant figures, and the third the number of zeros following (value in picoFarads). The letter indicates the tolerance M = 20%; K = 10%; J = 5%. So a 123K is a 12,000pF or 12nF or 0.012 $\mu\text{F}$  10% capacitor.

Some of the larger value greencaps are marked in  $\mu\text{F}$  (usually 0.1 $\mu\text{F}$  and larger). Smaller ceramics are usually marked in pF. This is why many constructors find capacitors confusing!

One more method is used to identify capacitors. Some polyester and tantalum capacitors are marked with a colour code similar to resistors. Refer to the table.



POLYSTYRENE

## DIODES

Diodes are used to convert AC current to DC (rectify), or to detect signals. Most are in the form of a black or clear cylinder 3-10mm long. Diodes are also polarised, with a cathode end (k) and an anode end (a). The cathode is marked with a black or silver stripe, or in some small signal diodes, a white end. Always check that they are installed the right way around.

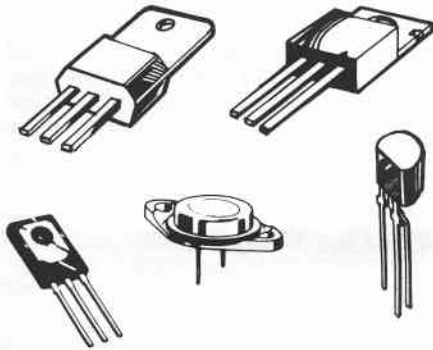
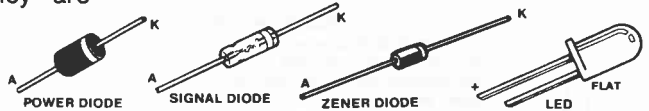

\* ALWAYS FOLLOW THE PIN CONNECTIONS ON THE CIRCUIT DIAGRAM CAREFULLY.

## TRANSISTORS

Transistors are the heart of most solid state equipment. They are used to amplify and switch signals. Transistors generally have three leads called emitter (e), base (b), and collector (c) and come in a wide variety of different cases. Always check that the leads are installed in the correct positions - two transistors may look the same, they may even work the same, but their leads could be differently oriented. The number of a transistor is normally printed on the case. Any other numbers or letters are manufacturers' codes and may be ignored. Typical transistors are illustrated alongside.

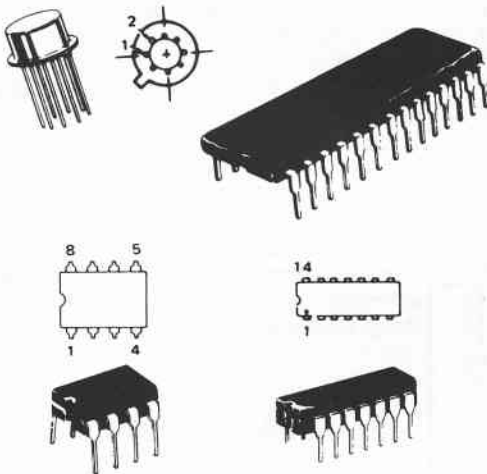

## INTEGRATED CIRCUITS





Integrated circuits are just what their name indicates: a complete circuit in a single package. They perform a wide variety of functions - amplifying, timing, switching, counting - the list is enormous. They are usually packaged in a dual-in-line (DIL) package with from eight to forty pins.

ICs must be installed in the correct direction. One end will be marked with a notch or hole which must be installed as indicated in the circuit layout.

Identifying the right IC can sometimes be difficult due to the maze of numbers printed on them. See the first paragraph of the component identification section for clues to identifying the right IC.

## SIMPLE DIGITAL CIRCUITS

### GATES

SYMBOL	CODE
 <p>INPUTS      OUTPUT</p> <p>"AND" GATE</p>	<p>Output is "on" only when all inputs are "on".</p> <p>Output is "off" when any or all inputs are "off".</p>
 <p>INPUTS      OUTPUT</p> <p>"NAND" GATE</p>	<p>Output is "off" only when all inputs are "on".</p> <p>Output is "on" when any or all inputs are "off".</p>
 <p>INPUTS      OUTPUT</p> <p>"NOR" GATE</p>	<p>Output is "on" only when all inputs are "off".</p> <p>Output is "off" when any or all inputs are "on".</p>
 <p>INPUTS      OUTPUT</p> <p>"OR" GATE</p>	<p>Output is "off" only when all inputs are "off".</p> <p>Output is "on" when any or all of the inputs are "on".</p>

### INVERTERS

SYMBOL	CODE
 <p>INPUT      OUTPUT</p> <p>INVERTER</p>	<p>Output is "on" only when the input is "off".</p> <p>Output is "off" only when the input is "on".</p>

### FLIP-FLOPS

A flip-flop can be compared with a push button switch connected to two lamps. When the button is pushed and released, one of the lamps will turn "on" and the other "off". If the button is again pushed and released, the lamp that was "off" will

now turn "on" and the lamp that was "on" will turn "off". There are many different types of flip-flops, but they all operate basically in the same way. The difference is in the number and type of inputs.

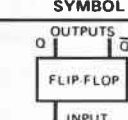
SYMBOL	CODE
 <p>OUTPUTS</p> <p>Q      Q̄</p> <p>FLIP-FLOP</p> <p>INPUT</p>	<p>"Q" output is "on" when "Q̄" output is "off".</p> <p>"Q" output is "off" when "Q̄" output is "on".</p> <p>Outputs change when the input is turned "off".</p>

## LATCH

A latch is a flip-flop designed to store information until it is needed. It has an extra latch input. When the latch is turned on, the information on the input will be transferred to the "Q" output.

When the latch is turned "off", the information that was on the input at the time the latch was turned off, will be stored on the "Q" output.

SYMBOL	CODE
	<p>"Q" output will follow the information input. "Q-bar" output will always be the opposite of the "Q" output.</p>

## COUNTERS

SYMBOL	CODE
	<p>As the input is turned "on" and "off" the count is accumulated on the outputs in either binary or decimal form depending on circuit. Counters are easily cascaded by using the highest output as the next input. When full the counter will automatically reset to zero. To use as an "N" divider the reset pin is connected to the required digit plus one.</p>

## COLOUR CODE FOR METAL FILM RESISTORS

Metal glazed					
Metal Film					
Metal Film (close tolerance)					
	figures	figures	figures	multiplier ( )	tolerance
black	0	0	0	0.01	10% silver
brown	1	1	1	0.1	5% gold
red	2	2	2	1	
orange	3	3	3	10	
yellow	4	4	4	100	
green	5	5	5	1k	
blue	6	6	6	10k	
violet	7	7	7	100k	
grey	8	8	8	1M	
white	9	9	9	10M	
					1% brown
					2% red



**METRIC UNITS AND CONVERSIONS**

Multiply by	← Into	To Convert			Multiply by	Multiply by	← Into	To Convert			Multiply by
		→ Into	→ Into	→			→ Into	→ Into	→		
$2.296 \times 10^{-5}$	Acres	Square feet	$4.356 \times 10^4$		$6.481 \times 10^{-2}$	Grams	Grams	15.43			
$2.471 \times 10^{-4}$	Acres	Square metres	4047		28.35	Grams	Ounces (avdp)	$3.527 \times 10^{-2}$			
$2.778 \times 10^{-4}$	Amperes hours	Coulombs	3600		1.341	Horsepower	Kilowatts	0.746			
$2.54 \times 10^8$	Angstrom units	Inches	$3.937 \times 10^{-9}$		0.3937	Inches	Centimetres	2.54			
$10^{10}$	Angstrom units	Metres	$10^{-10}$		$10^{-3}$	Kilograms	Tonnes	$10^3$			
0.02950	Atmospheres	Feet of water	33.90		0.4536	Kilograms	Pounds (avdp)	2.205			
0.06804	Atmospheres	Pounds per sq. in.	1470		$3.408 \times 10^{-4}$	Kilometres	Feet	3281			
1.0133	Bars	Atmospheres	$9.870 \times 10^{-7}$		$9.4637 \times 10^{12}$	Kilometres	Light years	$1.0567 \times 10^{-13}$			
$6.8947 \times 10^{-2}$	Bars	Pounds per sq. in.	14.504		0.869	Knots	Miles per hour	1.1508			
$(^{\circ}\text{F} - 32) \times 5/9 = ^{\circ}\text{C}$	Centigrade	Fahrenheit	$(^{\circ}\text{C} \times 9/5) + 32 = ^{\circ}\text{F}$		$2.54 \times 10^{-2}$	Metres	Inches	39.37			
$^{\circ}\text{K} - 273.1 = ^{\circ}\text{C}$	Centigrade	Kelvin	$^{\circ}\text{C} + 273.1 = ^{\circ}\text{K}$		0.6214	Miles (statute)	Kilometres	1.609			
$3.531 \times 10^{-2}$	Cubic feet	Litres	28.32		$5.88 \times 10^{12}$	Miles (statute)	Light years	$1.691 \times 10^{-13}$			
$6.102 \times 10^{-2}$	Cubic inches	Cubic centimetres	16.39		1.1508	Miles (statute)	Miles (nautical)	0.869			
$2.832 \times 10^{-2}$	Cubic metres	Cubic feet	35.31		$10^{-3}$	Millimetres	Microns	$10^3$			
0.16667	Fathoms	Feet	6		$2.205 \times 10^{-3}$	Pounds	Grams	453.6			
3.281	Feet	Metres	0.3048		746	Watts	Horsepower	$1.341 \times 10^{-3}$			

**HANDY REFERENCE CHART FOR IMPERIAL TO METRIC CONVERSION**

Inches	Decimal	Millimeters	Inches	Decimal	Millimeters	Inches	Decimal	Millimeters	Inches	Decimal	Millimeters
	1/64	015625	3969			17/64	265625	6 7469			
	1/32	03125	7937			9/32	28125	7 1437			
	3/64	046875	1 1906	19/64	296875	7 5406			35/64	546875	13 8906
1/16	0625	1 5875	5/16	3125	7 9375				9/16	5625	14 2875
	5/64	078125	1 9844			21/64	328125	8 3344			
	3/32	09375	2 3812			11/32	34375	8 7312			
	7/64	109375	2 7781	23/64	359375	9 1281			39/64	609375	15 4781
1/8	125	3 1750	3/8	375	9 5250				5/8	625	15 8750
	9/64	140625	3 5719			25/64	390625	9 9219			
	5/32	15625	3 9687			13/32	40625	10 3187			
	11/64	171875	4 3656	27/64	421875	10 7156			39/64	671875	17 0656
3/16	1875	4 7625	7/16	4375	11 1125				11/16	6875	17 4625
	13/64	203125	5 1594			29/64	453125	11 5094			
	7/32	21875	5 5562			15/32	46875	11 9062			
	15/64	234375	5 9531			31/64	484375	12 3031			
1/4	25	6 3500	1/2	5	12 7000				45/64	703125	17 8594
						15/32	46875	11 9062			
						23/32	734375	18 6531			
						47/64	75	19 0500			
						3/4					
						1					

## Wire sizes

Wire No.	SWG		AWG		BWG		Std metric (ref to swg) (mm)
	(In)	(mm)	(In)	(mm)	(In)	(mm)	
0000	0.40	10.16	0.460	11.68	0.454	11.53	
000	0.372	9.45	0.409	10.41	0.425	10.80	
00	0.348	8.84	0.365	9.27	0.380	9.65	
0	0.324	8.23	0.325	8.25	0.340	8.64	
1	0.300	7.62	0.289	7.35	0.300	7.62	
2	0.276	7.01	0.258	6.54	0.283	7.21	
3	0.252	6.40	0.229	5.83	0.259	6.58	
4	0.232	5.89	0.204	5.19	0.238	6.05	
5	0.212	5.38	0.182	4.62	0.220	5.59	
6	0.192	4.88	0.162	4.11	0.203	5.16	
7	0.178	4.47	0.144	3.66	0.179	4.57	
8	0.160	4.06	0.128	3.26	0.164	4.19	
9	0.144	3.66	0.114	2.90	0.147	3.76	
10	0.128	3.25	0.102	2.59	0.134	3.40	
11	0.116	2.95	0.091	2.30	0.120	3.05	
12	0.104	2.64	0.081	2.05	0.109	2.77	
13	0.092	2.34	0.072	1.83	0.095	2.41	
14	0.081	2.03	0.064	1.63	0.083	2.11	
15	0.072	1.83	0.057	1.45	0.072	1.83	
16	0.064	1.63	0.051	1.29	0.065	1.65	
17	0.056	1.42	0.045	1.15	0.058	1.47	1.5
18	0.048	1.22	0.040	1.02	0.049	1.24	1.25
19	0.040	1.02	0.036	0.91	0.042	1.07	1.00
20	0.036	0.92	0.032	0.81	0.035	0.89	
21	0.032	0.81	0.028	0.72	0.031	0.81	0.8
22	0.028	0.71	0.025	0.64	0.028	0.71	0.71
23	0.024	0.61	0.023	0.57	0.025	0.64	
24	0.023	0.56	0.020	0.51	0.023	0.56	0.56
25	0.020	0.51	0.018	0.45	0.020	0.51	0.5
26	0.018	0.46	0.016	0.40	0.018	0.46	
27	0.016	0.41	0.014	0.36	0.016	0.41	0.4
28	0.014	0.38	0.013	0.32	0.0135	0.356	
29	0.013	0.35	0.011	0.29	0.013	0.33	
30	0.012	0.305	0.010	0.25	0.012	0.305	0.315
31	0.011	0.29	0.009	0.23	0.010	0.254	
32	0.0106	0.27	0.008	0.20	0.009	0.299	
33	0.010	0.254	0.007	0.18	0.008	0.203	0.25
34	0.009	0.229	0.0063	0.16	0.007	0.178	0.224
35	0.008	0.203	0.0056	0.14	0.005	0.127	0.2
36	0.007	0.178	0.0050	0.13	0.004	0.102	
37	0.0067	0.17	0.0044	0.11			
38	0.006	0.15	0.0040	0.10			
39	0.005	0.127	0.0035	0.08			

SWG = Standard wire gauge; AWG = American wire gauge; BWG = Birmingham wire gauge. Diameters in millimetres are derived from original inch sizes.

## CMOS ICs

A special type of IC called CMOS requires careful handling. These are very sensitive to static electricity and come packed on special conductive foam for protection. Always install these ICs last, soldering the power and earth pins first. Make sure your

soldering iron is properly earthed, and avoid touching the pins with your fingers. Follow the instructions in the kit carefully and if you have any doubts about soldering, buy sockets for the ICs.

## TRANSFORMERS

Transformers are used mainly for reducing the 240V mains to a voltage suitable for powering the circuitry of a kit. All mains operated kits will include one. Connecting them is usually simple as the 'primary' (mains side) and the 'secondary' (low voltage side) are normally clearly marked. On transformers with 'flying lead' connections (wires coming directly out of the body), the red and black are normally the primary, and the two yellow and blue wires are the secondary. In this type the blue is a

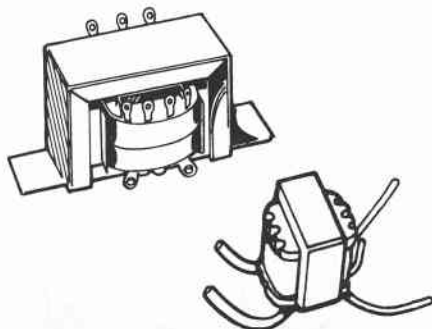

centre tap - a voltage halfway between the two yellow wires.

## CONNECTORS

All kits include connectors of various types - mains, battery, audio - the list of uses and types is enormous. When there is a standard connection configuration, it will be included in the instructions.

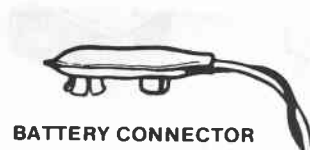

BATTERY CONNECTOR

## OTHER PARTS

All kits include a number of parts used for mounting, controlling and interconnecting. Here are the most common: **SOLDER LUGS** are used for connecting a wire to a bolt - for earth connections etc. **PBC PINS** are used for connecting wires to a printed circuit board. Handy, because they can be soldered to after the board is mounted. **TAGSTRIPS** are where a few components need to be mounted separately to the PCB. **MAINS TERMINAL BLOCKS** are the interconnection between the mains power cord and the circuitry of a kit. To use them, strip about 8mm from the wires, tin them, insert in the correct hole and tighten the screw - not too



PCB PIN

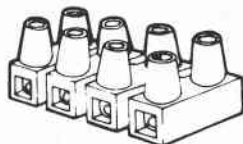

MAINS TERMINAL BLOCK

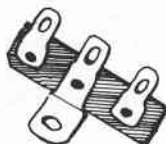

TAGSTRIP



SOLDER LUG

tightly or the wire could fracture. Make sure that no bare wire is outside the block.

## SWITCHES

Switches are used for controlling various functions in kits. They come in various types - toggle, rotary, paddle, micro, and are identified by the number of 'poles' and 'throws' or 'ways'. This is usually given as four letters or numbers. SPST stands for Single Pole Single Throw - one pole which is either off or on: DPDT stands for Double Pole Double Throw - two separate poles which have two 'on' positions. The drawing (right) will clarify these descriptions.

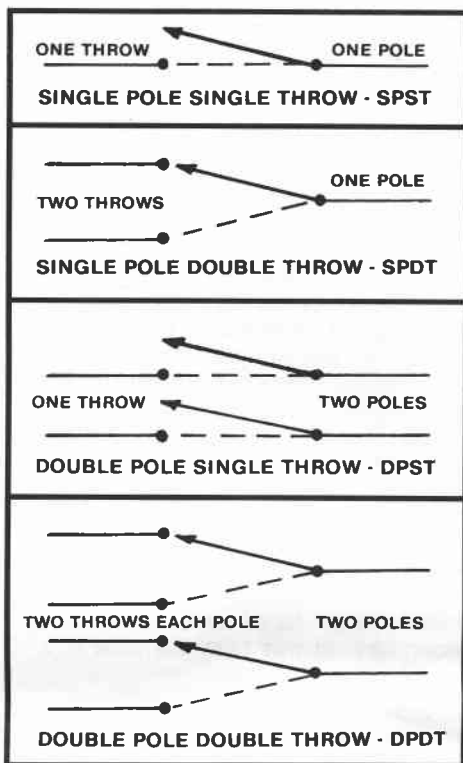
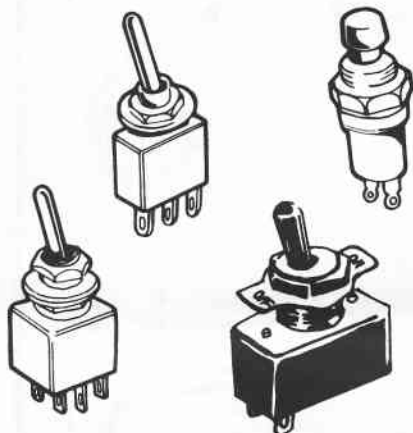

## WIRE AND CABLE

You will come across three main types of cable in our kits: **standard hookup wire** - light, flexible wire in a wide range of colours for low voltage connections. This may be in the form of a flat 'ribbon' of twelve separate conductors joined together for easier handling. **Mains hookup wire** - heavier stiffer wire in black, red and green used for wiring power switches, mains plugs etc. There are currently two standards for mains colour codes. The old system uses red, black and green for active, neutral and earth wires respectively. The new international standard is brown, blue and yellow/green striped. At the moment both are used about equally, with the new standard eventually being the only one. Remember the equivalents: red and

brown are for the active line, black and blue for the neutral and green and yellow/green are for the safety earth connection. Always make sure that any mains operated equipment, except double insulated equipment, is properly earthed. This protects you from dangerous shock situations.

The third type of wire you will come across is **shielded or coaxial cable**. This has one or more inner conductors surrounded by a twisted or braided shield.

In use the outer shield is normally earthed, while the inner conductor(s) carry the signal. The earthed shield protects the conductors from outside interference. This is why this cable is used for low level audio and radio signals.

Coaxial cables used for radio and TV have an impedance - measured in ohms. Always use coax of the specified

impedance; usually 75 ohms for TV and FM, and 50 ohm for CB and amateur radio use.

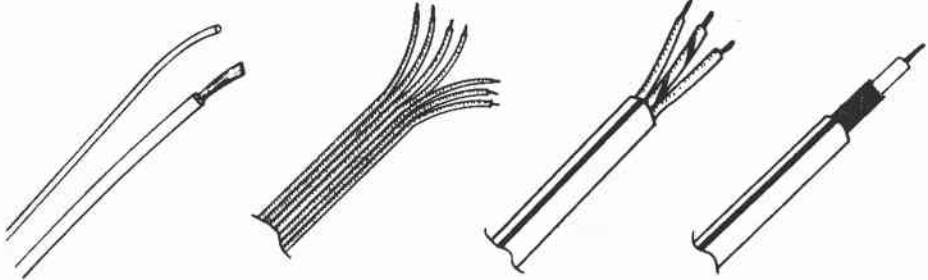

**HOOKUP WIRE    RIBBON CABLE    3-CORE MAINS CABLE    COAXIAL CABLE**

### SCHEMATIC DIAGRAMS

These are the commonly used symbols for components on schematic diagrams.

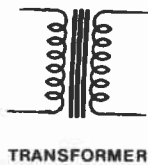
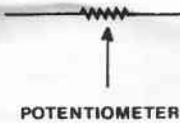
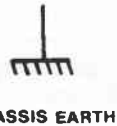
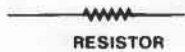

**CONDUCTORS NOT CONNECTED**

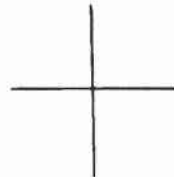

**TRANSISTOR**

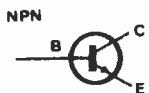

**CONNECTED**



## CONSTRUCTION TECHNIQUES

Most kits are assembled on a 'Printed Circuit Board' (PCB). This is a sheet of insulating material on which is etched the circuit layout in copper. Components are mounted on the non-copper side with their leads fed through the board and soldered to the copper tracks. When soldering, take care not to overheat as the tracks can lift off the board. Also avoid using too much solder, or you may 'bridge' across to another track causing a short circuit.

The drawings show how components are mounted on the PC board.

1. Bend components leads to fit the holes.
2. Insert leads in the correct holes and push down hard against the board. If the component is polarised, check that it is installed the right way round.
3. Turn the board over and bend the leads to 45 degrees.
4. Hold the bit of your soldering iron against the component lead and the copper.
5. After pre-heating for about one second apply the solder to the joint and the iron.
6. When the solder has flowed across the pad remove the iron and solder. (For more details, see the section on soldering on page 3.)
7. When cool cut the leads off flush with the solder.

The printed circuit boards are connected to the other components using hookup wire. Usually PC pins will be used to simplify connection. To connect to these first strip 5mm of insulation from the wire, tin the end (tinning is simply coating with solder) and the PC pin. Hold the wire against the pin and re-melt the solder. Hold still until the joint is solid.

When connecting wires to switches, potentiometers and terminals first strip and tin them as above; put a 90 degree bend in the stripped end and hook it through the terminal. Do not

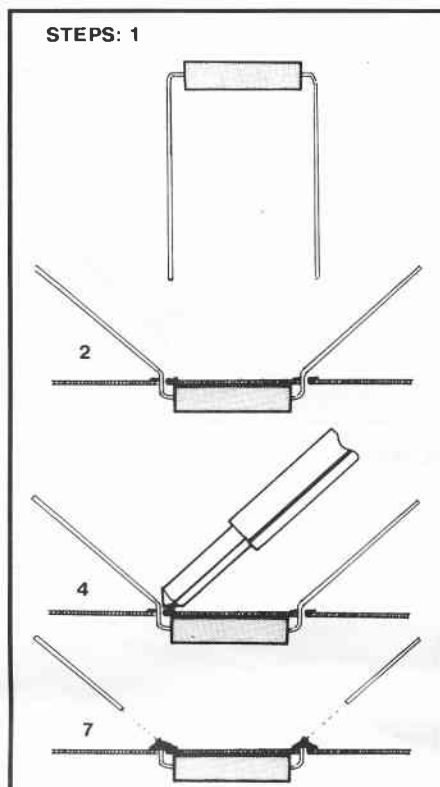

wrap it around the terminal or it will be difficult to remove if necessary.

## COMPONENT DRESS

Dress is the name given to the neat layout of parts. Whilst it is not essential, neat consistent layout and construction makes any fault-finding much simpler, as well as producing a more professional and reliable finished product.

Bend leads to fit their PCB holes accurately, using long-nose pliers. This means easier installation and less strain on the point where the lead enters the component. All components except transistors should sit right on the board. Line up all resistors so that their colour codes can be easily read. Position capacitors so that their values can be read (except polarised types, which must go in the direction indicated).

## USING A MULTIMETER

A multimeter is indispensable for testing and troubleshooting circuits. These notes will help you to use it effectively.

A typical multimeter measures volts (AC & DC), resistance and DC current.

To measure voltages, set the multimeters' range switch to the next voltage range higher than the voltage you want to measure. For example, to measure six volts, set the switch to ten volts. If you do not know what the voltage should be, set the switch to the highest voltage range (AC or DC) and measure the voltage. If it barely moves the needle, move the switch to the next range down. Do this until the needle falls around the middle of the scale.

Always make sure that you have set the meter to AC or DC as needed. Transformers and mains wiring are AC, transistor circuits are DC. When measuring DC, the red lead must be connected to the positive side, and the black to the negative. If the needle swings to the left, you have them the wrong way around.

## RESISTANCE MEASUREMENTS

When measuring resistance always make sure that no power is applied to the circuit or you will damage your meter or get a false reading.

The most important thing to remember when measuring resistance is to make sure the meter is properly 'zeroed'. To zero the meter, set it on the appropriate range ('ohms X1') and hold the two probe tips together. Now adjust the knob labelled 'ohms adjust' until the meter needle is sitting over the zero mark on the right hand side of the meter scale. Notice that the ohms scale reads from right to left.

## CURRENT MEASUREMENTS

To measure current, the point you wish to measure will have to be separated, as the meter will only measure current in series with the circuit. Adjust the range switch as for



A TYPICAL MULTIMETER

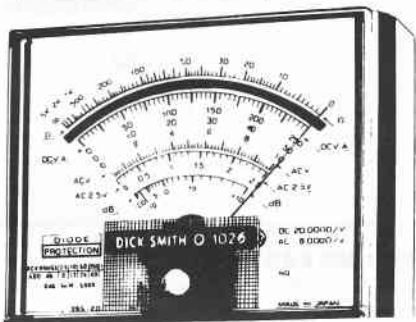

A MULTIMETER CORRECTLY ZEROED FOR MEASURING RESISTANCE

voltage measurements - start with the highest range and work down.

## GENERAL RULES

Check the position of the range switch before every measurement. Multimeters will not take much abuse (such as connecting to the mains on the ohms range!).

Make sure that you're reading the right scale of the meter. These will be identified similarly to the range switch.

Keep the meter flat when measuring, and read the scale from directly above - if your meter has a mirrored scale, line the needle up with its' reflection. This will minimise errors.

Re-zero the needle every time you measure resistance.

Switch the meter off, or to the highest current range when not in use.

Read your meters' instruction manual thoroughly.

## AUSTRALIA AND NZ ONLY MAINS VOLTAGES

Many of our kits are powered from 240V mains power. Mains voltages when not treated with respect can be fatal. **ALWAYS** insulate any mains switches, neons etc. with insulation tape or plastic sleeving. Even the most experienced constructor can accidentally brush a live wire -you might get away with it, but don't count on it. Follow mains wiring diagrams exactly - double checking everything. Always make sure that the green wire is securely connected to the metal case of any project.

When treated carefully, taking all these precautions, mains power is quite safe. If you are uncertain, get an experienced person to check your mains wiring before connecting the unit to power.

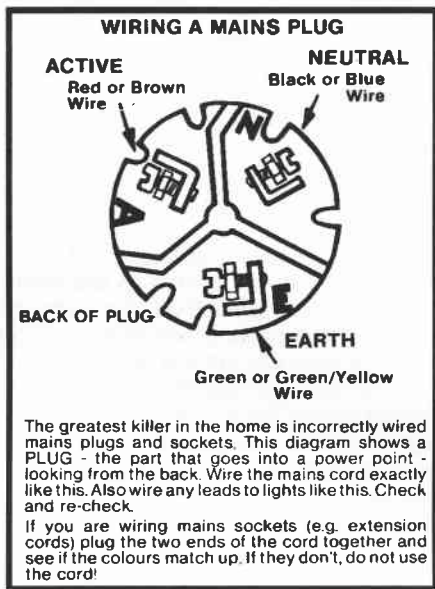

### MISSING PARTS

If you find any parts missing from your kit, fill in the card included with the kit and return it to the store you bought the kit from. Any missing parts will be supplied. This must be done within seven days of purchase.

### TROUBLESHOOTING

If a kit doesn't work when first switched on, switch it off immediately and disconnect the power.

Check the PC board for any solder bridges or dry joints. Re-solder any that look doubtful.

All components in the correct positions? Electrolytic capacitors, diodes, transistors and ICs the right way round?

Check all the wiring in this way. If no faults can be found after performing any tests described in the

kit manual, try getting the help of an experienced person - possibly a local 'ham' or technician.

One more note on troubleshooting: **DO NOT** attempt any fault-finding with mains operated equipment unless you are absolutely certain that you know what you're doing -**there is no room for mistakes with 240V wiring!**

From past experience we have found that, most faults in kits are due to poor soldering, or incorrect installed parts. Faulty parts are extremely rare, as all parts are top quality and factory fresh.



A.B.N. 34 000 908 716

P.O. Box 500 Regents Park DC, NSW 2143

WEBSITE: [www.dse.com.au](http://www.dse.com.au)

PH: (02) (Int 612) 9642 9100 Fax: (02) 9642 9111