

# EGV-40

## QRP transceiver for CW in kit form

*In memory of Miguel Montilla, EA3EGV (SK)*

## Assembly manual

Last update: Octubre 1st, 2013

[ea3gcy@gmail.com](mailto:ea3gcy@gmail.com)

For last minute updates and news, please got to: [www.qsl.net/ea3gcy](http://www.qsl.net/ea3gcy)

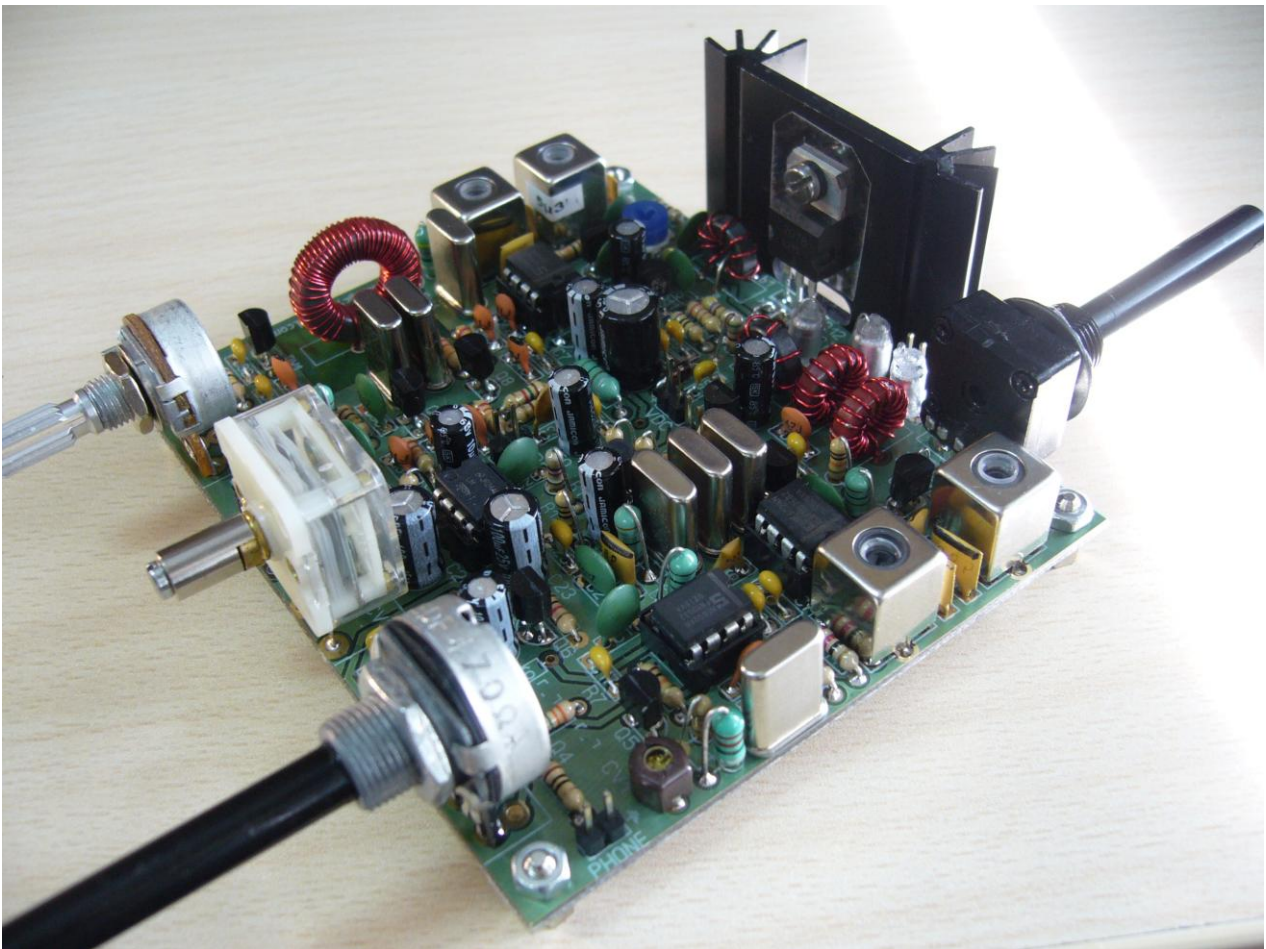

Thanks for buying and building the kit for the EGV-40 transceiver

Enjoy building and working QRP! 73, Javier Solans, ea3gcy

# INDEX

INDEX.....	2
INTRODUCTION.....	3
SPECIFICATIONS.....	4
TIPS FOR FIRST TIME BUILDERS.....	5
PARTS LIST SORTED BY VALUE/QUANTITY.....	7
INDIVIDUAL PARTS LIST.....	9
LOCATION MAP.....	13
ASSEMBLY.....	14
ADJUSTMENTS AND CHECKS.....	24
APPENDICES.....	28
IF YOUR KIT DOES NOT WORK AFTER ASSEMBLY.....	31
WARRANTY CLAUSES.....	33
SCHEMATICS.....	34
WIRING.....	35

# INTRODUCTION

*This EGV-40 transceiver is probably the kit that I have produced with more care and illusion in my life. It is a great honor to name this kit "EGV", the callsign suffix of the late Miguel Montilla, EA3EGV.*

*With no doubt, this is the kind of kit he liked most.*

*It was my privilege to establish and share with him the first years of the EA-QRP Club. He has always been a referent in my life; when I remember those wonderful years his humbleness, work capacity and generosity are the virtues which shine his image.*

*How lucky I was to be able to share the path with you, Miguel! Thanks!*

*Javier Solans, ea3gcy*

## **Miguel Montilla, EA3EGV**

Miguel got his A class callsign in 1983. He held previously the call EC3BAY. He was a good CW operator, highly respected among their peers. Holder of many awards and winner of several contests, Miguel enjoyed both the competition and sharing his time with a novel operator, patiently providing information to make a QSO.

He published articles on the journal from URE (Spanish Radio Amateur Union) Unión de Radioaficionados Españoles, on "CQ Radio Amateur" (Spanish edition) and on the G-QRP bulletins, etc. But, without doubt, what he liked most it was QRP kit building. He loved to build a kit over a weekend and enjoy some placid QSOs made with his new fresh transceiver. Of course, always with the minimum power required!

Miguel EA3EGV was the founder member #1 of the EA-QRP CLUB.

On September 1994 a group of four hams, Miguel Montilla EA3EGV, Miguel Molina EA3FHC, Vicenç Llarío EA3ADV and myself, Javier Solans EA3GCY, founded the EA-QRP.

Every April the club celebrates a CW contest: "EA-QRP-CW In memoriam EA3EGV".

## **EGV-40**

The EGV-40 is not a novel design.

The EGV-40 kit is a low power, CW transceiver designed to be simple and compact, using the legendary NE/SA602 mixer chips. The circuit is a "tutti frutti" mix of several well known designs from the last 20-25 years, very similar among them. In the EGV-40 I have tried to gather the best ideas of all these little jewels but keeping in mind the philosophy of making an easy to build, compact, reasonably cheap circuit with good characteristics.

The EGV is not a technical marvel but... will something so simple work well?

Build it, and you will be able to answer this question.

A high stability VXO covers around 40 kHz in the lower part of the band with very low drift: less than 200 Hz in the first 5 minutes of the start-up. A "fine" tuning has been added, so no mechanical or electrical band-spread of the main tuning is required.

Also, a variable attenuator has been included in the RX path to avoid the overload with the typical strong signals in the band.

## Acknowledgments

I want to thank Viçens EA3ADV, Lluís EA3WX and Alfons EA3BFL for their support and help to make this kit happen. To Dave K1SWL (smallwonderlabs.com) for granting me permission to use on the EGV-40 some details of the transmitter circuit of his legendary SW-40.

To Jon EA2SN for translating this manual into English, and to the "EA-QRP-CLUB" for keeping alive the homebrewing, even on difficult times.

And, in special, to Montse, Miguel's widow, for allowing me to link this EGV-40 kit with the memory of his late husband, and for generously providing me with information and support.

## SPECIFICATIONS

### GENERAL:

Frequency coverage: By means of a Variable Crystal Oscillator (VXO), tuning the CW segment of the 40 meter band (40 kHz).

Frequency control: High stability VXO, with a couple of crystals on 11.981 MHz.

Antenna impedance: 50 ohm.

Power requirements: 12-14 V DC, about 25 mA in reception (without signal), 380 mA (2.5 W) on transmission.

Part count: 36 resistors, 65 capacitors, 1 trimmer resistor, 2 trimmer capacitors, 3 potentiometers (volume, fine tune and attenuator), 7 IC's, 12 transistors, 6 diodes, 11 inductors, 5 IF transformers, 1 variable capacitor (tuning), and 5 crystals.

Front panel controls: Main tuning, fine tuning, volume.

Back panel controls: RX attenuator.

External connections: Headphones, key, antenna, DC connector.

Board dimensions: 100x85 mm (around 4 x 3 1/2 in).

### TRANSMITTER:

RF output: from 0 to 3.5 W (at 13.8 V) internally adjustable (2.5 W recommended).

2nd. harmonic output: -40dBc below the fundamental (at 2.5 W).

Other spurs: all other spurs are -50dBc or lower with respect to the fundamental.

T/R switching: Semi or full break-in (internally defined by changing a capacitor).

Adjustable RX/TX shift.

Sidetone monitor: through the receiver, picking an attenuated signal of the transmitter.

Sidetone level: internally defined by changing a resistor.

### RECEIVER:

Type: Superheterodyne, one conversion Balanced mixer.

Coverage: 7.0 to 7.04 MHz approx. (CW segment)

Sensitivity: 0.25  $\mu$ V MDS (minimum discernible signal).

Selectivity: ladder filter with 3 crystals. Bandpass: 800 Hz nominal (at -6 dB)

IF frequency: 4.915 MHz.

Dual AGC system, controlling both the RX mixer and the product detector.

Audio output: on headphones 150 mW (on 30-100 ohm loads).

# PLEASE, READ AT LEAST ONCE AND THOROUGHLY ALL THE ASSEMBLY INSTRUCTIONS PRIOR TO BUILDING SESSIONS.

## TIPS FOR FIRST TIME BUILDERS

### Tools Required:

- Small tipped soldering of about 25-30 W rating, good quality soldering tin for electronic work, small side cutters, wire strippers, long strippers, long nosed pliers, a sharp knife hobby "cutter", a screw driver for the M3 bolt, trimming tool for the IF cans.

- You need a good light and a magnifying glass to see fine print on the parts and other building details.

### Instruments required:

- Multimeter, Oscilloscope (desirable but not essential). Frequency counter or HF receiver. RF power meter. 50 ohm, 5W load. RF Generator (desirable not essential).

### Soldering:

There are two important things which need to be done to ensure the successful operation of a kit. One is getting the right part into the proper place on the board, the second is good soldering.

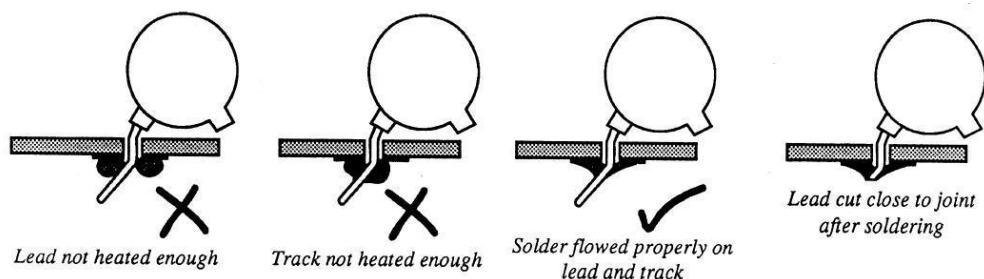

To solder properly, you must use the correct type of iron and the right quality of solder. Use a small tipped soldering iron which has a bit that is short and almost pointed at end. The iron should be about 25-30 Watts (if it is not thermostatically controlled). Use only electronic type multicore solder. NEVER use any extra flux. You should hold the hot iron in contact with both the board and component lead for about two seconds to heat them up. Then, keeping the iron in place, touch the solder onto the junction of lead and track and wait about two second or so until the solder to flow along the lead and track to form a good joint. Now remove the iron. The iron should have been in contact with the work piece for a total time of about 4 seconds in all. When soldering leads going to the ground plane of the board, you will need to preheat the union longer to get a good flow of the molten tin.

It is highly recommended to clean and remove the remaining tin from the iron tip after each soldering (most of the holders have a sponge for this); this helps to avoid old tin on the tip and residues from previous operations.

## **Finding the right part:**

### **IC's**

The outline on the board for the IC's has a "U" notch on one end, indicating pin 1 end of the IC. There is also a notch on one end of the sockets. This end goes over the "U" notch outline on the board. Finally, pin 1 of the IC is marked with a round dimple or dot; this end of IC will go towards the notch on the socket or "U" on the outline.

### **Diodes**

Be sure to observe proper polarity of diodes. There is a black band towards one end of the diode. This band should face the line shown on the diode outline of the board.

### **Electrolytic capacitors:**

These must be installed with the correct polarity. The positive (+) lead is always the long lead. The negative (-) lead is marked by a stripe on the body of the capacitor can. Make sure the plus end of the cap goes toward the hole labeled with the (+).

### **Coils and Transformers:**

You can find it convenient to wind and prepare all the coils and transformers before you start inserting parts. That way you don't need to stop and possibly lose concentration to wind them.

Is the part of the build considered by some to be the most difficult. I find it one of the easiest stages, personally, and almost relaxing. Just take your time. The assembly instructions and pictures illustrate the process.

# PARTS LIST SORTED BY VALUE/QUANTITY

Resistor list				
Qty	Value	Checked	Ref.	Identified
2	1 Ω		R10, R18	brown-black-gold
3	10 Ω		R12, R16, R34	brown-black-black
4	22 Ω		R4, R5, R17, R27	red-red-black
2	56 Ω		R35, R36	green-blue-black
1	270 Ω		R26	red-violet-brown
1	470 Ω		R33	yellow-violet-brown
2	1K		R13, R22	brown-black-red
1	1K5		R25	brown-green-red
1	1K8		R3	brown-grey-red
--	2K2/2K4	X	R2 SMD resistor. <b>Factory soldered.</b>	--
1	2K2		R32	red-red-red
2	4K7		R11, R15	yellow-violet-red
5	10K		R1, R8, R9, R29, R30	brown-black-orange
6	22K		R20, R21, R23, R24, R28, R31	red-red-orange
2	100K		R14, R19	brown-black-yellow
1	3M3		R7	orange-orange-green
1	4M7		R6 (sidetone level, see Annex)	yellow-violet-green
1	1K		P1 1K shaft potentiometer (linear)	1K LIN or B1K
1	500 Ω		P2 500 or 470 shaft potentiometer (log)	450 A or 470 A (Log)
1	10K		P3 10K shaft potentiometer (linear)	B 10K LIN
1	500		P4 500 adjustable resistor (TX power output adjust)	501 or 52Y

Capacitor list				
Qty	Value	Checked	Ref.	Identified
17	100n		C7, C14, C16, C17, C18, C19, C25, C28, C29, C32, C33, C45, C51, C55, C57, C60, C61	104 or 0.1
1	33n		C20	333 or 0.033
11	10n		C5, C11, C21, C26, C30, C37, C41, C49, C54, C56, C58	103 or 0.01
1	1n		C39	102 or 0.001
1	1n		C63 <b>Styroflex</b>	1000
2	470p		C62, C64 <b>Styroflex</b>	470
2	470p		C8, C9 ( <b>no styroflex</b> )	n47 or 471J
2	220p		C6, C47,	n22 or 221
6	100p		C12, C13, C34, C35, C42, C43	n10 or 101
4	82p		C1, C3, C46, C48	82P or 82J
1	68p		C10	68P or 68J
2	47p		C36, C65	47P or 47J
1	27p		C4	27P or 27J
1	22p		C31	22P or 22J
1	15p		C40	15P or 15J
1	8p2		C2	8P2
1	220uf		C59 (electrolytic)	220uf 25v or 35V
2	100uf		C23, C24 (electrolytic)	100uf 25V or 35V
8	10uf		C15, C22, C27, C38, C44, C50, C52, C53 (electrolytic)	10uf 25V or 35V
2	60p		CV1, CV4 Murata trimer	Brown
1	160+70p		CV2+CV3 Polyvaricon dual gang. Tuning. 160p + 70p	Polyvaricon



Semiconductors list				
Qty	Type	Checked	Ref.	Identified
Transistors				
8	BC547		Q1, Q2, Q5, Q6, Q7, Q8, Q10, Q11	BC547
1	BC557 or BC558		Q9	BC557 or BC558
2	J310 SMD	X	Q3, Q4 SMD <b>Factory soldered</b>	--
1	2SC2078/1969		Q12, washer and mica spacer	C2078 or C1969
Integrated circuits				
3	SA/NE602		IC1, IC2, IC6	SA602AN or NE602AN
1	LM386		IC3	LM386N-1
2	78L06		IC4, IC7	78L05
1	78L08		IC5	78L08
Diodes				
4	1N4148		D1, D2, D4, D5	4148
1	47V Zener		D3 Zener 47V 1W	BZX85C47
1	BB112		DV1 Varicap diode	BB112

Inductors/RF Transformers/Crystals				
Qty	Value	Checked	Ref.	Identified
4	100uH		L1, L3, L6, L8, Axial inductor	brown, black, brown
1	18uH		L2 Axial inductor	brown-grey-black
1	22uH		L4 Axial inductor	red-red-black
1	47uH		L7 Axial inductor	yellow-violet-black
2	T37-2		L10, L11 LPF toroids 16t.	9,5 mm diam. red
1	T68-2		L5 Toroid. Tuning inductor (47) 48t.	17,5 mm diam. red
2	FT37-43		T5 toroid = 8 + 1 turns ; L9 toroid = 6turns	9,5 mm diam. black
4	3334 (5u3H)		T1, T2, T3, T4 5u3H Shielded coils	K3334 or "5u3H"
5	4.915		X1, X2, X3, X4, X7 Crystals 4.915MHz.	4.915
2	11.981		X5, X6, 11.981MHz crystals	11.98

Hardware				
Qty	Value	Checked	Ref.	Identified
5	nuts		hex nuts M3	-
4	spacers		5mm spacer for M3 screw	-
4	screw		5mm M3 screw	-
1	screw		10mm M3 screw	-
1	washer		M3 lock washer	-
13	pins		Phone(2), KEY(2), VDC(2), ANT(2), VXO(2), J1A/B(3)	-
1	jumper		jumper for J1	-
4	IC socket		IC's socket 8 pin	-
1	Shaft Poly.		6mm Shaft Polyvaricon Hardware	-
1	Heatsink		Q7 (Output Amp) Heatsink	-
70cm	wire		70cm enameled copper wire 0,5mm	-
110cm	wire		110cm enameled copper wire 0,3mm	-
1	EGV PCB		100mm x 85mm ILER V2 PCB	-



# INDIVIDUAL PARTS LIST

Resistors						
Checked		Ref.	Value	Ident./Comment	Circuit section	Located
		R1	10K	brown-black-orange	Rx mute	C-8
X	X	R2	2K2/2K4	SMD factory soldered	AGC	F-9
		R3	1K8	brown-grey-red	Q2	C-7
		R4	22 Ω	red-red-black	IC1	E-10
		R5	22 Ω	red-red-black	IC2	E-10
		R6	4M7	yellow-violet-green	Q3 Mute (see text)	H-8
		R7	3M3	orange-orange-green	Q4 Mute	H-9
		R8	10K	brown-black-orange	Q5 Mute	G-9
		R9	10K	brown-black-orange	Q5 Mute	G-10
		R10	1 Ω	brown-black-gold	IC3 Audio out	G-5
		R11	4K7	yellow-violet-red	IC3 Audio out	F-6
		R12	10 Ω	brown-black-black	IC3 Audio out	F-6/7
		R13	1K	brown-black-red	Q6 AGC	G-7/8
		R14	100K	brown-black-yellow	Q6 AGC	H-7
		R15	4K7	yellow-violet-red	Q6 AGC	H-7
		R16	10 Ω	brown-black-black	earphones out	H-9/10
		R17	22 Ω	red-red-black	IC3 Audio out	H-5
		R18	1 Ω	brown-black-gold	Fine	G-3
		R19	100K	brown-black-yellow	Fine	H-1/2
		R20	22K	red-red-orange	VXO Q7	E-3
		R21	22K	red-red-orange	VXO Q7	G-4
		R22	1K	brown-black-red	VXO Q7	F-4
		R23	22K	red-red-orange	VXO Q8	E-3
		R24	22K	red-red-orange	VXO Q8	F-4
		R25	1K5	brown-green-red	VXO out	E-4
		R26	270 Ω	red-violet-brown	VXO out	E-4/5
		R27	22 Ω	red-red-black	Q10	C-4
		R28	22K	red-red-orange	Q10	C-3
		R29	10K	brown-black-orange	Q10	C-2
		R30	10K	brown-black-orange	Key in Q9	E-6
		R31	22K	red-red-orange	Key in Q9	E-6
		R32	2K2	red-red-red	Q11	B-4/5
		R33	470 Ω	yellow-violet-brown	Q11	B-4/5
		R34	10 Ω	brown-black-black	Q11	B/C-4/5
		R35	56 Ω	green-blue-black	Q11	B-5
		R36	56 Ω	green-blue-black	Q12	A-2

Potentiometers						
Checked		Ref.	Value	Ident./Comment	Circuit section	Located
		P1	1K shfat potentiometer	1K (B Lin)	RX atten.	A-9
		P2	500 Ω shaft potentiometer	500 or 470 (A Log)	Audio volume	I-9
		P3	10K shaft potentiometer	10K (B Lin)	Fine Tune	I-2
		P4	500 Ω adjustable resistor	501	Power level	B-3

Capacitors						
Checked	Ref.	Value	Ident./Comment	Circuit section	Located	
	C1	82p	82, 82p or 82J	RX BPF	C-10	
	C2	8p2	8p2 or 8.2	RX BPF	C-9	
	C3	82p	82, 82p or 82J	RXBPF	C-10	
	C4	27p	27, 27p or 27J	RX BPF	C-9	
	C5	10n	103 or 0.01	RX MIX	C-8	
	C6	220p	220p, 220 or n22	RX MIX	E-8	
	C7	100n	104 or 0.1	RX MIX	E-9	
	C8	470p	471 or n47	IF Filter	D-7	
	C9	470p	471 or n47	IF Filter	E-7	
	C10	68p	68, 68p or 68J	CW DETEC.	F-7/8	
	C11	10n	103 or 0.01	CW DETEC.	F-8	
	C12	100p	100, 100p or n10	CW DETEC.	F-10	
	C13	100p	100, 100p or n10	CW DETEC.	F-9/10	
	C14	100n	104 or 0.1	IC4	C-7	
	C15	10uF	10uF	IC4	C-6	
	C16	100n	104 or 0.1	CW DETEC.	E-9	
	C17	100n	104 or 0.1	MUTE	G-8/9	
	C18	100n	104 or 0.1	MUTE	I-7/8	
	C19	100n	104 or 0.1	MUTE	I-7/8	
	C20	33n	333 or 0.033	MUTE	I-7	
	C21	10n	103 or 0.01	AGC	F-7/8	
	C22	10uF	10uF	AGC	H-7/8	
	C23	100uF	100uF	Audio AMP	G-7	
	C24	100uF	100uF	Audio AMP	H-6	
	C25	100n	104 or 0.1	Audio AMP	F-7	
	C26	10n	103 or 0.01	Audio AMP	F-5/6	
	C27	10uF	10uF	Audio AMP	G-5	
	C28	100n	104 or 0.1	Audio AMP	H-5	
	C29	100n	104 or 0.1	Audio AMP	H-4/5	
	C30	10n	103, 0.01	VXO	G-3	
	C31	22p	22, 22p or 22J	VXO	G-2	
	C32	100n	104 or 0.1	VXO	H-1	
	C33	100n	104 or 0.1	VXO	H-2	
	C34	100p	100p, 100 or n10	VXO	G-4	
	C35	100p	100p, 100 or n10	VXO	F/G-4	
	C36	47p	47, 47p or 47J	VXO	F-4	
	C37	10n	103 or 0.01	IC5	G-4	
	C38	10uF	10uF	IC5	H-4	
	C39	1n	102 or 0.001	TX MIX	E-5	
	C40	15p	15, 15p or 15J	TX MIX	E-4	
	C41	10n	103 or 0.01	TX MIX	C-4	
	C42	100p	100, 100p or n10	TX MIX	D-3	
	C43	100p	100, 100p or n10	TX MIX	E-3	
	C44	10uF	10uF	IC7	D-4	
	C45	100n	104 or 0.1	IC7	D-3/4	
	C46	82p	82, 82p or 82J	TX MIX	D-2	
	C47	220p	220, 220p or n22	TX MIX	C-1	
	C48	82p	82, 82p or 82J	TX MIX	B-1	
	C49	10n	103 or 0.01	DRIVER	B-2	
	C50	10uF	10uF	DRIVER	E-5	
	C51	100n	104 or 0.1	DRIVER	E-5	
	C52	10uF	10uF	Q9 Key in	F-7	
	C53	10uF	10uF	DRIVER	C-3	
	C54	10n	103 or 0.01	DRIVER	C-3	
	C55	100n	104 or 0.1	DRIVER	C-5	
	C56	10n	103 or 0.01	DRIVER	B-4	
	C57	100n	104 or 0.1	DRIVER	C-5	
	C58	10n	103 or 0.01	Output AMP	A-3	
	C59	220uF	220uF	Supply	D-5	

Capacitors (continued)						
		C60	100n	104 or 0.1	Output Amp	C-5/6
		C61	100n	104 or 0.1	Output Amp	A/B-6
		C62	470p	470 (Styroflex)	LPF	A/B-6
		C63	1000p (1n)	1000 (Styroflex)	LPF	A-6/7
		C64	470p	470 (Styroflex)	LPF	A-7/8
		C65	47p	47, 47p or 47J	RX switch	C-7
		CV1	60p	Trimmer (brown)	CW Detector	G-10
		CV2+CV3	160+70p Var	Tuning Polyvaricon	VXO	I-5/6
		CV4	60p	Trimmer (brown)	TX Mix	E-1

Crystals						
Checked	Ref.	Frequency	Ident./Comment	Circuit section	Located	
	X1	4.915Mhz	4.915	IF	D-7/8	
	X2	4.915Mhz	4.915	IF	E-7/8	
	X3	4.915Mhz	4.915	IF	E-7/8	
	X4	4.915Mhz	4.915	RX DETEC.	F-10	
	X5	11.981Mhz	11.98	VXO	F-3	
	X6	11.981Mhz	11.98	VXO	F-3	
	X7	4.915Mhz	4.915	TX MIX	E-2	

Semiconductors						
Checked	Ref.	Type	Ident./Comment	Circuit section	Located	
<b>Transistors</b>						
	Q1	BC547	BC547	MUTE	B/C-9	
	Q2	BC547	BC547	IF	D-8	
X	X	Q3	J310	SMD factory soldered	MUTE	H-8
X	X	Q4	J310	SMD factory soldered	MUTE	H-9
	Q5	BC547	BC547	MUTE	G-9	
	Q6	BC547	BC547	AGC	G-7/8	
	Q7	BC547	BC547	VXO	F/G-4	
	Q8	BC547	BC547	VXO	E-4	
	Q9	BC557 or BC558	BC557 or BC558	KEY switch	E-6	
	Q10	BC547	BC547	DRIVER	C-2/3	
	Q11	BC547	BC547	DRIVER	C-4	
	Q12	2SC2078 or 1969	C20178 or C1969	Output Amp	A-5	
<b>IC's</b>						
	IC1	NE602/SA602	NE602/SA602	RX MIX	D-8/9	
	IC2	NE602/SA602	NE602/SA602	CW DETEC	F-9	
	IC3	LM386N	LM386N	Audio AMP	G-6	
	IC4	78L06	78L06	RX	C/D-6	
	IC5	78L08	78L08	VXO	H-3	
	IC6	NE602/SA602	NE602/SA602	TX MIX	D-3	
	IC7	78L06	78L06	TX MIX	D-4	

Diodes						
	D1	1N4148	1N4148	AGC	H-7	
	D2	1N4148	1N4148	Output AMP	A-2	
	D3	Zener 47V 1W	BZX85C47	Output AMP	C-5	
	D4	1N4148	1N4148	RX limiter	B-8	
	D5	1N4148	1N4148	RX limiter	B-9	
	DV1	BB112	Varicap diode BB112	VXO (Fine)	G/H-1	

<b>Inductors/RF Transformers</b>					
<b>Checked</b>	<b>Ref.</b>	<b>Value/Type</b>	<b>Ident./Comment</b>	<b>Circuit section</b>	<b>Located</b>
	L1	100uH Axial inductor	brown-black-brown	CW DETEC	C-8/9
	L2	18uH Axial inductor	brown-grey-black	IF	F-7
	L3	100uH Axial inductor	brown-black-brown	CW DETEC	F-8
	L4	22H Axial inductor	red-red-black	CW DETEC	G-10
	L5	T68-2 red toroid	48 turns (see text)	VXO	F-1/2
	L6	100uH Axial inductor	brown-black-brown	VXO	G/H-3
	L7	47uH Axial inductor	yellow-violet-black	TX MIX	E-1
	L8	100uH Axial inductor	brown-black-brown	DRIVER	D-5
	L9	FT37-43 black toroid	6 turns (see text)	Output AMP	B-6
	L10	T37-2 red toroid	16 turns (see text)	LPF	B-7
	L11	T37-2 red toroid	16 turns (see text)	LPF	B-8
	T1	5u3H (shielded)	RF transf. 5u3H	RX BPF	B-10
	T2	5u3H (shielded)	RF transf. 5u3H	RX BPF	D-10
	T3	5u3H (shielded)	RF transf. 5u3H	TX MIX	D-1
	T4	5u3H (shielded)	RF transf. 5u3H	TX MIX	B-1
	T5	FT37-43 black toroid	8 + 1 turns (see text)	Output AMP	A-4

# LOCATION MAP

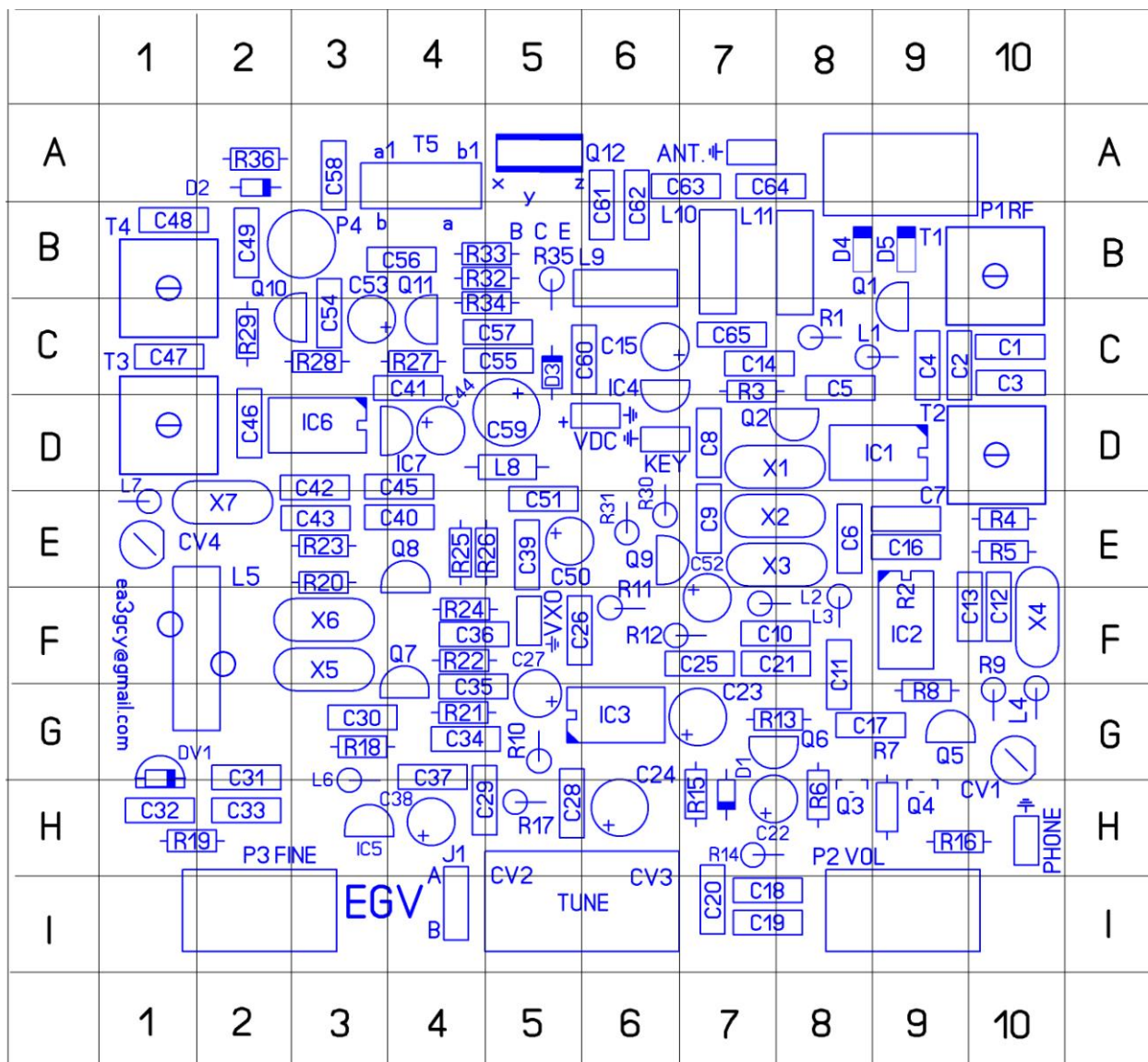

# ASSEMBLY

You may use “individual parts list” or the “value/quantity parts list”. The “value/quantity parts list” is the quickest way to place components because all parts of the same value or type can be placed one after each other. You will need, however, the “individual parts list” to know how each part is identified and its location on the board. According to your personal experience you may prefer to use the individual list, to play on the safe side. The location of all parts is very easy when using the 90 quadrants map. After placing each component, you can mark it in the “checked column list”.

It is highly recommended to inventory all parts to make sure everything is available and ready for assembly. Each builder may have his/her own way of organizing parts, but if you do not, you might try using a block of Styrofoam packing material and poke the parts on it. Parts may be sorted by type, value, and size (ohms, micro-farads etc).

## RECOMENDED ASSEMBLY SEQUENCE

### ☐ Resistors

The resistors are installed first. Place all resistors from R1 to R36 and the P4 trimmer (transmitter output power adjustment).

DO NOT install now the potentiometers P1 (RF attenuator), P2 (volume) and P3 (fine tuning).

Refer to the parts list, select the first resistor, R1 and locate its place on the board. This resistor is placed vertically; you need to bend only one leg. Most of the resistors are placed horizontally; bend their leads as close to the ends as possible, and fit them into the holes marked on the silkscreen of the PCB. Take care and avoid mixing resistors and axial inductors, which are a bit thicker. All resistors have a light yellow body color with a gold band at one end. The resistor's leads once inserted, push the body down to lay flat on the PCB, and on the other side bend slightly out the legs to hold the resistor in place. Then turn the PCB over and solder the leads to the PCB pads. Make sure the resistor body lays flat over the board to keep its legs as short as possible.

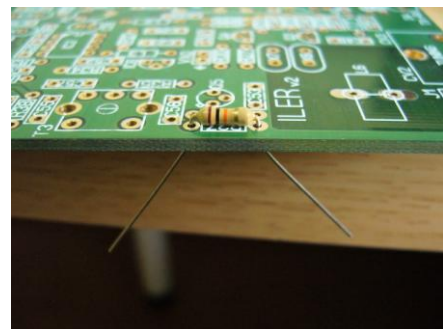
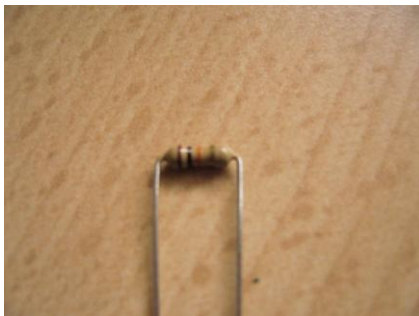



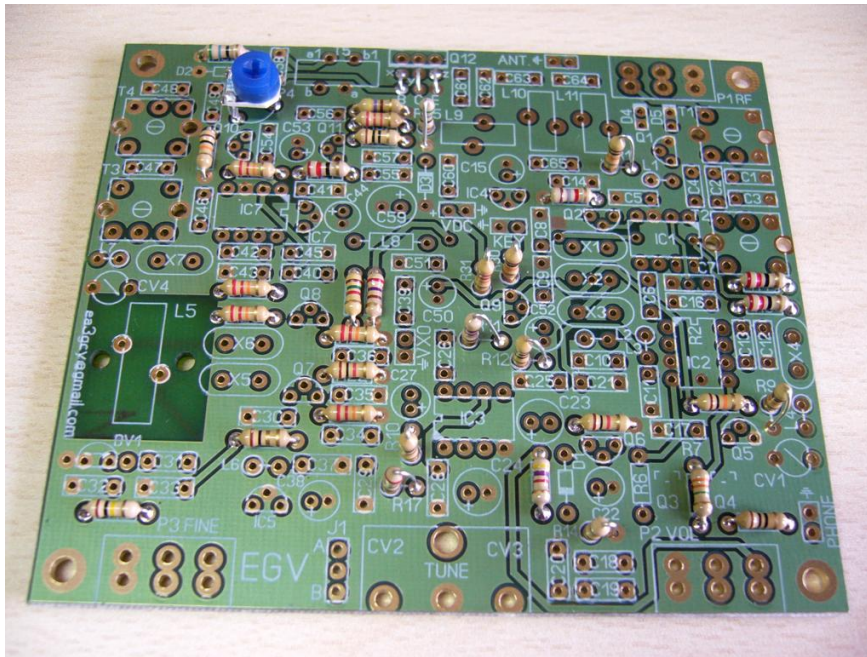
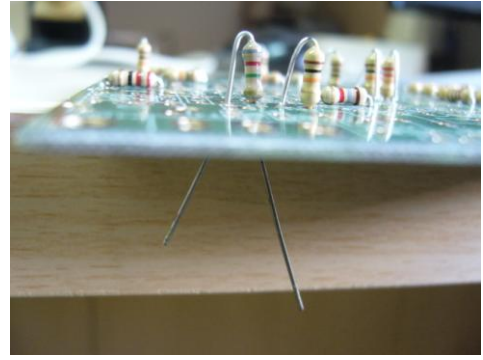

Please read the notes on soldering Poor soldering is the most common cause of a kit failing to work first time, so please take the soldering advice at heart! Once soldered cut off the excess length of the part lead as close to the joint as possible. Install all resistors from the parts list and carry on until all resistors are soldered in place.

Values which are in decade increments may be easily confused, such as 470, 4K7 and 47K. So, take a good look at the colors before you solder the part in place! In case of doubt, use a multimeter to check the resistor value.

R2 is an SMD resistor, factory installed.

#### ❑ Axial inductors

L1, L2, L3, L4, L6, L7, L8.

These components look just like fat resistors, but they have a blue or green colored bodies. Inside the device is a small coil wound on ferrite material. As before, refer to the parts list to select the correct one for each position. L1, L2, L3, L4, L6 and L7 are mounted vertically. L8 is the only inductor horizontally placed, and we recommend to separate it from the board approximately 1-1.5 mm (1/16 in).

Fit them on their designated places as with resistors.

Note: L5 is the VXO toroidal coil, which will be wound and placed later.



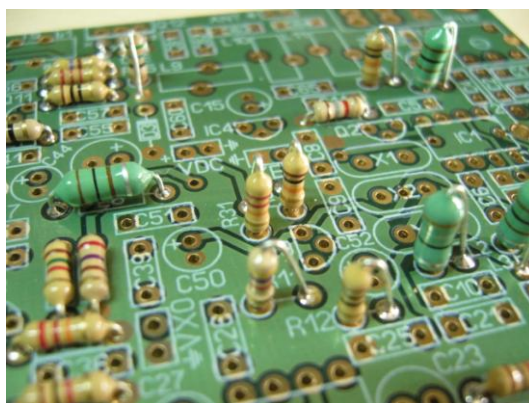

## □ Diodes

Now install the diodes, taking care to place them with the right orientation. There is one band at one end of each diode's body which has to match the silkscreen of the PCB.

D1, D2, D4 and D5 are 1N4148 types, these are usually orange with a black band, marked with "4148" on their body. D4 and D5 are placed vertically, all others are placed horizontally.

D3 is similar to the 1N4148 ones but thicker, and it is marked as BZX85C47.

DV1 is a BB112 varicap diode and is similar to a transistor with only two legs; its outline should fit the silkscreen of the PCB.

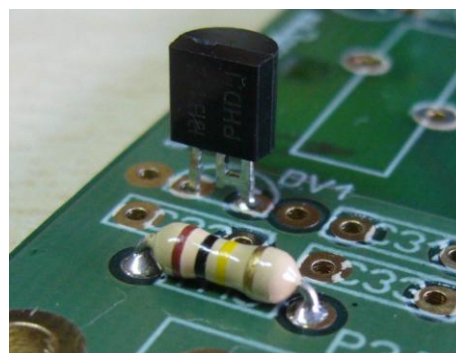
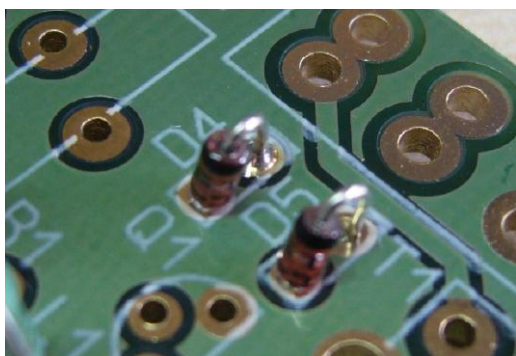

## □ Capacitors

There are Ceramic, Polyester, Styroflex and Electrolytic type capacitors. All these have their value printed on the body. Go to the parts list' "identified" column.

When fitting them, keep their leads as short as possible.

**C62, C63 y C64** are **Styroflex** capacitors, they are axial and must be placed vertically.

Values which are in decade increments may be easily confused, such as 8p2, 82p and 820 p. So, take a good look at the printed numbers before you solder the part in place!

Electrolytic capacitors must be fitted the right way around: the LONGER LEAD goes to the hole marked "+", the shorter lead is "-" and it is indicated by a band along the body of the capacitor with "-".

CV1 and CV4 are capacitor trimmers brown in color. They have no printed marks. Place them following the outline on the silkscreen of the PCB.

CV2 + CV3 are part of the two-section tuning "Polyvaricon" variable capacitor. DO NOT INSTALL it now.

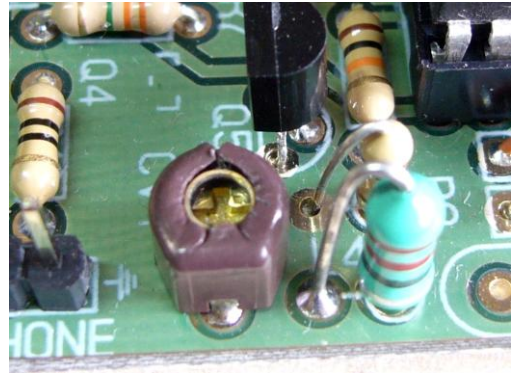

### □ Pin “headers”

Place and solder pins for “Phone”(2)(H-10), “KEY”(2)(D-6), “VDC”(2)(D-6), “ANT”(2)(A-7), “VXO”(2)(F-5), and J1 A/B(3)(I-4).

Turn the board over and hold the headers in place with the help of a female jumper while you solder them avoiding burning your fingers. Use the other hand for the soldering iron and move the board towards the tin to solder the headers in place. If you have someone to help out, much better!

### □ Transistors

All of them have their type numbers marked on their body. Place and solder Q1, Q2, Q5, Q6, Q7, Q8, Q9, Q10 and Q11 following the outline on the silkscreen.

Q3 and Q4 are SMD J310 transistors, and they are factory soldered on the tracks side of the PCB.

DO NOT INSTALL Q12 now (TX power amplifier).

### □ Integrated Circuits

The outline on the board for the ICs has a “U” notch on one end, indicating the pin 1 end of the IC. There is also a notch on one end of the sockets. This end goes over the “U” notch outline on the board. Finally, pin 1 of the IC is marked with a round dimple or dot; this end of IC will go towards the notch on the socket or “U” on the outline.

Install sockets for IC1, IC2, IC3, and IC6 on their PCB locations. Make sure that all sockets lie flat against the board. Next, insert IC1, IC2, IC3, and IC6 on their sockets.

**IMPORTANT:** Make sure that all IC’s are fully inserted on their sockets, push them if need be. It is a good idea to clean or scratch the legs of the chips prior to their insertion on their sockets. If contact fails in the sockets it may cause a malfunction of the rig.

Now, place the voltage regulators IC4, IC5, and IC7, following the outline of the silkscreen.



### ❑ Crystals

Install X1 to X7.

X1, X2, and X3 are part of the CW filter, X4 is the RX BFO crystal, and X7 is the oscillator for the TX mixer. These crystals have been hand picked (have handwritten numbers on their body) to have the same resonating frequency, in order to obtain the best filter quality. The X5 and X6 pair are the VXO crystals.

The crystal housing should not touch the board, place them slightly separated from the board. 0,5-1 mm (less than 1/16 in) may be sufficient.

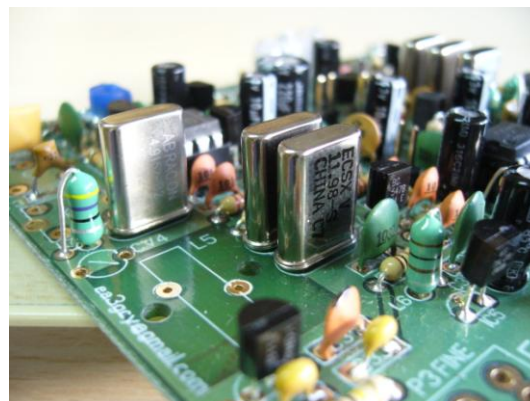
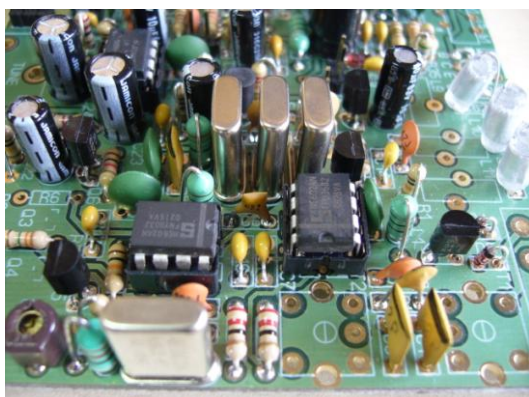

### ❑ Toko shielded coils (cans)

T1, T2, T3 y T4 are Toko “5u3” cans (Toko KANK3334). RF transformers for the bandpass filters Make sure their body lay flat against the PCB.

You may need extra heat to solder the shield tabs.

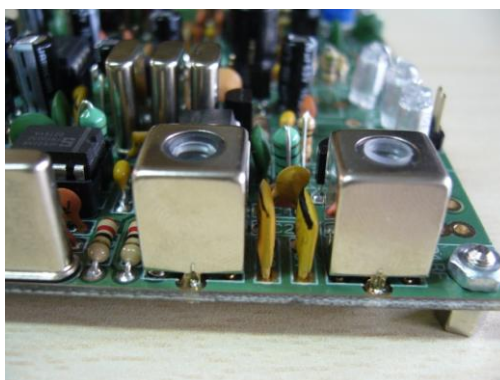



When you turn the board over the cans may fall. Fit the can in place, hold it with one hand, and turn the board over. Use the other hand for the soldering iron, and move the board towards the tin to solder the can in place. If you have someone to help out, much better!

#### □ Toroids L10 y L11 for the LPF

L10 and L11 are identical. T37-2 cores (red toroids with OD 9.5 mm / 0,375 in) are used.

Cut 25 cm (10") of 0.5 mm enameled wire and wind 16 turns on the red toroidal T37-2 core. Wind the wire tightly on the core, avoiding loose turns, and spread the turns evenly around the core. They should be uniformly spread around the circumference of the toroid. Leave pigtails of about 10 mm (0.4"). Remove the enamel with a cutter to solder the toroids on the board.

The nominal value for L10 and L11 is 1.02  $\mu$ H.

Counting turns: every time the wire passes through the toroid center hole counts as one turn.

Important: Wind the toroid exactly as shown in the pictures.

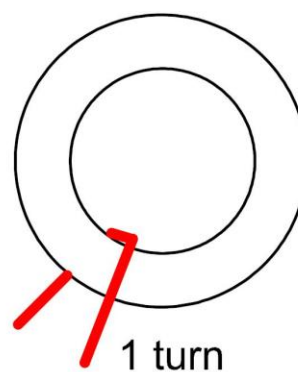
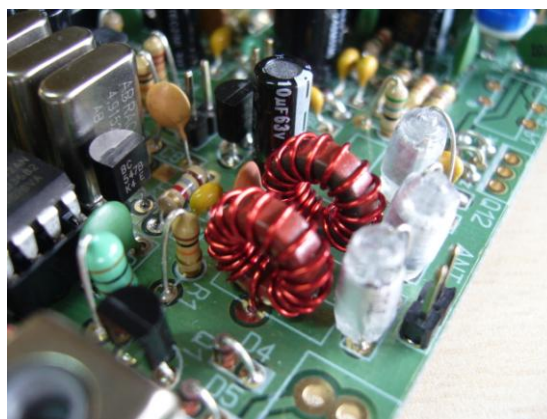
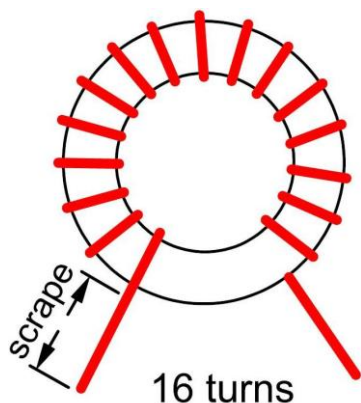

#### □ Toroidal transformer T5

T5 is an impedance matching transformer. A FT37-43 is used (black toroid with an OD of 9.5 mm / 0.375 in). It has a primary of 8 turns, going to "b" and "b1" holes in the PCB and one secondary of 1 turn going to "a" and "a1" holes.

- Cut 15 cm (6") of 0.5 mm enameled wire and wind 8 turns on the black FT37-43 toroidal core. Wind the wire tightly on the core, avoiding loose turns, and spread the turns evenly around the core. They should be uniformly spread around the circumference of the toroid. Leave pigtails of about 10-20 mm (0.70").
- Now take a resistor leftover of 15 – 20 mm (1/2-3/4 in) to make the 1 turn secondary (remember, one turn means that the wire goes once through the toroid core).
- Prior to its soldering, use a cutter, or sandpaper to scrape the enamel from the pigtails of the 8 turn winding.

**IMPORTANT:** Wind the T5 transformer exactly as shown in the pictures. You must follow both the number of turns and the winding direction.

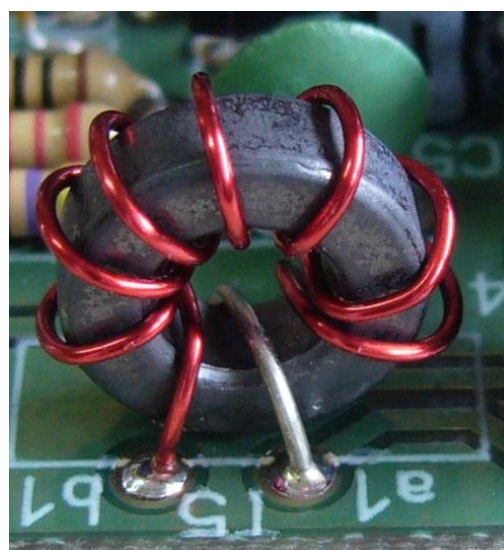
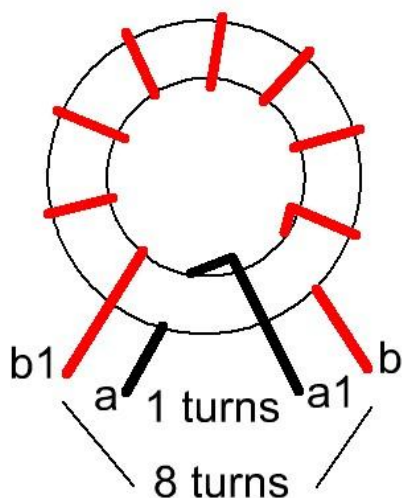

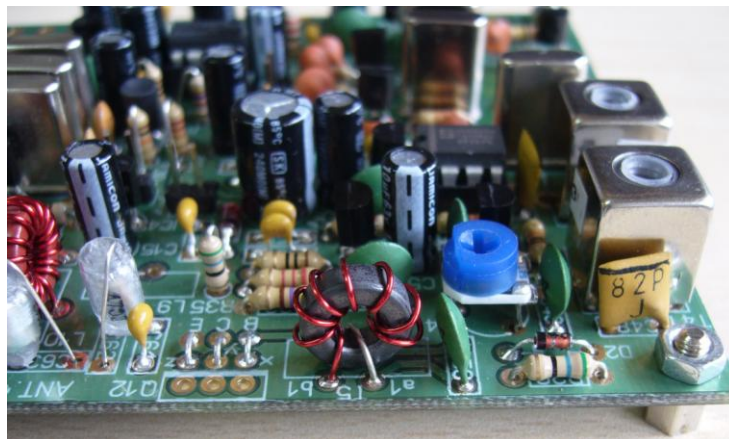

### □ L9 Toroid

L9 is an inductor acting as a collector choke on the TX power amplifier transistor. A FT37-32 is used (black toroid with an OD of 9.5 mm / 0.375 in). It has 6 turns.

Cut 12 cm (5") of 0.5 mm enameled wire and wind 6 turns on the black FT37-43 core. Wind the wire tightly on the core, avoiding loose turns, and spread the turns evenly around the circumference of the toroid. They should be uniformly spread around the circumference of the toroid. Leave pigtails of about 10 mm (0.4"). Remove the enamel of the pigtails with a cutter prior to soldering the toroid on the board.

The nominal value for L9 is 12.6  $\mu$ H.

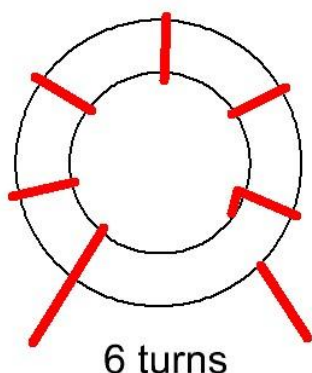

### □ Tuning Polyvaricon capacitor for the VXO CV2/CV3

Install the hardware shaft on the polyvaricon.

Place the Polyvaricon over the board at a distance of 3-5 mm (see picture). This eases the fitting of the variable cap to the front panel. Do not solder it until you know exactly how you are going to install the board on the box.

**You may want to mount the polyvaricon out of the board. This may be a good idea, but place it as close as possible and use short and rigid wires. Even small movements may affect the tuning!**



This polyvaricon contains two variable tuning capacitors inside. With the external jumpers J1 A/B you may select which section you will use; with the jumper in "B" you will use CV2, the larger capacitor, while on "A" the smaller CV3 will be used.

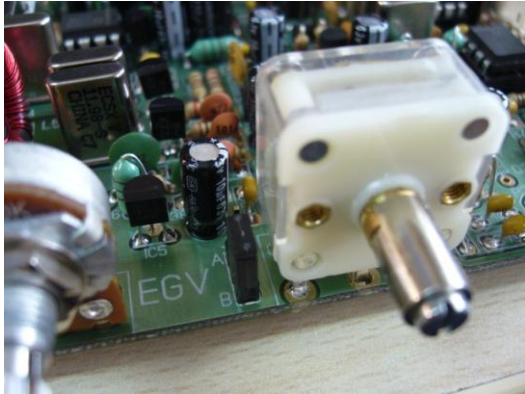

CV2 has about 150 pF, CV3 only 70 pf.

In the back of the capacitor there are two padders (small trimmers) for a fine adjustment. The one in the lower part "X" (close to the terminals) goes in parallel with CV2, and the one on top "Z" is for CV3. **Adjusting these you may change the upper limit of the band coverage by some 10-15 kHz!** You will have to adjust the upper limit with the polyvaricon in its minimum capacity (turned all the way clockwise). These adjustments will be carried out later on, in "ADJUSTMENTS AND CHECKS".

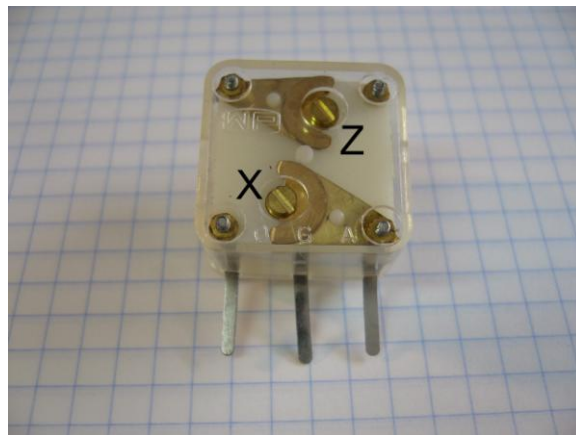

#### **IMPORTANT:**

- If you want to wire the polyvaricon out of the board, please take notice that, when mounting it with terminals up the connections get inverted and J1 A/B should be changed from J1B to J1A and vice versa.
- When screwing the polyvaricon to the front panel (M2,5 x 5 screws) take care not to drive the screws too much; they may block the internal mechanism of the polyvaricon. If needed, add one or more washers avoid this kind of trouble

#### **□ L5 Tuning inductor of the VXO**

A T68-2 is used (red toroid with an OD of 18 mm / 0.690 in).

Cut 102 cm (40 in) of 0.3 mm enameled wire and wind 48 turns on the T68-2. Leave pigtailed of 10-15 mm (3/8-1/2 in).



**IMPORTANT:** DO NOT INSTALL L5 now. You will install it later, when adjustments are made. (see the “ADJUSTMENTS AND CHECKS” section).

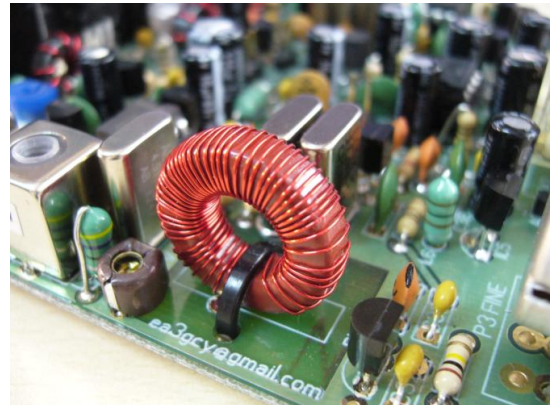

In order to make the process easier, L5 can be wound in two stages. Pass half of the wire through the toroid and wind half toroid; then, turn the toroid and wind the other half. In case of doubt about the turn count, you will be able to count them easily with a good light and a magnifying glass.

**□ P1, P2 and P3 potentiometers**

Install the pots P1 (RX attenuator), P2 (volume) y P3 (fine tuning) as shown in the picture. You may want to mount P2 and P3 in the front panel, out of the board. No problem, but use short wires. P3, the RF attenuator, is thought to be placed in the back panel; if you want to wire it use RF-rated mini coaxial cable.



**□ Q12 bridges ”B-C-E to ”x-y-z”**

The bridges “B-C-E to x-y-z” allows the use of different types of transistor for Q12. If need be we may use substitutes with different leg configurations.

The EGV-40 kit uses as Q12 a 2SC2078 and **the following bridges SHOULD BE INSTALLED: “B-x”, “C-y” and “E-z”**. Cut small pieces of wire (or resistor leftovers) to prepare the connections “B” to “x”, “C” to “y” and “E” to “z”

Take care and avoid any shortcircuits between bridges.

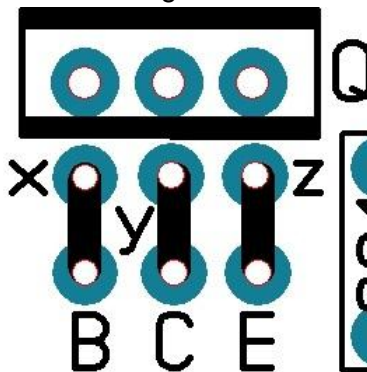

Q12 capsule (2SC2078) should be electrically isolated from the heatsink. Use the plastic washer and the mica sheet provided with the kit. Once the transistor is fitted over the heatsink, check with a multimeter that there is no continuity between the transistor tab, the screw and the heatsink. Use the insulating material and an M3 screw and nut. It is also recommended to apply a dab of thermal grease. You may also drill other hole on the heatsink if that suits better its position on your box.

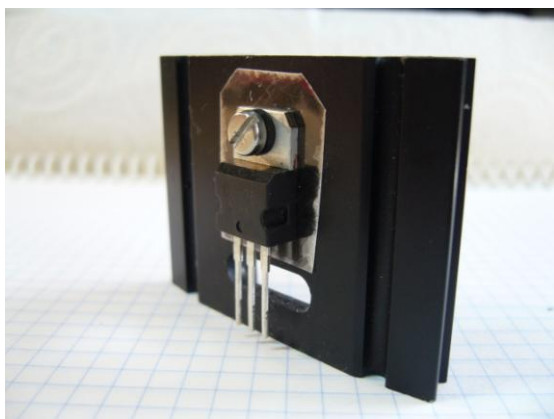

**DO NOT OPERATE the transceiver without a heatsink on Q12**

## ADJUSTMENTS AND CHECKS

### ☐ Preliminary testing

- Adjust P2 (volume), P3 (fine tuning), and P4 (TX output power) to mid position.
- Turn P1 (RF attenuator) all the way clockwise.
- Connect headphones to the header "PHONE" on the board.
- Connect a PSU (12-14 V) to the "VDC" header on the board.
- Measure the voltage on the following points (related to the receiver path):  
8 V from any leg of L6 and ground.  
6 V from any leg of R4 or R5 and ground.
- Turn the volume (P3) to the maximum; you will hear a hiss on the headphones.

If all is OK, you may continue.

If not, please check your kit (see section "If your kit does not work after assembly")

### ☐ Tuning adjustment of the inductor L5 and the Polyvaricon CV2/CV3

*NOTE: it is recommended to make all VXO adjustments with the "fine tuning" pot in its mid position; this way, once tuned the pot will allow you some extra coverage at both ends of the tuning range.*

The following task is more fun than you may think at first; it is not a "plug&play" one, but it is fun; leave one hour of relaxed time and enjoy it!

Solder the L5 pigtailed on their place over the board. Leave it for now some slack, so you may compress or spread the turns. Connect a frequency counter on the "VXO" header. If your counter has a low input impedance, insert between the counter and the header a resistor (470 ohm or more) or a small capacitance cap (try with 22 pF or less) to reduce the interaction between the counter and VXO.

If you don't have access to a counter, you may use an SSB or CW receiver with a digital dial covering the VXO frequency around 11.950 MHz. Connect to the receiver antenna input a length of wire with a small loop and place it over the EGV-40.

Note: A counter is highly recommended as the use of the receive is cumbersome.

On TX, the IF frequency of 4.915 MHz is subtracted from the VXO frequency to obtain the RF output signal. For instance: 11.945 – 4.915 to get 7.030 MHz.

On RX, the antenna signal is subtracted from the VXO frequency to obtain the IF frequency. For instance: 11.945 – 7.030 to get the IF of 4.915 MHz.

In both cases **VXO = RF + FI**

The polyvaricon capacitor contains two variable caps for tuning. J1 selects which section to use. Placing a jumper on "B" the larger CV2 (around 150 pf) is selected. Placing a jumper on "A" the smaller CV3 (70 pf) is selected.

**For normal use on the EGV-40 the jumper should be placed on J1 "A" (smaller capacity) when the polyvaricon is soldered directly on the board.** When the polyvaricon is placed out of the board, please notice that when mounted upside down, with the terminals up, the jumper connections get inverted, and you will have to place the jumper on J1 "B" instead of J1 "A".

*Lower limit of frequency.*

You may change the tuning coverage by spreading or compressing the turns. When the turns are compressed, the inductance increases and, thus, the coverage is larger (**the lower limit decreases**). When turns are spread, the inductance and, thus, the coverage diminishes. Spreading or compressing the turns a variation of a few kHz may be achieved.

The EGV-40 has been designed to have a lower limit of the tuning range around 7.000 MHz.

*Higher limit of frequency.*

In the back of the polyvaricon there are two padders (adjusting trimmers) “X” and “Z” to be used for the fine tuning. The one below, “X”, goes in parallel with CV2 (J1-B) and the one on top, “Z”, is for CV3 (J1-A). **These padders may move the upper limit up to about 10-20 kHz!** Make this adjustment with the polyvaricon on its minimum capacity (all the way clockwise). The EGV-40 has been designed to allow the adjustment of the upper limit of the coverage to 7.040 MHz.

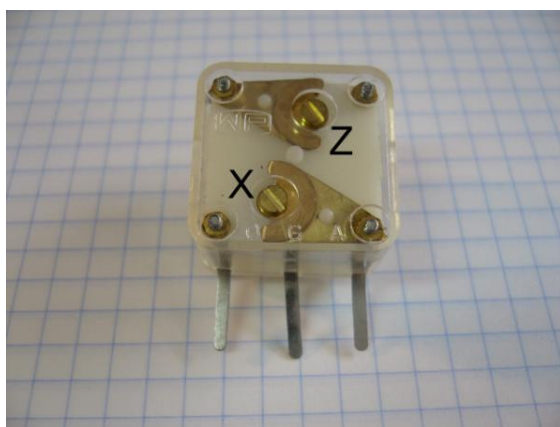

Please see some examples as an orientation:

CV3 L6= T68-2 48 turns.	Minimum		Maximum		Range
	MHz	MHz	MHz	MHz	
X5-X6 = 11.981Mhz.	VXO	RF	VXO	RF	
Turns widely spread	11.925	7.010	11.950	7.035	30 kHz
Turns less spread	11.915	7.000	11.958	7.043	43 kHz
Turns compressed	11.900	6.090	11.955	7.040	50 kHz

When the turns spread is changed, you may need to readjust slightly the “padder” on the polyvaricon to keep the tuning upper limit near 7.040MHz.



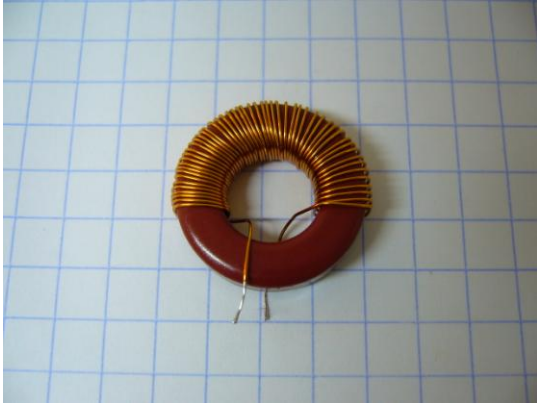

Once VXO coverage suits your needs you will have to secure L5 on its position on the board.

**The best and cleanest option is** to use a plastic retaining clamp throughout the holes on the board, as shown in the picture.

Once the clamp is fastened you will still have some slack to move a bit the turns and make slight adjustments. Once done, you may use nail polish to fix the turns.

*If you plan to use silicone or glues, please notice that, due to their composition, they may affect largely the characteristics of L5, even after curing. They also may absorb humidity, affecting its stability.*

L6 should remain well fixed, **it is very important**, since vibrations may change the VXO frequency causing "tremors" on the received and transmitted signals.

Prior to the L5 final fix to the board make all the adjustments and checks of the rig and confirm that the frequency coverage suits your needs.



Do not worry too much about the exact margin; is it so important to end at 40, 41 or 42 kHz?  
If you are dexterous, you may draw a dial in the front panel, with a scale to help you as a guide.

#### **□ RX adjustment. T1 and T2 bandpass. BFO oscillator CV1**

##### *T1-T2 bandpass*

Note: for this adjustment you will need a trimming tool for this kind of IF cans; if you use a screwdriver you may break and damage the coil core.

Turn P1 (RX attenuator) to minimum attenuation, that is, all the way clockwise.

If you have access to a RF generator, inject through the antenna header a signal on the receiving range of about 1-2  $\mu$ V, tune the receiver into it, and adjust alternately T1 and T2 until you get the maximum signal on the headphones.

If you don't have access to instrumentation, do not worry, as these adjustments are not critical at all. Connect an adequate antenna for 40 meters to EGV-40 and tune a strong CW signal, as stable as possible; adjust alternately T1 and T2 until you get the best reception on the headphones.

#### *BFO oscillator CV1*

Once you have the input bandpass filter (T1-T2) adjusted, you will have to adjust the CV1 trimmer to obtain the best CW note that suits your taste.

**Although this adjustment is not very critical, it is more important that it seems at first; the signals should sound bassy, and check also that this adjustment has an influence on the opposite sideband suppression.**

If you have access to a good counter with a sensible, high impedance input, try measuring the frequency on pin 6 or 7 of IC2 and adjusting CV1 to measure something between 4.9140 – 4.9141 MHz.

Note: some counters are not sensible enough or present a large load, changing the oscillating frequency and providing fake readings. You may try inserting between the counter and the pin a resistor (470 ohms or more) or a small cal (22 pF or less) to reduce the interaction between the counter and the BFO.

**REMEMBER: All transmission checks should be done with a 50 ohm load connected to the transmitter output.**

**DO NOT OPERATE the transceiver without a heatsink on Q12.**

#### **□ Adjustment of the TX, T3 and T4 bandpass filter. Adjustment of CV4, TX shift.**

Note: for this adjustment you will need a trimming tool for this kind of IF cans; if you use a screwdriver you may break and damage the coil core.

Connect a power meter and a 50 ohm load to the antenna connector. Turn P4 (power control) to mid position.

Connect a Morse key to the "KEY" headers and use the key to activate the transmitter (or shortcircuit the "KEY" headers.) You will notice that the receiver mutes and a reading on the wattmeter. Adjust alternately T3 and T4 to peak the power. With P4 on its mid position you will get some 2-2.5 W output power.

Put the headphones on and, while on TX, listen the sidetone monitor; turn CV4 until you hear a tone that suit your tastes. This adjustment can be done by ear, it is not critical at all, but usually the TX/RX shift lies around 600-700 Hz.

Please notice that the EGV is receiving its own transmitted frequency: the tone you are hearing is the same as the shift, the offset, of your transmission.

If you have access to an audio frequency meter you may check the frequency by measuring it at the headphone output.

Notes:

- While you are doing the transmitter adjustments, it is a good idea to touch Q12 heatsink every couple of minutes to check it is not overheating.

- If you plan to use always the same output power it is recommended to replace P4 with two fixed resistors of a similar value that the ones measured on P4 at the desired power.

## APPENDICES

### Appendix 1. "PHONE" headphone output. R16 limiting resistor.

The EGV-40 has not been designed to be used with loudspeakers directly.

On the "PHONE" header you may connect only headphones. Please use adequate headphones; bad ones will degrade the final outcome of your receiver. When checking several headphones, results will be very different and for us, hams, in many cases the most expensive headphones are not the best. Sometimes low cost headphones may result ideal for the purpose of listening to the EGV-40; this may be due to their sensitivity and the audio response, which may fit better the bandwidth required for the CW signals.

If you plan to use the EGV-40 at home, you may get very good results with PC multimedia speakers with their own amplifier (use 2.0 types of good quality, as systems with "sub-woofer" or "home cinema" are not adequate.)

-R16 limits the output level to the headphones and protects the audio amplifier in case of a shortcircuit at the output.

### Appendix 2. Transmitter power amplifier transistor Q12.

The 2SC2078 transistor included with the kit has been selected for the EGV for being a good output transistor for HF.

In case of need you may use others. Some transistors used on CB transceiver such as the 2SC2166 or 2SC1969 may be also used and offer a similar result. In some cases the terminal distribution is different. The bridges "B, E, C" - "x, y, z" will allow you to use any kind of TO-220 transistor as Q12.

Notes:

- Some transistors may have higher gain and, depending on their manufacturer, may be prone to auto-oscillations.
- Many of this kind of HF transistors offered in the market at low price are fakes and work bad or do not work at all.

### Appendix 3. The VXO as local oscillator.

Why are we using a VXO?

The classical -and economical- alternative to the VXO is a simple Variable Frequency Oscillator (VFO) or a Voltage Controlled Oscillator (VCO). In order to get very clean mixing products when an heterodyne system is used, it is recommended for both RX and, especially, for TX to use a Local Oscillator (LO) located over the Intermediate Frequency (IF), in our case 4.915 MHz, and over the working frequency, in our case 7.000 MHz. It will be possible to build a VFO LO on 2.085 - 2.125 MHz quite cheap and stable, but the mixing products on RX and TX will not be as clean as the ones produced with an LO on 11.9 MHz, as generated on the EGV-40 VXO.

The other option, a PLL driven VCO, will be adequate but expensive and cumbersome taking into account the number of parts required.

If you want to have a very precise transceiver, with high stability and digital dial, an excellent alternative is the use of a DDS circuit. I will recommend you the ILER-DDS from EA3GCY.

Note:

If you have bought the EGV-40 and the ILER-DDS you don't need to install any of the parts related to the VXO circuit. Please see Appendix 7.

### Appendix 4. Sidetone level. R6 value.

The sidetone level is fixed by R6. With the R6 resistor included with the kit the sidetone level is sufficient but soft. You may change the value between 1 M and 10 M to get the required level.



### **Appendix 5. Full-Break-in delay. C17 value.**

The TX/RX switching delay may be modified by exchanging C17 with a cap of different value. The kit includes a C17 cap of 100nF, getting a delay of 300-400 ms. You may increase or reduce the value of C17 to increase or reduce the delay. If you remove C17, you will be able to work with Full Break-in, but it is recommended to include a small capacitor to get a delay of some tens of ms to avoid switching clicks and noises.

### **Appendix 6. "Fine tune" coverage**

The P3 control acts as a fine tuning associated to the main tuning carried out by the polyvaricon and, obviously, **they both work on RX and TX.**

If you prefer to use a mechanical reduction on the shaft of the polyvaricon or a larger diameter button, you may disable the P3 pot but just removing it from the PCB; we recommend that, instead, you place two 4K7 resistors to keep the overall coverage of the VXO as previously adjusted. If you remove completely the "Fine tuning" circuit, including the DV1 varicap diode, the upper frequency limit may lie above the CW segment with no adjustment possible to lower it.

The "Fine tuning" control changes 1-2 kHz in the lower part of the coverage range and 5-6 kHz in the upper part. This is due to the nature of the circuit, the lack of linearity on the tuning circuit, and the fact that a similar change on the capacity external to the polyvaricon affects differently to the tuned frequency depending on the part of the band.

#### *Use of the "Fine tuning" control*

We recommend to place it normally on its mid position. Once you have find a station with the Main tuning control, move the Fine tuning to tune it spot on. Once you have finished the QSO, or when you want to search for other stations, return first the Fine tuning control to its mid position.

Note: You may change the coverage of the "Fine tuning" control by changing the value of the capacitor C31 and/or the resistor R18.

### **Appendix 7. Use of the ILER-DDS with the EGV-40**

The ILER-DDS offers a high stability oscillator against temperature changes, with a 10 Hz resolution and frequency reading on an LCD. Moreover, the ILER-DDS may be configured to work with any other IF value, place band limits, quickly change the tuning steps, display the PSU voltage, etc.

-If you have a working EGV-40 with its VXO and want to install an ILER-DDS, you need to disable the VXO by just disconnecting L6 and connecting the DDS output to the "VXO" header on the EGV-40.

-If you have bought the EGV-40 and the ILER-DDS and you want to install it from scratch you don't need to install any of the parts related to the VXO circuit with the exception of R26.

The following list gathers the parts related to the VXO that you don't need to install if you plan to use always the rig with the ILER-DDS:

*R18, P3, R19, R20, R21, R22, R23, R24, R25, and pot P3*

*C30, C31, C32, C33, C34, C35, C36, C37, C38, and Polyvaricon CV2/CV3*

*L6, DV1, Q7, Q8, IC5, X5, and X6*

### **Appendix 8. IF bandwidth**

The nominal bandwidth of the IF filter is of 800 Hz (at -6 dB). This offers a good selectivity for an easy listening of the CW signals. The IF bandwidth, however, may be modified by simply exchanging the caps on C8 and C9. You may reduce their value down to 100 pf to get a wider bandwidth (less selectivity). This change produces some mismatches on the terminating impedance and the ripple on the filter response may increase, but most of the time you will not notice it.

## IF YOUR KIT DOES NOT WORK AFTER ASSEMBLY

Don't worry, it is not uncommon a non working kit on the first try; be calm as in the majority of cases they are small mistakes with a simple fix.

Most faults are due to poorly soldered connections or misplaced parts; it is very rare to find a faulty part. Before taking any measurements with instruments, check all connections, inspect your soldering work looking for cold connections, shortcircuits between tracks, sockets not making good contact, or parts placed in the wrong place.

If your kit does not work after final assembly, please follow these steps in order:

-Double-check every step in the assembly manual, pads soldered, and right parts placed in their right position.

-If you have access to instrumentation, take readings, and follow the signals on the circuit to diagnose what is happening and why.

-Talk to a ham with experience on kits or a technician to check your work. A fresh look to your circuit may find things you had overlooked.

-In case of need, your request for technical assistance by email to [ea3qcy@gmail.com](mailto:ea3qcy@gmail.com) is welcomed. As a last resource, you may send the kit for a repair; I will have to charge, though, the repair needed, but I will try the cost will be as moderate as possible.

To help you troubleshooting your rig, it may be useful the following voltage table. The voltages on the IC's and transistors have been measured on Reception and on Transmission. If there is a fault, it is quite probable that one or more readings will be largely different.

Voltages while on reception without signal on the antenna. PSU voltage 13.8V.

	Q1	Q2	Q3	Q4	Q5	Q6	Q7	Q8	Q9	Q10	Q11	Q12
<b>B</b>	0	4.75	(G)3.67	(G)3.67	0	0	3.75	3.87	13.75	0	0	0
<b>C</b>	0	5.90	(D)4.80	(D)4.82	3.67	1.39	7.90	7.90	13.8	0	0	0
<b>E</b>	0	4.10	(S)4.80	(S)4.80	0	0	4.30	3.93	0	0	0	0

	IC1	IC2	IC3	IC4	IC5	IC6	IC7
<b>1</b>	1.39	1.39	1.34	Out 5.96	Out 7.98	0	Out 0.0
<b>2</b>	1.39	1.39	0	--	--	0	--
<b>3</b>	0	0	0	--	--	0	--
<b>4</b>	4.74	4.80	0	--	--	0	--
<b>5</b>	4.76	4.80	6.81	--	--	0	--
<b>6</b>	5.84	5.90	13.60	--	--	0	--
<b>7</b>	5.23	5.43	6.90	--	--	0	--
<b>8</b>	5.90	5.90	1.34	--	--	0	--

Voltages on transmission with P4 adjusted to minimum (no output power). PSU voltage 13.8V.

	Q1	Q2	Q3	Q4	Q5	Q6	Q7	Q8	Q9	Q10	Q11	Q12
<b>B</b>	0.70	4.75	(G)0	(G)0	0.70	0	3.75	3.87	12.98	4.10	2.40	0
<b>C</b>	0	5.90	(D)3.25	(D)3.75	0	1.39	7.90	7.90	13.65	13.49	13.65	13.80
<b>E</b>	0	4.09	(S)4.81	(S)4.82	0	0	4.30	3.93	13.80	3.45	1.80	0

	IC1	IC2	IC3	IC4	IC5	IC6	IC7
<b>1</b>	1.39	1.39	1.35	Out 5.96	Out 7.98	1.39	Out 5.98
<b>2</b>	1.39	1.39	0	--	--	1.39	--
<b>3</b>	0	0	0	--	--	0	--
<b>4</b>	4.75	4.81	0	--	--	4.74	--
<b>5</b>	4.77	4.82	6.82	--	--	4.74	--
<b>6</b>	5.84	5.90	13.63	--	--	5.93	--
<b>7</b>	5.20	5.44	6.92	--	--	5.36	--
<b>8</b>	5.90	5.95	1.35	--	--	5.98	--

Note: Values of +/- 5% can be considered correct.

## Limited WARRANTY

### Please read carefully BEFORE building your kit

All parts and hardware supplied with the kit are under warranty in case of manufacturing defect for the period of one year after sale. The warranty does not include the transmitter power amplifier transistor.

The original purchaser has the option of examining the kit and manual for 10 days. If, within this period, the buyer decides not to build the kit, he or she may return the entire unassembled kit at their own expense. Shipping charges included on the kit price and sale commissions (by banks or "Paypal", etc) won't be returned..

Please, BEFORE making a return, ask for directions by email to: [ea3gcy@gmail.com](mailto:ea3gcy@gmail.com).

Javier Solans, ea3gcy, warrants this device to function as described in this documentation provided that it is assembled and used correctly according to all printed instructions.

It is your responsibility to follow all directions in the instruction manual, to identify parts correctly, and to use good workmanship and proper tools and instruments in constructing and adjusting this kit.

REMEMBER: This kit will not work as a commercially manufactured set, however, can often give similar results. Do not expect great performance, but it is sure that you will have a lot of fun!

If you notice a missing kit part missing, please do first a thorough inventory. Check all bags, envelopes or boxes carefully. If need be, email me and I will promptly replace any missing part. Even in the case that you find the exact replacement locally, please let us know so we are aware of the problem and get ready to help other customers.

I can also supply any part that you have lost or break accidentally.

If you find any errors in this manual or would like to make a comment, please do not hesitate in contacting me at: [ea3gcy@gmail.com](mailto:ea3gcy@gmail.com)

THANKS for building the EGV-40 CW transceiver kit.

Enjoy QRP!

73 Javier Solans, ea3gcy

# SCHEMATICS

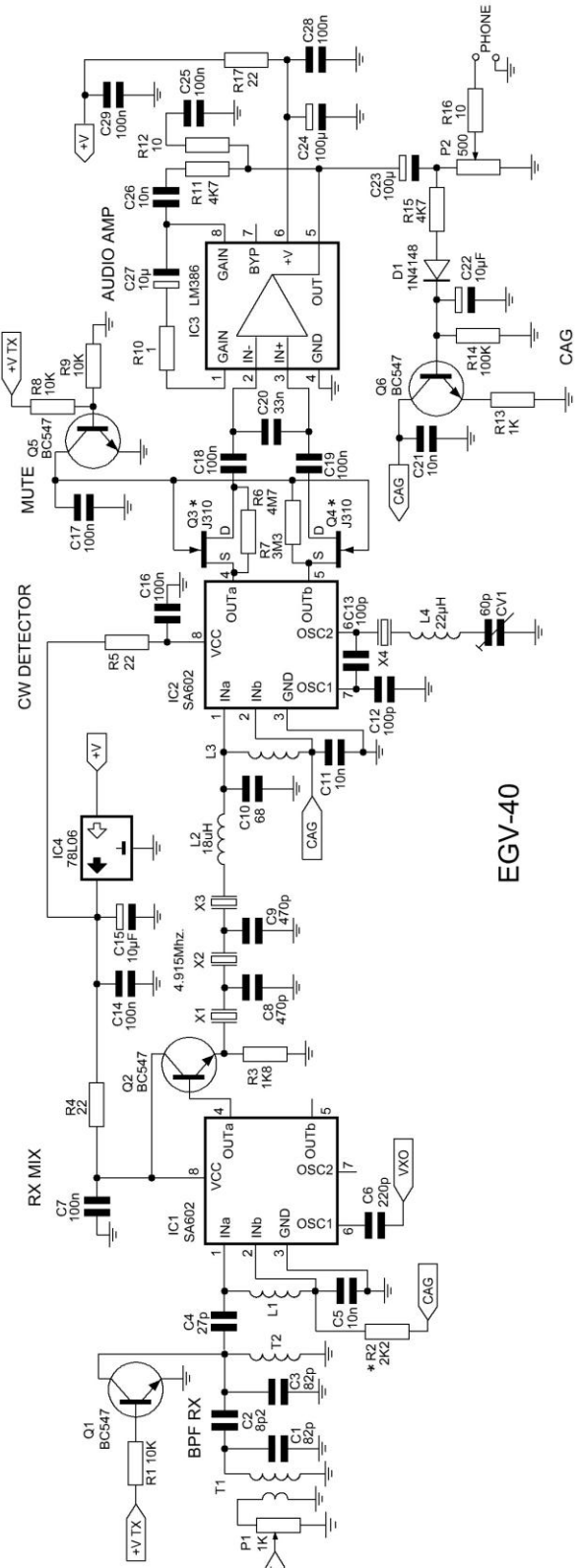
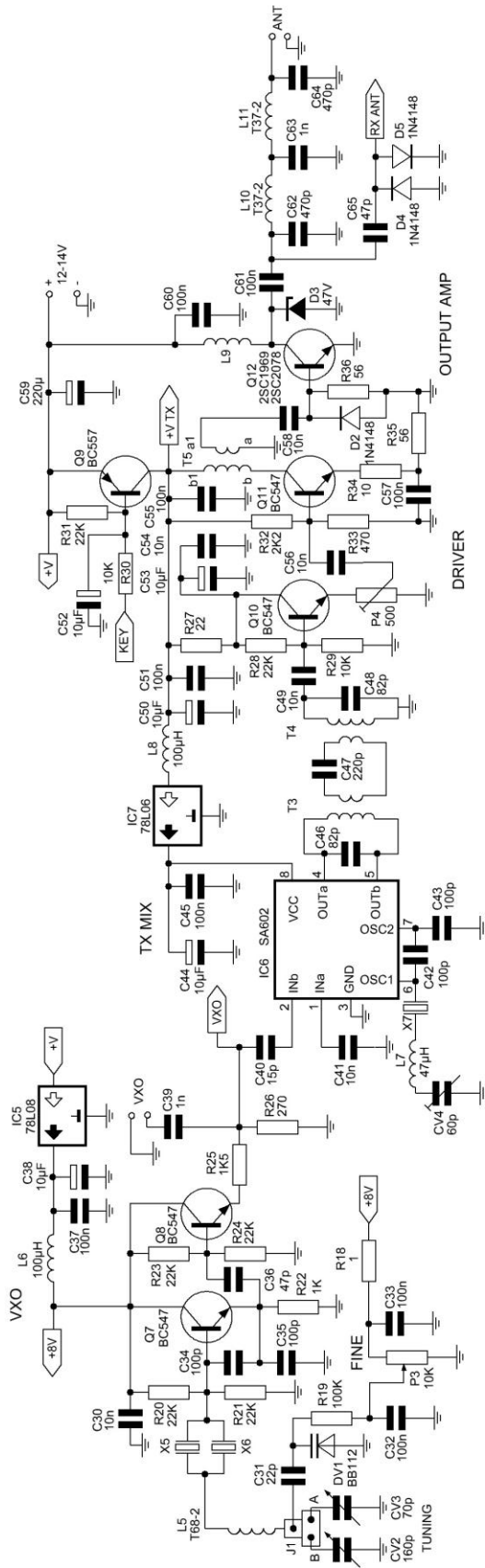

EGV-40

# WIRING

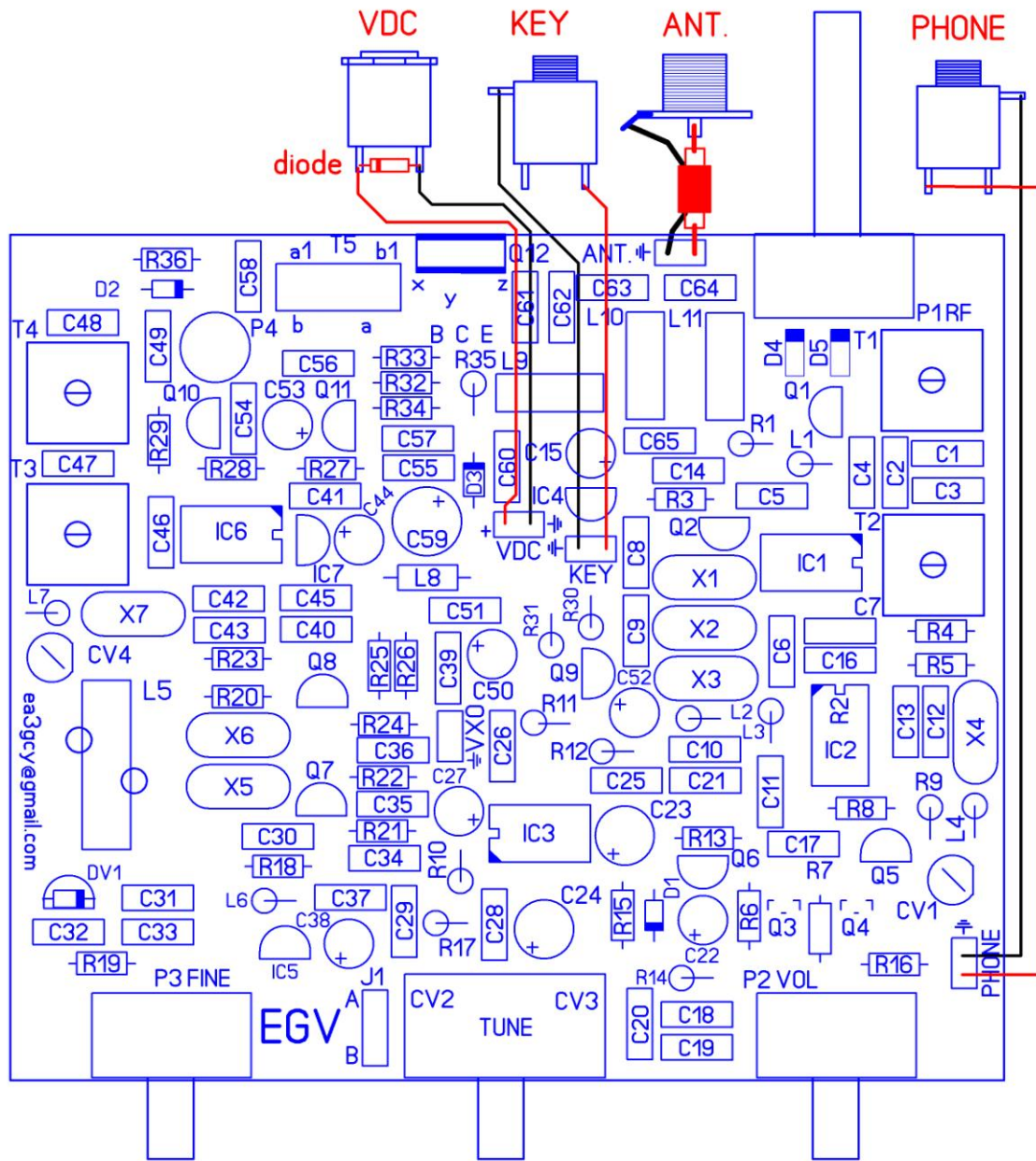

The EGV-40 wiring is very simple:

- For the antenna connection use RF-rated fine coaxial cable such as RG-174 or similar.
- If you place the polyvaricon outboard, use short and rigid wires as the mechanical stability is important.
- A metal box is highly recommended

**Take notice that the EGV-40 is NOT PROTECTED against polarity inversions!**

It is a good idea to place a diode (ex. BY255 or larger) in parallel with the PSU input on the EGV-40. The cathode (the end with the printed band) goes to the positive wire. If your PSU supports shortcircuits or has a fuse on its output, OK; else you will need to buy or build a cable with an on-line fuse in series.