

ELECRAFT K2 TRANSCEIVER

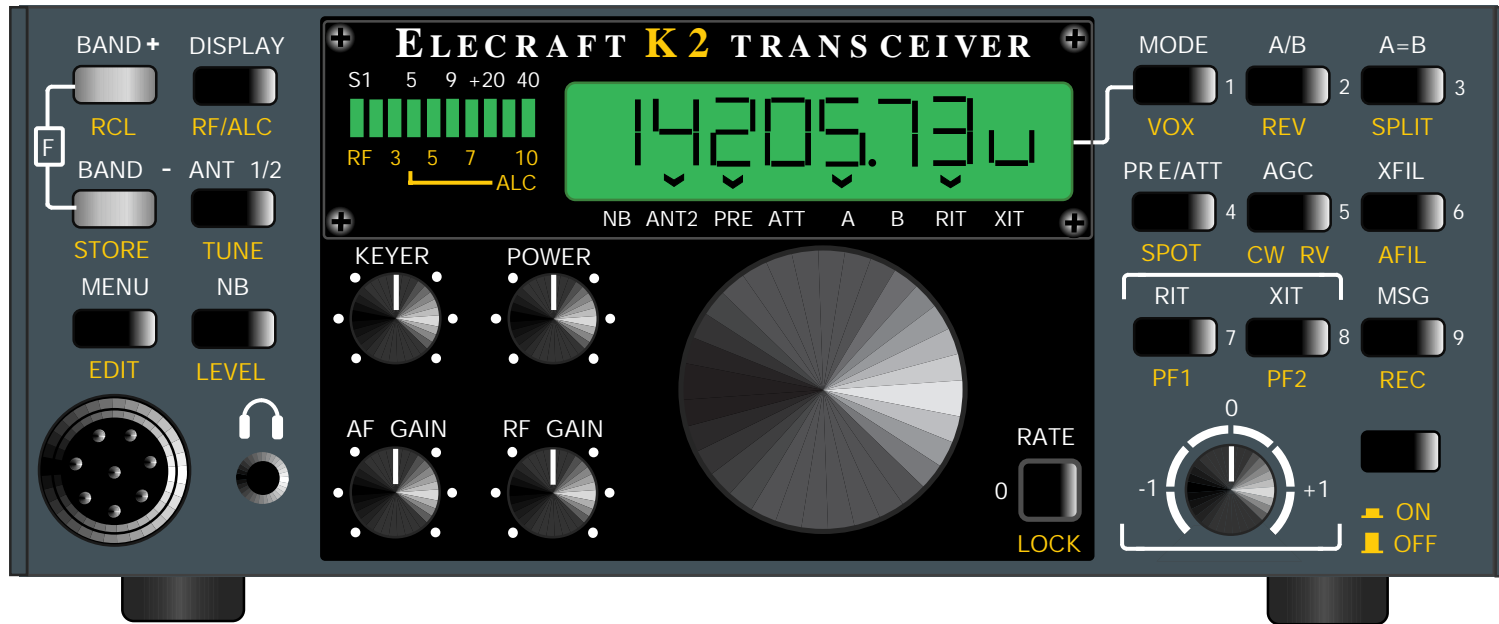

Downloaded by RadioAmateur.EU

OWNER'S MANUAL



ELECRAFT K2

160-10 Meter SSB/CW Transceiver Owner's Manual

Revision E, February 16, 2003

Copyright © 2003 Elecraft, LLC
All Rights Reserved

Table of Contents

1. INTRODUCTION.....	3
2. SPECIFICATIONS.....	5
3. PREPARATION FOR ASSEMBLY.....	7
4. CONTROL BOARD.....	13
5. FRONT PANEL BOARD.....	21
6. RF BOARD.....	32
7. FINAL ASSEMBLY.....	75
8. OPERATION.....	78
9. CIRCUIT DETAILS.....	103
10. OPTIONS.....	110
PARTS LIST.....	APPENDIX A
SCHEMATIC.....	APPENDIX B
BLOCK DIAGRAM.....	APPENDIX C
PHOTOGRAPHS.....	APPENDIX D
TROUBLESHOOTING.....	APPENDIX E
PARTS PLACEMENT DRAWINGS.....	APPENDIX F
100-WATT STAGE AND RS232 I/O (K2/100).....	APPENDIX G (SUPPLIED WITH KPA100 OPTION)

1. Introduction

The Elecraft K2 is a high-performance, synthesized, CW/SSB transceiver that covers all HF bands. It is a true dual-purpose transceiver, combining the operating features you'd expect in a home-station rig with the small size and weight of a rugged, go-anywhere portable.

The basic K2 operates on 80-10 meter CW, and provides over 10 watts of RF output. If you prefer a full-power station, you can complete your K2 as a K2/100 at any time by adding the internal 100-watt final stage (KPA100 option). Assembly of the KPA100 is covered in Appendix G, a separate manual supplied with the KPA100 kit.

You can customize your K2 by choosing from a wide range of additional options:

- SSB adapter with optimized 7-pole crystal filter
- Automatic antenna tuner (20 W internal or 150 W external)
- 160-m adapter with receive antenna switch
- 60-m adapter with low-level transverter interface
- Computer control interface (RS232)
- Noise blanker
- Low-noise audio filter and real-time clock
- Internal 2.9-Ah rechargeable battery

For a complete description of available options, see page 110. In addition to the options, a companion enclosure the same size and style as the K2 is available for those who wish to build their own matching station accessories (model EC2).

The K2 is an intermediate-level kit, yet you'll be pleasantly surprised at how uncomplicated it is to build. All of the RF (radio-frequency) circuitry is contained on a single board, while two plug-in modules provide front panel and control functions. Wiring is minimal, unlike traditional kits which depend on complex wiring harnesses.

A unique feature of the K2 is that it provides its own built-in test equipment, including a digital voltmeter, ammeter, wattmeter, complete RF probe, and frequency counter. These circuits are completed early in assembly, so they're ready to be used when you begin construction and alignment of the RF board. We also provide complete troubleshooting and signal-tracing information.

In addition to this owner's manual, you'll find extensive support for the K2 on our website, www.elecraft.com. Among the available materials are manual updates, application notes, photographs, and information on new products. There's also an e-mail forum; sign-up is available from the web page. It's a great way to seek advice from the K2's designers and your fellow builders, or to tell us about your first QSO using the K2.

We'd like to thank you for choosing the K2 transceiver, and hope it meets your expectations for operation both at home and in the field.

Wayne Burdick, N6KR
Eric Swartz, WA6HHQ

Pre-Wound Toroids Available

You can obtain a set of pre-wound toroids for the K2 if you prefer not to wind them yourself. Refer to our web site for details.

Customer Service Information

Technical Assistance

If you have difficulty with kit construction, operation, or troubleshooting, we're here to help. You may be able to save time by first consulting our web site, www.elecraft.com, or by posting your question on our e-mail forum, elecraft@mailman.qth.net.

Telephone assistance is available from 9 A.M. to 5 P.M. Pacific time (weekdays) at 831-662-8345. Via e-mail, use support@elecraft.com for support and parts@elecraft.com to request replacement parts. *Please use e-mail when possible; this gives us a written record of the details of your problem.*

Repair Service

If necessary, you may return your completed kit to us for repair. Contact Elecraft before mailing your kit to obtain current information on repair fees. (Kits that have been soldered using acid core solder, water-soluble flux solder, or other corrosive or conductive fluxes or solvents cannot be accepted for repair.)

The following information should be provided to expedite repair: your name, address, and phone number; your e-mail address (if applicable); and a complete description of the problem.

Shipping: First, seal the unit in a plastic bag to protect the finish from dust and abrasion. Use a sturdy packing carton with 3" or more of foam or shredded paper on all sides. Seal the package with reinforced tape. (Neither Elecraft nor the carrier will accept liability for damage due to improper packaging.) Cover the "to" address label with clear tape so it will be weatherproof. Finally, call or send e-mail to obtain the proper shipping address.

Elecraft's 1-Year Limited Warranty

This warranty is effective as of the date of first consumer purchase. Before requesting warranty service, you should complete the assembly, carefully following all instructions in the manual.

What is covered: During the first year after date of purchase, Elecraft will replace defective parts free of charge (post-paid). We will also correct any malfunction caused by defective parts and materials. You must send the unit at your expense to Elecraft, but we will pay return shipping.

What is not covered: This warranty does not cover correction of assembly errors or misalignment; repair of damage caused by misuse, negligence, or builder modifications; or any performance malfunctions involving non-Elecraft accessory equipment. *The use of acid-core solder, water-soluble flux solder, or any corrosive or conductive flux or solvent will void this warranty in its entirety.* Also not covered is reimbursement for loss of use, inconvenience, customer assembly or alignment time, or cost of unauthorized service.

Limitation of incidental or consequential damages: This warranty does not extend to non-Elecraft equipment or components used in conjunction with our products. *Any such repair or replacement is the responsibility of the customer. Elecraft will not be liable for any special, indirect, incidental or consequential damages, including but not limited to any loss of business or profits.*

2. Specifications

All measurements were made using a 14.0 V supply and 50-ohm load unless otherwise indicated. Values are typical; your results will be somewhat different. Specifications are subject to change without notice. (See option manuals for additional specifications.)

General

Size	
Cabinet	3.0" H x 7.9" W x 8.3" D (7.5 x 20 x 21 cm)
Overall	3.4" H x 7.9" W x 9.9" D (8.5 x 20 x 25 cm)
Weight	3.3 lbs. (1.5 kg), excluding options
Supply voltage	9 to 15 VDC; reverse-polarity protection; internal self-resetting fuse
Current drain, Receive	120-150 mA in minimum-current configuration; 180-250 mA typical
Transmit ¹	2.0 A typical at 10 watts; programmable current limiting
Frequency control	PLL synthesizer w/single VCO covering 6.7-24 MHz in 10 bands; fine steps via DAC-tuned reference

¹ Current varies with band, supply voltage, configuration, and load impedance. We recommend a minimum 3.5-amp power supply.

Frequency ranges,² MHz

Basic kit	3.5-4.0, 7.0-7.3, 10.0-10.2, 14.0-14.5, 18.0-18.2, 21.0-21.6, 24.8-25.0, 28.0-28.8
160 m (opt.)	1.8-2.0
60 m (opt.)	5.0-5.5

VFO

Stability	< 100 Hz total drift typ. from cold start at 25° C
Accuracy ³	+/- 30 Hz over a 500 kHz range (typ) when calibrated
Resolution	10 Hz
Tuning steps	10 Hz, 50 Hz, and 1000 Hz nominal (other step sizes available via menu)
Memories	20 (10 assigned to 160-10 m Bands; 10 general-purpose)
RIT/XIT range	+/- 0.6 to +/- 4.8 kHz (selectable); 10-40 Hz steps depending on range. Fine RIT mode steps 2-3 Hz typ.

Downloaded by RadioAmateur.EU

² The K2 can receive well outside the indicated bands, but this extended range is not specified or guaranteed. Transmit ranges may be limited for export to some countries. The K2/100 (KPA100 option) limits transmit from 25-27.999 MHz to 10 watts or less.

³ See Frequency Calibration Techniques (page).

Transmitter

Power output range	<0.5 W to >10 W (typ.); power setting resolution 0.1 W, accuracy 10% @ 5 W
Min. supply voltage recommended ⁴	9.0 V min for 2 watts out 9.5 V min for 5 watts out 10.0 V min for 7 watts out 10.5 V min for 10 watts out
Duty cycle	5 W, 100%; 10 W, 50%
Spurious products	-40 dB or better @ 10 W (-50 typ)
Harmonic content	-45 dB or better @ 10 W (-55 typ)
Load tolerance	2:1 or better SWR recommended; will survive operation into high SWR
T-R delay	approx. 10 ms-2.5 sec, adjustable
External keying	70 WPM max.
CW sidetone	400-800 Hz in 10 Hz steps

Keyer

Keying modes	Iambic A and B; adjustable weight
Speed range	9 - 50 WPM
Message memory	9 buffers of 250 bytes each; 1-level chaining; auto-repeat (0 - 255 s)

Receiver

	Preamp On	Preamp Off
Sensitivity (MDS)	-135 dBm	-130 dBm
3 rd -order intercept	0 to +7.5 ⁵	+10
2 nd -order intercept	+70	+70
Dynamic range, Blocking	125 dB	133 dB
Two-tone	96	97
I.F.	4.915 MHz (single conversion)	
Selectivity, CW	7-pole variable-bandwidth crystal filter, approx. 200-2000 Hz	
SSB ⁶	7-pole fixed-bandwidth crystal filter, 2.2 kHz typ.	
Audio output	1 watt max. into 4-ohm load	
Speaker	internal: 4 ohm, 3 W; Rear-panel jack for external speaker	
Headphones	4 - 32 ohms, stereo or mono	

Downloaded by
RadioAmateur.EU

⁴ For reference only; not guaranteed. If higher power than shown here is to be used for a given supply voltage, monitor transmitter output signal.

⁵ Varies with band.

⁶ With optional SSB adapter. Other CW and SSB fixed crystal filter options may be available

3. Preparation for Assembly

Overview of the Kit

The K2 uses modular construction, both physically and electrically. This concept extends to the chassis (Figure 3-1). Any chassis element can be removed during assembly or troubleshooting. (Also see photos in Appendix D.) If the KPA100 is installed, it takes the place of the original top cover.

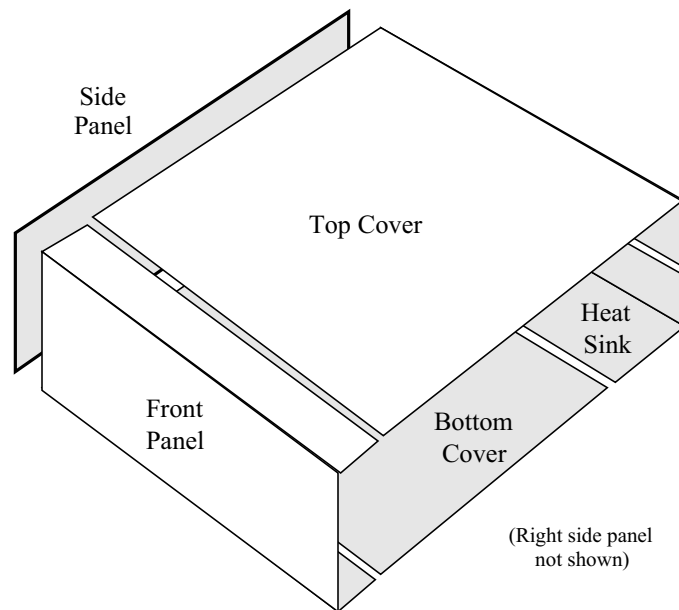

Figure 3-1

As shown in Figure 3-2, there are three printed circuit boards (PCBs) in the basic K2 kit: the Front Panel board, Control Board, and RF board. Option modules plug into the RF or Control board, but are not shown here.

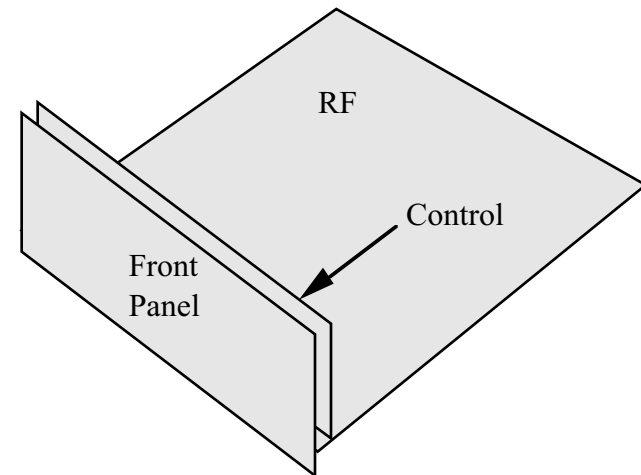

Figure 3-2

Board-to-board Connectors

The circuit boards in the K2 are interconnected using *board-to-board* connectors, which eliminates nearly all hand wiring. Gold-plated contacts are used on these connectors for reliability and corrosion resistance.

Figure 3-3 shows a side view of the PC boards and board-to-board connectors. As can be seen in the drawing, the Front Panel board has a connector **J1** which mates with right-angle connector **P1** on the RF board. Similarly, right-angle connector **P1** on the Control Board mates with **J6** on the RF board. (Not shown in this drawing are two additional right-angle connectors on the Control board, P2 and P3, which mate with J7 and J8 on the RF board.)

These multi-pin connectors are very difficult to remove once soldered in place. Refer to Figure 3-3 during assembly to make sure you have each connector placed correctly before soldering.

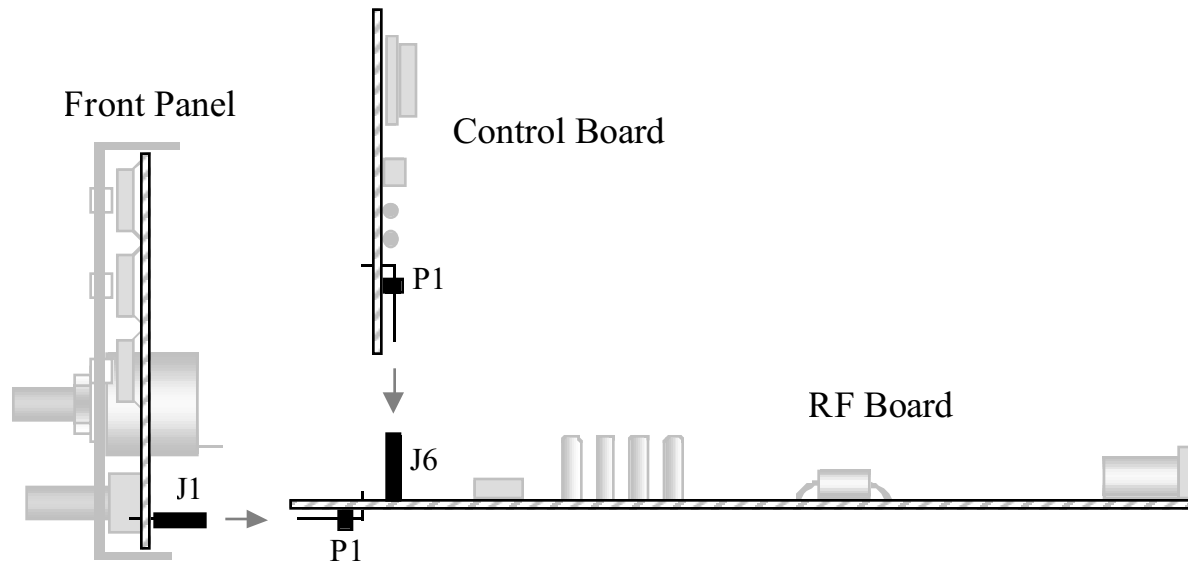

Figure 3-3

There are six steps in the K2 assembly process:

1. Control Board assembly
2. Front Panel Board assembly
3. RF Board assembly and test, part I (control circuits)
4. RF Board assembly and test, part II (receiver and synthesizer)
5. RF Board assembly and test, part III (transmitter)
6. Final assembly

This assembly sequence is important because later steps build on the previous ones. For example, in step 3 you'll put the modules together for the first time, allowing you to try out the K2's built-in frequency counter. The counter will then be used in step 4 to align and test the receiver and synthesizer on 40 meters. In step 5 all the pieces will come together when you complete the transmitter and filters, then align the K2 on all bands. The last few details—speaker, tilt stand, etc.—will be wrapped up in step 6.

Unpacking and Inventory

When you open the kit you should find the following items:

- six chassis pieces (Figure 3-1)
- three printed circuit boards (Figure 3-2)
- **FRONT PANEL** board components bag
- **CONTROL** board components bag
- **RF** board components in two bags
- **MISCELLANEOUS** components bag (includes hardware)
- **WIRE** bag
- 4-ohm Speaker, 5 small knobs, and large tuning knob
- plastic tube containing the latching relays
- an envelope containing the LCD bezel, green LED bargraph filter, serial number label, thermal insulators, and other items

Inventory

We strongly recommend that you do an inventory of parts before beginning to assemble the kit. It is not necessary to inventory the resistors, which are supplied attached to tape in assembly order.

Even if you don't do an inventory, it is helpful to familiarize yourself with the parts list, Appendix A. Additional information on identifying capacitor, chokes, and resistors is provided below.

Identifying Capacitors

Small-value fixed capacitors are usually marked with one, two, or three digits and no decimal point. If one or two digits are used, that is always the value in *picofarads* (pF). If there are three digits, the third digit is a multiplier. For example, a capacitor marked "151" would be 150 pF (15 with a multiplier of 10^1). Similarly, "330" would be 33 pF, and "102" would be 1000 pF (or .001 μ F). **In rare cases a capacitor manufacturer may use "0" as a decimal placeholder.** For example, "820" might mean 820 pF rather than the usual 82 pF. Such exceptions are *usually* covered in the parts lists. To be safe, measure the values of all capacitors below 1000 pF (most DMMs include capacitance measurement capability).

Fixed capacitors with values of 1000 pF or higher generally use a decimal point in the value, such as .001 or .02. This is the value in *microfarads* (μ F). Capacitors also may have a suffix after the value, such as ".001J." In some cases the suffixes or other supplemental markings may be useful in identifying capacitors.

Hard-to-identify capacitor values:

3.3 pF: These capacitors may have pillow-shaped, dark-green bodies about 1/8" (3 mm) square, with a black mark on the top. The "3.3" label may be difficult to read without a magnifying glass.

150 pF: These are correctly marked "151" on one side, but the other side may be marked #21 ASD, where "#21" looks like "821."

Resistors, Chokes, and the Color Code

All resistor and RF choke color bands are provided in the text along with their values. However, it is helpful to familiarize yourself with the color code to allow you to identify these components without having to refer to the text or parts list each time.

The color-code chart, Figure 3-4, shows how to read the four color bands on 5% resistors. 1% resistors are similar, except that they use five bands (three significant digits, multiplier, and tolerance). For example, a 1,500 ohm (1.5 k) 5% resistor has color bands BROWN, GREEN, and RED. A 1.5 k, 1% resistor has color bands BROWN, GREEN, BLACK, BROWN. The multiplier value is 1 rather than 2 in the 1% case because of the third significant digit.

Because 1% resistors have color bands that are sometimes hard to distinguish clearly, you should always check their resistance using an ohmmeter.

The markings on RF chokes reflect their value in microhenries (μH). Like 5% resistors, chokes use two significant digits and a multiplier. Example: an RF choke with color bands RED, VIOLET, BLACK would have a value of 27 μH .

Tools

The following specialized tools are supplied with the K2:

- .050" (1.3 mm) Allen Wrench, short handle
- 5/64" (2 mm) Allen Wrench, long handle
- Double-ended plastic inductor alignment tool

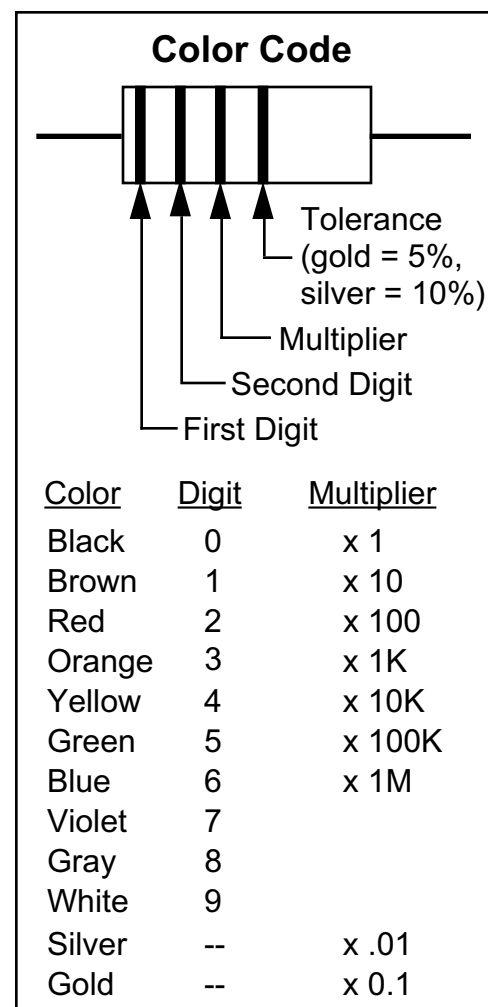

Downloaded by RadioAmateur.EU

Figure 3-4

In addition to the tools supplied, you will need these standard tools:

- Fine-tip soldering iron, 20-40 watt (temperature-controlled preferred, with 700 or 800°F tip [370-430°C])
- IC-grade, small-diameter (.031") solder (**DO NOT use acid-core solder, water-soluble flux solder, additional flux, or solvents of any kind, which will void your warranty**)
- Desoldering tools (wick, solder-sucker, etc.)
- Needle-nose pliers
- Small-point diagonal cutters, preferably flush-cutting
- Small Phillips screwdriver
- Jeweler's flat-blade screwdriver

While not required, the following items are recommended:

- DMM (digital multimeter) for doing resistance and voltage checks. A DMM with capacitance measurement capability is strongly recommended (see *Identifying Capacitors*).
- Magnifying glass
- Conductive wrist strap

Assembly Notes



This symbol is used to alert you to important information about assembly, alignment, or operation of the K2.

Photographs

You should review the photographs in Appendix D to get an idea of what the completed PC board assemblies look like.

Step-by-Step Assembly

Each step in the assembly process is accompanied by a check-box:



In some steps you will actually be installing multiple components of a particular type. In this case the instructions will be followed by a table listing all of the components to be installed, so you won't need to refer to the parts list during assembly. The order that the components are installed corresponds to their PCB locations.

Do not skip any assembly steps; you may find that you've installed one component that hinders the installation of another.

Forming component leads: In a few cases you'll find that the space provided for a component on the PC board is larger than the distance between the leads on the part itself. In such cases, you'll need to carefully bend the leads out and then down to fit the given space. Always use needle-nose pliers to accomplish this task, and *bend* the leads—don't tug on them. This is especially important with capacitor leads, which are fragile.

Bottom-Mounted Components

A number of components in the K2 are mounted on the *bottom* of the PC boards to improve component spacing or for electrical reasons. Component outline symbols are provided on both sides of each board, so it will always be clear which side a particular component goes on. You'll be able to tell the top of the board from the bottom easily: the top side has far more parts. Bottom-mounted parts are identified on the schematic by this symbol:



Top/bottom interference: In a few cases, top-mounted parts may interfere with the trimming and soldering of a bottom-mounted part. In this case, pre-trim the leads of the bottom-mounted part before final placement, and solder it on the *bottom* rather than on the top. (Since all holes are plated-through, you can solder on either side.)

Integrated Circuits and ESD

The K2 transceiver uses integrated circuits and transistors that can be damaged by electrostatic discharge (ESD). Problems caused by ESD can often be difficult to troubleshoot because components may only be degraded, at first, rather than fail completely.

To avoid such problems, simply touch an unpainted, grounded metal surface before handling any components, and occasionally as you build. We also recommend that you take the following anti-static precautions (in order of importance):

- Leave ESD-sensitive parts in their anti-static packaging until you install them
- Ground yourself using a wrist strap with a series 1 megohm resistor (do NOT ground yourself directly, as this poses a shock hazard)
- Make sure your soldering iron has a grounded tip
- Use an anti-static mat on your work bench

IC Sockets

Sockets are used for only the largest ICs. You should **not** use sockets for the other ICs because they tend to be unreliable and can cause problems due to added lead length. Since sockets are not used in most cases, you must double-check the part number and orientation of each IC before soldering.

Soldering, Desoldering, and Plated-Through Holes

CAUTION: Solder contains lead, and its residue can be toxic. Always wash your hands after handling solder.

The printed circuit boards used in the K2 have circuitry on both sides ("double-sided"). Boards of this type require *plated-through holes* to complete electrical connections between the two sides.

When you solder components on these boards, the solder fills the plated holes, making excellent contact. This means that you do not need to leave a large "fillet" or build-up of solder on top of the pads themselves. *A small amount of solder will do for all connections.*

Unfortunately, removing components from double-sided PC boards can be difficult, since you must get all of the solder back out of the hole before a lead can be removed. To do this, you'll need solder wick and a vacuum desoldering tool (see techniques below).

The best strategy for avoiding de-soldering is to place all components properly the first time. Double-check values and orientations, and avoid damaging parts via ESD.

When removing components:

- Don't pull a lead or pin out of a hole unless the solder has been removed, or you are applying heat. Otherwise, you can literally pull out the plating on the plated-through hole.
- Limit soldering iron contact to a few seconds at a time.
- Use small-size solder-wick, about 0.1" or 2.5 mm wide. Use the wick on both the top *and* bottom pads when possible. This helps get all of the solder out of the hole.
- Buy and learn how to use a *large* hand-operated vacuum desoldering tool, such as the "Soldapullt," model DS017LS. Small solder suckers are not effective.
- With ICs and connectors, clip all of the pins at the body first, then remove all of the pins slowly, *one at a time*. You may damage pads and traces by trying to remove a component intact, possibly leaving a PC board very difficult to repair.
- Invest in a PC board vice with a heavy base if possible. This makes parts removal easier because it frees up both hands.
- If in doubt about a particular repair, ask for advice from Elecraft or from someone else with PCB repair experience. Our e-mail reflector is also an excellent source for help.

4. Control Board

The Control board is the "brain" of the K2. It monitors all signals during receive and transmit, and handles display and control functions via the Front Panel board. The microcontroller, analog and digital control circuits, automatic gain control (AGC), and audio amplifier are located on this board.

Components



Review the precautions described in the previous section before handling any IC's or transistors. These components can be damaged by static discharge, and the resulting problems are often difficult to troubleshoot.

Open the bag of components labeled **CONTROL** and sort the parts into groups (resistors, diodes, capacitors, etc.). If any of the components are unfamiliar, identify them using the illustrations in the parts list, Appendix A.

Locate the Control board. It is the smallest of the three K2 PC boards, labeled "K2 CONTROL" on the front side, in the lower right-hand corner. The lower left-hand corner is notched.

Open the bag labeled **MISCELLANEOUS** and empty the contents into a shallow box or pan. This will prevent loss of any of the small hardware while allowing you to locate items as needed.



The Allen wrenches are located in a small bag with the **MISCELLANEOUS** items. These wrenches may have been oiled during manufacturing. Remove the wrenches and wipe off the oil, if any, then discard the bag.



There are five sizes of 4-40 machine screws provided with the kit. The relative sizes of the screws are shown below for identification purposes (not to scale). All of the screws are black anodized except for the 7/16" (11 mm) screws. The 3/16" (4.8 mm) pan-head screws are the most numerous, and will be referred to as **chassis screws** throughout the manual. There is only one flat-head, 3/16" screw.



Flat-head, 3/16" (4.8 mm)

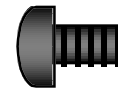

Pan-head, 3/16" (4.8 mm)
(**chassis screws**)

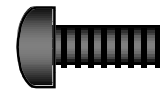

Pan-head, 3/8" (9.5 mm)



Pan-head, 7/16" (11 mm)

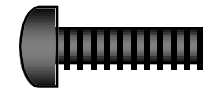

Pan-head, 1/2" (12.7 mm)

Identify all of the 4-40 screws and sort them into groups.

Assembly

The side of the Control board with most of the components is the *top* side. With the top side of the Control board facing you and the notch at the lower left, locate the position of resistor R5, near the left edge. The label "R5" appears just below the resistor's outline.

Install a 33-k resistor (orange-orange-orange) at R5, with the orange bands at the top and the gold band (indicating 5% tolerance) at the bottom. Make sure it is seated flush with the board, then bend the leads on the bottom to hold it in place. Do not solder this resistor until the remaining fixed resistors have been installed in the next step.

Install the remaining fixed resistors, which are listed below in left-to-right PC board order. The resistors should all be oriented with their first significant-digit band toward the left or top. This will make the color codes easier to read if you need to re-check the values after installation. Check 1% resistors with an ohmmeter.

Note: When multiple items appear on one line in a component list such as the one below, complete all items on one line before moving on to the next, as indicated by the small arrow. (In other words, install R5 first, then R2, then go to the second line.)

__ R5, 33 k (ORG-ORG-ORG) ⇒ __ R2, 3.3 M (ORG-ORG-GRN)
 __ R3, 10 k (BRN-BLK-ORG) __ R4, 5.6 k (GRN-BLU-RED)
 __ R6, 100 (BRN-BLK-BRN)

__ R7, 1.78 k, 1% (BRN-VIO-GRY-BRN)
 __ R8, 100, 1% (BRN-BLK-BLK-BLK)
 __ R9, 806 k, 1% (GRY-BLK-BLU-ORG)
 __ R10, 196 k, 1% (BRN-WHT-BLU-ORG)

__ R16, 10 (BRN-BLK-BLK) ⇒ __ R17, 3.3 M (ORG-ORG-GRN)
 __ R21, 10 k (BRN-BLK-ORG) __ R20, 2.7 ohms (RED-VIO-GLD)

Solder all of the resistors, then trim the leads as close as possible to the solder joints. **Some builders prefer to trim the leads *before* soldering. Either method can be used.**

Locate RP6, a 5.1 k, 10-pin resistor network. ("RP" means "resistor pack," another name for resistor networks.) RP6 is usually labeled "770103512." Check the parts list for alternative resistor network labels if necessary. Pin 1 of RP6 is indicated by a dot.

Locate the component outline for RP6 at the left end of the PC board. Install the resistor network so that the end with the dot is lined up with the "1" label.

Make sure the resistor network is seated firmly on the board, then bend the leads at the far ends in opposite directions to hold it in place. (Do not trim the leads.) Do not solder RP6 yet.



Components with many leads are difficult to remove once soldered. Double-check the part numbers and orientation.

Install the remaining resistor networks in the order listed below. Do not solder them until the next step.

__ RP1, 3.9 k, 10 pins (770103392) __ RP7, 33 k, 8 pins (8A3.333G)
 __ RP2, 82 k, 8 pins (77083823) __ RP3, 47 k, 10 pins (10A3.473G)
 __ RP5, 470, 10 pins (10A3.471G) __ RP4, 82 k, 8 pins (77083823)

Solder all of the resistor networks.

Install potentiometer R1 (50 k), located at the left side of the board. R1 will sit above the board due to the shoulders on its pins. Hold it in place (flat, not tilted) while soldering.

Install the 82 mH shielded inductor (L1) as shown by its component outline. Make sure the L1 is pressed down onto the PC board as far as it can go, then bend the leads slightly to hold it in place while soldering.

Install the diodes listed below, beginning with D1, which is in the upper left-hand corner of the PC board. (Refer to the parts list if necessary to identify the different types of diodes.) If a diode has only one band, the end with the band (the cathode) should be oriented toward the banded end of the corresponding PC board outline. If a diode has multiple bands, the *widest* band indicates the cathode end.

__ D1, 1N4148 __ D2, 1N4148 __ D3, 1N5817

Double-check the orientation of the diodes, then solder.

Install the small fixed capacitors listed below, beginning with C2 in the upper left-hand corner of the board. (This list includes all of the fixed capacitors on the Control board except the tall, cylindrical electrolytic types, which will be installed later.) The list shows both the value and the capacitor labels, using notation explained in the previous section. After installing each capacitor, bend the leads outward to hold it in place, but do not solder.

Note: Remember to complete all items in each line before moving on to the next. (Install C2, C3, and C4, then C7, etc.)

__ C2, .001 (102) ⇒ __ C3, .01 (103) ⇒ __ C4, 0.47 (474)
 __ C7, 330 (331) __ C6, .047 (473) __ C8, 39 (39)
 __ C9, .01 (103) __ C10, .01 (103) __ C12, .0027 (272)
 __ C5, .01 (103) __ C14, .047 (473) __ C17, .01 (103)
 __ C42, 0.1 (104) __ C16, .047 (473) __ C11, .01 (103)
 __ C19, .047 (473) __ C21, 33 (33)

__ C23, .01 (103) __ C20, .001 (102) __ C18, .01 (103)
 __ C43, .001 (102) __ C27, .022 (223) __ C25, 0.1 (104)
 __ C26, 0.1 (104) __ C24, .0027 (272) __ C31, .047 (473)
 __ C34, .001 (102) __ C30, .047 (473) __ C40, .01 (103)
 __ C35, .01 (103) __ C36, .0027 (272) __ C39, .01 (103)
 __ C41, .01 (103) __ C37, .01 (103) __ C38, 680 (681)

Solder all of the small fixed capacitors.

Install and solder the electrolytic capacitors listed below, which are polarized. Be sure that the (+) lead is installed in the hole marked with a "+" symbol. The (+) lead is usually longer than the (-) lead, and the (-) lead is identified by a black stripe (Figure 4-1).

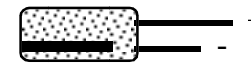

Figure 4-1

__ C1, 2.2 μ F ⇒ __ C13, 22 μ F ⇒ __ C15, 100 μ F
 __ C28, 220 μ F __ C29, 220 μ F __ C33, 2.2 μ F
 __ C32, 22 μ F

Install and solder ceramic trimmer capacitor C22. Orient the flat side of this trimmer as shown on its PC board outline.

Using a small flat-blade screwdriver, set C22 so that its screwdriver slot is parallel to the outline of nearby crystal X2.

Locate Q12 (type PN2222A), which is a small, black TO-92 package transistor. Q12 and other TO-92 transistors may have either of the two shapes shown in Figure 4-2. **The large flat side of the device must be aligned with the flat side of the component outline.** The part number may be found on either side.

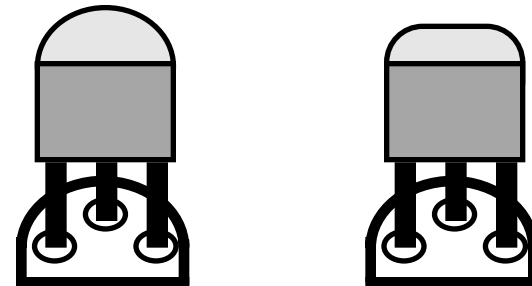

Figure 4-2

Install Q12 near the upper left-hand corner of the PC board. Align the large flat side of Q12 with its PC board outline as in Figure 4-2. The body of the transistor should be about 1/8" (3 mm) above the board; don't force it down too far or you may break the leads. Bend the leads of the transistor outward slightly on the bottom to hold it in place. Solder Q12.

Install the remaining TO-92 package transistors in the order listed below.

___ Q11, PN2222A	⇒	___ Q1, 2N3906	⇒	___ Q2, 2N3906
___ Q3, 2N7000		___ Q4, 2N7000		___ Q5, 2N7000
___ Q6, J310		___ Q7, J310		___ Q8, PN2222A
___ Q9, MPS5179		___ Q10, MPS5179		

Solder and trim the leads of these transistors.

Install crystals X1 and X2 so that they are flat against the board. X1 is 5.068 MHz and is located near the notch in the lower left-hand corner. X2 is 4.000 MHz, and is located near the center of the board.

Solder the crystals.

Prepare two 3/4" (19 mm) jumper wires from discarded component leads. These short jumpers will be used to ground the crystal cans in the next step.

 Grounding the crystal cans in the following step is required to ensure proper crystal oscillator performance.

Referring to Figure 4-3, insert the jumper wires into the grounding holes provided near X1 and X2. Fold each wire over the top of the crystal and solder it to the top of the can. (Only a small amount of solder is required.) Then solder and trim the wire on the bottom of the board.

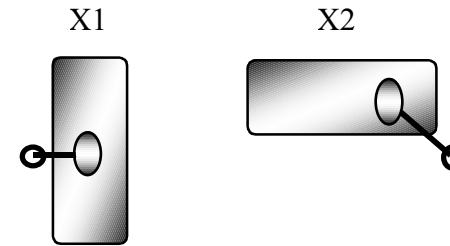



Figure 4-3

 The voltage regulators, U4 and U5, will be installed in the following steps. These regulators have different voltages and must not be interchanged. Check the labels before soldering.

Install U4 (LM2930T-8) and U5 (78M05, 7805T, L7805, etc.), forming the leads as indicated (Figure 4-4). Fold the pins over the shaft of a small screwdriver to create smooth bends. After inserting the leads into the proper holes, secure each IC with a 4-40 x 3/8" (9.5 mm) machine screw, #4 lock washer, and 4-40 nut. (These regulators may have either plastic or metal mounting tabs.)

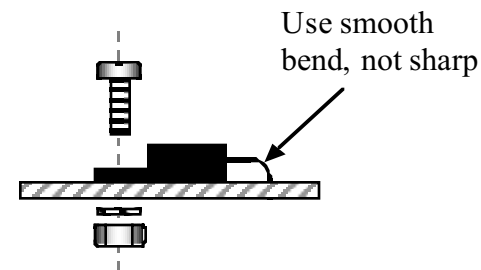



Figure 4-4

Solder the voltage regulator ICs.

Trim the IC leads as close to the PC board as possible.

Install a 40-pin IC socket at U6. (The microcontroller will be inserted into the socket in a later step.) Orient the notched end of the socket to the left as shown on the PC board outline. Bend two of the socket's diagonal corner leads slightly to hold the socket in place, then solder only these two pins. If the socket does not appear to be seated flat on the PC board, reheat the solder joints one at a time while pressing on the socket.

Solder the remaining pins of the 40-pin socket.

 The connectors used in the following steps have plastic bodies that can melt if too much heat is applied during soldering, causing the pins to be mis-positioned. Limit soldering time for each pin to 3 seconds maximum (1 to 2 seconds should be adequate).

Install the 2-pin male connectors, P5 and P6. As shown in Figure 4-5, the polarizing tab on each connector should be closest to the top edge of the board. P5, the voltmeter input connector, can be found near the upper left-hand corner of the board. P6 is used for frequency counter input, which is in the upper right-hand corner.

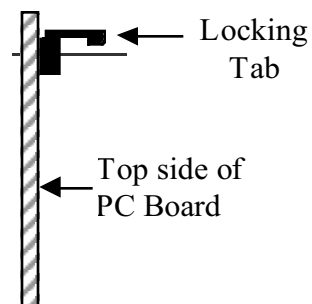

Figure 4-5

Install the 10-pin, dual-row connector, P4. It is located to the left of P5. It must be seated flat on the board before soldering.

Install P7, a 3-pin male connector, to the right of P5. The short ends of the 3 pins are inserted into the board.

Install a shorting jumper onto the two right-hand pins of P7.

At the upper left and right corners of the board are short jumpers, labeled with ground symbols (\perp). Use discarded component leads to make 3/4" (19 mm) U-shaped wires for each jumper (Figure 4-6). Solder the jumpers on the bottom of the board, with the top of the U-shape approx. 1/4" (6 mm) above the board.



Figure 4-6

Locate the outlines for resistors R18 and R19 on the *bottom* side of the Control board.

 The pads used for R18 and R19 are shared with connectors J1 and J2, which are labeled on the top side of the board. These connectors are provided with the KAF2 audio filter option. You should not install J1 and J2 or the KAF2 option until after K2 assembly and checkout have been completed.

Install short wire jumpers at R18 and R19. Make the jumpers from discarded component leads as you did above, but keep them flat against the board. Solder the jumpers on the top side.

Install the following resistors on the bottom side of the board:

__ R12, 820 (GRY-RED-BRN)

__ R11, 47 k (YEL-VIO-ORG)



The connectors along the bottom edge of the board (P1, P2 and P3) will be installed next. ***It is very difficult to remove them once they are soldered. Follow all instructions carefully.***

Hold the Control board vertically as shown in the side view below (Figure 4-7). The top side of the board--the side with most of the components--should be to the ***right***.

Turn to page 8 and review Figure 3-3, which shows how the Control board plugs into the RF board. **P1, P2, and P3 will all be installed on the top side of the Control board as shown.**

Position 6-pin right-angle connector P1 as shown in the side view below (Figure 4-7). **Do not solder P1 until the next step.** The plastic part of the connector must be seated flat against the PC board, and the pins must be parallel to the board. Do not bend or trim the pins on the bottom of the board.

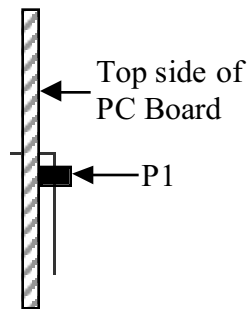

Figure 4-7

Solder just the two end pins of P1, then examine the placement of the connector. If P1 is not flat against the board, re-heat the solder on the end pins one at a time while pressing firmly on the connector. Once it is in the right position, solder all pins. Do not trim the leads.

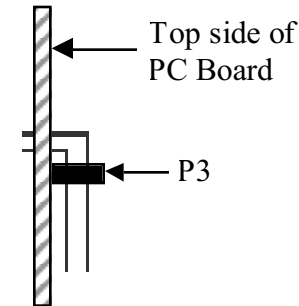

Figure 4-8

Install P3, the 20-pin, dual-row right-angle connector (Figure 4-8). Use the same method you used for P1. Do not solder P3 until you are sure that it is seated properly.

Install P2, the 36-pin, dual-row, right-angle connector. Use the same method you used for P1 and P3.



When you install ICs in the following steps, always straighten the leads of each IC first as shown in Figure 4-9. The two rows of pins must be straight and parallel to each other to establish the proper pin spacing for insertion into the PC board or socket.

To straighten the pins, rest one entire row of pins against a hard, flat surface. Press down gently on the other row of pins and rock the IC forward to bend the pins into position as shown below.

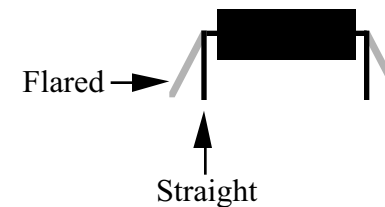



Figure 4-9

 **Before handling any IC, touch an unpainted, grounded metal surface or put on a conductive wrist-strap.**

Locate U2, an 8-pin IC, part number LM833. (LM833 is the basic part number. There may be an additional prefix or suffix or other markings.) This and all remaining ICs on the Control board are Dual-Inline Packages, or DIPs. Referring to Figure 4-10, identify the notched or dimpled end of the IC. IC pins are counted starting from pin 1 (as shown below) and going counter-clockwise.

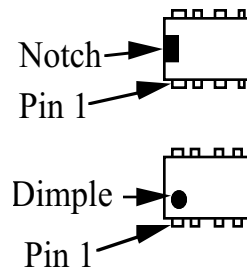



Figure 4-10

- Straighten the leads of U2 (see Figure 4-9).
- Install U2 in the orientation shown by its PC board outline, near the upper left-hand corner of the PC board, but do not solder it yet. Make sure the notched or dimpled end is lined up with the notched end of the PC board outline. Even though the outline is covered when the IC is installed, you can still verify that the IC is installed correctly by looking at pin 1. The PC board pad corresponding to pin 1 will be either oval or round.

 You may overheat the IC pins or PC pads if you take an excessive length of time to solder. After a few tries, you should be able to solder an IC pin in about 1 or 2 seconds.

Bend two of U2's corner pins out slightly on the bottom of the board to hold the IC firmly in place, flat against the top of the board. Find pin 1 and verify that its pad is either round or oval. Once U2 is properly seated, solder all eight pins, using a minimum of solder.

Install the ICs listed below. Bend the pins to hold each IC in place as you did with U2, but do not solder until the next step. The notched or dimpled end of each IC must be aligned with the notched end of its PC board outline.

Note: For U1, the IC type supplied may be either NE602 or SA602.

<input type="checkbox"/> U1, NE602	<input type="checkbox"/> U3, LM6482	<input type="checkbox"/> U7, 25LC320
<input type="checkbox"/> U8, MAX534	<input type="checkbox"/> U9, LM380	<input type="checkbox"/> U10, LMC660

- Check the orientation of pin 1 on each IC by looking at the associated PC board pads, as before. Then solder all of the ICs.
- Locate the microcontroller, U6.
- Straighten the pins of U6 (see Figure 4-9). With a large IC such as this, you can hold the IC body at both ends as you re-form each row of pins.

 When the microcontroller is pressed in its socket, you must be careful to avoid jamming its pins. Make sure that all pins are lined up with the associated holes in the socket before pressing down on the IC. Watch the pins on both rows as you press down, re-aligning them with the socket holes individually if necessary.

Insert the microcontroller, U6, into its socket. Make sure that pin 1 on the IC itself is lined up with the pin 1 label near the lower left-hand corner of the PCB outline. **Note:** The revision label on the IC (usually white) may not be oriented the same direction as the text printed on the IC. Do not use the label as a guide--use the notch or dimple to identify pin 1.

Option Components

All component locations on the Control board should now be filled except for the following:

- C44 (top side of the board near the microcontroller, U6). This capacitor will not be used.
- J1 and J2 (bottom side). These two connectors are provided for an audio filter option (KAF2). This option should be installed only after the basic K2 kit has been completed and tested.

Visual Inspection

Nearly all problems with kits are due to incorrectly installed components or poor solder joints. You can avoid these problems by doing a simple visual inspection. A few minutes spent here may save you hours of troubleshooting time.

Make sure there are no components installed backwards. Check all diodes, resistor networks, electrolytic capacitors, and ICs. (The parts placement drawings in Appendix F will be helpful when checking diode orientation.)

Examine the bottom of the PC board carefully for the following (use a magnifying glass if available):

- cold solder joints
- solder bridges
- unsoldered pins

Resistance Checks

In the table below, "<" means "less than," and ">" means "greater than." When measuring resistances that show a minimum value in the table (such as > 100 k), your resistance reading may be much higher or even infinite. This is typical when using a DMM (digital multimeter). If you use an analog meter you may find that some or all resistance measurements are too low.

Perform the resistance checks listed below to ensure that there are no shorts in the most critical control circuits. (The Control board will be fully tested in a later section.)

Test Point	Signal Name	Res. (to GND)
P2 pin 1	12V	> 10 k
U5, OUT ("5V" pin)	5A	> 2 k
U4, OUT ("8V" pin)	8A	3 - 7 k
Q1 collector	8T	> 1 M
Q2 collector	8R	> 1 M
U3 pin 8	12V IN	> 10 k
U6 pin 13	OSC1	> 100 k
U6 pin 14	OSC2	> 100 k
U6 pin 29	DASH	70 - 90 k
U6 pin 30	DOT/PTT	70 - 90 k
U8 pin 2	VPWR	> 100 k
U8 pin 15	VBIAS-XFIL	> 100 k
U8 pin 16	VBFO	> 100 k

5. Front Panel Board

The Front Panel board includes all of the control and display devices that you'll use when operating the K2, including the liquid-crystal display (LCD), LED bargraph, push-button switches, and potentiometers. See Appendix D for photos of the completed front panel assembly.

Components

- Open the bag labeled **FRONT PANEL** and sort the parts into groups (resistors, diodes, capacitors, etc.). Observe anti-static precautions when handling ICs and transistors.
- Locate the front panel PC board, which is just a bit larger than the Control board. It is labeled "K2 FP" on the top side, in the lower right-hand corner.

Assembly



Your K2's appearance and operation will be adversely affected if the controls or display are not mounted correctly, and in the indicated sequence. There are also special instructions for installing components on the bottom of the board.

- Locate the Spacer Set PC board (Figure 5-1). Using long-nose pliers, carefully break out the pushbutton switch spacing tool and the four backlight LED spacers. Break the material only at the four indicated points. **Note:** The switch spacing tool doubles as the PC board for the RF probe, which will be assembled later.

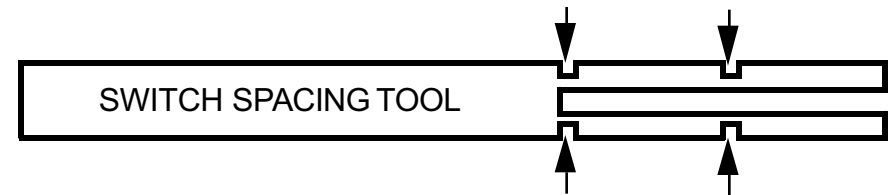

Figure 5-1

- Position pushbutton switches S1 and S2 as shown in Figure 5-2, using the switch spacing tool to set the switch height. Make sure all four legs of each switch are centered in their holes, then gently push each switch until it is resting flush against the switch-spacing tool. (Caution: switch pins are fragile.) *Do not solder yet.*

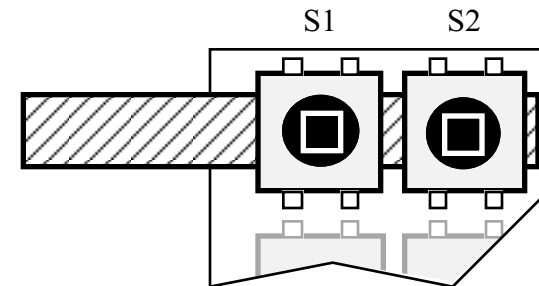

Figure 5-2

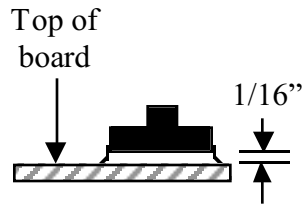

Figure 5-3

Figure 5-3 shows a side view of a switch that is properly mounted (spacing tool not shown). The leads of the switches will just be visible on the bottom of the board. *Proper switch height is important for maintaining an even appearance.*

Once you're satisfied that S1 and S2 are seated correctly, solder the leads (on the bottom side of the board). Leave the spacing tool in place until you've finished soldering both switches.

Install the remaining switches, S3-S16, using the same technique. When you get to S8 through S16, you may install three switches at a time using the spacing tool.

Install the following 1/4-watt fixed resistors, which are listed in left-to-right PC board order. Solder the resistors after all have been installed. (R13 and a few other parts are part of the SSB adapter option, and are not included in the basic K2 kit. A checklist of these components is provided at the end of this section.)

__ R12, 120 (BRN-RED-BRN) ⇒	__ R10, 33 (ORG-ORG-BLK)
__ R9, 220 (RED-RED-BRN)	__ R11, 470 (YEL-VIO-BRN)
__ R6, 4.7 k (YEL-VIO-RED)	__ R7, 4.7 k (YEL-VIO-RED)
__ R14, 100 k (BRN-BLK-YEL)	

Install the following resistors on the bottom of the board. Solder them on the bottom side. Keep your iron tip away from the bodies of the resistors.

__ R16, 15 k (BRN-GRN-ORG)	__ R15, 10 k (BRN-BLK-ORG)
----------------------------	----------------------------

 **When you install the resistor networks in the next step, you must align the dotted end of the network with the pin 1 label on the PC board outline.**

Install the resistor networks listed below (top side of the board). Double-check pin 1 orientation and values before soldering.

__ RP2, 120, 10 pins (770101121) (dotted end should be near "RP2" label)
__ RP1, 100 k, 10 pins (10A1.104G) (dotted end near "RP1" label)

Install and solder the diodes listed below, observing proper orientation as described in the previous section.

__ D4, 1N5817	__ D5, 1N5817	__ D6, 1N5817
---------------	---------------	---------------

Install and solder the following capacitors. C9 is located on the bottom of the board and must be soldered on the top side.

__ C1, .047 (473)	__ C2, .01 (103)	__ C3, .047 (473)
-------------------	------------------	-------------------

__ C9, .01 (103), on bottom

Install PN2222A transistors at Q1 and Q2, near the middle of the board, and solder. These transistors must be mounted so the lead length above the PC board is less than 1/8" (3 mm) to prevent them from hitting the front panel.

There are two ground jumpers on the Front Panel board, one at the far left and the other at the lower right, labeled with a \perp symbol. Use discarded component leads to make 3/4" (19 mm) U-shaped wires for each jumper. Solder them on the bottom side.

Install a 40-pin IC socket at U1, on the **bottom** of the board. (The IC will be inserted into this socket later.) Orient the notched end of the socket to the left as shown on the PC board outline.

 The ICs to be installed in the next step are very sensitive to static discharge. Touch a grounded surface before handling each IC. Also note that U4's label will read upside-down (pin 1 at the right) when properly installed.

Install the following ICs. Before soldering, verify that the ICs are oriented correctly (pin 1 associated with a round or oval pad).

__ U4, A6B595KA or TPIC6B595

__ U3, A6B595KA or TPIC6B595

__ U2, 74HC165

 The bargraph LED will be installed in the following two steps. This component must be seated flat on the PC board or it will interfere with final front panel assembly. Also, any misalignment will be visible from the front of the K2.

Locate the bargraph LED, DS2. The bargraph has a beveled corner or edge that indicates pin 1. Install DS2 as shown by its PC board outline, just to the left of the LCD. Bend two opposite corner pins slightly to hold it to the board, then solder only these two pins.

If the bargraph is not perfectly flat against the PC board, re-heat the solder on the corner pins alternately while pressing it down. Once it is in the correct position, solder the remaining pins.

Remove any hardware supplied with the microphone jack, J2. The nut and washer will not be used.

Install the microphone jack (J2) in the lower left-hand corner of the board, with its polarizing nub at the top (Figure 5-4). Press the jack down until it is completely flat against the PC board. Re-check the orientation of the polarizing nub before soldering.

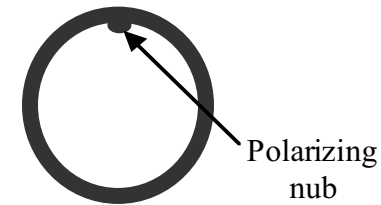

Figure 5-4

Install two 3/16" (4.8 mm) diameter x 1/4" (6.4 mm) long round standoffs on the top of the board, adjacent to the microphone jack (Figure 5-5). Use *two* #4 lock washers between each standoff and the PC board as shown. Secure the standoffs from the bottom side with chassis screws. Recall that "chassis screw" is short-hand for 3/16" (4.8 mm) long pan-head machine screws.

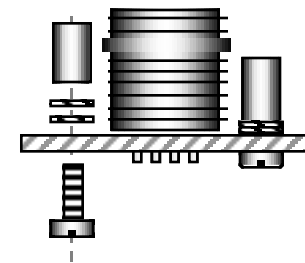

Figure 5-5

Install another 3/16" (4.8 mm) diameter x 1/4" (6.4 mm) long round standoff on the top of the PC board, on the left side of the large square hole in the middle of the board. The standoff mounting hole is below C2. Use the same hardware as indicated in Figure 5-5, including two #4 lock washers and one chassis screw.

Install two 1/4" (6.4 mm) diameter x 1/2" (12.7 mm) long hex standoffs on the bottom of the board (Figure 5-6). The holes for these standoffs are indicated by large pads on the top and bottom of the board. Use one lock washer and a chassis screw for each standoff. Insert the lock washer between the standoff and PC board.

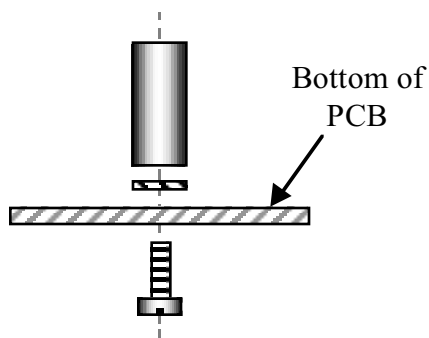



Figure 5-6

Identify the two different types of panel-mount potentiometers. Four of them are 5-kohm *linear-taper* types, labeled "B5K". The fifth is an *audio-taper* type, labeled "A5K". They may be physically identical or have slightly different shafts, body colors, etc.

 When you install the panel-mount potentiometers in the next two steps, do not push on the shafts, which may damage the part. Push only on the metal frame.

Install the audio-taper potentiometer, R3, in the lower left-hand corner. **(The PCB is labeled "AUDIO" at R3.)** Push only on the frame, not the shaft. Make sure that the potentiometer body is parallel to the PC board and is pressed against the board as far as it will go before soldering.

Install the four 5-k linear-taper potentiometers at R1, R2, R4, and R5. (The PC board is labeled "LINEAR" at each pot.) Verify correct positioning as you did in the previous step.

 Before installing J1 in the following step, review Figure 3-3 (page 8) to be sure you have J1 on the correct side of the board.

The front panel attaches to the RF board via J1, a 20-pin single-row female connector. **Install J1 on the bottom side of the board** (Figure 5-7). Solder just two pins, one at either end.

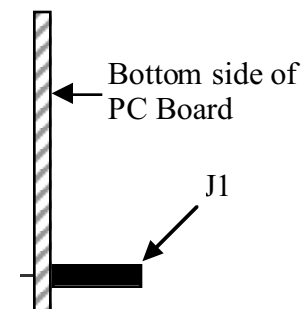

Figure 5-7

Re-heat the two end pins and press the connector down until J1 is seated flat against the board, then solder the remaining pins.

- Install rectangular gray key caps on S1 and S3 so the key caps are parallel to the long axis of the PC board (Figure 5-8). The caps are installed simply by pressing them onto the switch plungers.

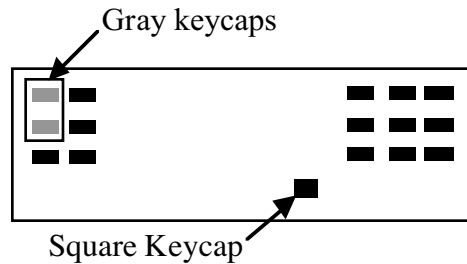



Figure 5-8

- Install a square black key cap on S7 as shown above.
- Install rectangular black key caps on the remaining switches.

 Before handling U1, touch an unpainted, grounded metal surface or put on a conductive wrist-strap.

- Straighten the pins of U1, the LCD driver (PCF8566), as you did with the microcontroller on the Control board.
- Insert U1 into its socket on the bottom of the board. (This must be done before continuing with LCD installation, since the LCD's presence will make pressing U1 into its socket much more difficult.) Be sure that U1 is completely seated with no bent pins.
- Locate the LCD backlight assembly, which is about 3" (7.5 cm) long. It includes the diffuser and two small LEDs, one at each end. *Do not remove the backing from either side of the diffuser.*
- Make sure the LEDs in the LCD backlight assembly are pressed into the diffuser and are not mis-aligned or loose.
- Place two 3/4" (19 mm) long spacers over the leads of each backlight LED as shown in Figure 5-9.

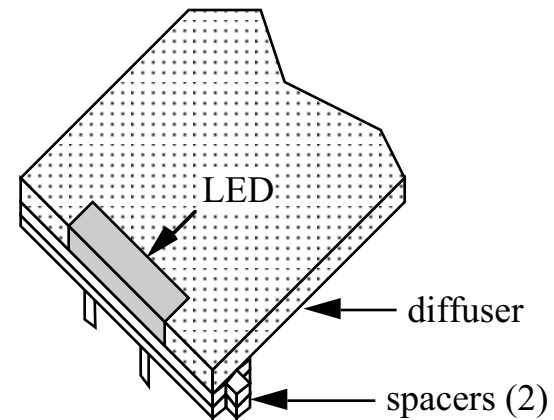

Figure 5-9

- Position the backlight assembly between the mounting holes labeled D2 and D3 as shown in Figure 5-10. *The diffuser must be parallel to and 1/8" (3 mm) above the PC board.* To hold the LED spacers and backlight assembly in place, use a rubber band or bend the LED leads out slightly on either end.

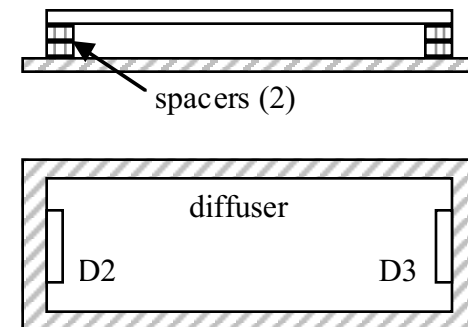

Figure 5-10

Examine the backlight assembly closely to ensure that it is parallel to the Front Panel board and seated as far down on the board as it will go (exactly 1/8" [3 mm] above the board).

Solder D2 and D3. If the backlight assembly is not flat against the PC board, re-heat the LED pins one at a time and press it into place.



Caution: The LCD and its pins are fragile—handle carefully. Do not remove the protective plastic film from the front surface of the LCD until later in this section when the front panel assembly is completed.

Remove the LCD from its packing materials, being careful not to bend the pins.

Look closely at the *back* surface of the LCD under a bright light. If you see a few very faint lines running across the back, it indicates that a piece of protective film is in place. Remove this piece of film very carefully. (**Note:** There is also protective film on the *front* surface, but do not remove it at this time.)

The LCD has six pins along its lower edge (three on each side), and 24 pins along the upper edge. Place the LCD in its proper position on the board but do not solder yet.

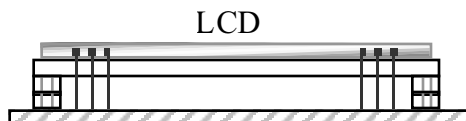

Figure 5-11

The LCD must be seated flat against the diffuser as shown in the edge view (Figure 5-11). If the LCD does not appear to be seated correctly, it may be because the backlight LEDs or spacers are mis-aligned. When the entire assembly is installed correctly, the LCD's pins will all protrude the same distance from the bottom of the board. (Some units may be supplied with shorter pins that do not protrude at all.)

Solder the four corner pins of the LCD, then re-check the alignment of the LCD assembly. If everything looks correct, solder the remaining pins. LCD pins can be soldered on the top of the board if they do not protrude from the bottom.

Attach two thin, 1/4" (6.4 mm) self-adhesive rubber pads to the bottom side of the Front Panel board in the positions indicated in Figure 5-12. The pads should be placed as close as possible to the corners, but should not hang over on either edge. These pads establish the correct spacing for the Front Panel board and provide some vibration resistance.

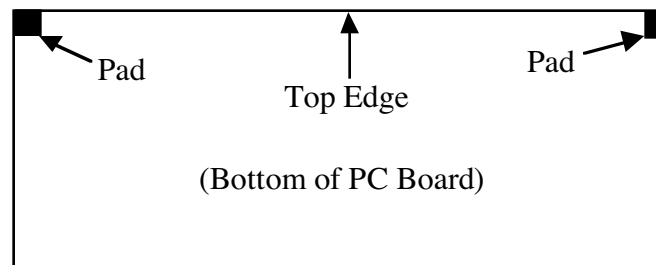

Figure 5-12

Uninstalled Components

Check off each of the components in the list below, verifying that they are not yet installed.

__ C4, .01 (103) __ C5, .01 (103) __ C6, .01 (103)
 __ C7, .01 (103) __ C8, .01 (103) __ R13, 68 k, 1%

__ RP3, 10 k resistor network
 __ Q3, 2N3906
 __ P1 (Mic. Configuration connector, on the bottom of the board)

The unfilled locations (above) are for parts that are provided with the SSB adapter (model KSB2). If you have the SSB adapter kit, you should install them now. Follow the *third* and *fourth* assembly steps under **Front Panel Board Components** in the KSB2 manual (page 16).

Visual Inspection

Make sure there are no components installed backwards. Check all diodes, resistor networks, electrolytic capacitors, and ICs. The parts placement drawings in Appendix F will be helpful in verifying the orientation of diodes.

Examine the bottom of the PC board for solder bridges, cold solder joints, or unsoldered components.

Resistance Checks

Set all potentiometers to their mid-points (approx.).

Perform the resistance checks (to ground) listed below. U1 is on the back of the board.

Test Point	Signal Name	Res. (to GND)
U1 pin 1	IDAT	25 - 35 k
U1 pin 2	ICLK	25 - 35 k
U1 pin 3	/SYNC	40 - 60 k
U1 pin 4	CLK	> 50 k
U1 pin 5	5A	15 - 40 k
U1 pin 6 - 11	Ground	0
U1 pin 12	2V	9 - 11 k
U1 pin 13 - 40	LCD segments	> 50 k
J1 pin 1	AF gain 1	> 1 M
J1 pin 2	AF gain 2	> 1 M
J1 pin 3	AF gain 3	> 1 M
J1 pin 4	DOT/PTT	> 1 M
J1 pin 5	MIC AF	> 1 M
J1 pin 6	ENC B	> 50 k
J1 pin 7	AUXBUS	> 1 M
J1 pin 8	Ground	0
J1 pin 9	SR DOUT	> 50 k
J1 pin 10	SR DIN	> 50 k
J1 pin 11	SR WRT	> 50 k
J1 pin 12	SR CK	> 50 k
J1 pin 13	ENC A	> 50 k
J1 pin 14	SR RD	> 50 k
J1 pin 15	VPOTS	10 - 60 k
J1 pin 16	ICLK	25 - 35 k
J1 pin 17	IDAT	25 - 35 k
J1 pin 18	5A	15 - 40 k
J1 pin 19	RF gain	1.5 - 3.5 k
J1 pin 20	Ground	0

Front Panel Final Assembly

- Locate the front panel chassis piece. Place it on a soft cloth to protect the finish and labeling.

 In the following step, the paint masking material will be removed from the inside of the front panel. The masking material is usually green, but may appear gray because of paint overspray. DO NOT remove the masking material from the other chassis pieces at this time.

- Some holes in the front panel were masked on the inside surface during painting. If masking tape (usually green in color) is still present, you'll need to remove it. The holes that are masked are in the four corners, along the top and bottom edges.

Masking tape should be removed as follows:

- Using a blunt instrument such as a ball-point pen, push on the tape through a hole until the tape begins to lift away from the surface.
 - Peel the tape completely off, using a sharp tool if necessary. Be careful not to nick or scratch the outer surface of the panel.
- After removing any masking tape, place the front panel chassis piece face-down, with the large, round microphone jack hole on the right.

- Locate the green plastic bargraph filter and two pieces of double-backed tape. These items will be found in a small bag.

 Caution: The adhesive on the double-backed tape is very strong. Once you position the tape on the green filter, you will not be able to remove it. Be very careful to align the tape with the long edges of the filter as explained below.

- Remove the white paper backing from one side of each piece of tape. Attach the tape to the *long* edges of the green filter (Figure 5-13). Be careful not to get any adhesive on the center portion of the filter, since it might be visible after installation.

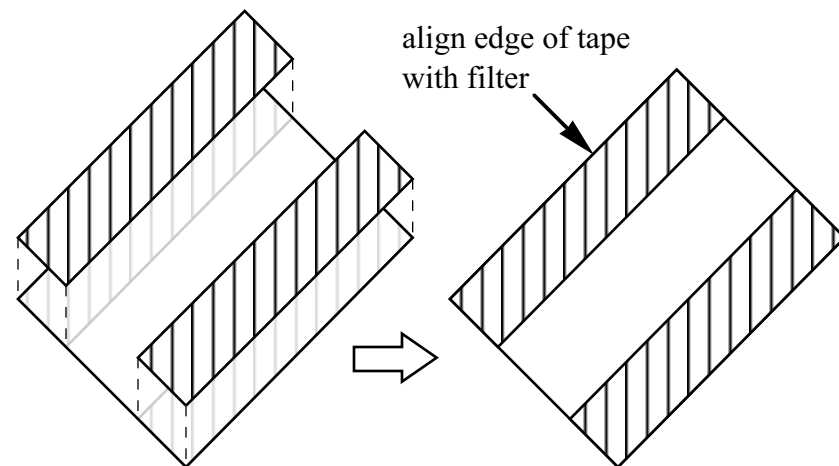

Figure 5-13

- Remove the brown paper backing from the other side of each piece of tape, then turn the filter/tape assembly adhesive-side down. Carefully center the green plastic filter over the *inside* of the bargraph LED hole (Figure 5-14).

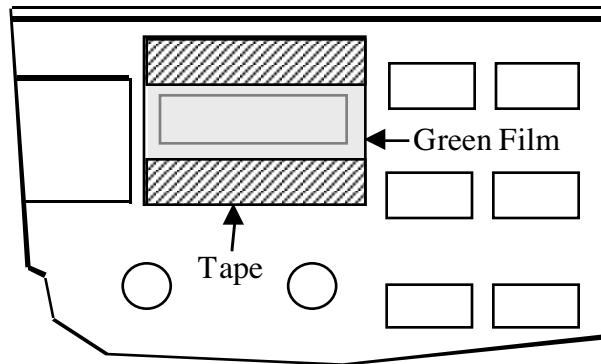

Figure 5-14

- Turn the front panel face up.
- Position the clear plastic LCD bezel over the LCD and bargraph holes as shown in Figure 5-15. The bezel goes on the *outside* of the panel.
- Secure the bezel with four 2-56 screws (stainless steel) as shown in Figure 5-15. **Tighten the 2-56 screws only the amount needed to hold the bezel to the front panel. Overtightening may crack the bezel or strip the threaded holes in the panel.**

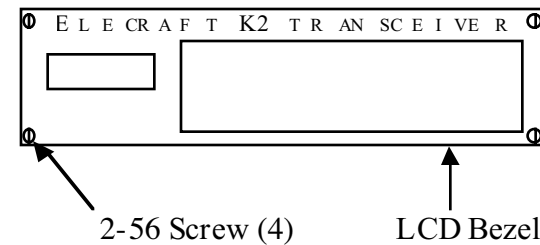

Figure 5-15

- Remove the insulation from four 1.5" (38 mm) lengths of green hookup wire.
- Install the bare wires on the bottom of the front panel PC board, using the four pads below the large rectangular hole (Figure 5-16).
- Solder and trim the wires on the top side of the board. The wires will be connected to the optical encoder, Z1, in a later step.

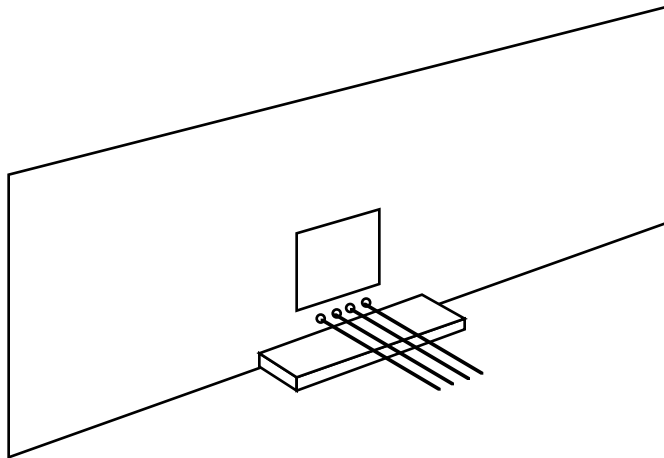

Figure 5-16

- Remove the protective plastic film from the face of the LCD. Be careful not to scratch the glass. **Caution: Do not peel off the LCD glass, just the thin protective film. The LCD will not be usable if you lift the glass itself.**

- Insert the front panel PC board assembly into the front panel. The pushbutton switch caps on both sides of the LCD should protrude slightly as shown in the side view, Figure 5-17a.

Note: the board/panel assembly will not be rigidly held in place until it is mated with the RF and Control boards in a later section.

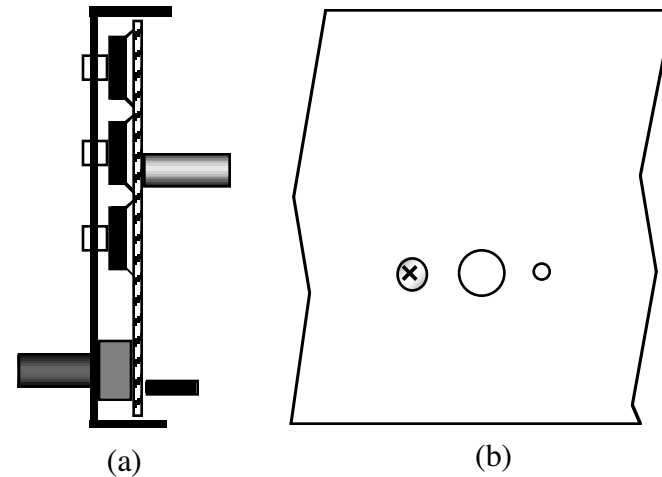

Figure 5-17

- A 1/4" (6.4 mm) standoff on the PC board should now be visible through the hole just to the left of the encoder mounting hole. Secure the panel to this standoff using the 4-40 x 3/16" (4.8 mm) *flat-head* screw as shown in Figure 5-17b.
- Remove the hardware from the shaft of the encoder, Z1, and discard the lock washer, which will not be used. Insert the encoder through the hole in the Front Panel board (Figure 5-18a).
- Cut 1/8" (3 mm) off the end of each of the encoder's four connector pins.

- Attach the encoder to the inside of the front panel using the nut and flat washer only. Figure 5-18 shows the side view (a) and front view (b) with encoder properly installed. The encoder has a small metal tab near the shaft that will only allow it to be installed one way. Do not over-tighten the nut. (Note: the green encoder bushing is metal, not plastic.)

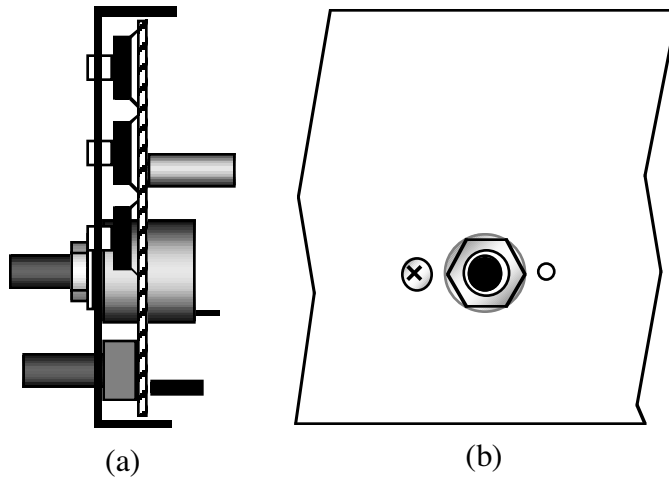

Figure 5-18

- Attach the four encoder wires you installed earlier to the matching pins on the back of the encoder. Each wire should be wrapped securely around the base of its matching pin, with no slack in the wire. Trim and solder the wires, making sure they aren't shorting to each other or to the encoder body, which is conductive.
- Set all potentiometers to midway in their rotation.



In the next step, a small knob may fit too tightly onto its potentiometer shaft. If so, rotate the shaft until it bumps up against one of its stops, place the knob at the top of the shaft, and rotate it slowly in the same direction while gently pressing it down.

- Attach small knobs to the potentiometer shafts, starting with the KEYER and POWER controls. Each knob's two set screws can be tightened using the small Allen wrench (.050", 1.3 mm). The knobs should be mounted as close as possible to the panel without touching it. Align the pointers per panel labeling.
- Locate the 1" (25 mm) dia. by 1/16" (1.6 mm) thick felt washer, and place it over the encoder nut (Figure 5-19). The washer should be seated on the front panel, with the nut inside it.

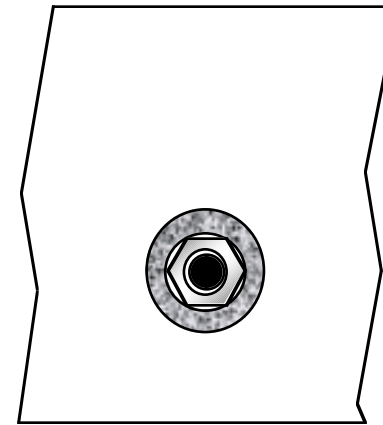

Figure 5-19

- Place the large knob on the encoder shaft. Push the knob on until it just touches the felt washer. If the knob does not spin freely, move it out slightly. If the knob is not contacting the felt washer at all, it may "drift" slightly once it stops spinning.
- Using the larger Allen wrench (5/64", 2 mm), tighten the two set screws alternately, in small increments.



At this point, the pushbutton switches may not all protrude an equal distance. The switch height will become equalized once the front panel assembly is mated to the RF board in a later step.

6. RF Board

Most of the K2's receiver and transmitter circuits are located on the RF board, including filters, oscillators, and RF amplifiers. The front panel and Control boards plug into the RF board, and the chassis pieces are designed to form a tight enclosure around it (see photos in Appendix D). In addition, many option boards plug directly into the RF board to minimize wiring.

Assembly and testing of the RF board is broken into three parts:

Part I: The DC and control circuits are installed so that the front panel and Control boards can be plugged in and tested. The I/O controller (U1 on the RF board) is also installed and tested at this time. Once this phase of assembly is completed, you'll have the K2's built-in test equipment available for testing and aligning the remaining circuits.

Part II: Synthesizer and receiver components are installed and tested. By the end of Part II you'll have the K2 receiving on 40 meters.

Part III. Transmitter components and all remaining filter components are installed. The K2 is then aligned on all bands.

Components



Review anti-static precautions before handling transistors or ICs.

Open the bags labeled **RF** and sort the components into related groups. In later steps you'll sort some of the components according to value to reduce the likelihood of assembly errors.

Locate the RF board and place it in front of you with the component side up (the side with most of the parts), and the front edge facing you (the edge with the irregular cutouts). Throughout this section we'll refer to the different areas of the board in terms of their proximity to you. For example, "front-left" means the corner closest to you on the left.

☐ Take a moment to familiarize yourself with the RF board using Figure 6-1 to identify the major sections. If you flip the board over you'll see that there are a few components on the bottom of the board, primarily in the transmitter section.

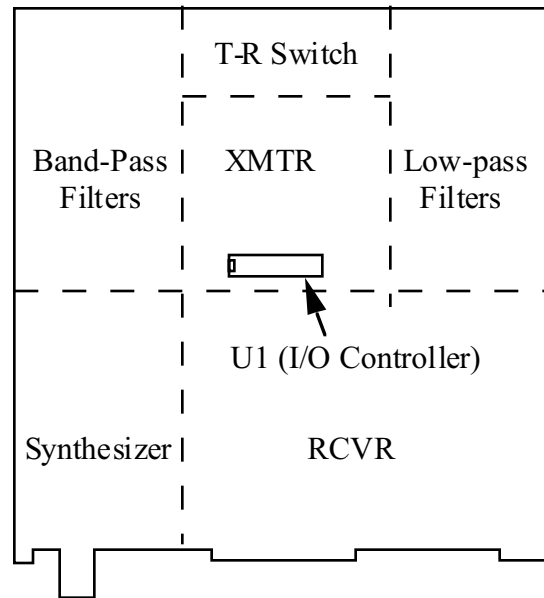

Figure 6-1

Assembly, Part I

☐ Locate a 2-D fastener and hold it vertically as shown in Figure 6-2. Looking at a side with two holes, note that the holes are offset from the center. When you install the fasteners in the following step, be sure to position them so that the holes in the fastener are shifted in the same direction as the holes in the PC board outlines on the bottom of the board.

☐ Turn the board over and install 2-D fasteners at five locations on the bottom of the RF board as shown in Figure 6-3. Secure each fastener from the *top* side of the board using two chassis screws (black, 3/16" [4.7 mm]) and two #4 lock washers.

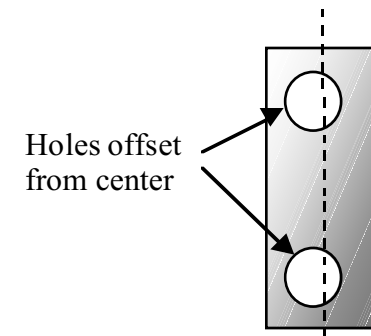

Figure 6-2

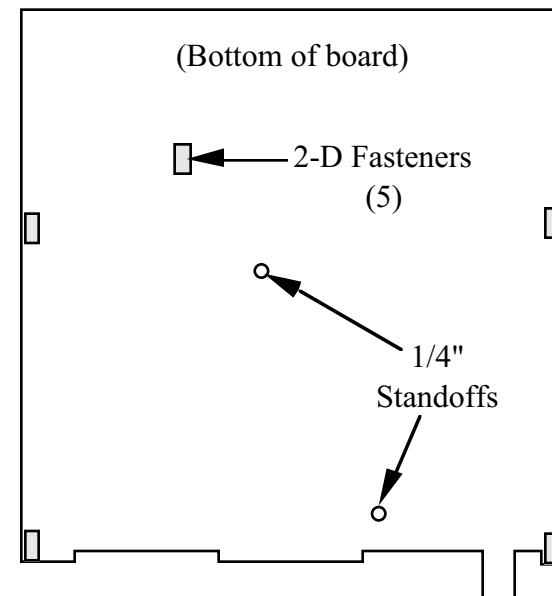

Figure 6-3

Make sure that the 2-D fasteners on the edges line up with the edge of the PC board and do not hang over. If they hang over or do not match their component outlines, they are installed backwards.

Install two 3/16" (4.8 mm) diameter by 1/4" (6.4 mm) long round standoffs on the bottom of the board at the locations identified in Figure 6-3. Secure these standoffs from the top side with chassis screws and #4 lock washers. *Do not put lock washers between the bottom of the board and the standoffs.*

Turn the board back over to the top side. Install the 28-pin IC socket at U1, near the middle of the board (Figure 6-1). The notched end of the socket should be at the left. Make sure the socket is flat against the PC board before soldering. (U1 itself will be installed in a later step.)



In the following steps you will install the latching relays (K1-K17). *Relay pins must not be bent or trimmed*, even after placement on the PC board, as this may cause unreliable mechanical operation. Since the pins cannot be bent to hold the relays on the board, an alternative assembly technique using a flat surface must be used. For this technique to work, the relays must be installed before any of the taller components.

Place relays K1-K17 on the top side of the RF board. One end of each relay has a heavy line printed across the top to indicate the pin 1 end. This end must be matched with the same end of the relay's PC board outline. Do not solder the relays yet.

When all of the relays have been placed on the board, lay a flat object such as a book or piece of cardboard on top of the relays to keep them in place, then flip the board over.

Solder only two pins (at opposite corners) on each relay. *Do not bend or trim relay leads.*

Turn the board back over and verify that all of the relays are in the correct orientation and are seated flat on the board.

Solder all of the remaining relay pins.

Install R1 and R2 (220 ohms, RED-RED-BRN), near the back left corner of the board.



To avoid stray signal coupling, all capacitors on the RF board must be mounted as close to the PC board as possible (without damaging the leads or their epoxy coating).

Install C1 and C2 (.001 μ F, "102"), which are on the left edge.

Install electrolytic capacitors C105 and C106 (2.2 μ F), located near the front-left corner.

Install R35 and R36 (82, GRY-RED-BLK) just to the right of C105.

Install R115 (.05 ohms, 3 watts) at the front right corner of the board. Form the leads as indicated by the component outline.

Install the following components to the left of R115.

__ C111, 2.2 μ F electrolytic ("+" lead goes into the square pad)
__ R113, 82 (GRY-RED-BLK)

Install the internal speaker connector, P5, which is a 2-pin connector like that shown in Figure 4-5. P5 is mounted near the on-off switch (S1). Position the connector as shown by its component outline, with the vertical locking ramp toward S1.

Install high-current diodes D10 and D12 (large black body), located near the right edge of the board:

__ D10, 95SQ015
__ D12, SB530 (a 1N5821 may be substituted for D12)

Install the following components near D10:

__ C77, .001 (102) __ C196, .047 (473)
__ R69, 100 k (BRN-BLK-YEL) __ R66, 2.7 k (RED-VIO-RED)

- Install the self-resetting fuse, F1, near D10. F1 is yellow and looks like a square-bodied capacitor. One side is labeled "G300".
- Install the key jack, J1, at the back-left corner of the board. Before soldering, make sure that the jack is aligned with its PC board outline.
- Install the headphone jack, J2, on the small board extension near the front left corner. The pins on J2 are not very long, so they will be nearly flush with the bottom of the board. Solder the pin closest to the front edge first (ground), then verify that the jack is seated flat on its plastic nubs before soldering the remaining pins.
- Install the power switch, S1, at the right front corner. (S1's key cap will be installed later.)
- Install the DC input jack, J3, at the back right corner. The 3 leads on the jack must be lined up with the slot-shaped holes in the component outline. If the holes are a tight fit, press firmly until the connector snaps into position.
- Install the antenna jack, J4 (BNC), just to the left of J3.
- Install the following components near U1 (at the middle of the board). You may need to confirm the part number of U2 (78L06), since it is easy to confuse it with U8 (78L05). Use a magnifying glass if necessary.

— U2 (78L06)	— C139, 0.1 (104)
— C140, .001 (102)	— R64, 100 (BRN-BLK-BRN)
- Install the ceramic resonator, Z5, near U1. (The ceramic resonator looks like a capacitor with three pins.)
- Install R65 (10 k, BRN-BLK-ORG) on the bottom of the board, near U1.

- Install D8 and D18 (1N4148), on the bottom of the board, toward the right edge. Make sure the banded end of each diode is aligned with the band on its component outline.



In the steps that follow you'll install the connectors that mate with the control and Front Panel boards. These connectors must be installed properly to ensure reliable mechanical connection. They are very difficult to remove once installed, so follow all instructions carefully. **Review Figure 3-3 (page 8) for correct placement.**

- Install the 6-pin, single-row female connector, J6, which is just left of the power switch. It must be seated vertically on the board and must not be tilted (Figure 6-4). Solder just one pin near the center of J6.

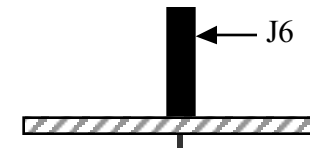

Figure 6-4

- If J6 does not appear to be completely flush with the board, re-heat the soldered pin and press down. Once it is installed correctly, solder the remaining pins.
- Install the 20-pin, dual-row female connector, J8, near the front left corner of the board. Use the same technique you used for J6. This connector must be seated flush with the board before soldering.
- Install 36-pin dual-row female connector J7 in the same manner as J6 and J8.

- Position 20-pin male right-angle connector P1 on the **bottom** of the board (Figure 6-5), but do not solder P1 yet. **Review Figure 3-3 (page 8) for correct placement.** The short ends of the bent pins are inserted into the holes, and the long ends must be parallel with the board.

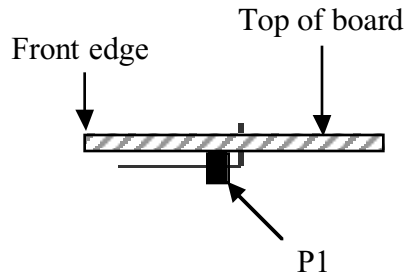



Figure 6-5

- Solder just the two end pins of P1.
- Look closely at P1 to make sure that its plastic support is pressed down as far as it will go, and that the pins are parallel to the board. If not, re-heat the soldered ends while pressing it into place. Once it is seated properly, solder the remaining pins.
- To the left and right of the I/O controller, U1, you'll find two short jumpers labeled " \perp " (on the top side of the board). Install 3/4" (19 mm) U-shaped ground jumpers at these locations as you did on the control and Front Panel boards. Use discarded component leads.
- On the bottom of the board you'll find two additional ground jumpers, one near the middle and the other near the back edge. Install U-shaped ground jumpers in these two locations.

 **Before handling U1, touch an unpainted, grounded metal surface or put on a conductive wrist-strap.**

- Install the I/O controller, U1 (PIC16C72 or 16F872), in its socket (near the middle of the board). Be sure to align the notched or dimpled end of U1 with the notched end of the socket (to the left). Make sure U1 is seated as far down in the socket as it will go and that none of its pins are bent. **Note:** The revision label may not be oriented in the same direction as the text printed on the IC. Use the notch or dimple to identify the pin 1 end.

Visual Inspection

- Examine the RF board carefully for unsoldered pins, solder bridges, or cold solder joints.
- Set switch S1 on the RF board to the "OFF" position. (Plunger OUT is OFF, plunger IN is ON.)

Resistance Checks

- Perform the following resistance checks.

Test Point	Signal Name	Res. (to GND)
R115, right end (near S1)	12V IN	> 500 ohms
U1 pin 1	6V	> 500 ohms
U1 pin 4	K13 control	> 20 k
U1 pin 9	OSC1	> 20 k
U1 pin 10	OSC2	> 20 k
U1 pin 28	AUXBUS	> 20 k
R1 (end near R2)	DOT/PTT	> 1 M
R2 (end near R1)	DASH	> 1 M

 When working with the side panels in the following steps, place a soft cloth on your work surface to protect the paint.

- Locate the two side panels. Remove any masking tape from the panels using the same technique described in the Front Panel section, taking care not to scratch the outer surfaces.
- Arrange the two panels as shown in Figure 6-6, and verify that they are mirror images of each other. The 2-D fasteners to be attached in the next step go on the *inside* surface, which has bare aluminum areas that were masked during painting. (**Note:** the actual size and shape of masked areas may vary.)

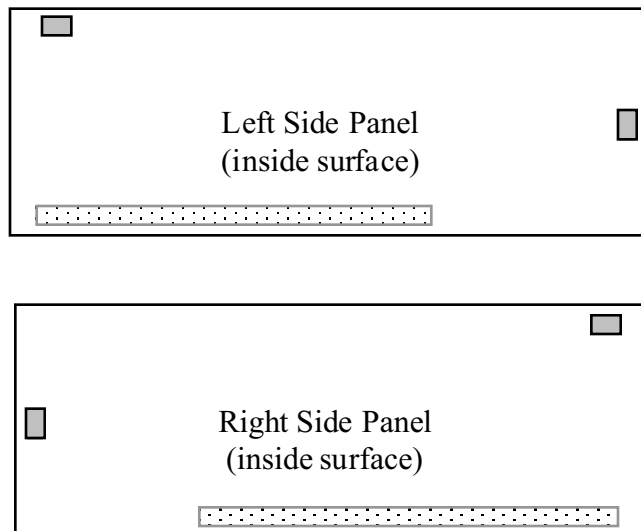

Figure 6-6

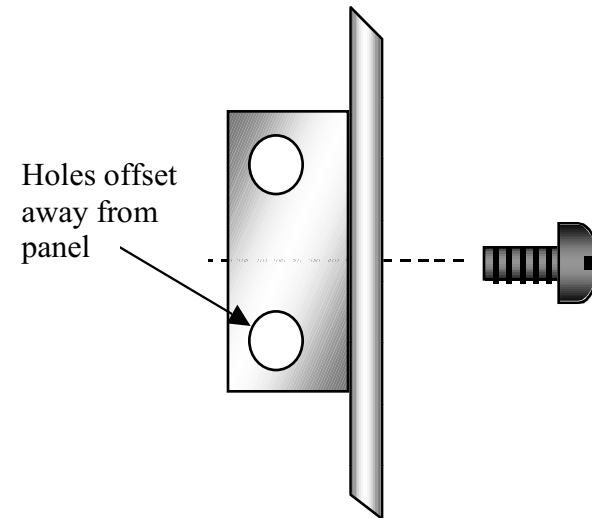

Figure 6-7

- Install two 2-D fasteners on each side panel at the locations indicated by small rectangles in Figure 6-6. Use one chassis screw to hold each fastener to the side panel (see Figure 6-7). The two unused holes on each fastener must be offset *away* from the side panel.



Since the K2 chassis is made up of a number of individual panels and fasteners, you may need to loosen the fasteners and readjust them once or twice during assembly.

Attach the side panels to the RF board using two chassis screws per side panel. The side panels are attached to the 2-D fasteners that are already in place on the RF board. Figure 6-8 shows the approximate location of the two screws used to secure the right side panel.

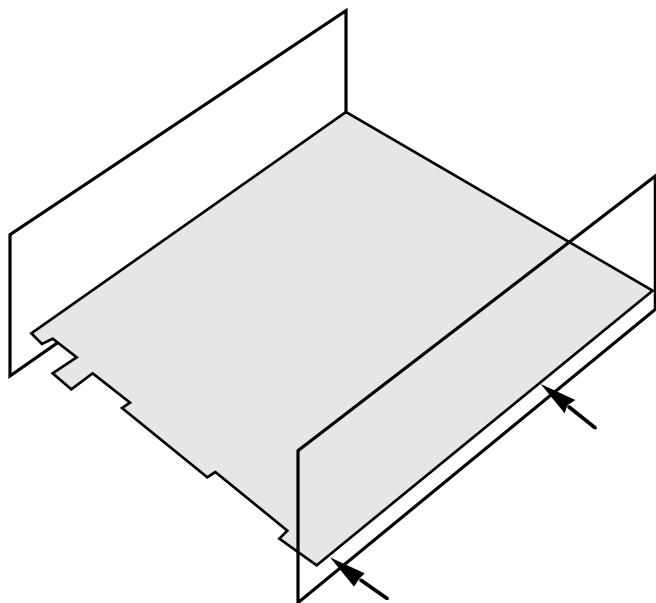

Figure 6-8

Locate the tilt stand, which can be found in the **MISCELLANEOUS** component bag. It has three parts: two oval feet and a tilt bail (Figure 6-9). Note: the screws that will be used to hold the tilt bail in place are not the black anodized type. They are standard steel/zinc plated screws, 7/16" (11 mm) long, so you won't confuse them with the 3/8" (9.5 mm) or 1/2" (12 mm) black screws.

Remove any masking tape from the bottom cover chassis piece.

Each oval foot has a notch into which the bail will be inserted. Install one of the oval feet on the bottom cover using two 7/16" (11 mm) 4-40 screws, #4 lock washers, and 4-40 nuts. The notch in the foot should be facing inwards (toward the other foot). The nuts and lock washers go on the *inside* of the bottom cover.

Install the tilt bail, then the second oval foot. The bail should be compressed firmly between the two feet. You may need to adjust the positions of the feet slightly before tightening the hardware.

Make sure the two feet are at exactly the same distance from the front edge of the bottom cover. If they are not equally spaced, the tilt stand may "rock" when in use.

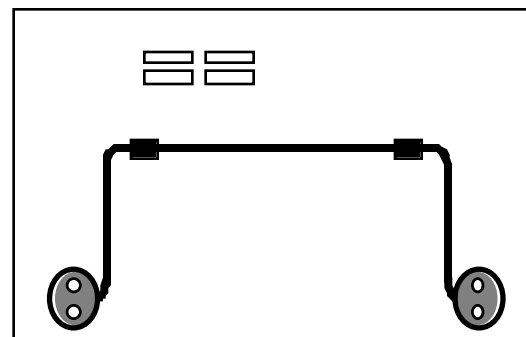

Figure 6-9

- Turn the RF board/side panel assembly upside down. Check for any untrimmed component leads on the bottom of the board.
- Position the bottom cover as shown in Figure 6-10, then secure it using six chassis screws. (The heat sink and rear feet will not be installed until Part III when the transmitter is assembled.)
- With the entire assembly still upside down or resting on one side panel, plug the front panel assembly into the RF board (Figure 6-10). Align the two assemblies so that connector J1 on the bottom of the front panel PC board mates with P1 on the bottom of the RF board. The arrow in Figure 6-10 shows the approximate location of P1 on the RF board.
- Once the front panel assembly is in place, the headphone jack (on the RF board) should be just flush with the front panel. The small rubber pads in the upper corners of the Front Panel board should be just touching the 2-D fasteners on the RF board. If this is not the case, the front panel must be pushed farther in.
- Secure the front panel to the side panels and RF board using 4 chassis screws. (Refer to the photos in Appendix D.) You may need to make slight adjustments to the 2-D fasteners at the top edge.

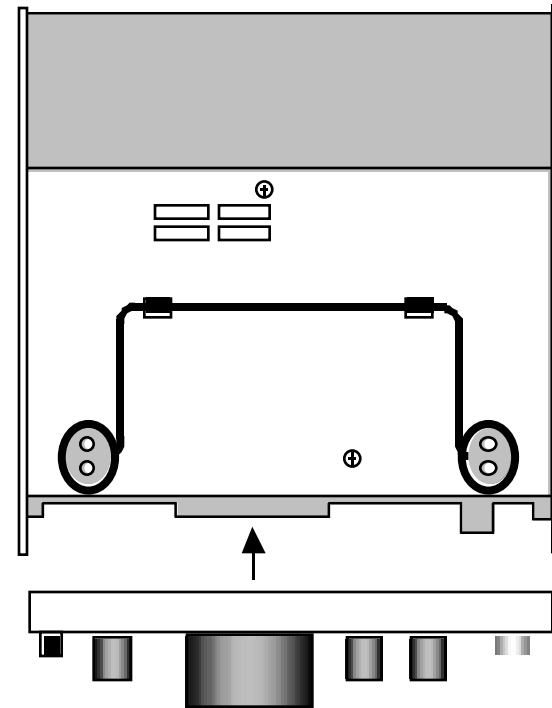

Figure 6-10

Plug the Control board assembly into the RF board, with the component side of the Control board facing backwards. (Refer to the photos in Appendix D.) All three connectors on the Control board must be lined up with the three connectors on the RF board at all pins.

Make sure the Control board is pushed as far down as it will go; it should be flat against the RF board along its entire edge, with all three connectors properly mated.



If the Control board does not plug in easily, you may have one or more connectors installed incorrectly.

The long-handled Allen wrench can be used to extract the Control board (Figure 6-11). To the left of J7 on the RF board you'll find the label "LIFT" near a hole at the base of the Control board. Insert the Allen wrench into this hole, then rest the knee of the wrench on the nearby screw head. Pry the board up with the wrench while guiding the board out at the top.

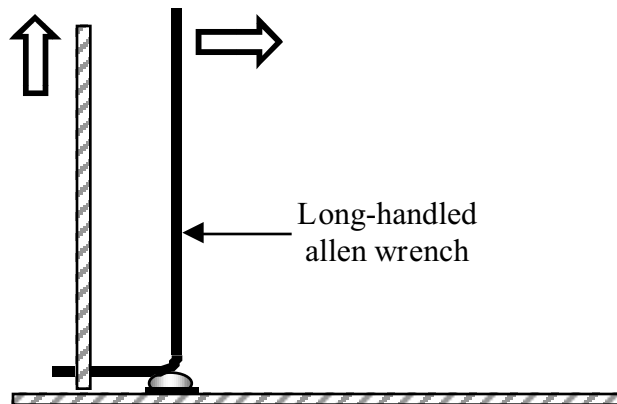

Figure 6-11

Once you have tried the Control board extraction technique described above, plug the Control board back in for the tests that follow.

Secure the front panel and Control boards together using two chassis screws (Figure 6-12). The upper left and right corners of the Control board may be touching the 2-D fasteners, or there may be a small gap.

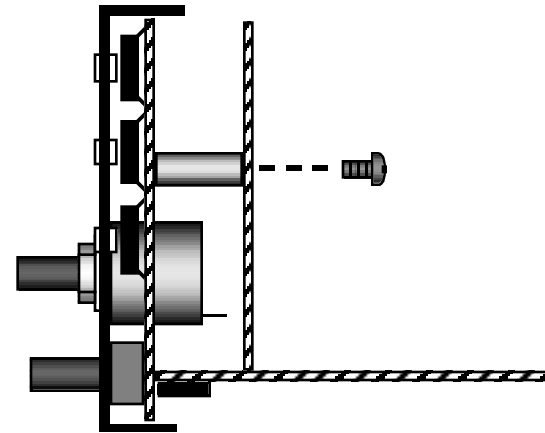

Figure 6-12

Push the black keycap onto S1's plunger until it snaps into place. Test S1's action (push on, push-off). Leave the switch in the OFF position (out).

Alignment and Test, Part 1

In this section you'll test most of the circuits on the Control board and front panel. Along the way you'll become familiar with basic operation of the K2, including use of the front panel switches, display, and menu.

Before proceeding with initial test, turn to the first page of the Operation section of the manual to familiarize yourself with the K2's front panel layout. *Do not turn on power to the K2 at this time.*

The Tap/Hold Rule

Each of the push-button switches on the front panel has two functions, one activated by a TAP (short press) and the other activated by a HOLD (long press, about 1/2 second). The upper label on each switch shows the TAP function (white lettering), and the lower label shows the HOLD function (yellow lettering). To highlight this in the text, we use two different typographical styles to identify switches: **TAP** and **HOLD**.

Initial Test



If any test or alignment step fails, refer to the Troubleshooting section (Appendix E).

Set the controls on the front panel as follows:

AF GAIN:	midway (12 o'clock)
RF GAIN:	maximum (clockwise)
KEYER:	midway
POWER:	minimum (counter-clockwise)
OFFSET:	midway

Locate P7 on the Control board. A shorting jumper should be installed onto the two pins of P7 nearest the "P7" label.

For the remaining test and alignment steps, you'll need a well-regulated 12-14 V power supply or a battery. A power supply rated at 300 mA or more of output current will suffice for the tests in Parts I and II, but higher currents (3-3.5 A) will be needed for transmitter tests in Part III.

If your power supply or battery does not already have a plug that mates with the power jack (J3), use the supplied mating plug and prepare a suitable power cable. The center lead of the plug is positive (+).

Make sure the K2 is turned OFF (power switch S1 out). Plug your power supply or battery into J3 on the rear panel.

Fold the tilt stand out to improve the viewing angle if desired.



If you see or smell smoke when you turn the K2 on for the first time, turn off power and disconnect the power supply immediately. Normally, you should hear the relays being reset by the I/O controller. Next, nonvolatile configuration memory (EEPROM) will be initialized. This process takes approximately 10 seconds. During this period, you should see **INFO 201** on the LCD. Displays of this kind are referred to as "INFO messages," and are used to alert you to possible problems. In this case, the info message is just a reminder that EEPROM has been initialized.

Turn on the K2 using S1. After about 10 seconds, you should see the default K2 frequency display for 40 meters: **7100.00c**. The letter C indicates CW mode. The annunciator for VFO A will also be turned on. (If you see any other INFO messages or the display does not come on, refer to Troubleshooting.)

Turn the K2 off and wait for a few seconds, then turn it back on. The display should now show **ELECRAFT** for about two seconds, followed by the frequency display. Now that the EEPROM is initialized, this is the display you should always see on power-up. The "R" and "T" in "ELECRAFT" appear in lower-case letters due to the limitations of the seven-segment LCD characters.

Tap the **DISPLAY** switch once to select voltage/current display. The display should now show something similar to this:

E12.0 i0.06

This would indicate that the power supply voltage (E) is about 12.0 V, and the supply current (I) is about 60-80 mA.⁷

Optical Encoder Test

Tap the **DISPLAY** switch to return to the frequency display.

Turn the VFO knob in both directions and verify that the displayed frequency changes accordingly.

Tap the **RATE** switch to the right of the knob to change the tuning rate, and repeat the VFO test at each rate.

Relay Test

Tap the **BAND+** switch. You should see the band change to the next higher band. At the same time, you'll hear one or more relays.

Tap the **BAND+** switch 7 more times to verify that you hear relays being switched with each band change. **Note:** The 1.8 MHz (160 m) and 5 MHz (60 m) bands will not appear in the band list unless the associated options are installed. This can be done only after assembly and alignment have been completed.

⁷ The supply voltage reading will reflect a small drop across D10, the reverse-polarity protection diode, typically 0.1 V on receive. Accuracy of both current and voltage readings is about +/- 5%.

Tap the **PRE/ATTN** switch three times. You should hear relays switch each time.

RF Probe Assembly

The Switch Spacing Tool used during Front Panel can now be used as the PC board for the RF probe. All parts for the probe, including a ground alligator clip, 2 feet of RG174 coax, and banana plugs for a DMM, are supplied with the kit. You can assemble the probe at any time, using the instructions on page 9 of Appendix E.

Voltmeter Probe Assembly

If you do not have a DMM (digital multimeter), you can use the simple DC voltage probe shown below in conjunction with the built-in voltmeter. The crimp pin and 2-pin housing can be found in the **MISCELLANEOUS** components bag.

Assemble the voltage probe as shown in Figure 6-13 using green-insulated hookup wire. No ground connection is needed since you will be measuring voltages inside the K2.

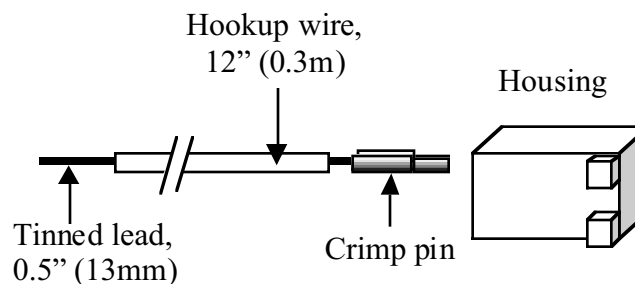

Figure 6-13

Plug the voltage probe assembly into P5 on the Control board. The probe should be oriented so that the hookup wire is connected to the (+) side of P5.

Move the voltage select jumper (Control board, P7) toward P5. Select voltage/current display mode using the **DISPLAY** switch. The voltage reading on the LCD should go to **00.0**.

To test the voltage probe, touch the tinned end of the hookup wire to pin 1 of the I/O controller, U1 (RF board). The voltage displayed on the LCD should be approximately 6 V.

Return the voltage select jumper to the "12 V" position.

Note: Always disconnect the voltage probe when it is not in use. It may cause shorts or noise pickup if left inside the K2 during normal operation

Menu Tutorial

We'll present a brief tutorial on using the menu here. A complete list of menu functions can be found in the Operation section.

Tap the **MENU** switch on the K2. The first entry will be displayed:

ST L 040

This is the sidetone level menu entry. **040** is the associated *parameter*, in this case the sidetone volume setting. The row of *annunciators* under **ST L** serves as an underline, indicating that turning the VFO knob will change the menu entries.

Tap the **MENU** switch again and you'll return to the frequency or voltage/current display, depending on what display mode was selected when you entered the menu.

Tap **MENU** again to bring up the menu. Turn the VFO knob now, and you'll see the other menu entries and their parameters scroll by. (You can also tap the **BAND+** or **BAND-** switches to scroll through menu entries.) Scroll the menu until you see

INP HAND

This menu entry is used to select the keying device. **HAND** means that the key jack is configured for a hand key or external keyer.

Press and hold the **EDIT** switch for 1/2 second to activate the EDIT function. (Remember the TAP/HOLD rule: when you HOLD a switch in, you activate the function indicated by the lower label on the switch.) The display should now show:

INP HAND

Notice that the underline has moved to the parameter (**HAND**). This tells you that you're in EDIT mode, and that turning the VFO knob will now change the parameter for the current menu entry. You can also change the parameter using **BAND+** and **BAND-**.

Turn the VFO knob now to see the various keying input selections. **PDLn** and **PDLr** configure the key jack for a keyer paddle, wired for either normal (tip = dot) or reverse (tip = dash) operation.

Tap the **MENU** switch again to exit EDIT mode. The underline should return to the menu entry.

Using the Calibration Functions

Scroll the menu until you see **CAL OFF**. This is the entry point into the calibration sub-menu, which you'll be using during alignment.

Enter **EDIT** mode by holding **EDIT** as before, moving the underline to the **OFF** parameter. Then turn the VFO knob to see the various **CAL** functions, including **FCTR** (frequency counter), **CUR** (transmit current limiting) **S HI** / **S LO** (S-meter calibration), **FIL** (crystal filter configuration), and **PLL** (VFO calibration).

Once you select a **CAL** function, holding **EDIT** again activates the function. The selected **CAL** function remains active until you tap **MENU** again, which returns you to the menu. Another tap of **MENU** returns you to the normal K2 display.

In the following section you'll activate the **CAL FCTR** (frequency counter) function. For now, just tap **MENU** once or twice to return to the normal display.

Frequency Counter Probe Assembly

In the bag labeled **MISCELLANEOUS** you'll find the components for the frequency counter probe (Figure 6-14). These components include a 10 pF axial-lead capacitor, two crimp pins, a 2-pin housing, and a 1-pin male connector (probe tip).

Cut a 7" (18 cm) length of RG-174 cable and carefully remove 1/2" (13 mm) of the coax jacket from each end. Be careful not to nick the braid.

Separate the braid from the center conductor at both ends. Remove 1/4" (6 mm) of insulation from each center conductor. At one end, cut the braid off completely right at the coax jacket (a ground connection will not be needed for frequency measurements). The braid should be twisted into a fine bundle at the other end.

Solder crimp pins onto the center conductor and shield at the housing end of the cable. Solder quickly, so that the heat from soldering does not melt the center insulator of the coax and cause a shield-to-center short.

Insert the pins into the crimp housing as shown in Figure 6-14. They should snap into place. Each crimp pin has a small tab on the back that latches into a hole in the housing.

Trim the leads of the 10 pF axial-lead capacitor down to 1/4" (6 mm). Solder one end to the center conductor of the coax cable.

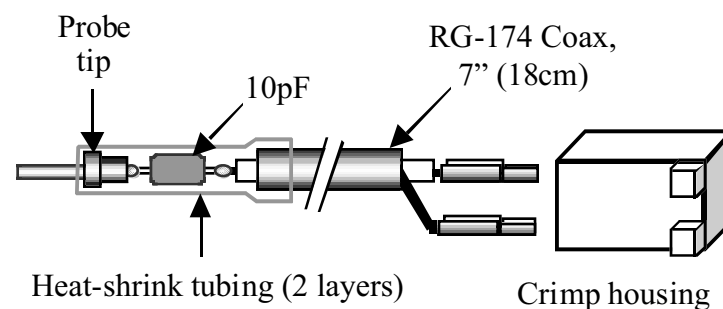

Figure 6-14

- Solder the probe tip to the other end of the 10 pF capacitor.
- Slip a 1" (2.5 cm) length of the larger size heatshrink tubing onto the probe tip components. Shrink the tubing using a heat gun. (You can also use a soldering iron, but avoid melting the tubing.)
- Add a second, identical length of heatshrink tubing on top of the first, then shrink it. This strengthens the assembly.

Plug the frequency counter probe assembly into P6, which is at the far left end of the Control board (as viewed from the front of the transceiver). The connector can only be plugged in one way.

Turn on the K2 and tap **MENU** to bring up the menu, then scroll to the **CAL** menu entry. Hold **EDIT**, then scroll the **CAL** parameter until the display shows **CAL FCTR**. Hold **EDIT** again to activate the frequency counter function of the **CAL** sub-menu. The LCD should show **0000.00**. (The frequency counter circuitry is sensitive, so it may pick up a stray signal and show it on the display.)

To test the counter, you can read the frequency of the 4 MHz oscillator on the Control board. Touch the counter probe tip to the left side of trimmer capacitor C22, which is just below the 18C452 microcontroller. The LCD should now read very close to **4000.00**.⁸

Remove the frequency counter probe.

Audio Amplifier and Tone Generator Test

Plug in a pair of low-impedance (4 to 32 ohm) headphones, stereo or mono.

Tap **MENU** and scroll to the sidetone level menu entry (**ST L**). Hold **EDIT** to activate the sidetone. You should now hear a clean 600-Hz audio tone. Turning the VFO knob should vary the volume.

Notice that turning the AF GAIN control does *not* affect the sidetone volume. The sidetone is injected into the AF amplifier after the volume control, so AF GAIN affects only the receiver volume.

Tap **MENU** to turn off the sidetone, then scroll up to the sidetone pitch menu entry (**ST P**) using the VFO knob or by tapping the **BAND+** switch. The display will show

ST P 0.60

This indicates that the sidetone pitch is set for **0.60** kHz (600 Hz). Hold **EDIT** to turn on the sidetone, then vary the VFO knob. The pitch of the sidetone should change to match the display.

Keyer

In the following steps you'll test the keyer (audio tone generation only). This tests the keyer jack, speed control, and potentiometer read circuits, including the A-to-D converter on the microcontroller.

Tap **MODE** until *C* is displayed at the right end of the LCD, indicating CW mode.

Plug a keyer paddle into the key jack. The plug must be stereo (2 circuit). A mono plug will key the transmitter continuously. (A mating stereo plug for the keyer jack is supplied with the kit.)

Using the menu's **INP** entry, set up the keyer input for either **PDLn** or **PDLr** as described previously.

Adjust the **KEYER** control. As soon as you turn it, the display should show the keying speed (approx. 9-50 WPM).

While listening with headphones, test the keyer paddle to verify that both dot and dash are working.

Note: No sidetone will be generated when LSB or USB mode is selected (*L* or *U*).

⁸ This is not a valid indication of how well the 4 MHz oscillator is calibrated, since this oscillator is used as the reference for the frequency counter itself. The 4 MHz counter will be calibrated in a later step.

Setting the AGC Threshold

- Make sure the RF GAIN control is rotated fully clockwise.
- Locate potentiometer R1 on the Control board (right side, as viewed from the front of the K2).
- Set your DMM for DC volts. Connect the (-) lead of the DMM to one of the ground jumpers or to the K2 chassis ground.
- Touch the (+) lead to pin 5 of U2 on the Control board. (U2 is located just above trimmer R1. Pin 5 is the pin nearest diode D1.)
- Adjust R1 for a reading of **3.80** volts on the DMM. This is the suggested setting, but it can be adjusted later to suite the operator.



The S-meter must be realigned anytime the AGC threshold setting is changed. S-meter alignment is covered in the following steps.

S-Meter Alignment

- Using the menu, select the **CAL S LO** function (S-meter zero). Hold **EDIT** a second time to activate it.
- Turn the VFO knob until you see only the left-most segment of the LED bargraph lit. Then turn the knob a bit more clockwise until this LED just turns off.
- Exit the **CAL S LO** function by tapping **MENU**. Enter the menu again and select **CAL S HI** (S-meter full-scale sensitivity).
- Turn the RF GAIN fully counter-clockwise (minimum gain). Adjust the VFO knob until you see segment 9 of the bar graph lit, then turn it a bit more counter-clockwise until segment 10 just turns on (right-most segment).

- Turn the RF GAIN control back to its full clockwise position.
- Exit the **CAL S HI** function by tapping **MENU**.

Bargraph Current Test

In the following steps, you'll test the current measurement circuit by using the bargraph LEDs to establish a known current drain.

- Enter the menu and verify that **GRPH** (LED bargraph mode) is set to **DOT**, not to **BAR** or **OFF**.
- Set the RF GAIN control for minimum gain. Segment 10 of the LED bargraph should now be on if you have done the S-meter adjustment as described above.
- Using the menu, select the **LCD** menu entry. Change the parameter from **NITE** to **DAY**. At this point you'll see the LCD backlight turn off, and segment 10 of the LED bargraph will become much brighter.
- Exit the menu and tap **DISPLAY** to switch to voltage/current mode. Write down the voltage and current readings.
- Use the menu to change the **GRPH** mode to **BAR**. All 10 segments of the LED should now be on.
- Exit the menu and check the current. It should now be about 0.16 to 0.18 amps higher.
- Use the menu to change **GRPH** to **DOT**, and **LCD** to **NITE**.



The combination of **LCD DAY** and **GRPH BAR** can result in high peak current drain on receive. When operating from a battery, **DOT** or **OFF** should be used to conserve power. More information about conserving power is provided in the Advanced Operating Features section.

Assembly, Part II

In this section you'll install the components for the synthesizer and receiver circuits. Most of the components to be installed are on the front half of the board (see Figure 6-1). After all of the parts are installed, individual stages will be aligned and tested. Detailed troubleshooting procedures are provided in the Troubleshooting section should you need them (Appendix E). The supplied RF probe will be very useful if you need to do signal tracing. RF probe assembly instructions start on page 9 of Appendix E.

In some steps a large number of components will be installed, then soldered as a group. Check for unsoldered leads after completing each group. A final complete check will be done later.

Remove the screws holding the Control board to the Front Panel board, then unplug the Control board. To avoid damaging any Control board components, use the long-handled Allen wrench as described in Part I.

Remove the bottom cover (six screws).

Remove the screws from the front panel assembly and unplug it from the RF board. Pull it straight out from the bottom edge, near the middle of the panel. This may be easier to do with the transceiver sitting on its right side so that you can steady it with one hand and pull with the other.

Remove the side panels by taking out the two screws along the bottom edge of each panel.

Install the following 1/4-watt resistors, orienting them so that the first band is at the left or toward the back of the board. The resistors are listed in the order they appear on the RF board, starting with R9 (near the left edge, about halfway back).

Note: Remember to complete each line of resistors before proceeding to the next line (i.e., install R9, then R16, then R10).

__ R9, 100 k (BRN-BLK-YEL) ⇒ __ R16, 100 k (BRN-BLK-YEL)
 __ R10, 470 (YEL-VIO-BRN) __ R31, 10 k (BRN-BLK-ORG)
 __ R32, 10 k (BRN-BLK-ORG) __ R33, 15 k (BRN-GRN-ORG)
 __ R30, 120 (BRN-RED-BRN) __ R28, 27 k (RED-VIO-ORG)
 __ R20, 270 (RED-VIO-BRN) __ R21, 100 k (BRN-BLK-YEL)
 __ R22, 3.3 M (ORG-ORG-GRN)

__ R25, 2.7 k (RED-VIO-RED) __ R24, 2.7 k (RED-VIO-RED)
 __ R15, 33 (ORG-ORG-BLK) __ R14, 10 k (BRN-BLK-ORG)
 __ R13, 10 k (BRN-BLK-ORG) __ R12, 560 (GRN-BLU-BRN)
 __ R17, 100 k (BRN-BLK-YEL) __ R11, 560 (GRN-BLU-BRN)
 __ R5, 2.7 k (RED-VIO-RED) __ R78, 22 (RED-RED-BLK)
 __ R6, 100 (BRN-BLK-BRN) __ R7, 68 (BLU-GRY-BLK)
 __ R8, 100 (BRN-BLK-BRN)

__ R92, 33 (ORG-ORG-BLK) __ R91, 820 (GRY-RED-BRN)
 __ R93, 820 (GRY-RED-BRN)
 __ R72, 470 (YEL-VIO-BRN) __ R95, 2.7 k (RED-VIO-RED)
 __ R96, 2.7 k (RED-VIO-RED) __ R74, 47 (YEL-VIO-BLK)
 __ R73, 2.7 k (RED-VIO-RED) __ R97, 33 (ORG-ORG-BLK)

__ R80, 680 (BLU-GRY-BRN) __ R81, 1.8 k (BRN-GRY-RED)
 __ R79, 1.8 k (BRN-GRY-RED)
 __ R82, 18 (BRN-GRY-BLK) __ R101, 10 k (BRN-BLK-ORG)
 __ R107, 100 k (BRN-BLK-YEL) __ R111 5.6 k (GRN-BLU-RED)
 __ R112, 22 (RED-RED-BLK) __ R90, 470 (YEL-VIO-BRN)
 __ R89, 100 (BRN-BLK-BRN) __ R88, 470 (YEL-VIO-BRN)
 __ R84, 18 (BRN-GRY-BLK) __ R85, 150 (BRN-GRN-BRN)
 __ R83, 4.7 ohms (YEL-VIO-GLD)

Install the resistor networks. Start with RP2, which is in the front left-hand corner. Align the pin 1 mark on each resistor network with the pin 1 end of its component outline.

__ RP2, 10 k, 8 pins (8A3.103G)
 __ RP3, 10 k, 8 pins (8A3.103G)
 __ RP6, 100 k, 8 pins (8A3.104G)
 __ RP4, 100 k, 6 pins (6A3.104G)
 __ RP5, 100 k, 6 pins (6A3.104G)

Locate all of the small glass-bodied diodes. You should have a number of 1N4148 diodes, and one 1N5711, which will be similar in size but should have different markings. Use a piece of masking tape to identify the 1N5711 as "D9, 1N5711."

Install the following diodes, located near the outline for toroidal transformer T5, in the synthesizer area. Be sure to orient the diodes according to their outlines.

__ D11, 1N4148 __ D13, 1N4148
__ D6, 1N4007 __ D7, 1N4007

Varactor diodes have a small plastic package, like a TO-92 transistor, but with only two leads. Sort the varactor diodes into groups: type MV209 and type 1SV149. (1SV149 diodes are labeled "V149" and may have a center lead that has been cut flush with the body of the device.) *The K2 will not function correctly if the varactor diode types are interchanged.*

Install the MV209 diodes listed below. The flat side of each diode must match the flat side of its PC board outline. These diodes must be pushed all the way down on the board to prevent stray signal coupling. Bend the leads slightly to hold them in place. D16 and D23-D26 are in the front-left corner. D39 is to the right of J7 (Control board).

__ D16 __ D23 __ D24
__ D25 __ D26 __ D39

Note: Do not install D19 and D20. These are supplied with the planned K60XV option, which should not be installed until the K2 has been aligned and tested.

Install type 1SV149 diodes at D37 and D38, near the SSB option connector. Keep them flat against the PC board, with no excess lead length.

Install the remaining 1SV149 diodes listed below, keeping them flat against the PC board, with no excess lead length. D17, D21 and D22 are in the front-left corner. D29 through D34 are on the right side near the crystal filter.

__ D17 __ D21 __ D22
__ D29 __ D30 __ D31
__ D32 __ D33 __ D34

Install the TO-92 package transistors listed below. Start with Q17, near the middle-left edge.

__ Q17, 2N7000 __ Q16, PN2222A __ Q18, J310
__ Q19, J310 __ Q20, 2N7000 __ Q24, J310
__ Q25, PN2222A

Install Q21 (2N5109), which is located near U1 in the middle of the board. Align the small tab on the transistor's case with the tab on its component outline. Bend the leads on the bottom to hold Q21 in place, then solder.

Install Q22 (2N5109), which is to the right of the "ELECRAFT" label. Make sure Q22 is flat against the board before soldering.

Carefully press a 3/4" (19 mm) dia. by 0.25" (6.4 mm) high star heat sink onto Q22. The heat sink should be pressed down as far as it will go, and should not touch the components around the transistor. **The heat sink is fragile. If you need to spread it slightly, use a blunted wooden pencil or a plastic wire nut.**

Install Q12 (2N7000), which is to the right of Q22.

Install Q23 (2N7000), near the right-front edge of the board.

Install C167 (.001 μ F, "102"), which is near J11, the connector for the SSB adapter. The leads on this capacitor should be formed to match its PC board outline.

Sort all of the remaining capacitors by value to reduce the possibility of assembly errors in the next step. If you are unsure of any capacitor's value and do not have a capacitance meter, the pictures in the parts list (Appendix A) may help.

Install the following capacitors, starting with C86 in the front-left corner. Integer values are in pF and fractional values are in μF .

__ C86, 0.1 (104)	⇒	__ C84, 120 (121)	⇒	__ C85, 120 (121)
__ C100, .001 (102)		__ C95, .01 (103)		__ C96, 1 μF (105)
__ C71, 82 (82)		__ C72, 270 (271)		__ C73, 47 (47)
__ C74, 20 (20)				
__ C82, .001 (102)		__ C80, .001 (102)		__ C81, .001 (102)
__ C79, .001 (102)		__ C59, 0.1 (104)		__ C38, .001 (102)
__ C55, .01 (103)		__ C61, .01 (103)		__ C58, .01 (103)
__ C65, 0.1 (104)		__ C54, .01 (103)		
__ C68, 10 pF (10)		__ C64, .001 (102)		__ C67, 0.1 (104)
__ C63, .01 (103)		__ C92, .022 (223)		__ C94, 0.047 (473)
__ C89, .001 (102)		__ C87, .01 (103)		__ C175, .01 (103)
__ C62, .01 (103)		__ C154, 100 (101)		__ C144, 100 (101)
__ C156, .047 (473)		__ C158, .01 (103)		__ C53, .01 (103)
__ C52, .01 (103)		__ C141, .01 (103)		__ C57, .001 (102)
__ C146, .01 (103)		__ C151, 0.1 (104)		__ C145, .01 (103)
__ C153, 68 (68)		__ C155, .01 (103)		__ C172, .01 (103)
__ C177, .022 (223)		__ C174, 82 (82)		__ C173, 220 (221)
__ C178, 0.1 (104)		__ C176, 0.1 (104)		__ C165, .01 (103)
__ C169, 390 (391)		__ C168, .01 (103)		__ C160, .01 (103)
__ C159, .01 (103)		__ C143, .01 (103)		__ C142, .01 (103)
__ C163, .01 (103)		__ C162, .047 (473)		__ C164, .01 (103)
__ C170, .047 (473)		__ C166, .047 (473)		__ C179, 100 (101)
__ C182, 180 (181)		__ C184, .01 (103)		
__ C185, 0.1 (104)		__ C181, .01 (103)		

Install the following ICs, aligning the notched end of each IC with the notch on its component outline. U6 is at the front-left.

__ U6, LMC662	⇒	__ U5, LTC1451	⇒	__ U4, MC145170
__ U3, LT1252		__ U10, NE602		__ U9, LT1252
__ U11, NE602		__ U12, MC1350		

Install U8 (78L05), which has a plastic TO-92 package like a transistor. U8 is located near the front left corner of the board.

Option-bypass jumpers W5, W2 and W3 are located on the right side of the board, near the crystal filter. Use component leads to make these jumpers, or remove the insulation from appropriate lengths of green hookup wire. These jumpers should be formed so that they lie flat on the board, and should not touch any adjacent components.

Test points TP1, TP2, and TP3 are round, yellow, single-pin female connectors. TP1 and TP3 can be found in the synthesizer area of the board. TP2 is near the SSB option connector, J11. Install and solder all three test points.

Install RF choke RFC13 (100 μH , BRN-BLK-BRN), near the middle of the board. Orient the first color band to the left.

Install the receive mixer, Z6 (TUF-1), below the "ELECRAFT" label at the middle of the board. Make sure that Z6 is lined up with its component outline and is flush with the board before soldering.

Install the electrolytic capacitors in the order listed below, starting with C60 near the far left-hand edge. Insert the (+) lead of each capacitor into the hole with the (+) symbol.

__ C60, 100 μF	__ C93, 10 μF	__ C103, 220 μF
---------------------------	--------------------------	----------------------------

Install RFC15 (100 μH subminiature RF choke) and C91 (.001 μF) as explained in the manual errata sheet.

- Locate the crystals used on the RF board: 12.096 MHz (1), 4.9152 MHz for BFO (2) and 4.9136 MHz for crystal filters (7). **Do not mix the BFO and filter crystals, which have different characteristics.**
- The bag of 7 filter crystals should have a number written on it. Record the number here: _____. (This identifies the tested frequency of the crystals, and can be used in aligning filters.)
- Install the 12.096 MHz crystal, X1, at the lower left. The crystal should be seated flat on the board before soldering (it is OK to bend the pins to hold it to the board). **X2 is not used.**
- To the left of X1 (along the edge of the board) you'll find a pad for grounding the crystal case. Use short lengths of bare wire to ground the crystal on at the top of the can.
- Install the BFO crystals at X3 and X4 (near J7). **Important:** trim **X3's** leads, and fold them down flat against their pads, before soldering. Then use a minimal amount of solder. *This is necessary to avoid interference between X3 and L33 in a later step.*
- Ground the cases of X3 and X4. The ground pads are to the left of the crystals.
- Install the 4.9136 MHz filter crystals at X5 through X11.
- Ground the cases of X5 and X6. The ground pads are near where the two crystals meet.
- A special grounding technique is required for X7-X11.** There are two ground pads for each of these crystals, one on either side. Use bare wires (10 total) for grounding the crystals as you did in previous steps, but **do not** solder the wires to the *tops* of the crystals. The wires must be soldered to the *sides* of the crystals, instead, about 1/4" (6 mm) up from the surface of the PC board. **Be very careful not to overheat the crystals. Use a temperature-controlled iron, and limit soldering time to about 3 seconds per soldering attempt.**



In the following steps you'll install several toroidal inductors. **Use the number of turns indicated.** Do not attempt to alter the turns to match inductances specified in the parts list.

- Sort the black and dark gray toroidal cores into three groups to avoid mis-identifying them in later steps. You should have eight FT37-43 ferrite cores (3/8", 9.5 mm); four T44-10 iron powder cores (0.44", 11 mm); and one FT50-43 ferrite core (0.5", 12.7 mm). Ferrite cores are **dark gray**; T44-10 cores are **black**.
- Locate a 3/8" (9.5 mm) diameter ferrite toroidal core (type FT37-43) as described above.
- Find RFC14's component outline on the RF board, near the front left-hand corner. Compare this component outline to Figure 6-15, which shows two views of a typical toroidal inductor. RFC14 will be mounted vertically as shown at the right side of the drawing, with one wire exiting at the core's upper left, and the other at the lower right. There are pads on the PC board in these two locations.

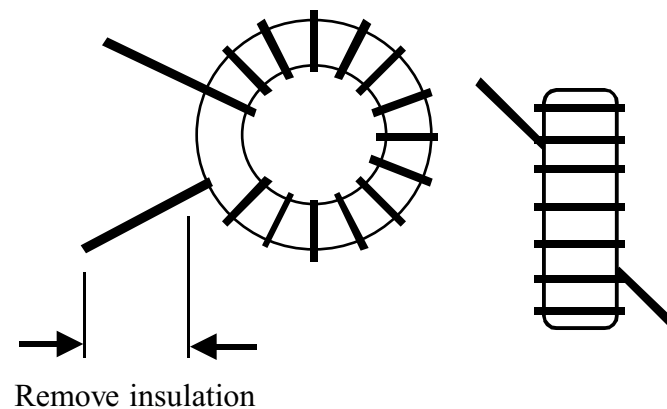

Figure 6-15

Note: Toroid illustrations such as the one above do not always show the actual number of turns used.

To wind RFC14, cut a 9" (23 cm) length of #26 red enamel-coated wire, then "sew" the long end of the wire through the core exactly 10 times. *Each pass through the core counts as one turn.* The finished winding should look very similar to Figure 6-15, but with 10 turns rather than 14.

Verify that the turns of RFC14 are not bunched together. They should be evenly-spaced and occupy about 85% of the core's circumference. If the turns are all bunched together, RFC14's inductance value will not be correct. (Unless otherwise specified, about 80 to 90% of the core should always be used.)

Stripping Toroid Leads

The enamel wire supplied with the kit can be heat-stripped. One way to do this is to place a small amount of solder (a "blob") on the end of your soldering iron, then insert the wire into the hot solder for a few seconds. Another possibility is to burn the insulation off by heating it with a match or small butane lighter for a few seconds, then use fine-grain sandpaper to remove the enamel residue. Avoid scraping insulation off with a razor blade, as this may nick the wire.

Strip and tin the leads of the toroid before you mount it on the board. As shown in Figure 6-15, you should remove the enamel from the leads up to about 1/8" (3 mm) from the core. You should see only bare wire (no insulation) on the side to be soldered.

Install RFC14 vertically as shown by its component outline, near the front left-hand corner of the board, then pull the leads taut on the bottom of the board.

Solder the leads of RFC14. When soldering, make sure that the solder binds well to the leads. If the lead appears to be an "island" in a small pool of solder, chances are it is not making good contact. Measure from pad to pad (not wire to wire) using an ohmmeter to be sure the leads are making contact.



Do not use adhesives or fixatives of any kind to secure toroids to the PC board. Toroids will be adequately held to the board by their leads alone. (T5 is the only exception.)

RFC16 is wound on an FT37-43 core (dark gray) using 16 turns of red enamel wire (12", 30 cm). Wind this inductor in the same manner as RFC14. Install RFC16 vertically, to the right of RFC14.

RFC11 is wound on an FT37-43 core using 20 turns of red enamel wire (16", 40 cm). Wind this inductor and prepare its leads in the same manner as RFC14.

Install RFC11 horizontally, on the *bottom* side of the board, as shown by its component outline (near the center of the board). The pads for RFC11 are the two that just touch the outline. Pull the leads taut on the top to keep the toroid secured to the board, then solder.



T5 is a toroidal *transformer*, with two numbered windings. These numbers are printed next to each pad on the PC board. T5's windings are 1-2 and 3-4.

Locate the large yellow core (T50-6) for use at T5. The core is 1/2" (12.7 mm) in diameter.

Wind the first winding, 1-2, using 16 turns of red enamel wire (15", 38 cm). This winding must occupy 85% of the core, and will look very similar to Figure 6-15. Remember that each pass *through* the core counts as one turn.

Carefully strip and tin the leads of T5's 1-2 winding.

□ T5's other winding, 3-4, uses 4 turns of *green* enamel wire (7", 18 cm). Wind the 3-4 winding on top of the 1-2 winding, interleaving the turns as shown in Figure 6-16. The turns should be secure, not loose. Strip and tin the leads of the 3-4 winding.

Note: T5's 3-4 winding must be wound exactly as illustrated or the VFO will not function correctly.

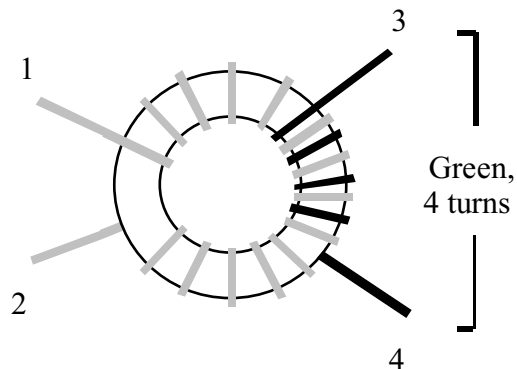

Figure 6-16

□ Install T5 as shown by its component outline in the synthesizer area of the board. Figure 6-17 shows how the 1-2 and 3-4 windings are oriented with the numbered pads. (Also shown are the nylon washer and screw, which will be installed in the next step.) Pull T5's leads taut on the bottom of the board, but do not solder yet.

□ Secure T5 to the board as shown in Figure 6-17 using a 3/8" (9.5 mm) diameter nylon washer, 1/2" (12.7 mm) long nylon 4-40 screw, and a #4 nylon nut. Tighten the nylon nut just enough to hold the assembly in place. Do not over-tighten as this will strip the threads. Solder T5, checking for good solder joints as before.

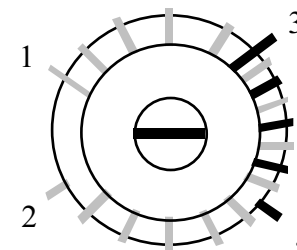

Figure 6-17

□ T7 is a toroidal transformer wound on a 3/8" (9.5 mm) diameter ferrite core (dark gray, FT37-43). T7's orientation and windings will appear similar to Figure 6-18. Wind T7's 3-4 winding first, using 20 turns of red enamel wire (20", 51 cm). (The drawing shows 14 turns.)

□ Wind T7's 1-2 winding using 5 turns of green enamel wire (6", 15 cm). Strip and tin the leads of both windings.

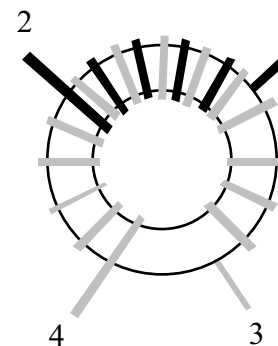

Figure 6-18

□ Install T7 as shown by its component outline near the front-right corner of the board, with the windings oriented as shown in Figure 6-18. Pull the leads taut on the bottom and solder.

Transformer T6 is mounted vertically, near the middle of the board. It uses a different winding technique where the wires for the two windings are twisted together before winding ("bi-filar"). Cut two 12" (30 cm) lengths of enamel wire, one red and one green. Twist them together over their entire length. The wires should cross over each other about once every 1/2" or 12 mm.

Wind the twisted wires onto a 3/8" (9.5 mm) ferrite core (FT37-43), using exactly 10 turns. Use the same method you used when winding non-twisted wires, covering about 85% of the core. Figure 6-19 shows how the winding should look from two views (your turns count will be 10 rather than 8 as in the drawing).

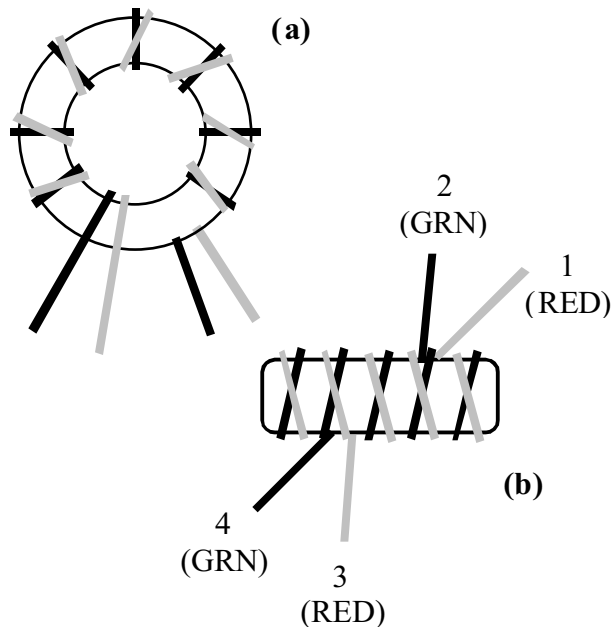

Figure 6-19

Clip and untwist the ends of the red/green pairs so that the leads of the transformer look like those in Figure 6-19 (b). The pin numbers shown match the component outline, with the red wires numbered 1-3 and the green wires numbered 2-4.

Strip and tin all four wires. Be careful not to strip the leads so close to the core that the red/green wire pairs might short together.

Install T6 vertically, with the wires inserted as indicated in Figure 6-19 (b). Pull the leads taut on the bottom, then solder.

Sort the slug-tuned shielded inductors into two groups: 1 μH ("T1050", quantity 4) and 4.7 μH ("T1005", quantity 8).

Install 4.7 μH inductors at L30 and L34 ("T1005"). Press these inductors down as far as they'll go before soldering.

Install the components listed below, starting with C39 in the back left corner (near the key jack).

- | | |
|--|---------------------------|
| __ C39, .001 (102) | __ C4, 820 (821) |
| __ C5, 100 (101) | __ C9, .001 (102) |
| __ C7, 100 (101) | |
| __ C8, 820 (821) | __ C108, .01 (103) |
| __ W6 (option bypass jumper) | __ D1, 1N4007 |
| __ R38, 1 k (BRN-BLK-RED) | __ D2, 1N4007 |
| __ RFC1, 100 μH (BRN-BLK-BRN) | |
| __ C107, .01 (103) | __ C109, .01 (103) |
| __ C110, .01 (103) | __ D3, 1N4007 |
| __ D5, 1N4007 | __ D4, 1N4007 |
| __ R37, 100 k (BRN-BLK-YEL) | __ R39, 1 k (BRN-BLK-RED) |
| __ C113, .01 (103) | __ C114, .01 (103) |
| __ W1 (option bypass jumper) | |

Review Figure 4-2 before installing Q2 in the next step.

Q2 is a ZVN4424A transistor, which has a slightly modified TO-92 package. It is flat on both sides, and the labeling may be on the smaller flat side. The *wider* flat side must be aligned with the flat side of the component outline.

Install Q2, which is near C113 (just installed). Be sure to orient Q2 as shown in Figure 4-2.

RFC3 is wound on an FT37-43 core (dark gray) using 16 turns of red enamel wire (12", 30 cm). Wind this inductor in the same manner as RFC14. Install RFC3 vertically, just to the left of W1.

Install 4.7 μ H slug-tuned shielded inductors (marked "T1005") at L1 and L2, near the back-left edge of the board.

Install the 40-meter low-pass filter components, which are listed below. These components are located near Q22 (2N5109 transistor with heat sink).

__ C225, 390 (391) __ C228, 56 (56) __ C227, 330 (331)
 __ C226, 680 (681) __ C229, 220 (221)

__ L25, T44-2 (red), 14 turns #26 red enamel wire, 14" (35 cm)

__ L26, T44-2 (red), 12 turns #26 red enamel wire, 13" (33 cm)



The leads of some bottom-mounted components may need to be pre-trimmed before mounting and soldering. See Page 11.

Install the following components on the bottom side of the board, starting with C207 at the back left. Once all components have been installed, solder them on the top side, being careful not to damage any adjacent top-mounted components.

__ C207, .001 (102) __ C216, .001 (102) __ C223, .001 (102)
 __ C224, .047 (473) (bend body down before soldering)
 __ C204, .001 (102) __ C208, .001 (102) __ C195, .001 (102)

(continued)

__ C133, 0.1 (104) (bend body down before soldering)

__ C135, .01 (103) __ C122, 56 (56) __ C119, .01 (103)
 __ C17, .001 (102) __ C27, .001 (102) __ C104, 68 (68)
 __ C29, 12 (12) __ C28, 12 (12)

__ R34, 2.7 k (RED-VIO-RED)
 __ RFC2, 100 μ H (BRN-BLK-BRN) __ RFC7, 15 μ H (BRN-GRN-BLK)

Find the "C6" label, along the back edge. The three pads near C6 are labeled "J15" on the top side (for a future option module). Install C6 (4.7 pF) into the *outer* two of the three pads.

Locate L31, a 10 μ H shielded solenoidal inductor (black case; may not be color coded). L31 is mounted on the bottom of the board, near the right edge. When soldering L31, be careful not to damage diode D18, which is on the top side near one of L31's leads.

Install the group of components listed below on the bottom of the board. C183 is near the front left corner.

__ C183, .01 (103) __ C186, .01 (103)
 __ C161, .01 (103) __ C150, 330 (331)

__ C90, .047 (473) (bend body down before soldering)
 __ C157, .047 (473) (bend body down before soldering)

__ R77, 220 (RED-RED-BRN) __ R76, 10 (BRN-BLK-BLK)
 __ R75, 680 (BLU-GRY-BRN) __ R94, 82 (GRY-RED-BLK)
 __ R99, 270 (RED-VIO-BRN) __ R98, 270 (RED-VIO-BRN)
 __ R100, 820 (GRY-RED-BRN) __ R110, 5.6 k (GRN-BLU-RED)
 __ R114, 3.9k (ORG-WHT-RED) __ R18, 1 M (BRN-BLK-GRN)
 __ R29, 10 k (BRN-BLK-ORG)

__ R19, 2.7 k (RED-VIO-RED)

__ RFC12, 100 μ H (BRN-BLK-BRN)

__ D36, 1N4007

__ RFC10, 1 mH (BRN-BLK-RED)

 The BFO toroid, L33, is supplied pre-wound due to the large number of turns and very small gauge wire required. When handling L33, be very careful not to damage the leads.

Locate the rubber stem bumper. Clip off about one-half of the tip of the stem using diagonal cutters.

L33 is located on the bottom of the board, near the front center. Place the rubber stem bumper directly on top of L33's component outline. **Flush-trim the leads of all parts under or near L33 so the stem bumper can sit flat on the PC board.**

Locate the pre-wound BFO inductor, L33 (41 μ H, 5%). It may be supplied in a small envelope or bag labeled "L33".

Press L33 down onto the stem bumper as far as it will go. Position L33 and the stem bumper as shown in Figure 6-20.

Locate resistor R116 (1/8th watt, 5.1 megohm, green-brown-green). Bend the leads of R116 down at 90-degree angles to match the spacing of L33's pads (Figure 6-20).

Insert R116's leads into L33's pads, then press the resistor down directly on top of L33. The resistor's body should be partially recessed into the "well" left in the center of the toroid.

Use the leads of R116 to hold L33 firmly to the board (Figure 6-21), bending them outward on the top side. Solder R116.

Solder L33's leads to the leads of the resistor points as shown in Figure 6-22. Keep L33's leads as short as possible, and away from any nearby component pads.

Trim off the excess portion of L33's leads. **Note:** Trimming fine wire may be difficult with worn or poor-quality diagonal cutters. Be careful not to stress L33's leads in the process. Use a magnifying glass if necessary.

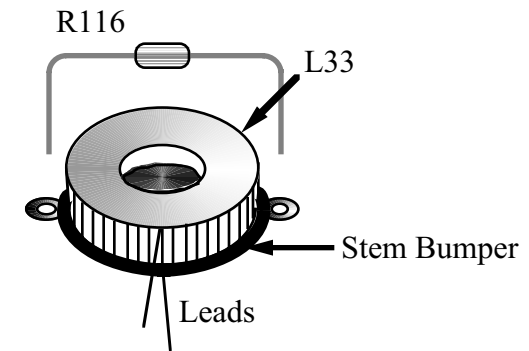

Figure 6-20

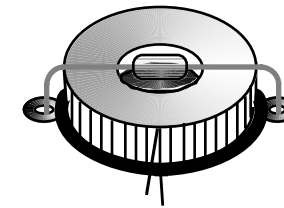

Figure 6-21

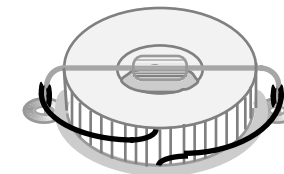

Figure 6-22

To ensure that R116 cannot short to the bottom cover, attach a thin self-adhesive insulator to the bottom cover in the area directly beneath L33. Electrical or other types of tape may be used.

Visual Inspection

Examine the bottom (solder side) of the RF board carefully for unsoldered pins, solder bridges, or cold solder joints. Since this is a large board, you should break the examination up into three parts:

__ perimeter of the board __ front half __ back half

Examine the top (component side) of the RF board for unsoldered pins, solder bridges, or cold solder joints. This step is necessary because some components are installed on the bottom of the board.

Make sure switch S1 on the RF board is in the OFF position. (Plunger OUT is OFF.)

Resistance Checks

Perform the following resistance checks:

Test Point	Signal Name	Res. (to GND)
R115, right end (near S1)	12V IN	> 500 ohms
U6 pin 8	8B	> 100 ohms
U4 pin 16	5B	> 1 k
U11 pin 8	8A	> 250 ohms
U10 pin 8	8 T	> 500 ohms
U12 pin 1	8R	> 500 ohms



It is very important to re-assemble the chassis as described below before attempting the alignment steps in the next section. If you don't put the chassis together, some alignment results will not be accurate.

Install the two side panels and secure with two chassis screws each.

Plug in the front panel assembly. Secure the front panel with four chassis screws.

Plug in the Control board.

Secure the front panel and Control boards together using two chassis screws.



Before installing the bottom cover in the following step, verify that all components on the bottom of the RF board have an installed height of 1/4" (6 mm) or less. Capacitors that stand above this height must be bent downward at an angle to prevent them from hitting the bottom cover.

Install the bottom cover and secure it temporarily using six chassis screws.

Alignment and Test, Part II

In this section you'll test and align the PLL (phase-locked-loop) synthesizer and receiver circuits. Once this is completed you'll be able to test the receiver using all modes on 40 meters.

- Connect your power supply or battery and turn on the K2.

4 MHz Oscillator Calibration

- Plug the frequency counter probe into P6 (Control board).
- Connect the probe tip to the PLL reference oscillator test point, TP3 (left-front corner of the RF board, near U4).
- Using the menu, select **CAL FCTR**, then hold **EDIT** a second time to enable the frequency counter. The counter should show a frequency of 12090 kHz +/- 30 kHz. If it is 0000.00, changing rapidly, or out of range, you could have a problem with the counter probe or the PLL Reference Oscillator.
- Use one of the following methods to adjust C22 on the Control board (listed in order of preference):

- Connect a calibrated external frequency counter probe to TP3, *without* removing the K2's internal counter probe. Adjust C22 until the K2's reading matches the external counter's reading.
- Alternatively, you can use a calibrated short-wave or ham-band receiver. Set the receiver for LSB or USB mode. Connect a short length of wire to the receiver's antenna jack, and lay the end near the 4 MHz crystal on the K2 Control board. Find the oscillator signal on the receiver. Tune the receiver to 4.000 MHz, and adjust C22 until you hear a zero-beat (pitch = 0 Hz).
- If you don't have a counter or receiver, leave C22 set at its mid-point for now. You can improve the calibration later using a calibrated signal generator or an on-air signal, such as WWV (at 10.000 MHz).

PLL Reference Oscillator Range Test

- Set up the K2 internal counter as described for **4 MHz Oscillator Calibration** (at left, first three steps).
- If you have an external frequency counter probe connected to TP3 along with the K2's internal counter probe, disconnect it.
- When you're in frequency counter mode, the **BAND+** and **BAND-** switches can be used to check the range of the PLL reference oscillator. First, tap **BAND+** and write down the frequency reading below (typically about 12100 kHz). Then tap **BAND-** and write down this frequency reading (typically 12080-12090 kHz).

Ref. High Freq.	Ref. Low Freq.	Range (kHz)

- Subtract the lower frequency reading from the higher reading. The range must be between 9.8 and 13 kHz (if not, see Troubleshooting). Tap **MENU** to exit **CAL FCTR**.

VCO (Voltage-Controlled Oscillator) Test

- Use **BAND+** or **BAND-** to select the 80-meter band, and set the VFO for a frequency of about 4000.10 kHz.
- Connect the frequency counter probe to the VCO test point, TP1. Activate the frequency counter using **CAL FCTR** as before.
- You should now see a frequency counter reading in the 8 to 10 MHz range. It may or may not be stable at this time (i.e., the frequency may be changing). If the reading is 0000 kHz or is changing rapidly, you probably don't have the counter cable connected to the VCO test point. If the reading is fairly stable but not between 8 and 10 MHz, refer to Troubleshooting.
- Tap **MENU** to exit **CAL FCTR**.

VCO Alignment

In the following steps you'll adjust the VCO inductor (L30) so that the VCO control voltage is in the proper range.

- Disconnect the internal frequency counter probe and remove it completely from the K2.
- Select 80 meters, and set the VFO for about 4000 kHz.
- Connect a DMM (digital multimeter) to the left end of resistor R30 (near the center of the synthesizer area of the RF board) and ground. Use a small alligator clip to ensure a good connection. (You can also use the built-in voltmeter to measure the VCO control voltage. Refer to Voltmeter Probe Assembly in Part I.)



It is possible to damage the slugs in slug-tuned inductors if you use a metal tool or if you tune the slug too far in or out. The tuning tool provided will not damage the slugs.

- Using the wide end of the plastic tuning tool, adjust the slug in inductor L30 until the voltage at R30 reads 6.0 V. If the voltmeter reading does not change at all as you tune L30 through its full range, refer to Troubleshooting. If the voltage changes but you cannot get to 6.0 V, you have probably wound the VCO inductor (T5) incorrectly or have installed the wrong value at L30 or C72.
- Set the VFO for approximately 3500 kHz.
- Measure and write down the VCO control voltage at this frequency in Table 6-1 (using pencil).
- For each remaining band, set the VFO to the low and high frequencies listed in Table 6-1 and write down the VCO control voltages.⁹ (You can tune quickly to the approximate frequencies in the table by selecting the 1-kHz tuning rate.)

⁹ Usable VFO coverage extends well beyond the ranges given in the table. 15 MHz is used as the upper boundary on 20 meters to allow reception of WWV at this frequency.

Table 6-1. VCO Voltage Readings

<u>Band</u>	<u>Low Freq.</u>	<u>Voltage</u>	<u>High Freq.</u>	<u>Voltage</u>
80 m	3500	-----	4000	-----
40 m	7000	-----	7300	-----
30 m	10000	-----	10150	-----
20 m	14000	-----	15000	-----
17 m	18000	-----	18200	-----
15 m	21000	-----	21450	-----
12 m	24800	-----	25000	-----
10 m	28000	-----	28800	-----

- If some VCO control voltage readings above are < 1.5 V, *or* some of them are > 7.5 V, you may be able to shift the entire set of readings so that they are all within the 1.5 to 7.5 V range. Switch to the band (and frequency) that had the highest or lowest voltage, then adjust L30 to bring that reading into range. Then re-measure all of the voltages to make sure they're in range.



If you have some voltages that are < 1.5 V and others that are > 7.5 V, you have probably installed the wrong value at one or more of the VCO capacitors (C71-C74) or varactor diodes (D21-D26). Another possibility is that T5 has the wrong number of turns or that you installed the wrong type of slug-tuned inductor at L30. If you change any of these components, repeat the VCO alignment procedure.

- Disconnect the DMM from R30.
- Connect the internal frequency counter probe to the BFO test point, TP2 (right side of the RF board, near the crystal filter).

BFO Test

The BFO (beat-frequency oscillator) will be tested in the following steps.

- Switch to the 40-m band.
- Connect the frequency counter to the BFO test point (TP2), which is on the right side of the RF board near the crystal filter.
- Using the menu, select **CAL FCTR**. The counter should show a frequency between 4908 and 4918 kHz.



If you see a reading of **0000.00** kHz or one that is changing rapidly, you may not have the frequency counter probe connected properly, or the BFO may not be working (see Troubleshooting). If you see a stable frequency reading that is nowhere near 4908-4918 kHz, you may have installed the wrong crystals in the BFO (X3/X4).

When you're in frequency counter mode, the **BAND+** and **BAND-** switches can be used to check the range of the BFO. First, tap **BAND+** and write down the frequency reading below (typically about 4916-4917 kHz). Then tap **BAND-** and write down this frequency reading (usually about 4909-4912 kHz). Finally, calculate the BFO range (high - low) in kHz. Typical range is 4 to 6 kHz.

BFO High Freq. _____ (must be \geq 4916.3 kHz)

BFO Low Freq. _____ (must be \leq 4912.7 kHz)

Range (High - Low) _____ (must be \geq 3.6 kHz)

If your BFO range is less than 3.6 kHz, you may have the wrong varactor diodes installed at D37 or D38, or the wrong crystals installed at X3 or X4.

If the BFO frequencies are shifted too high or too low, it may be due to one of the following:

- If you didn't calibrate the K2's internal frequency counter using an external counter, it may not be reading accurately. If possible, borrow an accurate counter and re-do the **4 MHz Oscillator Calibration**.
- The BFO range shift could be due to the inductance of L33 being too high or too low. However, since L33 is supplied pre-wound and tested, this is unlikely.
- The leads of R116 may have been heated excessively during soldering, shorting out a portion of L33's turns.
- One of L33's leads could be broken. Look closely at the leads using a magnifying glass.
- One or more of the capacitors or varactor diodes in the BFO circuit could be of the wrong value.

BFO Alignment

The K2 uses a variable-bandwidth crystal filter, allowing the operator to set up as many as four filter bandwidths for each operating mode. Each of these filter configurations requires an appropriate BFO setting, which determines the pitch you hear.

Filter and BFO set up is done with the **CAL FIL** calibration function. **CAL FIL** is described in detail in the Operation section of the manual, under Calibration Functions. Rather than duplicate this information here, the instructions and example in the Operation section will be used.

- Make sure the bottom cover is securely attached.
- Tap **PRE/ATT** until the **PRE** annunciator is turned on. (Turning the preamp on will provide some background noise so you can hear the effect of changing filter bandwidths.)
- Follow all instructions on page 85 to become familiar with the **CAL FIL** function.
- Perform the steps in the example on page 86 to set up all filters. You'll use the filter and BFO data from Table 8-1 (for a CW-only K2), since the SSB adapter is not installed. If you later install the SSB adapter, you can easily change the settings to take advantage of the optimized, fixed-bandwidth SSB filter.

VFO Linearization

- Make sure the bottom cover is securely attached.
 - Allow the K2 to stabilize for at least 10 minutes at room temperature (approx. 20-25°C). (**Note:** Avoid using a high-wattage work lamp direct above the K2 during calibration. With the top cover removed, this could heat the RF board to a higher temperature than would ever be seen during normal operation.)
 - Connect the internal frequency counter cable to the VCO output test point (TP1).
 - Use the procedure listed below to linearize the VFO. If you see any **INFO** messages, refer to Troubleshooting.
1. Use **BAND+** or **BAND-** to select 40 meters. Select CW normal mode and filter FL1.
 2. Set the VFO to anywhere in the range 7000-7100 kHz.
 3. Enter the menu and select **CAL PLL**, then hold **EDIT** a second time to start the VFO linearization sequence.
 4. The frequency counter will show the VCO frequency as it decreases through a range of about 10-13 kHz. (The letter "d" will flash each time a calibration data point is stored.)
 5. When calibration is completed (4-8 minutes), you'll see the message **End** on the LCD. You can then tap any switch to return to normal operation. If you see an **INFO** message rather than **End**, refer to Troubleshooting (Appendix E).

I.F. Amplifier Alignment

L34, located near the right front corner of the RF board, is used to peak the output of the I.F. amplifier.

- Using the wide end of the plastic tuning tool, adjust the slug in L34 until it is near the top of the can. **Stop turning the slug when it appears to be at the top or when you feel resistance.**
- Turn L34's slug one full turn clockwise (down into the can).
- Set the band to 40 meters using **BAND+** or **BAND-**. Select CW Normal and FL2 (700 Hz nominal bandwidth).
- Make sure the RF GAIN control is fully clockwise (max. gain). Disconnect the antenna from J4, if one was connected.
- Tap **PRE/ATTN** until the PRE annunciator turns on.
- Connect a pair of headphones (stereo or mono) to the front panel jack, and turn the AF GAIN control to about midway.
- Slowly tune the VFO to locate the weak internally-generated signal near 7000 kHz. If you can't hear the signal at all, you may have a receiver problem. Try the 40-meter Band Pass Filter Alignment, below, then refer to Troubleshooting if necessary.
- While listening to the signal at 7000 kHz, adjust L34 for best signal strength and lowest noise. This setting occurs at about 1 to 1.5 turns below the top of the can. (You can use your DMM on AC volts, at the speaker jack, to obtain a more sensitive indication.)

40-Meter Band Pass Filter Alignment

- Connect an antenna or a signal generator to the antenna jack on the rear panel. If you use a signal generator, set it for approx. 7150 kHz at an output level of about -100 dBm, or strong enough to activate the S-meter. If you're using an antenna, tune in a signal in the range of 7100-7200 kHz. If you cannot find a signal, you can use atmospheric noise from the antenna to peak the filter.

- Using the plastic tuning tool, adjust both L1 and L2 (back left corner) for peak signal strength. You may be able to use the bargraph if the signal is strong enough. If you do not hear any signals or noise, see Troubleshooting.



In CW mode, the frequency shown on the display takes into account an offset equal to your sidetone pitch. This allows you to determine a station's actual carrier frequency by matching their pitch to your sidetone, rather than by zero-beating the signal. The **SPOT** switch can be used for this purpose.

This completes 40-meter receiver alignment. You may wish to become familiar with the K2's receiver features before proceeding (see Operation). In Part III you'll install the remaining band-pass filters and align the transmitter and receiver on all bands.

Assembly, Part III

In this final RF board assembly section you'll install the transmitter components, as well as the remaining band-pass and low-pass filters. This will allow you to align and test the K2 on all bands.

- Turn off the K2 and disconnect the power supply.
- Remove the two screws holding the Front Panel board to the Control board, then unplug the Control board. Use the long-handled Allen wrench as described in Part I.
- Remove the bottom cover.
- Remove the screws from the front panel assembly and unplug it from the RF board.
- Remove the side panels by taking out the two screws along the bottom edge of each panel.

Install the following 1/4-watt resistors, starting with R46 which is just to the left of I/O controller U1.

__ R46, 270 (RED-VIO-BRN) ⇒	__ R45, 47 (YEL-VIO-BLK)
__ R59, 4.7 k (YEL-VIO-RED)	__ R61, 120 (BRN-RED-BRN)
__ R49, 120 (BRN-RED-BRN)	__ R40, 470 (YEL-VIO-BRN)
__ R41, 560 (GRN-BLU-BRN)	__ R55, 33 (ORG-ORG-BLK)

__ R53, 4.7 ohms (YEL-VIO-GLD)
__ R56, 33 (ORG-ORG-BLK)
__ R54, 4.7 ohms (YEL-VIO-GLD)
__ R60, 100 ohms (BRN-BLK-BRN)
__ R62, 2.7 k (RED-VIO-RED)
__ R67, 1.5 k, 1% (BRN-GRN-BLK-BRN)
__ R68, 226 ohms, 1% (RED-RED-BLU-BLK)

 The 150 pF and 3.3 pF capacitors to be installed below may be hard to identify. See capacitor information on page 9.

Install the capacitors listed below. C12 is near the back left corner. Note: C13 and C14 will not be installed; they are included with the 160 m/RX Antenna option (K160RX).

__ C12, 560 (561) ⇒	__ C11, 1800 (182) ⇒	__ C26, .001 (102)
__ C16, 1800 (182)	__ C15, 560 (561)	__ C22, 3.3 pF (3.3)
__ C20, 47 (47)	__ C19, 330 (331)	__ C30, 470 (471)
__ C24, 47 (47)	__ C25, 330 (331)	__ C35, 56 (56)
__ C37, .001 (102)	__ C36, 470 (471)	__ C33, 2.2 pF (2.2)

__ C49, .001 (102)	__ C31, 56 (56)	__ C42, 330 (331)
__ C43, 33 (33)	__ C48, 330 (331)	__ C47, 33 (33)
__ C45, 1 pF (1)	__ C115, .01 (103)	__ C117, .047 (473)
__ C118, .01 (103)	__ C116, 33 (33)	__ C121, 0.01 (103)
__ C120, .01 (103)	__ C131, 0.1 (104)	

__ C124, 0.1 (104)	__ C130, 0.1 (104)	__ C128, 680 (681)
__ C129, .01 (103)	__ C127, 680 (681)	__ C191, 1800 (182)
__ C190, 1200 (122)	__ C197, 100 (101)	__ C198, 27 (27)
__ C210, 82 (82)	__ C211, 10 (10)	__ C218, 150 (151)

__ C219, 12 (12)	__ C138, .047 (473)	__ C222, 100 (101)
__ C221, 39 (39)	__ C220, 220 (221)	__ C214, 68 (68)
__ C213, 33 (33)	__ C212, 150 (151)	__ C203, 47 (47)
__ C199, 220 (221)	__ C200, 150 (151)	__ C202, 120 (121)
__ C201, 220 (221)	__ C192, 1200 (122)	

 There are two types of ceramic trimmer capacitors used in the band-pass filters: 30 pF and 50 pF. These may look identical. They will either be bagged separately, or the 50-pF trimmers will have a red marking.

Install the trimmers listed below, starting with C21 near the back-left corner. Orient the flat side of each trimmer capacitor with the flat side of its component outline. This orientation is required to prevent RF pickup during alignment.

__ C21, 50 pF	__ C23, 50 pF
__ C32, 30 pF	__ C34, 30 pF
__ C44, 30 pF	__ C46, 30 pF

Set all of the trimmer capacitors just installed to their mid-way points (see Figure 6-23). Use a small flat-blade screwdriver.

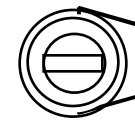

Figure 6-23

Install L5, a 33 μ H RF choke (ORG-ORG-BLK), near the back-left corner.

Install the following transistors, which are located near the I/O Controller (U1).

__ Q10, 2N7000	__ Q11, PN2222A	__ Q13, PN2222A
----------------	-----------------	-----------------

Ferrite-bead assemblies Z1 and Z2 will be installed vertically near transformer T3 as indicated by their component outlines. To make these assemblies, string two ferrite beads onto a 1" (25 mm) length of bare hookup wire (or discarded component leads) as shown in Figure 6-24.

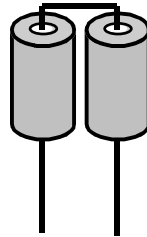

Figure 6-24

Install Z1 and Z2, bending the leads on the bottom of the board to hold them in place. Make sure that the beads are seated flat against the PC board, then solder.

Locate D9, the 1N5711 diode which you identified and set aside earlier. Install D9 near the right edge of the board.

Install electrolytic capacitors C126 (47 μ F) and C137 (100 μ F), Near the "ELECRAFT" label at the center of the board. Insert the (+) lead of each capacitor into the hole marked (+).

Install electrolytic capacitor C125 (22 μ F) which is near U1.

Install Q5 (2N5109). Be sure Q5 is firmly seated on the board and has its tab oriented as shown by the component outline before soldering.

Install the following components on the bottom of the board, working from left to right.

__ R63, 220 (RED-RED-BRN)

Note: bend the leads of R58 exactly as shown by its component outline.

__ R58, 180 ohms, 1/2 watt (BRN-GRY-BRN)

__ RFC8, __ RFC9, __ RFC4, 10 μ H (BRN-BLK-BLK)

__ RFC6, 0.68 μ H (BLU-GRY-SILVER)

__ RFC5, 10 μ H (BRN-BLK-BLK)

__ R50, 1.5 ohms, 1/2-watt (BRN-GRN-GLD)

__ R48, 120 (BRN-RED-BRN) __ R47, 47 (YEL-VIO-BLK)

__ R43, 22 (RED-RED-BLK)

__ R42, 4.7 ohms (YEL-VIO-GLD)

__ R44, 2.7 k (RED-VIO-RED)

Make sure you have separated the remaining slug-tuned shielded inductors into 1 μ H and 4.7 μ H types. Install these inductors in the order indicated below, on the top of the board. These inductors are difficult to remove once soldered, so double-check the part numbers. The 4.7 μ H inductors are labeled "T1005," and the 1 μ H inductors are labeled "T1050."

__ L3, 4.7 μ H ("T1005")

__ L4, 4.7 μ H

__ L8, 4.7 μ H

__ L9, 4.7 μ H

__ L10, 1 μ H ("T1050")

__ L11, 1 μ H

__ L12, 1 μ H

__ L13, 1 μ H

 TO-220 package transistors Q6, 7, and 8 look identical, but Q6 is different. Locate the two 2SC1969's (labeled "C1969"), Q7 and Q8, and set them to one side. The 2SC2166 transistor, Q6 ("C2166"), will be installed first.

- Attach a self-adhesive thermal pad to the PC board on top of the component outline for Q6. The hole in the thermal pad must be aligned precisely with Q6's mounting hole on the board.
- Prepare the leads of Q6 as you did with the voltage regulators on the Control board (Figure 4-4, page 16), using gradual bends to avoid lead breakage. Insert Q6 as shown by its component outline.
- Secure Q6 to the board using a 4-40 x 3/8" (9.5 mm) screw, #4 lock washer and 4-40 nut. The screw should be inserted from the bottom side of the RF board; the washer and nut go on the top.
- Verify that the body of Q6 is not touching the leads of any adjacent components, then solder.
- Wind and install each of the low-pass filter inductors listed below, starting at the back-right with L16 and L17 (80 meters). Wind each of the toroids using the core type and number of turns indicated (use red enamel wire). Review the toroid winding instructions and illustrations for RFC14 (Page 50).

___ L16	T44-2 (red), 21 turns	19" (48 cm)
___ L17	T44-2 (red), 21 turns	19" (48 cm)
___ L18	T44-2 (red), 9 turns	10" (25 cm)
___ L19	T44-2 (red), 8 turns	9" (23 cm)
___ L20	T44-2 (red), 7 turns	8" (18 cm)

Note: The black cores below are all of the powdered-iron (ceramic) type, not ferrite. If necessary you can identify them by measuring their diameter, which is 0.44" (11 mm), *not* 3/8" (9.5 mm).

___ L21	T44-10 (black), 9 turns	10" (25 cm)
___ L22	T44-10 (black), 8 turns	9" (23 cm)
___ L23	T44-10 (black), 11 turns	11" (28 cm)
___ L24	T44-10 (black), 10 turns	10" (25 cm)

 It is very important to wind and install toroidal transformers T1 through T4 exactly as described in the following steps. Remember that transformer windings are identified by numbered pairs of leads, which correspond to the PC board and schematic.

- T1 is wound on an FT37-43 ferrite core (dark gray) and has windings similar to those shown in Figure 6-25. The 1-2 winding is 9 turns of red enamel wire (10", 25 cm). The 3-4 winding is 3 turns of green enamel wire (5", 13 cm). (The drawing shows more than 9 turns on the larger winding.)
- Prepare T1's leads as in Part II. Completely remove the insulation to within about 1/8" (3 mm) of the core, then tin the leads.

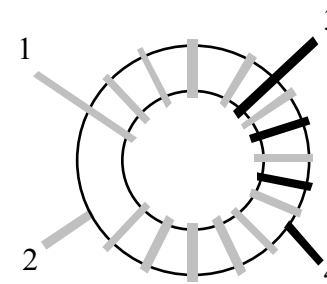

Figure 6-25

- Install T1 horizontally near Q5, inserting the leads into the matching numbered holes as indicated by the above illustration and by the component outline.

- T2 is wound on the same core type as T1 (FT37-43). Its windings must be spaced as shown in **Figure 6-26(a)**, with the 3-4 winding occupying about half the diameter of the core. T2's 1-2 winding is 12 turns of red enamel wire (13", 33 cm), and its 3-4 winding is 8 turns of green (9", 23 cm).
- Prepare T2's leads, but leave an extra 1/2" of insulation on leads 3 and 4 (green) as shown in **Figure 6-26(a)**.
- Fold the leads of T2's green winding (3-4) down and under the core as shown in **Figure 6-26(b)**.
- Install T2 horizontally, just to the right of Q6. To ensure that the leads do not contact any adjacent pads or components, T2 should be mounted so that it is elevated slightly above the board (about 1/16" [1.5 mm]).

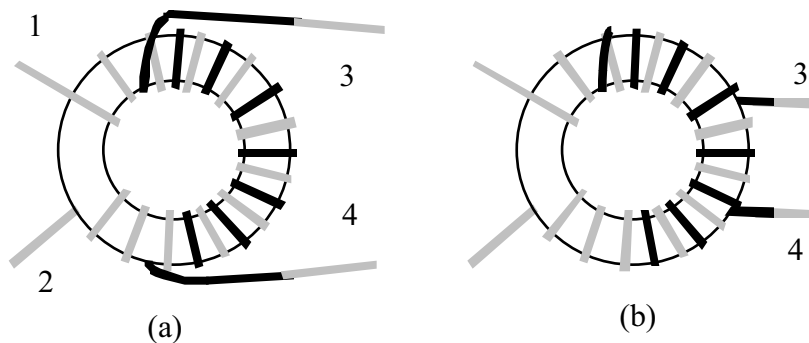

Figure 6-26

- Transformer T3 is mounted vertically, to the right of T2. The wires for the two windings must be twisted together before winding (bi-filar). First, cut two 10" (25 cm) lengths of enamel wire, one red, and one green. Then twist the wires together over their entire length. The wires should cross each other once every 1/2" or 1 cm.

- Wind the twisted wires onto a 1/2" (12.7 mm) dia. ferrite core (FT50-43), using exactly 5 turns and covering about 85% of the core. Figure 6-27 shows how the winding should look. The leads of T3 are labeled with letters A through D on the PC board to avoid confusing them with the numbered leads of T2 and T4.
- Separate T3's leads as shown in Figure 6-27. Strip and tin the leads, being careful not to let the red/green wire pairs short together.
- Install T3 vertically as shown by its component outline. T3 must be seated flat against the PC board, with its leads pulled tight on the bottom side.

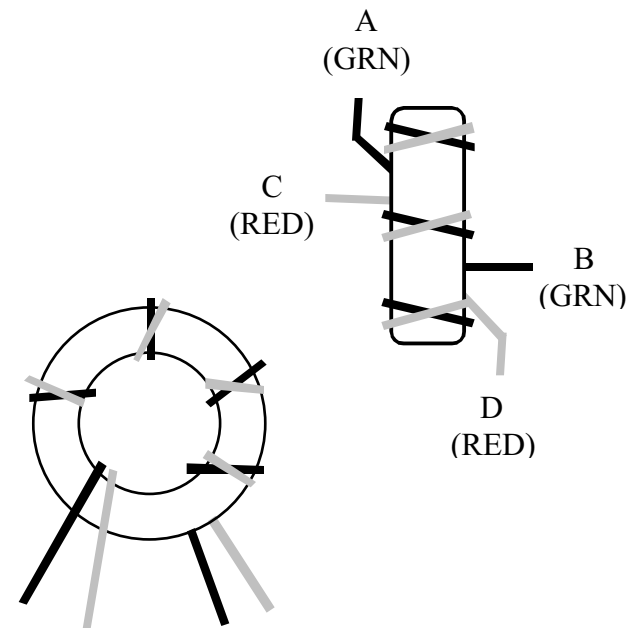

Figure 6-27

Locate the "binocular" (2-hole) ferrite core for T4. Wind 2 turns of **green-insulated hookup wire** (5", 13 cm) through the core as shown in Figure 6-28. This forms the 1-2 winding. (**Do not use enamel-coated wire.**)

Cut and strip the two leads using the lengths shown. Be careful not to nick the wire.

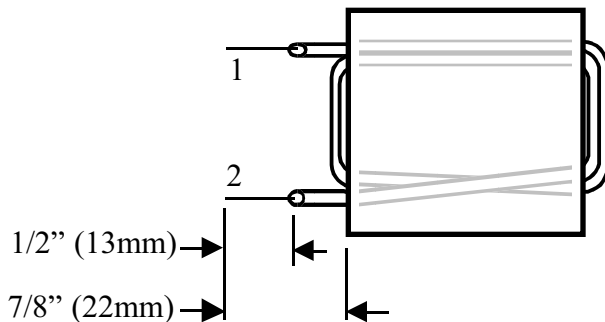

Figure 6-28

Wind a 3-turn winding (3-4) on top of the 1-2 winding, but with the wire starting and ending on the opposite side (Figure 6-29). Use 7" (18 cm) of **white-insulated hookup wire** (not enamel-coated wire). Prepare the leads in the same manner as above.

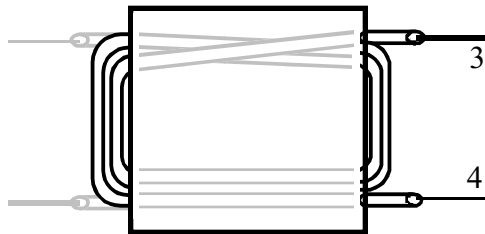

Figure 6-29

Before installing T4, verify that the screws holding the 2-D fastener beneath it are tightened, and that #4 internal-tooth lock washers were used. It is important that these screws not come loose sometime after T4 has been installed.

Install T4 to the right of T3, inserting leads for the 1-2 and 3-4 windings into their matching numbered holes. T4 should rest directly on top of the screws that secure the 2-D fastener beneath it. T4 should also be parallel to the board, not tilted to one side. Pull the leads taut on the bottom and bend them to hold the transformer in place. Do not solder T4 yet.

Use two 2" (5 cm) lengths of bare hookup wire to form the 5-6 and 7-8 windings on T4 (Figure 6-30). (These are more accurately described as *links*, each being just a single turn.) Route the bare wires through the core first, then bend them down and insert them into their numbered holes. Do not solder yet.

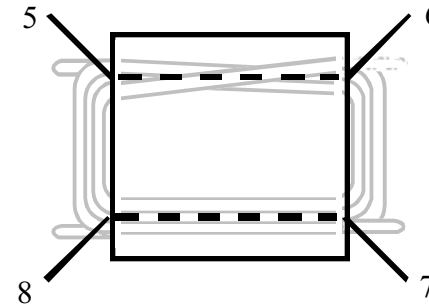



Figure 6-30

Adjust all of the windings of T4 as needed so that the transformer is positioned directly above its component outline. Pull the leads tight on the bottom, then solder.

Inspect all four transformers in the transmitter area closely, on both top and bottom, for shorts or cold solder joints.

 PA transistors Q7 and Q8 (2SC1969) must be installed on the *bottom* of the PC board, with their metal tabs facing away from the board, as explained in the following steps. Locate the component outlines on the bottom of the board before proceeding.

Prepare the leads of Q7 as shown in Figure 6-31. *Bend the leads upward, away from the tab--the opposite of the way you bent the leads of Q6.* Form the leads using the shaft of a small screwdriver to create gradual bends. Do not install Q7 yet.

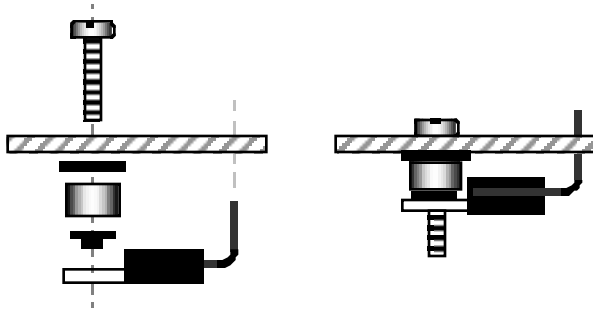



Figure 6-31

Insert a 4-40 x 1/2" (12.7 mm) screw through the PC board hole for Q7's tab (see Figure 6-31). Then slip the hardware listed below onto this mounting screw from the bottom side. (The shoulder washer can be found with the **MISCELLANEOUS** components.)

- ___ #4 fibre washer (black)
- ___ 1/4" (6.4 mm) dia., 1/8" (3 mm) long phenolic standoff (brown)
- ___ #4 nylon shoulder washer (black)

 Do not use any hardware other than that supplied. The height of the PA transistor assembly is critical for maintaining good heat dissipation.

Place Q7 on the bottom of the board so that the leads are inserted into the PC board as indicated by Q7's component outline. The mounting screw and hardware should appear as shown in Figure 6-31. Do not solder yet.

Make sure the smaller part of the shoulder washer is visible through the hole in Q7's metal tab.

Secure Q7 and its hardware temporarily using a 4-40 nut and #4 lock washer. Tighten the nut only finger-tight.

Once Q7 and its hardware appears to be parallel to the PC board as shown in Figure 6-31, solder Q7 on the top of the board.

Repeat the steps above for the other PA transistor, Q8.

Uninstalled Components

Check off the components in the list below, verifying that they are *not* yet installed. All of these components are on the top side of the board. **Note:** Most of these components are provided with option kits, as indicated in the list. Some of the connectors can be pre-installed, as will be explained on the next page.

- ___ J14 (near antenna jack); supplied with K160RX
- ___ C13 and ___ C14 (in 160 m band-pass filter); supplied with K160RX
- ___ C75 (synthesizer area); supplied with K160RX
- ___ J15 (3-pin connector in 40 m band-pass filter); supplied with K60XV
- ___ J13 (transverter conn., near 40 m band-pass filter); supplied with K60XV
- ___ D19 and D20 (synthesizer area); supplied with K60XV
- ___ P6 (near DC input jack); supplied with KAT2 or KPA100
- ___ P3 (near crystal filter); supplied with KBT2 or KPA100
- ___ J9, ___ J10, and J11 (near crystal filter); supplied with KSB2
- ___ J12 (near crystal filter); supplied with KNB2
- ___ J5 (near BFO crystals); reserved for future use



If you have already purchased option kits, you may install selected option components now, as explained in the following steps. This will simplify installation of the options after K2 alignment and test have been completed.

Do not remove the option bypass jumpers (W1, W2, etc.). The K2 must be aligned and tested before the jumpers are removed and option modules installed.

K160RX Component Installation (optional)

- Locate the **Installation** section of the K160RX kit manual.
- Cross out the first three steps (turning off the K2, removing hardware, etc.), which are not applicable since the K2 is already disassembled. Skip the next two steps. **Do not remove W1.**
- Complete the steps for J14 through C13 and C14.
- Cross out the next two steps (examination of Q7 and Q8). The remaining steps should be completed *after* alignment.

KSB2 Component Installation (optional)

- Locate **KSB2 Module Installation** in the KSB2 manual.
- Complete only the steps required to install J11, J9, and J10, and the standoff. **Do not remove W2, W3, or C167 at this time.** Complete the remaining steps after alignment.

Other Option Component Installation (optional)

- If you have the KAT2 (ATU) or KPA100 (Amplifier) option, install 2-pin connector P6. Use the option manual's instructions.
- If you have the KBT2 (Battery) or KPA100 option, install 2-pin connector P3. Use the option manual's instructions.

If you have the K60XV (60 meter) option, follow the instructions in the K60XV manual under "Pre-Installation During K2 Assembly".

If you have the KNB2 (Noise Blanker) option, locate the **Installation** section of the KNB2 manual. Complete only the installation of J12 and the standoff. **Do not remove W5, R88, R89 or R90 at this time.**

Visual Inspection

Examine the bottom (solder side) of the RF board carefully for unsoldered pins, solder bridges, or cold solder joints. Since this is a large board, you should break the examination up into three parts:

__ perimeter area __ front half __ back half

Examine the top (component side) of the RF board for unsoldered pins, solder bridges, or cold solder joints. This step is necessary because some components are installed on the bottom of the board and soldered on top.

Make sure switch S1 on the RF board is in the OFF position. (Plunger OUT is OFF.)

Resistance Checks

Perform the following resistance checks.

Test Point	Signal Name	Res. (to GND)
Q7 collector	12V	> 500 ohms
Q6 base	Driver bias	100-140 ohms
Q7 base	PA bias	2.5 - 3.0 k
U11 pin 8	8A	> 250 ohms
U10 pin 8	8T	> 500 ohms
U12 pin 1	8R	> 500 ohms

- Install the two side panels and secure with two chassis screws each as you did in Part I and Part II.
- Plug in the front panel assembly and make sure the connectors are completely mated. Secure the front panel with four chassis screws.
- Verify that all components on the bottom of the RF board have an installed height of 1/4" (6 mm) or less. Capacitors that stand above this height must be bent downward so that they won't hit the bottom cover or heat sink.
- Install the bottom cover and secure it using six chassis screws.
- Plug in the Control board. Make sure that all three connectors are completely mated.
- Secure the front panel and Control boards together using two chassis screws.
- Locate the heat sink panel. Remove any masking tape, including the large piece that covers several holes.
- Attach two round rubber feet to the heat sink using 4-40 x 7/16" (11 mm) screws, #4 lock washers, and 4-40 nuts. The screws are standard steel/zinc-plated, not black anodized. The nuts go on the *inside* surface of the heatsink. (The rubber feet can be found with the **MISCELLANEOUS** items.)
- Remove the finishing nuts and washers from the shafts of the antenna and key jacks. They will be re-installed later.
- Turn the K2 up on its left side. This will keep the PA transistor screws from slipping out during the following steps.
- Remove the 4-40 nuts and #4 lock washers from the mounting screws for Q7 and Q8, but do not pull the screws out. (If you pull these screws out, the associated hardware will fall off and will have to be re-installed.)



In the next step you'll install thermal insulation pads on the power amplifier transistors, Q7 and Q8. These pads must be positioned correctly to keep the collectors of the transistors from shorting to ground. Proper positioning is also required to guarantee good heat conduction.

- Place self-adhesive thermal pads on top of Q7 and Q8 as shown in Figure 6-32, with the hole in the pad centered over the hole in the transistor tab. *The adhesive side must be in contact with the transistor.*

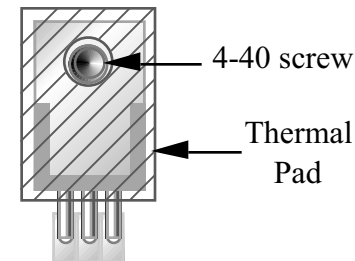

Figure 6-32

- Back out the mounting screws for Q7 and Q8 until the ends of the screws protrude only slightly from the transistor tabs. Keep the K2 on its left side so the screws don't slip out further.
- Make sure that the thermal pads on Q7 and Q8 are centered, and that you can see the shoulder washers inside the tab holes. If the shoulder washers have come out of the tab holes, re-align the PA transistor hardware as needed.

- Keeping the K2 on its left side, slip the heat sink over the rear-panel connectors and into position (Figure 6-33). Figure 6-34 shows how the heat sink and associated hardware appear in cross-section.

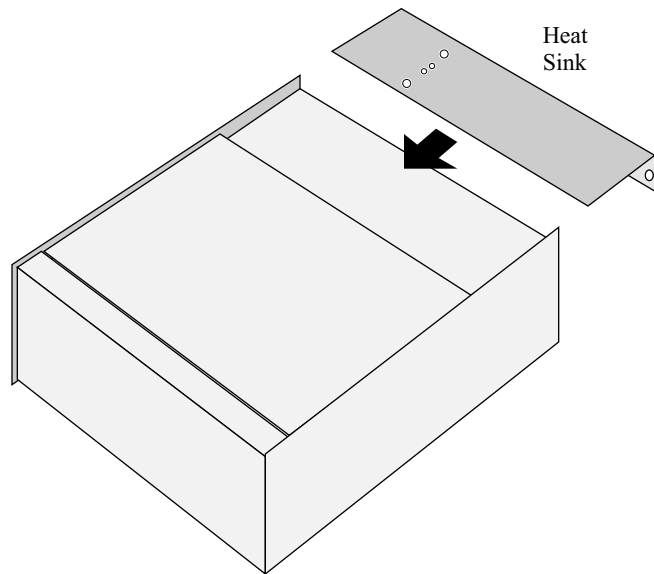

Figure 6-33

- Make sure that the four small holes in the heat sink line up with Q7/Q8 and the 2-D block between them.
- Press the Q7/Q8 mounting screws all the way back in so that they protrude from the heat sink.
- Use two chassis screws and two #4 lock washers to secure the heat sink firmly to the 2-D fastener.

- Secure Q7 and Q8 on the bottom of the heat sink using 4-40 nuts and #4 lock washers. *Do not over-tighten the nuts, as this may cause the thermal pads to scrape against the heat sink, possibly causing a short to ground.*

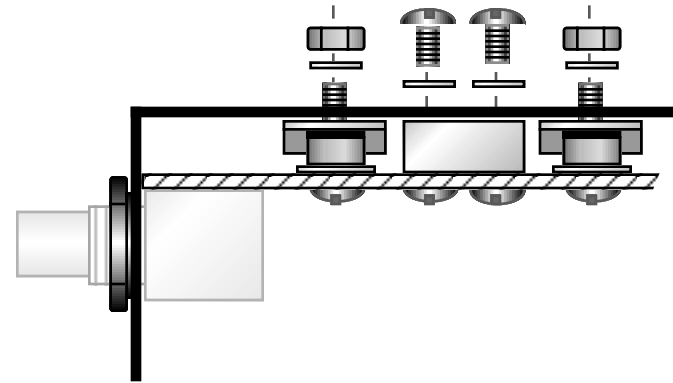

Figure 6-34

- Using an ohmmeter on a low resistance scale, check for a short from Q7 or Q8 collector to ground. (This test should also be performed any time the heat sink is removed and re-installed.) If a short is measured, remove the heat sink and investigate the cause. The most likely reason for a short is mis-alignment of a shoulder washer or thermal pad. *If a thermal pad or shoulder washer is damaged, it must be replaced.*
- There are four more #4 holes in the heat sink: two on the bottom and two on the back panel. Use four chassis screws to secure the heat sink to the side panels and RF board at these locations. You may need to adjust the positions of the 2-D fasteners on the side panels slightly.
- Install the washers and finishing nuts that you removed earlier from the antenna and key jacks. (The antenna jack hardware is shown installed in Figure 6-34.)

Alignment and Test, Part III

In this section you'll complete alignment and test of the K2 on all bands.

- Make sure the power switch, S1, is in the OFF position (out).
- Connect your power supply or battery. For transmitter tests, a battery or well-regulated power supply that can handle at least 2 amps is recommended. Avoid using a switching power supply unless it is well shielded and includes EMI filtering. A linear-mode supply will typically generate much less noise in the HF bands. (See any recent *ARRL Handbook* for examples of both types.)
- Connect a 50-ohm dummy load to the antenna jack. The dummy load should be rated at 10 watts or higher.
- Connect a pair of headphones and a key or keyer paddle.
- Set the POWER control fully counter-clockwise (minimum power output).
- Turn on the K2. You should see **ELECRAFT** on the LCD, followed by the frequency display.

- Select voltage/current display mode by tapping **DISPLAY** to make sure the receiver is not drawing excess current. (Typical current drain will be 180-250 mA depending on menu settings.)
- Return to frequency display mode.
- Switch to CW and select FL1 using **XFIL**.
- Use the menu to set up the desired CW sidetone volume and pitch if you have not already done so, using **ST L** and **ST P**. The pitch can be set from 400 to 800 Hz, although 500-600 Hz is recommended. The sidetone volume and tone will vary a small amount as the pitch is changed, but it should have a pleasant sinewave sound at any setting.
- Set up the desired keying device using **INP**. If you're using a hand key or external keyer, use **INP HAND**. To use the internal keyer, select **PDLn** or **PDLr** (normal or reverse paddle). You can also connect a computer or external keyer along with the keyer paddle. Refer to the Operation section for details on this "auto-detect" feature (Page 92).
- To verify that the sidetone is functioning, hold the **SPOT** switch. Tap any switch to turn the SPOT tone off.

40-Meter Transmitter Alignment



To align the transmitter you'll need some means for monitoring power output as you adjust the band-pass filters. An analog wattmeter or oscilloscope is ideal. However, in the instructions that follow we'll assume that you're using the K2's built-in digital wattmeter, which will also provide satisfactory results.

- Set the POWER control for 2.0 watts.
- Switch to the 40 meter band and set the VFO for about 7100 kHz.
- Locate the 40-meter band-pass filter inductors, L1 and L2, and be prepared to adjust them using the wide end of the tuning tool.



In the following steps you'll place the K2 into "TUNE" mode by holding **TUNE**. You should limit key-down periods to about 5 or 10 seconds during tune-up for safety reasons. If you see or smell smoke turn the K2 off and refer to Troubleshooting.

Note: While in tune mode, it is normal to see power drift upward several tenths of a watt. You may also see a sudden jump in power during alignment. The output will quickly be reduced to about 2.0 W by the firmware if this happens.

- Put the K2 into tune mode and activate the built-in wattmeter by holding **TUNE**. Using the alignment tool, adjust L1 for maximum output. Tap any switch to exit TUNE mode.
- Enter tune mode again and adjust L2 for maximum output. Tap any switch to exit.

- If necessary, repeat the adjustment of L1 and L2 two or three times to be sure that you have the inductors peaked correctly. If you cannot get power output to 2.0 watts or higher, see Troubleshooting.
- Make sure the bar graph is set for **DOT** mode using the **GRPH** menu entry.
- Set power output to 5.0 W using the POWER control.
- Tap **DISPLAY** to enter voltage/current display mode. When this display is selected, you can use **TUNE** to check your voltage and current in transmit mode.
- Enter tune mode and note the change in voltage and current. Current drain at 5 watts is typically 1.3 to 1.6 amps.¹⁰ If the current reading is much higher than this, or if the voltage drops more than 1 V, you may have a problem in the transmitter, load, or power supply (see Troubleshooting).
- Return to frequency display using the **DISPLAY** switch.
- Set the POWER control for 10.0 watts.
- Enter tune mode just long enough to verify that the wattmeter reads approximately 10 watts. If you then switch to voltage/current display and hold **TUNE** again, you should see a current drain of typically 1.8 to 2 amps. If you see a "HI CUR" warning message (high current), use CAL CUR to set your transmit current limit higher. If current is much higher than 2 A, see Troubleshooting.

This completes transmitter alignment and test on 40 meters.

¹⁰ The K2 transmitter is most efficient at 10 watts and higher; current drain at 5 watts CW may be higher than expected. This is unavoidable because the K2 is capable of up to 15 W output. Also, for a given power level, SSB transmission requires more transmitter "overhead" to prevent distortion.

Receiver Pre-Alignment

Since the same filters are used on both receive and transmit, it is possible to align all the remaining bands on transmit only. However, you can pre-align the filters on receive by using a signal or noise generator, separate ham transceiver, or on-air signals and atmospheric noise. This pre-alignment on receive will make transmitter alignment easier, since the filter adjustments will already be at or close to their final values.

- Switch to 80 meters and set the VFO for about 3750 kHz (mid-band). Turn on the RF preamp by tapping **PRE/ATTN** until you see the PRE annunciator turn on.
- Use a signal generator or an antenna to inject a signal or noise at this frequency.
- Adjust L3 and L4 for maximum signal strength.



Since some inductors are shared between two bands, you must always align the remaining bands in the order indicated. Always use this procedure if you re-align the filters later.

- Switch to 20 meters (14100 kHz) and turn on the preamp. Set C21 and C23 to their mid-points. Adjust L8 and L9 for maximum signal strength. (This step pre-sets C21, C23, L8, and L9 before final adjustment in the next two steps.)
- Switch to 30 meters (10100 kHz) and turn on the preamp. Adjust L8 and L9 for maximum signal strength.
- Switch back to 20 meters (14100 kHz). Adjust C21 and C23 for maximum signal strength.
- Switch to 15 meters (21100 kHz) and turn on the preamp. Adjust L10 and L11 for maximum signal strength.
- Switch to 17 meters (18100 kHz) and turn on the preamp. Adjust C32 and C34 for maximum signal strength.
- Switch to 10 meters (28200 kHz) and turn on the preamp. Adjust L12 and L13 for maximum signal strength.
- Switch to 12 meters (24900 kHz) and turn on the preamp. Adjust C44 and C46 for maximum signal strength.

This completes receiver alignment.



During receiver alignment, you may have noticed that signal strength is somewhat lower in volume when you select the narrowest filter (100 Hz setting, FL4). This is because the K2's crystal filter is optimized for wider bandwidths (250-800 Hz). Despite the slightly greater attenuation, the narrower settings are very useful in reducing QRM (interference) from strong, nearby signals. (Any of the filter settings can be changed, and FL2-FL4 can even be turned OFF. See page 85 for information on customizing filter settings.)

Transmitter Alignment

If you did the receiver alignment, above, you may find that little or no transmit adjustment is required on most bands.

- Set the POWER control for 2.0 watts.
- Switch to 80 meters and set the VFO for about 3750 kHz (mid-band).
- Enter tune mode and adjust L3 and L4 for maximum power as indicated on the internal wattmeter. (Use a more sensitive analog instrument if available.) Limit tune-up time to 5 or 10 seconds.



Since some inductors are shared between two bands, you must always align the remaining bands in the order indicated. Always use this procedure if you re-align the filters later.

- Switch to 20 meters (14100 kHz). Set C21 and C23 to their mid-points. Adjust L8 and L9 for maximum power output. (This step pre-sets C21, C23, L8, and L9 before final adjustment in the next two steps.)
- Switch to 30 meters (10100 kHz) and adjust L8 and L9 for maximum power output.
- Switch to 20 meters (14100 kHz) and adjust C21 and C23 for maximum power output.
- Switch to 15 meters (21100 kHz) and adjust L10 and L11 for maximum power output.
- Switch to 17 meters (18100 kHz) and adjust C32 and C34 for maximum power output.
- Switch to 10 meters (28200 kHz) and adjust L12 and L13 for maximum power output.
- Switch to 12 meters (24900 kHz) and adjust C44 and C46 for maximum power output.

This completes transmitter alignment.

7. Final Assembly

Place the top cover upside down as shown in Figure 7-1, with its rear panel facing away from you. The illustration shows how the speaker, 2-conductor cable, external speaker jack and other hardware will be attached to the top cover.

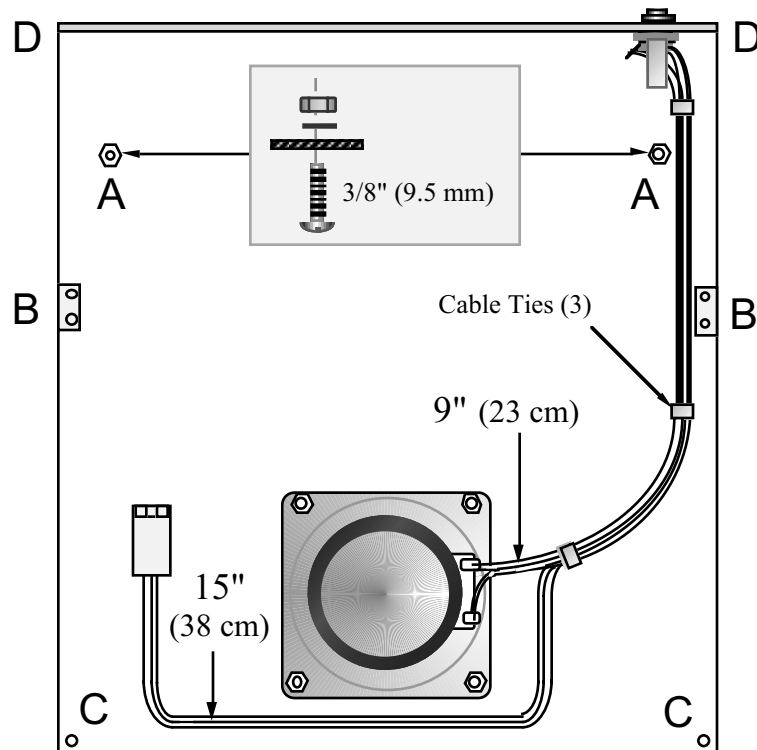

Figure 7-1

- Trim the supplied grille cloth to the size of the speaker frame.
- Place #4 fibre washers (black) at each of the top cover's four speaker mounting holes (Figure 7-1). Trim the corners of the grille cloth so it just fits between the fibre washers, not touching them.
- Place the speaker on top of the fibre washers and grille cloth. Secure it with four 3/8" (9.5 mm) screws, #4 lock washers, and 4-40 nuts (Figure 7-2). Do not over-tighten the nuts.

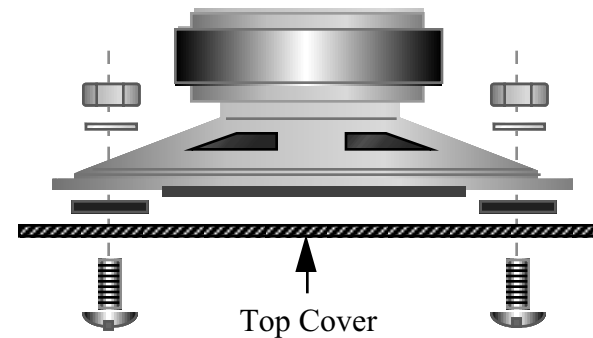

Figure 7-2

- Locate the two holes marked **A** in Figure 7-1. Use two 4-40 x 3/8" (9.5 mm) screws to fill these holes, securing them with #4 lock washers and 4-40 nuts. (The holes are for the battery option.)
- Install 2-D fasteners at the two locations marked **B** in Figure 7-1. The 2-D fasteners should line up exactly with the edges. Use two chassis screws per 2-D fastener.

Using a sharp tool, cut through and peel off about 1/2" x 1/2" (12 x 12 mm) of the masking material covering the EXT SPKR hole. **Note:** Leave the other holes covered with masking material until the associated options are installed.

Install the external speaker jack in the EXT SPKR hole. Orient the jack as shown in Figure 7-1 and Figure 7-4, with the "AF" tab nearest the inside of the top cover. (**Caution:** Misidentification of the three tabs could result in a ground short.)

24" (61 cm) of 2-conductor speaker cable is supplied. Cut it into two pieces, 15" (38 cm) and 9" (23 cm) long.

Solder crimp pins to the two wires at one end of the 15" (38 cm) length of speaker cable (Figure 7-3).

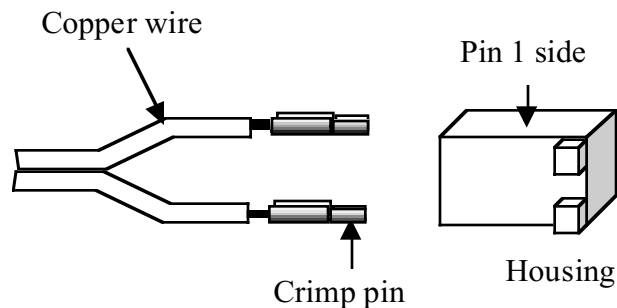

Figure 7-3



When you insert crimp pins into the housing in the next step, they should snap into place. Each pin has a small tab on the back that latches into a hole in the housing when inserted.

Insert the copper wire into the pin 1 position of a two-pin housing as shown. Insert the other wire into the pin 2 position.

Connect the other end of this cable to the external speaker jack as shown in Figure 7-4. The copper wire must be connected to the "AF" lug of the speaker jack. Solder only the copper wire.

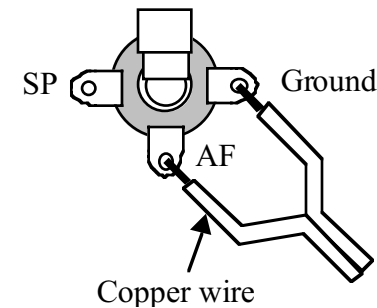

Figure 7-4

Connect one end of the 9" (23 cm) speaker cable to the speaker terminals. The copper wire should be connected to the lug marked (+) on the speaker. Solder both wires.

Connect the other end of this cable to the external speaker jack as shown in Figure 7-5. The copper wire must be connected to the lug marked "SP" below. Solder all three lugs.

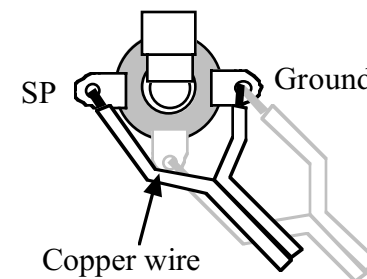

Figure 7-5

Use three cable ties at the points shown in Figure 7-1 to hold the speaker cables in place. (Save the fourth cable tie for use with the supplied RF probe.) The ties should be pulled tight. Trim any excess cable tie length.

Finishing Touches

- Examine the Control board one last time to be sure that it is correctly plugged into the RF board. All three connectors must be mated completely.
- Leave the frequency counter test cable connected to the BFO test point (TP2). This will allow you to modify your filter and BFO settings if necessary during normal operation.
- If there are any missing chassis screws in the bottom cover, heat sink, side panels, or front panel, install them now.
- Plug the internal speaker cable into P5 on the RF board, just behind the on-off switch, S1. The connector is keyed and can only be plugged in one way.



Even if you have purchased some K2 options, you should not assemble and install them yet. The option manuals assume that you are familiar with basic K2 operation.

- Remove the masking material from the two top-cover mounting holes marked **C** in Figure 7-1.
- Cut through and peel off about 1/2" x 1/2" (12 x 12 mm) of masking material from around the top-cover mounting holes marked **D** in Figure 7-1. These holes are in the far corners of the top cover's rear panel, corresponding to screws **1** and **2** in Figure 7-6.
- Place the top cover onto the chassis and secure it using six chassis screws as shown in Figure 7-6.



When removing the top cover in the future, take out only the six screws shown in Figure 7-6.

- Attach the self-adhesive serial number label to the rear panel of the heat sink in the space provided.
- Write the serial number on the inside cover of your manual.

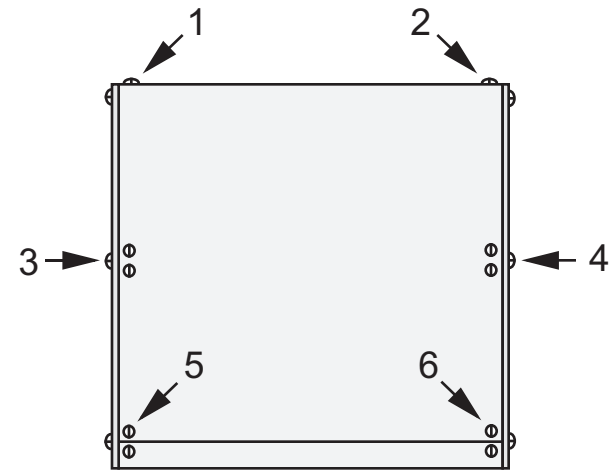

Figure 7-6

This completes assembly of your K2. Please read the Operation section, which follows, and try each of the K2's features.



If you did not have access to a frequency counter or calibrated receiver when aligning the 4-MHz oscillator, you may wish to use the one of the alternative VFO calibration techniques described in the Operation section (page 98). You can use an on-air signal, such as WWV at 10 MHz, to obtain better than +/- 50 Hz VFO dial calibration on all bands.

8. Operation

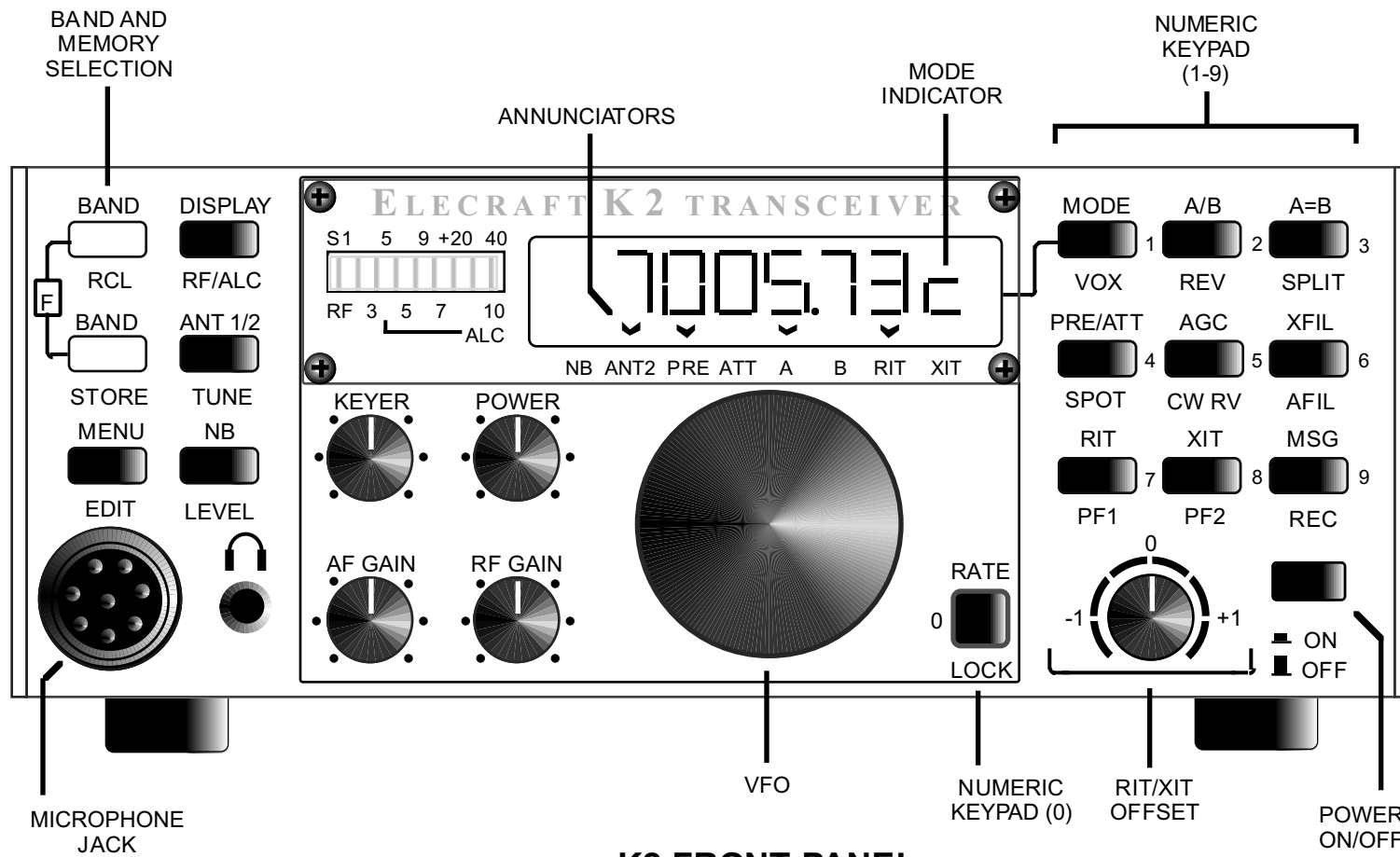

K2 FRONT PANEL

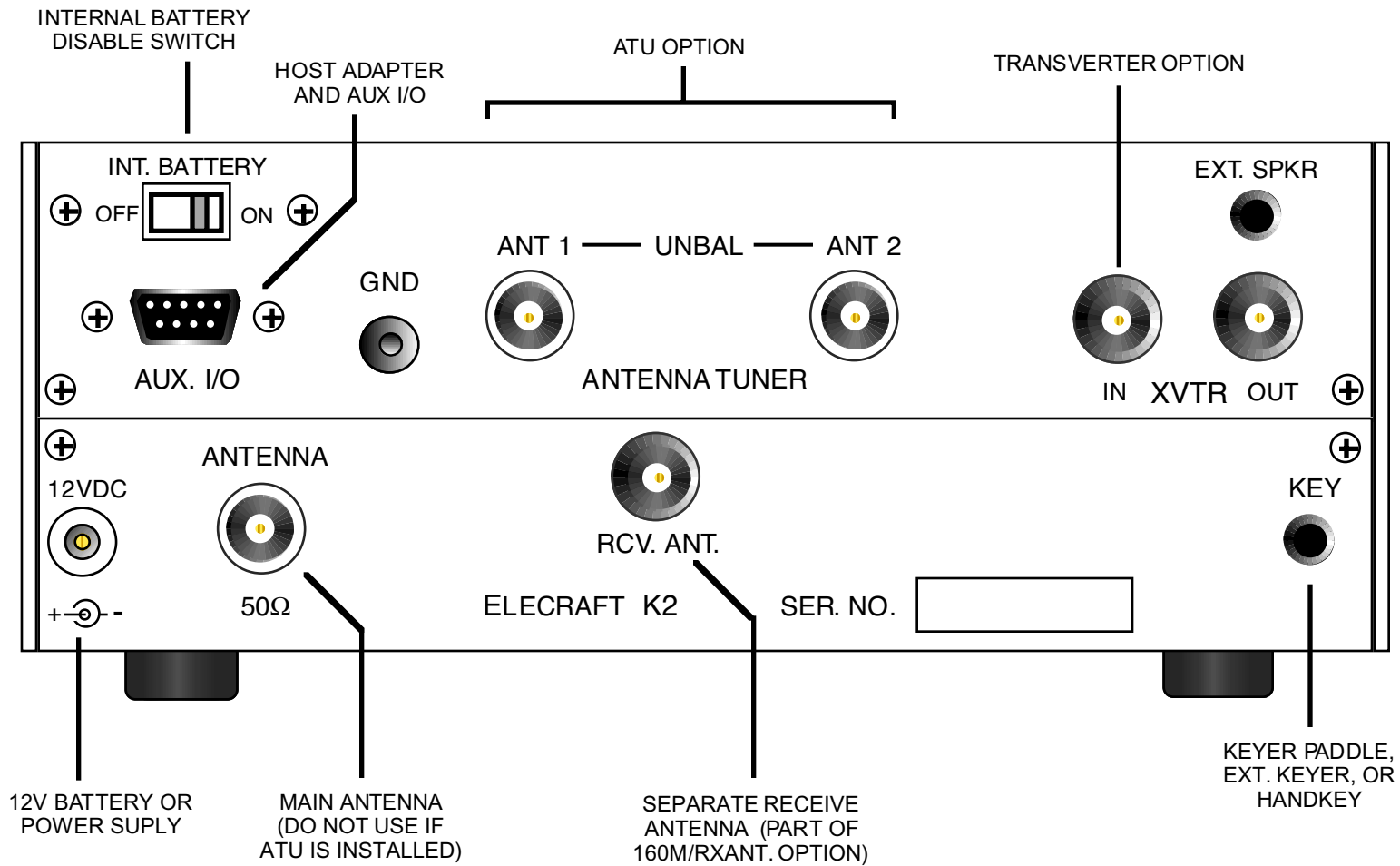

K2 REAR PANEL

This section of the manual explains how to set up and operate the K2. Refer to the K2 FRONT PANEL and REAR PANEL illustrations on the previous pages for control locations.

Connections

Power Supply

You can power the basic K2 (without the KPA100 amplifier) from any 9-15 V DC power supply. A mating connector for the DC input jack is provided with the kit. Current drain is typically 1.5-2 A on transmit, but can be over 3 A at the highest power settings or with high SWR. (See Current Limiting, below.)

Internal Battery: An optional 12 V, 2.9-Ah rechargeable battery can be installed inside the K2 (model KBT2). A 14.0 V power supply can then be used to recharge the battery *and* power the transceiver. If an external battery is connected, the internal battery must be disabled using the INT BATTERY switch (rear panel). This will prevent undercharging of the internal battery.

Low Battery Warning: If the battery (or power supply) voltage drops below about 11 V, you'll see a brief **LO BATT** message flashed on the LCD once every 8 minutes (approx.). If this happens, you should reduce power and recharge your battery as soon as possible. For tips on extending battery life, see page 97.

Self-Resetting Fuse: If the K2's internal 12 V line is shorted to ground, fuse F1 will temporarily open, limiting current drain to about 100 mA. The display will remain blank. If this happens, turn power off until the problem is located and corrected.

Current Limiting: You can specify the maximum transmit current (see **CAL CUR**, page 84). You'll see **HI CUR** on the LCD if the programmed limit is reached.

50/60-Hz Interference: Do not place the K2 beside, or on top of, any equipment that uses a large AC power transformer. This could result in modulation of the K2's low-level signal sources.

Antenna

A well-matched antenna (50 Ω) or an antenna tuner should be used with the K2. Some high SWR conditions may result in excessive current drain unless power is reduced.

If you have the KAT2 antenna tuner option installed, the K2's power control and power output display will be much more accurate under all SWR conditions.

Keying Devices

Any type of hand key, bug, or external keyer can be plugged into the KEY jack, or you can use the K2's built-in memory keyer. In all cases, you must use a stereo plug with the keying device (a suitable plug is provided with the kit). Also see CW Operation (page 92).

Microphone

A standard 8-pin microphone jack is provided on the front panel. A jumper block on the front panel PCB is used to configure the mic jack for specific microphones. Refer to the SSB adapter manual.

Headphones

Any type of mono or stereo headphones at nearly any impedance will work with the K2. However, for best results we recommend high-quality stereo headphones with full ear covers and 1/8" (3 mm) plug.

External Speaker

The K2 has a built-in, high-sensitivity 4-ohm speaker. You can also plug in an external 4 or 8-ohm speaker at the "EXT. SPKR" jack.

Option Connectors

A number of mounting holes are provided on the back panel of the K2 for specific option connectors. See Options (page 110).

Controls and Display

LCD and Bargraph Meter

The LCD shows the operating frequency and other information depending on selected display mode. The LED bargraph functions as an S-meter on receive, and RF out or ALC meter on transmit.

Power-Up Messages: The LCD will display **ELECRAFT** for two seconds on power-up. If a problem is detected, the display will show **INFO 100** or a similar message. The number shown corresponds to a paragraph in the Troubleshooting section.

Mode Indicator: A letter at the right end of the display tells you the operating mode: **C** (CW), **L** (LSB), or **U** (USB). A fourth mode, RTTY/data, can also be enabled, and uses the letter **r** (page 101). If a small bar appears above the **C** or **r**, it means that the CW sideband is inverted (*CW reverse* or *DATA reverse*). The mode indicator will also flash slowly in two cases: CW **TEST** mode (see page 93) and **SPEECH** (VOX) mode (see page 95).

Annunciators: The LCD provides eight Chevron-shaped *annunciators*, or status indicators:

NB	noise blanker on (flashes if Low Threshold setting is selected using LEVEL)
ANT2	ant. 2 selected (requires ATU)
PRE	pre-amp on (approx. +14 dB)
ATTN	attenuator in (-10 dB)
A	VFO A selected (flashes in SPLIT mode)
B	VFO B selected (flashes in SPLIT mode)
RIT	RIT turned on (flashes if wide range selected)
XIT	XIT turned on (flashes if wide range selected)

Decimal Points: The decimal point to the right of the 1 kHz digit will flash slowly if the VFO is locked by holding **LOCK**. See Advanced Operating Features for other cases where decimal points flash (scanning, page 96; AGC OFF, page 97).

SPLIT/RIT/XIT LED (Optional)

You can install an LED on the front panel that will turn on whenever SPLIT, RIT, or XIT is in effect. See the associated application note, [Adding a SPLIT/RIT/XIT LED to the K2](#).

Potentiometers

AF GAIN receiver audio level

RF GAIN receiver RF level¹¹

Turning this control CCW (counter-clockwise) decreases receiver RF sensitivity. At the same time it *increases* the bargraph S-meter indication to remind you that you're not at full receive sensitivity. The farther CCW the control is set, the stronger a signal must be before it results in a meter deflection.

KEYER keyer speed control

When you turn this control, keyer speed in words per minute (WPM) will be displayed, e.g. **SPD 18**. The speed can be set from about 9 to 50 WPM.

POWER power output control

When you turn this control, power output will be displayed in watts, e.g. **P 5.0**. The range is 0.1 to 15 W for the basic K2, and 1 to 100 W if you have the KPA100 amplifier installed. See Basic K2 Operation for details on controlling power output (page 90).

OFFSET RIT/XIT offset

This control provides a default range of +/- 0.6 kHz in 10 Hz steps when **RIT** and/or **XIT** are enabled. You can also select a wider RIT/XIT range (see **RIT** menu entry, page 101).

¹¹ As in many transceivers, this control actually varies the I.F. gain.

Switch Functions

Each pushbutton switch as two primary functions, indicated by the upper and lower labels. **TAP** a switch to access its upper function; **HOLD** a switch for over 1/2 second to access its lower function.

Numeric Keypad: In addition to their tap/hold functions, ten of the switches are labeled with digits 0 through 9. A digit can be entered using either a TAP or HOLD (e.g. **5**, or **5**). In some cases the difference between the two is significant, as indicated below.

Tap and Hold Functions

BAND+ RCL	select next higher band recall memory # 0-9 (to start scan, use # 0-9)
BAND- STORE	select next lower band store memory # 0-9 (to start scan, use # 0-9)
MENU EDIT	enter the menu edit current menu parameter
DISPLAY RF/ALC	select display mode (freq., voltage/current, time*) select SSB transmit bargraph mode (RF or ALC)
ANT1/2 TUNE	toggle between ATU antenna jacks 1 and 2* key transmitter; activates ATU if installed
NB LEVEL	select noise blanker mode (OFF/NB1/NB2)* toggle noise blanker threshold (low or high)*
RATE LOCK	select VFO tuning rate (see RATES menu entry) lock/unlock VFO (DP flashes)
MODE VOX	select operating mode (CW/LSB/USB) CW: oper/test; SSB*: PTT/speech 0.4/speech 1.0

*These functions require option modules; see page 110.

PRE/ATT SPOT	turn on preamp or attenuator CW audio spot signal on/off
RIT PF1	turn on RIT (see RIT menu entry, page 101) activate programmable function 1
A/B REV	select A or B VFO temporary A/B VFO swap (used in SPLIT)
AGC CW RV	select FAST/SLOW AGC toggle between CW norm/reverse or USB/LSB
XIT PF2	turn on XIT (see RIT menu entry, page 101) activate programmable function 2
A=B SPLIT	set both VFO's to current VFO frequency toggle between SPLIT and NORMAL transceive
XFIL AFIL	select next crystal filter (FL1-4) audio filter mode (OFF, AF1, AF2)*
MSG REC	play or chain CW msg # 0-8 (to repeat, use # 0-8) record CW message # 0-8 (MSG cancels record)

Two-Switch Combinations

Press and *hold* the two indicated switches simultaneously:

BAND+ + BAND-	direct frequency entry (e.g., # 7 0 4 0)
PRE/ATT + AGC	AGC on/off (mode letter dec. pt. flashes)
XFIL + AGC	display crystal filter # and bandwidth (plus audio filter setting, if applicable*)
DISPLAY + TUNE	override ATU TUNE power limit*
RIT + XFIL	turn FINE RIT on/off (see page 99)

Using the Menu

There are two menus: *primary* and *secondary*. You'll use the primary menu far more often; see list at right. The secondary menu is described starting at page 100.

To access the menu: Tap **MENU**. The display will show the *menu entry* last used, with an underline. For example, you might see: **LCD DAY**, indicating that the LCD is in "day" mode (i.e., backlight off). You can scroll to a desired menu entry by turning the VFO knob or by tapping the **BAND+** and **BAND-** switches.

To modify a menu entry's parameter: Hold **EDIT** to move the underline to the parameter, rather than the menu entry name. In the case of **LCD**, the parameter can be **DAY** or **NITE**. Change the parameter using the VFO knob or **BAND+**/**BAND-**. When you're finished, tap **MENU** to return to scrolling. Another tap of **MENU** will return you to normal operation.

DISPLAY Switch Usage in EDIT Mode: The **DISPLAY** switch is used to access supplemental parameters when editing certain menu entries (marked "*" at right). You will normally not need to change these settings. Entries which use **DISPLAY** include:

Entry	DISPLAY Switch Usage in EDIT mode
ST L	Selects the sidetone source, U6-25 or U8-4 . Use U8-4 (default) with the revision B RF board.
T-R	Specifies "8R" behavior, 8r hold or 8r nor . "Hold" mode (default) holds the 8R line low during the user-programmed QSK delay.
INP	Selects <i>auto-detect</i> mode, ADET On (default) or ADET Off .

EDIT Shortcut: If the menu entry you want to change is the last one used, you don't need to tap **MENU**; just hold **EDIT**. Change the parameter as usual, then exit by holding **EDIT** once more.

Primary Menu Functions

All primary menu functions are listed below (secondary menu functions are listed on page 100). Supplemental parameters accessed with **DISPLAY** are marked (*); see explanation at left.

ST L	sidetone level (volume): 0-255 (Tone Source*)
ST P	sidetone pitch: 0.40 to 0.80 kHz in 10 Hz steps
T-R	QSK delay: 0.00 to 2.55 sec. (8R Mode*)
RPT	CW message repeat interval: 0 to 255 seconds
INP	CW input selection (Auto-detect on/off*): PDLn (internal keyer/norm. w/auto-detect ¹²) PDLr (internal keyer/reversed w/auto-detect) HAND (hand key or external keying device)
IAB	iambic mode: A or B
SSBA	SSB audio level (mic gain): 1, 2, 3 , or BAL
SSBC	SSB speech compression level: 1-1 through 4-1 ; in RTTY/data mode, a separate compression level is provided, and the menu entry is SSBCr
LCD	DAY (backlight off, bargraph bright) or NITE (backlight on, bargraph normal)
GRPH	LED bargraph selection: OFF, DOT, BAR (OPT BATT overrides GRPH BAR , forcing DOT mode)
OPT	receiver optimization: PERFORMANCE or BATTERY (see page 97)
ATU	ATU operating mode
RANT	RX antenna: OFF or ON , per-band (page 97)
CAL	calibration submenu (page 84)
PF1 / PF2	programmable functions (page 97); can be assigned to any menu function, SCAN , or FPon (Fast-Play)

¹² If auto-detect is turned on, a computer, hand key, or external keyer can be connected along with the paddle. See page 92.

Calibration Functions

The **CAL** menu provides the following functions:

FCTR	frequency counter
CUR	programmable transmit current limit
TPA	PA temperature set (see KPA100 manual)
S LO	S-meter zero set
S HI	S-meter full-scale sensitivity set
PLL	VFO linearization
FIL	filter settings (see next page)

After selecting a **CAL** function, hold **EDIT** to activate it.

Frequency Counter (CAL FCTR)

CAL FCTR displays the frequency of the signal at P6 on the Control board during alignment (see page 57).

Transmit Current Limit (CAL CUR)

CAL CUR allows you to set a safe maximum transmit current. The recommended setting is 3.50 A. A lower setting may be appropriate if you're using 5 watts or less, or if your power supply has a lower current rating.

S-meter Calibration (CAL S LO, CAL S HI)

To set the S-meter zero level:

1. disconnect the antenna
2. make sure the RF GAIN control is fully clockwise (max gain)
3. select **CAL S LO** in the menu
4. turn the VFO knob until the left-most bargraph segment is just barely turned off
5. exit **CAL** mode by tapping **MENU**

To set the S-meter sensitivity:

1. disconnect the antenna
2. turn the RF GAIN control fully counter-clockwise (minimum gain)
3. select **CAL S HI** in the menu
4. turn the VFO knob until the right-most bargraph segment is just barely turned off
5. exit **CAL** mode by tapping **MENU**

Note: The S-meter must be recalibrated anytime the AGC threshold is changed. The AGC threshold adjustment is described on page 46.

VFO Linearization (CAL PLL)

The **CAL PLL** function automatically calibrates VFO fine-tuning¹³. You can repeat **CAL PLL** at any time, although this should not normally be necessary. One reason you might re-run **CAL PLL** is after calibrating the frequency counter (see Advanced Operating Features, page 98). In general, you'll need to re-run **CAL PLL** and **CAL FIL** anytime you change the setting of C22 (Control board), which is used to align the 4 MHz crystal oscillator.

To Linearize the VFO:

1. Remove the top cover. The *bottom* cover must be installed
2. Allow a 10-minute warm-up period at room temperature.
3. Connect the internal frequency counter cable to TP1 (VCO).
4. Exit the menu if you were using it.
5. Switch to 40 meters and set the VFO anywhere in the 7000-7100 kHz range.
6. Use the menu to activate **CAL PLL**.
7. When calibration is completed (4-8 minutes), you'll hear a short alert tone and see **End** on the LCD. You can then tap any switch to return to normal operation.

¹³ What you're actually calibrating is the relationship between the PLL (phase-locked loop) divider and the crystal reference oscillator. (See Circuit Details.)

Filter Settings (CAL FIL)

This section explains how to use **CAL FIL** to select the bandwidth and BFO settings. An example appears on the next page. The Elecraft web site provides information on other filter setup methods, including a method that uses a personal computer sound card. For a discussion of how the crystal filter and BFO settings are related, see page 104.

Basic CAL FIL Setup

1. Connect the frequency counter test cable to TP2 (BFO).
2. Set AF GAIN high enough to hear some background noise.
3. Switch to a band between 160 m and 17 m. (The sideband is inverted on 15 m and above, which may be confusing during filter setup.)
4. Select CW mode using **MODE**. If a bar appears above the C, the K2 is in CW Reverse mode; hold **CW RV** to select CW Normal mode.
5. Tap **XFIL** until **FL1** is selected.
6. Tap **MENU** and scroll to **CAL**. Hold **EDIT** to move the underline to **OFF**, then scroll until you see **CAL FIL**. Finally, hold **EDIT** again to activate the filter display.

Filter Bandwidth Display

The initial **CAL FIL** display shows the present filter bandwidth and the operating mode, e.g. **FL1 1.50c**. The number **1.50** indicates a bandwidth of *roughly* 1.50 kHz.¹⁴ This parameter has a range of **0.00 - 2.49**. Above **2.49**, the parameter changes to **OP1 - OP5**, which can be used to select optional filters. For example, the filter on the SSB adapter (KSB2) is **OP1**.

Note the present bandwidth setting, then try using the VFO knob to change it. You'll hear the "shape" (or pitch) of the noise change. (Return to the original bandwidth after experimenting.)

¹⁴ The number shown should be used only as a relative indication of filter bandwidth. Actual bandwidth will probably be narrower.

BFO Displays

Tap **BAND-** to display the BFO setting for filter FL1, which will be similar to **BF1t110c**. The 3-digit number is the *BFO control parameter*. This number can be changed using the VFO knob, but you'll use a different BFO-setting method described below. The letter **t** after **BF1** is a reminder that the **BF1** BFO frequency is always used on transmit, which is important for SSB operation.

Whenever the BFO control parameter is displayed, you can tap **DISPLAY** to show the actual BFO frequency in kHz. The VFO knob can then be used to set the BFO directly. This method is used in the filter-setup example.

Note: After changing the BFO setting, you can tap **AGC** to re-measure and save the BFO information *without switching filters*. This is useful if you want to try various BFO settings for a particular filter to find the one with the best audio peak.

Other CAL FIL Operations

When you're in **CAL FIL** you can always tap **XFIL** to change to the next filter, tap **MODE** to change modes, and hold **CW RV** to switch from CW normal to CW reverse. *Whenever you switch modes or filters, the K2 will first record your new settings, if they have been changed.*

BAND+ switches to the filter bandwidth display, and **BAND-** switches to the BFO display. Tapping **MENU** exits **CAL FIL** and returns to the normal display. (On exit from **CAL FIL**, changes are saved.)

Turning Selected Filters Off

FL2, 3, or 4 can be individually disabled. To turn off a filter, display the filter bandwidth using **CAL FIL**, then set the bandwidth number to **OFF**. (To get to **OFF**, go to **0.00** first, then turn the VFO knob a bit farther counter-clockwise.)

Basic K2 Operation

Mode Selection

Tap **MODE** to cycle through the operating modes, noting the change in the mode indicator letter (**C** = CW, **L** = lower sideband, **U** = upper sideband). If RTTY/data mode is enabled, **r** = RTTY/data will also appear in the mode list (see page 101).

Sideband Inversion: The K2 inverts the sideband on 15 meters and above due to the frequency mixing scheme (the upper and lower sidebands of the signal become reversed). In CW Normal mode, the pitch of CW signals goes up with frequency on the lower bands; on 15 m and up, the pitch goes down with frequency.

Receiver Configuration

Gain Controls: The RF GAIN control should normally be set fully clockwise. Adjust the AF GAIN control for comfortable volume. Sidetone volume is set using **ST L** (page 93).

Crystal Filter Selection: Each operating mode provides up to four filter settings, FL1-FL4. Bandwidth and BFO settings can be customized using **CAL FIL** (page 85)¹⁵. Tapping **XFIL** cycles through the filters. FL2, 3, or 4 can also be turned OFF.

Filters and Operating Modes: The CW Normal and CW Reverse crystal filter selections are tied together. For example, if you switch to FL2 when in CW Normal mode, CW Reverse also switches to FL2. The same applies to the LSB and USB modes.

Checking Filter Status: You can check the current filter number and its bandwidth without changing filters by holding **XFIL** + **AGC**. For example, you might see **FL2 0.80c**. If the KAF2 audio filter is installed and the CW filter is enabled, you'll see **AF1** or **AF2** following the crystal filter display.

Audio Filter Control: If you have the KAF2 option (audio filter and real-time clock) installed, holding **AFIL** will allow you select its operating mode.

Preamp: When operating on higher bands, you'll probably want to use the preamp (about +14 dB) to improve the overall signal-to-noise ratio. If you experience very strong in-band interference, you may need to turn the preamp off.

Attenuator: If necessary, an additional 10 dB of attenuation can be switched in by turning on the attenuator. This is more effective than using the RF GAIN control in the case of strong-signal overload.

Scanning: See Advanced Operating Features, page 96.

Antenna Selection: If you're using a KAT2 or KAT100 automatic antenna tuner, the **ANT 1/2** switch will toggle between the two ATU antenna jacks. This also instantly recalls the ATU's stored L-C parameters for each antenna. Refer to the relevant ATU manual.

Noise Blanker Controls: The KNB2 option is required to use these controls. The noise blanker is always turned OFF on power-up, and you should leave it off unless needed. When it is turned on, the receiver will be more susceptible to interference from strong signals. To turn on the noise blanker, tap the **NB** switch. You'll see **NB1**, **NB2**, and **OFF** in that order. The **NB1** and **NB2** modes provide short or wide pulse blanking intervals, respectively. One may be more effective than the other, depending on the type of noise. In either mode, the NB annunciator will turn on.

The noise blanker provides two thresholds of noise detection: high and low. If you hold **LEVEL** the noise blanker will toggle between these two modes, with the display showing **HI THR** or **LO THR**. High threshold is the default and should be used in most cases. If you select low threshold, the noise blanker may be more effective on certain types of noise, but it will also leave the receiver more vulnerable to strong in-band signals. When **LO THR** is selected, the NB annunciator flashes as a reminder.

¹⁵ Bandwidth settings below **0.20** may cause excessive signal attenuation.

LCD and Bargraph Configuration

Day/Night Selection: If you're operating outdoors, use the menu to select **LCD DAY**, which turns off the LCD backlight and puts the bargraph into high-brightness mode. Indoors or at night, use **LCD NITE**, which turns the backlight on and reduces the bargraph brightness.

Bargraph Modes: You have a choice of **OFF**, **DOT**, or **BAR** for the LED bargraph. If you select **DOT**, just one bargraph segment representing the current meter level will be illuminated. If you select **BAR**, all LED segments to the left of the current level will also be illuminated, resulting in a more visible display. **OFF** mode turns off the bargraph completely during receive but uses DOT mode on transmit (see Advanced Operating Features).

Display Modes: Tapping the **DISPLAY** switch alternates between **frequency** display mode and **voltage/current** display mode. If you have the KAF2 option installed (audio filter and real-time-clock), a **time/date** display mode will also be available.

In frequency display mode, the LCD will show the operating frequency, mode indicator, and any annunciators that are enabled, e.g. **24945.04c**. This is the display you'll use most often.

In voltage/current display mode, the LCD will show supply voltage (E) in 0.1 V increments and supply current (I) in 0.02 A increments, e.g. **E13.8i1.40**. Voltage/current display is useful for monitoring battery condition and transmitter performance. It can also be used in conjunction with a simple voltage probe to check DC voltages inside the K2. A two-position jumper on the Control board, P7, selects either 12 V monitoring or the voltage probe (P5). If the voltage/current display shows **0.0** volts, it is likely that you have P7 in the probe position.

In time/date display mode, the LCD will show either time (e.g. **08.05.00**) or date (e.g. **11-28-02**). You can toggle between time and date by holding **BAND+** and **BAND-** together. Refer to the KAF2 manual for details on setting the time and date.

Frequency and Band Selection

The basic K2 kit covers the 80 through 10 meter bands. 160 meter coverage can be added with the K160RX option, and 60 meters with the K60XV. You can tune well above and below the ham bands.¹⁶

Transverter Bands: The K2 provides up to three programmable transverter band displays for use with external transverters. Refer to the **TRNx** menu entry (page 102).

Transmit Limits: Some countries require transmit to be disabled outside of specified amateur bands. If you key the transmitter with the VFO set outside fixed limits, you'll see **End** on the LCD.

You can change bands in one of three ways:

- tap **BAND+** or **BAND-**
- hold **RCL** (memory recall); see below
- use Direct Frequency Entry (described later)

Whenever you change bands or recall a frequency memory, a number of parameters are saved in nonvolatile memory (EEPROM). This update also occurs periodically if you've moved the VFO (see Backup Timer). The parameters that are saved on a per-band basis include:

- A and B VFO frequencies and VFO tuning rate
- Current VFO (A or B)
- Operating mode (CW, USB, LSB) and CW Normal/reverse
- AGC slow/fast
- Preamp and attenuator on/off
- Noise blanker on/off (requires noise blanker option)
- ANT1/2 selection (ATU option)
- Receive antenna on/off (160 m/RX ant. option))

¹⁶ The receiver is not intended to be general coverage; narrow band-pass filters are used at the front end to reject out-of-band signals. If you attempt to tune too far outside an available band, receiver sensitivity and transmit power will greatly decrease, and at some point the synthesizer will lose lock.

Default Frequency Memories: When you first turn on the K2, each band memory is preset as follows:

- VFO A is set to the first multiple of 100 kHz above the band edge (e.g. 7100, 24900).
- VFO B is set to the U.S. CW QRP frequency for that band
- Other defaults include: CW mode; VFO A; fast AGC; preamp ON above 40 meters and OFF on 40 m and below; noise blanker OFF and high threshold; antenna 2 OFF (antenna 1 selected); receive antenna OFF (normal receive operation)

Memories #1-8 are preset to the same values as the 160-10 meter band memories, respectively.

Store and Recall: Ten memories are provided, numbered 0 through 9. Each memory stores the same information that is stored per-band.

To store the current setup in a frequency memory, hold **STORE** until you see **ENT 0-9**, then tap one of the numeric keypad switches. To recall a stored setup, hold **RCL** until you see **ENT 0-9**, then tap the number of the memory you wish to recall. In both cases you can cancel the operation by tapping any non-numeric switch.

Note: If you *hold* rather than *tap* a numeric keypad digit when doing either a store or recall, you will initiate *scanning*. (See page 96.)

Direct Frequency Entry: To do direct frequency entry, *hold* both **BAND+** and **BAND-** simultaneously. When you see "----" on the LCD, release the two switches, then enter the target frequency using the numeric keypad. To enter a frequency in the 160 meter band, you must enter 5 digits, starting with a leading 0, e.g. **0****1****8****3****5**. For other bands below 10 MHz, you need only enter 4 digits (e.g., **7****0****4****0**). On transverter bands, direct frequency entry can only be used to go to a new frequency *within* the present band. (see **TRNx** menu entry, page 102).

There are three possible results from using direct frequency entry:

- If you enter a frequency *within* the current band, only the current VFO will be updated.
- If you enter a frequency that is in a different band, a band change results, and the entire configuration for the target band will be loaded, except that the current VFO will now be at the frequency you just entered.
- If you enter a frequency that is too far outside any available band, you'll be switched to the closest available band, and the frequency will be set to the one last used on that band. For example, if you try to switch to 8400 kHz--which is typically outside the range of the synthesizer--the K2 will switch to 40 meters and setup the VFOs as they last were on this band.

Tuning Rates: The VFO tuning rate is selected by tapping **RATE**. Default tuning rates include 10 Hz, 50 Hz, and 1 kHz per step, resulting in 1 kHz, 5 kHz, and 100 kHz per VFO knob turn. Other tuning rates can be selected; see the **RATES** menu entry (page 100).

The frequency display changes to remind you of the current tuning rate. At 10 Hz/step, two decimal places are shown (100 Hz and 10 Hz). When you select 50 Hz/step, the 10 Hz digit is blank. When you select 1 kHz/step, both decimal places are blank.

VFO Lock: The current VFO frequency can be locked by holding the **LOCK** switch until **LOC** is displayed. The decimal point will then flash slowly as a reminder. **Split Operation:** Lock applies only to the *current* (receive) VFO. So, while you are holding the **REV** switch (temporary VFO reverse), you can change the frequency of the *other* VFO (transmit), overriding lock. This is very useful when operating SPLIT, since it allows you to check and modify your transmit frequency without unlocking the receive VFO.

Holding the switch again cancels lock and displays **NOR** (normal).

Power Control

Turn the POWER control to set the power output directly in watts (e.g., **P 5.0**). The normal range of the control is 0.1 to 15 watts. If you have the KPA100 option installed and enabled, the range is 0.1 to 110 watts, with the amplifier module disabled at 10 watts or lower. In CW mode, you must send a few CW characters or press **TUNE** to allow the ALC (automatic level control) to lock-in the new power level.

Requested vs. Actual Power: The POWER control sets the *requested* power, which may exceed the *actual* power that the transmitter can achieve. To see actual power output, use **TUNE** (see below). In tune mode, the display always shows the actual power output (except when the display is showing voltage and current, or when the ATU is doing an autotune). The power displayed will be accurate to within about 10% if the load at the antenna is matched (50 ohms).

Using TUNE: Hold **TUNE** to key the transmitter. You'll hear one beep when you start tune, and another when you terminate tune by tapping any switch or hitting the keyer paddle.

ATU: If you're using a KAT2 or KAT100 automatic antenna tuner, pressing **TUNE** will drop power to either 2 or 20 watts maximum (depending on whether the KPA100 is in use), and may trigger a re-tune of the antenna matching network. You can also override power reduction by holding **TUNE** + **DISPLAY** (see page 91).

Current Limiting: To protect the transmitter and power supply/battery from excess current drain, you can program a transmit current limit using **CAL CUR** (see Calibration Functions).

VFO Selection

To select the A or B VFO, tap **A/B**. To set the unused VFO equal in frequency to the current VFO, tap **A=B**. The currently-selected VFO will determine both the transmit and receive frequencies unless you're running SPLIT (see below). A and B VFO frequencies are saved in EEPROM on a per-band basis, and are updated periodically (see Backup Timer at the end of this section).

Split and Reverse Operation

Split operation means transmitting and receiving on different frequencies. This is useful for DX work, since many DX stations will ask you to call them above or below their carrier frequency to avoid interference. To enter split mode, hold **SPLIT** until the message **SPLIT** appears on the LCD. Holding **SPLIT** in again will display **NOR** (normal). The active VFO annunciator (A or B) will flash slowly when you're in SPLIT mode to remind you that this feature is enabled and that your receive and transmit frequencies are different. Also, each time you transmit when in SPLIT mode, the transmit frequency is displayed for a minimum of 1/2 second.

When you're using split, you can switch between your transmit and receive frequencies by tapping **A/B**. However, there are times when you only want to quickly listen on your transmit frequency, not switch VFOs. In this case you can hold in the **REV** switch (reverse), which temporarily swaps the VFOs. When you release REV, the LCD will return immediately to the receive frequency. When using split, experienced operators can simultaneously hold in the REV switch and adjust the VFO knob--all with one hand--to quickly find a clear spot to transmit. (**REV** overrides VFO lock as described previously.)

You can install an LED on the front panel that will turn on whenever SPLIT, RIT, or XIT is in effect. See the associated application note, [Adding a SPLIT/RIT/XIT LED to the K2](#).

RIT and XIT

You can turn on RIT (receive incremental tuning) by tapping **RIT**. The RIT annunciator then turns on. It flashes slowly if you have selected a wide-range RIT/XIT offset (see **RIT** menu entry, page 101). The OFFSET knob controls the receive offset.

The +1 and -1 kHz marks on the offset control apply only if the RIT/XIT range is set to +/- 1.2 kHz using the **RIT** menu entry. Regardless of the range used, the exact offset can be determined by comparing the VFO frequencies with RIT on and off.¹⁷

When **XIT** is turned on, it works similarly to **RIT**, except that the *transmit* frequency is varied with the OFFSET control. This can be useful for small-split operation (for example, when a DX station you're listening to says to call "UP 1" kHz), or to adjust your transmitted frequency at the request of another station. The transmitted frequency is not displayed during receive mode, so if you need to determine the exact setting of the offset control when using **XIT**, you can briefly turn on **RIT**.

It's OK to have both **XIT** and **RIT** on at the same time. In this case the OFFSET control can be thought of as an extension to the main tuning knob, but covering only a small frequency range.

As with **SPLIT**, if you have **RIT** or **XIT** enabled, the transmit frequency will be displayed when you transmit, and the receive frequency will be restored a minimum of 1/2 second later.

FINE RIT: In some cases you may want to control the VFO in smaller steps to fine-tune signals on receive. This can be done using the FINE RIT feature, described on page 99.

¹⁷ We did not include detent on the offset knob because experience has shown that knob detent mechanisms degrade over time, making it difficult to adjust the offset near the zero point. However, you can always return the offset knob to the zero point by simply matching the RIT-on and RIT-off frequency displays, or by turning RIT off.

Automatic Antenna Tuner (ATU)

Both the low-power internal automatic antenna tuner (model KAT2) and high-power external antenna tuner (KAT100) can match nearly any coax-fed or random-length antenna on multiple bands. ATU functions will be covered briefly here; refer to the specific ATU manual for details.

The operating mode of the KAT2 or KAT100 is selected using the **ATU** menu entry, and is normally set to **AUTO**. The menu entry also allows you to see the L and C selection, step through ATU relays, etc. **Note:** If you have both a KAT2 and a KAT100 connected to your K2, the **ATU** menu entry will control only the KAT100. The KAT2 will be placed in through mode (L and C = 0), and will be set to antenna 1.

The ATU is activated whenever you press **TUNE**. The K2 display will show SWR or forward/reflected power, depending on the tuner's mode. If a KPA100 is installed, its **TUNE** display will be used. Power is reduced to 2 watts during TUNE mode (20 watts if the KPA100 is enabled). This power reduction can be overridden by holding **TUNE** + **DISPLAY**. In this case, no auto-tune will be attempted.

Two antenna jacks are provided on both ATUs, with the matching network data for both antennas stored on a per-band basis. You can tap **ANT 1/2** to switch antennas. Since the relays take only a small fraction of a second to switch, it becomes practical to quickly try both antennas anytime the distant station is weak. This is particularly useful for Field-Day and similar contests, where you might use two end-fed random wires running in different directions.

Backup Timer

While you're moving the VFO, a 30-second data backup timer is being continuously re-started. Once you have completely *stopped* tuning the VFO for at least 30 seconds, the K2 will then save your current operating frequency in EEPROM. As long as you stay on a particular frequency, no further updates will be done.

CW Operation

The K2 provides a number of features for the CW operator:

- fast I.F.-derived AGC with fast/slow/off control
- full break-in operation with no relays
- accurate control of sidetone volume and sidetone pitch/offset
- memory keyer with Iambic modes A and B,
- nine programmable message buffers; chaining and auto-repeat
- software-selectable paddle selection (normal or reverse)
- multiple crystal filter bandwidths and opposite-sideband CW
- dedicated **SPOT** switch for accurate signal pitch matching.
- optional low-noise analog audio filter

Several advanced CW features are covered in later sections:

- Fast-Play ("one touch") message buffers (page 100)
- Adjustable keying weight (page 100)
- "smart" CW signal scanning (page 96)
- FINE RIT for fine-tuning CW signals (page 99)

Keying Device Selection

A single connector in the back is provided for your keyer paddle, hand key, keyer, or computer. It is also possible to connect both a paddle and an external keyer or computer at the same time (see External Keying Auto-Detect, below).

You must use a *stereo* (2-circuit) plug, even if you use only a hand key or external keyer. This should not affect the use of the keying device with other equipment, since the middle contact on the plug (often called the "ring" contact) is only used with keyer paddles.

Hand key or External Keying Device: To use a hand key or external keying device, select **INP HAND** using the menu. Use the "tip" contact (DOT) of the key jack with a hand key or external keying device. You can key the K2 externally at up to 70 WPM.

Internal Keyer: To use a keyer paddle, use the menu to choose **INP PDLn** or **INP PDLr** (normal or reverse paddle). With **PDLn** selected, the "tip" contact on the stereo key jack is DOT and "ring" (the middle contact) is DASH. **PDLr** is the reverse.

External Keying Auto-Detect: If you wish to connect a handkey, external keyer or computer along with a keyer paddle, you can use the K2's "auto-detect" feature. Simply connect your external keying device to the DOT and DASH lines through two diodes as shown in Figure 8-1, along with the keyer paddle. Be sure you have selected **INP PDLn** or **INP PDLr** in the menu.

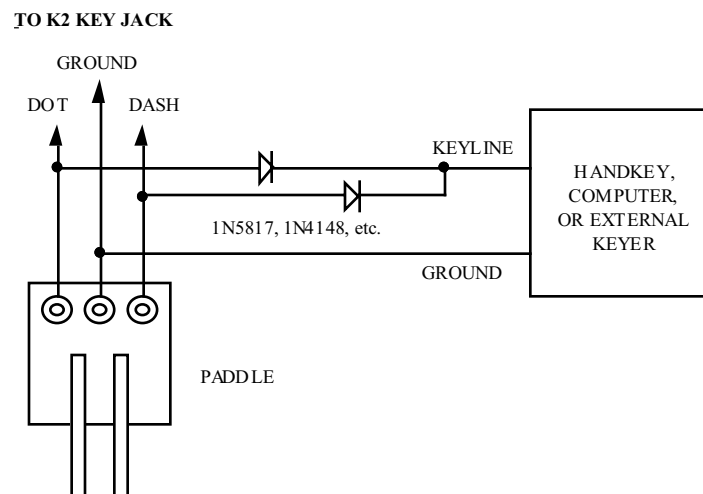

Figure 8-1

When you connect the keying devices in this way, you can continue to use the paddle as usual. But if the external keying device is keyed, both the DOT and DASH lines will be pulled low simultaneously via the diodes. The K2 firmware interprets this as direct external keying rather than as DOT or DASH triggers.

Auto Detect can be turned off if desired. Find the **INP** menu entry, **EDIT** the parameter, then tap **DISPLAY** to select **ADET OFF**.

Basic CW Setup

Mode Selection: To place the rig in CW mode, tap the **MODE** switch until the mode indicator changes to *C*.

Filter Selection: You can select one of the filters using the **XFIL** switch. FL1 is typically configured as the widest filter. If you have the SSB adapter installed, you'll probably want to use **CAL FIL** configure FL1 as OP1 (SSB option filter) in CW and CW reverse modes, and leave FL2-4 at the narrower factory defaults (0.7, 0.4, and 0.1). Details on how to do this setup can be found in the SSB adapter manual.

CW Frequency Display: In CW mode, the frequency shown on the LCD takes into account an offset equal to your sidetone pitch. This allows you to determine a station's actual carrier frequency by matching their pitch to your sidetone, rather than by zero-beating the signal. The **SPOT** switch can be used for this purpose.

Operate vs. Test mode: If you want to try out the keying without actually transmitting, hold the **VOX** switch until the display shows **TEST**. The mode letter *C* on the LCD will flash to remind you that you have disabled transmit. Holding the **VOX** switch in again returns to **OPERate**.

Sidetone Setup: Key the rig in **TEST** mode and listen to the sidetone volume and pitch. To change the volume, use the menu's **ST L** entry (sidetone level). The pitch can be changed using the **ST P** entry (sidetone pitch). **ST L** is used often, so you might want to assign it to **PF1** or **PF2** (see Advanced Operating Features).

Break-in (QSK) delay: The QSK delay is set using the **T-R** menu option. A setting of **0.00** is fastest but some operators may find the keying harsh, in which case **0.01** is a good compromise. **0.05** is about right for casual operation. You can select a longer delay (up to 2.5 seconds) for slower CW work or to prevent un-muting when sending a repeating beacon message.

The SPOT Switch

The **SPOT** switch can be used to zero-in on received signals or to test your sidetone pitch quickly, without having to key the transmitter or enter the menu. It's important to use **SPOT** before using CW reverse. Once a signal has been SPOTted, you'll only hear a slight change in pitch when you use the **CW RV** switch.

When you use **SPOT**, the receiver audio will not be muted. This allows you to listen to another station and turn the VFO knob until the pitch of the received signal matches that of the sidetone. Once the two match, you'll be very close to the station's frequency if you call. (Exception: If you're using **RIT**, **XIT**, or **SPLIT**, your transmit and receive frequencies will differ by more than just the normal transmit/receive offset. Turn off these features when using **SPOT**.)

Unfortunately, matching audio pitch is a little tricky for some operators. Basically, you'll need to tune the VFO up and down until the station you're hearing seems to "disappear" under the sidetone—that is, until you can't hear any difference between the two. When this happens, you'll know the two pitches are matched.

Using the Internal Keyer

Two menu entries are provided to set up the keyer:

- **IAB** allows you to select Iambic mode **A** or **B**. (Mode **A** is similar to Curtis mode A; mode **B** is similar to Super CMOS Keyer III mode B. If you aren't sure which to use, start with mode A, which has less critical timing requirements.)
- **INP** selects paddle normal (**PDLn**), paddle reverse (**PDLr**), or hand key/ext. keyer (**HAND**)

These settings are stored in EEPROM, so you won't lose them when you turn power off.

Use the **KEYER** control to select the desired CW speed. The display shows the speed in WPM as soon as you start turning the knob. You can adjust the keyer speed even while transmitting.

Message Memories

The K2 provides nine CW message memories of 250 bytes each. Playback features include message repeat and 1-level chaining. CW messages can only be recorded using a keyer paddle connected directly to the K2's key jack. Set **INP** to **PDLn** or **PDLr**.

To record a message: Hold **REC**, and when prompted tap a numbered switch (#**0-8**) to select one of the nine message buffers. The display will then show REC 250, indicating that 250 bytes of storage are available in this message buffer. This number will count down toward 0 as long as you are sending. Whenever you stop sending, up to two standard-length word spaces will be inserted. To stop recording, tap **MSG**. If you do this *before* starting to send, the original message contents will not be lost.

To play back a message: Tap **MSG**, then select a message buffer (#**0-8**). Message play can be canceled at any time by hitting **MSG** again or by tapping the keyer paddle. To listen to a message without transmitting, use **TEST** mode (**VOX** switch).

Auto-Repeat: Any message memory can be auto-repeated when played. To auto-repeat, tap **MSG** as usual, then *hold* the desired numbered switch (#**0-8**). The message will then play back continuously until you tap **MSG** again or hit your key or paddle. The buffer # will flash at the end of each transmission (e.g., **B6**).

Note: You cannot change the frequency with the VFO knob during a repeating message, but you can use RIT (if enabled) to listen above and below your receive frequency between calls.

Setting the Auto-Repeat Interval: The length of the pause between messages during auto-repeat can be programmed using the **RPT** menu entry (0-255 sec.). Long delays are useful for beacons.

Message Chaining and chain/repeat: While a message is playing, you can tap #**0-8** to chain a message onto the end of the current one. The buffer number will be displayed twice: once when you hit the numbered switch, and again when the chained message starts. To chain a repeating message onto the current message, HOLD rather than TAP the numbered switch (i.e., use #**0-8**). Chaining is useful during contests. For example, you might set up message 5 as "QSL 73" and message 6 as "CQ TEST DE N6KR." You could then hit **MSG** **5** **6** at the end of a QSO to sign with the previous contact, then begin a *repeating* CQ.

CW Reverse

CW Reverse allows you to listen to CW using the opposite sideband. Sometimes this can eliminate or reduce interference from a strong station without reducing the strength of the desired signal. To switch to the opposite sideband, hold the **CW RV** (CW reverse) switch. A bar will appear above the mode letter **C** on the LCD. (Use **SPOT** first to stay on frequency when you switch to CW reverse.)

Sidetone Pitch and Receive Offset

When you change the sidetone pitch using the **ST P** menu entry, you're also changing the CW receive offset. The two always match within approximately 10 Hz. This ensures that when you listen to other stations at same pitch as the sidetone, your transmitted signal will be right on that station's frequency.

To see how the receive offset tracks the sidetone pitch: Use **SPOT** to tune in a station at your current sidetone pitch as described earlier. Then use **ST P** to change the pitch. As soon as you exit the menu, you'll notice that the station you were listening to has also been shifted to the new sidetone pitch.

Changing the sidetone pitch does not automatically re-adjust the BFO frequencies in relation to the crystal filter passband. So if you change your sidetone pitch, you should use **CAL FIL** to manually optimize the BFO settings.

SSB Operation

You can use SSB and RTTY/data modes if you have the KSB2 SSB adapter installed. Basic information on using the SSB adapter is provided here. For complete details, refer to the KSB2 manual.

SSB Controls

Operating Mode: Use **MODE** to select *L* (LSB) or *U* (USB). To alternate directly between USB and LSB, use **CW RV**. LSB is usually used on 40 meters and below, and USB is used on the higher bands.

Crystal Filter Selection: If the SSB adapter is installed, you'll be able to take advantage of its 7-pole fixed-bandwidth filter. The fixed filter is designated **OP1** in **CAL FIL**. In addition to its application to SSB and data modes, it can be used for CW and AM reception. Refer to the KSB2 manual.

SSB Menu Entries: **SSBA** is used to set the mic audio level (mic gain), from **1** to **3**. An additional setting, **BAL**, is used during SSB adapter alignment. **SSBC** is used to set the speech compression level, from **1-1** to **4-1**. Higher settings add "punch" and are especially useful at low power levels.

PTT/VOX Selection: By default the K2 uses PTT (push-to-talk) via your microphone's PTT switch. To use VOX (voice-operated transmit), hold the **VOX** switch until you see **SPCH 0.4** or **SPCH 1.0** on the LCD. The number 0.4 or 1.0 is the approximate VOX delay time in seconds. Holding **VOX** again restores the setting to **PTT**.

Power/ALC Metering: If you have the SSB adapter installed, you'll be able to switch between RF and ALC bargraph meter modes by holding **RF/ALC**. ALC metering is used only in SSB modes, and may help in setting the mic gain and speech compression level. The ALC reading starts from the *right* end of the bargraph rather than the left, using BAR mode, so you won't confuse it with the RF display. Use RF meter mode for normal operation.

Microphone Configuration

You'll need to configure the MIC CONFIG header on the Front Panel board in order to transmit SSB on the K2. Most microphones with standard 8-pin connectors can be used. On many mics, the Up and Down buttons can be configured to switch between VFO A and B. You'll hear one beep on switching to VFO A, and two beeps when switching to VFO B.

RTTY/Data Operation

RTTY/data operation can be accomplished in SSB modes by using AFSK (*audio frequency shift keying*) or other modulation modes. Audio must be fed into the mic jack from a computer or modem, and the K2's audio output routed to the computer or modem from either the headphone or speaker jack. Either LSB or USB can be used; this will probably be determined by your software. You can use either the SSB adapter's fixed filter (**OP1**) or the variable-bandwidth crystal filter for receive purposes. On transmit, **OP1** is always used.

Since some RTTY/data mode duty cycles approach 100%, you should reduce power to about 5W or avoid transmitting at 10W for longer than 1-2 minutes at a time. (Power levels above 10 W are not recommended.) You can key the transmitter via either the key jack or the mic jack, since the DOT line is also the PTT line.

RTTY/Data Mode (mode letter r): This is a special fourth mode of operation that provides independent crystal filter selections for use with RTTY, PSK31, etc. For details on configuring and using RTTY/data mode, see page 101.

FINE RIT: Fine RIT allows you to vary the receive frequency in increments smaller than 10 Hz. This is especially useful with PSK31 and other narrow-band data modes. See page 99.

Advanced Operating Features

A number of specialized operating techniques are described in this section:

- Scanning (see below)
- Reducing current drain for portable operation
- Using a separate receive antenna
- Programming the PF1/PF2 functions
- AGC on/off control
- VFO frequency calibration techniques
- Checking firmware revision numbers
- Resetting to factory defaults
- Using computer control of the K2
- FINE RIT mode

Also see **Secondary Menu Functions** (page 100).

Scanning

The K2's scanning feature lets the K2 tune any band segment continuously, keeping the receiver audio squelched until signals of interest are found. Scanning works for both CW and SSB signals, and when properly set up will ignore most stable carriers (key-down signals with no modulation).

Scanning is very useful for monitoring bands that may at first appear "dead." You may be surprised to find more activity than expected. The receiver will stay squelched until a signal appears.

Frequent scan users may wish to program **PF2** (or **PF1**) to do SCAN RESUME as described at right.

To use scanning:

- Setup VFOs A and B for the two ends of the band of interest. VFO A must be set for a frequency *lower* than VFO B (a minimum of 2 kHz separation is recommended).
- Select the operating mode, preamp/attenuator setting, and tuning rate (**RATE**). Select a narrow filter if the band is noisy.
- Store this setting in any memory (using the **STORE** switch), but instead of *tapping* the switch for the desired memory, *hold* the numbered switch (**0-9**) to initiate scanning. You can also initiate scanning when you recall a stored memory. Just hold **RCL**, then hold the numbered switch in, as with **STORE**. The memories can store up to 10 scan ranges for instant recall.
- During scanning, the MHz decimal point flashes. When a station is found, the receiver will stay on that frequency for about 25 seconds or until the signal fades. Once a signal has disappeared or 25 seconds have elapsed, the frequency will be incremented by 0.5 kHz and scan resumed.
- If scanning seems to be locking onto noise too often, you can tailor the lock rate by backing down the RF GAIN control. Also try using a narrower filter or turning off the preamp. You'll need to re-store the scan memory after making these changes.
- You can exit scan mode by tapping any switch or hitting your key or paddle. Use SCAN RESUME (below) to restart scan.

Scan Resume: Often you may wish to stop scanning, then pick up where you left off. To do this, you can program **PF2** (or **PF1**) to do scan resume. Once scan resume has been assigned to a programmable function switch, simply tap any switch or the keyer paddle to stop scan, and hold **PF2** (or **PF1**) to re-start it. You'll hear one BEEP when you stop scan, and another beep when you resume it. The frequency will jump up 0.5 kHz to avoid having scan re-lock on the same station.

Reducing Current Drain for Portable Operation

You can use any of the methods listed below to reduce receive-mode current drain and thus extend battery life. These techniques will have only a small effect on *transmit* current drain, however. Reduce power output to the lowest effective level if you're transmitting frequently on a weak battery.

- Use headphones or reduce speaker volume.
- Turn off the RF preamp.
- Set **GRPH** to **DOT** mode. There's also an **OFF** mode, which completely disables the S-meter and forces **DOT** mode for transmit power display.
- Set **OPT** (Optimization) to **BATT** (battery); this reduces the I.F. post-mixer amplifier current by about 40 mA and automatically forces the bargraph to use **DOT** mode if set for **BAR**. Receive performance is minimally affected by this setting unless you have very strong in-band stations nearby.
- Set **LCD** to **DAY** to turn off the **LCD** backlight. This is most effective if you also set **GRPH** to **OFF**, since each bargraph LED segment that is turned on in **DAY** mode uses about 18 mA. (Each segment uses only 6 mA in **NITE** mode.)

Note: Voltage/current display mode can be used to verify the effect of each setting.

Using a Separate Receive Antenna

The 160 m/RXANT option (K160RX) provides a separate receiving antenna. This capability is included with the 160-m option because such an antenna is frequently used on 160 meters. However, the receive antenna switch can be used on any band.

To enable the receive antenna: Switch to the desired band. Next, use the menu to change the **RANT** option to **ON**. This will affect only the current band. If you anticipate switching between the normal and receive antennas often, you can program **PF1** or **PF2** as **RANT**.

Programmable Function Switches (PF1/PF2)

The **PF1** and **PF2** switches (below **RIT** and **XIT**, respectively) can be programmed as direct edit shortcuts to any two menu entries of your choice, including *secondary menu* entries (see page 100). Two special functions can also be assigned to **PF1** or **PF2**: Fast Play (**FPon**, page 100) and SCAN RESUME (**SCAN**, page 96).

To program PF1 or PF2: Enter the menu and scroll to **PF1** or **PF2**, then change the parameter to the desired entry. Exit the menu.

To use PF1 or PF2: HOLD one of these switches to activate the selected menu shortcut, then change the menu parameter (which will be underlined) using the VFO knob or **BAND+**/**BAND-**. To return to normal operation, tap any switch or the keyer paddle. Exceptions: the **FPon** and **SCAN** functions take effect immediately.

Using PF1 or PF2 as secondary menu shortcuts: Enter the menu and scroll to **PF1** or **PF2**. To switch to the secondary menu entries, tap **DISPLAY**. (Tapping **DISPLAY** again will return to the primary menu entries.) Select the desired parameter, then exit the menu.

AGC On/Off Control

Some operators prefer to turn AGC off and use manual RF GAIN control under certain weak-signal conditions.

To turn off AGC: Hold both the **PRE/ATT** and **AGC** switches simultaneously. Release the switches when you see **OFF** flashed on the LCD. To remind you that AGC is off, the decimal point to the left of the mode indicator will flash slowly. Received signals will no longer affect the S-meter level. Turning the RF GAIN control counter-clockwise will increase the S-meter reading.

Frequency Calibration Techniques

The VFO is only as accurate as the 4.000 MHz oscillator on the Control board, which is calibrated using C22. C22 can be fine-tuned using one of the following methods:

Using an External Counter or Ham-Band Receiver:

These methods are described in detail in Alignment, Part II (**4 MHz Oscillator Calibration**). After setting C22 using either technique, you must re-run **CAL PLL** (with the counter probe on TP1). You'll also need to use **CAL FIL** (with the probe on TP2) to re-adjust each BFO setting, which will allow the K2 to store new, more accurate BFO frequency measurements.

Using a Calibrated Signal Source:

You can calibrate C22 using a signal generator, ham transmitter, or strong AM carrier such as WWV at 10 MHz. The K2's receiver is used to zero-beat this signal to determine how far off the VFO is, then C22 is adjusted to compensate. *Because of the way **CAL PLL** works, you can only use a signal source that is at one of the lower band edges, e.g. 7000.00 or 10000.00 kHz.* Here's the procedure:

1. Select LSB or USB mode on the K2.
2. Zero-beat the calibrated signal source on the K2, then note the VFO dial error. For example, 10 MHz WWV might zero-beat at 10000.20 kHz. The error is then $10000.20 - 10000.00 = +0.20$. *Do not move the VFO from this position.*
3. Connect the K2's internal counter to the VCO test point (TP1).
4. Select and activate **CAL FCTR** using the menu.
5. Note the displayed VCO frequency. (In this example, 14913.88 kHz. Your VCO frequency will be somewhat different.)
6. Subtract the VFO dial error from the VCO to obtain a target VCO frequency. (In our example, $14913.88 - 0.20 = 14913.68$.)
7. Adjust C22 until the VCO is at the target frequency.
8. Re-run **CAL PLL** (see Calibration Functions). Tap **MENU** to

exit **CAL PLL** when "End" appears.

9. Move the counter probe to TP2 (BFO). Using **CAL FIL**, change the *BFO control parameter* for the filter presently being used by at least one count, then return it to the original setting. Tap **MENU** to exit without switching filters. This will force the K2 to re-measure the BFO frequency.
10. Repeat step 2. If the VFO dial is still off, repeat steps 3 - 9.
11. Modify *all* BFO settings using **CAL FIL** (as in step 9).

Firmware Revision Numbers

You can check the K2's **main microcontroller** and **I/O controller** firmware revisions by holding in any switch on power-up. Two numbers will then be displayed briefly. For example, you might see **2.03A 2.04**. The first number is the main microcontroller's firmware revision and letter suffix. The second number is the I/O controller's firmware revision.

The ATU's firmware revision is one of the parameters in the ATU submenu, e.g. **F1.00**. This also applies to the **KPA100**. The **SSB adapter**'s firmware revision can be obtained by first setting the **SSBA** menu entry to **BAL**, then holding the **VOX** switch. (Return the **SSBA** menu entry to its normal setting after checking the firmware revision.)

The firmware revisions for other options may also be accessible; refer to the individual option manuals.

Resetting the Configuration to Factory Defaults

You should reset configuration data to defaults *only* if the K2's EEPROM is accidentally corrupted. (This is extremely unlikely to happen.) The most likely symptom that this has occurred would be an unexpected frequency setting showing up on a particular band, or strange characters appearing on the LCD. Before resetting the configuration to defaults, try simply re-entering the correct frequency and storing it in the affected memory.

If you find it necessary to defaults, record the following data first:

- filter and BFO settings for all modes/filters (using CAL FIL)
- other CAL parameters, e.g. S-meter HI/LO, current limiting
- primary menu parameters
- secondary menu parameters, if applicable

To reset to defaults: Turn the K2 off, then hold down the **4**, **5**, and **6** switches, and turn power back on. The EEPROM will be rewritten with factory defaults. You can then re-enter the data saved above using the menu functions. Re-doing CAL PLL is also recommended.

Computer Control of the K2

If you have the RS232 interface adapter installed (model KIO2), or the 100-watt stage (KPA100), you'll be able to use a computer to control the K2. Both the KIO2 and KPA100 provide true RS232 levels (at 4800 baud), with no need for a level converter.

The K2's computer-control capabilities are compatible with nearly all contesting, logging, and remote-control software, including Elecraft's *k2remote* and *k2voice* programs. Control over the internet is also possible. You can write your own programs as well (see the *KIO2 Programmer's Reference*, on our web site).

Refer to the KIO2 or KPA100 manuals for additional details.

Fine RIT Mode

The K2's FINE RIT feature provides receiver tuning in steps smaller than 10 Hz. The primary use of FINE RIT is for data modes such as PSK31, which can benefit from a reduction in T/R frequency shift between FL1 and one other filter¹⁸. *FINE RIT mode is only effective for this if FL1 is configured as OP1 (SSB crystal filter)*. FINE RIT can also be used to accurately zero-beat AM stations, or to fine-tune CW signals when a narrow filter is used.

Limitations: Entering FINE RIT mode turns off SPLIT, RIT, and XIT, which cannot be used in combination with FINE RIT. If you move the VFO while using FINE RIT, you may need to readjust the OFFSET control due to small differences in linearity over the VFO's tuning range.

To use FINE RIT: Select a narrow data-mode filter (**FL2 - FL4**) using **XFIL**. Next, hold **RIT** and **XFIL** together; the display will show **FINE ON**, and the RIT and XIT annunciators will alternate on/off slowly. Only **FL1** and the selected narrow filter will now be available; the other two will be temporarily disabled. You can then use the OFFSET knob to fine-adjust the signal pitch of the narrow filter without affecting the pitch of FL1. Turning the OFFSET knob will display the filter selection and the FINE RIT offset, from -15 to +15 units (e.g., **FL3 -12**). One unit is about 1 to 3 Hz (finer on lower bands). When you transmit (always through **OP1**), you will be closer to the received station's carrier frequency, and on receive, switching filters will result in few if any lost characters.

To cancel FINE RIT: Hold **RIT** + **XFIL**, or change modes or bands. **FINE OFF** will be displayed.

¹⁸ In data modes, the TX and RX frequency will always be exactly the same if you use *only* FL1 (if set to **OP1**), and avoid using splits. However, you may wish to switch to a narrow filter when QRM is present. The shift in frequency between **OP1** (which is used on transmit) and the narrow filter can cause the signal to "walk" up or down the band if "net" is turned on in the demodulation software. Most software provides a means of turning off "net" (i.e. locking the TX frequency). FINE RIT provides a supplemental tool.

Secondary Menu Functions

MENU normally shows the *primary* menu. To access the *secondary* menu, tap **DISPLAY** (after tapping **MENU**). As you go back and forth between the two menus with **DISPLAY**, you'll see **PRI** and **SEC**. Scrolling and editing are done the same way in both menus.

All secondary menu functions are listed and described here. Parameters accessed with **DISPLAY** are marked (*); see below.

SLCH	Squelch level
RATES	RATE switch selections
DOT	Dot/space ratio (keying weight)
FPLY	Fast Play switch selections
PORT	RS232 interface on/off (Port Test*)
SPLT	SPLIT , RIT , XIT configuration
Po28	10 / 12 meter SSB power output limit
RTTY	RTTY (data) mode control
RTC	Real-time clock control
RIT	RIT/XIT offset range (up to +/- 4.8 kHz)
ACC	Accessory output control
D19	Leave at default (n) unless K60XV option installed
PA	K2/100 final stage mode selection (Fan Mode*)
TRN1-3	Transverter band setup (Parameter*)

DISPLAY Switch Usage in **EDIT** Mode: The **DISPLAY** switch is used to access supplemental parameters when editing certain menu entries (marked "*" above). You will normally not need to change these settings. Entries which use **DISPLAY** include:

Menu Entry	DISPLAY Usage
PORT	Sends an RS232 test message if PORT is ON
PA	Selects PA fan mode (see KPA100 manual)
TRN1-3	Selects transverter parameters (see page 102)

Squelch (SLCH)

Squelch defaults to **OFF**. You can set the threshold to **1-10**, corresponding to the S-meter's bargraph segments. Transmitting holds squelch open for about 10 seconds.

Tuning Rate Selection (RATES)

The **RATES** menu entry lets you specify how the **RATE** switch works. The four options are:

3N	3 rates, normal order (10/50/1000 Hz steps)
3R	3 rates, reverse order (1000/50/10 Hz steps)
3C	3 rates, CW optimized (10/20/1000 Hz steps)
2	2 rates (10/50 Hz steps only)

Keying Weight (DOT)

DOT sets the internal keyer's dot/space ratio (keying weight). The range is **0.90-1.40**, roughly 90% to 140% of "normal" weighting. The default is **1.10**.

Fast-Play CW Messages (FPLY)

CW messages are normally played by tapping **MSG**, then **0-8**. During contests, some operators prefer to have one-touch access, which we refer to as *Fast-Play*.

To use Fast-Play: First, program **PF1** or **PF2** as **FPOn** for use in turning Fast-Play mode on/off. Next, use the **FPLY** menu entry to select a switch group. For example, if you have **FPLY 2-5** selected, you can use **2**, **3**, **4**, and **5** for Fast-Play. (The **TAP** functions of these switches won't be available in CW mode; **HOLD** functions are unaffected.) When Fast-Play is on, the letter **F** will replace the mode letter **c** once every few seconds as a reminder.

A tap of any Fast-Play switch will play its message buffer one time. To auto-repeat, you must still use **MSG** as described on page 94.

RS232 Interface Setup (PORT)

Use the **PORT** menu entry to turn on 4800-baud RS232 communication. When **PORT** is **ON**, tapping **DISPLAY** sends an "FA" command (VFO A frequency) for test purposes. Refer to the KIO2 or KPA100 manual for details.

SPLIT/RIT/XIT Configuration (SPLT)

Normally, the K2's **SPLIT**, **RIT**, and **XIT** selections stay the same as you switch from one band to the next. To have these selections stored on a per-band basis and retained when power is off, set **SPLT** to **PER** (per-band).

10 and 12 m Power Limit in SSB/RTTY Modes (Po28)

The highest distortion-free *single-sideband* power output level may be less than 15 watts, especially on 10 and 12 m. We recommend leaving **Po28** at **10.0** watts. (Does not apply to CW mode.)

RTTY/Data Mode (RTTY)

RTTY/Data mode (mode letter lower-case **r**), if enabled, provides four independent crystal filter settings for use with data modes. To enable RTTY/Data mode, set the **RTTY** menu parameter to **ON**. The **MODE** list will then include **C**, **L**, **U** and **r**. **r**-NORMAL mode uses lower sideband, and **r**-REVERSE (with a "bar" over the **r**) uses upper sideband. To select **r**-REVERSE, hold the **CW RV** switch. (FINE RIT is also very useful in data modes; see page 99).

Filter configuration (CAL FIL): **r** mode defaults to the same settings as LSB and USB. Use **CAL FIL** (on 17 meters or below) to modify the **r**-mode filter bandwidths or BFO settings as needed.

Speech compression (SSBCr): The **SSBC** menu entry will change to **SSBCr** when **r** mode is selected. A setting of **1-1** (1:1, or speech compression off) is recommended for RTTY/data.

Real-Time Clock (RTC)

If the KAF2 option is installed, the **DISPLAY** switch will show time or date. Refer to the KAF2 option manual.

RIT/XIT Range Selection (RIT)

RIT is used to select one of four RIT/XIT OFFSET ranges. If the selected range is +/- **1.2** kHz or higher, the RIT/XIT annunciators flash whenever **RIT** or **XIT** are turned on.

Accessory Outputs (ACC)

This menu entry is reserved for use with a future programmable-I/O accessory.

Extended VFO Range (D19)

Leave **D19** set to the default, **n** (no), unless you have installed varactor diodes D19 and D20 in conjunction with the K60XV option (60 meters plus low-level transverter I/O). At that time the parameter should be set to **Y**.

Note: Do not install D19 and D20 without the K60XV, even if they were supplied with your K2 kit.

K2/100 Mode Selection (PA)

If you have the KPA100 option installed, the **PA** menu entry shows the 100-watt stage's operating mode. While editing the **PA** parameter, tapping **DISPLAY** selects the fan mode (**nor**, **LoHi**, **Hi**). For more details, refer to the KPA100 manual (Appendix G of the K2 owner's manual, which is supplied with the KPA100 kit).

Transverter Bands (TRN1/TRN2/TRN3)

Three user-definable bands are provided for use with transverters. Once enabled individually using the **TRN1-3** menu entries, these bands will appear in the band rotation following 10 meters. Transverters themselves must be supplied by the builder, and can be mounted internally or externally to the K2.

Transverter switching: If you have more than one transverter, you can switch their power and RF connections manually. However, the K60XV option (60 meter adapter and low-level transverter I/O) can be used to do automatic selection of up to three transverters. The K60XV has one logic output for each transverter band, which can turn on a small relay or a relay drive transistor. Refer to the K60XV manual for further details.

Transverter configuration: Several parameters can be set up on each band using the **TRN1-3** menu entries. First, tap **MENU**, select the secondary menu (**SEC**) using **DISPLAY**, and scroll to **TRN1**, **2**, or **3** as desired. Next, hold **EDIT** to highlight the first parameter. You can then tap **DISPLAY** to rotate through the parameters. Finally, change the parameters as needed using the VFO knob or **BAND+**/**BAND-**. Changes take effect when you exit EDIT mode.

ON / OFF	Set to ON to have this transverter band appear in the band list
RF	Transverter operating frequency (0-999 MHz; GHz digits not used)
IF	K2 band to use as the I.F. (7, 14, 21, or 28 MHz) ¹⁹
OFS	Display offset (+/- 9.99 kHz); calibrate based on transverter oscillator offset, if any
OUT	Power output (set to POT to use the POWER pot, or set fixed level, 1.0-15.0 watts).

¹⁹ When you first select a different I.F., the displayed A and B VFOs may end up outside the intended RF band. To correct this, tune the VFO up or down to the desired frequency, or use direct frequency entry.

Using transverter bands: When you switch to a transverter band (using **BAND+**/**BAND-**), the message **TRN1**, **2** or **3** is flashed. The LCD shows up to 999 MHz by shifting one place to the right, except with 10-Hz tuning. In the 10-Hz case, the hundreds of MHz digit isn't shown.

Direct Frequency Entry on transverter bands is *in-band* only. For bands over 99 MHz, the first digit is made part of the prompt. For example, on a transverter band in the 430 MHz range, you'd see - - - 4 when you hold **BAND+** and **BAND-** together to initiate Direct Frequency Entry. To get to 432.100 MHz, you'd then enter **32100**.

Controlling transverter relays: The 8R HOLD feature can prevent excessive transverter relay switching in CW mode. To change the 8R HOLD setting, locate the **T-R** menu entry (primary menu), edit the parameter, and tap **DISPLAY** to select **8r hold**. (This is the default setting and is recommended for use in all operating modes, whether or not transverters are used.)

Using the K60XV option with transverters: In addition to 60 meter coverage, the K60XV option provides a low-level, split RX/TX path transverter interface²⁰. This interface can be selected on a per-transverter-band basis. The K60XV also provides a buffered relay keying output, and individual logic outputs for each of the three transverter bands. (Refer to the K60XV manual.)

ATU considerations: *Use caution when connecting both a transverter and an HF antenna to the KAT2: you could accidentally transmit at high power into the transverter.* For example, suppose that you have **TRN1** set up for an I.F. of 14 MHz and a 1.0-watt power limit. If you switch the K2 to 14 MHz--where there is no power limit--you must remember not to transmit into the KAT2 antenna jack that is connected to the transverter.

²⁰ Planned for December, 2002 or later. Check our web site for availability of this option.

9. Circuit Details

Before reading this section you should become familiar with the schematics (Appendix C) and Block Diagram (Appendix B).

System Overview

The K2's modular design allows flexibility in configuration and provides for future expansion. At the core of this modular architecture are the three main circuit boards:

Front Panel	User interface, including display and controls
Control Board	MCU, DC control, AGC, and AF amplifier
RF Board	All RF circuitry, relays, and I/O controller (IOC)

This functional division allows related circuits to be grouped together, but also provides a high degree of isolation between the analog and digital sections of the transceiver. The RF board serves as a "mother board," while the front panel and Control boards plug into the RF board at its front edge. The front panel and Control boards are mounted back-to-back, with their ground-plane layers forming a partial enclosure that helps minimize radiated digital noise.

The K2's custom enclosure is also modular. It is fabricated in six pieces, with a unique 2-D fastener used at each joint and also for PCB support. This design provides a rugged but light-weight enclosure that is ideal for field or home use.

The top cover, which includes the upper portion of the rear panel, can support a variety of built-in options such as an internal battery, automatic antenna tuner, and host RS-232 interface. The top cover can be replaced with a 100 W power amplifier module, converting the K2 into a medium-power station.

Signal Flow

The block diagram (Appendix C) shows overall signal flow in the K2. Transmit and receive paths are shown for sideband operation. For CW transmit, the BFO signal is routed directly to the transmit mixer.

The K2 receiver is a single-conversion superhet, utilizing double-tuned band-pass filters on each band and down-conversion to a low I.F (4.915 MHz). This approach results in excellent CW and SSB performance. The low I.F. is compatible with narrow, variable-bandwidth CW crystal filtering and allows the use of fast I.F.-derived AGC. An I.F. of 4.915 MHz also results in nearly no birdies across all nine bands. The BFO is microcontroller controlled to allow upper and lower sideband reception on any band, as well as CW on either sideband. AM signals can be received in SSB modes thanks to the stable VFO, although AM transmit is not currently supported.

Individual (per-band) band-pass filters offer improved intermodulation performance when compared to up-conversion designs that use only a single low-pass filter to remove image products ahead of the receiver. Up-conversion also requires the use of a second I.F. to obtain good CW performance, increasing cost and producing additional spurious signals. (An alternative is up-conversion followed directly by a product detector and audio filter. While this results in minimal parts count, it was not considered since the resulting CW and AGC performance would have been poor.)

On transmit signal flow is reversed, so the BFO is combined with the VCO to generate an output at the operating frequency, which is filtered by the band-pass and low-pass filters. A highly stable power amplifier chain up to 10-15 watts on all bands, and the output level can be set in 0.2-W increments (0.1-W increments below 10 W). The transmit strip is conservatively rated to provide excellent reliability and immunity to high SWR. High-isolation PIN-diode T-R switching is used to provide silent, no-relays QSK. (Please refer to the RF Board section for further details.)

Coverage of 160-10 meters is provided by a single wide-range VCO (voltage-controlled oscillator). High-side and low-side injection are both used, depending on the band, so the overall VCO range is limited to about 6 to 24 MHz. Only one VCO is needed, with a single high-Q inductor and three small DPDT relays configured to select one or more fixed capacitors. The VCO is driven by a PLL synthesizer. 5 kHz frequency steps are used at the PLL, while 10 Hz increments are provided by a 12-bit DAC driving an 11 MHz VCXO (PLL reference oscillator).

Crystal Filters and BFO Settings

The signals you tune in on the K2's receiver are "shaped" by the crystal filter, which passes only a narrow range of frequencies. The *pitch* of these signals is determined by the BFO (beat-frequency oscillator). Figure 9-1 shows an example of how these signals are related. The BFO frequency is *below* the filter passband; this is the case for the CW "normal" and LSB modes on the K2. Two different filters are shown: FL2 (narrow, for CW), and FL1 (wide, for LSB voice). Frequencies in the 4915 kHz range are shown because this is the K2's *intermediate frequency*, or I.F.

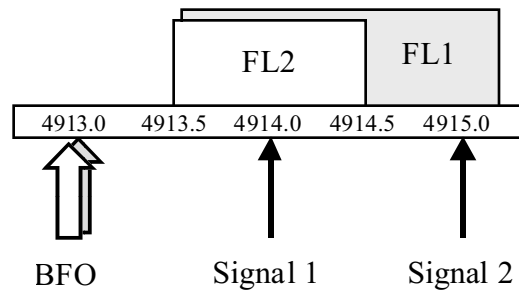

Figure 9-1 CW Normal or LSB.

In this example, filter FL2's bandwidth is set for about 1 kHz, and it is centered at 4914.0 kHz. The BFO is set for 4913.0 kHz.

Signal 1 (4914.0 kHz) will be passed by FL2, and you'll hear it at an audio pitch of 1 kHz (4914-4913). **Signal 2** (4915.0 kHz) will be rejected by FL2, but passed by FL1, and heard at 2 kHz. The same BFO setting can be used for both filters, because the lower boundary of the K2's variable-bandwidth crystal filter stays fixed as it is made wider. Only the upper edge moves significantly.

Figure 9-2 shows the BFO positioned *above* the same two filters, which will allow the K2 to receive USB and CW Reverse (opposite-sideband CW). Since the upper boundary of the filter moves as the filter is widened, the BFO frequency must move the same amount. BFO2 is used with FL2, and BFO1 is used with FL1.

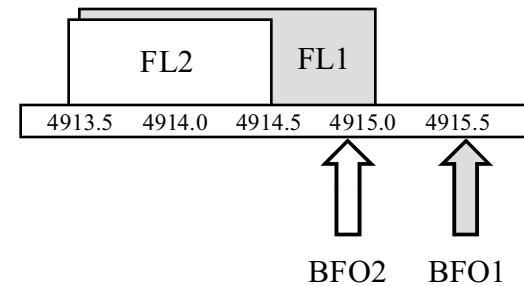

Figure 9-2. CW Reverse or USB.

The **CAL FIL** menu function provides the means to control how wide the filters are, and where the BFOs are located in relation to them. (The numeric parameters you select using **CAL FIL** are translated into voltages that control the filter and BFO by means of voltage-variable-capacitance diodes, or *varactors*.)

Microcontroller (MCU)

The K2's microcontroller is an integral part of all transceiver operations. Firmware is used to advantage to provide many functions traditionally provided by discrete control logic. For example, the VCXO (PLL reference oscillator) is linearized on each band by a firmware auto-calibration routine, with resulting tables stored in EEPROM. Another example is firmware ALC, which is used on CW to maintain the user-specified power level across all bands. The SSB adapter, when installed, provides its own optimized hardware ALC.

Extensive use of firmware also results in many useful operating features not usually found on transceivers in this price class. These features include built-in test equipment (frequency counter and digital voltmeter), auto-calibration, dual VFOs, memories, split operation, RIT/XIT, and a versatile keyer. Provisions have also been made in firmware to support a wide range of option modules. (See full feature list elsewhere on the web site.)

Latching Relays

Latching relays are used for all filter, VCO, and option switching, so there is no relay current drawn during normal operation. This, combined with careful power control at all stages in the transceiver, results in receive-mode current drain as low as 100 mA. The latching relays are all controlled by a single device, the I/O Controller (see below), which also handles other miscellaneous I/O tasks on the RF board. DPDT relays are used for all filter switching, reducing the number of relays needed by a factor of two. 50-ohm switching is used for all filters, and this combined with careful layout and guard-banding of the relays results in excellent filter input/output isolation.

Co-Processors and the AuxBus

In keeping with the K2's modular system architecture, much of the I/O switching is handled by co-processors. There is only one co-processor in the basic K2, the I/O Controller (IOC). Some option modules, such as the SSB adapter, have their own co-processors. This distributed processing technique allows future modifications to be made to option boards without changing the transceiver itself. It also reduces cost of the basic K2, since fewer main-processor control lines are needed.

The IOC, as well as all co-processors on option modules, go into "sleep" mode with their own 4 MHz clocks suspended during normal operation. For this reason, there is virtually no digital noise on the RF board to cause receiver EMI.

When the operator performs an operation that changes relay states, the main microcontroller (on the Control board) wakes up the co-processors and sends one of them a configuration command. These commands are transmitted on a one-wire network called the AuxBus. The AuxBus network line sits at a logic high during normal operation, and is only activated when needed. The receiver is muted during commands, so the operator never hears any digital noise due to AuxBus activity.

Most AuxBus transmissions occur due to operator requests such as a band change. However, the AuxBus may also be used during transmit to relay numeric data such as SWR or ALC from a coprocessor to the main microcontroller. Waking up the coprocessors during transmit has no effect on the transmitted signal.

Front Panel Board

The front panel PC board plugs into the RF board via a 20-pin single-row connector, P1. The Front Panel is made up of a number of user-interface elements as detailed below.

The LCD, DS1, is an 8-digit 7-segment transfective type with three backplanes (triplexed). Its driver, U1, receives display commands via an I²C interface.²¹ The LCD backlight LEDs, D2 and D3, are used to provide enough brightness to handle low-lighting situations ("NITE" mode in the menu), while drawing only a small amount of current (<30 mA). However, they can be turned off when ambient lighting is sufficient ("DAY" mode) because the LCD is transfective, i.e. it can either reflect or transmit light. The LCD displays the operating frequency and status messages, and also has 8 annunciators which indicate the settings of various controls.

A 10-segment LED bargraph, DS2, is used to display received and transmitted signal strength and ALC level. Using the menu, the operator can select OFF, DOT or BAR mode for the bargraph, with OFF or DOT modes typically used to save current during battery operation. U3 and U4 are 8-output MOSFET driver arrays which control the bargraph, among other things. Q1 and Q2 form a brightness control. When the NIGHT(low) control line is pulled to ground by U3, the bargraph supply voltage drops to 2.7 V, resulting in about 6 mA/LED. The LCD backlight is also turned ON in this case. When NIGHT(low) is left high for daytime use, each LED draws about 18 mA, and the LCD backlight is OFF.

A high-quality optical shaft encoder, Z1, provides 100 counts per turn. VFO tuning steps of 10, 50, or 1000 Hz per increment are used, resulting in 1, 5 and 100 kHz per turn, respectively. The encoder is also used to modify parameters in the menu. The encoder can be turned off by U3 to save current under certain operating conditions.

S1-S16 are pushbutton switches. Switch data is read by U2, an 8-bit parallel-to-serial shift register. Each switch has at least two functions: the top label corresponds to a TAP (short press) and the bottom label corresponds to a HOLD (long press, ~0.5s). Switch combinations are also supported, although only two are used (BAND+ and BAND- together enter direct frequency entry mode, and AGC with PRE/ATTN turns AGC on or off).

²¹ I²C stands for Inter-IC Communication, an industry standard serial interface protocol used by Philips and other IC manufacturers.

Potentiometers R1, R2 and R5 (Keyer Speed, Power Out, and RIT/XIT Offset) are multiplexed onto a single A-to-D input of the MCU, the "VPOTS" line, so their position can be read. Firmware hysteresis is used for these controls to prevent noise from interfering with the readings, with more hysteresis on transmit. The AF GAIN control is not read by the MCU; its leads go directly to the input of the AF amp on the Control Board. (The entire path from product detector to AF amp is balanced to prevent common-mode noise pickup—see Control Board for details.) As is true of most modern transceivers, the RF GAIN control actually controls the receiver's IF gain; it varies the DC control voltage on pin 5 of U12 (RF Board).

The circuitry associated with J2, the mic jack, is only present if the SSB option is installed. P1 is a configuration header that the user can wire as needed to support any of several industry-standard microphones with an 8-pin circular connector. Q3 and its associated resistors are used to multiplex the UP, DOWN, and FUNCTION lines from P1 onto the VPOTS line to allow the mic to send commands to the MCU. The PTT line from the MIC activates the DOT-PTT line to initiate transmit. The MICAF line, mic audio output, is amplified and processed by circuitry on the SSB adapter (see Option Modules).

Control Board

The Control board plugs into the RF board via connectors P1, P2, and P3 (along the bottom edge of the schematic). P1 handles for AGC signals while P2 provide miscellaneous I/O. Redundant connections are provided for ground, supply voltages, low-impedance signals (such as audio output) and a few other critical signals.

U6 is a PIC18C452 microcontroller (MCU), with 8 k of EPROM, 300+ bytes RAM, serial I/O, parallel I/O, and A-to-D inputs. It is self-contained with the exception of its 4 MHz crystal oscillator, X2. Even when running at 4 MHz, the PIC processor is very efficient: it only draws a few milliamps at 5 V. Also, since the program and data memories are located on-chip, there is very little noise radiation from the MCU.

To get the most out of the available I/O on the MCU, much of the communication from MCU to the rest of the K2 is done via serial interfaces:

RS232:	Used for communicating with a host computer via P4 (Aux I/O)
I ² C:	Display driver data
SPI:	The serial peripheral interface is used to access various peripherals, including the PLL and DACs.
AuxBus:	1-wire data network for co-processor control
Shift registers:	serial-to-parallel shift registers are used to access MOSFET LED drivers on the front panel; a parallel-to-serial shift register on the front panel is used for reading pushbuttons.

In addition to the microcontroller the Control board provides a number of specialized hardware interfaces. Circuitry is described moving from left to right, top to bottom on the schematic.

U10A and associated circuitry are used to accurately control power output as well as provide CW waveform shaping.

Q9 and Q10 form a two-stage amplifier, supplying a square wave signal to the MCU when the frequency counter is enabled and a probe is connected to P6. The counter amp is turned off at all times except when one of the calibration routines is being used.

The four outputs from the quad DAC (U8) provide: audio tones (via U10B), BFO frequency control (U10D), and crystal filter bandwidth control (U10C). Audio tone pitch, amplitude, and wave shape are controlled in firmware to yield clean sidetone from 400-800 Hz, as well as general-purpose tones. The bandwidth control line doubles as the transmitter driver bias control on transmit.

Note: The sidetone signal is actually generated at pin 4 of U8, which is a logic output, while sidetone volume is set by a D-to-A output of the DAC using Q5 as a variable-drain-voltage saturated switch. The DAC cannot be used to generate sidetone directly because the 60 dB channel-to-channel isolation is not adequate to prevent slight modulation of the VBFO and BVIAS lines on transmit.

U7 provides 2 kbytes of non-volatile configuration data storage. This memory is used for VCO lookup tables, CW messages, frequency memories and other variables that must be permanently saved. The EEPROM can be written millions of times without loss of data. During normal operation on a single frequency (such as when in a QSO), the EEPROM is not accessed at all. However, whenever the VFO is moved, a 30-second timer is triggered. Once the VFO has *stopped* moving for 30 seconds, the EEPROM is updated with the latest VFO frequency. In this way, the K2 always saves the most recent "important" frequency. (The EEPROM update also takes place any time you change bands or operating modes, etc., so you don't have to wait for 30 seconds to record an important configuration change.) An alternative strategy used by many rigs is to use battery-backed-up RAM, continuously recording the operating frequency. However, we preferred to eliminate the backup battery, which often has a high failure rate and must be periodically replaced.

The Control board provides a built-in voltmeter and ammeter. By jumpering P7 appropriately, the operator can monitor either the internal 12 V supply voltage or the voltage from a test probe plugged into P5. U3B buffers the DC signal from the probe, and also is used in conjunction with Q11 to provide supply current monitoring. The current sense resistor, which has a value of 50 milliohms, is located on the RF board (R115).

U4 is a low-dropout 8 V regulator, which is stable with a K2 input DC voltage as low as 8.2 V. Since all signal-generating and signal monitoring stages in the K2 run from this 8 V supply, the transceiver will function normally even when running from very depleted batteries; most transceivers use a higher regulated voltage for these stages and in some cases will not operate reliably even at a battery voltage of 11 V. (Transmit power will be scaled back and a warning message displayed if the battery voltage drops below a critical value or if current drain is excessive.) U5 provides 5 V for logic circuits on the front panel and Control board, but this signal does not appear on the RF board, so noise is minimized.

8 V Switching: Q1 and Q2 provide stable +8 V sources on transmit (8T) and receive (8R). (Q23 on the RF board is used to guarantee that 8R goes to 0 V on receive to maintain proper reverse voltage on T-R switch diodes.)

An optional audio filter module can be mounted on the bottom of the Control board. This filter will provide analog and/or digital signal processing functions. The audio filter module has its own co-processor so that it can be enhanced in the future.

Q6 and Q7 disconnect the AF amplifier from the product detector on transmit, which is necessary for clean QSK. U9 is an LM380 audio amp IC, supplying approximately 1W of audio drive to a 4-ohm speaker in the cover of the K2. Sidetone is injected post-volume control so that sidetone and receiver audio volume can be controlled independently.

The AGC circuit is the only RF stage located on the Control board. Mixer/oscillator U1 generates a low-level signal at about 5.068 MHz, then mixes it with the 4.915 MHz I.F. signal from the RF board to produce a new auxiliary I.F. of about 150 kHz. This auxiliary I.F. signal is then amplified by U2B and detected by D1 to create a positive-going AGC voltage, which is then routed back to the RF board to control the I.F. amp (U12). While it is possible to generate the same AGC voltage by simply amplifying and detecting the 4.915 MHz signal itself, this technique often necessitates shielding of the AGC RF amplifier stages to prevent radiation of the I.F. or BFO signals back into the receiver I.F. strip. We obtain all of the gain at 150 kHz instead, so the 4.915 MHz signal is not re-radiated. 150 kHz is high enough to obtain fast AGC response—two orders of magnitude faster than is possible when audio-derived AGC is employed.

RF Board

The RF board is the largest of the three K2 boards, and serves as a structural element that the chassis and the other boards attach to. This board contains all of the RF circuits (amplifiers, oscillators, filters, etc.). Refer to the RF board schematic (Appendix B).

Sheet 1: Synthesizer

The K2 uses a PLL (phase-locked-loop) synthesizer IC (U4) in conjunction with a wide-range, band-switched VCO (Q18). The synthesizer provides approximately +7 dBm output from 6 to 24 MHz, which is then injected at the transmit and receive mixers (sheet 2). Phase noise performance of the synthesizer is very good despite its low parts count and absence of shielding.

U4 provides coarse tuning (5 kHz steps). Fine steps are achieved using a 12-bit DAC (U5) to tune a voltage-controlled crystal oscillator (Q19), which is the PLL reference oscillator. The reference oscillator range needed on each band varies in proportion to the VCO output frequency. To cover exactly 5 kHz in 10 Hz steps on each band, an automatic calibration routine is provided in firmware. The DAC is swept from its highest output voltage down, and the DAC word needed to select each 100 Hz step is recorded in EEPROM on a per-band basis. 10 Hz steps are then interpolated based on the 100 Hz table data. Crystal X1 in the PLL reference oscillator can be tuned by varactor diodes D16 and D17 over a range of about 10 kHz, which is required in order to tune the full 5 kHz on the lowest band (160 m), but still provides better than 10 Hz resolution on the highest bands.

The synthesizer design is unique in that three inexpensive DPDT latching relays are used to select one of eight VCO ranges, thus requiring only a single high-Q VCO inductor (T5). The relays are optimally interconnected to allow for maximum coverage of the nine HF bands, plus a large out-of-band tuning range. Computer simulation was used to find a relay topology that allowed for the use of standard 5% fixed capacitors along with the smallest practical varactor diode capacitance. As a result, the VCO exhibits low noise on all bands and has a low max/min tuning ratio on each band.

In order to provide some allowance for unit-to-unit variance in T5, a much higher value slug-tuned inductor (L30) is placed across T5's high-impedance winding. L30 has only a small effect on the Q of T5, but provides about a 20% tuning range. The combined parallel inductance is very small (only 1 μ H), resulting in a very large C/L ratio on the lowest bands.

U3 buffers the VCO signal. Q16/Q17 provide stable ALC to keep the VCO voltage fairly constant over the entire frequency range despite variations in the VCO transistor, Q18.

Also shown on sheet 1 is the DC input circuitry (bottom right-hand corner), which is designed to protect the K2 and its power supply from almost any conceivable mis-connection or short. D10 protects the K2 from reverse polarity at the DC input, while dropping only 0.1-0.2 volt. F1 is a thermal self-resetting fuse that goes into a high-resistance state if a short or other high-current situation exists anywhere inside the K2. F1 resets quickly once the source of the short is removed. D12 provides reverse-polarity protection for the internal battery, if applicable.

Sheet 2: Receiver and Low-Level Transmitter Circuits

The receiver is a single-conversion superhet with an I.F. (intermediate frequency) of 4.915 MHz. The preamp and attenuator are switched in using latching relays so that no current is required except when switching them on or off. The mixer is a diode ring type, providing good dynamic range (Z6), and is followed by a strong post-mixer amplifier, Q22. The current drain in Q22 can be reduced by the operator using a menu option that turns off Q12.

A 5-pole variable-bandwidth crystal filter is used on CW (X7-X11). This filter is optimized for use at low bandwidths (~200 to 500 Hz), but can be set both narrower and wider as needed with only a small additional loss. The shape factor and passband ripple content are optimized at around 300 Hz. (On SSB, a separate fixed filter is switched in; this filter is located on the SSB adapter.)

AGC is derived from the output of the I.F. amp by using an auxiliary, low-frequency I.F. of about 150 kHz (see Control Board). The AGC signal is then applied to pin 5 of the I.F. amp (U12).

A second crystal filter (X6/X5) follows the I.F. amp to reduce wideband noise. This filter is also tunable. Varactor diode D39's capacitance is increased during CW use, but on SSB is reduced, making the response quite broad. Q25 turns on only if the optional SSB adapter is installed and its fixed-bandwidth "OP1" filter is selected. This pulls capacitor C179 to ground, which interacts with L34 to shift the second crystal filter's center frequency so that it matches that of the OP1 filter.

The product detector is a Gilbert-cell mixer/oscillator (U11). Due to the loss in the second crystal filter, the input voltage to U11 never exceeds the range that the device can handle.

U11 also provides the BFO signal, which is tunable over about a 4 to 5 kHz range by varactor diodes D37 and D38. X3 and X4 have carefully-controlled characteristics and are well matched. As in the PLL VCXO (Q19, sheet 1), the two crystals de-Q each other to increase the tuning range of the BFO.

On transmit, the BFO buffer/attenuator (Q24) is turned on. Q24's drain voltage is controlled by the microcontroller, providing BFO amplitude control. PIN diode D36 provides additional reduction in low-level signal leakage when Q24 is turned off. U10 mixes the VCO with the BFO on transmit, and video amplifier U9 increases the signal level while providing a low-impedance output to drive the bandpass filters (sheet 3).

Sheet 3: Filters and I/O Controller

The band-pass and low-pass filters are switched with latching relays to minimize loss and current drain. Only five band-pass filters and seven DPDT relays are required to cover nine bands (160-10 m). This is accomplished by switching fixed capacitors in or out using two additional relays. For example, on 160 meters, relay K3 places C13 and C14 across the 80 m band-pass filter. But relay K3 also used to switch the 20 meter band-pass filter to 30 meters by shorting C21 and C23 to ground. K6 places C32/C34 across the 15 m inductors to select 17 meters, or C44/C46 across the 10 m inductors to select 12 meters. The band-pass response is a compromise on 80 and 160 meters but on all other bands is similar to what would be obtained with separate filters.

The low-pass filters also serve double-duty in most cases; five filters cover 8 bands (80-10 m). The 30/20 m filter uses three pi-sections to provide good roll-off of the 20 MHz second harmonic when operating on 30 meters. Most of the filters are elliptic, aiding attenuation of specific harmonics. But elliptic filters are not needed on 40 and 80 meters since these each cover only one band. The 2nd harmonic attenuation provided by the push-pull power amplifier is quite good even pre-filter (sheet 4).

DPDT relays are used for the low-pass and band-pass filters rather than the traditional SPDT approach which requires twice as many relays. This is possible by virtue of careful guard-banding techniques on both top and bottom of the PC board in the filter areas. Isolation between input and output of each filter is excellent across the entire frequency range.

The T-R switch (D1-D5) provides very high isolation using low-cost silicon diodes with a PIN characteristic (1N4007). Q2 is a very high-voltage MOSFET that provides a ground path on receive for D3 and D4, but on transmit this transistor can easily handle the high voltages present on the power amplifier collectors.

U1, a 28-pin PIC microcontroller (16C72 or 16F872), drives all of the latching relays and a few other I/O lines. U1 is referred to it as the I/O controller (IOC) because it handles nearly all I/O functions for the main microcontroller. It also has the job of determining whether the 160 m/RXANT option board is installed by sensing the presence or absence of the two relays on the module. Finally, the IOC contains all of the per-band and per-memory initialization data in ROM, which is sent to the main microcontroller as needed to initialize EEPROM data tables. A number of different regional band plans and other customized parameters can be accommodated in U1's data tables.

The latching relays are wired with a single common drive line so that when one relay needs to be turned on or off, the others are pulled in the opposite direction. This arrangement requires no drivers of any kind. U1's I/O lines are protected from relay transients by its own internal shottky clamping diodes to 6 V and ground. Measured transients are well within the current rating of the clamping diodes. Transients are reduced in amplitude by the series resistance of the other non-switched relays and U1's own MOSFET driver impedance. The relays are rated at 5 V nominal (250-ohm coils). The actual impressed voltage is in the 5 V to 6 V range, depending on ambient temperature, reflecting the best and worst-case sink/source current limits of the 16C72/16F872.

The IOC communicates with the main microcontroller over the 1-wire AuxBus. U1's 4 MHz clock is turned off and the device is in sleep mode at all times, except when it is processing an AuxBus message, so there is no digital noise on receive. The main microcontroller runs from a 5 V supply, while the IOC runs from 6 V. The AuxBus is designed to accommodate devices running at both voltage levels.

Sheet 4: Transmitter Amplifier

Q5 and Q6 are class-A pre-driver and driver stages, respectively. Q5's bias is provided directly by the 8 V transmit line (8T), while Q6's bias is switched on by the 8T line but is gated by Q10. This is necessary because the DAC output that supplies the bias voltage for the driver is used as the crystal filter bandwidth control voltage on receive. The bias to Q6 can be varied under firmware control to optimize efficiency for CW vs. SSB and at different output levels. This is useful in maintaining high overall efficiency during battery operation.

Q7 and Q8 form a conservatively-rated push-pull power amplifier that can easily supply 10 watts or higher output on all bands. Q11 and Q13 are used as a bias voltage regulator. The bias regulator is effectively out of the circuit on CW because of the large size of resistor R62, resulting in approximately a class-B bias level. On SSB, resistor R63 is grounded by the I/O controller, causing much more current flow through Q13 and stabilizing the bias for class AB operation.

10. Options

The K2 can be customized using a variety of internal and external options, which are briefly described here. **Note:** If you press a switch associated with a missing option module, you'll see **NOT INST** (not installed) on the LCD. Menu parameters for missing options will be displayed as "--".

KSB2 SSB Adapter: The KSB2 allows the K2 to transmit and receive LSB and USB, which enables use of voice as well as PSK31, RTTY (AFSK), SSTV, and other data modes. VOX and PTT are supported, and power output can be set from about 0.5 to 15 watts (PEP). The adapter's crystal filter is optimized for SSB transmit and receive, but can also be used for CW or AM receive. Mic gain and speech compression level can be set using the menu. Our **MH2 Heil/Elecraft hand mic** is ideally suited to use with the KSB2.

KNB2 Noise Blanker: The KNB2 is effective on a wide range of noise sources, and includes two gain settings as well as two different blanking pulse widths. The noise blanker is controlled using two dedicated front-panel functions, **NB** and **LEVEL**.

KAT2 Automatic Antenna Tuner (ATU): Our internal QRP ATU handles a wide range of impedances, tunes nearly any antenna—on any band—in seconds, and stores all data for instant band recall. Best of all, it includes an integral dual antenna switch (controlled by **ANT1/2**), providing the functionality of two antenna tuners in one. The KAT2 uses latching relays, so current drain is nearly zero except when an antenna is being tuned.

KAT100 High-Power Automatic Antenna Tuner (ATU): The KAT100 is a rugged, external ATU that's the ideal companion for the K2/100. It can handle up to 150 watts, and like the KAT2, provides two antenna jacks accessible with the **ANT1/2** switch. The KAT100 offers the same matching range, menu control features, and display capabilities of the KAT2, and in addition offers 10 LEDs for real-time monitoring of SWR. **Note:** The KAT100 can be used with the basic K2 as well as the K2/100. The basic K2 must have the KIO2 option installed to control the tuner.

K60XV 60-m Adapter and Transverter Interface²²: The K60XV adds 60 meter coverage and a low-level, split RX/TX transverter interface (~0 dBm).

K160RX 160 m Adapter and RX ANT Switch: The K160RX option includes all components necessary to put the K2 on 160 meters, along with a receive antenna switch. The receive antenna switch is particularly useful on 160 meters, where operators often need a low-noise receiving antenna.



KBT2 Internal 12-V Battery: The rechargeable battery fits snugly into the top cover along with the KAT2 ATU and/or KIO2. Recharging requires an external 13.8-14.2 V regulated power supply, which can also power the transceiver. The internal battery kit includes a rugged, custom-designed battery bracket; gold-plated connectors; reverse-polarity protection diode; and a heavy-duty 10-A disable switch that is accessible from the rear panel.

KIO2 RS232 Interface: This option allows full computer control of the K2, and uses true RS232 signal levels (no external level converter required). It works with most transceiver control and logging software, as well as our own *k2remote* and *k2voice* programs. RS232 voltages are derived from an on-board crystal oscillator rather than a driver IC oscillator, minimizing RF noise.

KAF2 Audio Filter and Real-Time Clock: This module provides 3 kHz low-pass and narrow CW band-pass functions, using low-noise analog circuitry. The **AFIL** switch controls filter selection. The real-time clock provides time/date display, and includes its own long-life backup battery.





KPA100 Internal 100-Watt Stage with RS232 I/O: The KPA100 completes the K2 as a 100 W PEP/CW transceiver. The kit comes with its own top cover/heat sink that replaces the K2's original top cover. If you have the KAT2, KBT2, or KIO2 options, you can leave these installed in the original cover. The KPA100 can then be easily removed, and the original cover reinstalled, when low-power field operation is planned.

²² Check our web site for availability of this option.



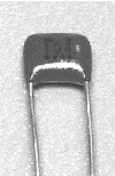
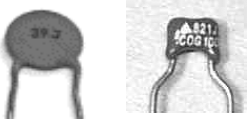

Appendix A	K2 Packing Box Parts List				
PICTURE	Designators	Value	Description	Part Number	QTY
	PCB3	RF	Printed Circuit Board, RF	E100086	1
	B1	left side	Chassis piece, painted	E100076L	1
	B2	right side	Chassis piece, painted	E100076R	1
	B3	front panel	Chassis piece, painted/silk-screened	E100072SS	1
	B4	rear panel / heatsink	Chassis piece, painted/silk-screened	E100075SS	1
	B5	top cover	Chassis piece, painted/silk-screened	E100073SS	1
	B6	bottom cover	Chassis piece, painted	E100074	1
	Bag, Wire Pack		Wire, coax, heatshrink tubing	E850005	1
	Bag, Front Panel Parts		Front Panel board parts	E850003	1
	Bag, RF Parts		RF board parts	E850001A & B	1
	Bag, Control Parts		Control board parts	E850002	1
	Bag, Misc. Parts		Hardware and Misc. parts	E850004	1
	K1, K2, K3, K4, K5, K6, K7, K8, K9, K10, K11, K12, K13, K14, K15, K16, K17	Latching Relay, 5V	In plastic tube; 10-pin DIP	E640001	17
	Manual	K2 Manual		E740001	1
	SP1	Speaker	4-ohm, 3-watt, high-sensitivity speaker	E980007	1
	KN1	Knob, 1.6" diam	Main Tuning Knob, weighted, 6mm shaft	E980013	1
	KN2, KN3, KN4, KN5, KN6	Knob, 0.5" diam	Small Control Knobs, 6mm shaft	E980016	5
	Docs	Toroid Order Form		E740038	1

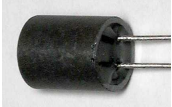
Appendix A		Items inside back of manual		E850011	
PICTURE	Designators	Value	Description	Part Number	QTY
	Misc	Acrylic display bezel	Covers LCD and LED bargraph (FRONT PANEL)	E100080	1
	HW	Thermal insulator, TO220	Adhesive Thermal Insulators for Q6, Q7, Q8 (RF BOARD)	E700002	3
	S/N	Serial Number Label		E980010	1
	Misc	Green filter w/ adhesive	1.15" x 0.95" with adhesive strips. (FRONT PANEL)	E980011	1



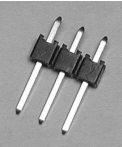
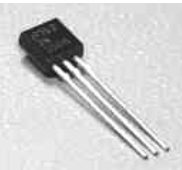

Appendix A

Appendix A		K2 Control Board Parts List (p/n E850002)			
PICTURE	Designators	Value	Description	Part Number	QTY
	C2, C20, C34, C43	.001	Monolithic Cap, "102"	E530001	4
	C12, C24, C36	.0027	Monolithic Cap, "272"	E530055	3
	C3, C5, C9, C10, C11 C17, C18, C23, C35, C37, C39, C40, C41	.01	Monolithic Cap, "103"	E530009	13
	C27	.022	Monolithic Cap, "223"	E530056	1
	C6, C14, C16, C19, C30, C31	.047	Monolithic Cap, "473"	E530025	6
	C25, C26, C42	0.1	Monolithic Cap, "104"	E530011	3
	C4	0.47uF	Monolithic Cap, "474"	E530057	1
	C21	33	NPO disc cap, "33" or "330" (see page 9)	E530064	1
	C8	39	NPO disc cap, "39" or "390"	E530036	1
	C7	330	NPO disc cap, "331"	E530043	1
	C38	680	NPO disc cap, "681"	E530053	1
	C1, C33	2.2μF	Electrolytic cap	E530023	2
	C13, C32	22μF	Electrolytic cap	E530012	2
	C15	100μF	Electrolytic cap	E530061	1
	C28, C29	220μF	Electrolytic cap	E530062	2
	C22	var, 8-50pF	Ceramic trim cap (Green paint on screw with RED Marking on side; or no markings at all.)	E540000	1
	D1, D2	1N4148	Silicon switching diode, small glass body	E560002	2
	D3	1N5817	Shottky diode, black body	E560008	1
	L1	82 mH inductor, 5%	Shielded, cylindrical, dark gray	E690015	1

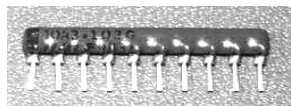

Appendix A

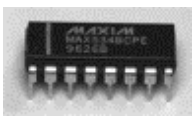
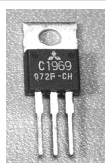



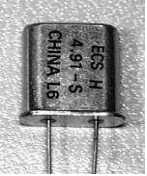

Appendix A		K2 Control Board Parts List (p/n E850002)			
PICTURE	Designators	Value	Description	Part Number	QTY
	P1	6P male, RA	Right Angle 6 pin connector	E620041	1
	P2	18x2 male, RA	Right Angle 18 x 2 pin connector	E620043	1
	P3	10x2 male, RA	Right Angle 10 x 2 pin connector	E620042	1
	P4	5x2 pin male	5 x 2 pin connector; for Aux I/O	E620040	1
	P5, P6	2 pin male	Includes locking ramp; for Volt Meter, Freq. Counter Inputs	E620024	2
	P7	3p male	For voltmeter source selection	E620007	1
	Q1, Q2	2N3906	TO-92	E580000	2
	Q3, Q4, Q5	2N7000	TO-92	E580002	3
	Q6, Q7	J310	TO-92	E580012	2
	Q8, Q11, Q12	PN2222A	TO-92	E580001	3
	Q9, Q10	MPS5179	TO-92	E580014	2
	R8	100, 1%	(BLUE)	E500059T	1
	R7	1.78k, 1%	(BLUE)	E500026T	1
	R10	196K, 1%	(BLUE)	E500051T	1
	R9	806K, 1%	(BLUE)	E500052T	1
	R18, R19	0 ohm	Use short wire jumpers on back (see text)	n/a	2
	R20	2.7 ohm, 5%	(TAN)	E500055T	1
	R16	10, 5%	(TAN)	E500054T	1
	R6	100, 5%	(TAN)	E500010T	1
	R12	820, 5%	(TAN)	E500001T	1
	R4	5.6K, 5%	(TAN)	E500007T	1
	R3, R21	10K, 5%	(TAN)	E500015T	2
	R5	33K, 5%	(TAN)	E500057T	1
	R11	47K, 5%	(TAN)	E500067T	1
	R2, R17	3.3M, 5%	(TAN)	E500021T	2



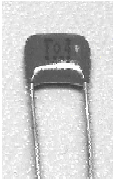

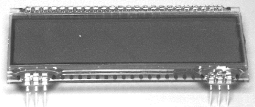
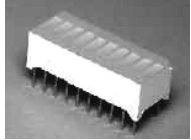
Appendix A

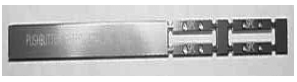

Appendix A		K2 Control Board Parts List (p/n E850002)			
PICTURE	Designators	Value	Description	Part Number	QTY
	R1	50K Trimmer	AGC Threshold	E520011	1
	RP5	470,5R ISO "10A3-471G"	SIP resistor pack, 10 pins; ALT: "770103471"	E510015	1
	RP1	3.9K,5R ISO "770103392"	SIP resistor pack, 10 pins; ALT: "10A3392G"	E510014	1
	RP6	5.1K,5R ISO "770103512"	Sip resistor pack, 10 pins; ALT: "10A3512G"	E510013	1
	RP7	33K,4R ISO "8A3-333G"	SIP resistor pack, 8 pins; ALT: "77083333"	E510016	1
	RP3	47K,5R ISO "10A3-473G"	SIP resistor pack, 10 pins; ALT: 770103473"	E510007	1
	RP2, RP4	82K,4R ISO "77083823"	SIP resistor pack, 8 pins; ALT: "08A3823G"	E510011	2
		U1	SA602AN	AGC Mixer (SA612 Alt.), 8 pins	E600006
U2		LM833N	Dual Op Amp, 8 pins	E600012	1
U3		LMC6482AIN	Dual Op Amp, 8 pins	E600011	1
U9		LM380N-8	Audio Amplifier, 8 pins	E600019	1
U7		25LC320	EEPROM; 4K x 8, 8 pins	E600009	1
	U10	LMC660	Quad Op Amp, 14 pins	E600025	1
	U8	MAX534	Quad, 8-bit DAC, 16 pins	E600031	1
	U4	LM2930T-8	8 Volt regulator, TO-220 Pkg.	E600018	1
	U5	78M05 Alt: 7805, 7805T, L7805	5 Volt regulator, TO-220 Pkg.	E600024	1
	U6	PIC18C452	MCU, Programmed, 40 pins	E610002	1

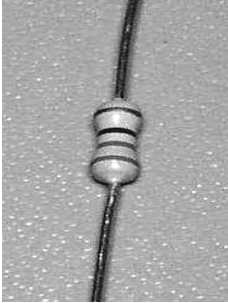

Appendix A

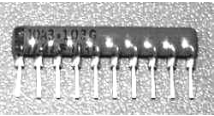

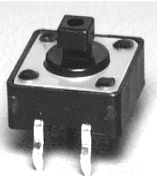
Appendix A		K2 Control Board Parts List (p/n E850002)			
PICTURE	Designators	Value	Description	Part Number	QTY
	X1	5.068Mhz	Crystal, HC49 (may be standard or low-profile)	E660009	1
	X2	4.000MHz	Crystal, HC49 (standard)	E660006	1
	MISC	40 pin socket	socket for MCU	E620017	1
	MISC	2-pin shorting jumper	For use with P7 (voltage source select)	E620055	1
	PCB1	Control	Printed Circuit Board, Control	E100084	1

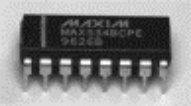
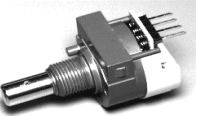

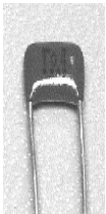

Appendix A	K2 Front Panel Board Parts List (p/n E850003)				
PICTURE	Designators	Value	Description	Part Number	QTY
	C1, C3	.047	Monolithic, "473"	E530025	2
	C2, C9	.01	Monolithic, "103"	E530009	2
	D2, D3	LCD Backlight Assy	LED Backlights mounted in Diffuser	E570004	1
	D4, D5, D6	1N5817	(BLACK)	E560008	3
	DS1	VIM-838-DP	4-character, 7-Segment multiplexed LCD	E570003	1
	DS2	10LED array	Hi-eff. Green LED bargraph	E570005	1
	HW	Felt Washer, 1" OD	Mounts under main tuning knob	E700033	1
	HW	Spacer Set (made from PCB stock)	(4) 0.75" spacers for Backlight LEDs; (1) spacing tool for push button switches	E100079	1
	J1	socket	FP to RF Board	E620025	1
	J2	8p male	Mic Jack; Male; PCB Mount, Round	E620034	1



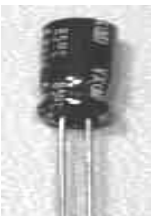

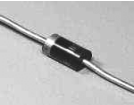

Appendix A	K2 Front Panel Board Parts List (p/n E850003)				
PICTURE	Designators	Value	Description	Part Number	QTY
	Misc	Keycap, rect, black	Black keycaps for Push Buttons (BLACK)	E980000	13
	Misc	Keycap, rect, gray	Band up/down keycap; S1, S3 (GRAY)	E980027	2
	Misc	Keycap, square, black	Rate / Lock Keycap; S7, (BLACK, Square)	E980009	1
	Q1, Q2	PN2222A	Plastic Body, TO-92	E580001	2
	R1, R2, R4, R5	5K potentiometer, linear taper	"B5K"; Keyer Speed, Power Out, I.F. Gain, RIT/XIT Offset	E520004	4
	R3	5K potentiometer, audio taper	"A5K"; Audio Gain Control	E520003	1
	R10	33	1/4W, 5% resistor. (TAN Color)	E500036T	1
	R12	120	1/4W, 5% resistor. (TAN Color)	E500022T	1
	R9	220	1/4W, 5% resistor. (TAN Color)	E500002T	1
	R11	470	1/4W, 5% resistor. (TAN Color)	E500003T	1
	R6, R7	4.7K	1/4W, 5% resistor. (TAN Color)	E500047T	2
	R15	10K	1/4W, 5% resistor. (TAN Color)	E500015T	1
	R16	15K	1/4W, 5% resistor. (TAN Color)	E500060T	1
	R14	100K	1/4W, 5% resistor. (TAN Color)	E500006T	1
	RB1, RB2	Rubber bumper; .040 or .047 thick, x .312" square	For top corners of FP PCB	E980017	2
	RP2	120Ω SIP, "770101121"	SIP 10pin resistor pack; ALT: "10A1121G"	E510012	1
	RP1	100K SIP, "10A1-104G"	SIP 10pin resistor pack; ALT: "770101104"	E510010	1

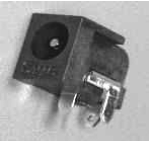

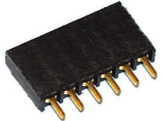

Appendix A		K2 Front Panel Board Parts List (p/n E850003)			
PICTURE	Designators	Value	Description	Part Number	QTY
	S1, S2, S3, S4, S5, S6, S7, S8, S9, S10, S11, S12, S13, S14, S15, S16	switch, push button	Front Panel push button switches	E640005	16
	Misc	40 pin socket	for LCD driver chip, U1	E620017	1
	U1	PCF8566PN	LCD Driver chip, 40 pin	E600027	1
	U2	74HC165N	8-bit parallel-in, serial-out shift register, 16 pin	E600028	1
	U3, U4	TPIC6B595N Alt: 6B595KA	8-bit serial-in, parallel-out shift register, 20 pin	E600032	2
	Z1	Shaft Encoder	100-count incremental encoder w/straight pins; VFO main tuning control	E640003	1
	PCB2	front panel	Printed Circuit Board, Front Panel	E100083	1





Appendix A		K2 RF Board Parts List (p/n E850001A and E850001B)			
PICTURE	Designators	Value	Description	Part Number	QTY
	C1, C2, C9, C17, C26, C27, C37, C38, C39, C49, C57, C64, C77, C79, C80, C81, C82, C89, C91, C100, C140, C167, C195, C204, C207, C208, C216, C223	.001	Monolithic Cap, "102"	E530001	28
	C52, C53, C54, C55, C58, C61, C62, C63, C87, C95, C107, C108, C109, C110, C113, C114, C115, C118, C119, C120, C121, C129, C135, C141, C142, C143, C145, C146, C155, C158, C159, C160, C161, C163, C164, C165, C168, C172, C175, C181, C183, C184, C186	.01	Monolithic Cap, "103"	E530009	43
	C92, C177	.022	Monolithic, "223"	E530056	2
	C90, C94, C117, C138, C156, C157, C162, C166, C170, C196, C224	.047	Monolithic, "473"	E530025	11
	C59, C65, C67, C86, C124, C130, C131, C133, C139, C151, C176, C178, C185	0.1	Monolithic, "104"	E530011	13
	C45	1 pF	NPO, "1", black top	E530068	1
	C33	2.2 pf (alt: 2 pF)	NPO, "2R2" or "2"	E530047	1
	C22	2.7 pf (alt: 3 or 3.3 pF)	NPO, "2R7", "3", "3.3", or "3R3"	E530065	1
	C6	4.7pf (alternate: 5 pF)	NPO, "4.7"	E530048	1
	C68, C211	10	NPO, "10" or "100" (see page 9)	E530006	2
	C28, C29, C219	12	NPO, "12" or "120"	E530058	3
	C74	20	NPO, "20" or "200"	E530059	1
	C198	27	NPO, "27" or "271"	E530060	1
	C43, C47, C116, C213	33	NPO, "33" or "330"	E530064	4



Appendix A		K2 RF Board Parts List (p/n E850001A and E850001B)			
PICTURE	Designators	Value	Description	Part Number	QTY
 	C221	39	NPO, "39" or "390"	E530036	1
	C20, C24, C73, C203	47	NPO, "47" or "470"	E530014	4
	C31, C35, C122, C228	56	NPO, "56" or "560"	E530015	4
	C153, C104, C214	68	NPO, "68" or "680"	E530007	3
	C71, C174, C210	82	NPO, "82" or "820"	E530038	3
	C5, C7, C144, C154, C179, C197, C222	100	NPO, "101"	E530016	7
	C84, C85, C202	120	NPO, "121"	E530041	3
	C200, C212, C218	150	NPO, "151"; markings on rear side may include: "041 RKF"	E530049	3
	C182	180	NPO, "181"	E530008	1
	C173, C199, C201, C220, C229	220	NPO, "221"	E530042	5
	C72	270	NPO, "271"	E530050	1
	C19, C25, C42, C48, C150, C227	330	NPO, "331"	E530043	6
	C169, C225	390	NPO, "391"	E530051	2
	C30, C36	470	NPO, "471"	E530004	2
	C12, C15	560	NPO, "561"	E530052	2
	C127, C128, C226	680	NPO, "681"	E530053	3
	C4, C8	820	NPO, "821" (Do not confuse with 150pf)	E530066	2
	C190, C192	1200	NPO, "122"	E530005	2
	C11, C16, C191	1800	NPO, "182"	E530035	3
		C96	1uF	Monolithic Cap (Thick) "105"	E530037
C105, C106, C111		2.2uF	Electrolytic	E530023	3
C93		10uF	Electrolytic	E530045	1
C125		22uF	Electrolytic	E530012	1
C126		47uF	Electrolytic	E530063	1
C60, C137		100uF	Electrolytic	E530061	2
C103		220uF	Electrolytic	E530062	1



Appendix A	K2 RF Board Parts List (p/n E850001A and E850001B)				
PICTURE	Designators	Value	Description	Part Number	QTY
	C44, C46, C32, C34	var,5-30pF	ceramic trimmer (see below to tell from 50 pF)	E540001	4
	C21, C23	var,8-50pF	ceramic trimmer (red mark or bagged separately)	E540000	2
	D9	1N5711	orange glass body	E560004	1
	D1, D2, D3, D4, D5, D6, D7, D36	1N4007	large black body, silver band	E560001	8
	D8, D11, D13, D18	1N4148	clear or blue glass body	E560002	4
	D10	95SQ015	ultra-low-drop shottky diode, 9A, very large black body	E560009	1
	D12	SB530 (alternate: 1N5821)	shottky diode, 5A, very large black body	E560003	1
	D16, D23, D24, D25, D26, D39 (also D19-D20--see description)	MV209	TO-92, 2 leads D19-D20 supplied with K60XV option	E560006	6
	D17, D21, D22, D29, D30, D31, D32, D33, D34, D37, D38	1SV149	TO-92, 2 leads	E560005	11
	F1	RGE300	Resettable fuse; (YELLOW) "G300" Looks like a larger monolithic cap.	E980018	1
	J8	10x2,female socket	10 x 2 female socket	E620038	1
	J7	18x2,female socket	18 x 2 female socket	E620039	1
	J3	2.1mm jack	2.1 mm DC barrel connector	E620026	1

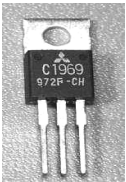

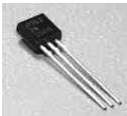
Appendix A		K2 RF Board Parts List (p/n E850001A and E850001B)			
PICTURE	Designators	Value	Description	Part Number	QTY
	J6	6p,female socket	6 x 1 female socket	E620037	1
	J4	BNC	Antenna connector	E620020	1
	J1	SJ-373	Keyer Jack, Threaded, Stereo, Vertical orientation	E620027	1
	J2	Stereo+iso sw.	Headphone jack. Horizontal Orientation	E620028	1
	L10, L11, L12, L13	Variable Ind, 1 μ h "T1050Z"	TOKO , 15/17m BPF, 10/12m BPF. Small adjustment slot	E690002	4
	L30, L1, L2, L3, L4, L8, L9, L34	Variable Ind, 4.7 μ H "T1005Z"	TOKO , VCO, IF, 40m BPF, 80/160m BPF, 20/30m BPF. Large adjustment slot	E690001	8

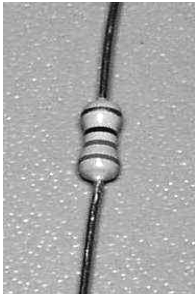

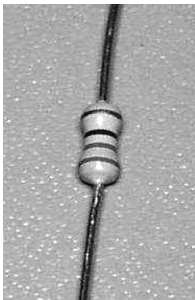
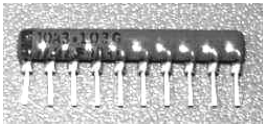
Appendix A		K2 RF Board Parts List (p/n E850001A and E850001B)			
PICTURE	Designators	Value	Description	Part Number	QTY
	L31	10µH , Shielded	solenoidal, shielded, DELEVAN (BLACK)	E690005	1
	L33	Pre-wound toroidal inductor, 41 µH, 5%, T44-7 core	FRAGILE LEADS--HANDLE WITH CARE. SEE TEXT FOR MOUNTING INSTRUCTIONS USING 1/8W RESISTOR	E690018	1
	L21, L22, L23, L24	T44-10	Toroid (BLACK); 12/10m LPF(.32µH, .26µH); 17/15mLPF(.45µH)	E680009	4
	L16, L17, L18, L19, L20, L25, L26	T44-2	Toroid (RED); 80m LPF(2.50µH); 20/30m LPF(.58µH, .44µH, .37µH); 40M LPF (1.25µH, 0.89µH)	E680012	7
	L5	33µH solenoidal	green body; orange-orange-black	E690007	1
	RFC6	0.68µH solenoidal	green body; blue-gray-silver	E690008	1
	RFC1, RFC2, RFC12, RFC13,	100µH solenoidal	green body; brown-black-brown	E690004	4
	RFC4, RFC5, RFC8, RFC9	10µH solenoidal	green body; brown-black-black	E690009	4
	RFC15	100µH solenoidal, subminiature	very small tan body; brown-black-brown	E690013	1
	RFC7	15µH solenoidal	green body; brown-green-black	E690006	1
	RFC10	1mH solenoidal	green body; brown-black-red	E690010	1
	RFC3, RFC11, RFC14, RFC16		0.37" dia. ferrite core (GRAY) RFC3, 47µH, 16T; RFC11, 100µH, 20T RFC14, 18µH, 10T; RFC16, 47µH, 16T		
	T1, T2, T6, T7	FT37-43	0.37" dia. ferrite core (GRAY) T1, 9:3T; T2, 12:8T; T6, 10T bifilar; T7, 5:20T	E680003	8
	T3	FT50-43	Toroidal transformer on 0.50" dia. ferrite core (GRAY). 5T bifilar.	E680008	1
	T5	T50-6	Toroidal transformer on 0.50" dia. iron-powder core (YELLOW), 1.3µH, 16:4T	E680010	1

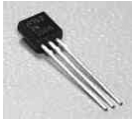

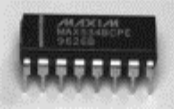
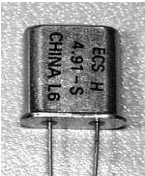
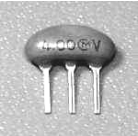
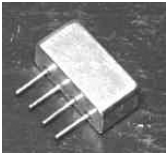

Appendix A	K2 RF Board Parts List (p/n E850001A and E850001B)				
PICTURE	Designators	Value	Description	Part Number	QTY
	T4	Binocular core	2:3:1:1, Balun Core; Square, Two Holes	E690011	1
	Z1, Z2	Ferrite Bead	2 (GRAY) ferrite beads ea. on bare wire (see text)	E980029	4
	P1	20 x 1 ,male, RA	20 pin male, right angle. To Front Panel, J1	E620029	1
	P5	2p,male	2 pin male. For Speaker; Locking Ramp	E620024	1
	Q5, Q21, Q22	2N5109	Pre-Amp, Post Amp, Pre-Driver	E580013	3
	Q7, Q8	2SC1969	Push-Pull Finals	E580008	2
	Q6	2SC2166	Driver	E580007	1





Appendix A		K2 RF Board Parts List (p/n E850001A and E850001B)			
PICTURE	Designators	Value	Description	Part Number	QTY
	Q10, Q12, Q17, Q20, Q23	2N7000	TO-92	E580002	5
	Q18, Q19, Q24	J310	TO-92	E580012	3
	Q11, Q13, Q16, Q25	PN2222A	TO-92	E580001	4
	Q2	ZVN4424A	Slightly Thinner TO-92 Style	E580005	1
	R115	0.05 ohm	1%, 3W Current Sense, (BLACK)	E500050	1
	R116	5.1 megohm	5%, 1/8W (grn-brn-brn); for L33--see text	E500086	1
	R68	226	1%, 1/4W (BLUE)	E500033T	1
	R67	1.5k	1%, 1/4W (BLUE)	E500034T	1
	R50	1.5 ohm, 1/2 watt	(TAN)	E500025T	1
	R42, R53, R54, R83	4.7 ohm	(TAN)	E500062T	4
	R76	10	(TAN)	E500054T	1
	R82, R84	18	(TAN)	E500061T	2
	R43, R78, R112	22	(TAN)	E500028T	3
	R15, R55, R56, R92, R97	33	(TAN)	E500036T	5
	R45, R47, R74	47	(TAN)	E500019T	3
	R7	68	(TAN)	E500058T	1
	R35, R36, R94, R113	82	(TAN)	E500038T	4
	R6, R8, R60, R64, R89	100	(TAN)	E500010T	5
	R30, R48, R49, R61	120	(TAN)	E500022T	4
	R85	150	(TAN)	E500011T	1
	R58	180 ohm, 1/2 watt	(TAN)	E500049T	1
	R1, R2, R63, R77	220	(TAN)	E500002T	4
	R20, R46, R98, R99	270	(TAN)	E500039T	4
	R10, R40, R72, R88, R90	470	(TAN)	E500003T	5
	R11, R12, R41	560	(TAN)	E500046T	3



Appendix A	K2 RF Board Parts List (p/n E850001A and E850001B)				
PICTURE	Designators	Value	Description	Part Number	QTY
	R75, R80	680	(TAN)	E500040T	2
	R91, R93, R100	820	(TAN)	E500001T	3
	R38, R39	1K	(TAN)	E500013T	2
	R79, R81	1.8K	(TAN)	E500004T	2
	R5, R19, R24, R25, R34, R44, R62, R66, R73, R95, R96	2.7K	(TAN)	E500005T	11
	R114	3.9K	(TAN)	E500009T	1
	R59	4.7K	(TAN)	E500047T	1
	R110, R111	5.6K	(TAN)	E500007T	2
	R13, R14, R29, R31, R32, R65, R101	10K	(TAN)	E500015T	7
	R33	15K	(TAN)	E500060T	1
	R28	27K	(TAN)	E500056T	1
	R9, R16, R17, R21, R37, R69, R107	100K	(TAN)	E500006T	7
	R18	1M	(TAN)	E500024T	1
	R22	3.3M	(TAN)	E500021T	1
	RP4, RP5	100K, 3R ISO; "6A3-104G"	SIP; resistor pack, 6 pins; ALT: "77063104"	E510017	2
	RP6	100K, 4R ISO; "8A3-104G"	SIP; resistor pack, 8 pins; ALT: "77083104" or "B104G"	E510018	1
	RP2, RP3	10K, 4R ISO; "8A3-103G"	SIP; resistor pack, 8 pins; ALT: "77083103"	E510005	2
	TP1, TP2, TP3	test point, female	VFO, BFO, PLL REF test points	E620036	3
	U1	16C72 Alt: 16F872	Relay Driver PIC; I/O Controller; programmed	E610004	1
	U2	78L06AWC	TO-92, 6v Reg. For relays	E600001	1

Appendix A	K2 RF Board Parts List (p/n E850001A and E850001B)				
PICTURE	Designators	Value	Description	Part Number	QTY
	U3, U9	LT1252	8 pin DIP, VFO Buffer; TX Buffer	E600020	2
	U5	LTC1451	8 pin DIP, 12-Bit DAC for Reference Freq. Of PLL	E600016	1
	U6	LMC662	8 pin DIP, (rail-to-rail out); PLL Loop filter	E600026	1
	U10, U11	NE/SA602	8 pin DIP, mixer; alt: NE/SA612	E600006	2
	U12	MC1350P	8 pin DIP, IF Amp / AGC	E600000	1
	U8	78L05	5-volt reg. (100mA)	E600029	1
	U4	MC145170P2 (or P1)	16 pin DIP, PLL	E600016	1
	W1, W2, W3, W5, W6	1" bare wire	Use component leads		0
	X1 (X2 not used)	12096 kHz	PLL reference oscillator crystal; HC-49	E850007	1
	X3, X4	4915.2 kHz	BFO crystals; matched set; HC-49 Typical labeling: ECS D 4.91 -S	E850008	2
	X5, X6, X7, X8, X9, X10, X11	4913.6 kHz	Filter crystals; matched set, HC-49 Typical labeling: ECS V 4.9136-S	E850006	7
	Z5	4.000MHz Resonator	Ceramic resonator w/caps; 0.2% tolerance	E660001	1
	Z6	TUF-1	Balanced diode mixer	E980025	1

Appendix A	K2 RF Board Parts List (p/n E850001A and E850001B)				
PICTURE	Designators	Value	Description	Part Number	QTY
	S1	DPDT	Power Switch	E640006	1
	MISC	Keycap; TAC-BLK	Power Switch Keycap; rectangular	E980023	1
	MISC	28 pin socket, 0.3" DIP	Socket for U1	E620011	1
	HW	heatsink TO5 Flush	Crown heatsink; for Q22	E700029	1
	HW	D, phenolic; RAF #1122-4- PH (COLOR: BROWN)	For PA Transistor Mounting	E700034	2
	HW	stem bumper, 0.5" dia., black rubber	For L33 (BFO)	E980005	1
	HW	washer, nylon, #4	0.375" diameter (For T5)	E700035	1
	HW	4-32, nut, nylon	nut, nylon (For T5)	E700021	1
	HW	4-32,screw, nylon x 1/2"	screw, pan head, nylon (For T5)	E700022	1

Appendix A		K2 Misc. Bag Parts List (p/n E850004)			
PICTURE	Designators	Value	Description	Part Number	QTY
	HW	#4 lockwasher	internal tooth	E700010	41
	HW	2-56,screw , 1/8", STAINLESS	fillister head, STAINLESS 2-56 x 1/8",slotted, for LCD bezel	E700023	4
	HW	2-D Fastener	Chassis fasteners	E100078	11
	HW	4-40 nut, Steel-ZN		E700011	18
	HW	4-40 screw, 3/8", black	pan-head Phillips screw, black oxide steel (incl. spares)	E700008	11
	HW	4-40 screw, 3/16", black	spares)	E700015	56
	HW	4-40 screw, 82 deg. Flt Hd, black	3/16", flathead Phillips, 82 deg, 0.21 dia head, black oxide steel (front panel)	E700025	1
	HW	4-40 screw 1/2", black	Phillips, for mounting PA transistors	E700030	2
	HW	4-40 screw 7/16", steel-ZN	Phillips, for mounting feet and tilt stand	E700032	6
	HW	4-40 standoff 1/4" long x 3/16"	Threaded	E700026	5
	HW	4-40 standoff, 1/2" x 1/4" Dia.	Threaded hex 0.5" x 0.25" dia.	E700007	2
	HW	Shoulder washer, nylon, black	For PA transistors	E700001	2
	HW	Cable tie - Small	For speaker wiring and RF probe	E980002	4
	HW	Tilt stand set + 4 feet	Two oval front feet, tilt stand, two rear feet	E980019	1
	HW	#4 washer, fibre, black	For speaker and PA transistor mounting	E700031	6
	SPK-J2	1/8" phone jack, mono w/switch	Panel-mount jack for ext. speaker	E620035	1

Appendix A		K2 Misc. Bag Parts List (p/n E850004)			
PICTURE	Designators	Value	Description	Part Number	QTY
	SPK-J1	2 pin female conn. Housing	0.1" spacing w/locking ramp, int. speaker plug	E620021	1
	ACC-P1	2.1mm male conn.	Mates with DC power jack	E620032	1
	ACC-P2	stereo 1/8" phone plug	Plug for hand key/keyer/paddle/computer input	E620033	1
	Misc	female crimp pins	For 2-pin speaker housing (SPK-J1)	E620022	2
	Misc	plastic tuning tool, p/n MARS-12	For aligning slug-tuned inductors (GREEN)	E980012	1
	Misc	Allen wrench	Long-handled, for large knobs and for Control board removal	E980004	1
	Misc	Allen wrench	Short-handled, for small knobs	E980008	1

Appendix A		K2 Misc. Bag Parts List (p/n E850004)			
PICTURE	Designators	Value	Description	Part Number	QTY
Appendix A		K2 Probe Assemblies Parts List (p/n E850036 envelope in E850004 Misc bag)			
PICTURE	Designators	Value	Description	Part Number	QTY
	FCP-C1	10pf cap	Axial Leads (like a resistor); counter probe	E530067	1
	RFP-C1	.01 μ F cap	Monolithic capacitor, for optional RF probe	E530009	1
	RFP-D1	1N34A diode	For RF probe; germanium	E560000	1
	FCP-E1	1 pin male probe tip	For counter probe	E620044	1
	FCP-J1, VMP-J1	2 pin female housing	For counter and voltmeter probes	E620021	2
	Misc	female crimp pins	For counter and voltmeter probes	E620022	3
	Misc	Aligator clip, insulated	For RF probe (ground)	E700074	1
	Misc	Banana plug, red	For RF probe (DMM positive lead)	E700076	1
	Misc	Banana plug, black	For RF probe (DMM negative lead)	E700075	1
	RFP-R1	4.7M Resistor	5%, 1/4W; For RF probe	E500048	1

Appendix A		K2 Wire Bag Parts List (p/n E850005 bag)			
PICTURE	Designators	Value	Description	Part Number	QTY
	Misc	#26 Red Enamel Wire	For toroids	E760002	30 ft
	Misc	#28 Red Enamel Wire	For L33 (BFO); bagged separately	E760003	3 ft
	Misc	#26 Green Enamel Wire	For toroids	E760004	8 ft
	Misc	Green solid hookup wire, #24	Insulated wire for T4, misc. wiring	E760008	3 ft
	Misc	White solid hookup Wire, #24	Insulated wire for T4, misc. wiring	E760013	1 ft
	Misc	Black stranded hookup wire, #24	For RF probe	E760016	6"
	Misc	RG174 Coax Cable	For counter and RF probes	E760010	3 ft
	Misc	#24 Dual-conductor speaker wire	For speaker and ext. speaker jack	E760012	2 ft
	Misc	Grill Cloth	Must be cut to speaker size; see text	E850089	3x3"
	Misc	Heat Shrink; 3/16" dia.	For counter probe.	E980028	4"

Relay Table

SET Relays

Band	BPF	LPF	VCO
160m	K2	160m-K1	-
80m	K2, K3	K8	K13
+60m	K1, 60m-K1	K12	K13, K14
*40m ALT	K1	K12	K13, K14
40m	K1	K12	K14
30m	K3, K4	K9	K14, K15
20m	K4	K9	K13, K14, K15
17m	K5	K11	K13, K15
15m	K5, K6	K11	K15
12m	K6, K7	K10	K13, K14, K15
10m	K7	K10	K13, K15

+ 60 meters is available only if the K60XV option is installed.

*40m ALT applies if D19-D20 are not installed.

NOTE: All relays are single-coil latching type and are shown in the RESET position in schematics.

Relay pins 5 and 6 are not connected internally.

Diodes

1Nxxxx

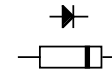

MV209, 1SV149



Transistors

2N7000
ZVN4424

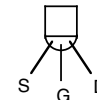

2N3906
PN2222A
MPS5179

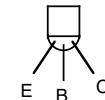

J310

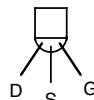

2N5109



2SC2166
2SC1969

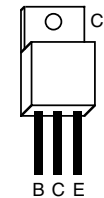

Integrated Circuits

PLASTIC DIP
(DUAL-INLINE PACKAGE)

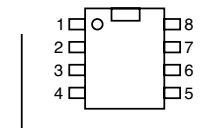

COUNT PINS STARTING AT
PIN 1 AND GOING COUNTER-
CLOCKWISE (8-PIN DIP SHOWN)

VOLTAGE REGULATORS

78L05, -06

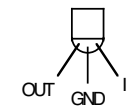

2930T-8, 78XX

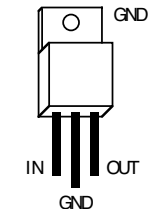

VCO Table

Band	Fixed Cap., pF	Total Cap., pF*	VCO Freq. at band edge**
160m	C75 (470)	525-629	6715 (subtract)
80m	C72 (270)	325-429	8415 (subtract)
60m	C71+C73 (129)	215-259	10165 (subtract)
***40m ALT	C71+C73 (129)	163-209	11915 (subtract)
40m	C71 (120)	154-203	11915 (subtract)
30m	C73+C74 (67)	102-131	14915 (subtract)
20m	C74 (20)	55-84	18915 (subtract)
17m	none (0)	35-64	22915 (subtract)
15m	C73 (47)	82-111	16085 (add)
12m	C74 (20)	55-84	19975 (add)
10m	none (0)	35-64	23085 (add)

* This includes capacitance of varactor diodes D23-D26 on all bands, D21-D22 on 80 -160 m, and D19-D20 on 40 and 60 meters (if applicable). Only a portion of the indicated capacitance range is actually used to cover each Amateur band segment. VCO frequency can be calculated based on a total inductance of 0.95 μ H (T5 in parallel with L30).

** Based on an I.F. of 4915 kHz (e.g., 6715 - 4915 = 1800).
5250 kHz used as 60-meter lower band edge (pending U.S. FCC ruling).

***40m ALT applies if D19-D20 are not installed.

Special Symbols

= On bottom of PC board.

= Jumper

Elecraft K2 Schematic Key			
By W. Burdick E.Swartz	Rev. D	Date 10/23/02	Sht. 1 of 1

Appendix B

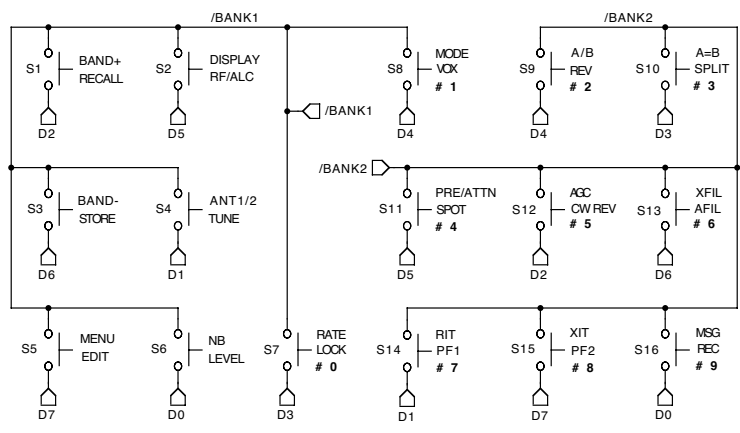
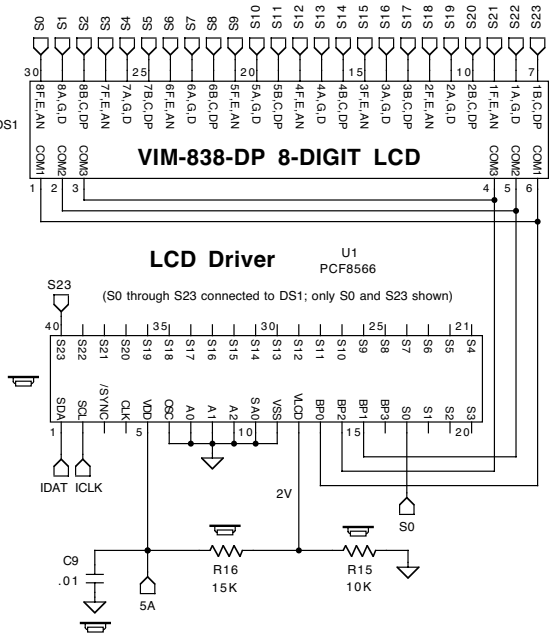
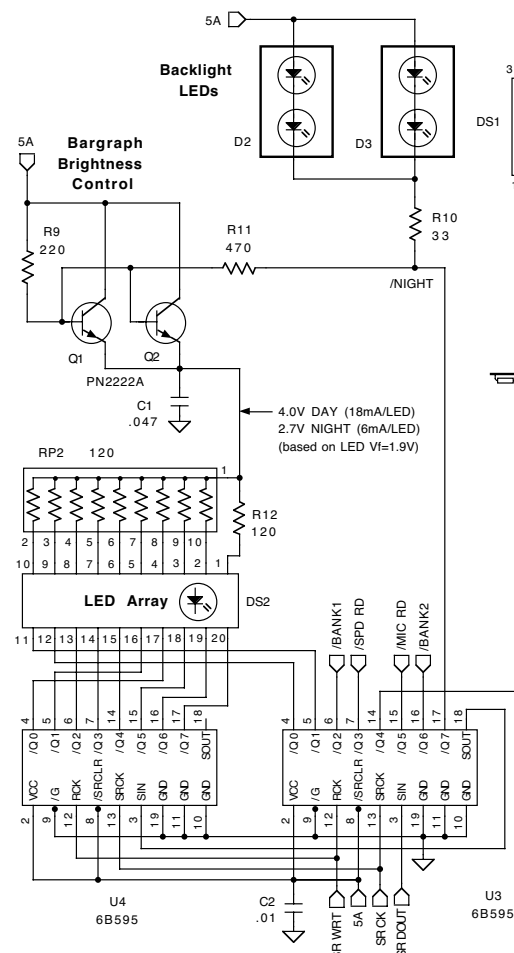

Pushbutton Switches

First switch label corresponds to switch TAP, Second label corresponds to switch HOLD. S7 - S16 can also be used as a numeric keypad.

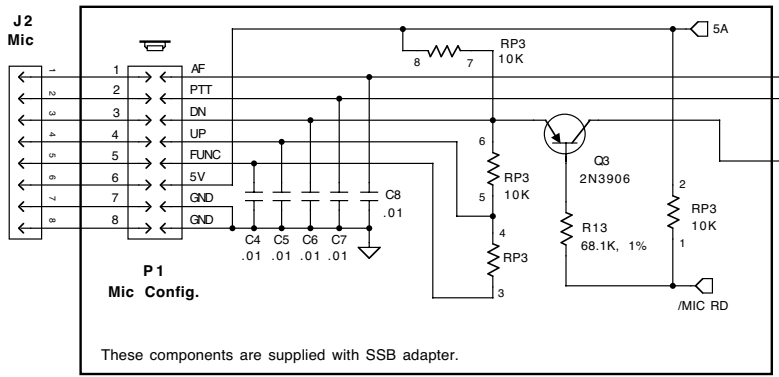
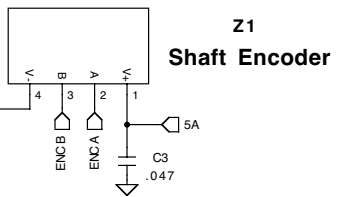
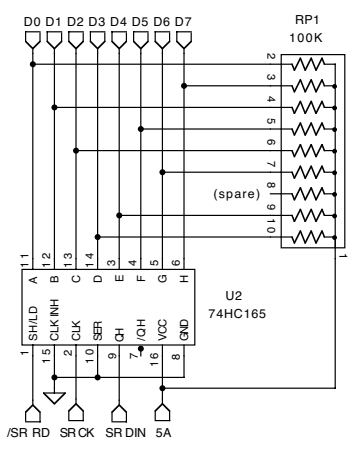

These components are supplied with SSB adapter.

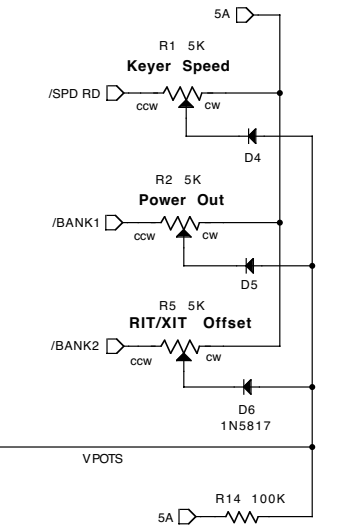
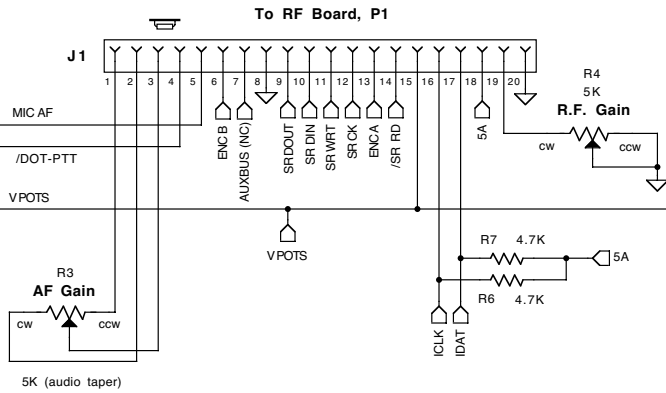

Elecraft K2 Front Panel Board			
By	Rev.	Date	Sht.
W. Burdick	C	10/6/02	1 of 1
E. Swartz			

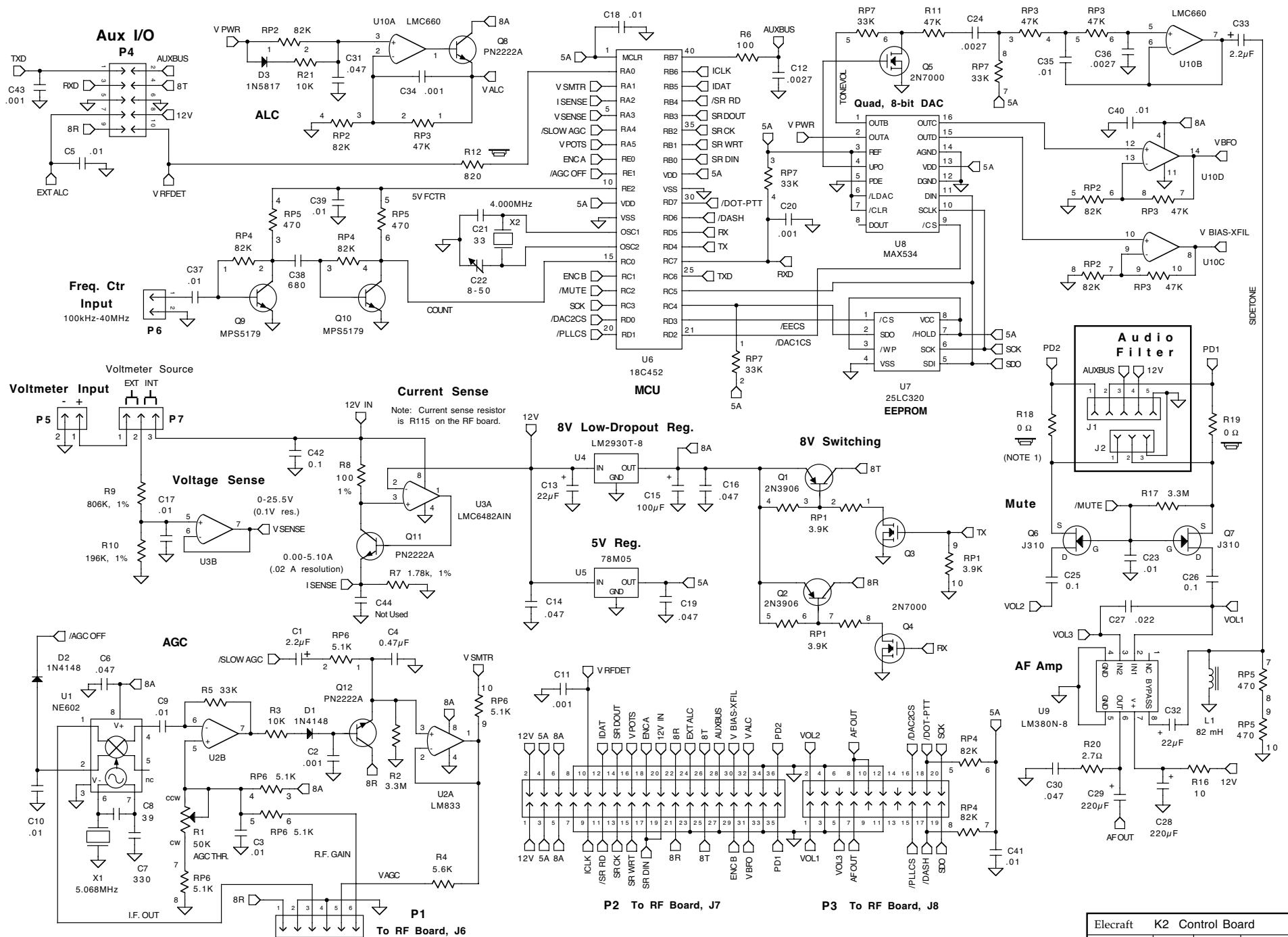

Elecraft K2 Control Board			
By W. Burdick	Rev. E	Date 2/16/03	Sht. 1 of 1

NOTE 1: Jumpers are used at R18 and R19. They must be removed if the Audio Filter option is installed.

☐ = on bottom of PC board

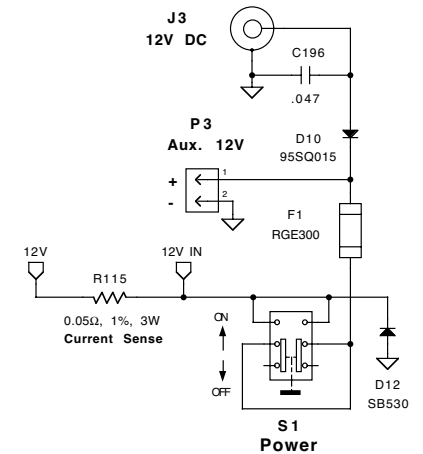
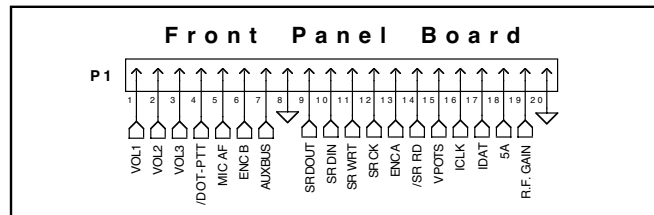
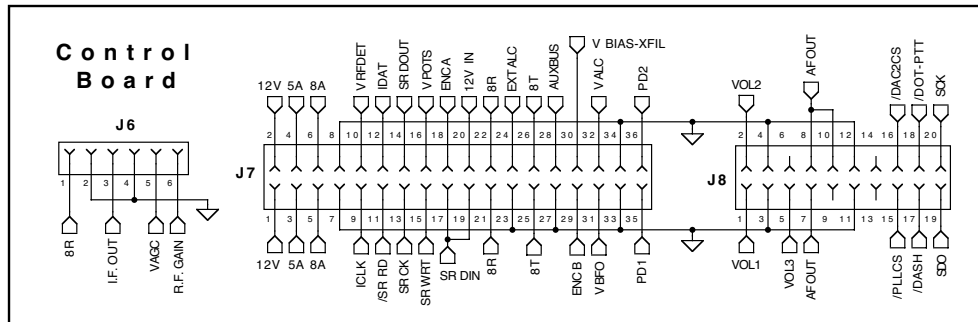
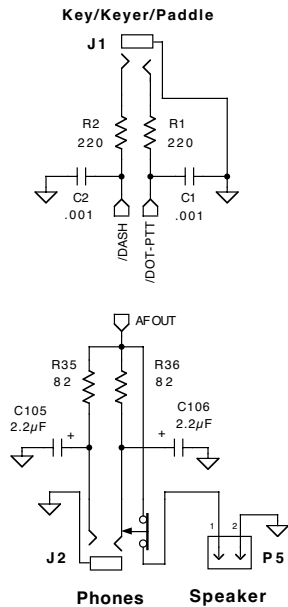
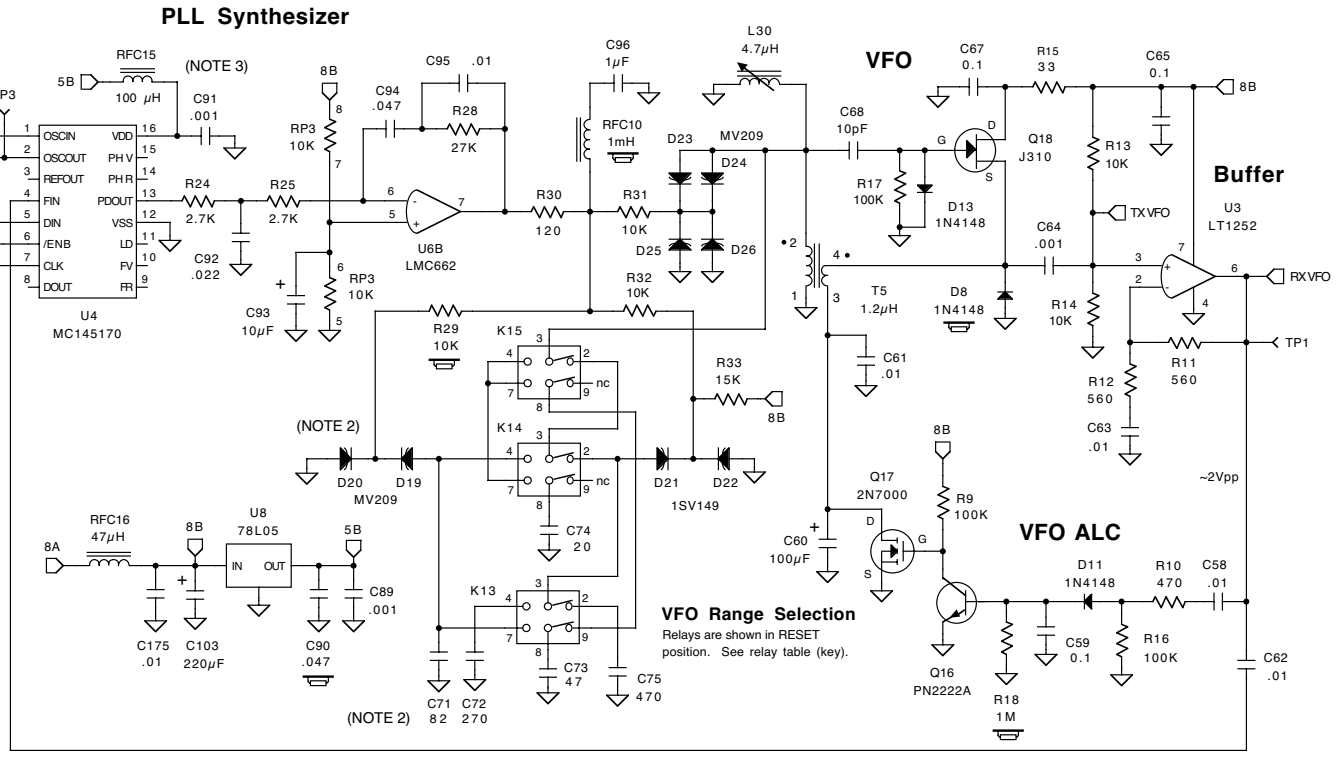
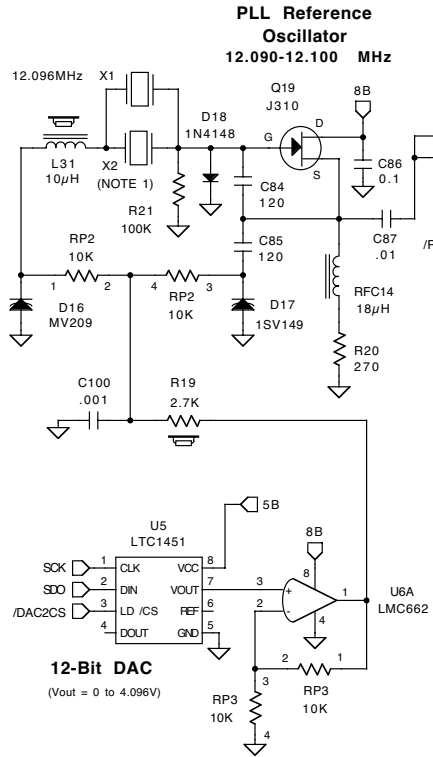

Elecraft K2 RF Board			
By W. Burdick	Rev. E	Date 2/16/03	Sht. 1 of 4

NOTE 1: X2 is not used.
 NOTE 2: If D19-D20 are installed, C71 must be changed to 120 pF, and the "D19" menu entry set to "Y".
 NOTE 3: These components are not present on the Rev B or earlier RF board, but must be added (see text).

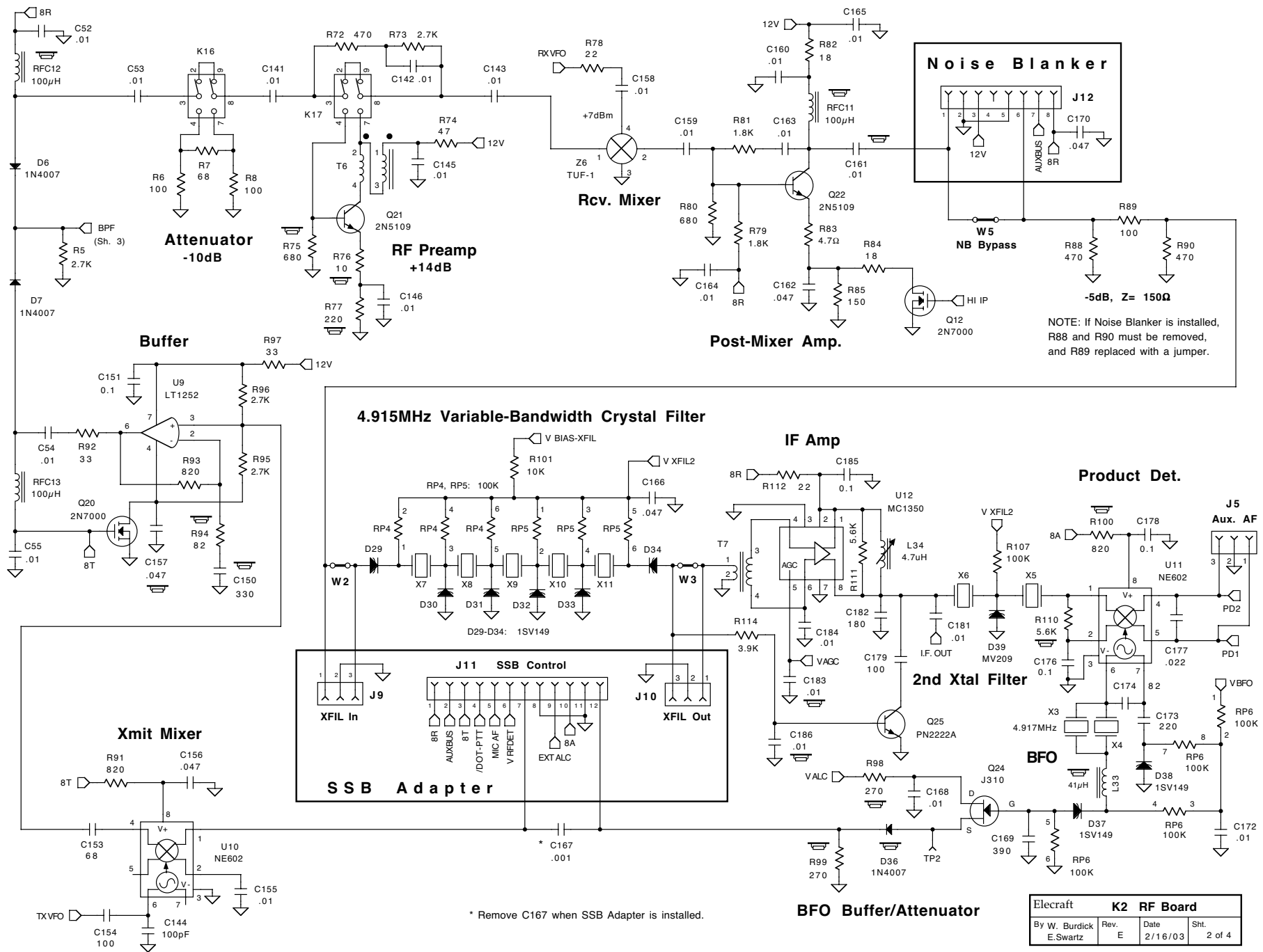

* Remove C167 when SSB Adapter is installed.

Elecraft K2 RF Board			
By W. Burdick E.Swartz	Rev. E	Date 2/16/03	Sht. 2 of 4

Appendix B

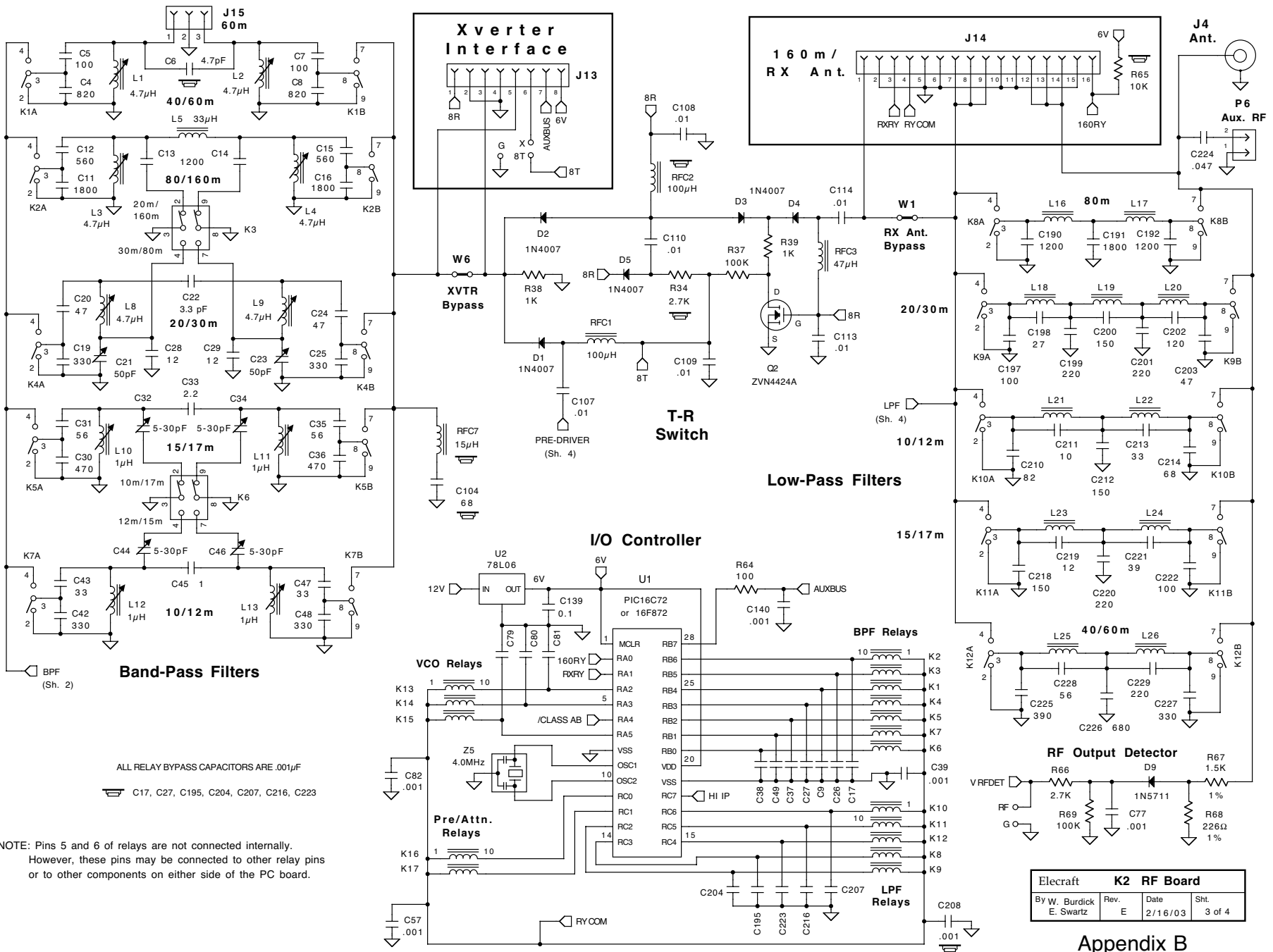

NOTE: Pins 5 and 6 of relays are not connected internally. However, these pins may be connected to other relay pins or to other components on either side of the PC board.

Appendix B

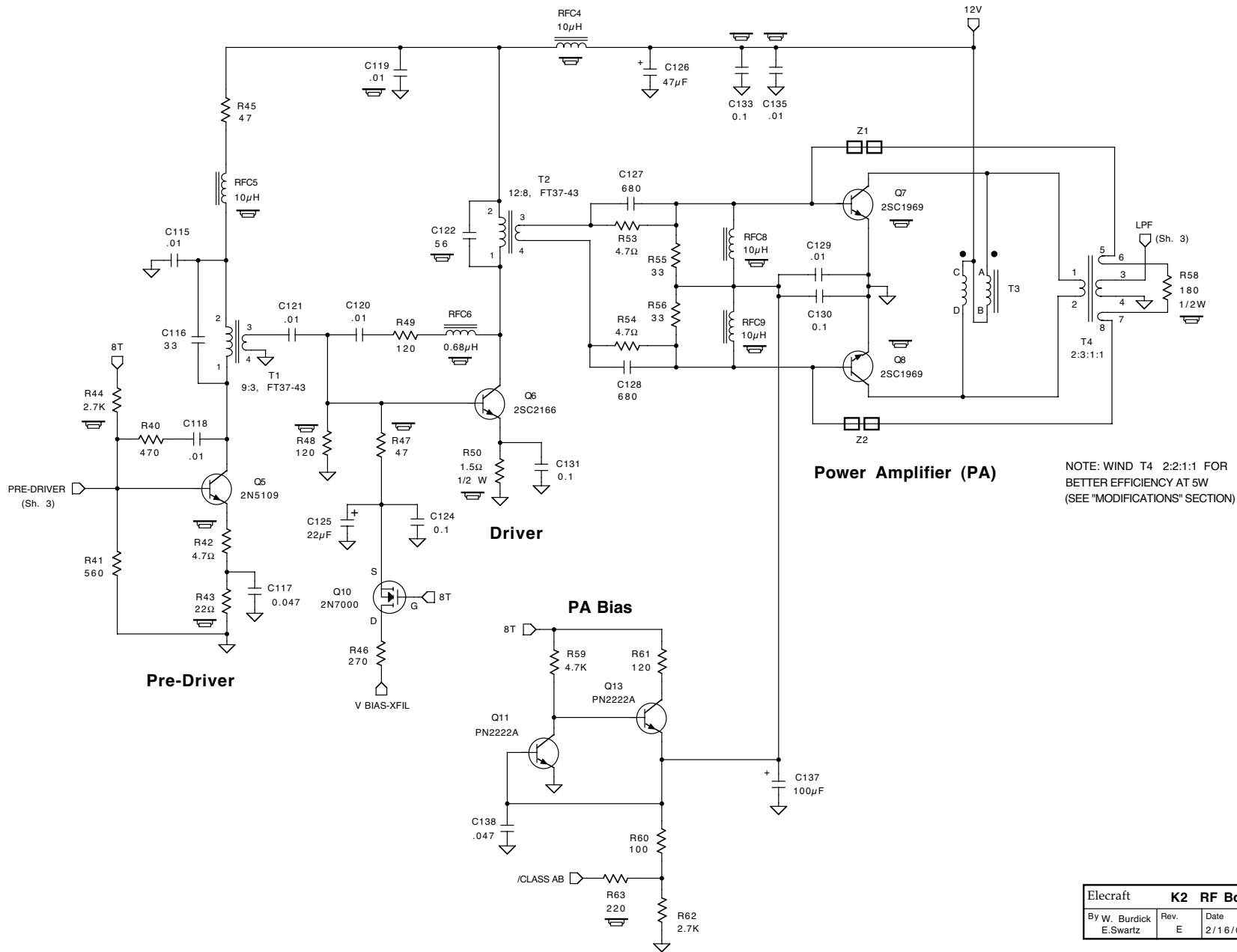

Elecraft	K2 RF Board		
By W. Burdick E. Swartz	Rev. E	Date 2/16/03	Sht. 4 of 4

Appendix B

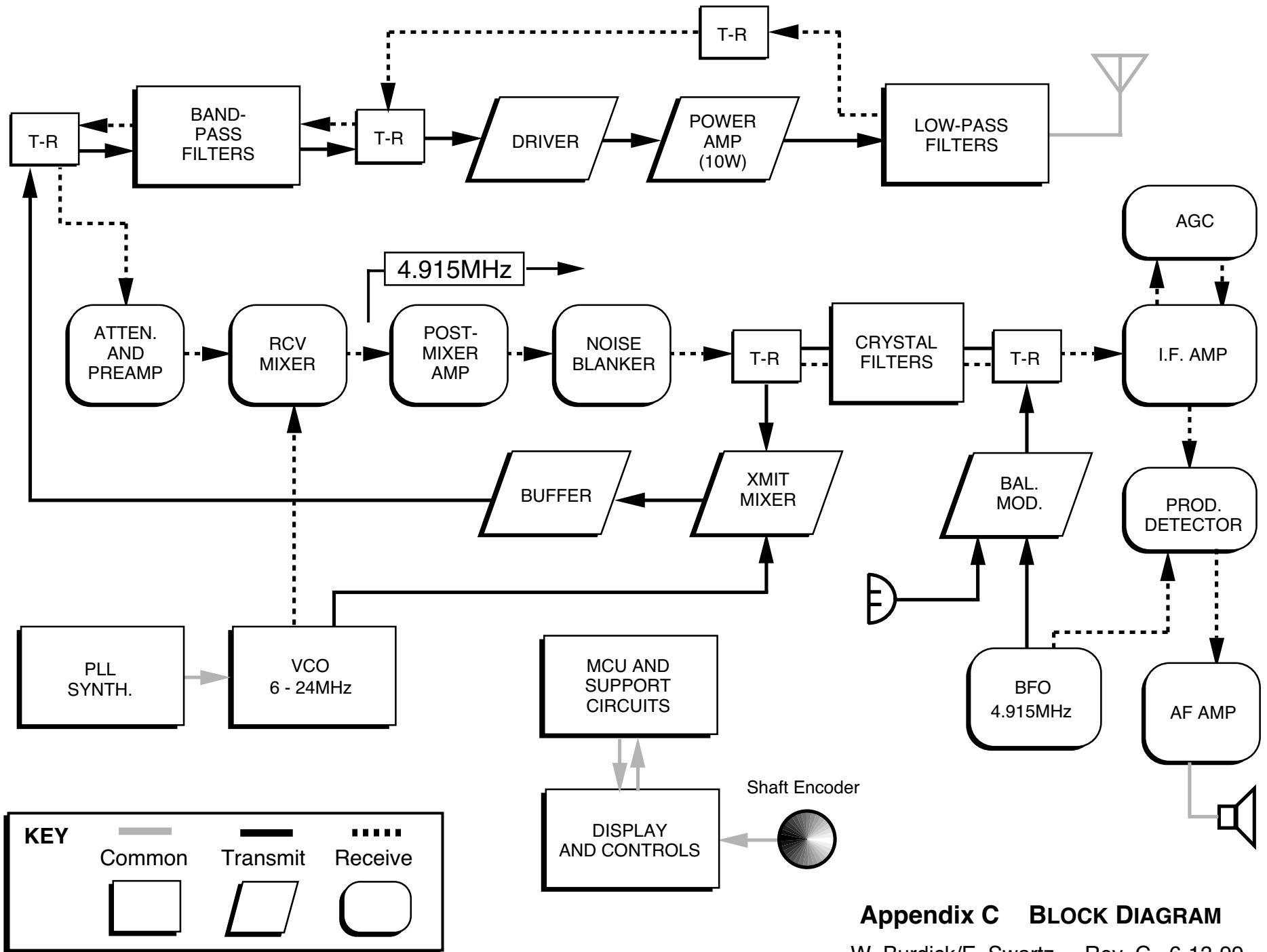

Appendix C BLOCK DIAGRAM
 W. Burdick/E. Swartz Rev. C 6-13-99

Appendix E, Troubleshooting

If you have any difficulty with your K2:

- Closely examine all PC boards for poor solder joints and incorrect, broken or missing components.
- Look for your problem in the **Troubleshooting Tables** (below).
- Follow the step-by-step receiver and transmitter **Signal-Tracing** procedures at the end of this section. Also included are complete **DC Voltage Tables** for all ICs and transistors.

Troubleshooting Tables

There are five troubleshooting tables (listed below). Within each table, problems are identified by 3-digit numbers in the ranges shown. In most cases you'll know which table to look in based on the symptoms you observe. If in doubt, start with the General Troubleshooting table.

General Troubleshooting	000-049
Control Circuits	050-099
Receiver	100-149
Transmitter	150-199
Operation and Alignment	200-249

When referring to components on the various K2 boards in the table, we will sometimes use a shorthand form such as "RF-U11," which means U11 on the RF board.

INFO Messages

If you see a message such as **INFO 100** on the LCD, look up the corresponding entry in the troubleshooting tables. **Note:** **INFO** messages can be cleared by pressing any switch. However, the cause of these messages should be investigated before continuing to operate the transceiver.

General Troubleshooting (000-049)

Problem	Troubleshooting Steps
000 Unit appears to be completely dead when power switch is turned on (no display, no audio)	<ul style="list-style-type: none">▪ Make sure your power supply or battery is connected, turned on, and isn't plugged in backwards▪ Check power supply and battery fuses if applicable▪ The K2's internal self-resetting fuse, F1, may have gone into a high-resistance state due to a short from the 12-V line to ground; unplug the power supply and check for such shorts▪ Examine power cable for shorts or opens▪ Verify control board is plugged in and that its connectors are fully seated▪ Check for 12 VDC at the power jack▪ Make sure speaker, battery, and other internal option connectors are not swapped or plugged in backwards▪ Measure the +5V and +8V regulated power supplies. If either is incorrect, check the regulators (050).▪ Check the MCU (075)
003 LCD is dim	<ul style="list-style-type: none">▪ Check values of R16 and R15 on the front panel▪ Check continuity from LCD driver (U1) to LCD. Also look for bent pins on driver.
004 Display turns on but unit still appears functionally dead or is "running slowly"	<ul style="list-style-type: none">▪ Check the MCU, Control-U6 (075)▪ Verify that the control and front panel boards are plugged in correctly▪ The MCU oscillator may be shorted out due to solder flux residue, especially if you used water-soluble flux solder (030)
005 No display, but audio is OK	<ul style="list-style-type: none">▪ Remove the bottom cover and verify that the front panel connector is properly mated with the RF board▪ If the front panel is plugged in correctly but the problem still persists, check all LCD voltages and control lines (060)

009 LO BATT
displayed

010 Battery voltage
too low for proper
voltage regulation

011 No audio, but
display is OK

012 Display, VFO
knob, switches, or
potentiometers do not
function correctly or
are intermittent

015 Current drain
excessive on receive

016 Current drain
excessive on transmit

- P7 on the control board may be jumpered for ext. 12V. Move the jumper to the "12V" pos.
- Battery voltage may be below 10.5V. Recharge the battery as soon as possible.
- If you saw **INFO 010** on the LCD, your battery voltage is too low (< 8.5V). This usually happens on transmit when your battery is weak. Disconnect the battery from the K2 and measure its voltage; if the battery voltage quickly rises back to 11 or 12V, the K2 may be loading the battery down. But if the battery stays stabilizes at under about 10 V when measured outside of the K2, it has become fully discharged or may be defective.
- If you suspect the K2 is pulling the voltage down, tap any button to clear the **INFO** message then use **DISPLAY** to show the voltage and current drain. If the current drain is > 200 mA with no signal and the bargraph OFF, something is shorting either the 12V line or one of the regulators (**050**).
- Make sure that a working antenna is connected; check antenna switch, tuner, SWR bridge, etc.
- See Receiver Troubleshooting (**100**)
- Front panel or control board may not be plugged in correctly
- Check the MCU (**075**)
- Check all regulated supply voltages (**050**)
- RP1 or RP2 on the front panel board may be installed backwards.
- Check receive-mode current drain (**140**)
- Connect the K2 to a known 50 ohm load (preferably a dummy load); if current drain returns to normal, you probably have a mismatched antenna and will have to improve the match or reduce output power
- If you have set the power level control significantly above the level that the transmitter is capable of, current may

018 Supply voltage
drops when K2 is
turned on

019 Supply voltage
drops too low when
transmitter is keyed

025 Battery won't
charge up to the
correct voltage, or
discharges too quickly

029 Small error in
actual vs. displayed
frequency

increase significantly; try reducing the power setting or use **CAL CUR** to set up a current limit

- Use voltage/current monitor mode to see if the power supply voltage drops below 11V on transmit; if so, you may be exceeding the capability of your power supply or battery (**025**)
- If the supply voltage and antenna impedance are correct, the driver or PA transistors may not be operating efficiently (**150**)
- Use voltage/current monitor mode to see if the receive-mode current drain is too high (**015**)
- If voltage drops but current drain is normal, you probably have a power supply problem or a battery that is not fully charged (**025**); review power supply requirements (Specifications)
- Use voltage/current monitor mode to see if transmit-mode current drain is too high (**016**)
- If voltage drops but current drain on transmit is normal, you probably have a weak battery or inadequate power supply (**025**)
- Batteries must be charged using the right voltage or their usable life will be greatly reduced; if you have the K2 internal battery option, refer to the charging instructions in the option manual
- Battery life can be extended by reducing power output and by turning off selected features using the menu; see Operation
- Always disable the K2's internal battery using the rear-panel battery on-off switch if you plan to use an external battery or a reduced-voltage power supply that is inadequate for charging purposes
- Make sure your 4.000-MHz oscillator (control board, X2) is calibrated. Two methods are provided in the Operation section (Advanced Operating Features).

030 VFO frequency jumps or drifts, or operating frequency appears to be entirely incorrect

- Make sure the bottom cover is installed when doing **CAL FIL** and **CAL PLL**. Also, if you calibrate at room temperature but operate the radio at much lower or higher temperatures, calibration will be worse.
- Re-do **CAL FIL** after calibrating the 4.000-MHz oscillator
- Re-do **CAL PLL** after calibrating the 4.000-MHz oscillator
- Use **CAL FCTR** with probe on TP1 and tune very slowly through about 10 kHz of VFO range; if you see any sudden jumps of > 50 Hz over this range even after doing CAL PLL, your 12.096-MHz oscillator crystal may be defective (RF, X1).
- You must align both the VCO and BFO using the **CAL PLL** and **CAL FIL** before operating the K2; otherwise the VFO cannot be tuned properly and the synthesizer may not be locked (see Operation as well as RF board Alignment and Test, Part II)
- Make sure the supply voltage is above 8.5V at all times or the 8V regulator may not function correctly.
- If you used solder with water-soluble flux, you may have conductive paths all over the PC boards. These can cause numerous problems with the VFO, BFO, and logic circuits (anything high impedance). Try cleaning the entire board with hot water and a Q-tip, or follow solder manufacturer's recommendations (except immersion).
- If you used **CAL FIL** to change the BFO settings, make sure you placed the BFO on the correct side of the zero-pitch value for each operating mode (see Operation, Filter Settings)
- If you tune beyond the lock range of the VCO, the frequency will stop changing and may "hunt" near the end of this range. If you

are in a range that the VCO should be capable of tuning, re-check VCO alignment (see RF board Alignment and Test, Part II)

- If the displayed frequency is "garbage," see Resetting the Configuration to Defaults in Advanced Operating Features.

Control Circuits (050-099)

Problem
050 Regulated voltage(s) incorrect

051 General problem with control circuits (switches, knobs, display, bargraph, T-R switching)

052 +5V too low (< 4.75V)

Troubleshooting Steps

- Remove all option boards, since any one of them might be causing a short on a regulated supply line
- Make sure that the DC input voltage at J3 is > 8.5 (the minimum voltage needed by the voltage regulators)
- If +5V is too low (< 4.5V) go to **052**
- If +8V is too low (< 7.5V) go to **053**
- Check all DC voltages using the voltage tables (later in this section). Start with the control board.
- If the problem involves the front panel, measure those voltages next. If the problem is with T-R switching, check the RF board voltages next. You may have RP1 or RP2 on the front panel board installed backwards.
- Remove the front panel to see if it is pulling the 5V line low. If not, the problem is likely to be on the control board.
- Pull the control board out and inspect the entire 5V line looking for heat-damaged components or shorts. The schematic can be used to identify components on the 5V line.
- Remove the microprocessor to see if it is loading the 5V line down.
- Unsolder the output pin of the 5V regulator and bend it up slightly to break contact with the PC board. If the voltage is still too low measured at the pin, replace the regulator.

053 +8V too low
($< 7.5V$)

- Inspect the entire 8V path on the RF and control boards. Look for heat-damaged components or solder bridges.
- Unsolder the output pin of the 8V regulator and bend it up slightly to break contact with the PC board. If the voltage is still too low measured at the pin, replace the regulator.
- There are a number of places where you can easily break the 8V line to eliminate parts of the circuit in your search for the problem. One example is RFC16 on the RF board. If you lift one end of this inductor it will disconnect the entire synthesizer from the 8V line.
- A number of circuits have resistors in series with the 8V line, for example R112 in series with the I.F. amplifier (U12). If you measure voltage on both sides of these resistors you may find a circuit that is drawing high current or is shorted. Example: If you measured 7V on one side of R112 and 3V on the other, it would indicate that U12 had a current drain of 180 mA, which is much too high ($I = E/R = 4/22 = 0.18$).

060 No display on
LCD

- If the bar-graph is also not working, check the 5V regulator (**052**)
- Remove the front panel hardware and panel from the front panel PC board and inspect the entire board for shorts or incorrect components. You may have LCD driver U1 in backwards or it may have a bent pin.
- Check the values of R15 and R16 on the bottom of the board; these resistors set the voltage for the LCD itself.
- Re-install the front panel board and turn on the K2. Using a voltmeter, measure the voltages on pins 16 and 17 of front panel connector J1 (ICLK and IDAT). These lines should show DC voltages between 0 and 5V due to data transmission from the microprocessor to the LCD driver. If the voltages are fixed at either 0 V or 5V rather than being somewhere in-between, the MCU may not be functioning (**075**)
- If you suspect a ground short in any relay-controlled circuit (LPF, BPF, VCO) you can simplify debugging by pulling out the control board, then turning power ON and back OFF. This places all relays in the RESET condition (see schematic).
- If you hear no relays on power-up, check the IOC (**080**)

065 Relay Problem

075 Possible MCU problem

- Measure the voltage on pin 32 of the MCU (U6, control board). If it is not 5V, check the 5V regulator (**052**).
- Remove the control board and carefully inspect the microprocessor. Make sure it is not installed backwards, has no bent pins, and is seated firmly in its socket.
- Verify that the MCU oscillator components all have the correct values and are soldered properly, with no shorts (X2, C21, C22).
- Listen for the 4-MHz oscillator signal using another ham-band receiver. If you can't hear the signal, try putting a 1M resistor across X2 on the control board. Also try rotating C22.

080 IOC Problem

- If you saw the message **INFO 080**, the I/O controller (IOC, RF-U1) or other auxBus device did not respond to messages from the main processor (MCU). Turn power OFF and back ON; if you hear some relays switching on power-up, the IOC may be OK, and the problem is likely to be with the AuxBus (**081**)
- If you do not hear any relays switching on power-up, your IOC (RF-U1) may be defective. Inspect U1 carefully to see if you have installed it backwards or if any pins are bent.
- Pull U1 out, check its pins, then re-install it, making sure all pins make good contact with the IC socket. Check the 4-MHz oscillator (**075**).
- Remove the bottom cover and verify that all pins of U1's socket are soldered, as well as those of the 6V regulator (RF-U2), and U1's 4 MHz oscillator (RF-Z5).
- With power ON, check all voltages associated with U1. You should see 6V at pins 1 and 20 at all times, even when the IOC is sleeping (not being accessed by the MCU).

081 AuxBus problem

- You may have an option board installed that is causing a problem with the AuxBus. Try removing each option board and turning power off and back on.
- Verify that R64 is installed (RF board, near U1).
- Check the voltage at pin 1 of the IOC (RF, U1). If it isn't approximately 6V, U2 may be bad (6V regulators).
- Check the voltage at pin 28 of the IOC (RF-U1). It should be between 5 and 6V. If it is zero volts, you probably have a short somewhere on the AuxBus line. Turn power OFF, then measure pin 28 of U1 to ground. If it is a short, pull the control board out to see if the short is on that board.
- If the voltage at pin 28 is between 5V and 6V, try pressing the **BAND+** button a number of times while watching the voltage carefully (use an oscilloscope if possible). The voltage should drop below 5V briefly if the MCU (CTRL-U6) is sending a message to the IOC. If the voltage does not change at all, the MCU itself may not be sending AuxBus messages.
- Check the AuxBus signal at the MCU, pin 40 (CTRL-U6). If you don't see this voltage drop below 5V briefly when the band is changed, the MCU may not be functioning (**075**).

090 EEPROM test #1 failed

091 EEPROM test #2 failed

- If you saw the message **INFO 090** or **INFO 091** on the LCD, one of the EEPROM write tests has failed.
- Check all voltages on the EEPROM (CTRL-U7).
- Remove the control board and inspect U7 and surrounding traces. Verify that U7 is properly soldered.

Receiver (100-149)

Problem

100 Low (or no) audio output from receiver, or general receiver gain problem

Troubleshooting Steps

- If you hear normal audio output on some bands but not all of them, check the band-pass and low-pass filters and T-R switch (**120**)
- Make sure you have headphones or speaker connected and do not have the AF GAIN set at minimum
- Check the key jack for a short to ground
- Make sure RF GAIN is at maximum
- The AGC threshold control (R1, Control board) may be set incorrectly. It is normally set so that the voltage at U2 pin 5 is 3.90 volts (no antenna, RF GAIN at max). You can set R1 for a slightly higher voltage at U5 pin 5 to increase the no-signal I.F. gain. If R1 is adjusted, you'll need to re-adjust CAL S HI and CAL S LO (S-meter).
- If you have the 160 m/RXANT option board installed, you may have menu entry **RANT** turned ON but no receive antenna connected; this may affect only one band since **RANT** can be set individually for each band.
- Peak the band-pass filters if you have not already done so
- Check for ground shorts in the LPF and BPF by first resetting all of the relays (**065**)
- Turn the AF GAIN to maximum
- If you don't hear any "hiss" at the receiver output, troubleshoot the AF amplifier (**110**)
- Check the 8V regulated supply voltage and troubleshoot if necessary (**053**)
- Measure the 8R line (+8V receive) at the anode of D6 on the RF board. It should be 8V +/- 0.5V. If not, look for a problem in the 8V switching circuitry (control board).
- Try using signal tracing (see procedure later in this section)

110 AF amp not working

114 AGC or S-meter not working

120 Signal loss only on some bands

- Use the menu to set a sidetone level of 60 (**ST L 060**). Hold **SPOT**. If you hear a strong tone, the A.F. amplifier itself is probably working; check the mute circuit (CTRL-Q6 and Q7) and trace the volume control lines back to the product detector (RF-U11)
- Remove the control board and inspect the entire A.F. amplifier and mute circuit for mis-installed components, shorts, and opens
- If AGC appears to be working but the S-meter isn't, try re-calibrating the meter using **CAL S HI** and **CAL S LO**. If the S-meter is "stuck," you may have an open, short, or incorrect component in the area of U2 on the control board.
- Make sure the RF gain control is at maximum
- If the AGC and S-meter are both not working, you may have a dead 5.068 MHz oscillator crystal, X1 (control board). Listen for the 2nd harmonic of X1 at about 10.136 MHz while touching a screwdriver blade to pin 7 of U1 (NE602). If you can't hear this signal, try soldering a 22 k resistor from pin 7 to pin 3 on U1 (NE602).
- If you have the 160 m/RXANT option installed, make sure you have menu entry rANT set to OFF, or if it is ON that you have a receive antenna connected
- Try peaking the band-pass filters on the affected bands
- Inspect all components in the T-R switch area, and check all T-R switch voltages
- Trace the signal from band-pass filters back all the way to the antenna using an RF signal generator
- Make sure the VCO is oscillating on affected bands by using the frequency counter

140 Receiver current drain is too high

- If you saw the message **INFO 140**, your receive-mode current drain was measured at over 500 mA during normal operation. Continue with the checks below.
- Use DISPLAY to show voltage and current on the LCD. If the current shown is > 300 mA with no incoming signal or > 200 mA with the bargraph turned OFF and no signal, you may have a short or excessive load on the 8V or 8R lines (**053**).
- You may have the speaker and/or external speaker jack wired incorrectly. This can place a short across the audio amp output, causing very low audio output (if any) and current as high as 500 to 800 mA.

Transmitter (150-199)

Problem

150 General Transmitter problem

Troubleshooting Steps

- If power output is too low, go to 155
- If power output slowly increases during key-down, go to 160
- If current drain on transmit is too high for the given power level or you see HI CUR, go to 175
- If the transmitter output power seems to be unstable go to 160
- If the transmitter stops transmitting by itself go to 170
- If the keyer isn't working properly, go to 180
- Use the signal tracing procedure
- You may have CAL CUR (current limit) set too low; 2.00 A recommended at 10 W
- Check power output when using a 50Ω dummy load; if the output is correct on a dummy load but not when using an antenna, your antenna is probably not matched
- Install the bottom cover (all six screws) to prevent RF pick-up by low-level circuits
- Check all component values in the RF

155 Power output is low or zero

detector; you may have two resistors swapped (R67/R68, R66/R69) or the wrong detector diode (D9, should be 1N5711)

- You may have a short in the LPF or BPF; reset all of the relays before trying to look for shorts (**065**)
- Examine transformers T1-T4 carefully; these must be wound as indicated in part III of the RF board assembly section (see this section for drawings)
- Check all DC voltages in the transmitter (RF board, Q5/Q6/Q7/Q8) as well as the ALC circuitry (control board, U10A and RF board, Q24).
- One component that should be checked specifically is R50 (driver), which can open if the driver current goes too high.
- Make an RF probe and signal-trace through the transmitter to find where signal is lost (see probe and procedure later in this section)
- Check for any components getting hot
- Turn the K2 OFF and remove the heat sink; inspect all parts and check for shorts or opens
- If you stay in key-down (**TUNE**) mode for several seconds, it is normal to see some increase in power; this is due to slow junction heating in the final amplifier transistors. It is not indicative of a problem unless current drain is too high for the given power output.
- If power goes up and down significantly during normal keying, you may have a poorly-matched antenna OR you may have power set too high for your battery or power supply to handle; try reducing power to see if it stabilizes
- If you have seen a slow (10-20Hz) oscillation superimposed on the transmitter's output signal, it could be due to ALC modulation. Increase the value of R98 (RF board) to the largest size that permits full output on 10 m.
- If the transmitter is truly unstable

160 Power output fluctuates

- (oscillating) even when connected to a 50-Ω load, you may have an incorrect component value or a toroid-winding error; go through the checks at **155**
- Make sure none of the diodes in the T-R switch circuits are in backwards
 - If you have transmit power set too high for your battery or power supply, the supply voltage may drop so low on transmit that it resets the MCU (CTRL-U6) or the I/O controller (RF-U1). Reduce power.
 - You may have power set higher than the final amplifier can achieve, resulting in overdrive of all transmitter stages. Try reducing power to see if normal current drain is observed at lower power levels
 - Damaged PA transistors or other components could cause inefficiency in any stage of the transmitter. Check all DC voltages and components; signal trace if necessarily (**155**)
- 170** Output power drops to zero suddenly
- 175** Current drain too high on transmit (or **HI CUR** warning)
- 180** Keyer Problem
- If the keyer is stuck at a fixed speed or the sidetone pitch won't change, go into the menu and see what sidetone pitch you have. If it's not in the range of 0.40-0.80 kHz, you may have bad data in the EEPROM. See "Resetting the Configuration to Defaults" in the Advanced Operating Features section.
 - If the keyer is generally erratic when transmitting and seems to get worse as power is increased, you probably have RF leaking into the keyline. Try bypassing your key with .001 μF capacitors; also try 100 μH RF chokes in series with the paddle and ground connections.
 - If your antenna is connected directly to the rig with no coax (i.e., internal ATU), the only way to cure RF problems with the keyer and other circuits may be to reduce transmit power, seek a better antenna match, or improve your ground system

Operation and Alignment (200-249)

- | Problem | Troubleshooting Steps |
|---|---|
| 201 EEPROM initialized | <ul style="list-style-type: none"> ▪ INFO 201 is an informational message only, not a problem indication. You will see INFO 201 one time on power-up. The only other time you might see this message is if you install a new version of the firmware that requires a reformat of EEPROM. (In most cases new firmware should not cause an EEPROM reformat, however.) |
| 230 BFO not connected to frequency counter | <ul style="list-style-type: none"> ▪ INFO 230 is displayed if you try to use CAL FIL without the frequency counter connected to the BFO test point (RF-TP2) |
| 231 VCO not connected to frequency counter | <ul style="list-style-type: none"> ▪ INFO 231 is displayed if you try to use CAL PLL without the frequency counter connected to the VCO test point (RF-TP1) |
| 232 CAL PLL on wrong band | <ul style="list-style-type: none"> ▪ INFO 232 is most likely to be displayed if you use CAL PLL without first selecting 40 meters. |
| 235 PLL ref. oscillator range error | <ul style="list-style-type: none"> ▪ INFO 235 is displayed if CAL PLL cannot complete VFO linearization due to inadequate PLL reference oscillator range (RF-Q19). ▪ You may have the frequency counter probe on the wrong test point (should be on TP1) ▪ Re-test the PLL reference oscillator using the procedure described under "PLL Reference Oscillator Test" in Part II of the RF board Alignment and Test section. ▪ If the PLL reference oscillator range is found to be inadequate, X1 may be defective. Also check D16, D17, C84, C85, and L31 for proper value. |

Signal Tracing

Signal tracing is the primary method by which radio equipment is tested and repaired. You can solve nearly all receiver and transmitter problems yourself by following the steps in this section carefully.

RF Probe Assembly

Your K2 kit includes a complete RF probe, including the PC board, coax, and connectors. **The switch spacing tool, which you used in assembling the Front Panel, doubles as the PC board for the probe.** The RF probe (Figure 1) converts RF signals to DC so they can be measured using a DMM. The DC readings on your DMM will be approximately equal to the signal voltage in V_{rms} (root-mean-square).

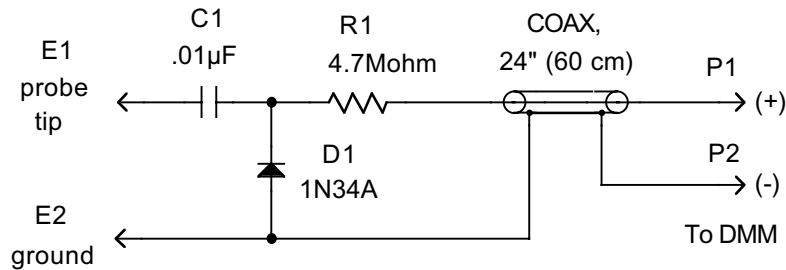

Figure 1

Assembly Instructions: Use a discarded lead from a large diode such as an SB530 or 95SQ015 as the probe tip (E1). It should be about 1" (2.5 cm) long. All other components for the probe can be found in the MISCELLANEOUS bag. An insulated alligator clip is provided for ground (E2). It should be connected to the board using 4" of black insulated hookup wire. Two banana plugs are supplied for connecting the probe to your DMM (P1-P2). Use RG174 coax between the probe board and the banana plugs. The coax should be secured to the board using one cable tie. Thread the cable tie through the two holes provided, near the coax end of the board.

To use the Probe: Connect E2 to the nearest ground test point, and plug the banana jacks into your DMM. Set the DMM for DC volts (20 or 30 V scale). Avoid touching the tip or discrete components while taking measurements.

Signal Generator

A simple crystal oscillator (Figure 2) can be used in lieu of a signal generator. This oscillator takes its output from the crystal itself, resulting in fairly low harmonic content. This results in very slight "pulling" of the oscillator frequency as you adjust the output level, but this is of no concern for signal tracing. The oscillator will run on voltages as low as 8 V, but 12 V or more is recommended to guarantee enough output for all signal tracing steps. The components are not critical, and can vary 20% with little variation in performance. Nearly any NPN RF transistor will work in the circuit.

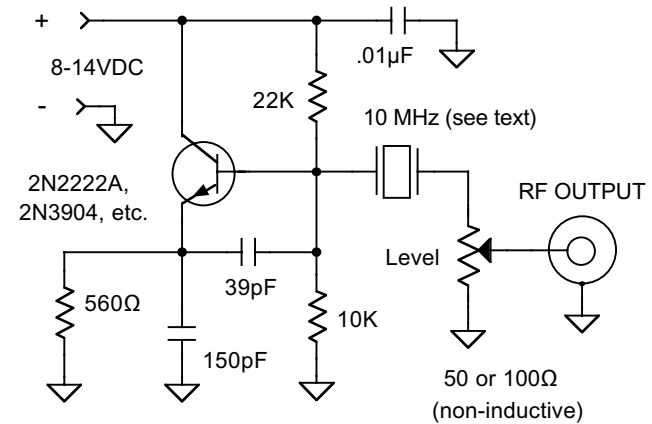

Figure 2

Any crystal frequency that falls in or near a ham band can be used, but 10 MHz is recommended since our signal tracing measurements were done using this band. If you have only completed the K2 up through part II of the RF board (40 m), you'll have to use a crystal in the 6.8 to 7.5 MHz range.

You may wish to build the oscillator into an enclosure fitted with a BNC connector and level control. Use short leads for all wiring. Use very short leads (2") or coax to connect the signal generator to the K2's antenna jack.

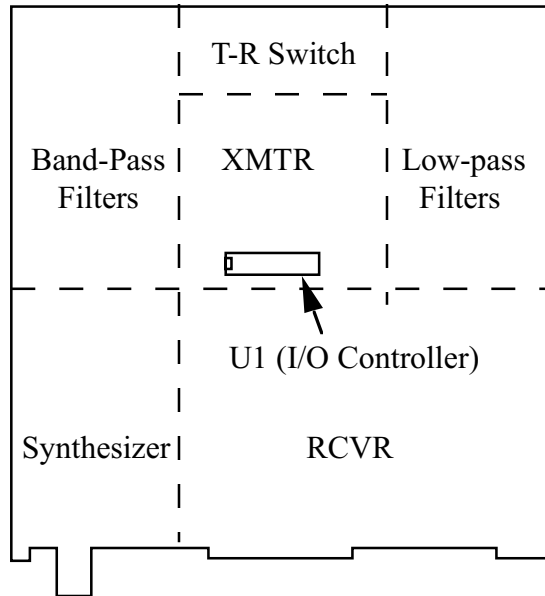

Figure 3

Receiver and Synthesizer

In the following steps you'll use the RF probe and other techniques to find the stage where the received signal is getting attenuated. (Figure 3 shows the approximate location of the synthesizer, receiver, and other circuits on the RF board.) You can then use voltage tables, resistance checks and close examination to find the bad component or connection.

Perform all measurements in the order listed. In general, your measurements can vary 20-25% from those shown and still be acceptable. Space is provided to record your own measurements (in pencil), which will be very useful if you need to re-test a particular circuit after repairs.

Preparation for Receiver Signal Tracing

1. Verify that basic display and control circuits are functioning.
2. Using your DMM, check the 5-V and 8-V regulator outputs.
3. Measure the voltages on the anodes (right end) of D6 and D7 (on the RF board, near the I/O controller, U1). In receive mode, D6's anode should be at about 8 V, and D7's should be near 0 V.
4. Connect the RF probe's output to your DMM's +/- DC input jacks.
5. Select a 2 or 3-V DC range.
6. The DMM should read close to 0.000 V DC. The reading should increase when you touch the RF probe tip with your finger.
7. Turn on the K2 and switch to 30 m (or the appropriate band for your signal generator). Select CW Normal mode.
8. Using the menu, select **OPT PERF**.
9. Use **CAL FIL** to set up CW normal filter FL1 for a bandwidth of **1.50**. If you can hear some noise on your receiver, set up the BFO for this filter as described in the Operation section of the manual. Otherwise, set the BFO to the factory default value.
10. Exit **CAL FIL**, then select the 1.50-bandwidth filter using **XFIL**.

PLL Reference Oscillator and VCO (RF board schematic, sheet 1)

1. Connect the RF probe's ground clip to the ground jumper near the synthesizer circuitry.
2. **Reference Oscillator Output:** Measure the reference oscillator signal at pin 1 of U4 (MC145170), which is near the front-left corner of the RF board (near the control board). Expected: 0.8-1.8 Vrms. Actual: _____.
3. **VCO Output:** Measure the VCO signal at pin 3 of U3 (LT1252). Expected: 0.30-0.40 Vrms. Actual: _____. If this signal is zero, you may have the secondary winding of T5 reversed.
4. **VCO Buffer Output:** Measure the signal on pin 6 of U3. Expected: 0.60-0.75Vrms. Actual: _____.
5. Check the VCO frequency (RF Board, Alignment and Test Part II).

BFO (RF, sheet 2)

1. **BFO Output:** Measure the signal on U11, pin 6 (NE602). Expected: 0.20-0.70 Vrms. Actual: _____.
2. Use the menu to select **CAL FCTR**. Press EDIT again to confirm; the display will now show a frequency reading (it will depend on where you have the frequency counter probe connected).
3. **BFO Buffer Output:** Measure the amplitude of the signal at TP2 using the RF probe. Expected: 0.025-0.070 Vrms. Actual: _____.
4. Exit **CAL FCTR**. Check the BFO frequency (RF Board, Alignment and Test Part II).

Low-Pass Filter, Bandpass Filter, and T-R Switch (RF, sheet 3)

1. Turn both the attenuator and preamp OFF using **PRE/ATT**.
2. Set RF GAIN to minimum.
3. Set AF GAIN to about 10% and connect a pair of headphones.
4. Switch to the 30 m (or the correct band for your signal generator).
5. Connect a signal generator or test oscillator to the antenna jack. Set the signal generator for 0.14 Vrms as indicated by the RF probe.
6. If possible, tune the VFO until you hear the signal. It may be quite strong even if your receiver is attenuating the signal somewhere. Find the approximate signal peak by ear. Set AF GAIN to minimum.
7. Align the band-pass filter for the current band if possible: (a) Put the RF probe on the banded end (cathode) of D6 (to the left of the I/O controller, U1); (b) adjust the band-pass filter for the current band for a peak indication on the DMM (on 30 m: adjust L8 and L9).
8. Aligning the band-pass filter may have changed the input impedance of the receiver. Put the RF probe back on the antenna input and adjust the signal generator for 0.14 Vrms again.
9. **Low-Pass Filter Output:** Measure the signal at jumper W1, near the PA transistors (Q7/Q8). Expected: 0.13 Vrms. Actual: _____.
10. **T-R Switch #1 Output:** Measure the signal at W6, which is just to the right of the transverter option connector, J13 (near the back edge of the board). Expected: .093 Vrms. Actual: _____.
11. **Band-Pass Filter Output:** Measure the signal at the left side of D6. Expected: .086 Vrms. Actual: _____.
12. **T-R Switch #2 Output:** Measure the signal at the right side of D6. Expected: .077 Vrms. Actual: _____.

Mixer, I.F. Amplifiers, and Crystal Filter (sheet 2)

1. **Attenuator Off Test:** Measure the signal at the end of R72 closest to Q21. Expected: .077 Vrms. Actual: _____.
2. **Preamp Off Test:** Measure the signal at the end of R73 closest to Z6. Expected: .077 Vrms. Actual: _____. (Preamp gain will be tested later.)
3. **Composite Mixer Output:** Measure the signal at the right end of R80. Expected: .079 Vrms. Actual: _____.
4. **Post-Mixer Amp Output:** Measure the signal at the case (collector) of Q22 (2N5109). Expected: 2.20 Vrms. Actual: _____.
5. **-5 dB Pad Output:** Measure the signal at jumper W2, near the crystal filter. Expected: 1.40 Vrms. Actual: _____.
6. **Crystal Filter Output:** Touch the RF probe to jumper W3, near the crystal filter. Adjust the VFO for a peak in the DMM reading. Expected: 0.35 Vrms. Actual: _____. If this reading is low, it may be due to a non-optimal setting of the BFO in CAL FIL. Try a different BFO setting, then adjust the VFO for peak again and re-measure the filter loss. (Note: this measurement exaggerates the filter loss because the *input* to the filter is a composite of many signals besides the desired one.)
7. **T7 Step-Up Ratio:** Measure the signal at U12, pin 4 (MC1350). Expected: 1.36 Vrms. Actual: _____.
8. **I.F. Amp Saturated Output:** Measure the signal at U12, pin 8. It may be anywhere between 0.00 and 0.30 Vrms. Adjust the signal generator level until the DMM reads approx. 0.15 Vrms. (If your signal generator is running from a 9-V battery you may have trouble getting the output this high. Try running the generator from 12V or more in this case.)
9. **2nd Crystal Filter Output:** Measure the signal at U11, pin 1 (NE602). Expected: approx. 0.27 Vrms. Actual: _____.
10. **Product Detector Saturated Output:** Measure the signal at U11, pin 5 (NE602). Expected: 0.58 Vrms. Actual: _____.

AGC (Control Board)

1. Disconnect the RF probe from the DMM. Connect the DMM's (-) lead to chassis ground.
2. Turn the signal generator completely OFF (remove its power).
3. Set RF GAIN to maximum.
4. **No-Signal AGC, Max. IF Gain:** Measure the DC voltage on pin 1 of U2 (LM833). Expected: 3.6 V. Actual: _____.
5. Set RF GAIN to minimum.

6. **No-Signal AGC, Min. IF Gain:** Measure the DC voltage on pin 1 of U2. Expected: 4.6 V. Actual: _____.
7. Turn the signal generator back on.
8. **AGC @ Saturation:** Measure the DC voltage on pin 1 of U2. Expected: 6.9 V. Actual: _____. Adjust the VFO to make sure this voltage is at its peak.
9. **I.F. Amp AGC Input:** Measure the DC voltage on pin 5 of U12 (RF, sheet 2). Expected: 5.0 V. Actual: _____.

Product Detector and AF Amp (RF, Sheet 2)

1. Set up the DMM to read AC volts (use a 2 or 3-V meter range).
2. Touch the (+) lead of the DMM to pin 5 of U11 (NE602). Decrease the signal generator level until the AC voltage at pin 5 reads .025 Vrms. (The K2's RF GAIN control should still be at minimum.)
3. Disconnect the headphones and speaker. Turn the AF GAIN control to maximum.
4. Measure the signal at the speaker jack, P5 pin 1 (near the on/off switch, S1). Expected: 1.6 Vrms. Actual: _____.

I.F. Amp Noise Gain (RF, sheet 2)

1. Turn the signal generator off and disconnect it from the antenna jack. Connect a 50-ohm dummy load.
2. Turn off all nearby equipment (especially computers or signal sources).
3. Set AF GAIN to maximum. Set RF GAIN to minimum.
4. Make sure the preamp and attenuator are both OFF.
5. Verify that FL1 is selected (bandwidth = 1.50), as well as CW Normal mode.
6. **AF Output, Min. IF gain:** Setup the DMM for its lowest AC volts range. Measure the signal at the speaker jack, P5 (near the on/off switch, S1). Expected: 0.000-0.001 Vrms. Actual: _____.
7. **AF Output, Max. IF gain:** Set RF GAIN to maximum. Measure the signal at P5, pin 1. Expected: 0.007-0.013 Vrms. Actual: _____.
8. **Preamp Noise Gain:** Turn on the preamp. Measure the signal at P5. Expected: 0.030-0.060 Vrms. Actual: _____.
9. **Noise Increase w/Antenna:** Connect an antenna. The signal at P5 should increase substantially even if atmospheric conditions are quiet. A typical reading on 30 or 40 m is 0.20-0.40 Vrms. In general, the longer or higher your antenna is, the greater the noise increase will be.

Final Steps

If you have completed receiver signal tracing and any necessary repairs, you should then do the following:

1. Re-install the bottom cover and heat sink.
2. Re-do calibration of the VCO, BFO, band-pass filters, crystal filters, etc. as needed (see RF Board Alignment and Test, parts I, II, and III). If you peaked L8 and L9 when signal tracing through the 30-m band-pass filter, you'll need to re-peak C21 and C23 on 20 m.
3. Leave the frequency counter cable connected to TP2 (BFO)
4. Connect the speaker and re-install the top cover.

Transmitter

The following procedure can be used to isolate problems with the transmitter (the transmitter area of the RF board is identified in Figure 3). CW mode is used for these tests. If you're having difficulty with the SSB adapter, make sure the transmitter works on CW first, then proceed with the signal tracing instructions in the SSB adapter manual.

Once you find a location where the signal appears to be much lower than expected, stop signal tracing and check that circuit. Check all component values and DC voltages (see DC Voltage Tables). Closely examine the PC board for unsoldered pins and solder bridges. One of most likely causes of a transmitter problem is a poorly-soldered toroid lead. Re-heat any suspect leads or solder joints.

Preparation for Transmitter Signal Tracing

1. Make sure basic display and control circuits are functioning before attempting transmitter testing.
2. Remove the SSB adapter (if installed) and install temporary jumpers at J9 and J10. Temporarily re-install C167 (.001 μ F or higher) between pins 7 and 12 of J11. (See RF board, sheet 2.)
3. **12 V supply check:** Use your DMM to check the DC voltage at the cathode (banded end) of D10 (right edge of the board). Expected: 9 to 14 V. Actual: _____. Verify that the same voltage (or slightly lower) can be found on the case (collector) of Q5 and the tab (collector) of Q6 when the K2 is turned on and is in receive mode.

4. If you don't have an RF probe, you can build the one from Figure 1.
Note: do not use the RF probe to directly measure the transmitter's power output unless you have the power set for 2 W or less. The 1N34A diode in the RF probe may be damaged at higher power levels.
5. **Test Shared Circuits:** Do the *receiver* signal tracing (above). This tests a number of circuits that are shared by both transmitter and receiver, including the VCO, BFO, BFO buffer, T-R switches, band-pass filters, and low-pass filters. **It's important not to skip this step**, even if the receiver seems to be working correctly. Shared circuits that are working marginally may affect the transmitter more than the receiver, so their actual output levels must be measured.
6. Set up the K2 for 40 meters (about 7100 kHz), CW Normal mode.
7. Plug in a 50-ohm dummy load (10-W or higher rating).
8. Set the power level to 5 watts.
9. Connect a hand key or keyer paddle to the key jack.
10. Connect a speaker or headphones.
11. Use the menu to set **ST L** 030, **ST P** 0.50, and **T-R** 0.05.
12. Select hand key mode (**INP HAND**).
13. Set up a transmit current limit of 2.50 amps using **CAL CUR**.

Basic voltage checks (RF schematic, sheet 2)

Note: When using **TUNE** to key the transmitter, be sure to tap **TUNE** again within 5 seconds or less each time. This will reduce the chance of damaging any components in the transmitter that are consuming excess power.

1. Switch to voltage/current display mode using **DISPLAY**.
2. Hold **TUNE** to key the transmitter, and verify that supply voltage does not drop by more than about 0.8 V. If it drops more than this, either your power supply is inadequate or the transmitter is drawing excess current.
Actual transmit-mode voltage: _____ V. Current: _____ A.
3. Return to normal display mode using **DISPLAY**.
4. Measure the key-down DC voltages on the anodes (right end) of D6 and D7 (near U1, the I/O controller). During transmit, the voltage on the anode of D7 should be about 8 V, and on D6, near 0 V. Actual TX-mode voltages, D6: _____ V; D7: _____ V.
5. Use **TUNE** and note the actual power output: _____ W.

Sidetone (Control Board)

Note: If the sidetone is already functioning correctly, you can skip this section.

1. Make sure you're in CW mode. The sidetone will not function in SSB modes.
2. Disconnect the headphones and speaker.
3. Use the menu to set **ST L** to 255 (maximum sidetone level).
4. Use the **VOX** button to select CW TEST mode (the mode letter will then flash). This is a safe setting for sidetone tests, since there is no power output.
5. Set your DMM for AC volts, 2 or 3-V range. Touch the positive lead of the DMM to pin 25 of U6 on the control board (18C452). (This is the source of the sidetone signal.)
6. Key the transmitter using the hand key (**TUNE** does not activate the sidetone). Measure the AC voltage on pin 25 of U6. Expected: 2.5 Vrms. Actual: _____. Un-key the transmitter.
7. Move the DMM probe to the drain of Q5 (control board, 2N7000). Key the transmitter and measure the AC drain voltage. Expected: 2.4 Vrms. Actual: _____. If this is zero, either Q5 is defective or there is no drain voltage supply from pin 1 of U8 (MAX534, D-to-A converter).
8. Measure the AC voltage on pin 7 of U10 (LMC660). Expected: 0.5 Vrms. Actual: _____.
9. Measure the AC voltage on pin 8 of U9 (LM380). Expected: 0.5 Vrms. Actual: _____.
10. Measure the AC voltage on pin 6 of U9. Expected: 0.5 Vrms. Actual: _____. This signal should also be present on the speaker jack, P5 pin 1 (RF board).
11. Return the **ST L** setting to 030.
12. Use the **VOX** button to put the transmitter back into **OPERate** mode.

ALC (control board)

1. Make sure the POWER control is set for 5 watts, and that you're in CW/Operate mode.
2. Set up the DMM for DC volts, 20 or 30-V range.
3. **Power Control Test (VPWR line):** The VPWR line, pin 2 of U8 (MAX534), is where transmit power control begins. On key-down, the microprocessor (U6) starts increasing the voltage on VPWR until it sees the desired power indication from the RF output detector (RF board,

sheet 3, lower right-hand corner). To test VPWR, set the DMM for DC volts, then measure the DC voltage on pin 2 of U8 when **TUNE** is pressed. Expected: 0.7-2.5 VDC. Actual: _____.

4. **If VPWR reading is high (> 4.5 V):** The ALC software will set VPWR to its highest level (about 5 V) if the transmitter cannot be driven to the requested power level. This happens for one of two reasons: (a) the transmitter gain is low (or transmitter isn't working at all); (b) the RF detector has an incorrect component. Check all component values in the RF detector. If you can't find a problem with the RF detector, continue with the next signal tracing section (transmit mixer, etc.).
5. **If VPWR reading is low (< 0.4V):** VPWR can be too low because: (a) the ALC software is being "fooled" by a signal from the RF detector that says the power is higher than it really is; (b) because U8 on the control board is defective or has a pin shorted to ground or not soldered. Check all component values in the RF detector (RF, sheet 3). If these appear correct, check DC voltages on U8 (control), as well as resistance to ground on all pins.

Transmit Mixer, Buffer, Band-Pass Filter, T-R Switch (RF, sheets 2-3)

Note: The measurements in this section and the next may vary widely, especially if you do the measurements on a band other than 40 m. However, the *ratio* between any two back-to-back measurements should remain fairly constant, and is a good indication of gain or loss of a stage in the transmitter. For example, the ratio of measurements in steps 3 and 2 below is about 12.

1. Connect the RF probe to the DMM. Set the DMM for a 2 or 3-V DC volts range.
2. **Xmit Mixer Output:** Measure the key-down signal at U10, pin 4. Expected: 0.016 Vrms. Actual: _____.
3. **Buffer Output:** Measure the key-down signal at U9, pin 6 (LT1252). Expected: 0.200 Vrms. Actual: _____.
4. **Band-Pass Filter Output:** Measure the key-down signal at W6. Expected: 0.030 Vrms. Actual: _____.
5. **T-R Switch #1 Output:** Measure the key-down signal at the anode of D1. Expected: 0.029 Vrms. Actual: _____.

Pre-driver, Driver, and PA (RF, sheet 4)

1. **Pre-Driver Output:** Measure the key-down signal at the case (collector) of Q5 (2N5109). Expected: 0.120 Vrms. Actual: _____.

2. **Driver Input:** Measure the key-down signal on the base of Q6 (2SC2166; pins are labeled *B, C, E*). Expected: 0.026 Vrms. Actual: _____.
3. **Driver Output:** Measure the key-down signal at the tab (collector) of Q6. Expected: 1.8 Vrms. Actual: _____.
4. **PA Input (Q7):** Measure the key-down signal at the base of Q7 (2SC1969 on bottom of the board; pins are labeled on the top). Expected: 0.38 Vrms. Actual: _____.
5. **PA Input (Q8):** Measure the key-down signal at the base of Q8. Expected: 0.38 Vrms. Actual: _____.
6. **RF Detector Input:** Measure the key-down signal on the anode (non-banded end) of D9 (1N5711, middle of the right edge of the board). Expected: 2.0 Vrms. Actual: _____. (This voltage should be fairly constant regardless of the band used.)
7. **PA Transistor Tests:** If the PA input voltages were higher than expected, but the RF detector input was too low, one or both PA transistors could be defective. After checking DC voltages and transformer leads, turn off power to the K2 and use your DMM's diode/transistor test range to test the transistors. With the DMM's positive lead on the base of Q7, you should measure about 0.6 k to the emitter or collector. With the DMM's negative lead on the base of Q7, you should measure about 1.3 k to the emitter and > 3 k to the collector. These also apply to Q8.

DC Voltage Tables

The tables on the following pages provide DC voltages for all ICs and transistors on each of the three boards, as well as the diodes in the T-R switch (RF board). Typically, your readings will match these within 10%. The voltages were measured using a high-impedance DMM (10-11 Megohm). The K2's internal voltmeter can also be used for most measurements.

Receive-mode voltages are listed except as noted. Most of the Control board measurements were made with the Front Panel module removed for easier access. Exceptions are indicated by (**).

Equipment Setup: Supply voltage 14.0 V; no antenna; LCD = NITE; GRPH = DOT; receive mode; no headphones or speaker connected; RF GAIN mid-range; AF GAIN minimum; OFFSET mid-range.

CONTROL BOARD (Front panel removed except ** = CAL FCTR mode w/front Panel plugged in; * = approximate and/or may fluctuate)

Ref.	Pin	VDC	Ref.	Pin	VDC	Ref.	Pin	VDC	Ref.	Pin	VDC	Ref.	Pin	VDC	Ref.	Pin	VDC
Q1	E	8.0	Q12	E	6.3	U6	1	5.0	U6	34	0.0	U9	1	0.4*			
	B	8.0		B	7.0		2	0.0*		35	0.2*		2	.02*			
	C	0.0		C	8.0		3	5.0*		36	0.8*		3	.02*			
Q2	E	8.0	U1	1	1.4		4	0.2*		37	5.0		4	0.0			
	B	7.3		2	1.4		5	2.6*		38	1.2*		5	0.0			
	C	7.5		3	0.0		6	4.7*		39	0.2*		6	6.7			
Q3	S	0.0		4	6.9		7	0-5*		40	5.5		7	13.7			
	G	0.0		5	6.9		8	0-5*	U7	1	5.0		8	6.8			
	D	8.0		6	8.0		9	0 or 5		2	5.0	U10	1	7.7*			
Q4	S	0.0		7	7.5		10	5.0**		3	5.0		2	5.0*			
	G	5.0		8	8.0		11	5.0		4	0.0		3	5.0*			
	D	0.0	U2	1	6.9		12	0.0		5	5.0		4	8.0			
Q5	S	0.0		2	6.9		13	2.3*		6	0.0		5	5.0			
	G	0 or 5		3	6.9		14	2.4*		7	5.0		6	5.0			
	D	0-5		4	0.0		15	2**		8	5.0		7	5.0			
Q6	G	2.7*		5	7.3		16	0-5*	U8	1	0-5*		8	0-8*			
	S	5-6*		6	7.3		17	2.7*		2	5.0**		9	0-8*			
	D	5-6*		7	7.3		18	0.0		3	5.0		10	0-8*			
Q7	G	2.7*		8	8.0		19	5.0		4	0.0		11	0.0			
	S	5-6*	U3	1	0.4*		20	5.0		5	0.0		12	0-8*			
	D	5-6*		2	13.7		21	5.0		6	5.0		13	0-8*			
Q8	E	7.0**		3	13.7		22	5.0		7	5.0		14	0-8			
	B	7.7**		4	0.0		23	5.0		8	0 or 5						
	C	8.0**		5	2.5		24	5.0		9	5.0						
Q9	E	0.0		6	2.5		25	0.0		10	0.0						
	B	0.7**		7	2.5		26	5.0		11	5.0						
	C	2 **		8	13.7		27	0.0		12	0.0						
Q10	E	0.0	U4	IN	13.7		28	5.0		13	5.0						
	B	0.7**		GND	0.0		29	5.0		14	0.0						
	C	2**		OUT	8.0		30	5.0		15	0-5*						
Q11	E	0.2*	U5	IN	13.7		31	0.0		16	0-5*						
	B	0.9*		GND	0.0		32	5.0									
	C	13.5		OUT	5.0		33	5.0									

FRONT-PANEL BOARD (* = approximate and/or may fluctuate; ** = not accessible due to LCD)

Ref.	Pin	VDC	Ref.	Pin	VDC	Ref.	Pin	VDC	Ref.	Pin	VDC	Ref.	Pin	VDC	Ref.	Pin	VDC
Q1	E	2.7	U1	26	3.5	U3	1	0.0	U4	15	0.0						
	B	3.4		27	3.5		2	5.0		16	0.0						
	C	5.0		28	3.5		3	0.8*		17	0.0						
Q2	E	2.7		29	3.5		4	> 0		18	0.4*						
	B	3.4		30	3.5		5	> 0		19	0.0						
	C	5.0		31	3.5		6	4.0*		20	0.0						
				32	3.5		7	2.0*									
				33	3.5		8	5.0									
				34	3.5		9	0.0									
U1	1	**		35	3.5		10	0.0									
	2	**		36	3.5		11	0.0									
	3	**		37	3.5		12	.02*									
	4	**		38	3.5		13	0.2*									
	5	**		39	3.5		14	3.1*									
	6	**		40	3.5		15	0.8*									
	7	**	U2	1	5.0		16	4.0*									
	8	**		2	0.2*		17	0.1									
	9	**		3	5.0		18	3.6*									
	10	**		4	5.0		19	0.0									
	11	**		5	5.0		20	0.0									
	12	**		6	5.0	U4	1	0.0									
	13	**		7	5.0		2	5.0									
	14	**		8	0.0		3	3.6*									
	15	**		9	0.1*		4	> 0									
	16	**		10	0.0		5	> 0									
	17	**		11	5.0		6	> 0									
	18	**		12	5.0		7	> 0									
	19	**		13	5.0		8	5.0									
	20	**		14	5.0		9	0.0									
	21	3.5		15	0.0		10	0.0									
	22	3.5		16	5.0		11	0.0									
	23	3.5					12	.02*									
	24	3.5					13	0.2*									
	25	3.5					14	0.0									

RF BOARD (Shaded areas indicate transmit-mode voltage measurements)

Ref.	Pin	VDC	Ref.	Pin	VDC	Ref.	Pin	VDC	Ref.	Pin	VDC	Ref.	Pin	VDC	Ref.	Pin	VDC
D1	A	0.0	Q12	S	0.0	U1	1	6.0	U3	6	4.3	U8	IN	8.0			
	C	7.5		G	6.0		2	6.0		7	8.0		GND	0.0			
D2	A	8.0		D	0.0		3	0.0		8	0.0		OUT	5.0			
	C	7.5	Q13	E	0.6		4	0.0	U4	1	2.1	U9	1	0.0			
D3	A	8.0		B	1.3		5	0.0		2	2.4		2	6.9			
	C	7.5		C	7.5		6	0.0		3	0.0		3	6.9			
D4	A	8.0	Q16	E	0.0		7	0.0		4	2.3		4	0.0			
	C	7.5		B	0.6		8	0.0		5	5.0		5	0.0			
D5	A	0.0		C	2.2		9	0.2		6	5.0		6	6.9			
	C	8.0	Q17	S	0.0		10	0.15		7	0.0		7	13.8			
D6	A	8.0		G	2.2		11	0.0		8	0.1		8	0.0			
	C	7.5		D	2 to 3		12	0.0		9	0.0	U10	1	1.4			
D7	A	0.0	Q18	G	-1.0		13	0.0		10	0.0		2	1.4			
	C	7.5		S	2 to 3		14	0.0		11	0.0		3	0.0			
Q2	S	0.0		D	6.3		15	0.0		12	0.0		4	5.0			
	G	8.0	Q19	G	0.0		16	0.0		13	4.0		5	5.0			
	D	0.0		S	0.8		17	0.0		14	5.0		6	6.0			
Q5	E	0.6		D	8.0		18	6.0		15	5.0		7	5.5			
	B	1.3	Q20	S	0.0		19	0.0		16	5.0		8	6.1			
	C	12.4		G	8.0		20	6.0	U5	1	0.0	U11	1	1.4			
Q6	B	1.1		D	0.0		21	0.0		2	5.0		2	1.4			
	C	13.3	Q21	E	1.6		22	0.0		3	5.0		3	0.0			
	E	0.4		B	2.3		23	0.0		4	5.0		4	5.0			
Q7	B	0.6		C	13.2		24	0.0		5	0.0		5	5.0			
	C	13.4	Q22	E	1.3		25	0.0		6	2.0		6	6.1			
	E	0.0		B	2.0		26	0.0		7	0 to 4		7	5.6			
Q8	B	0.6		C	12.5		27	0.0		8	5.0		8	6.1			
	C	13.4	Q23	S	0.0		28	5.5	U6	1	0 to 8	U12	1	7.9			
	E	0.0		G	0.0	U2	IN	13.7		2	0 to 4		2	7.9			
Q10	S	1.6		D	8.0		GND	0.0		3	0 to 4		3	0.0			
	G	8.1	Q24	G	0.0		OUT	6.0		4	0.0		4	2.5			
	D	1.6		S	1.2	U3	1	0.0		5	4.0		5	3.9			
Q11	E	0.0		D	1.3		2	4.3		6	4.0		6	2.5			
	B	0.6					3	4.1		7	0 to 8		7	0.0			
	C	1.3					4	0.0		8	8.0		8	7.9			
							5	0.0									

Appendix F

Parts Placement Drawing, Top

