

ELECRAFT® K3

HIGH-PERFORMANCE 160 – 6 METER TRANSCEIVER

K3 KIT ASSEMBLY MANUAL

Rev M, September 3, 2014

Copyright © 2014, Elecraft, Inc.

All Rights Reserved

Contents


Introduction.....	2	Loudspeaker.....	55
Customer Service and Support.....	3	Loudspeaker Description	55
Technical Assistance.....	3	Loudspeaker Installation Procedure	55
Preventing Electrostatic Discharge Damage	5	KPA3 Shield	57
How ESD Damage Occurs	5	KPA3 Shield Description	57
Preventing ESD Damage.....	5	KPA3 Shield Installation Procedure.....	57
Preparing for Assembly	6	Bottom Cover	59
Overview of the Kit.....	6	Bottom Cover Description.....	59
Tools and Test Equipment Required	8	Bottom Cover Hardware Installation Procedure..	59
Unpacking and Inventory	9	KNB3 Noise Blanker.....	61
Screws	9	KNB3 Noise Blanker Description	61
Standoffs	10	KNB3 Installation Procedure.....	61
Lock Washers.....	10	Battery BT1	62
Assembly	11	Battery BT1 Description.....	62
RF Board and Chassis	12	Battery BT1 Installation Procedure	62
RF Board Description	12	KBPF3 General Coverage Receive Option	63
RF Board and Chassis Assembly Procedure	12	KBPF3 Description.....	63
KANT3 or KAT3, Right Side and Rear Panels	20	KBPF3 Installation Procedure	63
KANT3 or KAT3 Description.....	20	Power Amplifier Jumper Block.....	64
Installing KANT3 or KAT3 Antenna Connectors	20	Finishing the Enclosure	64
.....	20	Fan Opening Cover.....	64
Installing KRX3 AUX RF (ANT) Connector	20	AUX RF Cable	64
Preparing Right Side Panel for Installation.....	23	Bottom Covers.....	65
Mounting the KANT3 or KAT3, Side and Rear	24	Top Cover	67
Panels	24	Test and Calibration.....	69
KIO3 Interface	27	Initial Power Checks.....	69
KIO3 Description	27	Synthesizer Calibration.....	70
KIO3 Interface Installation Procedure	27	Filter Setup	71
Front Panel and DSP	31	Reference Oscillator Calibration	71
Front Panel and DSP Description.....	31	TX Gain Calibration	71
Front Panel Assembly Procedure	31	Option Modules	72
Mounting the Subreceiver Auxiliary DSP Board	39	Enable Modules	72
Installing the KDVR3 Digital Voice Recorder	41	KPA3 100-Watt Amplifier Installation	72
Option.....	41	KRX3 Subreceiver Installation.....	72
Mounting the DSP Board Assembly on the Front	42	Other Calibration Procedures	72
Panel.....	42	Wattmeter Calibration (Optional).....	72
Mounting the Front Panel Assembly.....	44	S-Meter Calibration (Optional).....	72
Resistance Checks	48	Appendix A, Illustrated Parts List.....	A1
Initial Power On Check	49		
KREF3 Reference Oscillator.....	49		
KREF3 Description	49		
KREF3 Installation Procedure	49		
KSYN3 Synthesizer	52		
KSYN3 Description	52		
KSYN3 Installation Procedure.....	52		



Elecraft manuals with color images may be downloaded from

www.elecraft.com.

Key to Symbols and Text Styles

 Identifies important information.

-100 Characters displayed on the LCD screen

DISP *Tap* switch function (labeled *above* a switch)

AVERAGE *Hold* switch function (labeled *below* a switch; hold for 1/2 sec. to activate)

MENU:Font Typical menu entry

Introduction

This manual will guide you through assembly of your Elecraft K3 transceiver. We're confident that you'll find the K3 easy to build, even if you've had no prior kit-building experience.

Every modern transceiver is complex, and the K3 is no exception. The kit includes nearly 300 individual components, including over a dozen PC boards and a multi-element modular chassis. But the K3's unique design eliminates some of the tedious aspects of construction, enabling you to complete assembly in far less time than previous high-performance transceiver kits. Also, virtually all of the alignment is handled in firmware using the K3's built-in test capabilities.

If you should have difficulty, you'll have our full support via phone and e-mail. In addition, we hope you'll join our growing and enthusiastic community of owner/builders via the Elecraft reflector.

Further information about the Elecraft K3, including specifications, installation, and operation instructions, can be found in the Owner's Manual.

Elecraft manuals with color images may be downloaded from www.elecraft.com.

Customer Service and Support

Technical Assistance

You can send e-mail to K3support@elecraft.com and we will respond quickly - typically the same day Monday through Friday. Telephone assistance is available from 9 A.M. to 5 P.M. Pacific time (weekdays only) at 831-763-4211. Please use e-mail rather than calling when possible since this gives us a written record of the details of your problem and allows us to handle a larger number of requests each day.

Repair / Alignment Service (We want to make sure everyone succeeds!)

If necessary, you may return your Elecraft product to us for repair or alignment. (Note: We offer unlimited email and phone support to get your kit running, so please try that route first as we can usually help you find the problem quickly.)

IMPORTANT: You must contact Elecraft before mailing your product to obtain authorization for the return, what address to ship it to and current information on repair fees and turn-around times. (Frequently we can determine the cause of your problem and save you the trouble of shipping it back to us.) Our repair location is different from our factory location in Aptos. We will give you the address to ship your kit to at the time of repair authorization. *Packages shipped to Aptos without authorization will incur an additional shipping charge for reshipment from Aptos to our repair depot.*

Elecraft's 1-Year Limited Warranty

This warranty is effective as of the date of first consumer purchase (or if shipped from factory, date product is shipped to customer). It covers both our kits and fully assembled products. For kits, before requesting warranty service, you should fully complete the assembly, carefully following all instructions in the manual.

Who is covered: This warranty covers the original owner of the Elecraft product as disclosed to Elecraft at the time of order. Elecraft products transferred by the purchaser to a third party, either by sale, gift or other method, who is not disclosed to Elecraft at the time of original order, are not covered by this warranty. If the Elecraft product is being bought indirectly for a third party, the third party's name and address must be provided to Elecraft at time of order to insure warranty coverage.

What is covered: During the first year after date of purchase, Elecraft will replace defective or missing parts free of charge (post-paid). We will also correct any malfunction to kits or assembled units caused by defective parts and materials. Purchaser pays inbound shipping to Elecraft for warranty repair, Elecraft will pay shipping to return the repaired equipment to you by UPS ground service or equivalent to the continental USA and Canada. Alaska, Hawaii and outside U.S. and Canada actual return shipping cost paid by owner.

What is not covered: This warranty does not cover correction of kit assembly errors. It also does not cover misalignment; repair of damage caused by misuse, negligence, or builder modifications; or any performance malfunctions involving non-Elecraft accessory equipment. The use of acid-core solder, water-soluble flux solder, or any corrosive or conductive flux or solvent will void this warranty in its entirety. Also not covered is reimbursement for loss of use, inconvenience, customer assembly or alignment time, or cost of unauthorized service.

Limitation of incidental or consequential damages: This warranty does not extend to non-Elecraft equipment or components used in conjunction with our products. Any such repair or replacement is the responsibility of the customer. Elecraft will not be liable for any special, indirect, incidental or consequential damages, including but not limited to any loss of business or profits.

Preventing Electrostatic Discharge Damage

There is no climate or work location where the components of your K3 are safe from Electrostatic Discharge (ESD) unless you take specific steps to prevent such damage. Many of the components in your K3 can be damaged by static discharges of only a few volts: far too little for you to notice. It is those low-voltage but destructive discharges that easily happen anywhere and under virtually any environmental conditions.

ESD damage may not be apparent at first. The damaged components may not fail completely. Instead, the damage may result in below-normal performance for an extended period of time before you experience a total failure.

How ESD Damage Occurs

Whenever an object containing a static charge touches a circuit in your K3, current will rush into the circuit until the components reach the same voltage as the source of the static charge. If the voltage or current that passes through a component in your K3 during that brief period exceeds its normal operating specifications, it may be damaged or destroyed.

Preventing ESD Damage

ESD damage cannot occur if there is no voltage difference between the components in your K3 and any object that touches them. That is how anti-static packaging works. Anti-static bags allow the static charge to flow over their surface, so that any part of the bag that touches the components inside are all at the same potential at all times. Anti-static foam keeps the leads of sensitive components at the same potential.

At your work bench, avoiding a dangerous voltage is achieved most easily by tying everything together and connecting them to a common mains safety ground. This includes your K3, individual boards or other sensitive components as well as everything they may touch at the work table.

Inexpensive static dissipating work mats are readily-available that will steadily and safely drain off any charges built up on parts or circuit boards placed on them. They are supplied with a lead that connects the mat to the common workbench ground. Also, metal cabinets on test equipment used on the bench should be tied together and connected to the common ground.

Most importantly, you must have a way of continuously draining off any static charges that occur on your body. Such charges are easy to create, even while sitting quietly at the work bench. Moving your feet on the floor, shifting position in your chair or even moving your arms so that clothing rubs against itself can all produce destructive static charges. You can discharge yourself by touching an unpainted metal ground, but that will last only until you move in a way that produces a new static charge. The safest technique is to wear a grounded wrist strap with a series 1-megohm resistor that continuously drains off any charges. Such wrist straps are readily-available and inexpensive.

WARNING

DO NOT attach a ground directly to yourself without a current-limiting resistor as this poses a serious shock hazard. A wrist strap must include a 1-megohm resistor to limit the current flow. If you choose to touch an unpainted, metal ground to discharge yourself, do it only when you are not touching any live circuits with your other hand or any part of your body.

We strongly recommend you take the following anti-static precautions (listed in order of importance) to avoid trouble:

- Leave ESD-sensitive parts in their anti-static packaging until you install them. The packaging may be a special plastic bag or the component's leads may be inserted in conductive foam. Parts which are especially ESD-sensitive are identified in the parts list and in the assembly procedures.
- Wear a conductive wrist strap with a series 1-megohm resistor. If you do not have a wrist strap, touch a ground briefly before touching any sensitive parts to discharge your body. Do this frequently while you are working. You can collect a destructive static charge on your body just sitting at the work bench. **DO NOT attach a ground directly to yourself as this poses a serious shock hazard.**
- Use a grounded anti-static mat on your work bench.
- If you choose to use a soldering iron to work on your K3 for any reason, be sure the iron is ESD-safe with a grounded tip tied to the same common ground used by your mat or wrist strap.

Preparing for Assembly

Overview of the Kit

The kit comprises two major assemblies: the main chassis and the front panel. Figure 1 shows an assembled K3/10 with its top cover removed.

The main chassis is literally built up around the RF circuit board, which fills the entire bottom of the unit of the chassis assembly. Panels are mounted around the RF board using Elecraft's 2D fasteners. These fasteners allow individual removal of any one panel, if needed, to gain access to the inside of the radio for servicing. Very few cables or wires are used in the kit. Most of the other boards and optional accessories plug directly into the RF board or one of the boards mounted on the RF board.

The front panel assembly, including the display and main operator controls, includes the front panel board and the digital signal processing (DSP) board.

There are many options that you can add to the basic K3/10, such as the 100 watt amplifier module, internal antenna tuner, second receiver, additional crystal I.F. filters, etc. If you purchased these options with your K3 kit, you will find instructions to install them at proper places in the assembly procedure to make getting your complete K3 together and operational in the most efficient manner.

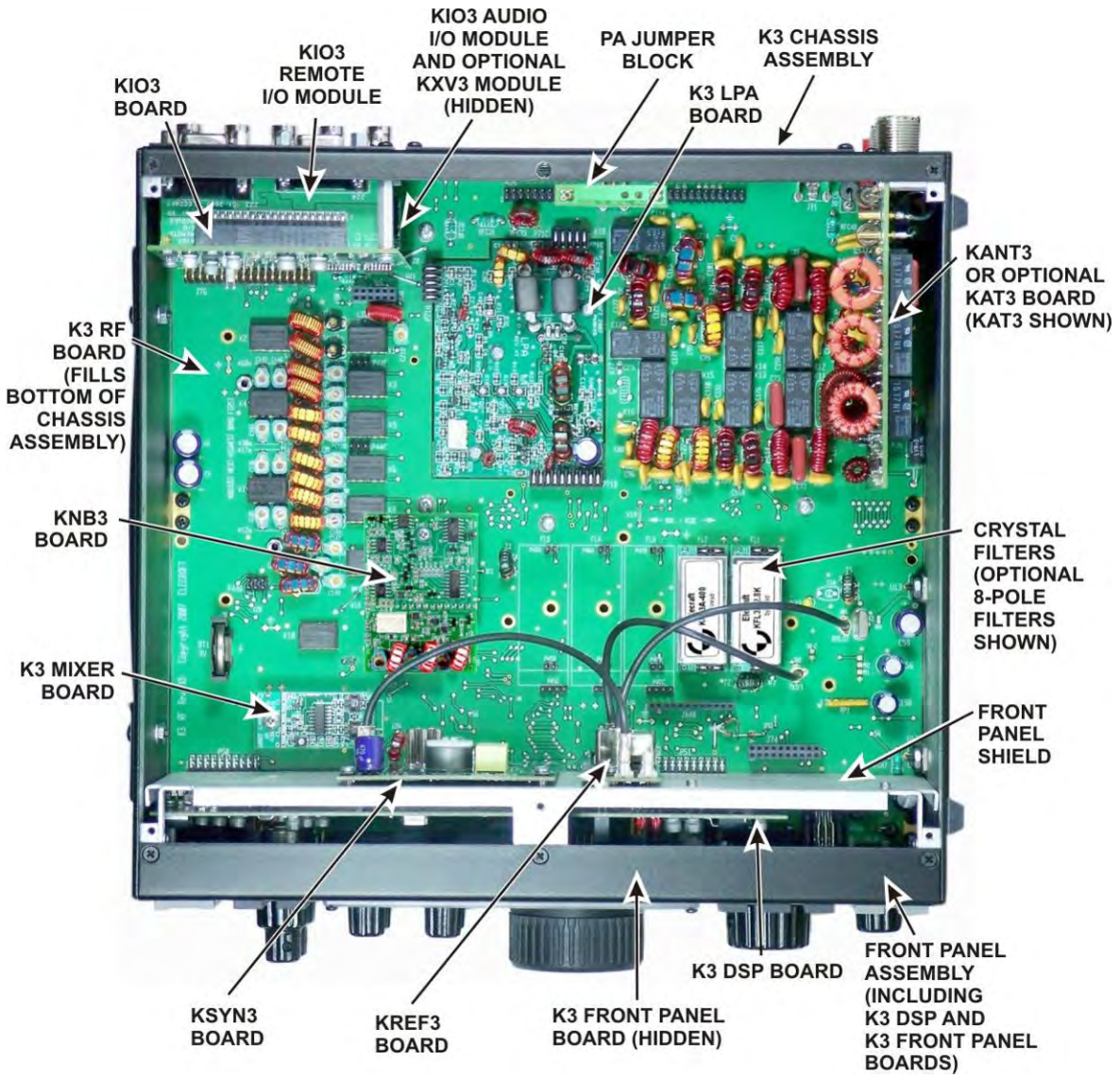


Figure 1. Typical Assembled K3/10 (Less Top Cover and Chassis Stiffener Bar).

Tools and Test Equipment Required

1. #0 and #1 size Phillips screwdrivers. To avoid damaging screws and nuts, ***do not use a power screwdriver***. Use the screwdriver that best fits the screw in each step.
2. Soft cloth or other surface to lay cabinet panels on to avoid scratching. A clean static-dissipating mat is ideal (see below). ***If using cloth, do not lay circuit boards on it. See Preventing Electrostatic Discharge Damage on page 5.***
3. Pliers or suitable wrenches for tightening 1/4", 3/16" and 1/2" nuts. The 1/2" size is used to tighten nuts on the front panel controls. If available, a deep socket or nut driver is recommended. Pliers or an ordinary wrench can be used, but requires care to avoid damaging the front panel paint.
4. Long nose pliers.
5. Diagonal cutters.
6. Small rule capable of measuring lengths up to 1" (2.5 cm) with an accuracy of at least 1/16" inch (1.6 mm).
7. Digital Multimeter (DMM) for resistance checks.
8. RF 50-ohm, 5 W (minimum) dummy load with low VSWR from 160 meters through 6 meters.
9. Power supply 13.8 VDC nominal (11-15 V) with a cable and Anderson PowerPole[®] connector. A power cable kit is provided with your K3 if you do not have a suitable cable with the required Anderson PowerPole connector. The power supply must be capable of providing at least 3 Amperes for a K3/10 and 20 Amperes for a K3/100. (See *Specifications* in your Owner's manual for more information on power supply recommendations).

The following tools are strongly recommended:

1. ESD wrist strap.
2. Static dissipating work mat.

Optional Equipment:

1. RF Power Meter with accurate readout from 1 mW to 5 watts, minimum.
2. Signal generator with calibrated 50 uV output at 20 or 40 meters.

In addition, two Allen wrenches, 5/64" (2mm) and .050", are supplied with your kit.

Unpacking and Inventory

CAUTION

Do not handle the circuit boards without anti-static protection! Doing so may damage sensitive components. See *Preventing Electrostatic Discharge Damage* on page 5 for important information before proceeding.

Before starting construction, do a complete inventory, comparing the parts in your kit with the parts list in Appendix A, to familiarize yourself with all of the parts and to ensure the kit is complete. When inventorying, look in the sealed envelopes to identify their contents, but not mix them up. Some screws are very similar in length, but must be used in the correct locations described in the procedure to avoid damaging your K3. A paper clip or piece of tape will hold the envelopes closed after you check their contents. Note that a few extras of some screws, nuts and washers may have been included on purpose.

All dimensions given in the assembly procedure are provided in both US customary (often called English) and metric measurements. The native dimensions of the parts are in US Customary units. Approximate metric equivalents are given to assist those more familiar with that system to identify the correct parts.

Screws

A number of different types and sizes of screws and washers are used in the assembly. It is very important that you use the screw specified in each location or your finished K3 may not fit together properly. In some places, using the wrong size screw may damage components. The following various screw types and sizes specified in the text are shown in Figure 2. Images are shown for comparing relative sizes. They are not to scale. The lengths of the screws called for in the text are measured as shown.


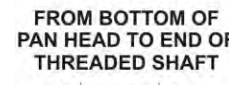





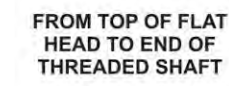



SCREW AS IDENTIFIED IN TEXT	RELATIVE SIZE (NOT TO SCALE)	MEASURING SCREW LENGTHS
2-56 5/32" (4.0 mm) BLACK PAN HEAD		FROM BOTTOM OF PAN HEAD TO END OF THREADED SHAFT
2-56 1/4" (6.4 mm) BLACK PAN HEAD		
4-40 3/16" (4.8 mm) BLACK PAN HEAD		FROM TOP OF FLAT HEAD TO END OF THREADED SHAFT
4-40 3/16" (4.8 mm) BLACK FLAT HEAD		
4-40 1/4" (6.4 mm) BLACK PAN HEAD		FROM TOP OF FLAT HEAD TO END OF THREADED SHAFT
4-40 3/8" (9.5 mm) BLACK PAN HEAD		
4-40 1/4" (6.4 mm) ZINC PAN HEAD		FROM TOP OF FLAT HEAD TO END OF THREADED SHAFT
4-40 3/8" (9.5 mm) BLACK FLAT HEAD		
4-40 7/16" (11 mm) ZINC PAN HEAD		FROM TOP OF FLAT HEAD TO END OF THREADED SHAFT
4-40 1/2" (13 mm) BLACK FLAT HEAD		
6-32 1/2" (13 mm) BLACK PAN HEAD		

Figure 2. Screw Sizes Used in Assembly.

Standoffs

A number of threaded standoffs are used. As with the screws and washers, be sure you use the correct size as specified in the text. Standoff lengths are measured from end to end as shown in Figure 3. Standoffs threaded for 2-56 and 4-40 screws are used.

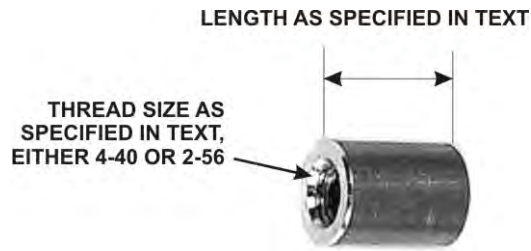


Figure 3. Typical Standoff.

Lock Washers

Two types of lock washers are used in the K3 (see Figure 4). It is important that you use only the type specified and put the washers exactly where indicated. Failing to use the correct type may result in short circuits to nearby circuit traces. Adding washers or placing the washers in the wrong position may cause parts to fail to fit together properly.



Figure 4. Lock Washers.

Assembly

IMPORTANT ASSEMBLY INFORMATION

1. Screws and other Fasteners: A variety of screws and fasteners are used to assemble your K3:
 - **Stainless Steel Hardware Kit:** If you purchased the optional hardware kit that provides stainless steel hardware for the external fasteners, the letters (SS) are included in the procedure wherever you should use the stainless steel parts instead of the parts supplied with this kit.
 - **Use your rule to check the length of screws and standoffs before installing them.** Some components are only 1/16" different from others but using the wrong size may result in parts not fitting correctly, possibly damage electrical and mechanical components. See *Screws* on page 9 and *Standoffs* on page 10 for more measurement instructions.
 - **Loosen screws as needed for a proper fit.** When mounting parts with multiple screws or adjacent parts that fit together, such as the exterior cabinet panels, loosen adjacent mounting screws as needed to adjust the parts for the best fit. Be certain you re-tighten the screws before proceeding.
 - **Ensure all screws are tight.** A loose screw can cause both mechanical and electrical problems such as intermittent operation, unexpected noise or false signals (birdies) in the receiver.
 - **Threads can be easily stripped** if too much force is applied when tightening screws. Use the correct size hand tool and apply only moderate torque. Do not use a power screwdriver!
2. Brief circuit descriptions are provided through the manual for those interested in the functions of the circuits. For more detailed circuit information, consult the Theory of Operation in your Owner's manual.

CAUTION – TO AVOID DEGRADING THE PERFORMANCE OF YOUR K3:

DO NOT DISTURB ANY ADJUSTMENTS ON THE BOARDS!

Each board was tested and aligned for optimum performance at the factory. Any change to these adjustments will degrade the performance of your K3 or prevent its operation altogether. All user calibrations and adjustments are done in firmware using the front panel menus. These are described at the appropriate points in the assembly procedures.

DO NOT ADJUST THE TURNS ON ANY TOROIDS!

The position of the turns on the cores of many toroids has been adjusted at the factory to produce exactly the inductance needed for the circuit to work properly. Any attempt to adjust their position or to make a coil look "nicer" may seriously degrade circuit performance.

Also, do not attempt to fix the turns or coils in place with adhesives or other materials. Those toroids needing support have been fixed at the factory. Adding material to the other toroids will alter their inductance, again degrading circuit performance.

ESD SENSITIVE!

Observe ESD precautions when handling the circuit boards and whenever you are working on your K3 with the covers off. Failure to observe ESD precautions may result in your K3 not operating at all, or operating but not meeting normal factory performance specifications due to damaged components. See page 4 for more information.

RF Board and Chassis

RF Board Description

The RF PCB (Printed Circuit Board) is the heart of the K3 transceiver, both physically and electrically. During assembly, it serves as an attachment point for other PCBs as well as chassis panels, acting as the glue that holds things together. During operation, the RF board provides signal routing to and from all modules. For more information, see *Theory of Operation, RF Board*, in the K3 Owner's Manual.

RF Board and Chassis Assembly Procedure

CAUTION

There are components on both sides of the circuit boards. When handling them, be careful not to damage components on either side by placing the board on top of tools or other objects, or bumping or crushing the components while mounting parts or installing the boards

Remove the RF board from its anti-static packaging. The top side of the board is the side with the toroid inductors and relays along with other components, including several connectors along one edge. The edge with the connectors is the back edge of the board, while the front edge has notches cut in it that will fit around front panel controls. Locate the six rectangular bare copper pads for the 2D fasteners (see Figure 5). There is one in each corner of the board and one in the center of each side (see Figure 11 on page 16).

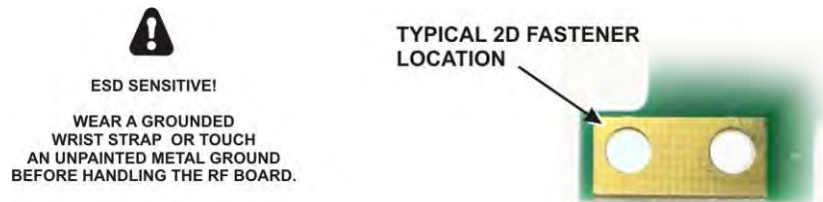


Figure 5. 2D Fastener Location on RF Board.

Install 2D fasteners at the six spaces provided (one at each corner and at the center of each side of the RF board). Mount the fasteners on the *bottom* side of the board as shown in Figure 6. Be sure the 2D fasteners are oriented so the side of each fastener lines up with the edge of the RF board as shown.

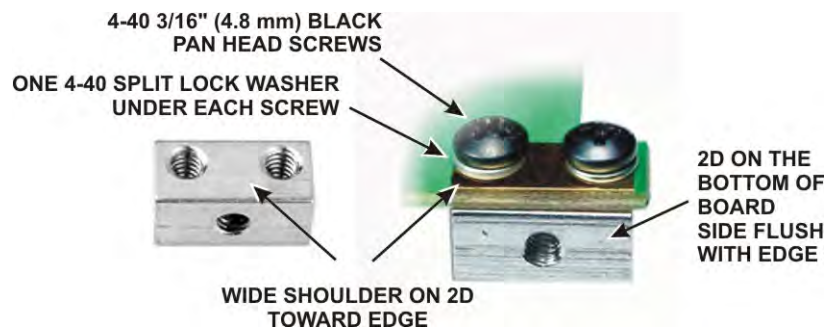


Figure 6. Installing 2D Fasteners on RF Board.

□ Install a 4-40 3/8" (9.5 mm) standoff on the RF board near connector Z1 as shown in below and Figure 11 on page 16. This standoff will support the mixer to be installed later. Install the standoff using *three* lock washers as shown below with two of the lock washers between the standoff and the RF board.

⚠ CAUTION: To avoid damaging the circuit trace between R74 and the metal ring around the mixer standoff screw hole, position the lock washer under the screw head with the split facing away from the trace, then tighten the assembly by turning the standoff while holding the screw and lock washer stationary.

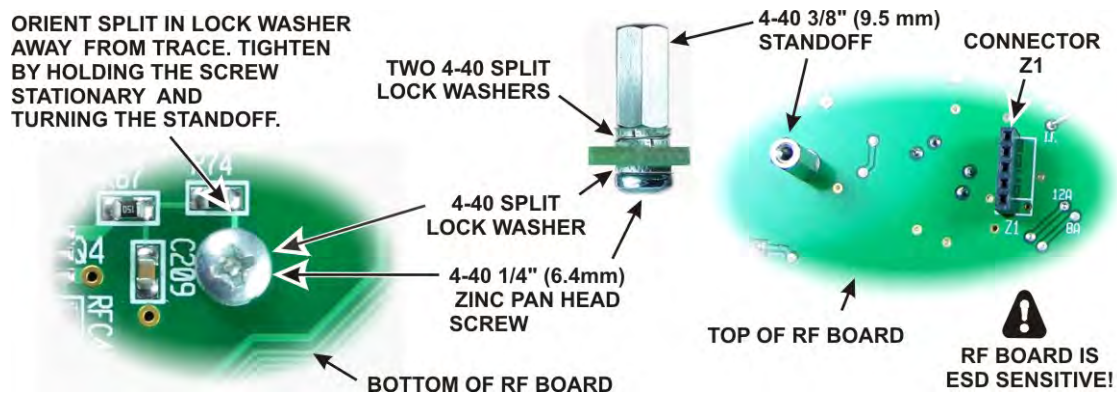


Figure 7. Installing Mixer Standoff.

□ Install the two KBPF3 standoffs shown in Figure 8. Even if you didn't purchase the KBPF3 general coverage option, the standoffs and hardware are included in the K3 kit to make installing the option easier at some future date. Note that these standoffs have only *one* lock washer between each standoff and the RF board

⚠ Note that one standoff is very close to the toroid coils. The standoff may touch the coil. That will not affect circuit performance. If you wish, you may adjust the position of the coil slightly to avoid contact. .

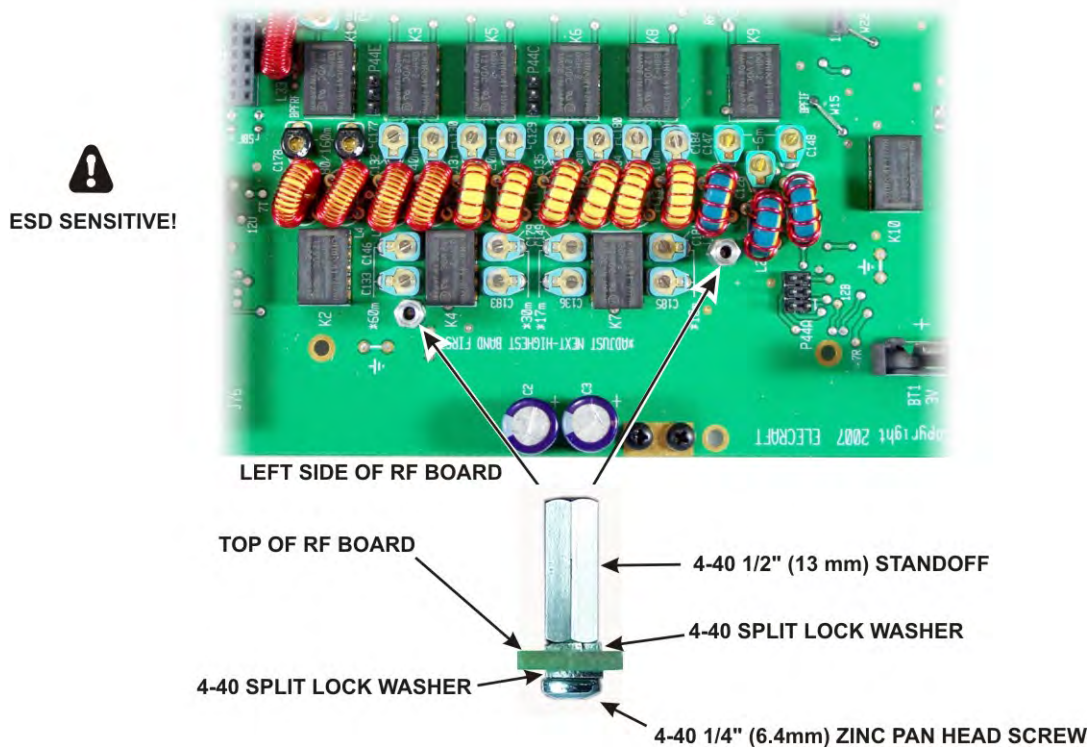


Figure 8. Installing KBPF3 Standoffs.

Install hardware to attach Q3 to the RF board near the rear left corner as shown in Figure 9 and Figure 11 on page 16.

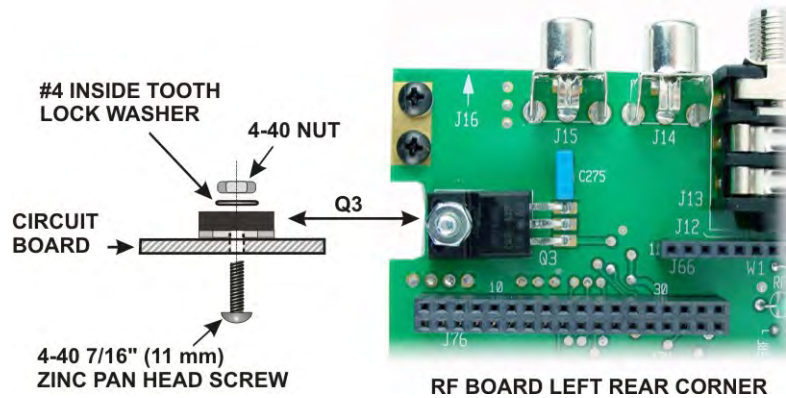


Figure 9. Installing Q3 Hardware.

Locate the crystal I.F. filters. Two types of filters are available: standard 5-pole filters and optional 8-pole filters (see Figure 10). One standard 5-pole 2.7 kHz filter is supplied. If you have elected to equip your K3 with the optional 8-pole 2.8 kHz filter, it has been supplied instead of the 2.7 kHz filter. If you have purchased additional filters, they may be installed now as well. If you plan to add filters later, spaces may be left for them. For example, if you plan to add the FM or a 6 kHz AM filter later, you can leave spaces FL1 and FL2 open for them and install the 2.8 kHz filter in position FL3. The filters are not hard to move about later, so if you aren't sure, install the widest at FL1, the next widest at FL2 and so on.

Enter the following data on Table 1. You will need this information to set up your filters after assembling your K3. Be sure you're following the rule described in the step above about the proper order for the filters. Note that Table 1 is set up with FL1 to the right and FL5 to the left, just as they must be installed on the RF board.

- Enter the bandwidth of each filter in the row below the filter position in which it will be installed.
- Enter the FREQ OFFSET shown on each filter. The optional 8-pole filters have no offset marked on them. Enter a zero in the FREQ OFFSET column for those filters. **For the 5-pole filters, note that the frequency offset may be *negative*, indicated by a minus sign (single dash) ahead of the number.**

Table 1. Filters Installed.

Note: FL1 is to the right and FL5 is to the left. In the next step you will install the filters right-to-left on the RF board as well.

POSITION	FL5	FL4	FL3	FL2	FL1 ¹
BANDWIDTH ²					
FREQ OFFSET ³					

1. If you're installing the K-FL3B FM filter, place it in FL1 position since it is the widest bandwidth filter available.
2. The bandwidth is shown in the label attached to the filters except the K-FL3B FM filter. Record a bandwidth of 13 kHz for the K-FL3B FM filter.
3. All of the optional 8-pole filters have an offset of zero. Note that the 5-pole filters may have a negative offset, indicated by a minus sign ahead of the number.

Install the filters as shown in Figure 10. Refer to the list of filters you created in Table 1 to determine which filter to install at each location.

⚠ CAUTION

1) Do not use screws longer than 1/4" (6.4 mm) to mount the filters. Use your ruler to measure the screws before installing them. Longer screws may extend into the optional 8-pole filter and destroy it. We strongly recommend you use a 1/4" screw even when installing the 5-pole filters to reduce the possibility of damaging an 8-pole filter should you change them later.

2) Do not over-tighten the screws. Too much torque may pull the threaded bushing out of the bottom of the filter module.

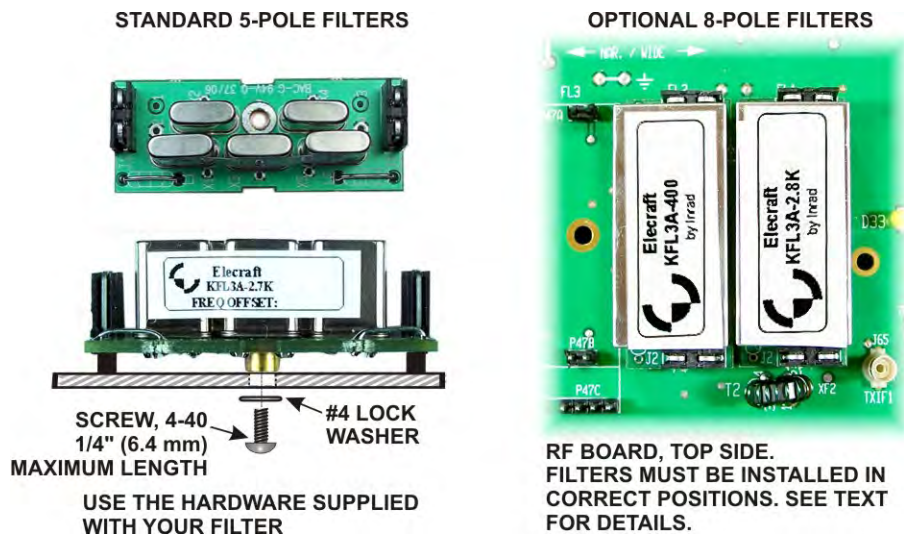


Figure 10. Installing Crystal I.F. Filters.

Locate the K3 top cover. On the inside is a label with places to record the bandwidth (BW), and frequency offset (FRQ) of each filter. Copy the information from Table 1 and place a check mark by Main (for main receiver) on the label. Use pencil in case you change your filters later. This will keep the filter information with your K3. The label also has a row for Gain. This is a value you can determine later after your K3 is assembled and aligned. It is a value set in the K3's MENU to adjust the overall gain for each roofing filter so the audio remains constant when switching from one filter to another. Making this adjustment is described under *Filter Loss Compensation* in your owner's manual.



ESD SENSITIVE!

**WEAR A GROUNDED
WRIST STRAP OR TOUCH
AN UNPAINTED METAL GROUND
BEFORE HANDLING THE RF BOARD.**

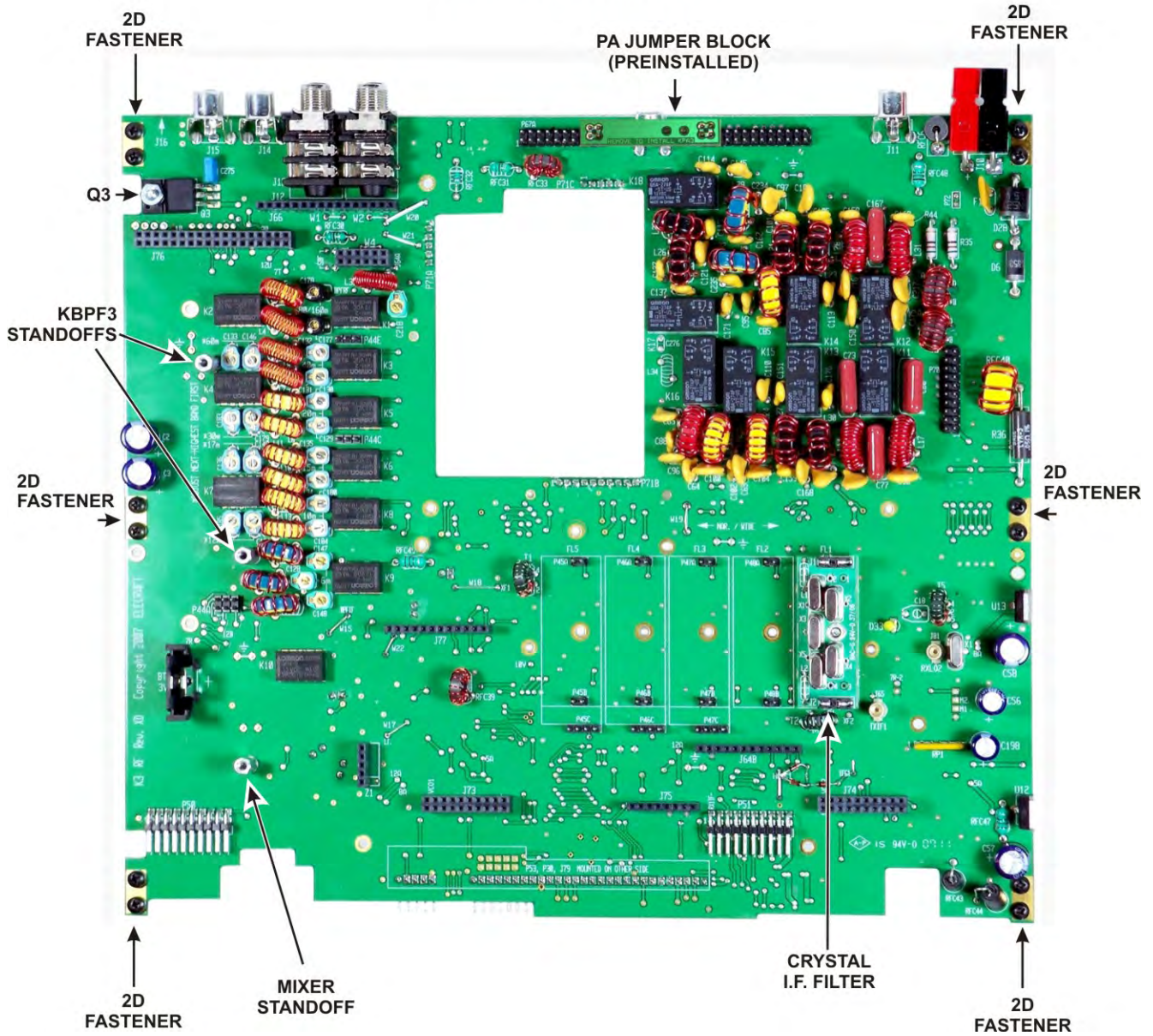


Figure 11. RF Board Partially Assembled.

Install the Low Power Amplifier (LPA) board in the cutout on the RF board as shown in Figure 12. The LPA board is held in place by its connectors until the bottom cover is installed..

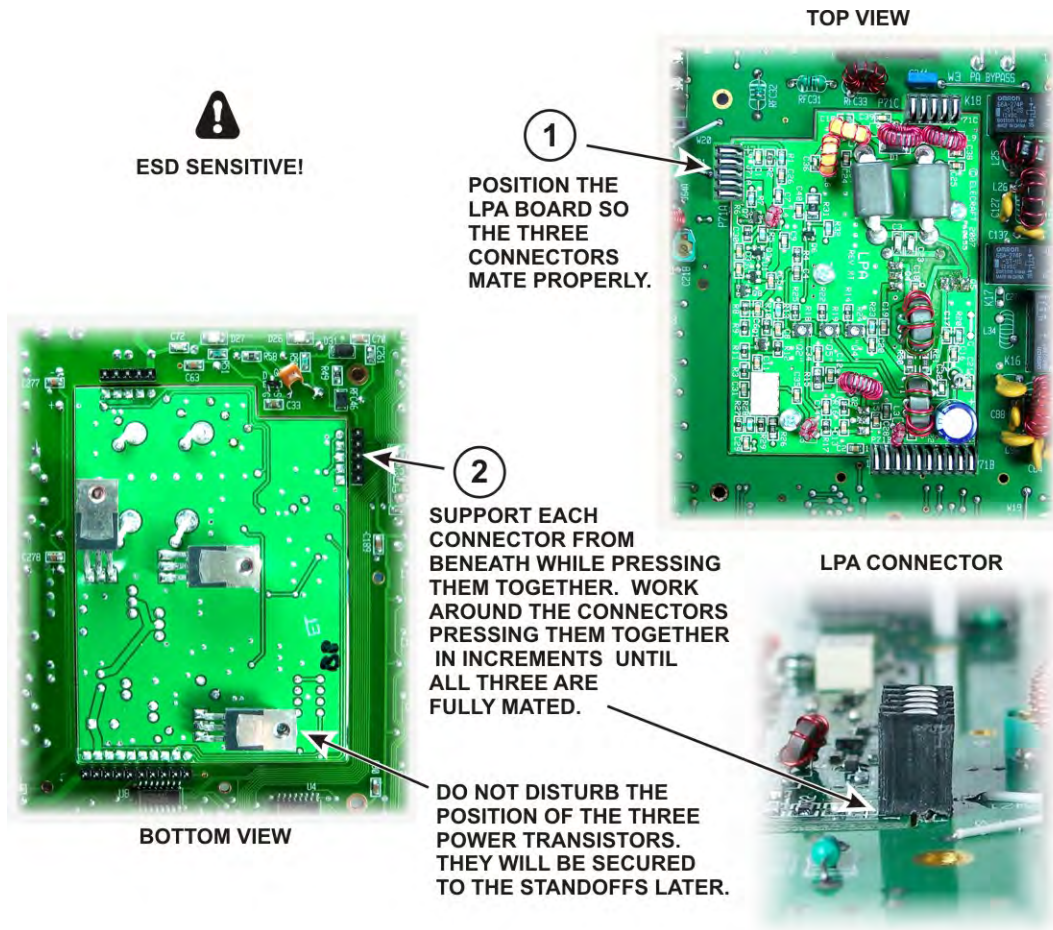


Figure 12. Installing the Low Power Amplifier (LPA).

Check all three LPA connectors shown in Figure 12 to ensure they are fully mated as shown. If they are not fully mated, the transistors will not rest against the K3 bottom cover as required when it is fitted later.

□ Mount a 2D fastener on each ear of the front panel shield, and then mount the shield on the RF board as shown in Figure 13. Be sure the 2D fasteners are oriented with the widest part between the two holes and the edge toward the outside as shown.

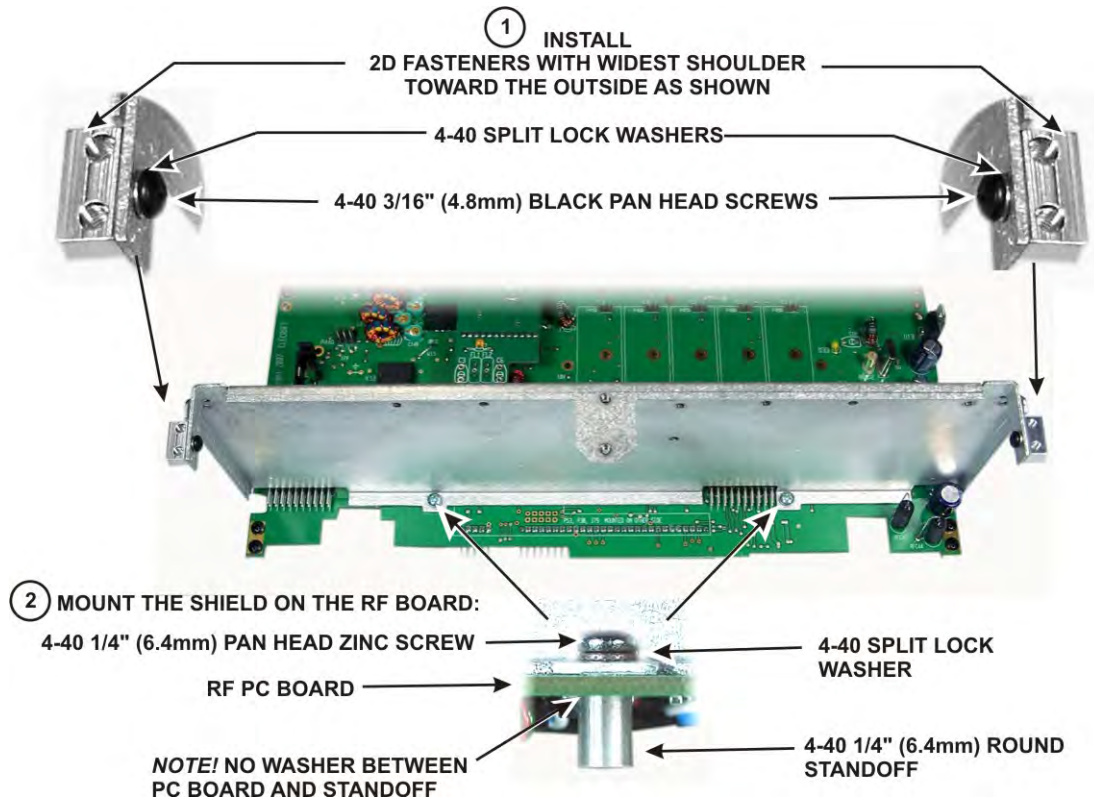


Figure 13. Installing Front Panel Shield.

□ Mount the K3 mixer board on the RF board as shown in Figure 14. The mixer plugs into Z1 on the RF board.

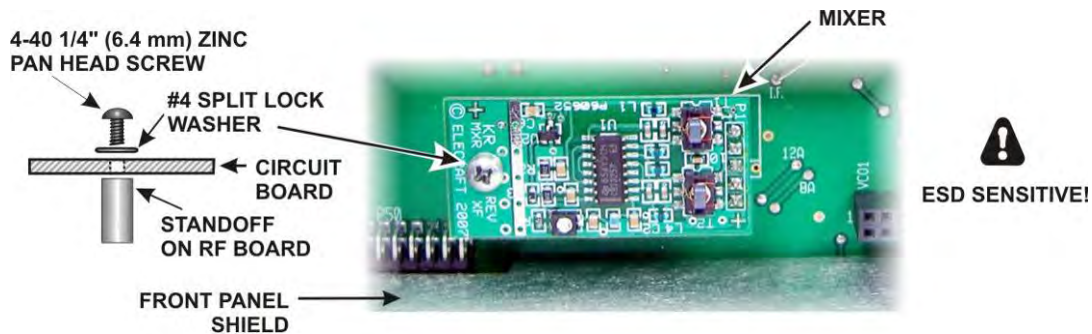


Figure 14. Installing Mixer Board.

- Locate the two side panels. They are approximately 4" (10 cm) by 9-7/8" (25 cm) in size. Both panels have six counter-sunk screw holes near the edges. Note that the countersunk holes are farther from one end than the other. This is important. You will need to orient the panels correctly as you install them. The side panels are different as well. In addition to the six counter-sunk screw holes, the left side panel has two holes near the centerline for attaching the handle and three larger counter-sunk holes near the top edge. The left side panel with the handle attached is shown in Figure 16. The right side panel has six additional holes; four for mounting the side feet and two for attaching other parts inside the K3 (see Figure 21). Set the right side panel aside for now.
- Check the inside (partially painted) of both panels to ensure no masking tape is covering any screw holes. If found, peel it off.
- Attach the handle to the left side cover using the hardware shown in Figure 15 at each end. The ribbed side of the handle faces away from the panel. Tighten the screws enough to compress the lock washers, but do not tighten the screws so much that you deform the handle end cover. The handle should move easily to allow room for your fingers between the handle and cover for carrying, then lie flat against the cover when it is not in use.



Figure 15. Installing Side Handle Mounting Hardware.

- Install three 6-32, 1/4" (6.4 mm) screws in the larger holes in the side panel shown in Figure 16. Use a #6 nut and split ring lock washer on the inside to secure each screw. These holes are for mounting the optional K144XV 2-meter module. The screws are provided to fill them when the option is not installed.
- Attach the left side panel to the RF board assembly as shown in Figure 16 using five 4-40 3/16" (4.8 mm) black flat head screws (SS). Do *not* use washers. When oriented correctly, the edge of the panel will extend about 1/2" (13 mm) past the 2D fasteners at the front panel shield. If needed, loosen the screws attaching the 2D fasteners to the RF board or front panel shield for best alignment. Tighten them again after the side panel is installed.



Figure 16. Mounting Left Side Panel.

Mount a 2D fastener at the top back corner of the left side panel (the one you just installed) with a 4-40 3/16" (4.8 mm) black flat head screw (SS) as shown in Figure 17. Do **not** use washers. Be sure the 2D fastener is oriented correctly as shown in the figure.



Figure 17. Installing Left Side Panel 2D Fastener.

KANT3 or KAT3, Right Side and Rear Panels

⚠ If you purchased a KAT3 with your kit, you did not get a KANT3 board with your kit. For more information, see the *KANT3 AND KAT3 Circuit Description* below.

KANT3 or KAT3 Description

The basic K3/10 includes a KANT3 antenna input module. If you've ordered a KAT3 antenna tuner, the KANT3 is not required and will not be supplied with the kit. In either case, the module plugs into the RF board at the back-right corner. Both the KANT3 and KAT3 provide antenna surge protection, as well as resistors for bleeding off static DC charge. The KAT3 provides a wide-range, switchable C-in/C-out L-network. See *Theory of Operation, KANT3 and KAT3*, in the K3 Owner's Manual for more details.

Installing KANT3 or KAT3 Antenna Connectors

Locate the rear panel and check the inside for any masking tape still covering screw holes. If found, peel it off.

Mount the SO239 connector in the ANT1 position on the rear panel using two 4-40 1/4" (6.4 mm) black pan head screws (SS), two 4-40 inside tooth lock washers and two 4-40 nuts as shown in Figure 18. The flange of the SO239 connector is on the inside (unpainted side) of the rear panel.



Figure 18. Mounting the ANT1 Connector.

If you are installing the KAT3, install the second SO239 connector in the ANT2 position on the rear panel using two 4-40 1/4" (6.4 mm) black pan head screws (SS), two 4-40 inside tooth lock washers and two 4-40 nuts just as you did for the ANT1 connector. Set the rear panel aside for now.

Installing KRX3 AUX RF (ANT) Connector

If you do not have the KRX3 Subreceiver option kit on hand, skip this section and go directly to *Preparing Right Side Panel for Installation* below to continue assembly.

If you have the KRX3 Subreceiver option kit on hand, you may wish to install the AUX RF antenna connector at this time. The AUX RF connector is one optional way to connect an antenna to the subreceiver. Before you decide, turn to your *KRX3 Installation and Operation Manual* and review the *Auxiliary KRX3 Antenna Input (Optional)* section. It is not necessary to install the connector now, even if you decide to use it. Complete instructions for installing it later are included in your KRX3 manual.

If you wish to install the AUX RF connector now, do so as follows.

- Retrieve the following components from your KRX3 Subreceiver kit:
 - Coaxial cable with a pre-mounted BNC female panel connector on one end and a TMP connector on the other end (TMP connectors are shown in Figure 75 on page 54).
 - Nut and inside tooth lock washer that fits the BNC connector. (They may be supplied threaded onto the connector. If so, remove them.)
 - One 4-40 3/8" (9.5 mm) black pan head screw.
 - One #4 inside tooth lock washer.
 - One 4-40 nut.
- The highly scratch-resistant powder coating on the rear panel may interfere with the fit of the BNC connector through the hole. Remove the coating around the edge of the hole using a hobby knife or other sharp tool (see Figure 19). Note that the hole is flat at the top. That is intentional.

THE DURABLE POWDER COATING
MAY INTERFERE WITH THE FIT OF THE
CONNECTOR. USE A HOBBY KNIFE
OR OTHER SHARP TOOL TO REMOVE
THE COATING FROM THE INSIDE
EDGE OF THE HOLE.



Figure 19. Removing the Powder Coating from the AUX RF Connector Hole.

Thread the BNC/TMP cable through the AUX RF connector hole from the outside, lining up the flat on the threaded section of the connector with the flat at the top of the hole. Slide the lock washer and nut onto the cable. Fold the solder lug on the braid down against the coax to fit through the back panel hole, the lock washer and the nut. Thread the nut onto the connector and tighten it (see Figure 20).

Mount the solder lug attached to the braid as shown in Figure 20, using a 4-40 3/8" (9.5mm) black pan head screw (SS), #4 inside tooth lock washer and 4-40 nut. If you have the KAT3 option, there will be a shorter screw holding the connector flange. Replace it with the 3/8" (9.5 mm) screw. If you do not have a KAT3, there will be no connector in the ANT2 hole. In that case, the solder lug is directly against the unpainted inside surface of the rear panel.

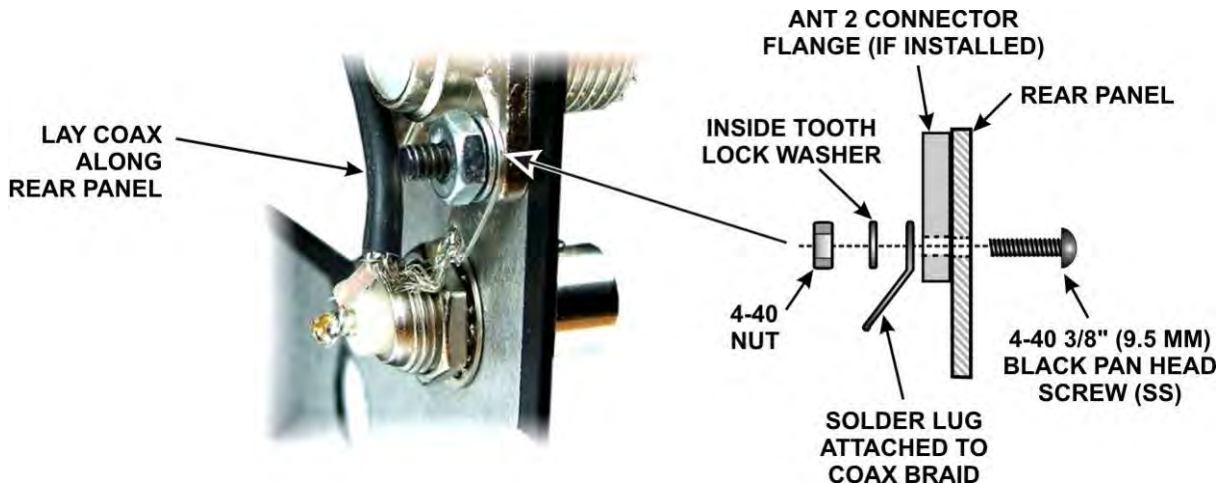


Figure 20. Installing the AUX RF Connector.

Carefully insulate the metal TMP connector, covering all of the metal parts with electrical tape or other suitable material that you can remove easily later.

⚠ CAUTION

Later you will apply power to do preliminary testing and calibration before the KRX3 Subreceiver is installed. Failure to insulate the TMP connector as described above may result in short circuits and extensive damage to your K3 if it touches a component, solder pad or other exposed circuit points.

Preparing Right Side Panel for Installation

□ Install the four rubber side feet in the holes in the right side panel as shown in Figure 21. Two suggested procedures for doing this are as follows:

Press Method:

- Wet the tip of the foot with a *tiny* amount of soap. (Do not use petroleum jelly or oils. They can deteriorate the rubber over time).
- Place the foot, tip up, on a solid work surface.
- Position the panel with the outside (fully painted side) toward the foot with the hole in the panel against the tip and press down. The tip should slip through the hole without further help. If necessary, grip the tip and pull with your long-nose pliers, working it from side to side until the shoulder opens against the inside of the panel. ***Do not use excessive force. You can tear the foot apart.***
- Wipe any excess soap off of the panel or foot.

Twist Method:

- Press the foot against the outside (fully painted side) of the panel so the tip is in the hole at an angle.
- While pressing the tip into the hole, twist the foot so the edge of the tip grabs the inside edge of the hole.
- Continue pressing and twisting until the tip is fully inside the panel all the way around its circumference. ***Do not twist with excessive force. You can tear the foot apart.***

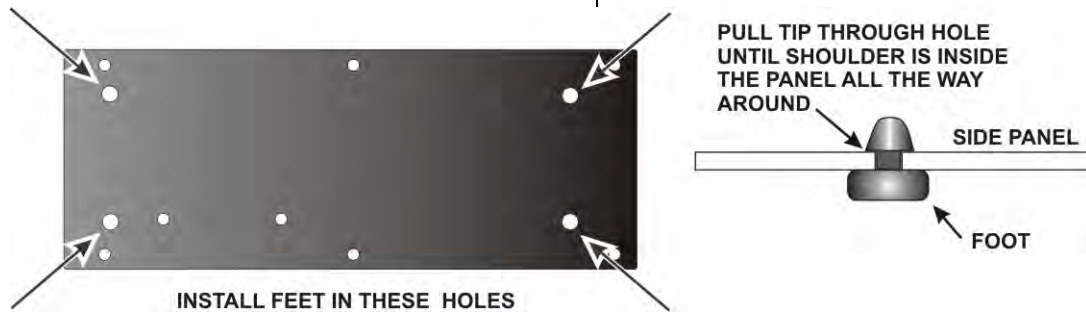


Figure 21. Installing Side Panel Feet.

□ Position the right side panel against the K3 to verify how it will fit against the RF board. When it is oriented correctly, the three holes along the bottom edge will line up with the holes in the 2D fasteners on the RF board and two holes in the side panel will be aligned with the tabs on voltage regulators U12 and U13. The end of the panel toward the rear will very nearly line up flush with the edge of the RF board. Do not mount the side panel yet, but note which corner of the panel is in the upper rear corner. You'll work with this corner in the next step.

□ At the upper rear corner of the side panel you just identified in the previous step, mount a 2D fastener as shown in Figure 22, using a black 4-40 1/2" (13 mm) flat head screw (SS). Remember that flat head screws are measured from the flat top to the end of the threads. Note that the screw extends some distance through the 2D fastener.

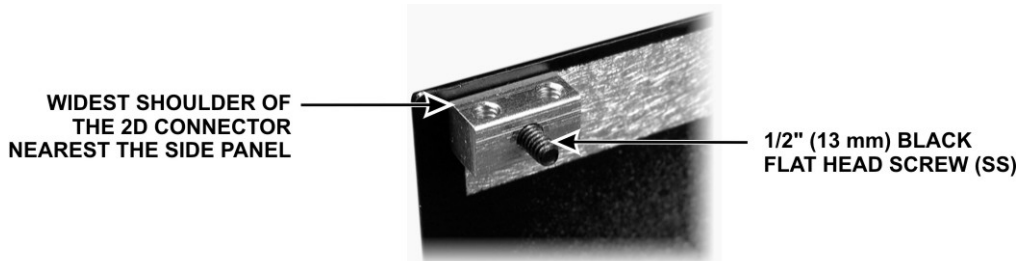


Figure 22. Mounting 2D fastener for KANT3 or KAT3 Standoff.

□ Screw a 4-40 1/2" (13 mm) standoff onto the exposed end of the screw as shown in Figure 23. **Do not use a lock washer between the standoff and the 2D fastener.** Tighten the standoff securely against the 2D fastener. Set the side panel aside temporarily.

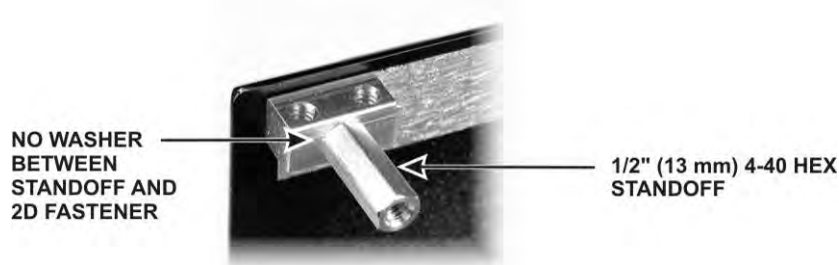


Figure 23. KANT3/KAT3 Mounting Standoff.

Mounting the KANT3 or KAT3, Side and Rear Panels

□ Insert J70 on the KANT3 or the KAT3 board into P70 near the red and black APP power connectors at the right rear corner of the RF board. The KANT3 board is shown in Figure 24. The KAT3 board fits exactly the same way *with the toroidal inductors toward the center of the RF board.*



NOTE:

DUE TO DESIGN CHANGES, L3 MAY NOT BE PRESENT. (YOU MAY SEE CLIPPED LEADS WHERE IT WAS REMOVED. THAT IS NORMAL.) ALSO, ON SOME BOARDS C6 AND C6 MAY NOT BE PRESENT.

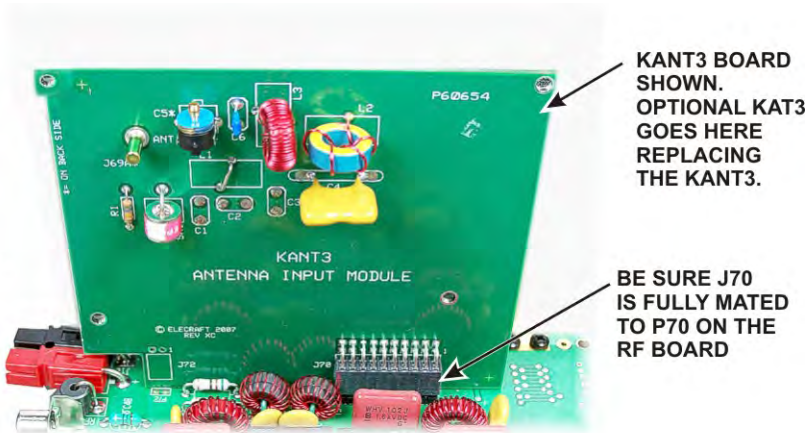


Figure 24. Installing the KANT3 or KAT3 Board.

Peel the backing from the self-adhesive serial number label and attach it to the back panel as shown in Figure 25. You may wait until the assembly is finished before attaching the serial number, but at this point you can lay the panel flat on the work surface to easily position the label square within the outline.



Figure 25. Attaching Serial Number.

Position the rear panel on the K3 chassis assembly so that the SO239 connector(s) are at the end nearest the KANT3 or KAT3 board. If installed, the coax cable attached to the AUX RF connector should pass between the rear panel and the KAT3 or KANT3 board (see Figure 26). Thread the 6-32 thumbscrew into the ground terminal position near the center of the rear panel as shown in Figure 27. Use two #6 flat washers between the thumbscrew and the back panel as shown. If the hole in the rear panel does not line up with the threaded hole in the ground bracket mounted on the RF board, loosen the side panel screws at the end nearest the rear panel so you can adjust the position of the rear panel as needed.

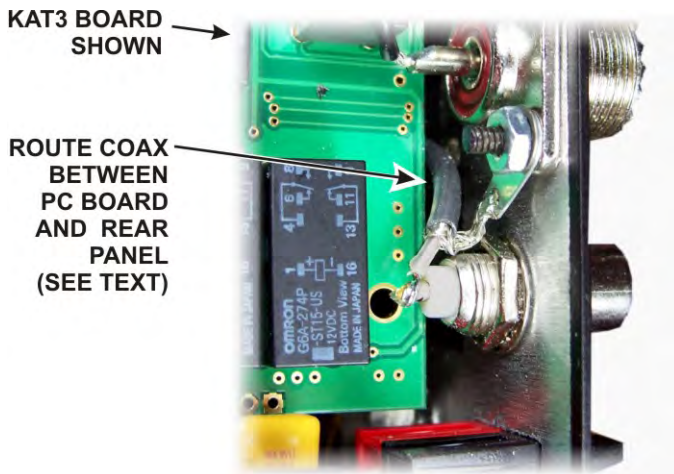


Figure 26. Routing AUX RF Connector Coax.

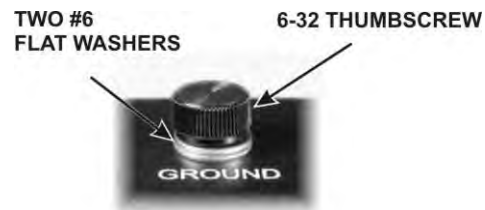


Figure 27. Installing Rear Panel Ground Screw

If you loosened the side panel screws in the previous step, tighten them again now.

Attach the bottom lip of the rear panel to the 2D fasteners at the rear corners of the RF board with 4-40, 3/16" (4.8 mm) black **pan head** screws (SS). (Note that all the screws used on the bottom of the K3 are black pan head screws.)

Connect the wires from the SO239 connector(s) to the KANT3 or KAT3 board as shown in Figure 28. Use needle-nose pliers to grip the terminals on the wire ends and carefully insert the connectors *straight* into the holes in the board. They may be very difficult to insert unless they are perfectly aligned. While inserting the plugs, support the board with your fingers to avoid putting stress on the connector at the bottom.

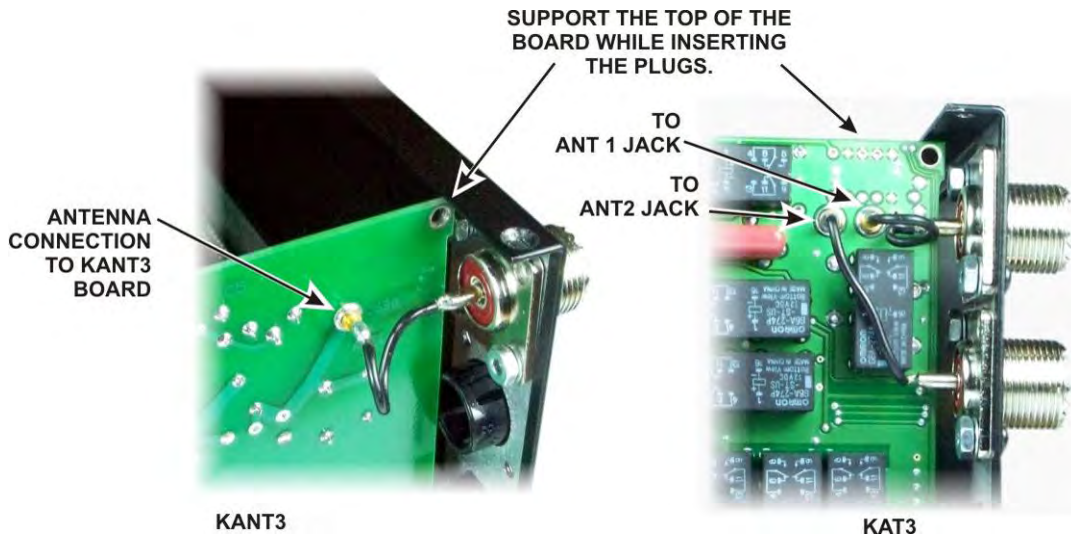


Figure 28. ANT Connections to KANT3 or KAT3 Boards.

Attach the right side panel to the RF board assembly four 4-40 3/16" (4.8mm) black flat head screws: three along the bottom and one at the top front into the 2D fastener on the front panel shield. Do *not* use washers. Note that there are two open holes for screws to secure voltage regulators U12 and U13. They will be installed later.

Mount the KANT3 or KAT3 board to the standoff on the side panel with a 4-40 1/4" (6.4mm) zinc pan head screw and a #4 split lock washer under the screw head as shown in Figure 29. *Do not place a washer between the board and the standoff.*

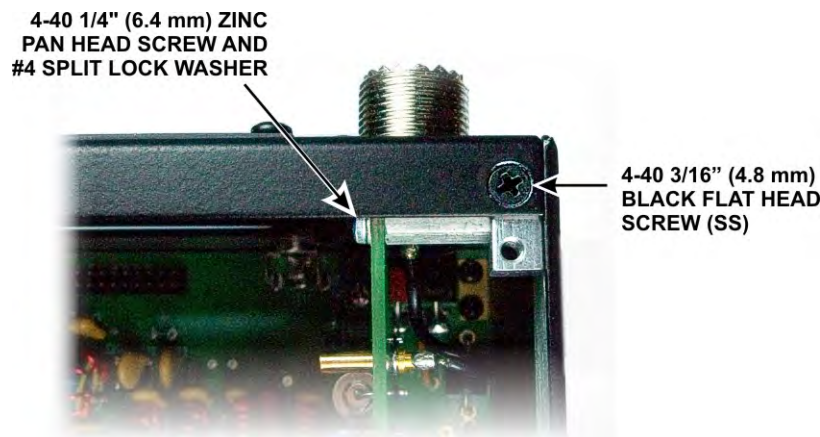


Figure 29. Installing KANT3/KAT3 Mounting Screw.

Install a 4-40 3/16" (4.8 mm) black flat head screw (SS) to secure the top of the rear panel to the 2D fastener as shown in Figure 29

Install another 4-40 3/16" (4.8 mm) black flat head screw (SS) at the opposite end of the rear panel to secure it to the top 2D fastener on the left side panel. When properly positioned, the rear panel should fit snugly against the inside edge of the side panel as shown in Figure 29. Verify the fit is correct at both ends. If necessary loosen the 2D fastener screws enough to adjust the position of the panels. .

If you installed the KANT3 board, the hole for the ANT2 jack is not used. Insert the larger of the hole plugs in the opening until it clicks in place (see Figure 30).

If you do not have the K3EXREF option, insert one of the smaller hole plugs in the REF connector at the bottom right. Align the open side of the plug with the flat side of the hole as shown in Figure 30. If the plug does not have a cutout, use your diagonal cutters to clip out a section of the plug so it will fit into the hole. Similarly, install the other small plug in the AUX RF opening if the subreceiver connector was not installed.

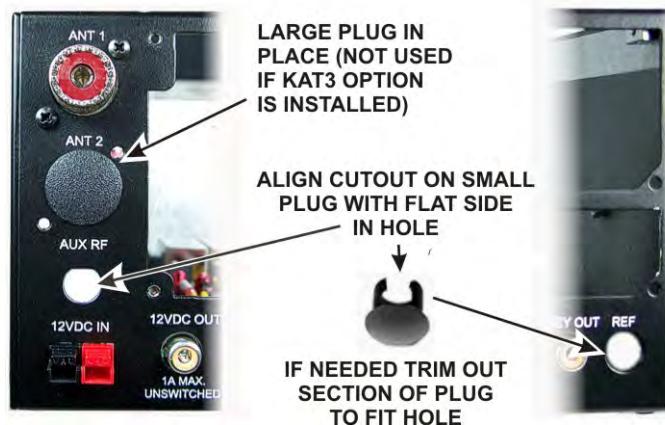


Figure 30. Installing Rear Panel Hole Plugs.

KIO3 Interface

KIO3 Description

All rear-panel audio and digital/computer I/O is routed through the KIO3. The KIO3 is made up of three PC boards: Main, Audio I/O and Digital I/O. The Main KIO3 board plugs directly into the RF board, while the Audio and Digital I/O modules plug into the KIO3 main board. All three boards can be upgraded to meet future requirements. See *Theory of Operation, KIO3*, in the K3 Owner's Manual for more information.

KIO3 Interface Installation Procedure

If you have purchased the KXV3 option with your kit, go to the *Installation Procedure* in the KXV3 manual and install the option now, following the instructions in the *Special Note to K3 Kit Builders*. Otherwise mount the small blank panel in the space directly above PADDLE, KEY, PTT and KEY OUT connectors on the rear panel as shown in Figure 31.



DO NOT INSTALL IF YOU ARE INSTALLING THE KXV3 INTERFACE OPTION. SEE TEXT FOR DETAILS.



Figure 31. Preparing Rear Panel for KIO3 Installation.

Mount two 1-1/4" (31.8 mm) standoffs in the two holes on the KIO3 board as shown in Figure 33 using a zinc 4-40 1/4" (6.4 mm) screw and inside tooth lock washer at each standoff. One is in the corner and the other is about half way down the opposite side of the board. **Do not put lock washers between the standoffs and the board.**

Inspect the KIO3 Audio board for a yellow dot at one corner of the board (see below). There are two versions of the audio board, one with a yellow dot and one without. Both versions provide the same performance but the version with a yellow dot requires a simple change to the firmware setup when you apply power to test your K3. Check either "yellow dot" or "no yellow dot" below to remind you which version board you are installing.

Yellow Dot

No Yellow Dot

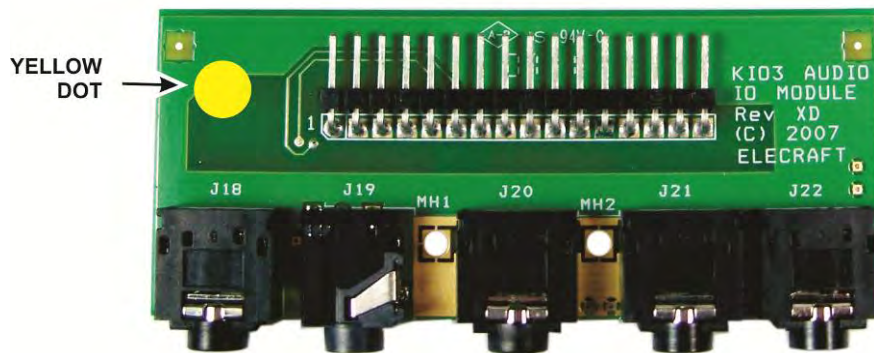


Figure 32. Yellow Dot on KIO3 Audio Board.

Plug the Audio I/O daughter board into J91 as shown in Figure 33. The second daughter board will be installed later.

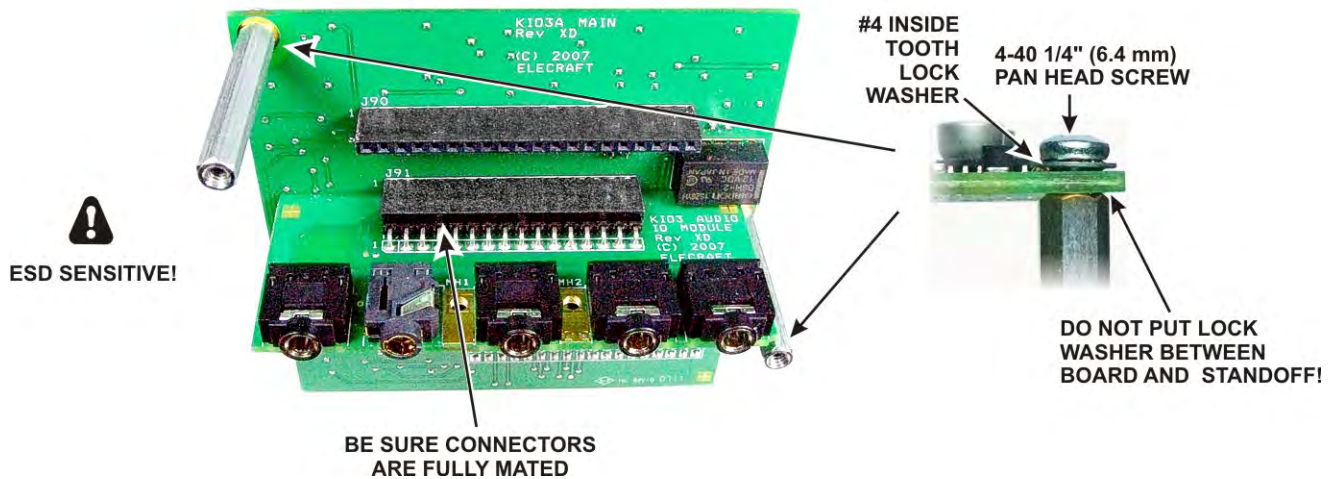


Figure 33. Preparing the KIO3 Board for Installation.

□ Install the KIO3 Main board with the Audio I/O daughter board attached into the K3 as shown in Figure 34. The KIO3A main board plugs into J76 on the RF board. If the KXV3 is installed, the coaxial TMP cable fits between the KXV3 and KIO3 boards. Ensure the connectors are fully mated so the standoffs line up with the screw holes on the rear panel.



Figure 34. Installing KIO3 Main Board.

□ The DB9 multi-pin connector on the KIO3 Digital I/O daughter board may have jackscrew nuts installed on the connector. (Jackscrew nuts are shown in Figure 36). If so, remove them. They will be reinstalled shortly.

□ Install the KIO3 Digital I/O daughter board as shown in Figure 35. Be careful to support the KIO3 main board as shown while pressing the daughter board in place.

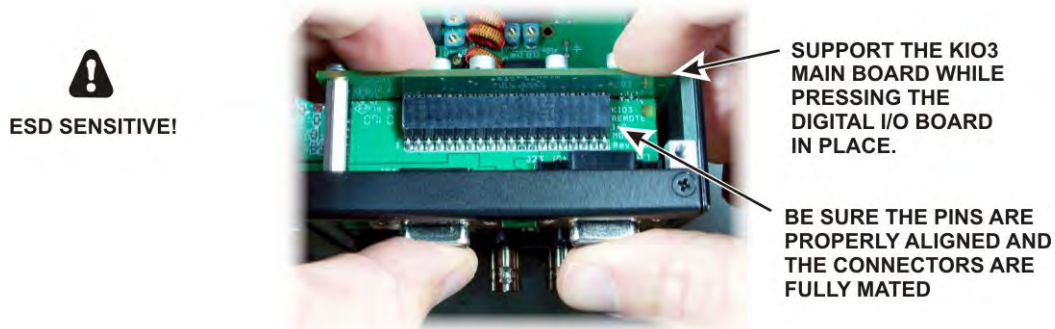


Figure 35. Installing the KIO3 Digital I/O Board.

- Install the KIO3 rear panel as shown in Figure 36.

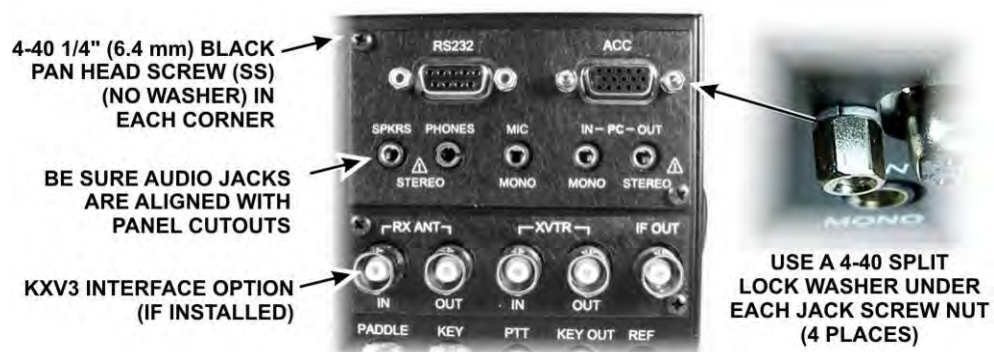


Figure 36. Mounting the KIO3 Connector Panel.

Front Panel and DSP

Front Panel and DSP Description

The Front Panel is a large plug-in module that provides the K3's user interface (LCD, switches, shaft encoders, potentiometers, and LEDs) as well as the microcontroller (MCU) and parameter storage (EEPROM and FLASH). It also includes the 32-bit DSP assembly, which processes all AF and IF signals. See *Theory of Operation, Front Panel and DSP*, in the K3 Owner's Manual.

Front Panel Assembly Procedure

CAUTION

Do not use inside tooth lock washers where split lock washers are specified. Inside tooth lock washers are slightly larger and may short nearby circuit pads.

- Mount three standoffs on the back of the front panel board as shown in Figure 37 . Place the lock washer between the screw head and the board as shown.

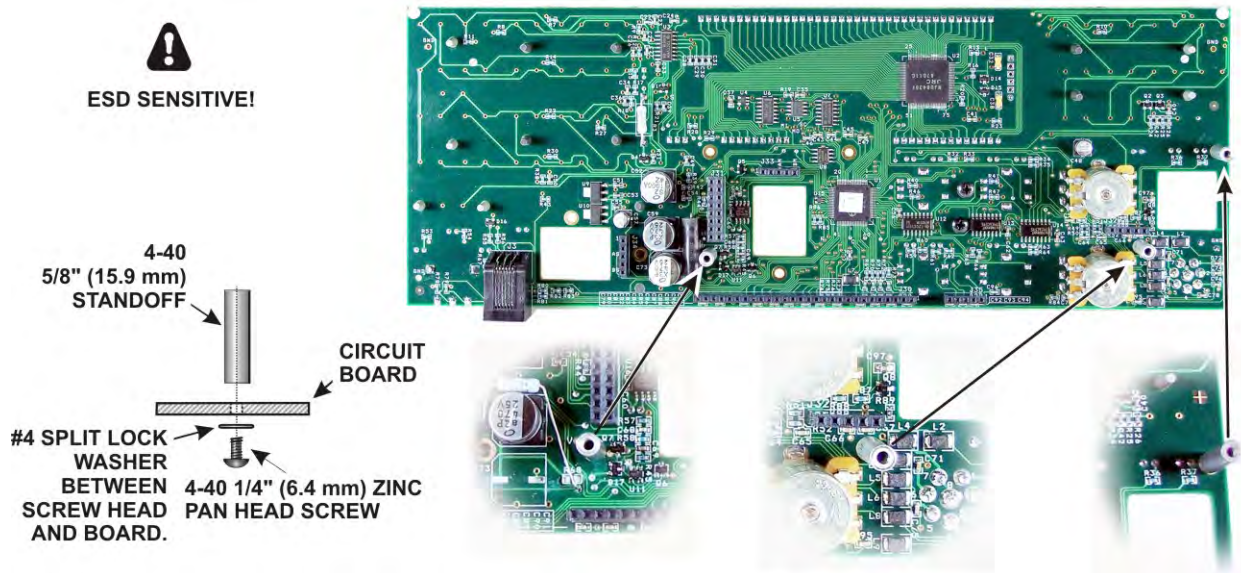


Figure 37. Preparing the Front Panel Board for Mounting, Part 1.

- On the front side of the board, mount four standoffs as shown in Figure 38.

⚠ IMPORTANT!

1. Place the split lock washers between the standoff and board as shown in the figure. This is important to establish the correct spacing between the board and the front panel.
2. Note that the two standoffs near the LCD use smaller #2 hardware.

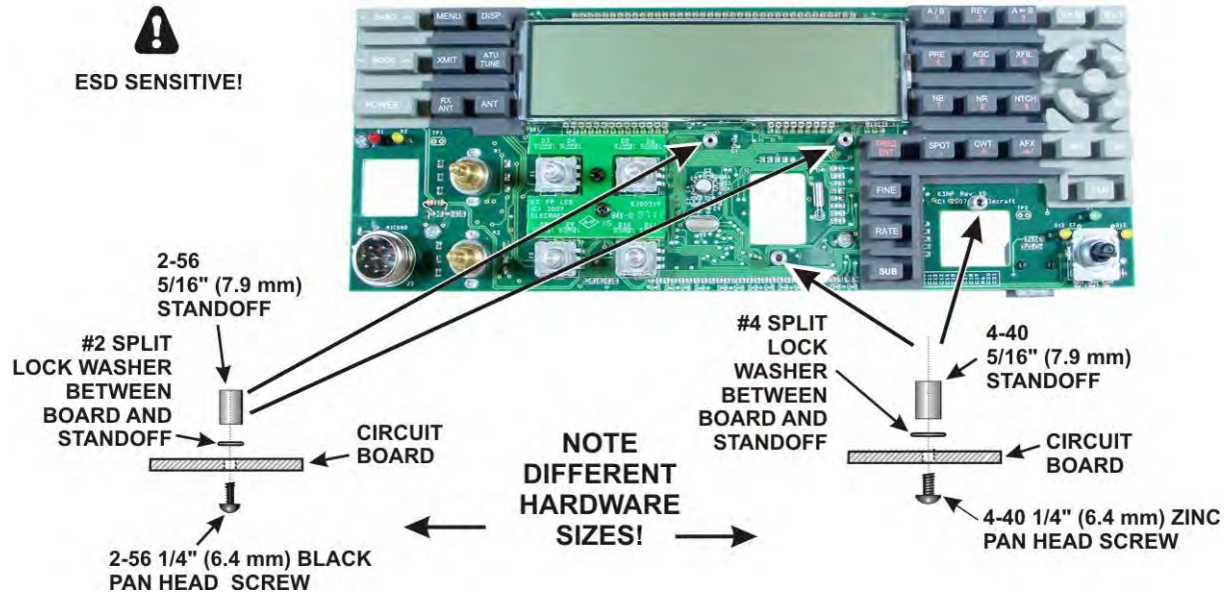


Figure 38. Preparing the Front Panel Board for Mounting, Part 2.

- Inspect the front panel board to verify the following:
 - Three 4-40 5/8" (15.9 mm) standoffs are mounted on the back as shown in Figure 37.
 - Two 4-40 5/16" (7.9 mm) standoffs are mounted on the front as shown in Figure 38.
 - Two 2-56 5/16" (7.9 mm) standoffs are mounted on the front as shown in Figure 38.

□ Install the two soft foam light blockers at the ends of the LCD display as shown in Figure 39. Remove the paper strip covering the adhesive on each blocker and stick that side against the board (or the lip at the base of the switch buttons) so it stands up between the switches and the LCD. Push them down so the adhesive side is against the board or base of the switches and that they cover ends of the LCD, including the terminals at the right hand end of the LCD as shown.

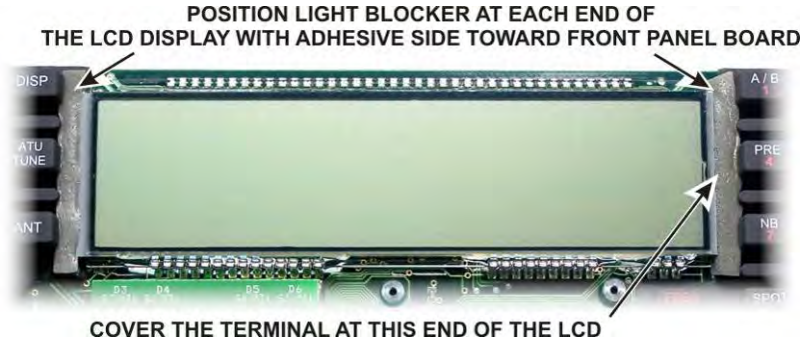


Figure 39. Installing LCD Light Blocker.

□ Locate the front panel and inspect the inside surface for any masking tape covering the holes left during the painting process. If any is found peel it off.

□ Locate a 2-56 5/32" (4.0 mm) black pan head screw found in the small envelope marked E850340 LCD Bezel Screws Envelope 2-56 5/32 Blk Ox PH+(700149). Thread the screw through each of the four threaded holes at the corners of the opening in the front panel for the LCD to ensure they are clear of paint (see Figure 40). Lubricate the screw if the fit is tight. A drop of water on the threads will usually work well and it is easier to wipe away excess water than oil. Return the screw to the envelope until it is called for later.



Figure 40. Checking 2-56 Threaded Screw Holes.

□ Place the front panel board face up on your work surface, then set the front panel over it as shown in Figure 41. Check to ensure the LEDs above the four controls under the LCD display, the red and yellow LEDs below the POWER button, and the three LEDs above the control in the lower right corner of the panel are positioned in their openings. If necessary, lift the panel off and gently adjust the position of the LEDs.

☐ Ensure the flange on the MIC connector is not caught behind the panel. The flange should be slightly above the panel as shown all the way around its circumference as shown in Figure 41. It may be a snug fit requiring you to press it into place, pushing on the back of the connector. If the connector refuses to fit through the hole in the front panel, use a sharp tool to carefully remove the paint from the inside edge where the connector is binding against the hole. Work from the *inside* of the front panel to avoid damaging the paint on the front edge of the MIC connector hole.

☐ Secure the front panel to the board with a 4-40 3/16" (4.8 mm) black flat head screw (SS) above the control opening near the right end and a 1/2" (13mm) nut and inside tooth lock washer on each concentric pot bushing near the left end as shown. Tighten the screw and nuts only until you feel firm resistance. Be very careful not to scratch the front panel.



Figure 41. Mounting the Front Panel on the Front Panel Board.

☐ Two identical encoder assemblies are provided for VFO A and VFO B. Select one encoder and place a 1/2" (13mm) inside tooth lock washer over the threaded shaft as shown in Figure 42. This will be the VFO A encoder.



Figure 42. VFO A Encoder Assembly Preparation for Installation.

Place the VFO A encoder in the opening near the center of the front panel board so the shaft protrudes through the opening under the LCD. Be careful to avoid dropping the lock washer into to the space between the front panel board and the front panel. Normally, the lock washer hangs on the threads while you put the encoder in place. Optionally, you can hold the encoder with the shaft upright and place the front-panel assembly over it until the shaft is through the hole. Orient the encoder so the pins mate with connector J33 on the front panel board as shown in Figure 43.

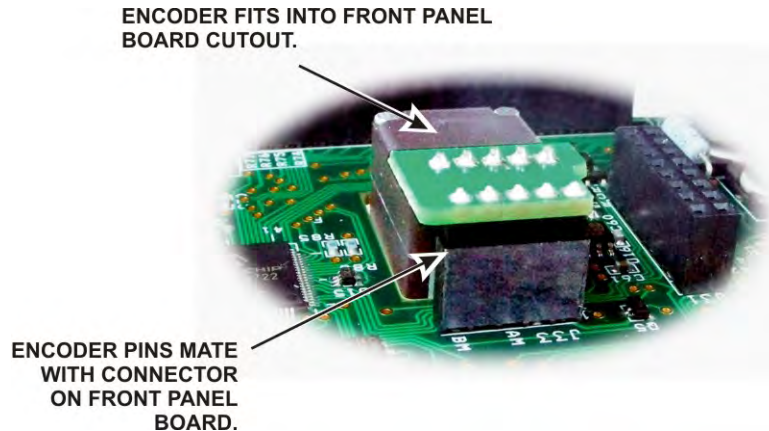


Figure 43. Mounting VFO Encoders.

Place a 1/2" (13mm) inside tooth lock washer and nut on the threaded shaft of the VFO A encoder and tighten them against the front panel. Take care not to damage the front panel paint with your tools.

Prepare the remaining encoder for VFO B as shown in Figure 43. Be sure the nut is tight against the shoulder of the ferrule. Cut only the five pins shown close to the back of the pc board so they do not extend above the solder pads. Cutting them avoids the possibility of a short circuit to an adjacent pc board when the K3 is assembled.

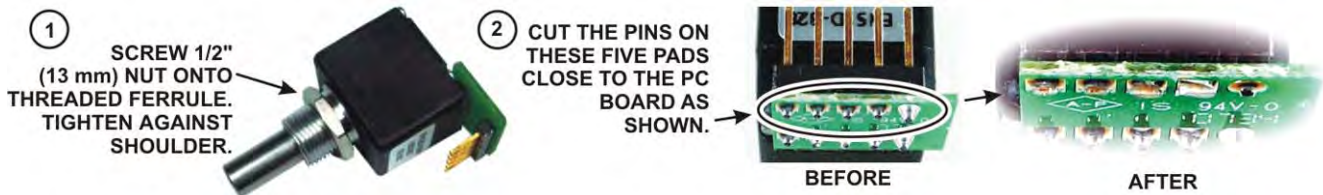


Figure 44. VFO B Encoder Assembly Preparation for Installation.

Place the VFO B encoder in the opening near the end of the front panel board so the nut rests against the inside of the front panel and the encoder pins mate with J34. The connectors may not mate fully, leaving a very small area of the pins showing. That is normal.

Place a 1/2" (13mm) inside tooth lock washer and nut on the threaded shaft of the VFO B encoder and tighten them against the front panel. Take care not to damage the front panel paint with your tools.

Place a second 1/2" (13mm) nut on the VFO A encoder shaft under the LCD and tighten it against the nut you installed earlier (see Figure 45).

Locate the clear plastic LCD display cover and VFO A trim panel. They may have an adhesive paper covering them for protection. If so remove it. If needed, wash the them in warm water with mild soap. To avoid etching or scratching the surface, do not use harsh detergents or wipe them with paper towels.

⚠ CAUTION!

In the following steps you will attach the plastic LCD cover and VFO A trim panels to the front cover using small screws. Use the screws specified in each step. Do not over-tighten these screws. Tighten the screws only to the point where you feel some resistance. It is very easy to strip the threads, especially the screws holding the LCD cover. If you strip these threads the only remedy is to obtain a new front panel!

☐ Brush or blow any dust or lint away from the front panel area around the encoder shaft under the LCD, then mount the trim panel as shown in Figure 45, oriented so the beveled edges are away from the front panel. Use the 2-56 1/4" screws and the 4-40 5/16" screw found in the small envelope marked E850241 VFO A Bezel Screws Envelope. Tighten the screws only until they come into firm contact with the trim panel. (If you had already opened the envelope, be sure you are using the 1/4" (6.4 mm) screws and not the shorter 5/32" (4.0 mm) screws.) **Be careful not to over-tighten the screws or you may strip the threads or break the trim panel!**



Figure 45. Mounting VFO A Trim Panel.

☐ Locate the clear plastic LCD cover and four 2-56 5/32" (4.0 mm) black pan head screws. These screws are in the small envelope marked E850340 LCD Bezel Screws Envelope 2-56 5/32 Blk Ox PH+(700149) or (SS). **Be sure you are using 5/32" (4.0 mm) screws to install the cover in the following steps. Longer screws may extend through the front panel and break the glass front of the LCD!**

☐ Check the LCD cover screw holes by sliding a 2/56 screw through them to be sure they are clear of any bits of plastic that might interfere with the screws. The screws should slide easily through the holes. Pushing them back and forth through the holes should loosen the fit if they are tight. When finished, ensure the LCD cover is free of dust, smudges and fingerprints.

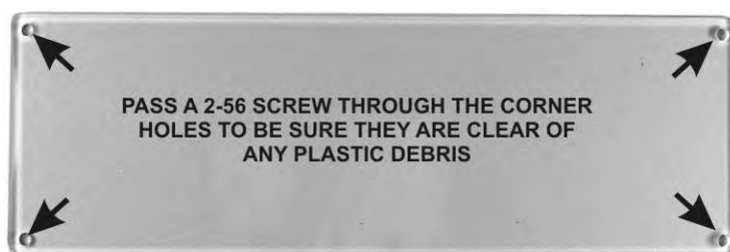


Figure 46. Checking LCD Cover Screw Holes.

□ Mount the cover on the front panel over the LCD as shown in Figure 47 oriented so the beveled edges are away from the panel. If the cover seems to bind against the VFO A trim panel, rotate it so the long edge striking the trim panel is at the top and, if necessary, work the screws through the holes in the plastic cover some more to loosen the fit. Tighten the screws only until they come into firm contact with the trim panel. **Be sure you are using screws no longer than 5/32" (4.0 mm) (SS), and do not thread the screws through the front panel without the cover in place to avoid the screws breaking the glass front of the LCD.**


DO NOT OVER-TIGHTEN THE SCREWS! DOING SO MAY STRIP THE THREADS AND RUIN THE FRONT PANEL OR BREAK THE LCD COVER.



Figure 47. Installing LCD Cover.

□ Place the larger of a pair of concentric knobs over the RF/SQL - SUB control as follows (See Figure 48):

 **CAUTION!**

Do not over-tighten the set screws in the knobs in the following steps or you may crack the knobs! Use only enough torque to hold the knobs in place.

- Turn both shafts fully clockwise
- Place the larger knob over the shafts. Do not tighten the set screw yet.
- Place the smaller knob over the shaft, align its index line as shown in Figure 48 and tighten one set screw with a 0.050" Allen wrench.
- Rotate the larger knob so its index line is aligned with the index mark in the smaller knob, then lift it gently so it does not bind against the control bushing or the upper knob and tighten one set screw.
- Rotate both knobs about half way counter-clockwise and tighten the second set screw in each knob.
- Rotate the smaller and larger knobs over their entire range to see if moving one knob moves the other at any point in the rotation. If it does, loosen the set screws on the larger knob and move it slightly toward the panel until the knobs operate independently over their entire range of movement.

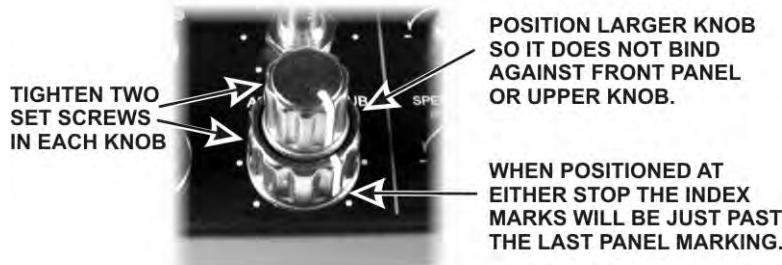


Figure 48. Mounting Concentric Knobs.

□ Place a pair of concentric knobs over the AF-SUB controls in the same manner as you installed the RF/SQL-SUB knobs. Don't forget to start by turning both shafts fully clockwise.

⚠ CAUTION!

You may damage the encoders while installing the knobs in the next step unless you align the flats in the knobs with the flats on the shafts as described below.

☐ Press small knobs on the four controls under the left end of the LCD: SHIFT/LOW, HI/WIDTH, SPEED/MIC and CMP/PWR. These knobs are all the same size and are held in place by a friction spring as shown in Figure 49. Align the flat in the knob with the flat on each shaft before pressing each knob in place. In addition to the rotating encoder, each knob has a switch that is actuated by pressing the knob toward the panel. You will feel the switch action when you press each knob onto the shaft.

⚠ If a knob feels very loose, check to see if the metal friction spring insert is in place as shown below. If not it should be in the bag with the knobs. Slide the spring insert into the knob and place it on the shaft. Friction will hold it and the knob securely once it is mounted.

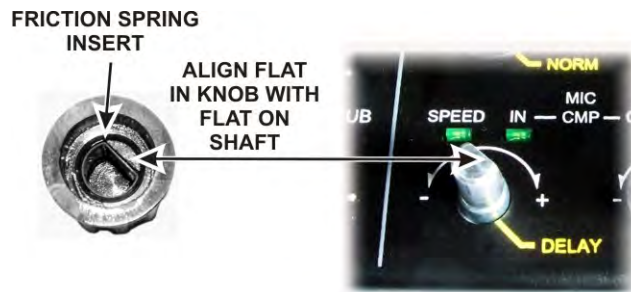


Figure 49. Mounting Friction Knobs.

☐ In the same manner, mount the slightly larger friction knob onto the RIT/XIT control in the lower right corner of the front panel. The RIT/XIT control does not have the switch action of the other four encoders.

☐ Mount the large knob on the VFO A encoder shaft below the LCD as shown in Figure 50. Adjust the position of the knob against the felt washer to produce the desired amount of drag for smooth movement without the knob turning too freely. Setting the panel face up and then placing the knob on the shaft so its weight determines the pressure against the felt usually produces a satisfactory amount of friction. If you want to make further adjustment and find it too sensitive, try a second felt washer under the knob. An extra felt washer is included in the kit for this purpose. You can do this after assembly is completed. The finger grip slides off to provide access to the set screw.



Figure 50. Mounting the VFO A Tuning Knob.

Mount the last knob on the VFO B encoder shaft to the right (under the pushbutton switches) as shown in Figure 51. Before tightening both set screws, adjust the position of the knob against the felt washer to produce the desired amount of drag for smooth movement without the knob turning too freely.

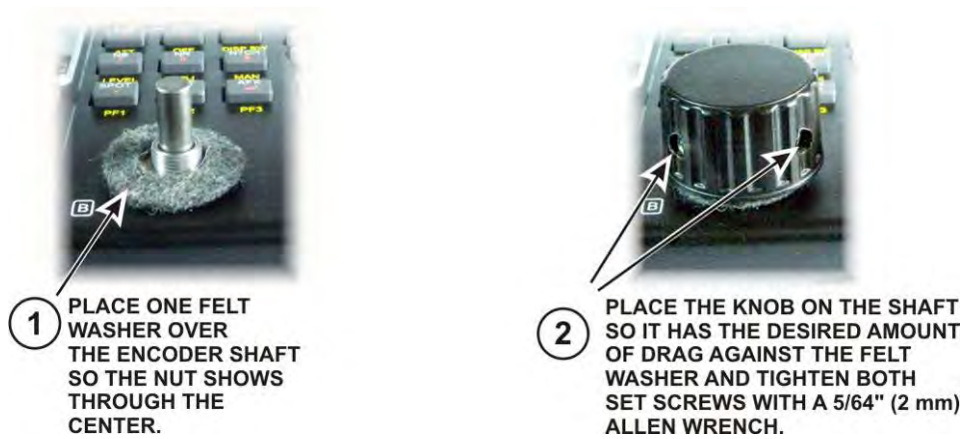


Figure 51. Mounting the VFO B Knob.

Mounting the Subreceiver Auxiliary DSP Board

If you purchased the optional KRX3 Subreceiver with your K3, install the KXR3 auxiliary DSP board as follows. If you did not purchase the KRX3, go to *Installing the KDVR3 Digital Voice Recorder Option* on page 41 if you purchased the KDVR3 Digital Voice Recorder Option with your K3. If you do not have the KDVR3, go directly to *Mounting the DSP Board Assembly on the Front Panel* on page 42.

The parts called for in the following procedure are included in the KRX3 Subreceiver kit. Install only the Auxiliary DSP board as described in the following steps. You will complete the KRX3 installation after the basic K3 is assembled, calibrated and tested.

If your KRX3 kit was supplied with 1/4" (6.4mm) long nylon screws, skip this step. If you have 1/2" (13mm) nylon screws, cut all three of them to length as follows:

- Screw three 4-40 nuts onto the 1/2" (13 mm) 4-40 nylon screw as shown in Figure 52.
- Cut off the nylon screw flush with the last nut. Sharp diagonal cutters or a knife will cut the nylon.
- After cutting, remove all three nuts. (The nuts establish the correct length for the screw and "clean up" the thread where you cut the screw.)

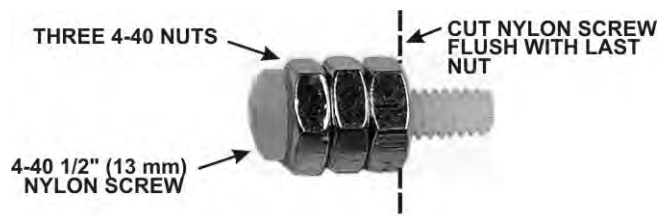


Figure 52. Preparing the Nylon Screw.

□ Mount the three 7/16" (11mm) male/female standoffs on the component side of the *main* DSP board as shown in Figure 53 using 4-40 nuts and #4 split lock washers. Be sure that:

- The standoffs are on the component side of the board as shown.
- No lock washer is used between the standoff and the board.
- One split lock washer is used between the nut and the board.

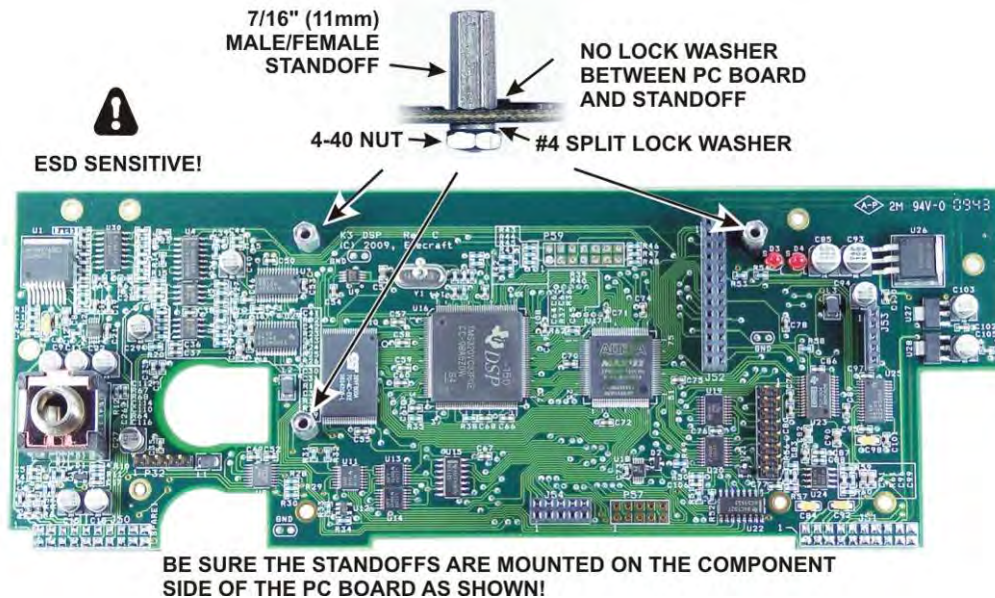


Figure 53. Installing Standoffs on the Main DSP Board.

□ Plug the aux DSP board into the main DSP board by mating P52 and P53 on the aux DSP board (at the narrow end) with J52 and J53 on the main DSP board. When fully seated, the connectors should be fully engaged so that the pins do not show and the aux DSP board should rest against the top of the standoffs with the holes in the board aligned for the screws (See Figure 54). Note that a two-row 10-pin connector at the top of the aux DSP board does not mate with anything on the main DSP board. That is normal. Attach the boards with three 4-40 1/4" (6.4 mm) *nylon* screws or the nylon screws you trimmed to length earlier (see Figure 52). Place a split lock washer under each screw head. Do not place washers between the standoff and the pc board. **Be careful tightening the nylon screws. They are easily stripped!**

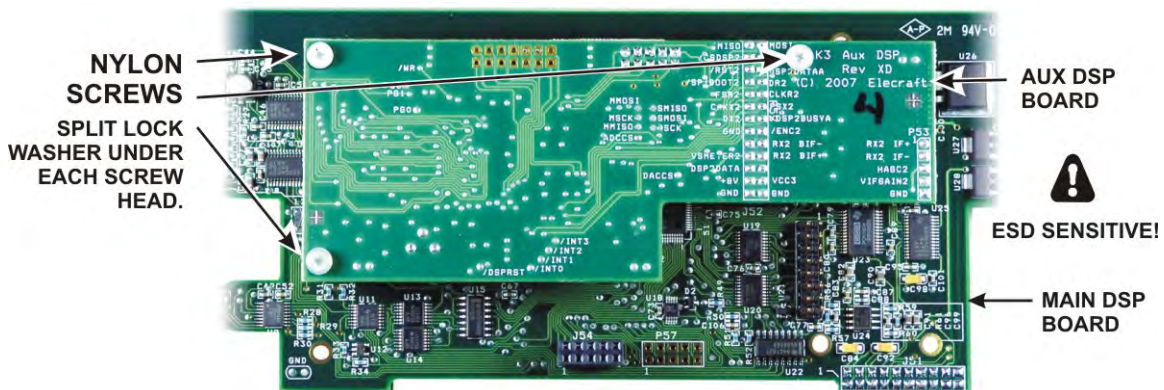


Figure 54. Mating the Main and Auxiliary DSP Boards.

☐ Locate resistor R3 on the front panel board (mounted on the front panel). If R3 is positioned above the board on its leads as shown in Figure 55, push it over to one side of the outline as shown. Be sure you don't push it so far its leads might touch the solder pads for other components on the board.

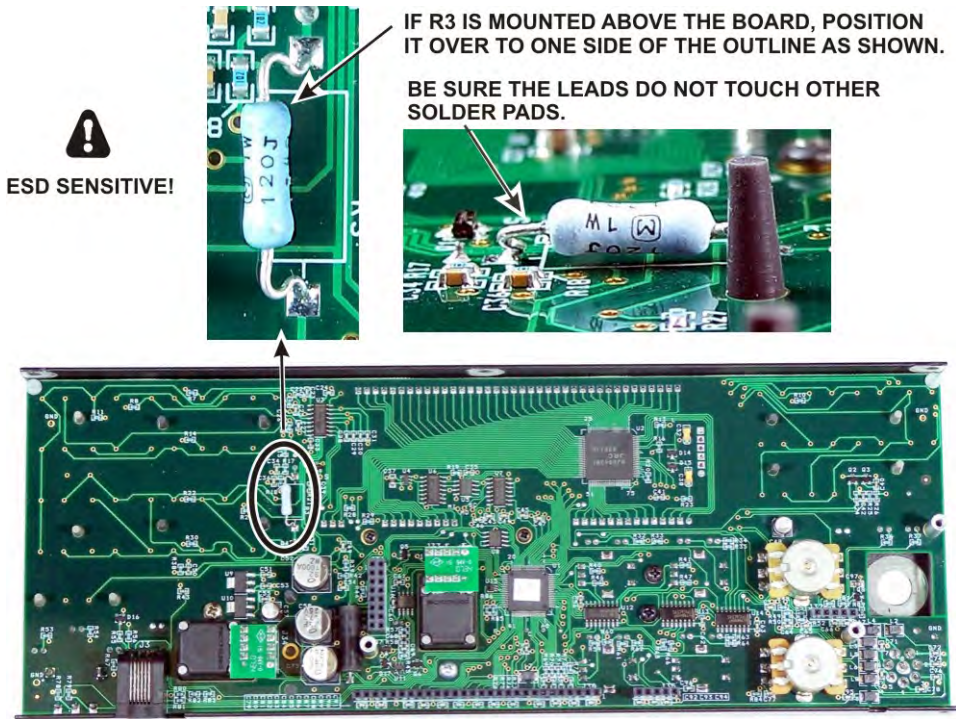


Figure 55. Positioning R3 on the Front Panel Board.

Installing the KDVR3 Digital Voice Recorder Option

☐ If you have the KDVR3, install it on the main DSP board as shown in Figure 56. The required hardware is included in your KDVR3 kit. If you did not purchase the KDVR3, skip this step and continue with *Mounting the DSP Board Assembly on the Front Panel* on 42.

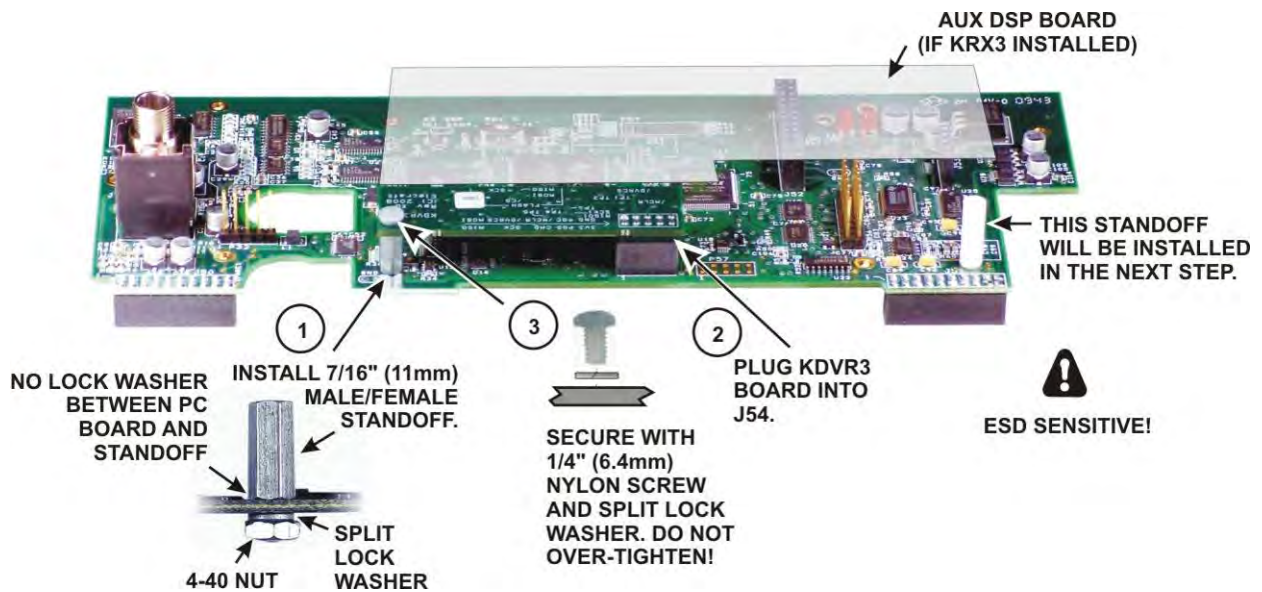


Figure 56. Installing the KDVR3 Board.

Mounting the DSP Board Assembly on the Front Panel

Locate the main DSP board and install the nylon standoff near J51 as shown below. Be sure you place it in the correct hole near the edge of the board. The standoff is also shown in Figure 56.

⚠ CAUTION: To avoid damaging a circuit trace very close to the metal ring around the screw hole, position the lock washer under the screw so the split faces away from the trace. Tighten the hardware by turning the standoff while holding the screw and lock washer stationary. *Do not over-tighten the screw. It is easy to strip the threads in the nylon standoff.*

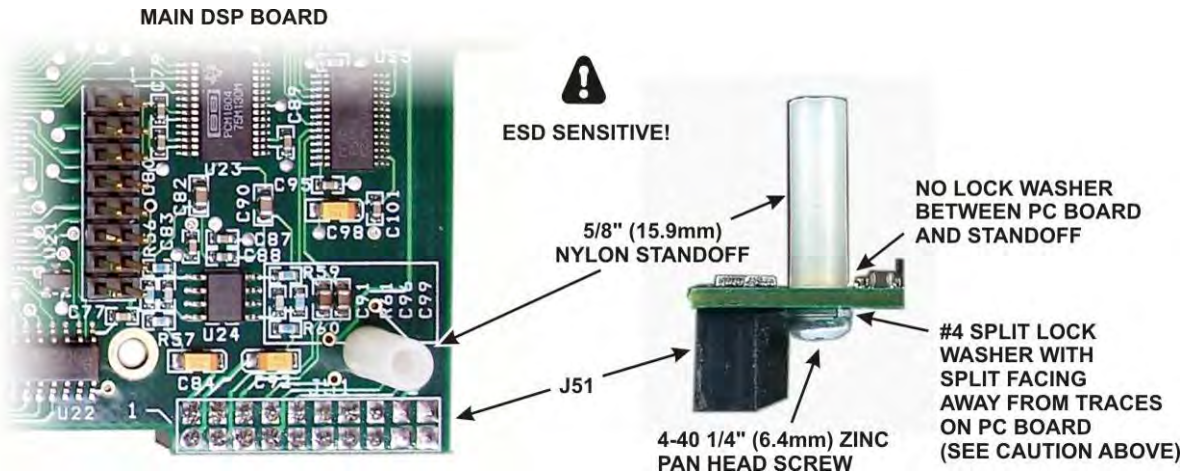


Figure 57. Installing the Nylon Standoff.

Place the front panel assembly face down on a soft, clean surface to protect the finish. The back side of the front panel board should be facing upward.

Position the large flat washer on the inside of the front panel over the PHONES jack hole (see Figure 60 on page 44). This is easily done by sliding the washer into place from the end of the front panel.

Gently position the DSP board on the front panel board so that the large jack fits through the cutout in the front panel board with the threaded section passing through the large flat washer and the circular opening in the front panel. Adjust the position of the board as needed so you can see the standoffs on the front panel board lined up with the screw holes in the DSP board.

Pick up the assembly while holding the DSP board in place and inspect the position of the two male plugs on the DSP board. They should mate with J31 and J32 on the front panel board. J31 is near the encoder for VFO A and J32 is between the two dual potentiometers. Adjust the DSP board's position as needed so the pins enter the corresponding holes in the sockets on the front panel board.

⚠ Use a strong light to look between the boards to be sure the connectors are properly mated. Be especially careful to check the connector near the dual potentiometers. Be sure the pins are entering the socket and not resting alongside it.

□ Squeeze the boards together while ensuring the pins are mating with the connectors until the DSP board is resting against the three standoffs on the back of the front panel board that you installed earlier. The two connectors will not mate completely. About 1/4" (6.4mm) of the pins may be visible when the DSP board is positioned against the standoffs. There are other connectors on the DSP board as well, but the two that mate with J31 and J32 are the only ones that connect between the front panel and DSP boards.

□ If you installed the Auxiliary DSP board for the KRX3 and adjusted the position of resistor R3 as shown in Figure 55, look between the DSP boards and the front panel board to verify that the leads are not touching any terminals on either the aux DSP or front panel boards (see Figure 58). If necessary, unplug the DSP board assembly and adjust the position of R3 to ensure the leads are clear of other solder pads before proceeding.

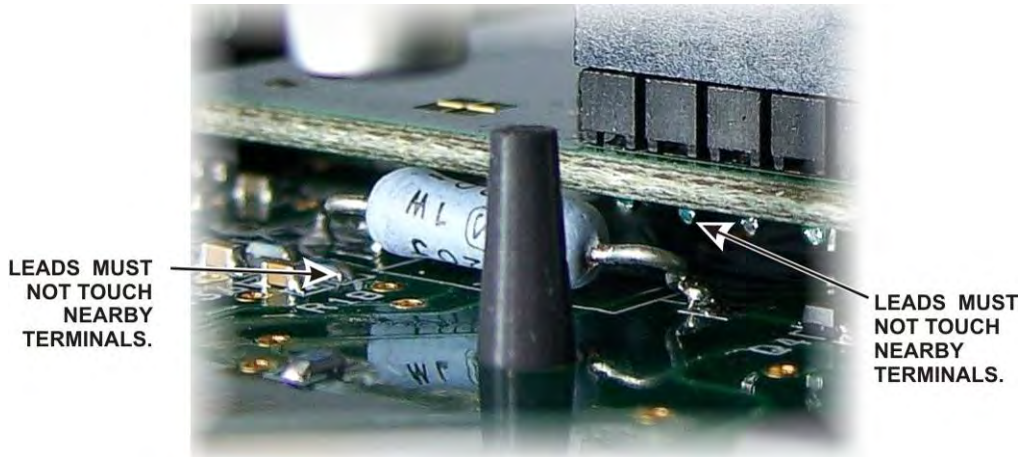


Figure 58. Checking the Position of R3.

□ Secure the DSP board to the front panel board with three 4-40 1/4" (6.2 mm) zinc pan head screws and split lock washers as shown in Figure 59.

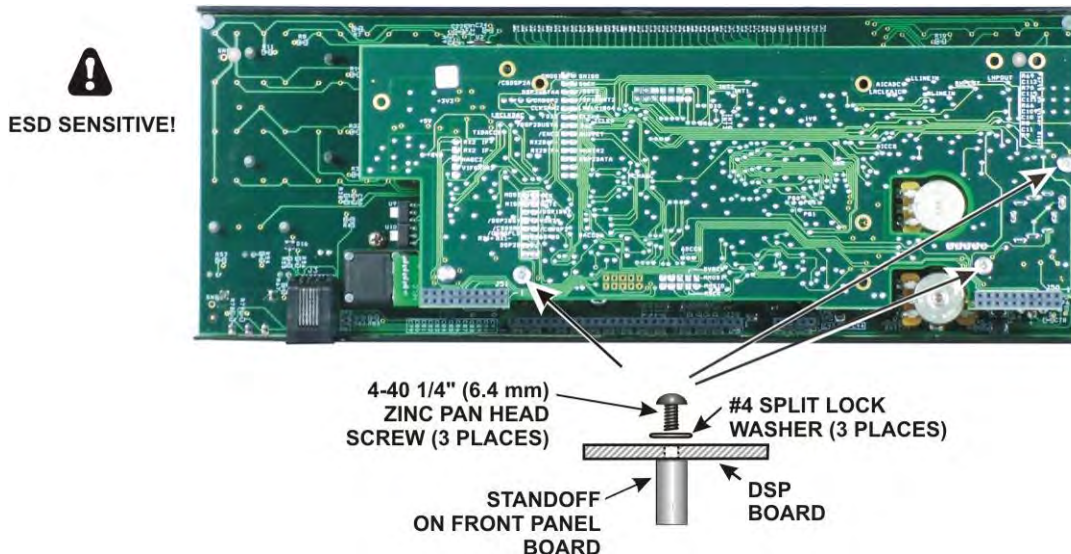


Figure 59. Mounting the DSP Board.

Screw the knurled nut onto the threaded shaft of the PHONES jack where it exits the front panel (see Figure 60). Screw it only finger tight. Do not use pliers.

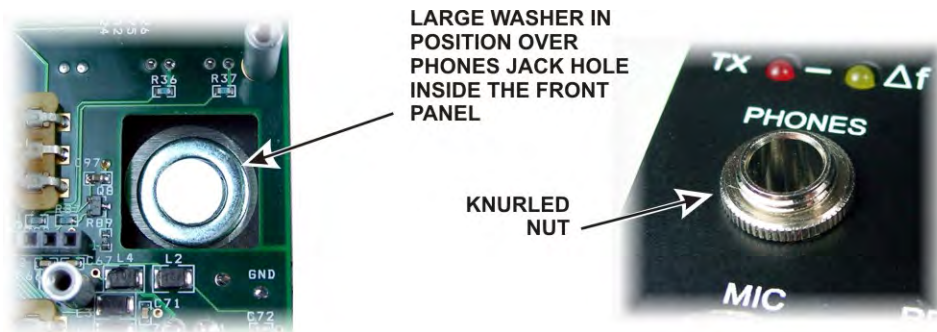


Figure 60. Phones Jack Hardware.

Mounting the Front Panel Assembly

Remove both side panels from the chassis as follows. This will allow you to see the connectors that must mate properly when attaching the front panel assembly.

- Remove the two screws shown in Figure 61 so the 2D connector and standoff remain attached to the side panel. Remove the remaining screws in the right side panel to free it.
- Remove all of the screws in the left side panel (except the two screws holding the handle assembly) to free it.

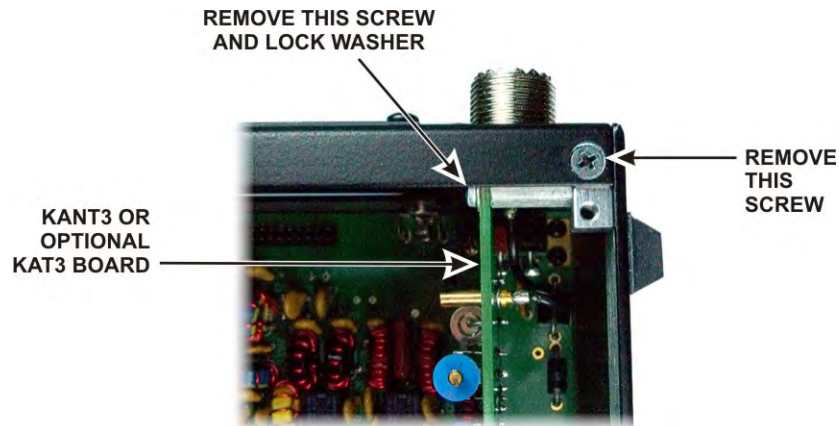
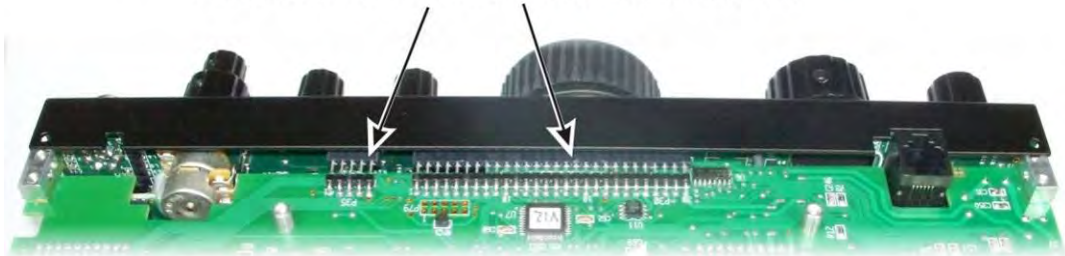


Figure 61. Removing Right Side Panel Hardware.

⚠ ESD SENSITIVE: Wear a grounded wrist strap or touch an unpainted metal ground before handling the RF Board in the following steps.

- Turn the chassis upside down and position the front panel so the pins of P30 and P35 on the bottom of the RF board just begin to engage the connectors on the lower edge of the front panel assembly. Do not fully mate them yet.

POSITION THE FRONT PANEL ASSEMBLY SO THESE CONNECTORS BEGIN TO ENGAGE, BUT DO NOT TRY TO MATE THEM FULLY YET.



BOTTOM VIEW

Figure 62. Mounting Front Panel Assembly - Connectors P30 and P35.

- Look at the two multi-pin connectors on the top of the RF board to see if they are engaging the corresponding connectors on the front panel assembly (see Figure 63). Adjust the position of the RF board or the front panel assembly to ensure they are mating properly.

ADJUST POSITION OF FRONT PANEL AND RF BOARD SO THE PINS OF BOTH CONNECTORS ENGAGE

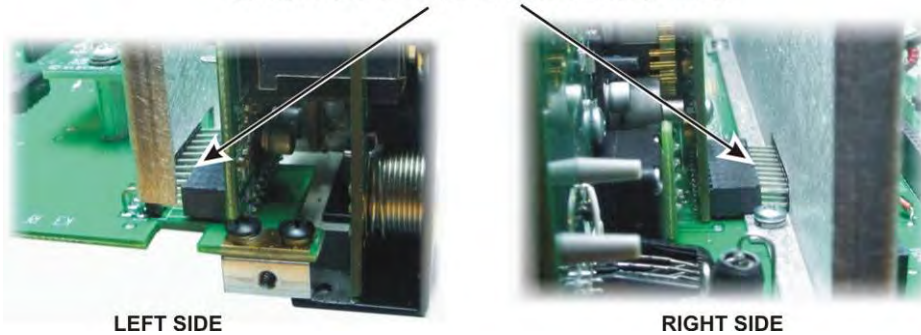


Figure 63. Mounting Front Panel Assembly - Connectors P50 and P51.

- With the pins of all four connectors started, press the front panel onto the RF board connectors. Press only from the bottom of the front panel to avoid flexing the RF board. You can use your fingers to press on the back side of each multi-pin connector on the top of the RF board while holding the front panel to engage them. There may be small areas of pins showing even after they are mated. You will know they are properly mated when the screw holes on the bottom lip of the front panel assembly line up with the screw holes in the 2D fasteners on the bottom of the RF board.

⚠ REMOVING THE FRONT PANEL: If you need to remove the front panel assembly, remove the five screws holding it to the chassis (three on the top lip and two on the bottom), turn the unit upside down and use a screwdriver in the two pry slots provided as shown in Figure 64. Do not insert the screwdriver deep enough to strike components on the boards! Pry each end in short increments until the connectors separate. Either a blade (as shown) or Phillips screwdriver may be used. Note that you may need to remove the left side panel and the 2D mounting screw shown in Figure 63.



Figure 64. Removing the Front Panel.

- Secure the front panel assembly at the bottom lip to the 2D fasteners at the forward edge of the RF board with two 4-40 3/16" (4.8 mm) black pan head screws (SS).
- Replace the right side panel (the panel with the feet) as follows:
 - Start four 4-40 3/16" (4.8 mm) black flat head screws (SS) through the side panel: three along the bottom and one at the front top. Make the threads have engaged, but do not tighten them yet.
 - Start one 4-40 3/16" (4.8 mm) black flat head screw (SS) through the rear panel into the 2D fastener shown in Figure 61.
 - Start one 4-40 3/16" (4.8 mm) black flat head screw (SS) at the top right corner of the front panel assembly, nearest the side panel.
 - Tighten all six screws
 - Replace the 4-40 1/4" (6.4mm) zinc pan head screw holding the KANT3 (or KAT3) board shown in Figure 61.

Attach voltage regulators U13 and U12 to the right side panel as shown in Figure 65 using a 4-40 3/8" (9.5 mm) black flat head screw (SS), #4 inside tooth lock washer and a #4 nut for each regulator as shown. When the screws are tightened the tabs on U12 and U13 should lie flat against the side panel.

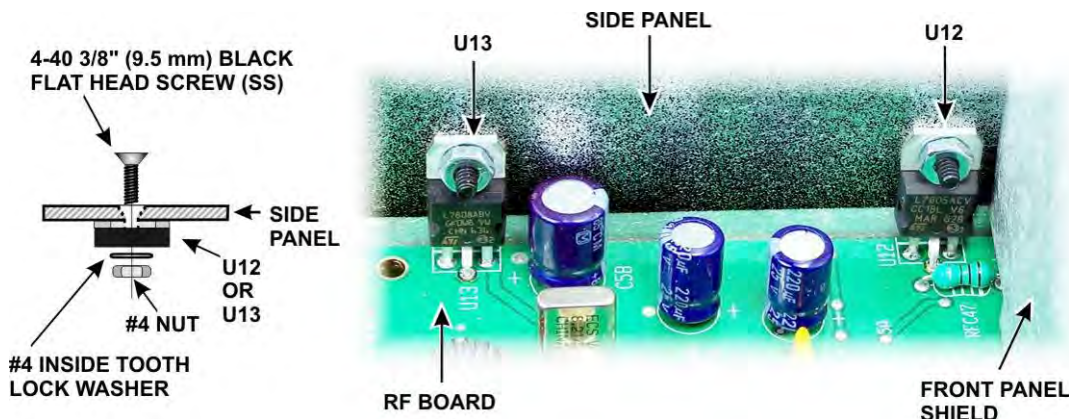


Figure 65. Attaching U12 and U13 to the Right Side Panel.

If you are installing the K3EXREF option, refer to the *K3 K3EXREF Frequency Lock Option* manual and install the coaxial cable as shown in Figures 3, 4 and 5 on pages 7 and 8. Note that in your kit the K3's bottom cover and KREF3 board are not yet installed. They will be added later.

Replace the left side panel (with the handle) as follows:

- Start the six 4-40 3/16" (4.8 mm) black flat head screws (SS) through the panel: three along the bottom, one at the top rear, one at the top front, and one just below the front end of the handle. It is normal to adjust the position of the panels slightly when assembling so the screw holes line up. The cabinet will become structurally sound and rigid with all the panels, including the top and bottom covers, are mounted.
- Start one 4-40 3/16" (4.8 mm) black flat head screw (SS) at the top corner of the front panel assembly.
- Inspect the area where the side panel meets the front panel shield, and make sure there is positive mechanical contact at the screw just below the end of the handle and about 3/4" (19 mm) above the RF board. The area of the side panel around that point is clean metal.
- Tighten all seven screws. ***Be sure all the screws are tight, including the screw near the forward end of the handle that threads into the front panel shield.***

⚠ CAUTION

Failure to establish a solid contact at that point may result in birdies in the receiver.

Fasten the top center of the front panel assembly to the front panel shield with a 4-40 3/16" (4.8 mm) black flat head screw (SS).

Resistance Checks

The following resistance checks confirm that the main power busses in the K3 aren't shorted to ground. If any of the values measured are lower than specified, inspect the unit carefully for loose hardware that is caught between components on the boards or for improperly mated connectors.

Use your digital multimeter (DMM) to measure the resistance across the red and black 12VDC IN connectors on the rear panel. The resistance should be greater than 3K ohms. It may be much higher, depending upon which way you connect the leads. Your DMM may indicate the value is so high it is out of the range of the instrument and as it does when in ohms mode and the probes are not touching anything. If you are not sure, refer to your DMM instruction manual to interpret the reading.

Use your DMM to measure the resistance between the end of R36 and ground at the exposed copper around the screws for the 2D fastener (see Figure 66). The resistance must be greater than 150 ohms.

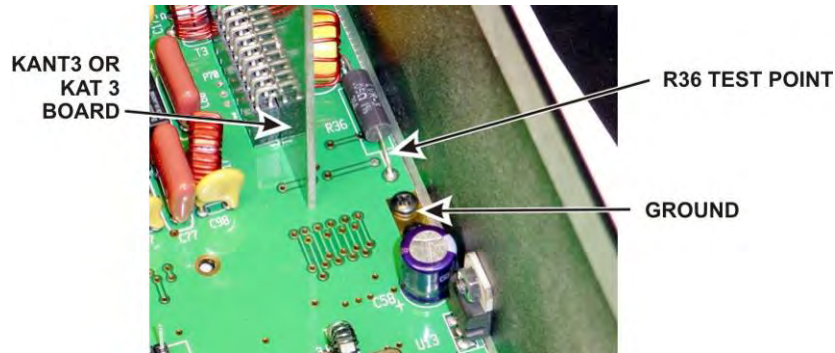


Figure 66. R36 Test Point.

Use your DMM to measure the resistance between the terminal on U12 and ground shown in Figure 67. The resistance must be greater than 500 ohms (although in some K3's it may be only slightly greater than 500 ohms).

Use your DMM to measure the resistance between the terminal on U13 and ground shown in Figure 67. The resistance must be greater than 125 ohms.

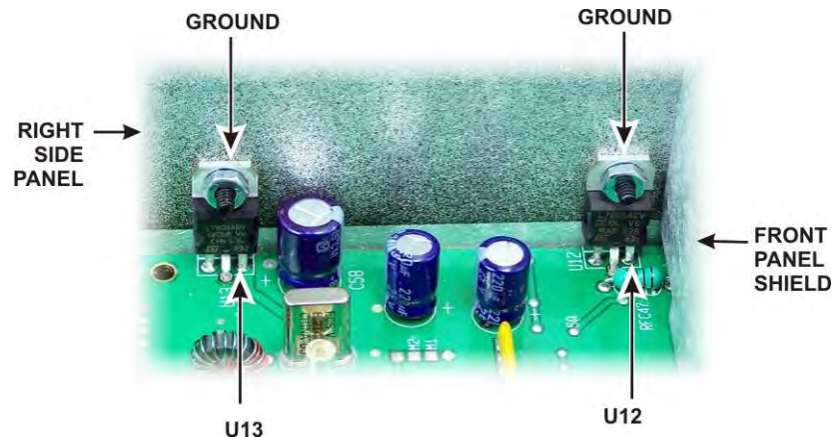


Figure 67. U12 and U13 Test Points.

Initial Power On Check

The following check confirms that the power supply and power control circuits are working properly. Be sure your K3 passes the resistance tests above before proceeding.

⚠ CAUTION!

If you see or smell smoke when applying power, turn the K3 off and remove the power cable immediately, then locate the source.

- Connect your 13.8 VDC power supply to the 12VDC IN connector on the rear panel. If you do not have a suitable cable handy, assemble the Power Supply Cable Kit supplied with your K3. Do not connect a key, microphone or other accessories to the K3 at this time.
- Tap (press for less than 1/2 second) the front panel **POWER** button and confirm the LCD display lights. There may be a delay of about 1 second before the display lights. Some front panel LEDs may light as well, and you may notice D33 on the RF board, next to the crystal filters, light. Ignore any error messages on the display and do not try to operate the radio at this time. You'll get to do that soon.
- Tap the front panel **POWER** button again to turn the K3 off and disconnect your external power supply.

KREF3 Reference Oscillator

KREF3 Description

The KREF3 module's 49.380-MHz temperature-compensated crystal oscillator (TCXO) is the common reference for the K3's synthesizers. See *Theory of Operation, KREF3*, in the K3 Owner's Manual for more information.

KREF3 Installation Procedure

- Locate the Temperature-Compensated Crystal Oscillator (TCXO) module. If you ordered the optional ± 1 ppm TCXO it will be supplied *instead* of the standard 5 ppm module (see Figure 68).
 - Note the position of a small colored dot on the top of the module. It is sometimes faint and may be hard to see without good light. The dot allows you to orient the module correctly in the socket. Some modules have four pins while others have only three. If your module has three pins, the missing pin is in the same corner as the painted dot.

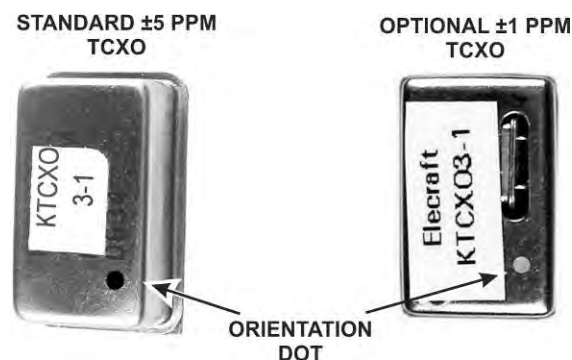


Figure 68. TCXO Modules.

- If you have the optional ± 1 ppm module, it is supplied with a thin flat insulator that fits over the pins to cover the bottom. Place the insulator over the pins. *This insulator is not used on the standard ± 5 ppm module.*

□ Mount the TCXO module on the KREF3 board as shown in Figure 69. Be certain the leads go into the corner holes in the socket and the black dot is oriented toward connector J6 as shown. If you have a 1ppm high-stability module, the dot may be light brown and not as close to the corner. If the module has only three leads, the missing lead will be in the corner with the dot. If you have the standard 5ppm TCXO, the bottom may be slightly above the socket when the leads are fully inserted. Tighten the tie wrap enough to ensure the oscillator so it cannot fall out but do not bend the leads.

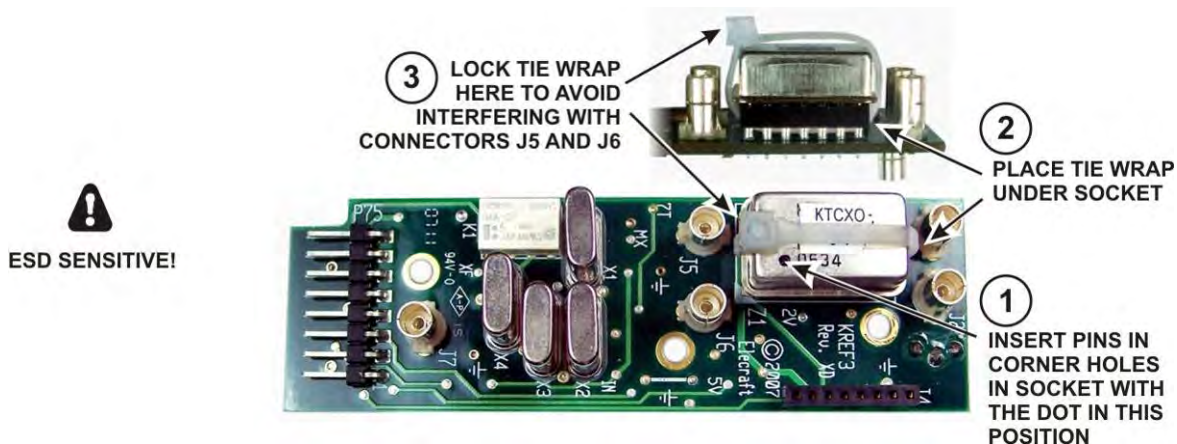


Figure 69. Mounting TCXO Module on KREF3 Board.

□ Inspect the bottom of the KREF3 to ensure no leads are higher than the chokes as shown below. The chokes are the highest of the black surface-mount components on the board. Use your diagonal cutters to trim any excessively long leads close to the board.

⚠ CAUTION

The objective is to be certain no bare leads touch the front panel shield when the board is installed in the next step. Do not add spacers or insulating material between the board and the front panel shield. It is important for proper shielding of the circuits that the board sit very close to the front panel shield.



Figure 70. Checking Lead Lengths on KREF3 Board.

□ If you are installing the K3EXREF option, mount the K3EXREF board on the KREF3 board as shown in the *K3 K3EXREF Frequency Lock Option* manual, Figures 8 and 9 (pages 9 and 10). Be sure to install the shorting block as shown in Figure 8. After the KREF3 board is in place, be sure to connect the TMP connector on the cable you installed earlier to the connector that passes through the front panel shield.

⚠ CAUTION

In the following step it is easy to drop screws and lock washers into the K3. If this happens, you must find and retrieve the hardware. Failing to do so may cause short circuits and damage your K3 when power is applied.

Recommend you practice installing the KREF3 board without the screw and washers first to acquaint yourself with the procedure for inserting it and fitting the connector through the hole in the front panel shield. You'll need to do this smoothly to avoid dropping the hardware.

Install the KREF3 board on the back side of the front panel shield as shown in Figure 71. The board plugs into J75 just behind the shield. **Be certain you use a split lock washer between the KREF3 board and the PEM nut attached to the shield. An inside tooth washer may short out nearby circuit traces.**

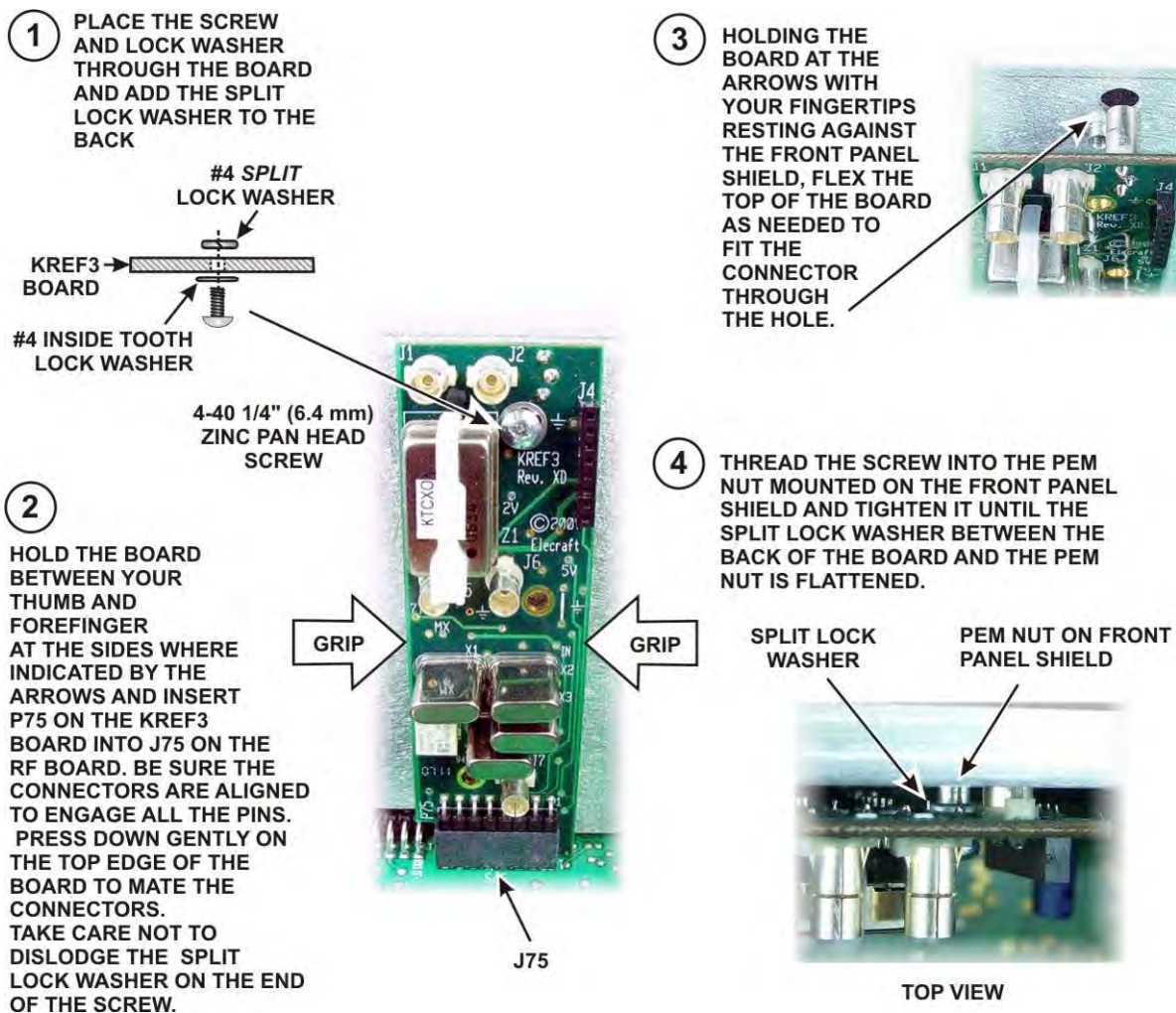


Figure 71. Installing KREF3 Board.

If you are installing the K3EXREF option, connect the TMP connector on the cable leading to the rear panel REF connector to the connector on the KREF3 board that passes through the front panel shield.

KSYN3 Synthesizer

KSYN3 Description

The KSYN3 module is a high-performance, wide-range synthesizer covering 8 to 46 MHz. It uses a crystal-filtered DDS (direct digital synthesis) reference. This in turn drives a VCO with a high C/L ratio, resulting in very low phase noise. See *Theory of Operation, KSYN3*, in the K3 Owner's Manual for more information. The KSYN3 is supplied with a stiff metal plate covering the front of the pc board. This plate keeps the board from vibrating, especially if the K3 is operated with its internal speaker at high volumes.

KSYN3 Installation Procedure

- Confirm that the screw, washer and nut are mounted on the bottom corner of the KSYN3 board as shown in Figure 72. Install them if they are not already. Note that the nut is on the side with the stiffener plate.

⚠ CAUTION

The hardware should be tightened only enough to begin to compress the lock washer. Over-tightening may compress the thin adhesive between the stiffener plate and the pc board, causing short circuits under the stiffener plate.



Figure 72 Stiffener Fastener on KSYN3 Board.

- Inspect the bottom of the KSYN3 board to ensure no leads are higher than the chokes as shown below. The chokes are the highest of the black surface-mount components on the board. Use your diagonal cutters to trim any excessively long leads close to the board.

⚠ CAUTION

The objective is to be certain no bare leads touch the front panel shield when the board is installed in the next step. Do not add spacers or insulating material between the board and the front panel shield. It is important for proper shielding of the circuits that the board sit very close to the front panel shield.

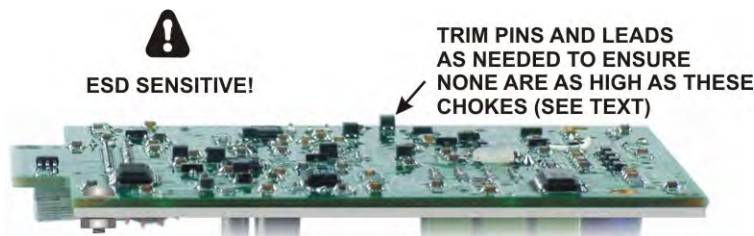


Figure 73. Checking Lead Lengths on KSYN3 Board.

⚠ CAUTION

In the following step it is easy to drop screws and lock washers into the K3. If this happens, you must find and retrieve the hardware. Failing to do so may cause short circuits and damage your K3 when power is applied.

□ Install the KSYN3 board on the back side of the front panel shield using the hardware exactly as shown in Figure 74. This is most easily done as follows:

- Place an inside tooth lock washer over each 1/2" (12 mm) pan head screw, then place the screw in the hole in the KSYN3 board.
- While holding the screws in place, add a split lock washer to each screw on the back side of the board. **Be sure you use split lock washers on the back of the board. Inside tooth lock washers may short out nearby circuit traces.**
- **Hold the board with the screws and washers in position by lightly pinching the corners of the board with your thumbs over the screw heads and index fingers holding the split lock washers in place on the back.**
- Position the board to mate P73 on with J73 on the RF board. Be sure you have the connectors properly aligned and mate them fully so the screws line up with the PEM nuts on the front panel shield.
- Thread each screw into the PEM nut on the front panel shield. Be sure the split lock washer is still in place between the board and the PEM nut.

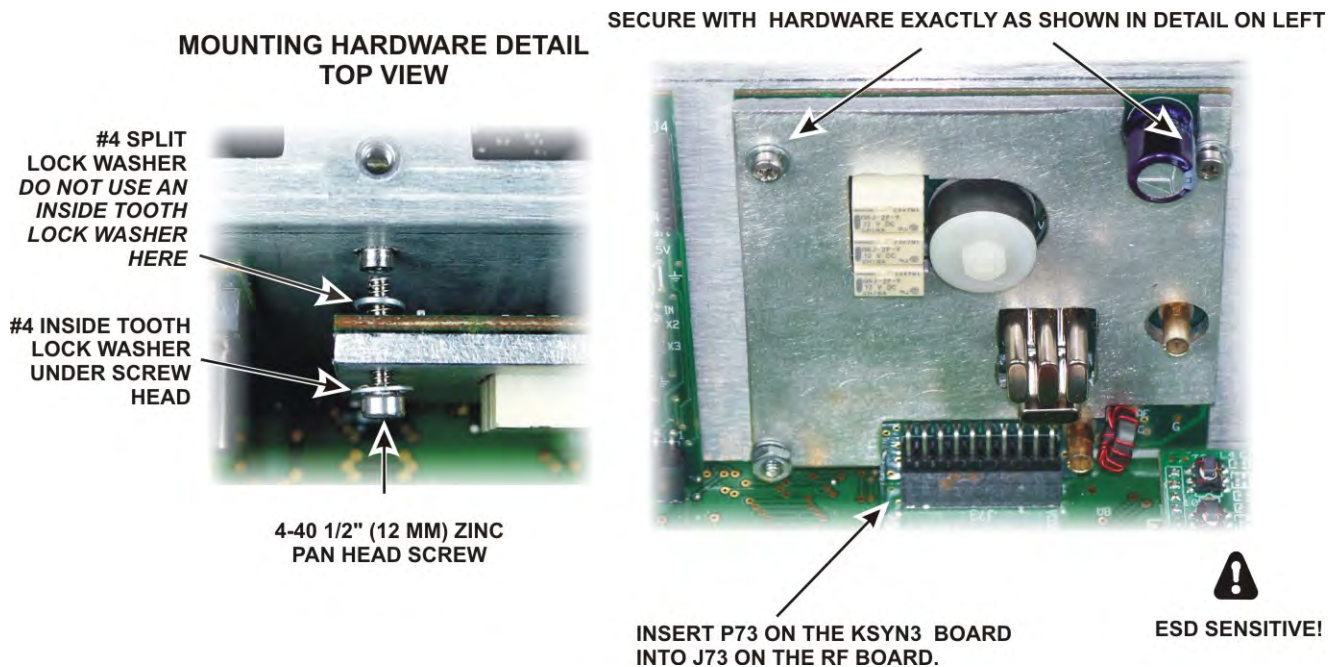


Figure 74. Installing the KSYN3 Board.

□ Locate the three TMP cables. They are about 1/8" (3 mm) diameter coaxial cables with connectors at each end as shown in Figure 75. Check each cable and trim any excess center conductor strands extending beyond the end of the pin as shown. This will make mating the connectors much easier.

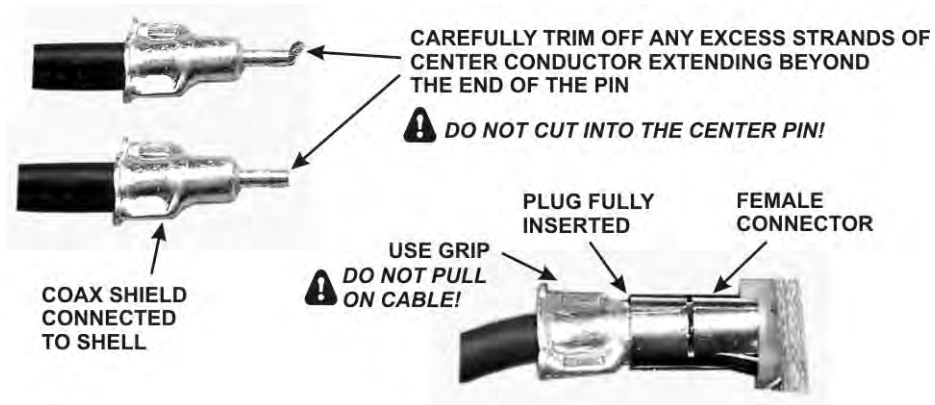


Figure 75. TMP Cable Connectors.

□ Install the three TMP cables between connectors on the KREF3 board, the main RF board and the KSYN3 board as follows. Handle the connectors by the finger-grip area shown in Figure 75, especially if you unplug a connector. **Do not pull on the coaxial cable to unplug a connector!** When mating the connectors, be sure the plugs are fully inserted as shown in Figure 75. To make the connectors easier to mate, first be sure the center pin is started in the socket, then you may twist the connector back and forth while holding it by the metal ears if needed to seat it fully as shown in Figure 75.

- KREF3 board J7 to RF board J65.
- KREF3 board J6 to RF board J81.
- KREF3 board J2 to KSYN3 board J83.

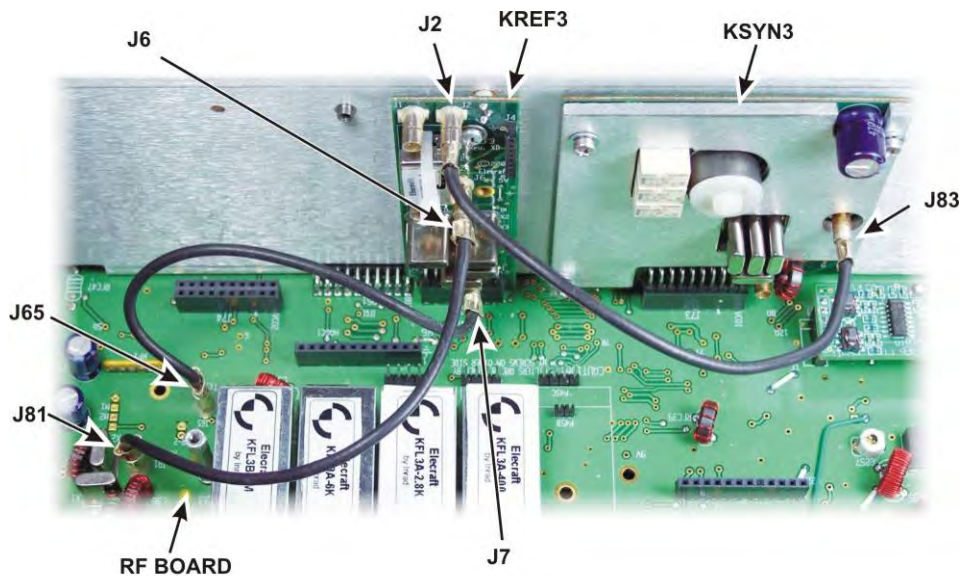


Figure 76. Installing KREF3 TMP Cables.

Loudspeaker

Loudspeaker Description

The built-in loudspeaker is mounted on the top cover. A grill cloth covering the sound holes keeps dust and debris from falling into the speaker cone. The loudspeaker is equipped with a magnetic shield to avoid unwanted interaction with nearby circuits.

Loudspeaker Installation Procedure

- Locate the top cover and check the inside for any masking tape still covering screw holes. If found, peel it off.
- Mount the chassis stiffening bracket on the underside of the cover as shown in Figure 77. Do not use washers.

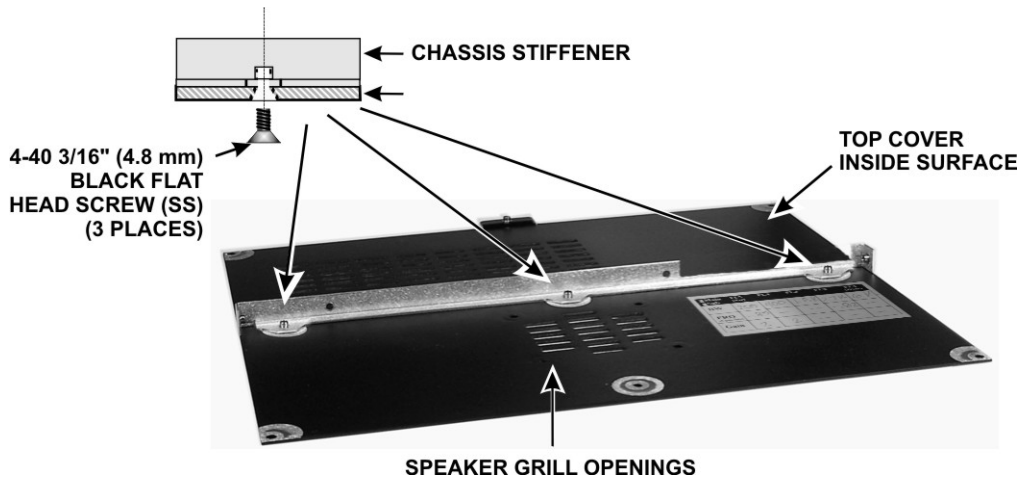


Figure 77. Attaching Chassis Stiffener to Top Cover.

- Trim the grill cloth to cover the speaker grill openings and overlap the four holes for the loudspeaker mounting screws. Mark and cut four holes in the grill cloth for screws to pass through the cloth. The grill cloth is shown as it must fit after the speaker is mounted in Figure 78. Normally, the stiffener will remain attached to the K3 when you remove the top cover. If you install the KPA3 100-watt amplifier, the stiffener will be attached to the KPA3 shield and cannot be removed with the cover (see Figure 82 on page 58). The grill cloth must be trimmed as shown so it cannot become trapped between the chassis stiffener and the top cover when the cover is removed and replaced.

⚠ CAUTION!

Failing to install the fiber washers as shown in the next step or over-tightening the screws so that the speaker mounting flanges are distorted may damage the speaker, causing distorted, fuzzy sound.

□ Mount the speaker using the hardware shown in Figure 78. A suggested procedure for doing this is as follows:

- Find a book or other flat-smooth surface that is about the size of the top cover.
- From the top, place the screws in the four holes at the corners of the speaker grill area.
- Cover the screw heads with the book and, holding it in place against the top cover, invert the cover and lay it with the book on your work table so the bottom side is facing upwards.
- Trim and cut screw holes in the grill cloth as needed and position it over the four screws that are now held in place by the book. Trim the grill cloth so the cloth does not touch the stiffener.
- Place a fiber washer on each screw so it rests on the grill cloth.
- Position the loudspeaker on the four screws so they pass through the holes in the flanges. Orient the speaker so the wire exits toward the rear (the side nearest the stiffener).
- Place a #4 internal tooth lock washer on each screw.
- Start a 4-40 nut on each screw.
- Pick up the entire assembly and tighten all four screws. ***Do not tighten the screws enough to bend the speaker flanges!***

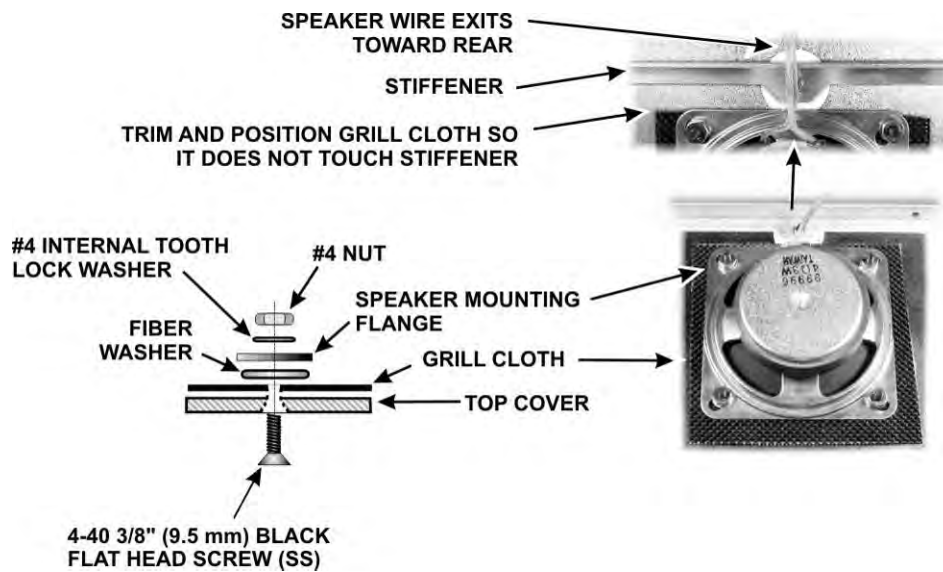


Figure 78. Mounting Loudspeaker.

Install the shield over the speaker magnet as shown in Figure 79.

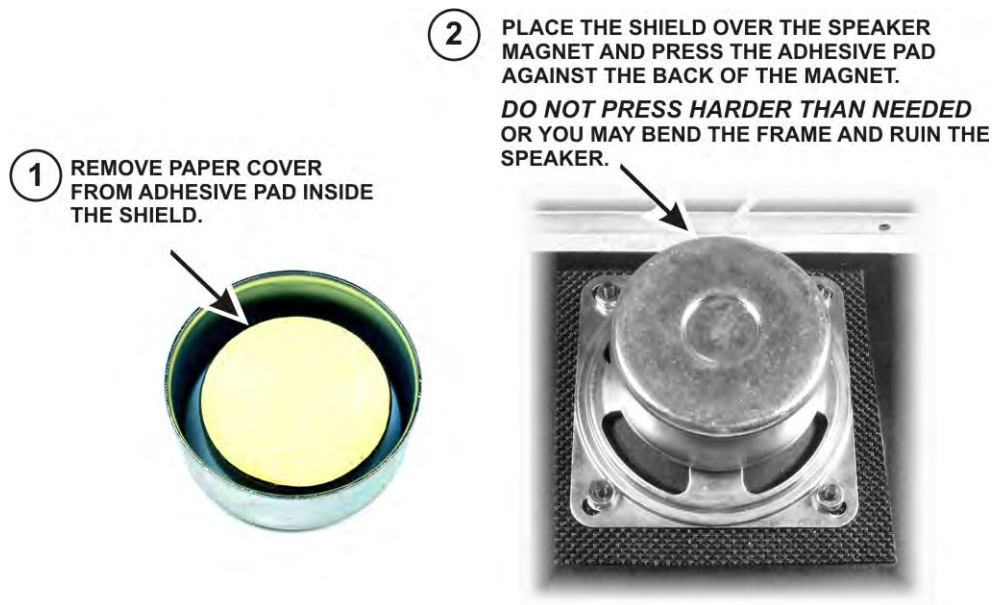


Figure 79. Installing Speaker Magnet Shield.

KPA3 Shield

If you are *not* planning to install the KPA3 module at this time, skip this section and go directly to *Bottom Cover* on page 59. Only the KPA3 shield is installed at this time to avoid rework later. You will be directed to finish installing the KPA3 module after initial testing and calibration of your K3.

KPA3 Shield Description

The KPA 3 Shield is part of the optional KPA3 100-watt amplifier module. It isolates the high-level RF circuits in the KPA3 from the rest of the K3 and provides mechanical support for the amplifier module itself.

KPA3 Shield Installation Procedure

Remove the shield from the KPA3 Option kit and position it over the holes in the RF board as shown in Figure 80. The holes in the shield must line up with the holes in the RF board.

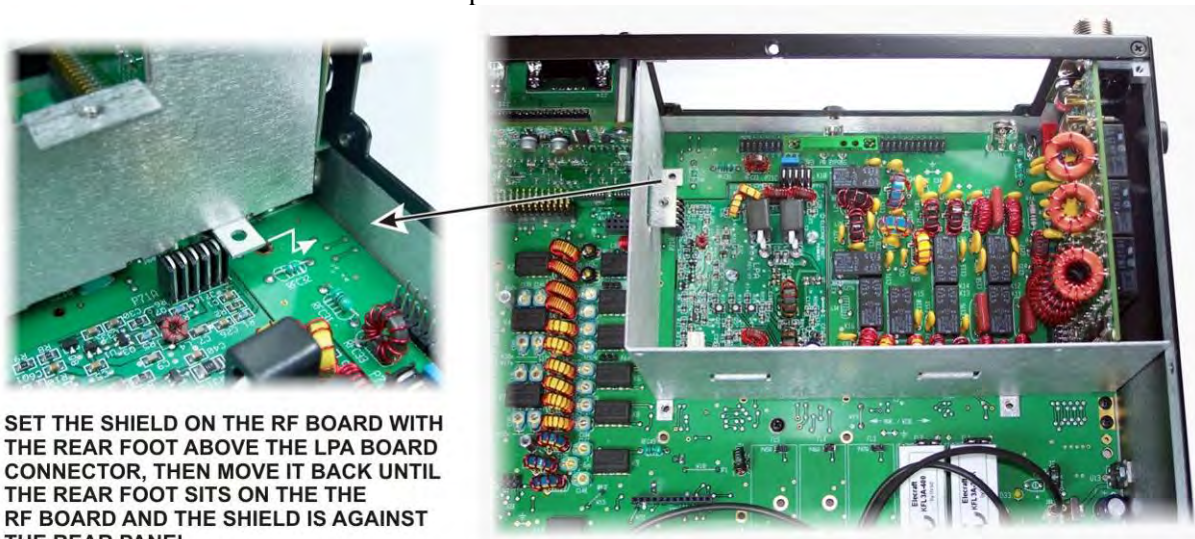


Figure 80. Positioning the KPA3 Shield.

Attach the shield to the RF board and to the rear panel as shown in Figure 81. The screws, washers and nut are in the KPA3 Option kit. The standoffs are part of the K3 kit hardware.

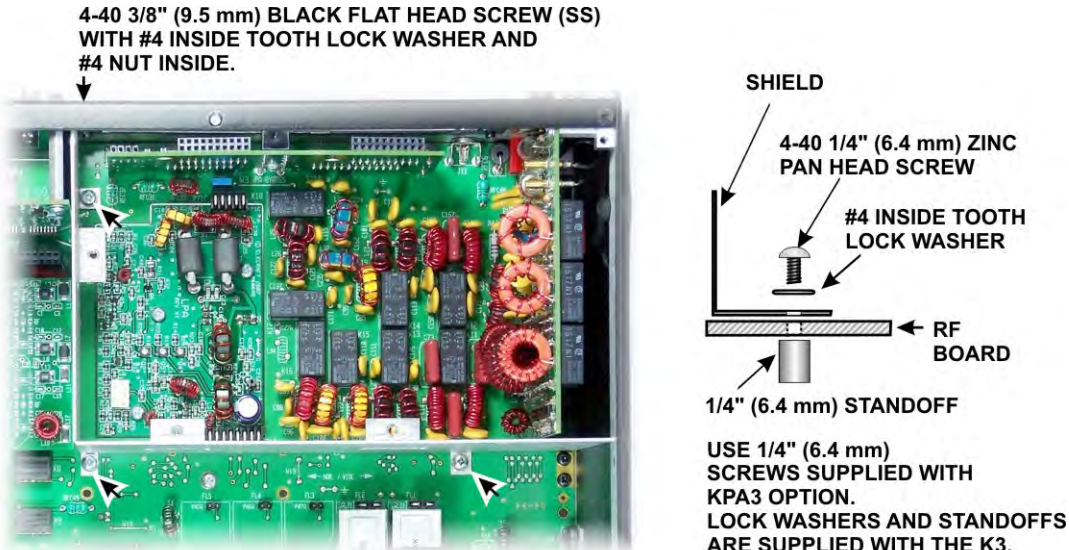


Figure 81. Attaching the KPA3 Shield.

Remove the stiffener bar from the top cover and install it on the chassis as shown in Figure 82. The hardware required to attach it to the shield are in the KPA3 Option kit. The black flat head screws used to attach it to the side panels are part of the K3 kit hardware.

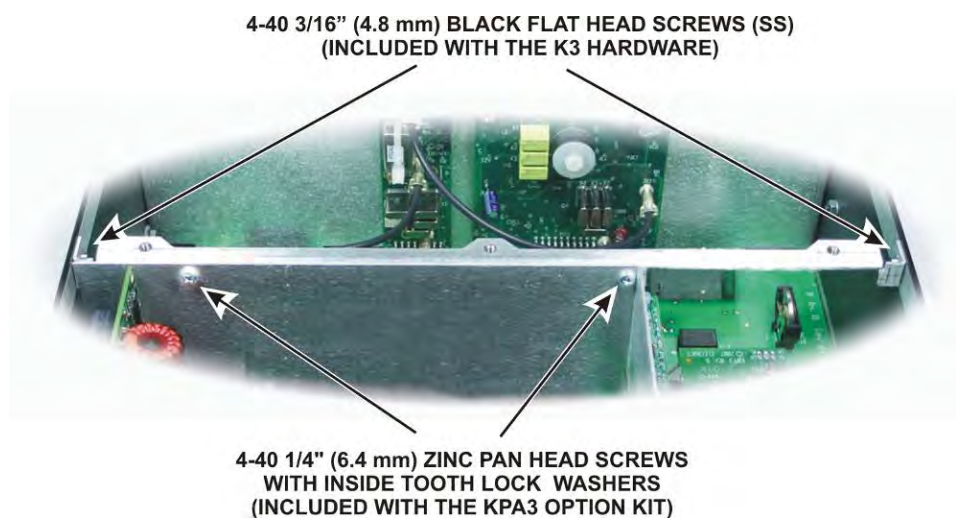


Figure 82. Installing the Chassis Stiffener Bar.

Bottom Cover

Bottom Cover Description

The bottom cover is divided into two parts, the rear and forward sections. The rear section is slightly thicker than the forward section to act more efficiently as a heat sink for the LPA transistors. The bottom covers attach to standoffs as well as the 2D fasteners on the bottom of the RF Board. A folding tilt stand and feet are mounted on the cover panels.

Bottom Cover Hardware Installation Procedure

Install the standoffs on the bottom of the RF board shown in Figure 83. If you installed the KPA3 shield, three of the four standoffs required are already in place. *If so, be sure to install the remaining standoff!*

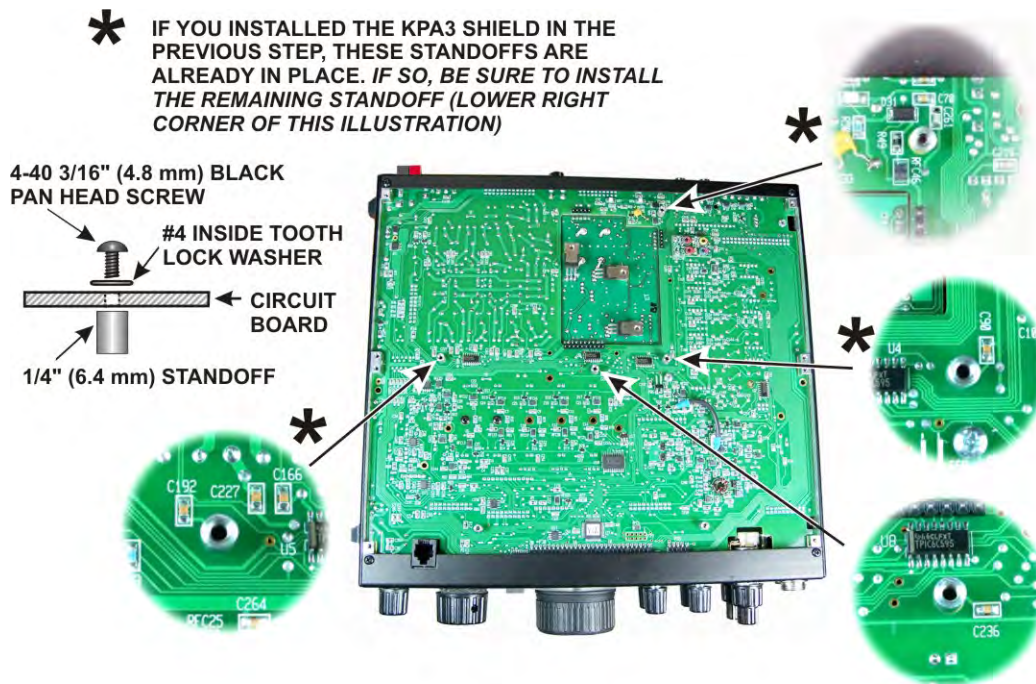


Figure 83. Installing Standoffs on RF Board.

- Identify the bottom cover forward section by test fitting it on the bottom of the K3. The forward section is the thinner panel with a notch along one edge (see Figure 84).
- One side of the cover is fully painted. That is the outside. The other side has areas of bare metal left to ensure good electrical contact with the other cabinet parts. Check the inside surface for any masking tape left from the painting process. If found, peel it off.
- Attach the front feet and tilt stand to bottom cover section A as follows. Insert a 4-40 7/16" (11 mm) zinc pan head screw (SS) through the cover *with the screw head on the inside*, and place a foot over the screw on the outside (fully painted) of the cover. Orient the foot as shown in Figure 84. Place a #4 lock washer (SS) and 4-40 nut (SS) on the end of the screw inside the hole in the foot, and put your finger over the hole to hold the nut against the screw. Turn the screw to start the nut onto the threads but do not tighten it. Repeat the procedure for the second screw in the foot. Leave the foot as loose as possible without the hardware falling off.
- Install the tilt stand and second foot as shown in Figure 84. You may need to press the foot against the tilt stand to get the 4-40 7/16" (11mm) screws (SS) to pass through the cover and foot. Put a #4 lock washer (SS) and nut (SS) on each screw as you did before.
- Tighten all four screws. It should not be necessary to put a tool on the nuts. Friction against the feet and the lock washers should hold them securely while you tighten them by turning the screw heads.

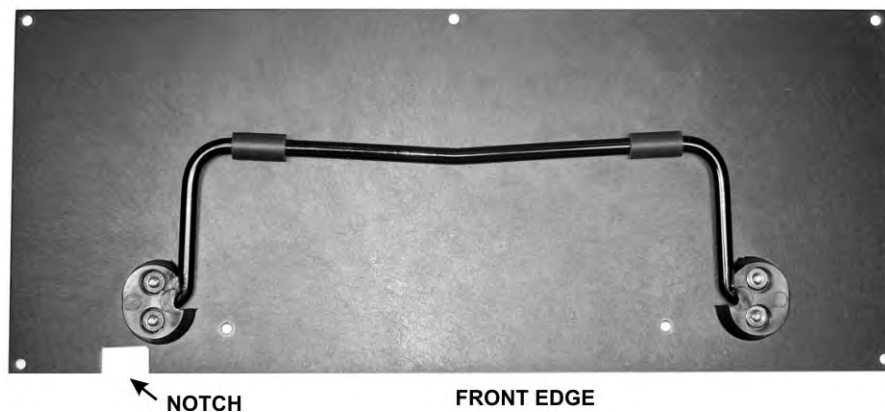
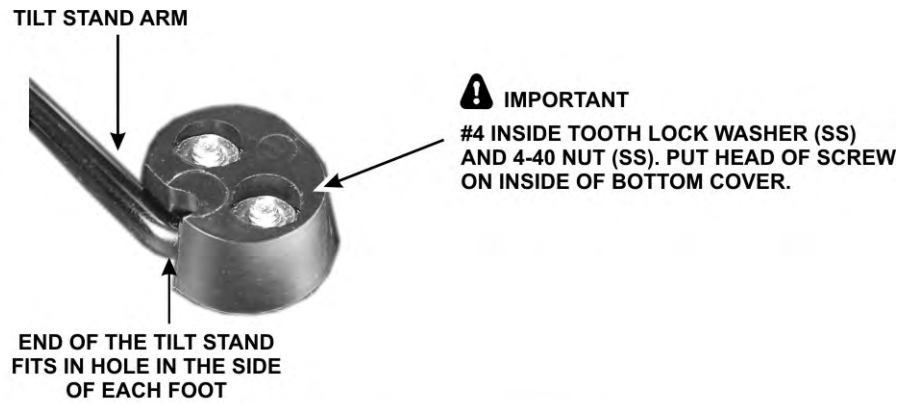


Figure 84. Installing Tilt Stand.

Locate the rear bottom cover section. This cover has eight rectangular slots cut in it. Like the front section, bare metal is exposed in some areas on the inside surface. The bare metal ensures good electrical contact with the other cabinet parts and good thermal contact with the heat sinks for Q2, Q4 and Q5 on the LPA circuit board.

Check the inside surface of the bottom cover for any masking tape that may have been left from the painting process. If found, peel it off. Two of the screw holes inside bottom cover section B have *not* had the paint removed from them. These are the mounting holes for the two rear feet. Attach each foot as shown in Figure 85. Note that these screws are also installed with their heads on the inside surface.

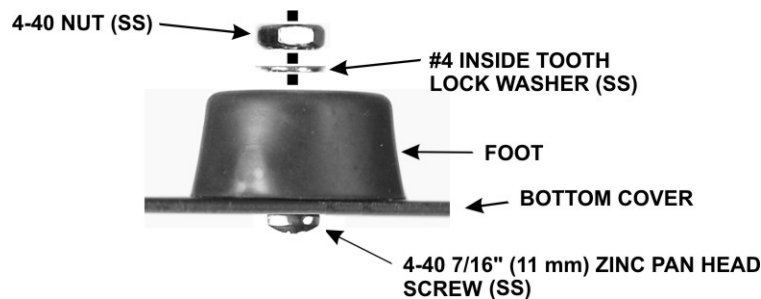


Figure 85. Installing Rear Feet.

Set both bottom covers aside in a safe place. They will be mounted on the K3 later.

KNB3 Noise Blanker Description

The KNB3 is one of two noise blanker systems in the K3. It is a narrow I.F. pulse blanker that plugs into the RF board. See *Theory of Operation, Noise Blanker* in the K3 Owner's Manual for more information

KNB3 Installation Procedure

Install the standoff for the noise blanker as shown in Figure 86. The location of J77 is to the left of crystal filter position FL5 on the RF board. Be sure to put *two* split lock washers between the standoff and the RF board as shown.

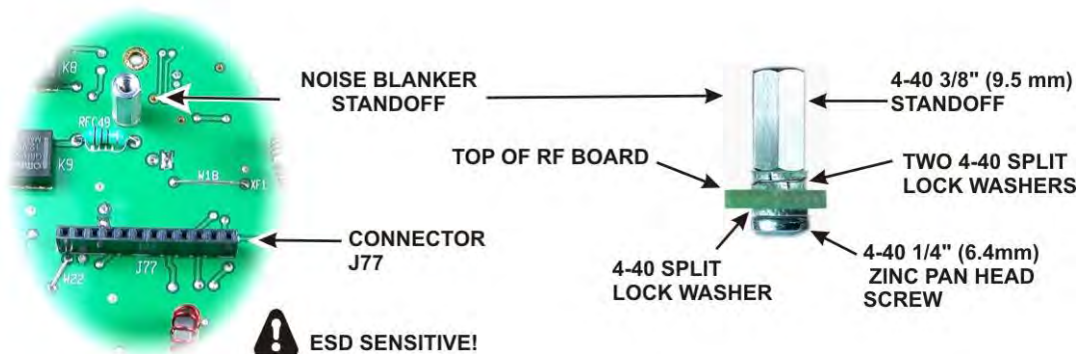


Figure 86. Installing Noise Blanker Standoff.

- Plug the noise blanker board into J77 and attach it to the standoff using the hardware shown in Figure 87.

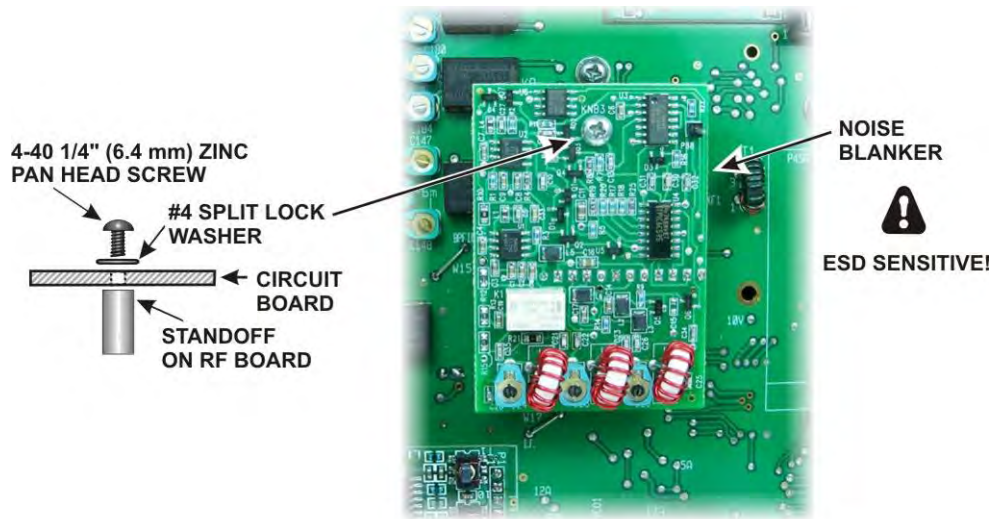


Figure 87. Installing the Noise Blanker Board.

Battery BT1

Battery BT1 Description

BT1 is a 3-volt lithium coin cell that provides the operating voltage for the real-time-clock IC (RTC) on the front panel when the K3 is turned off. Depending on the type of cell, BT1 could last from 2 to 10 years, thanks to the extremely low current drain of the RTC – on the order of a few microamperes. The RTC keeps track of the full date and 24-hour time, either of which can be displayed on the VFO B portion of the LCD.

Battery BT1 Installation Procedure

- Insert the CR2032 cell into battery holder BT1 as shown in Figure 88.



Figure 88. Installing BT1.

KBPF3 General Coverage Receive Option

If you have the KBPF3 General Coverage Receive option kit, install the board as follows. Otherwise skip this section and go directly to *Power Amplifier Jumper Block* on page 64.

KBPF3 Description

The KBPF3 extends the receive coverage outside of the Ham bands over the range of 500 KHz to 30 MHz and from 48 MHz through 54 MHz. Only the receiver coverage is extended. The transmitter frequency coverage is not affected.

KBPF3 Installation Procedure

□ Install the board on the standoffs you installed earlier as shown in Figure 89. The screws and lock washers needed are supplied with your KBPF3 Option kit. There are three connectors on the bottom of the KBPF3 board that must be properly mated to P44A, P44C and P44E on the RF board. Even though the connectors are hard to see if they KPA3 shield is installed, they can be aligned as follows:

- Set the KBPF3 board in place over the standoffs, aligning it so the holes in the KBPF3 board are aligned with the tops of the standoff. This will align the connectors.
- Press down on the KBPF3 board to mate the connectors at the end near battery BT1 and along the side nearest the LPA board or, if installed, the KPA3 shield, while checking to ensure that the holes in the board are aligned with the holes in the standoffs. Note that simply installing the mounting screws will not ensure the 3-pin connectors are fully mated. When properly mounted the KBPF3 board should rest on top of the standoffs and be parallel with the RF board underneath.

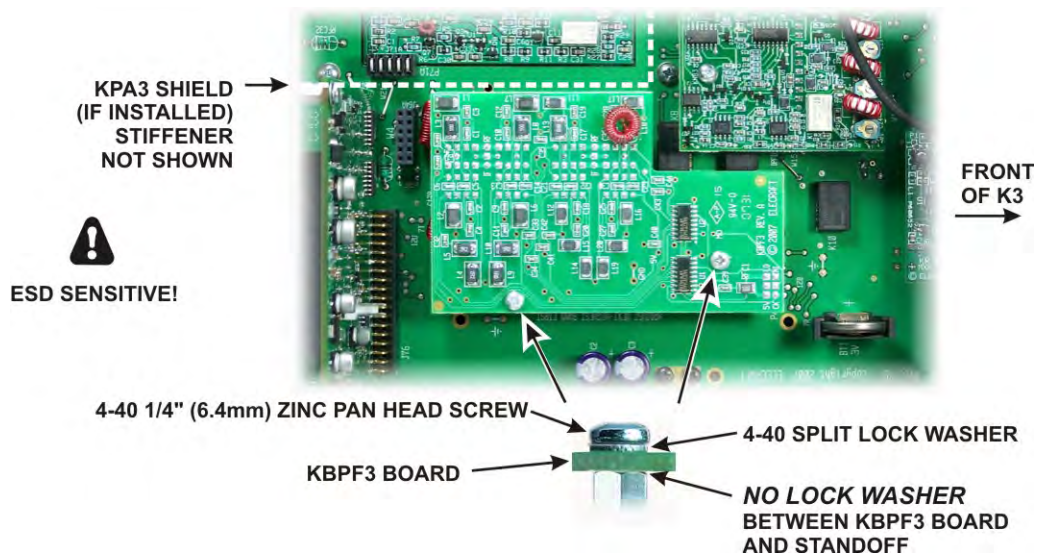


Figure 89. Installing the KBPF3 Option Board.

Bottom Covers

□ Turn the K3 over so the bottom is exposed. Position the forward section of the bottom cover with the feet and bail toward the front as shown in Figure 91. Attach the cover with seven 3/16" (4.8 mm) black pan head screws (SS) at the positions shown. Do not use washers.

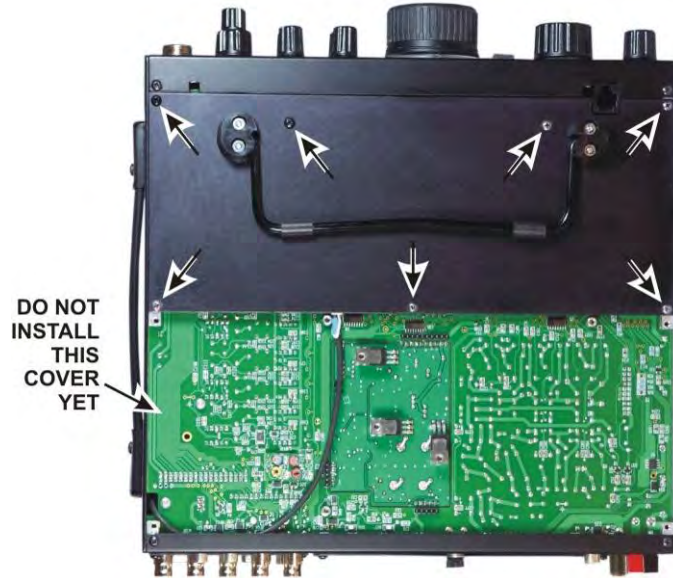


Figure 91. Installing Bottom Cover Forward Section.

□ Locate the three thermal pads and clear the screw holes. They are already cut. If material is still covering the holes, push a small tool through the hole to remove the unwanted material. Remove the protective backing from each pad and press the adhesive side against a low-power amplifier transistor with the hole in the pad aligned with the screw hole in the transistor as shown in Figure 92. Take care not to disturb the position of the transistors over the standoffs.

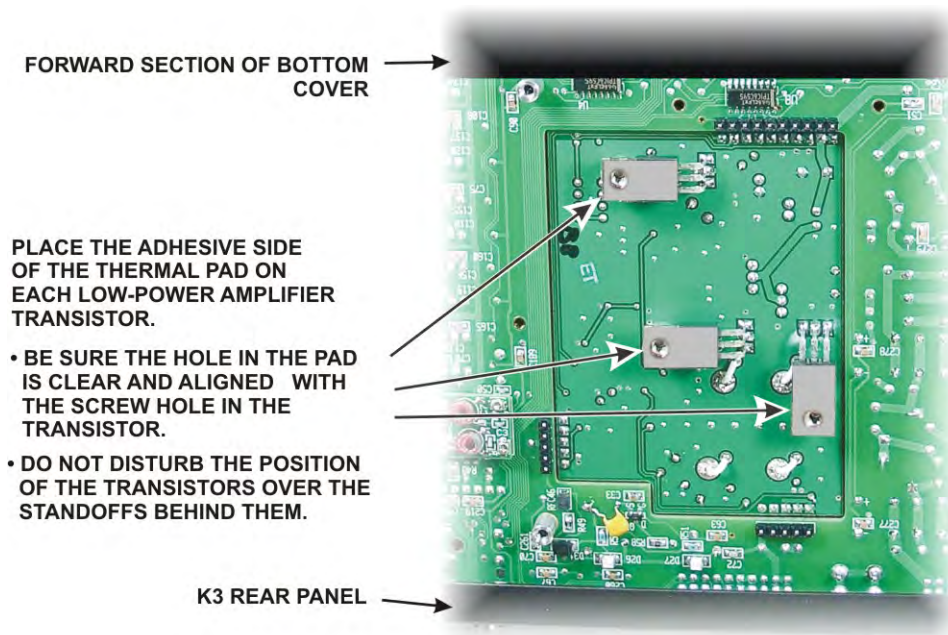


Figure 92. Installing the Low Power Amplifier Transistor Thermal Pads.

- Install the rear bottom cover section as follows (see Figure 93):
 - Position the cover so the holes near the center line up with the transistors on the LPA board. The remaining holes will line up with 2D fasteners and standoffs.
 - Note:** The bottom cover is anodized, not painted. There is a circular area around the three holes on the inside surface that was masked to retain the bare metal. This circular area may not cover the entire area of the thermal pads of all three transistors. That is normal. The thermal pads will efficiently transfer the heat even if part of one or more extends onto the anodized area.
 - Start three 4-/40 1/4" (6.4 mm) black pan head screws (SS) into the transistors through the holes near the center with a #4 inside tooth lock washer under each screw head. Do not tighten the screws yet.
 - Start seven 4-40 3/16" (4.8 mm) black pan head screws (SS) into the remaining holes. Do not use washers.
 - Tighten all ten screws.

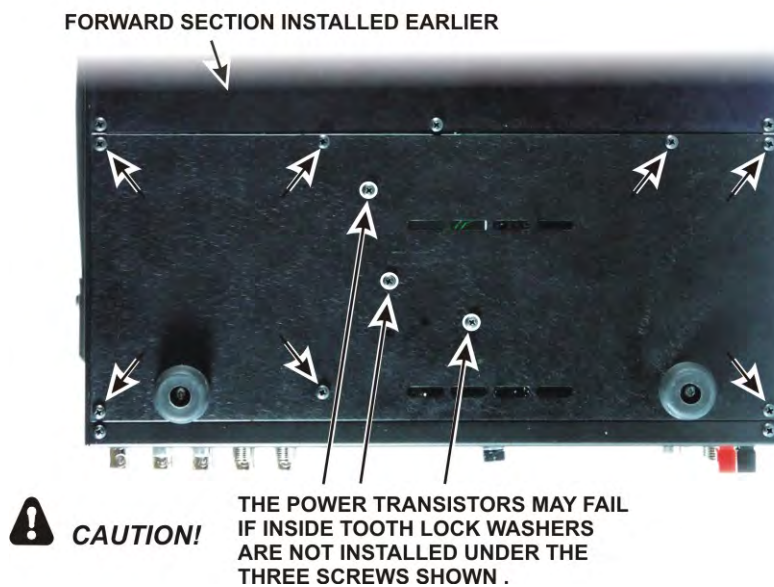


Figure 93. Checking Power Transistor Mounting Hardware.

- Inspect the bottom cover screws to ensure you have inside tooth lock washers under the three screws shown in Figure 93. **Be sure all three screws are tight.**

Top Cover

Even if you have the KPA3 100-watt module to install, install the top cover and speaker at this time for initial testing and calibration of the basic 10-watt K3 configuration.

Connect the speaker cable to P25 of the KIO3 board as shown in Figure 94. If you have the KPA3 shield installed, route the speaker wire under the stiffener bar.

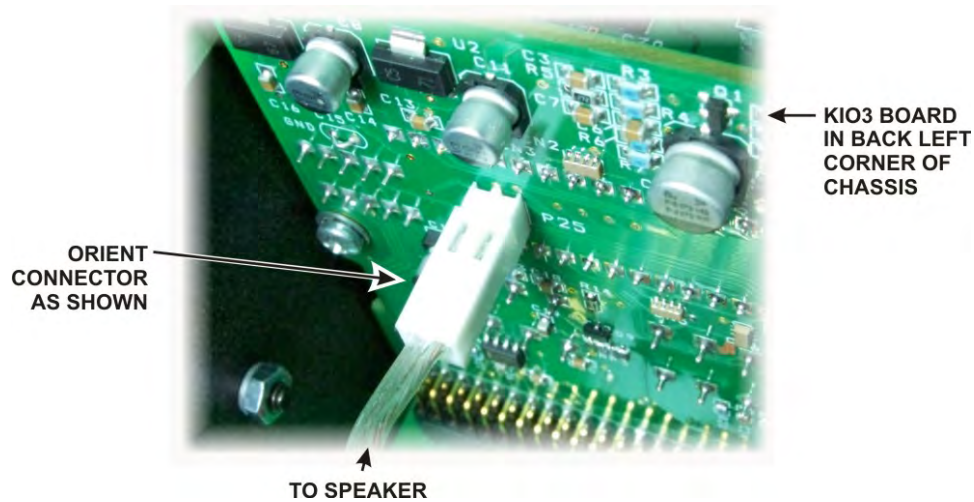


Figure 94. Connecting Speaker to KIO3 Board.

Place the top cover on the K3 with the tab at the rear extending under the lip of the rear panel. Secure the top cover with six 4-40 3/16" (4.8 mm) black flat head screws (SS) along the front and rear edges of the cover. You may find it necessary to loosen screws at the top of the side, front and rear panels to adjust their position so the top cover fits properly.

☐ If you have the KPA3 shield installed, place three 4-40 3/16" (4.8 mm) black flat head screws (SS) through the holes across the middle of the cover to secure it to the stiffening bar. If you have not installed the KPA3 shield, the stiffening bar is still attached to the top cover where you mounted it to measure the speaker grill cloth for trimming. Place a 4-40 3/16" (4.8 mm) black flat head screw (SS) into each side panel to secure the ends of the stiffening bar.

⚠ *The screws that hold the top cover in place are an important part of the structural design that provides excellent structural rigidity in spite of its light weight. Be sure all the screws are in place and tight whenever you replace the cover or other panels.*

When removing the top cover in the future, the normal procedure is to remove the nine screws on top, leaving the stiffening bar on the chassis (see Figure 95). If the KPA3 100-watt amplifier is installed, this is the only way the top cover can be removed because the rear shield installed with the KPA3 attaches to the stiffening bar.

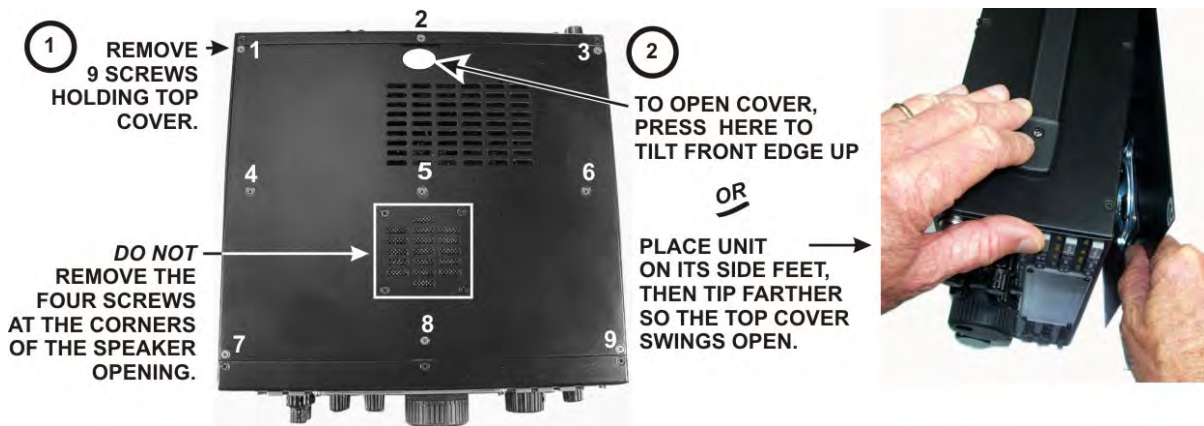


Figure 95. How to Remove the Top Cover.

This completes the assembly of your K3/10 Transceiver. Next perform the Initial Test and Calibration procedures below to ensure your K3 is operating properly. Once they have been completed you can proceed to install other options, including the KPA3 100-watt amplifier module, at any time. Each option is supplied with its own installation manual.

⚠ PARTS LEFT OVER?

You may find that you have extra screws, washers or nuts after completing the assembly of your K3. This is normal. Extras of parts most easily lost during assembly are frequently included.

Test and Calibration

It's time to apply power! In the following tests and procedures you will check out and calibrate essential functions of your basic K3. You must complete these procedures before operating your K3 at low power or before installing a KPA3 100-watt power amplifier option.

Have your K3 Owner's Manual handy. Detailed procedures are in your Owner's Manual where you can find them easily in the future if you need them.

⚠ YOUR K3 WILL NOT OPERATE, OR WILL NOT OPERATE CORRECTLY, until you complete the Test and Calibration procedures below, including:

- **Synthesizer Calibration.**
- **Filter Setup (all five procedures listed for *each* filter installed).**
- **Reference Oscillator Calibration.**
- **TX Gain Calibration on *all* bands.**

⚠ Using Tap/Hold Switches: Most K3 switches have two functions. ***Tapping*** activates the function labeled on the switch. ***Holding*** (~1/2 sec.) activates the function labeled beneath the switch.

Initial Power Checks

Connect your 13.8 VDC nominal (11-15 VDC) power supply to the red and black 12VDC IN connector on the back of your K3. Don't connect anything else to your rig until instructed to do so.

On the front panel, tap **POWER** to turn the K3 on. The LCD display should illuminate as it did before. It will probably show an error message, e.g. ERR PLL or ERR PL1. This is normal! It is reporting that the synthesizer has not been calibrated. Tap **DISP** (display) to clear the error message. Other error messages may follow, depending upon which modules you have installed, indicating that they have not been initialized yet. Press display until you have cleared the error messages.

⚠ Always turn your K3 off by pressing the **POWER button. Removing DC power while the K3 is on can, on rare occasions, result in corrupted data in the EEPROM requiring you to reload the firmware.**

If you checked the “Yellow Dot” box on page 28 while inspecting the KIO3 Audio Board, do the following. Otherwise skip this step and proceed to *Synthesizer Calibration* below. The headphone jack on the KIO3 Audio Board uses an inverted speaker cut-off logic that prevents speaker audio with the default firmware setting. Change the firmware setting as follows:

- Hold the **CONFIG** switch at least 1/2 second to bring up the configuration menu on the LCD.
- Rotate the VFO B knob (the knob marked **B** to the right of the main tuning knob) until *SPKR+PH* appears in the lower right area of the LCD.
- Tap the **1** switch on the numeric keypad to the right of the LCD until you see *PH.R SW* followed by a + sign.
- Tap the **1** switch again and note that the sign changes to –, indicating it is set for the inverted logic. This is a toggle; if you tap the **1** switch again the sign will change back to +. Be sure the sign is – for KIO3 Audio boards with a yellow dot.
- Tap the **MENU** switch to exit the configuration menu and confirm that you have noise in the loudspeaker when the AF GAIN knob is rotated clockwise.

Synthesizer Calibration

Hold **CONFIG** to access the configuration menu, then rotate VFO B to display TECH MD. Set the TECH MD parameter to ON with VFO A.

Refer to the *Calibration Procedures* in your Owner’s Manual and perform the *Synthesizer* calibration.

When the calibration process is completed, press the BAND switch to cycle through all the bands from 160 meters through 6 meters and verify that there are no CAL PLL error messages on the display. That indicates that the synthesizer is calibrated on all the bands.

Filter Setup

Turn to the *Crystal Filter Installation and Setup* section of your Owner's Manual and perform the following procedures. If you have installed standard Elecraft 5-pole filter(s) you will need the **FREQ OFFSET** data you recorded earlier on page 14.

- *Filter Bandwidth Setup*
- *Filter Center Frequency Setup*
- *Receive Filter Enables*
- *Filter Loss Compensation*
- *Transmit Filter Selection*

⚠ The transmit filter selection setup requires that you select a valid transmit filter for each mode. If you fail to do so, you will see **ERR TXF** and have no RF output when you attempt to transmit.

Reference Oscillator Calibration

Turn to the *Calibration Procedures, Reference Oscillator* section in your Owner's manual and perform either of the reference oscillator calibration procedures found there. One of the procedures uses an off-air signal and requires no external test equipment. If you installed the K3EXREF option, refer to *Using the K3EXREF* on page 4 of the *K3 K3EXREF Frequency Lock Option* manual for testing and operating instructions.

TX Gain Calibration

If you do not have a computer, turn to the *Calibration Procedures, Transmitter Gain* section in your Owner's manual and perform the manual *Low-Power (5W) TX Gain Calibration* procedure.

⚠ Note: If you perform the manual procedure in the Owner's manual, when you press ANT to select ANT1 or press BYPASS to put the ATU in bypass mode, the display will read NO ATU even if you have installed the KAT3 ATU module. If you have the installed the KAT3 ATU, it will be enabled next section after this calibration is done.

If you have a Windows, Linux or Macintosh computer with an RS232 interface and cable, and an internet connection, perform the automated TX Gain calibration using the K3 Utility program as follows:

Install the Elecraft K3 Utility Ver. 1.1.12.29 or later on your computer. The utility is available for downloading from the Elecraft web site: www.elecraft.com

Connect your computer to your K3's RS232 port and start the K3 Utility program.

Click on the K3 Utility "Configuration" tab, "Calibrate Transmitter Gain..." and perform the 5-Watt Transmitter Gain Calibration.

Option Modules

Enable Modules

Enable the KNB3 noise blanker and, if installed, the KBPF3, KAT3, KDVR3 and KXV3 option modules as described in the *Option Module Enables* section of your Owner's Manual. Even though they are installed, these modules will not function until they are enabled.

KPA3 100-Watt Amplifier Installation

If you purchased the KPA3 100-watt amplifier option, turn to the *KPA3 Option Installation Instructions* manual *Installation Procedure* to complete installation and testing now.

KRX3 Subreceiver Installation

If you purchased the KRX3 subreceiver, turn to the *KRX3 High-Performance Subreceiver Installation and Operation* manual to complete the installation. Since you have already installed the Auxiliary DSP board, begin with the section *Checking and Modifying Resistor R91* and continue on with all the steps to the end of the manual.

Other Calibration Procedures

Wattmeter Calibration (Optional)

The wattmeter is reasonably accurate as it is supplied. However, if you have an accurate external wattmeter you can adjust the K3 to match its readings at low power (5 watts), high power (50 watts), and, if you have the KXV3 module installed, at 0.5 milliwatts output at the KXV3 transverter interface. Refer to *Calibration Procedures, Wattmeter* in your Owner's Manual.

S-Meter Calibration (Optional)

The S-meter calibration is normally quite accurate with the default settings provided. If you have an accurate 50-ohm, 50-microvolt signal generator (such as the Elecraft XG1 or XG2) you can calibrate the S-meter yourself. Refer to *Calibration Procedures, S-Meter* in your Owner's manual.

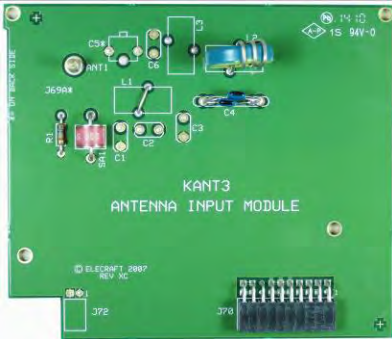


Appendix A Illustrated Parts List

Your kit contains a number of envelopes, boxes and packages of parts. Check the contents of each one carefully against the following lists. Doing so will not only ensure no parts are missing, but it will also familiarize you with the appearance of each part that helps the kit assembly go smoothly and quickly.



You may find extra small parts included in your kit. The quantities specific are those required. Also there is a small bag marked Spares containing more extra parts. If a part is missing, contact Elecraft for a replacement (see *Customer Service and Support* on page 1).

Parts for Your Specific Kit



Depending upon the options you chose for our K3, certain parts may be supplied or omitted as needed. One of the first things you removed from the box was a smaller box containing these parts as described below. Some options such as the KPA100 KAT3 Automatic Antenna Tuner are supplied in separate boxes with their own parts lists. They are not shown here. As you assemble your K3, you will be directed to install those options or prepare your K3 for them to be installed after initial testing and checkout at the proper points in the assembly procedure.

ILLUSTRATION	DESCRIPTION	QTY	ELECRAFT PART NO.
	<p>KANT3 Antenna Input Module.</p> <p>Not supplied if you purchased the KAT3 automatic antenna tuner option with your K3 kit.</p> <p>The KAT3 replaces the KANT3.</p> <p>NOTE: Not all component positions on the board are filled. That is normal, the result of design improvements.</p>	1	E850248
	<p>Panel, Blank (KPA3 Fans)</p> <p>Not supplied if you purchased the KPA 100 watt amplifier option with your K3 kit.</p>	1	E850297
	<p>Panel, Blank (KXV3 I/O)</p> <p>Not supplied if you purchased the KXV3 I/O option with your K3 kit.</p>	1	E850296

E850323 KREF3 TCXO Module Bag




ILLUSTRATION	DESCRIPTION	QTY	ELECRAFT PART NO.
	KREF3 TCXO Module, 49.380 MHz, ±5 ppm stability This module is not supplied if you purchased the optional ±1 ppm module shown below. .	1	E660033
	Tie Wrap, KREF3 TCXO. Module	1	E980145

KTCX03-1 TCXO Module Bag




ILLUSTRATION	DESCRIPTION	QTY	ELECRAFT PART NO.
	KREF3 TCXO Module, 49.380 MHz, ±1 ppm stability. (optional)	1	KTCX03-1
Rectangular Insulator attached to the bottom of the TCXO Module	TCXO spacer (supplied only with optional KTCX03-1 module)	1	E980146
	Tie Wrap, KREF3 TCXO. Module	1	E980145

Crystal Filter (in bag)

Standard Filter. Not supplied if you ordered the optional KFL3A-2.8K filter (see below)

ILLUSTRATION	DESCRIPTION	QTY	ELECRAFT PART NO.
	KFL3A-2.7K Filter Note: This filter is not supplied if you purchased the optional 8-pole 2.8 kHz filter with your K3 kit.	1	E850249
	Screw, 4-40, either 1/4" (6.4 mm) Zinc, Pan Head. Screw may be inserted into a threaded bushing in the bottom of the filter board with the washer below.	1	E700005
	Lock Washer, #4, Interior Tooth.	1	E700010

Optional Filter

ILLUSTRATION	DESCRIPTION	QTY	ELECRAFT PART NO.
	KFL3A-2.8K Filter (optional)	1	KFL3A-2.8K
	Screw, 4-40, either 1/4" (6.4 mm) Zinc, Pan screw in envelope.	1	E700005
	Lock Washer, #4, Interior Tooth in envelope with screw.	1	E700010

If you ordered additional crystal filters, they will be enclosed in the box in separate bags with the same hardware shown above.

Parts Included in All K3 Kits

These parts are in a box with a label identifying the contents as a K3 kit and whether it is a K3/10 (10 watt) or K3/100 (includes the optional 100 watt KPA100 amplifier).

Your kit should include all of the following parts regardless of the options you chose. Note that there are two additional boxes. One box contains the large K3 BSF (main RF board) (see page A-15) and the other box contains the chassis set (see page A-16).

Printed Circuit Boards

Each board is packaged in its own ESD-safe bag identified by the part numbers shown below. The photographs are provided to help you identify each board. You may find that some of the components or component locations on the boards you receive are slightly different from those shown.

⚠ CAUTION!

DO NOT DISTURB ANY ADJUSTMENTS ON THE BOARDS

Each board was tested and aligned for optimum performance at the factory. Any change to these adjustments will degrade the performance of your K3 or prevent its operation altogether. All user calibrations and adjustments are done in firmware using the front panel menus. These are described at the appropriate points in the assembly procedures and in the Owner's Manual.


ILLUSTRATION	DESCRIPTION	QTY	ELECRAFT PART NO.
	Front Panel Printed Circuit Board Assembly ⚠ ESD Sensitive	1	E850242


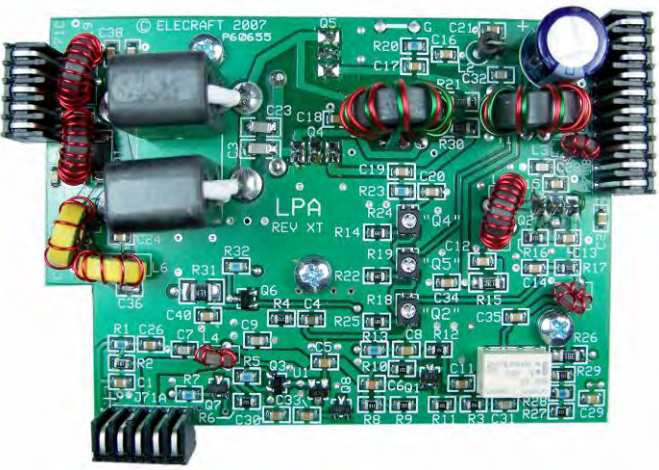
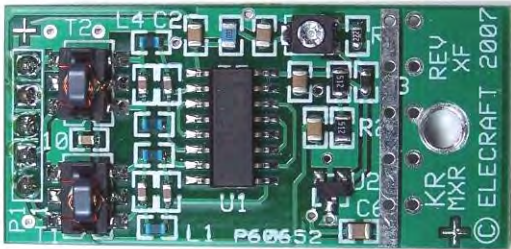
ILLUSTRATION	DESCRIPTION	QTY	ELECRAFT PART NO.
 <p>A green printed circuit board (PCB) assembly for a DSP. It features a central DSP chip, various integrated circuits, resistors, capacitors, and connectors. The board is populated with numerous components and has a complex layout.</p>	<p>K3 DSP Printed Circuit Board Assembly</p> <p>⚠ ESD Sensitive</p>	<p>1</p>	<p>E850233</p>
 <p>A green PCB assembly for a Low Power Amplifier (LPA). It includes a large electrolytic capacitor, several resistors, capacitors, and a central amplifier chip. The board is densely packed with components and has multiple connection points.</p>	<p>LPA (Low Power Amplifier) PCB Assembly</p> <p>⚠ ESD Sensitive.</p>	<p>1</p>	<p>E850256</p>
 <p>A green PCB assembly for a mixer. It features a central mixer chip, several resistors, capacitors, and a transformer. The board is populated with various components and has a clear layout.</p>	<p>K3 Mixer PCB Assembly</p> <p>⚠ ESD Sensitive.</p>	<p>1</p>	<p>E850257</p>


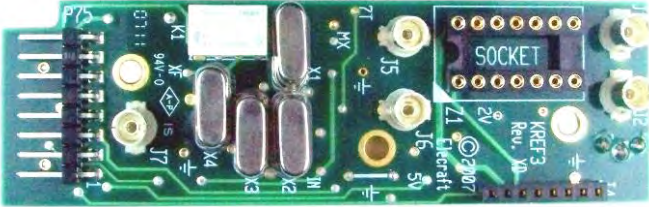

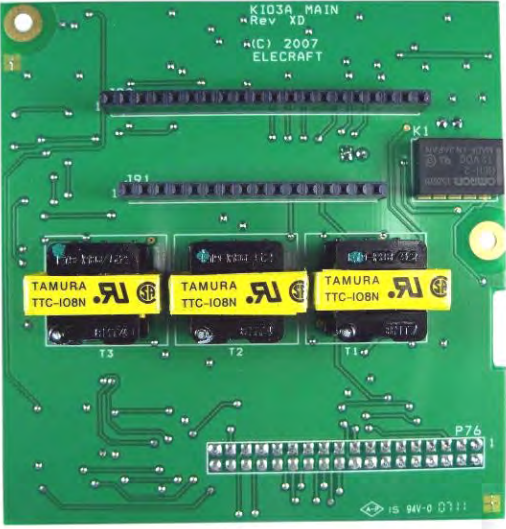
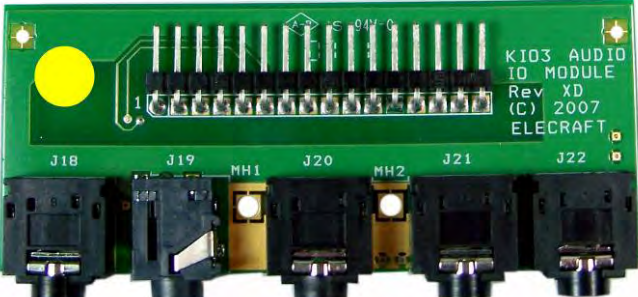
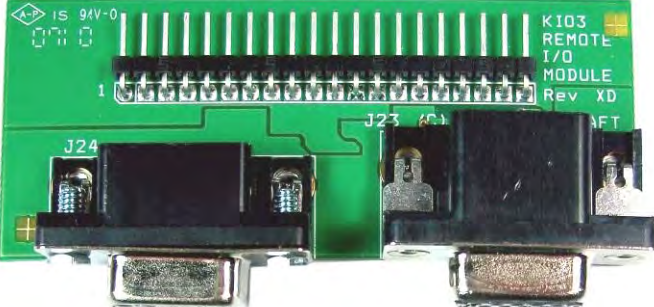

ILLUSTRATION	DESCRIPTION	QTY	ELECRAFT PART NO.
	<p>KNB3 Noise Blanker PCB Assembly</p> <p>⚠ ESD Sensitive.</p>	1	E850280
	<p>KREF3 PCB Assembly</p> <p>⚠ ESD Sensitive.</p>	1	E850254
	<p>KSYN3 Assembly w/Stiffener Attached</p> <p>⚠ ESD Sensitive</p>	1	E850402

ILLUSTRATION	DESCRIPTION	QTY	ELECRAFT PART NO.
 <p>The image shows the KIO3A MAIN PCB Assembly, a green printed circuit board. It features three yellow Tamura TTC-108N capacitors labeled T1, T2, and T3. The board is populated with various electronic components and has a multi-pin connector at the bottom. Text on the board includes "KIO3A MAIN Rev XD", "(C) 2007 ELECRAFT", and "P76".</p>	<p>KIO3 Main PCB Assembly ⚠ ESD Sensitive.</p>	1	E850237
 <p>The image shows the KIO3 Audio I/O PCB Assembly, a green printed circuit board. It features a multi-pin connector at the top and several audio jacks at the bottom labeled J18, J19, MH1, J20, MH2, J21, and J22. A yellow dot is visible near the top-left corner. Text on the board includes "KIO3 AUDIO IO MODULE Rev XD (C) 2007 ELECRAFT".</p>	<p>KIO3 Audio I/O PCB Assembly ⚠ ESD Sensitive. NOTE: The board may have a yellow dot near one corner. This is normal and explained in the assembly procedure.</p>	1	E850649
 <p>The image shows the KIO3 Digital I/O PCB Assembly, a green printed circuit board. It features a multi-pin connector at the top and two large connectors at the bottom labeled J23 and J24. Text on the board includes "KIO3 REMOTE I/O MODULE Rev XD" and "IS 94V-0".</p>	<p>KIO3 Digital I/O PCB Assembly ⚠ ESD Sensitive.</p>	1	E850235




Miscellaneous Components

Packed in separate bags and envelopes as follows:


E850239 K3 FP Encoder Assembly Bag

ILLUSTRATION	DESCRIPTION	QTY	ELECRAFT PART NO.
	K3 FP Encoder Assembly	2	E850239


E850305 K3 Knobs for Front Panel (bag)

ILLUSTRATION	DESCRIPTION	QTY	ELECRAFT PART NO.
	Knob, VFO B Tuning	1	E980090
	Knob, RIT/XIT	1	E980089
	Knob, Concentric Shaft, Large	2	E980092
	Knob, Concentric Shaft, Small	2	E980091




E850308 K3 Front Panel Knobs , Set of 4 (bag)

ILLUSTRATION	DESCRIPTION	QTY	ELECRAFT PART NO.
	Knob, Small Encoder Shaft	4	E980088

E850306 K3 Knob and Band for VFO A (bag)





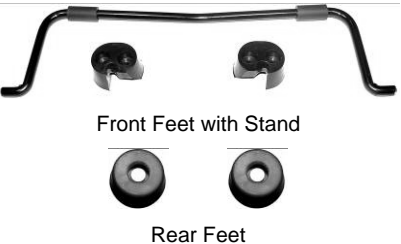





ILLUSTRATION	DESCRIPTION	QTY	ELECRAFT PART NO.
	Knob, VFO A Tuning	1	E980093
	Finger Grip, Main VFO Tuning Knob	1	E980094


E850307 K3 Front Panel Bezels and Serial Number Label (bag)

ILLUSTRATION	DESCRIPTION	QTY	ELECRAFT PART NO.
	Bezel (LCD cover), K3	1	E100195
	Trim Panel, K3 VFO	1	E100197
	Serial Number Label (supplied in envelope marked E850298)	1	E980137


E850263 K3 RF Misc. Bag

You will find bags included inside this bag. Where a bag or envelope inside this bag contain several parts with individual part numbers, they are listed on separate tables following this one. In addition there is a small bag marked K3 Hardware Spares Bag. It contains a collection of small parts that are easily lost. Normally you will not need any of the parts it contains to build your kit.




ILLUSTRATION	DESCRIPTION	QTY	ELECRAFT PART NO.
	TMP Cables	3	E100282
	Lithium Battery, 3V (in envelope)	1	E850058
	Loudspeaker Grill Cloth	1	E850089
	#4 Fiber Washer	4	E700031
 <p data-bbox="300 1050 511 1081">Front Feet with Stand</p> <p data-bbox="357 1165 454 1186">Rear Feet</p>	Bottom Feet with tilt stand	1	E980098
	SO239 Hole Cover	1	E980135
	BNC Hole Cover	3	E980136
	Thumbscrew, #6	1	E700070
	2D Fastener	10	E100078
	Thermal Pads (inside small envelope)	3	E850411

<p>Typical Standoffs (May be round or hexagonal)</p> 	Standoff, 4-40, 1/4" (6.4 mm) long	6	E700026
	Standoff, 4-40, 3/8" (9.5 mm) long	2	E700153
	Standoff, 4-40, 1/2" (13 mm) long	3	E700061
	Screw, 4-40, 3/16" (4.8 mm) Black, Flat Head	27	E700025
	Screw, 4-40, 3/8" (9.5 mm) Black, Flat Head	6	E700131
	Screw, 4-40, 1/2" (13 mm) Black, Flat Head	1	E700132
<p>Typical Pan Head Screws</p>  <p>Zinc Black</p>	Screw, 4-40, 3/16" (4.8 mm), Black, Pan Head	38	E700015
	Screw, 4-40, 1/4" (6.4 mm) Zinc, Pan Head	20	E700005
	Screw, 4-40, 1/4" (6.4 mm) Black, Pan Head	3	E700009
	Screw, 4-40, 7/16" (11 mm) Zinc, Pan Head	7	E700032
	Lock Washer #4, Split	38	E700004
	Lock Washer, #4, Inside Tooth	20	E700010
	Nut, 4-40	14	E700011
	Washer, Flat, #6	2	E700067
	Grommet Bumper, 7/16" Round (Side panel feet)	4	E980141





E850067 Allen Wrench Envelope (in K3 RF Misc Bag)

ILLUSTRATION	DESCRIPTION	QTY	ELECRAFT PART NO.
	Allen Wrench, 5/64" (in envelope)	1	E980004
	Allen Wrench, .050" (in envelope)	1	E980006

E850382 K144XV Side Panel Hardware Envelope (in K3 RF Misc Bag)





ILLUSTRATION	DESCRIPTION	QTY	ELECRAFT PART NO.
	Screw, 6-32, 1/4" (6.4 mm) Black Flat Head	3	E700186
	Lock Washer, #6, Split Ring	3	E700041
	Nut, 6-32	3	E700040

E850399 KSYN3 Envelope (in K3 RF Misc Bag)






ILLUSTRATION	DESCRIPTION	QTY	ELECRAFT PART NO.
	Screw, 4-40 1/2" (12 mm) Zinc, Pan Head	2	E700196
	Screw, 4-40 3/8" (9.5 mm) Zinc Pan Head (see note below)	1	E700036
	Lock Washer #4, Split	2	E700004
	Lock Washer, #4, Inside Tooth (see note below)	3	E700010
	Nut, 4-40 (see note below)	1	E700011

Note: This screw, lock washer and nut are used to secure the stiffener on the KSYN3 PCB (see lower left corner of KSYN3 image on page A-5). Normally they are already installed. If so, they may not be included in this bag, or the corresponding parts in this bag are extras.

E850229 SO239 Ant Connector Assembly Bag (in K3 RF Misc Bag)

ILLUSTRATION	DESCRIPTION	QTY	ELECRAFT PART NO.
	SO239 (UHF) Female Panel Mount Connector with cable	1	E850229
	Screw, 4-40, 1/4" (6.4 mm) Black, Pan Head	2	E700009
	Lock Washer, #4, Inside Tooth	2	E700010
	Nut, 4-40	2	E700011

E850238 KIO3A Hardware Bag



ILLUSTRATION	DESCRIPTION	QTY	ELECRAFT PART NO.
	Screw, 4-40, 1/4" (6.4 mm) Black, Pan Head	4	E700009
	Screw, 4-40, 1/4" (6.4 mm) Zinc, Pan Head	2	E700005
	Lock Washer, #4, Inside Tooth	2	E700010
	Jackscrew Nut, 4-40 Note: Two of the jackscrew nuts may be mounted on the DB-9 connector on the Remote I/O Board.	4	E700078
	Standoff, 4-40, 1-1/4" (31.8 mm) long	2	E700119

E850241 Front Panel Hardware Bag

ILLUSTRATION	DESCRIPTION	QTY	ELECRAFT PART NO.
	Felt Washer	3	E700033
	Knurled Nut (Phones Jack)	1	E700138
<p data-bbox="324 583 487 609">Typical Standoffs</p> 	Standoff, 2/56, 5/16" (7.9 mm) long	2	E700122
	Standoff, 4-40, 5/16" (7.9 mm) long	2	E700121
	Standoff, 4-40, 5/8" (15.9 mm) long	3	E700003
	Standoff, Nylon, 5/8" (15.9 mm) long	1	E700163
	Screw, 4-40, 3/16" (4.8 mm) Black, Flat Head	1	E700025
	Screw, 2-56, 1/4" (6.4 mm) Black, Pan Head	2	E700124
	Screw, 4-40, 1/4" (6.4 mm) Zinc, Pan Head	7	E700005
	Lock Washer, #2, Split	2	E700123
	Lock Washer #4 Split	9	E700004
	Nut, 1/2" (13 mm) Hex	6	E700125
	Lock Washer, 1/2" (13 mm) Inside Tooth	5	E700150
	Washer, Flat, Phones Jack Spacer	1	E700145
 <p data-bbox="324 1617 487 1648">(Soft Foam Strips)</p>	Front Panel Light Blocker (2 strips in envelope)	1	E850324


E850341 VFO A Bezel Screws Envelope (in Front Panel Hardware Bag)

⚠ Do not mix these screws up with other parts in the Front Panel Hardware bag. Confusing them with other screws nearly the same length may destroy your front panel board. They are packaged separately for your convenience. You will be instructed when to use each screw in the assembly procedure.

ILLUSTRATION	DESCRIPTION	QTY	ELECRAFT PART NO.
	Screw, 4-40, 5/16" (7.9 mm) Black, Flat Head	1	E700027
	Screw, 2-56, 1/4" (6.4 mm) Black, Pan head (See Note Below)	2	E700124

E850340 LCD Bezel Screws Envelope (in Front Panel Hardware Bag)

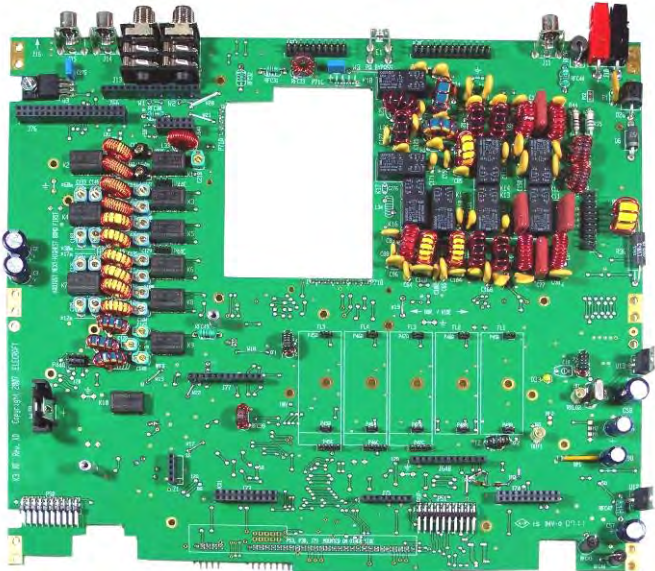


⚠ Do not mix these screws up with other loose parts in the Front Panel Hardware bag. Confusing them with other screws nearly the same length may destroy your front panel board. They are packaged separately for your convenience. You will be instructed when to use each screw in the assembly procedure.

ILLUSTRATION	DESCRIPTION	QTY	ELECRAFT PART NO.
	Screw, 2-56, 1/4" (6.4 mm) Black, Pan head	4	E700124


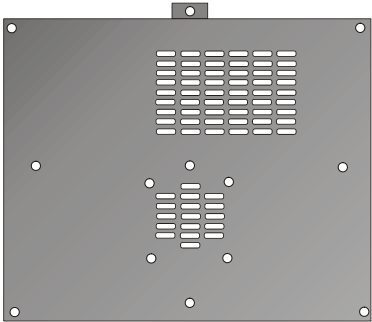






E850301 Power Cable Assembly

Bag with components and separate instruction sheet.


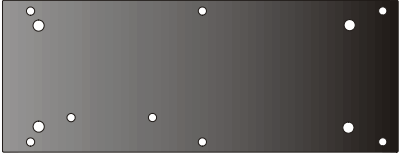
E850350 K3 RF BSF Assembly (in box)

	<p>RF Board  ESD Sensitive</p>	<p>1</p>	<p>E850557</p>
	<p>PA Jumper Block Assembly (pre-installed on RF board)</p>	<p>1</p>	<p>E850325</p>


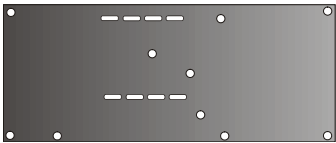
E850262 K3 Chassis Set (in box)

ILLUSTRATION	DESCRIPTION	QTY	ELECRAFT PART NO.
	Front Panel	1	E100209SS
	Top Cover	1	E100212
	Rear Panel	1	E100214SS
	Front Panel Shield	1	E100216
	Chassis Stiffener	1	E100222
	KIO3 Panel	1	E850315
	Loudspeaker with attached wire and connector	1	E850300
	Loudspeaker Shield	1	E980087





E850312 Side Panels

ILLUSTRATION	DESCRIPTION	QTY	ELECRAFT PART NO.
	Left Side Panel	1	E100210
	Right Side Panel	1	E100211

E850313 Bottom Covers (Wrapped)

ILLUSTRATION	DESCRIPTION	QTY	ELECRAFT PART NO.
	Bottom Cover A	1	E100213
	Bottom Cover B	1	E100221

E850316 Carrying Handle Bag

ILLUSTRATION	DESCRIPTION	QTY	ELECRAFT PART NO.
	Handle (strap, spring insert and two end caps)	1	E850317
	Screw, 6-32, 1/2" (13 mm), Black, Pan Head (in envelope)	2	E700042
	Lock Washer, #6, Split (in envelope)	2	E700041
	Nut, 6-32 (in envelope)	2	E700069