



# ELECRAFT® K3

## HIGH-PERFORMANCE 160 – 6 METER TRANSCEIVER

### OWNER'S MANUAL

Revision D10, August 24, 2011

Copyright © 2011, Elecraft, Inc.

All Rights Reserved

# Contents

A Note to K3 Owners .....	3	Buffered I.F. Output.....	39
Key to Symbols and Text Styles .....	3	Using Transverters .....	39
Quick-Start Guide.....	4	Scanning .....	40
Introduction.....	7	<b>Main and Sub Receiver Antenna Routing.....</b>	<b>41</b>
K3 Features .....	7	Basic K3 (no KAT3 or KXV3).....	41
Specifications .....	8	K3 with KXV3 RF I/O Module.....	41
Customer Service and Support .....	10	K3 with KAT3 ATU .....	42
<b>Front Panel .....</b>	<b>11</b>	K3 with KAT3 and KXV3.....	43
Control Groups.....	11	<b>Remote Control of the K3 .....</b>	<b>44</b>
Display (LCD).....	12	<b>Options and Accessories .....</b>	<b>45</b>
LEDs.....	13	<b>Firmware Upgrades.....</b>	<b>45</b>
Front Panel Connectors.....	13	<b>Configuration.....</b>	<b>46</b>
Primary Controls.....	13	Crystal Filter Setup .....	46
Multi-Function Controls .....	14	Option Module Enables .....	47
VFO Tuning Controls .....	14	Miscellaneous Setup .....	47
Keypad.....	15	VFO A Knob Friction Adjustment .....	48
Memory Controls .....	16	VFO B Knob Friction Adjustment .....	48
Message Record/Play Controls.....	16	Real Time Clock Battery Replacement.....	48
RIT and XIT Controls.....	16	<b>Calibration Procedures .....</b>	<b>49</b>
<b>Rear Panel .....</b>	<b>17</b>	Synthesizer .....	49
Connector Groups .....	17	Wattmeter.....	49
KIO3 Module .....	18	Transmitter Gain .....	49
<b>Basic Operation.....</b>	<b>21</b>	Reference Oscillator.....	50
Receiver Setup .....	23	Front Panel Temperature Sensor .....	51
Reducing Interference and Noise .....	25	PA Temperature Sensor .....	51
Transmitter Setup.....	26	S-Meter and RF GAIN Control .....	51
Voice Modes (SSB, AM, FM).....	28	<b>Menu Functions .....</b>	<b>52</b>
CW Mode .....	30	MAIN Menu.....	52
Data Modes .....	31	CONFIG Menu.....	53
<b>Advanced Operating Features.....</b>	<b>33</b>	<b>Troubleshooting.....</b>	<b>64</b>
Text Decode And Display.....	33	Parameter Initialization.....	66
CW-to-DATA.....	34	Module Troubleshooting.....	67
Tuning Aids: CWT and SPOT.....	34	<b>Theory Of Operation.....</b>	<b>71</b>
Audio Effects (AFX).....	35	RF BOARD.....	71
APF and Dual-Passband CW Filtering.....	35	KAT3 (ATU) and KANT3 .....	73
Receive Audio Equalization (EQ).....	35	KIO3 (AF/Digital I/O).....	73
Transmit Audio Equalization (EQ) .....	35	Front Panel and DSP.....	73
SPLIT and Cross-Mode Operation.....	36	KREF3 (Ref./2 <sup>nd</sup> LO).....	74
Extended Single Sideband (ESSB).....	36	KSYN3 (Synthesizer) .....	75
General-Coverage Receive .....	36	Firmware.....	75
VFO B Alternate Displays.....	36	K3 Block Diagram .....	76
Alarm and Auto Power-On.....	36	<b>Appendix A: Crystal Filter Installation.....</b>	<b>77</b>
Using the Sub Receiver.....	37	<b>Index.....</b>	<b>81</b>
Receive Antenna In/Out.....	39		

# A Note to K3 Owners

On behalf of our entire design team, we'd like to thank you for choosing the Elecraft K3 transceiver.

The K3—like its predecessor, the K2—reflects our desire to go beyond what other high-performance transceivers have offered. It isn't just a home-station rig; at about 8 to 9 pounds, it can accompany you wherever you go, whether it's out to your back porch or halfway around the world. And it's the only rig in its class that you can build yourself. Above all, we want the K3 to be ready for any operating situation you encounter, and to be more enjoyable to use than any transceiver you've ever owned.











In addition to this manual, you'll find much more information on the K3 on our web site, including operating tips, answers to frequently asked questions, and information on firmware upgrades and accessories.

73,

Wayne, N6KR  
Eric, WA6HHQ

---

## Key to Symbols and Text Styles

	<b>Important – read carefully</b>
	Operating tip
<b>LSB</b>	LCD icon or characters
	LED
	<b>Enter</b> keypad function
	<b>Tap</b> switch function (labeled <i>on</i> a switch)
	<b>Hold</b> switch function (labeled <i>below</i> a switch; hold for 1/2 sec. to activate)
 <b>SQL</b>	Rotary control without integral switch
 	<b>Tap</b> switch function of rotary control (labeled <i>above</i> a knob)
 	<b>Hold</b> switch function of rotary control (labeled <i>below</i> a knob; hold for 1/2 sec.)
<b>MAIN:VOX GN</b>	Typical MAIN menu entry
<b>CONFIG:KAT3</b>	Typical CONFIG menu entry





# Quick-Start Guide

To get started using your K3 right away, please read this page and the two that follow, trying each of the controls. The text uses braces to refer to numbered elements in the front- and rear-panel illustrations below. For example, {1} refers to ①, the mic jack. Later sections provide greater detail on all aspects of K3 operation.

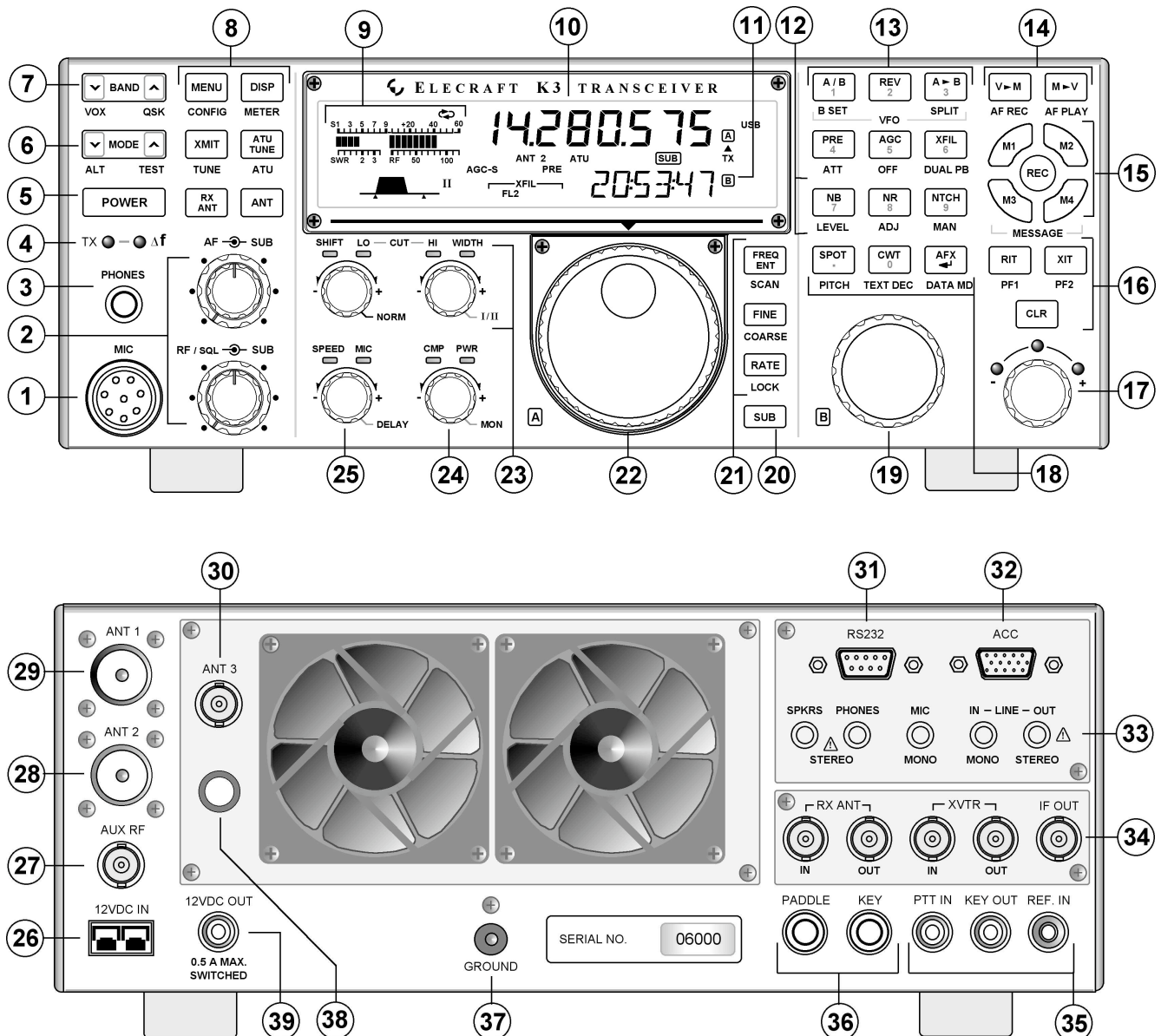
**⚠ The first thing you need to know about the K3** is that most switches have two functions. *Tap* (press briefly) to activate the function labeled *on* a switch. *Hold* to activate the function labeled *below* the switch. In the text, *tap* functions are shown like this: **MENU**. An example of a *hold* function is **CONFIG**. Additional typographical conventions are shown on the previous page.

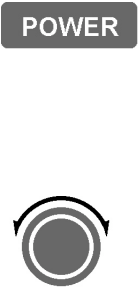
Try tapping **MENU** {8}. This brings up the **MAIN** menu. Rotating VFO B {19} selects menu entries, while rotating VFO A {22} changes their parameters. Tap **MENU** again to exit the menu.

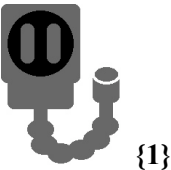
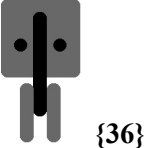

<p><b>Connections</b></p> 	<ul style="list-style-type: none"> <li>• Connect a power supply to the DC input jack {26} (see Specifications, pg. 8).</li> <li>• On the K3/100, a circuit breaker is provided on the fan panel for the 100-W stage {38}.</li> <li>• You can power an accessory device from the switched DC output jack {39} (0.5 A max).</li> <li>• Connect an antenna to ANT1 {29}. With an ATU (pg. 22), you can also use ANT2 {28}. AUX RF {27} is for the sub receiver; see pg. 17. ANT3 {30} is used with the internal 2-m module (K144XV). With a KXV3, you can connect an RX antenna to RX ANT IN {34}.</li> </ul>
<p><b>The Basics</b></p> 	<ul style="list-style-type: none"> <li>• Press <b>POWER</b> {5} to turn on the K3. If there are any error indications, refer to pg. 68.</li> <li>• <b>TAP</b> and <b>HOLD</b> Functions: <i>Tapping</i> briefly activates the function labeled <i>on</i> a switch. <i> Holding</i> for about 1/2 second activates the function labeled <i>below</i> a switch.</li> <li>• Tap either end of <b>BAND</b> {7} to select a band, and tap <b>MODE</b> {6} to select the mode. Set the AF gain using <b>AF</b> {2}. Set <b>RF</b> to max. <b>SUB</b> controls are discussed on pg. 37.</li> <li>• The large knob {22} controls VFO A (upper display, {10}). The medium knob {19} controls VFO B (lower display, {11}). VFO A is main RX/TX except in SPLIT (pg. 36).</li> <li>• <b>CMP / PWR</b> is one of four <b>multifunction controls</b> {24}. Each has two primary functions, indicated by green LEDs. The knob has a built-in switch; <i>tap</i> it to select either <b>CMP</b> (compression level) or <b>PWR</b> (power output). <i>Hold</i> the knob in to access its secondary function, <b>MON</b>itor level. Tap again to restore the primary function.</li> </ul>
<p><b>Filter Controls</b></p> 	<ul style="list-style-type: none"> <li>• Rotate the <b>SHIFT / LOCUT</b> and <b>HICUT / WIDTH</b> controls {23} to adjust the filter passband. Crystal filters <b>FL1-FL5</b> are automatically selected as you change the bandwidth. Tap either knob to alternate between shift/width and hicut/locut.</li> <li>• Hold <b>SHIFT / LOCUT</b> to <b>NORMAL</b>ize the bandwidth (e.g., 400 Hz CW, 2.8 kHz SSB).</li> <li>• Hold <b>HICUT / WIDTH</b> to alternate between two filter setups, <b>I</b> and <b>II</b> (per-mode).</li> <li>• Tap <b>XFIL</b> {13} to select crystal filters manually; this also removes any passband shift.</li> </ul>
<p><b>Voice Modes</b></p> 	<ul style="list-style-type: none"> <li>• Hold <b>METER</b> {8} to see <b>CMP / ALC</b> levels. While talking, set <b>MIC</b> {25} for 4-7 bars of ALC, and <b>CMP</b> for the desired compression. Then return to <b>SWR / PWR</b> (pg. 28).</li> <li>• <b>Optional:</b> Hold <b>TEST</b> {6} for TX TEST mode; allows off-air TX adjustments (pg. 13).</li> <li>• Hold <b>CMP / PWR</b> {24} to set speech <b>MON</b>itor level; tap to return to <b>CMP / PWR</b>.</li> <li>• Hold <b>VOX</b> {7} to select PTT or <b>VOX</b>. Hold <b>SPEED / MIC</b> to set <b>VOX DELAY</b>.</li> <li>• <b>Details:</b> VOX, pg. 29; TX EQ, pg. 35; <b>MIC SEL</b>, pg. 52; SSB/AM/FM, pg. 28.</li> </ul>
<p><b>CW Mode</b></p> 	<ul style="list-style-type: none"> <li>• <b>SPEED</b> {25} sets the CW keyer speed. Hold this knob to set semi-break-in <b>DELAY</b>. Hold <b>QSK</b> {7} to select full <b>QSK</b> (pg. 30.). Hold <b>VOX</b> {7} to select hit-the-key CW.</li> <li>• Hold <b>PITCH</b> {18} to set sidetone pitch. Hold <b>CMP / PWR</b> to set sidetone <b>MON</b> level.</li> <li>• Tap <b>CWT</b> {18} for tuning aid {9} (pg. 34). With <b>CWT</b> on, <b>SPOT</b> auto-spots (pg. 30).</li> <li>• To select CW text decode/display mode, hold <b>TEXT DEC</b> {18}; rotate VFO B (pg. 30).</li> <li>• CW keying is converted to DATA in <b>FSK D</b> and <b>PSK D</b> modes (below and pg. 34).</li> <li>• Hold <b>DUAL PB</b> {13} to turn on audio peaking (APF) or dual-passband filtering (pg. 30).</li> </ul>
<p><b>Data Modes</b></p> 	<ul style="list-style-type: none"> <li>• Tap <b>MODE</b> {6} until you see the <b>DATA</b> icon turn on (see Data Modes, pg. 31).</li> <li>• Hold <b>DATA MD</b> {18}. Use VFO B to select from: <b>DATA A</b> (PSK31 &amp; other soundcard-based modes), <b>AFSK A</b> (soundcard-based RTTY), <b>FSK D</b> (RTTY via data input or keyer), or <b>PSK D</b> (PSK via data input or keyer). VFO A selects data baud rate for internal encoder/decoder, if applicable. <b>DUAL PB</b> turns on RTTY filter (DTF, pg. 32).</li> <li>• Hold <b>PITCH</b> {18} to select mark tone and shift (for encoder/decoder and RTTY filter).</li> <li>• Hold <b>TEXT DEC</b> {18} to set up text decode. <b>CWT</b> shows tuning aid (pg. 34).</li> </ul>

<b>VFOs and RIT/XIT</b>	<ul style="list-style-type: none"> <li>• <b>RATE</b> {21} selects 10 or 50 Hz VFO/RIT tuning. See VFO menu entries, pg. 53.</li> <li>• <b>FINE</b> {21} selects 1-Hz steps. <b>COARSE</b> selects large steps (MAIN menu, <i>VFO CRS</i>).</li> <li>• Tap <b>FREQ ENT</b> {21} to enter frequency in MHz using numeric keypad &amp; decimal point. Tap return (↵) to complete the entry, or tap <b>FREQ ENT</b> again to cancel. (Pg. 15.)</li> <li>• Hold <b>SCAN</b> to start/stop scanning. <b>SCAN</b> must be preceded by a memory recall (pg. 40).</li> <li>• The <b>RIT</b> and <b>XIT</b> offset knob {17} has LEDs that show -/0/+ offset (pg.16). Tap <b>CLR</b> {16} to zero the offset. <b>Hold CLR</b> for &gt; 2 sec. to add the offset to VFO A, then zero it.</li> </ul>
<b>Transmit, ATU, and Antenna Controls</b>	<ul style="list-style-type: none"> <li>• The <b>TX</b> LED {4} indicates that the K3 is in transmit mode. The <math>\Delta f</math> LED turns on if the RX and TX frequencies are unequal (<b>SPLIT</b>, <b>RIT/XIT</b>, cross-mode, etc.). (Pg. 13.)</li> <li>• <b>XMIT</b> {8} is equivalent to PTT {35}. <b>TUNE</b> puts out full CW power in any mode.</li> <li>• <b>ATU TUNE</b> {8} initiates antenna matching (pg. 22). <b>ATU</b> enables or bypasses the ATU.</li> <li>• <b>ANT</b> selects <b>ANT1</b> or <b>ANT2</b>. <b>RX ANT</b> selects main or <b>RX</b> antenna (KXV3).</li> </ul>
<b>NB, NR, and Notch</b>	<ul style="list-style-type: none"> <li>• Tap <b>NB</b> {12} to enable DSP and I.F. noise blanking. Hold <b>LEVEL</b> to set DSP NB level (VFO A) and I.F. NB level (VFO B). Fully CCW is OFF in both cases. (Pg. 25.)</li> <li>• Tap <b>NR</b> {12} to turn on noise reduction (saved per-mode). Hold <b>ADJ</b> to tailor noise reduction for the present band conditions (pg. 25).</li> <li>• Tap <b>NTCH</b> {12} once to select auto-notch (<b>NTCH</b> icon), and a second time to select manual notch (adds ◀▶ icon). Hold <b>MAN</b> to adjust manual notch frequency. (Pg. 25.)</li> </ul>
<b>SPLIT, BSET, and SUB</b>	<ul style="list-style-type: none"> <li>• Hold <b>SPLIT</b> {13} to enter split mode (RX on VFO A, TX on VFO B). If VFOs A and B are on different frequencies in SPLIT mode, the Delta-F LED (<math>\Delta f</math>) will turn on (pg. 13).</li> <li>• Hold <b>BSET</b> {13} to adjust VFO B / sub RX settings independently of VFO A (pg. 37).</li> <li>• Tap <b>SUB</b> {20} to turn on the sub receiver (pg. 37). VFO B controls its frequency.</li> <li>• <b>Hold SUB</b> {20} to link the two VFOs (VFO A is then the master). A 2-second hold of <b>SUB</b> engages <i>diversity mode</i> (pg. 38). SPLIT operation is possible in diversity mode.</li> </ul>
<b>Memories, Messages, and DVR</b>	<ul style="list-style-type: none"> <li>• To store a frequency memory, tap <b>V ► M</b> {14}, then: tap <b>M1-M4</b> {15} to save a per-band quick memory; or tap <b>0-9</b> to save a general-purpose quick memory; or rotate VFO A to select from memories 0-99, then tap <b>V ► M</b> again to save. Tap <b>M ► V</b> to recall. (Pg. 16.)</li> <li>• <b>REC</b> and <b>M1-M4</b> {15} are also used to record &amp; play voice/CW/DATA messages. The KDVR3 option is required for voice messages and <b>AF REC</b> / <b>AF PLAY</b> (pg. 29).</li> </ul>
<b>Menus and Switch Macros</b>	<ul style="list-style-type: none"> <li>• <b>MENU</b> &amp; <b>CONFIG</b> {8} access the MAIN and CONFIG menus. VFO B selects entries; VFO A changes parameters. In general, CONFIG menu entries are used less often.</li> <li>• Tapping <b>DISP</b> {8} within menus shows information about each entry on VFO B (pg 52).</li> <li>• Menu entries can be assigned to programmable switches <b>PF1</b>, <b>PF2</b> {16} and <b>M1-M4</b> {15} (pg 52). These switches can also execute often-used <i>macros</i> like “SPLIT, A&gt;B, move VFO B up 5,” with a single tap or hold. See the <i>K3 Programmer’s Reference</i> for examples.</li> </ul>
<b>Other Features</b>	<ul style="list-style-type: none"> <li>• RX and TX EQ (MAIN menu) provide 8 bands of receive/transmit equalization (pg. 35).</li> <li>• Tap <b>AFX</b> {18} to enable the selected audio effect (see <i>CONFIG:AFX MD</i>, pg. 52).</li> <li>• Tap <b>DISP</b> {8} and use VFO B to show time, supply voltage, etc. on VFO B (pg. 36).</li> <li>• The ALARM function (<i>MAIN:ALARM</i> menu entry) can be used to remind you about a contest, net, or QSO schedule, and can even turn the K3 on at alarm time (pg. 36).</li> <li>• The KIO3 module provides a rich set of AF {33} and digital {32} I/O (pg. 17).</li> </ul>

# Introduction

This comprehensive manual covers all the features and capabilities of the Elecraft K3 transceiver. We recommend that you begin with the **Quick-Start Guide** (pg. 4). The **Front Panel** (pg. 11) and **Rear Panel** (pg. 17) sections are for general reference. **Basic Operation** (pg. 21) and **Advanced Operation** (pg. 33) fill in the details.

**A** Anytime you add new filters or options, refer to **Configuration** (pg. 46).

## K3 Features

The K3 offers a number of advanced features to enhance performance and versatility:

### *Receiver*

- Up to five crystal roofing filters with bandwidths as narrow as 200 Hz (pg. 23)
- High-performance, fully independent sub receiver, also with up to five crystal filters, allows true diversity receive with two antennas (pg. 37)
- Variable-bandwidth crystal filters that track DSP filter settings
- Narrow ham-band front-end filters, plus wider band-pass filters for general-coverage receive (pg. 45)

### *DSP*

- 32-bit I.F. DSP for advanced signal processing, including full stereo and other binaural effects (pg. 35)
- Passband tuning and programmable DSP/crystal filter presets (pg. 14)
- 8-band transmit and receive EQ (graphic equalization) (pg. 35)
- Versatile digital voice recorder (DVR) for incoming/outgoing audio streams (pg. 29)

### *CW and Digital Modes*

- Built-in digital-mode demodulation with text displayed on the K3's LCD (CW, RTTY, PSK31) (pg. 33)

- APF (audio peaking filter) for digging out weak signals in CW mode (pg. 30)
- Internal CW-to-RTTY or CW-to-PSK31 encoding for casual digital-mode QSOs without a computer (pg. 34)
- CW decoded and displayed as you send – great for improving CW skills (pg. 33)
- Automatic CW/data signal spotting and manual fine-tuning display (pg. 30)

### *User Interface*

- Dual VFOs with independent modes, bands, and filter settings (pg. 14)
- 100 memories with alphanumeric labels, plus 4 quick-memories per band (pg. 16)
- Dedicated message play controls for use in CW, data, and voice modes (pg. 30)
- Real-time clock/calendar with alarm and automatic power-on (pg. 36)
- Utility displays show voltage, current drain, RIT/XIT offset, front panel temperature, PA heatsink temperature, etc. (pg. 36)
- Built-in help menu help text (pg. 21)
- Programmable switch “macros” to automate often-used operations (pg. 44)
- Custom “sign-on banner” can be displayed on power-up (via the **K3 Utility** program)

### *Connectivity*

- Enhanced remote control (pg. 44)
- Firmware upgrades via the Internet (pg. 45)
- Isolated PC audio input/outputs (pg. 17)
- Front and rear mic and headphone jacks
- Full stereo audio with two speaker outputs

### *Options and Accessories (pg. 45)*

- ATU, sub receiver, digital voice recorder, 100-W PA, 2-meter module, external reference lock, and other internal options
- KPA500 amplifier, P3 Panadapter, PR6 six-meter preamp and other accessories

## Specifications

**A** Some specifications apply only if the corresponding option modules are installed (see *Options*, pg. 45).

### GENERAL

<b>Frequency Range</b>	Main and Sub Receivers, 490 kHz - 30 MHz and 44-54 MHz. Transmitter: Amateur bands between 1.8 and 54 MHz (varies by country). 144-148 MHz with K144XV option.  MARS coverage on request (excluding transmit from 7.550-8.999 MHz at 13 W and higher, and 7.650-8.999 MHz at 12 W or lower).
<b>Tuning Step Sizes</b>	1, 10, 20, and 50 Hz fine steps; user-configurable coarse tuning steps (per-mode). Direct keypad frequency entry in either MHz or kHz.
<b>Memories</b>	100 general purpose, plus 4 scratch-pad memories per band
<b>Frequency Stability</b>	+/- 5 ppm (0-50 C) TCXO standard; +/- 1 ppm TCXO opt. (+/- 0.5 PPM typ., 0-50 C). K3EXREF option locks TCXO to an external 10-MHz reference (+/- 1 to 2 Hz typ.).
<b>Antenna Jacks</b>	50 ohms nominal. One SO-239 supplied (2nd SO-239 jack supplied with KAT3 ATU). BNC jacks for RX antenna in/out and transverter in/out (KXV3 Option).
<b>Modes</b>	USB, LSB, AM, FM, CW, DATA (FSK D [direct], AFSK A [Audio], PSK D [Direct] and DATA A [Audio]; PSK). Built in PSK, RTTY, and CW text decode/display.
<b>VFOs</b>	Dual VFOs (A and B) with separate weighted tuning knobs
<b>Remote Control Port</b>	EIA-232 standard DE-9F; USB adapter option. Full control of all radio functions.
<b>Audio I/O</b>	Line-level isolated TX/RX audio interface (stereo outputs); front (1/4") and rear (1/8") stereo headphone jacks; stereo speaker jack.
<b>Transverter Interface</b>	Transmit, 0 dBm typ.; BNC in/out connectors on KXV3 option module. KXV3A (updated KXV3) includes connectors for K144XV internal 2-meter module.
<b>Buffered IF output</b>	BNC connector (KXV3 Option); see pg. 39 for interface recommendations.
<b>Other I/O</b>	Key/Keyer/Computer, Paddle, PTT In, and KEY Out. Band information output via binary interface and AUXBUS on ACC connector.
<b>Real-Time Clock/Calendar</b>	Accuracy: Approx. +/- 20 ppm (+/- 2 seconds/day). U.S. and E.U. date formats. Battery: 3 V coin cell (see pg. 48 for replacement instructions).
<b>Supply Voltage and Current</b>	13.8 V nominal (11 V min, 15 V max). 17-22 A typical in TX for K3/100, 3-4 A typical in TX for K3/10. 0.9A typical RX (less sub receiver). When using reduced supply voltage (< 12 V), power output should be reduced (e.g. 70 W at 11 V). <b>Recommended supply:</b> 13.8VDC @ 25A, continuous duty for K3/100; 13.8VDC @ 6A for K3/10. For best results, use the supplied 5 foot (1.53 m) power cable. When a battery is used, both sides of the battery cable should be protected by fast-blow fuses.
<b>Accessory DC output</b>	Switched, 0.5 A max; 13 V no-load, 12 V max load (@ Vsupply = 13.8 V)
<b>Weight (K3/100)</b>	Approx. 8.5 lbs. (3.8 kg). With KRX3 sub receiver option, 9.5 lbs. (4.3 kg).
<b>Size</b>	Enclosure only, 4.0 x 10.7 x 10.0 in., HWD (10.2 x 27.2 x 25.4 cm). With projections, 4.4 x 11.1 x 11.8 in. (11.2 x 28.2 x 30.0 cm).



## **RECEIVER (Main and Sub)\***

<b>Sensitivity (MDS)</b>	-136 to -138 dBm (typ.), preamp on, 500 Hz bandwidth. 6 m MDS with PR6 option: -143 to -144 dBm (typ.). Reduced sensitivity near 8.2 MHz (first I.F.) and from 44-49.5 MHz. Sensitivity decreases gradually below 1.8 MHz due to intentional high-pass response at the T-R switch. (Use RX ANT input or sub receiver's AUX input to avoid the high-pass filter loss.) <b>Note:</b> KBPF3 option required for full general coverage (including 0.49 to 1.7 MHz).
<b>Dynamic Range</b>	IMD3 > 100 dB, Blocking 140 dB, typical (at 5, 10, and 20 kHz spacing)
<b>Image and I.F. Rejection</b>	> 70 dB
<b>Audio Output</b>	2.5 W per channel into 4 ohms; typ. 10% THD @ 1 kHz, 2 W
<b>S-Meter</b>	Nom. S9 = 50 $\mu$ V, preamp on; user-adjustable
<b>Noise Blanker</b>	Adjustable, multi-threshold/multi-width hardware blanker plus DSP blanker
<b>Receive AF graphic EQ</b>	+/- 16 dB/octave, 8 bands
<b>Filter Controls</b>	IF Shift/Width & Lo/High Cut with automatic crystal filter selection

\* **Receive specifications are guaranteed only within ham bands.** Dynamic range measurements based on 400-Hz, 8-pole filter. Other available filters have very similar performance; see [www.elecraft.com](http://www.elecraft.com) for full list.

## **TRANSMITTER \***

<b>Output Power</b>	K3/100: 0.1 W –100 W typ. Suggested max from 51-52 MHz, 85 W; 52-54, 70 W. K3/10 (or K3/100 with PA bypassed): 0.1 W –12 W, HF-10 m; 8 W max on 6 m. XVTR OUT (KXV3 option): -10 to +1.8 dBm. K144XV: ~10 W, 144-148 MHz.  <b>Note:</b> Output can be set up to 110 W. However, IMD and spurious products are specified at 100 W, the recommended max. If a KAT3 ATU is installed, actual output will be slightly lower (typ. loss < 0.5 dB below 28 MHz, < 0.8 dB above).
<b>Duty Cycle</b>	CW and SSB modes, 100% 10-min. 100W key-down at 25 C ambient
<b>True RF Speech Processor</b>	Adjustable compression
<b>Transmit AF graphic EQ</b>	+/- 16 dB/octave, 8 bands
<b>SSB TX Bandwidth</b>	4 kHz max (> 2.8 kHz requires 6 kHz AM filter)
<b>SSB TX Monitor</b>	Post-DSP filtering/processing
<b>VOX</b>	DSP-controlled, adjustable threshold, delay, and anti-VOX
<b>Full and Semi CW Break-In</b>	Adjustable delay; diode T/R Switching
<b>SSB Carrier Suppression</b>	> 50 dB
<b>Harmonic / Spurious Outputs</b>	> 50 dB below carrier @ 100W (> 60 dB on 6 meters)
<b>CW Offset/Sidetone</b>	300-800 Hz, adjustable (filter center frequency tracks sidetone pitch)
<b>Mic Connector</b>	Front panel, 8 pin; rear panel 3.5 mm. Switchable DC bias ( <i>MAIN:MIC SEL</i> )

\* **Transmit specifications are guaranteed only within ham bands.**

## Customer Service and Support

### *Technical Assistance*

You can send e-mail to [k3support@elecraft.com](mailto:k3support@elecraft.com) and we will respond quickly – typically the same day Monday through Friday. If you need replacement parts, send an e-mail to [parts@elecraft.com](mailto:parts@elecraft.com). Telephone assistance is available from 9 A.M. to 5 P.M. Pacific time (weekdays only) at 831-763-4211. Please use e-mail rather than calling when possible since this gives us a written record of the details of your problem and allows us to handle a larger number of requests each day.

### *Repair / Alignment Service*

If necessary, you may return your Elecraft product to us for repair or alignment. (Note: We offer unlimited email and phone support, so please try that route first as we can usually help you find the problem quickly.)

**IMPORTANT: You must contact Elecraft before mailing your product** to obtain authorization for the return, what address to ship it to and current information on repair fees and turn around times. (Frequently we can determine the cause of your problem and save you the trouble of shipping it back to us.) Our repair location is different from our factory location in Aptos. We will give you the address to ship your kit to at the time of repair authorization. *Packages shipped to Aptos without authorization will incur an additional shipping charge for reshipment from Aptos to our repair depot.*

### **Elecraft 1-Year Limited Warranty**

This warranty is effective as of the date of first consumer purchase (or if shipped from the factory, the date the product is shipped to the customer). It covers both our kits and fully assembled products. For kits, before requesting warranty service, you should fully complete the assembly, carefully following all instructions in the manual.

**Who is covered:** This warranty covers the original owner of the Elecraft product as disclosed to Elecraft at the time of order. Elecraft products transferred by the purchaser to a third party, either by sale, gift, or other method, who is not disclosed to Elecraft at the time of original order, are not covered by this warranty. If the Elecraft product is being bought indirectly for a third party, the third party's name and address must be provided at time of order to ensure warranty coverage.

**What is covered:** During the first year after date of purchase, Elecraft will replace defective or missing parts free of charge (post-paid). We will also correct any malfunction to kits or assembled units caused by defective parts and materials. Purchaser pays inbound shipping to us for warranty repair; we pay shipping to return the repaired equipment to you by UPS ground service or equivalent to the continental USA and Canada. For Alaska, Hawaii, and other destinations outside the U.S. and Canada, actual return shipping cost is paid by the owner.

**What is not covered:** This warranty does not cover correction of kit assembly errors. It also does not cover misalignment; repair of damage caused by misuse, negligence, or builder modifications; or any performance malfunctions involving non-Elecraft accessory equipment. The use of acid-core solder, water-soluble flux solder, or any corrosive or conductive flux or solvent will void this warranty in its entirety. Also not covered is reimbursement for loss of use, inconvenience, customer assembly or alignment time, or cost of unauthorized service.

**Limitation of incidental or consequential damages:** This warranty does not extend to non-Elecraft equipment or components used in conjunction with our products. Any such repair or replacement is the responsibility of the customer. Elecraft will not be liable for any special, indirect, incidental or consequential damages, including but not limited to any loss of business or profits.

# Front Panel

This reference section describes all front panel controls, the liquid crystal display (LCD), LEDs, and connectors. Operating instructions are covered in later sections.

## Control Groups

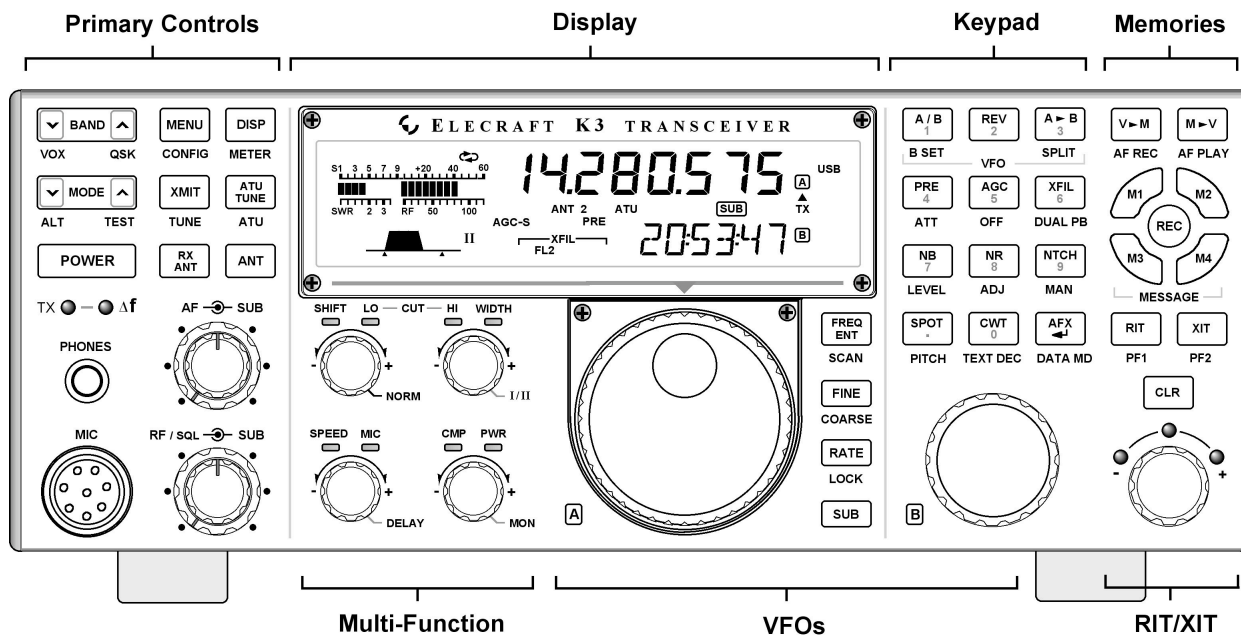

**Primary Controls (pg 13):** These controls provide basic transceiver setup, including power on/off, band, operating mode, AF and RF gain and squelch, ATU and transmit controls, display modes, and menus.

**Display (pg 12):** The LCD shows signal levels, VFO A and B frequencies, filter bandwidth, operating mode, and the status of many controls. The VFO B display is alphanumeric, so it can show decoded text from digital modes (CW, RTTY, PSK31), as well as menus, time and date, help messages, etc.

**Multi-Function Controls (pg. 14):** The upper two knobs set up receiver DSP filtering. The lower two control transmit parameters, including keyer speed, mic gain, speech compression, and power output level. LEDs above each knob show which function is active; tapping the knob alternates between them. Pressing and holding these knobs (1/2 second or longer) provides access to secondary functions.

**Keypad (pg. 15):** This group of switches is numbered for use during memory store/recall and direct frequency entry, but each switch also has normal tap and hold functions. The upper row of switches are VFO controls. The remaining rows control receive-mode and miscellaneous functions, such as noise reduction and text decode/display.

**Memories (pg. 16):** These switches control frequency memory store/recall, message record/play, and audio record/playback (with the DVR). **M1-M4** can also be used as up to eight tap/hold programmable function switches.

**VFOs (pg. 14):** The large knob controls VFO A; the smaller knob controls VFO B. The four switches between the VFO knobs select tuning rates and control related functions.

**RIT/XIT (pg. 16):** Three switches control RIT and XIT on/off and clear (offset zero). The knob below the **RIT/XIT** switches selects the offset.

## Display (LCD)

**Multi-character displays:** The 7-segment display (upper) shows the VFO A frequency. The 13-segment display (lower) shows VFO B or text.

**Bar graph, receive mode:** The bar graph normally acts as an S-meter. If **CWT** is turned on, the right half of the S-meter becomes a tuning aid (pg. 34).

**Bar graph, transmit mode:** The bar graph normally shows **SWR** and **RF** power output. The **RF** scale will be either **5** and **10** (low power) or **50** and **100** (high power). In voice and data modes, transmit scales can be changed to compression (**CMP**) and **ALC** using **METER**.

**VFO Icons:** The **TX** icon indicates which VFO is selected for transmit. In TX TEST mode, or when TX is inhibited externally, **TX** flashes (see **TEST**).  
 Shows that VFO A or B is locked (see **LOCK**).



VFO A is the transmit VFO



VFO B is the transmit VFO; see **SPLIT**

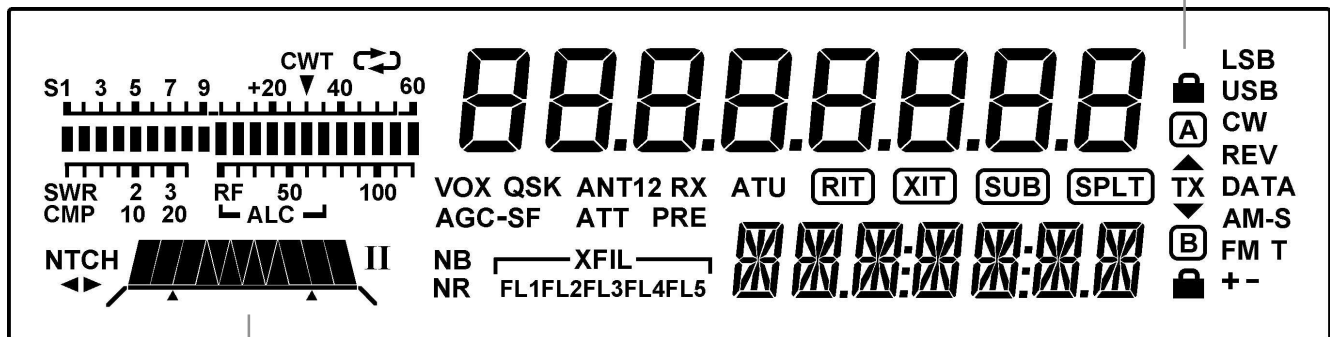

**Filter Graphic:** This shows the approx. bandwidth and position of the receiver's I.F. passband. See **Filter Passband Controls**, pg. 23.

### Filter Icons:

**NTCH** Notch filtering on (**NTCH**, pg. 25)

 Manual notch (**MAN**, pg. 25)

**I / II** Shows selected preset (**I/II**, pg. 14)

**XFIL** Crystal filter selection (**FL1-FL5**)

### Mode Icons:

Basic modes (**LSB / USB**, **CW**, **DATA**, **AM**, or **FM**) are selected by tapping either end (Up/Down) of **MODE**. Alternate modes (**CW REV**, **DATA REV**, **AM-S**, **FM +/-**) are selected by holding **ALT**. **LSB** and **USB** are alternates of each other. **+** icon on in SSB modes indicates ESSB (pg. 36).

**T** indicates FM/tone, CW/DATA text decode, or AM-Sync auto-tracking.

### Other Icons:

**CWT** CW/data tuning aid on (**CWT**, pg. 34)

 DVR in use (**AF REC / AF PLAY**, pg. 16)

**VOX** VOX enabled (**VOX**, pg. 13)

**QSK** Full break-in CW enabled (**QSK**, pg. 30)

**NB** Noise blanker on (**NB**, pg. 15)

**NR** Noise reduction on (**NR**, pg. 15)

**ANT** Antenna 1 or 2 (**ANT**, pg. 13)

**RX** RX antenna in use (**RX ANT**, pg. 13)

**ATT** Attenuator on (**ATT**, pg. 15)

**PRE** Preamp on (**PRE**, pg. 15)

**ATU** ATU enabled (**ATU**, pg. 13)

**RIT** RIT on (**RIT**, pg. 16)

**XIT** XIT on (**XIT**, pg. 16)

**SUB** Sub receiver on (**SUB**, pg. 37)

**SPLT** Split mode in effect (**SPLIT**, pg. 36)

## LEDs

- **TX [Red]** Turns on in transmit mode.
- **Δ F [Yellow]** The **Delta-F** LED turns on if transmit and receive frequencies or modes are different due to the use of SPLIT, RIT, or XIT.
- ▢ **[Green]** Eight LEDs show which functions are in effect for the **Multifunction Controls** (pg. 14).
- (-) ● ● ● (+) **RIT/XIT OFFSET** If the offset control is centered, or you tap **CLR**, the **green** LED turns on (offset = 0). Otherwise, the **yellow** (-) or (+) LED will be on, indicating the direction of the offset. See **RIT**, **XIT**, and **CLR**.

## Front Panel Connectors

**PHONES** You can use either mono or stereo headphones at either the front- or rear-panel headphone jack. Also see **AFX** (pg. 35).

**MIC** An Elecraft MH2, MD2, Proset-K2, or other compatible mic can be used (see pinout below). To select the front- or rear-panel mic, and to turn bias on/off, use the **MAIN:MIC SEL** menu entry.

**Bias** must be turned **on** for electret mics (e.g. MH2, MD2, Proset). It must be **off** for dynamic mics (e.g. Heil mics using HC4 or HC5 elements).

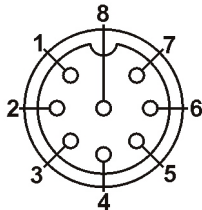

Mic jack, viewed from front of K3

- 1 Mic audio, low-Z (~600 ohms)
- 2 PTT
- 3 DOWN button \*
- 4 UP button \*
- 5 FUNCTION button \*
- 6 8V (10 mA max)
- 7, 8 Ground

\* See **CONFIG:MIC BTN** menu entry.

**FP ACC** This connector (RJ-45, 6 pins) is located on the bottom of the transceiver, near the VFO B knob. It is used with accessory devices.

## Primary Controls

**BAND** Tap left/right end to move among ham bands. **CONFIG:BND MAP** disables bands. For “quick” band switching, see **CONFIG:MEM 0-9**.

**VOX** Selects voice-operated or CW keying-operated transmit (**VOX** icon on), or PTT (**VOX** icon off). Also see **DELAY** (pg. 30) and CW VOX auto-off control (**CONFIG:CW WGHT**).

**QSK** Selects either full break-in (**QSK** icon on) or semi break-in keying, if VOX is selected in CW mode. Also see **DELAY** (pg.30).

**MODE** Tap the left or right end of this switch to select the operating mode. When **DATA** is selected, the **DATA MD** switch is used to specify DATA-A, AFSK A, FSK D, or PSK D (pg. 31).

**ALT** In **LSB** mode, switches to **USB** (and vice-versa). Also selects alternate modes, including: **CW REV**, **DATA REV**, and **AM-S** (pg. 29). In **FM** mode, selects +/- or simplex (pg. 29).

**TEST** Selects TX TEST (**TX** LCD icon flashing); allows key/mic test without actually transmitting.

**POWER** Turns the K3 on or off. **Note: To ensure correct save of operating parameters, turn the K3 off before turning the power supply off.**

**MENU** Displays MAIN menu (pg. 21).

**CONFIG** Displays the CONFIG menu (pg. 21).

**XMIT** Manually-operated transmit. Places the K3 into transmit mode (same as PTT, pg. 26).

**TUNE** Puts out a carrier at the present power level. Also **TUNE Power Level** (pg. 27).

**RX ANT** Enables the receive antenna (pg. 22). If the sub RX is on, **holding RX ANT** alternates between the sub’s **MAIN / AUX** antennas (pg. 37).

**DISP** Shows an alternate display on VFO B, such as time, date, voltage, etc. (pg. 36).

**METER** Selects voice transmit bar graph modes: **SWR** and **RF**, or **CMP** and **ALC** (pg. 28).

**ATU TUNE** Matches the antenna (transmitting at up to 10 W) using the KAT3 ATU (pg. 22).

**ATU** Puts the ATU into normal mode (**ATU** icon on) or bypass mode (pg. 22).

**ANT** Selects **ANT 1** or **2**. In BSET mode with the sub receiver on, selects **MAIN** or **AUX** antenna for the sub receiver (pg. 37).

## Dual-Concentric Potentiometers

☉ **AF — SUB** AF gain controls for main receiver (inner, or smaller knob) and sub receiver (outer ring, or larger knob).

☉ **RF / sQL — SUB** RF gain (and/or squelch) controls for main and sub receiver.

Two menu entries are provided to control squelch directly: *CONFIG:SQ MAIN*, and *SQ SUB*. They can also be used to reconfigure the RF gain controls as squelch for either receiver, and to select FM-only or all-mode squelch. See **Config Menu** (pg. 53).

## Multi-Function Controls

The upper two multi-function controls set up receiver filtering. The lower two controls adjust transmit settings. Each control has two primary functions (white labels) and a secondary function (yellow). **Tap** a control knob to alternate between its primary functions, indicated by two LEDs. **Hold** a knob (~1/2 second or longer) to select its secondary function.

### Filter Controls

The primary functions of the filter controls are:

- ☉ **SHIFT** Shift passband either direction
- ☉ **LO CUT** Adjust low-frequency response
- ☉ **HI CUT** Adjust high-frequency response
- ☉ **WIDTH** Adjust width of the passband

As these settings change, so does the filter graphic. Crystal filters are selected automatically (or manually using **XFIL**, pg. 15). Also see **Filter Passband Controls** (pg. 23).

The secondary functions of these controls are:

**NORM** Normalize passband

Normalizing the passband sets the bandwidth to a fixed, per-mode value (e.g. 400 Hz in CW mode) and centers the passband. (Also see user-defined normal settings, **NORM1/2**, pg. 24.)

**I/II** Select preset **I** or **II** (per mode)

Presets **I** and **II** each hold a continuously-updated DSP/crystal filter setup (pg. 24).

## Transmit Controls

The primary functions of the transmit controls are:

- ☉ **SPEED** Keyer speed in WPM, 8-50 (8-100 if *CONFIG:CW QRQ* is **ON**)
- ☉ **MIC** Mic gain
- ☉ **CMP** Speech compression level
- ☉ **PWR** RF output power in watts (pg. 26)

The present transmit mode determines which primary functions normally apply; for example, in CW mode, the ☉ **SPEED** / **MIC** control defaults to **SPEED**. You can always tap a knob to override the present selection.

The secondary functions of these controls are:

- ☉ **DELAY** VOX delay (voice/data) or CW semi-break-in delay, in seconds
- ☉ **MON** Voice or data monitor level or CW/data sidetone level

**i** You can optionally **LOCK** the **MIC**, **CMP**, and **PWR** control settings; see *CONFIG:PWR SET*.

## VFO Tuning Controls

VFO A controls the upper frequency display. This is normally the RX and TX frequency. In **SPLIT** mode, VFO B controls the transmit frequency (pg. 36). VFO B also controls the sub receiver (pg. 37).

The controls to the right of VFO A include:

**FREQ ENT** Direct frequency entry (pg. 15)

**SCAN** Start or stop scanning (pg. 40)

**FINE** Select 1 Hz tuning for both VFOs and RIT/XIT offset

**COARSE** Select coarse tuning rate (pg. 22)

**RATE** Select one of two normal tuning rates (10/50 or 10/20 Hz; pg. 22)

**LOCK** Lock VFO A (use **BSET** to lock B)

**SUB** **Tap** to turn sub RX on/off (pg. 37). **Hold** to link/unlink VFO A and B on the present band (pg. 37). A **long hold** (2 seconds or longer) enters diversity mode (pg. 38).

**i** VFO A can optionally be coarse-tuned using the RIT/XIT offset control if both **RIT** and **XIT** are off. See *CONFIG:VFO OFS*.

## Direct Frequency Entry

To jump to any frequency within the tuning range of the K3, tap **FREQ ENT**, then enter 1 to 3 MHz digits, a decimal point, and 0 to 3 kHz digits. Follow this with **Enter** (**↵**) to accept or **FREQ ENT** to cancel. The decimal point is optional if no kHz digits are entered, making it very easy to get to the low end of most ham bands.

### Examples:

1.825 MHz: **FREQ ENT** 1 . 8 2 5 **↵**

1.000 MHz: **FREQ ENT** 1 **↵**

50.100 MHz: **FREQ ENT** 5 0 . 1 **↵**

**i** If four or more digits are entered without a decimal point, a value in kHz is assumed.

## Keypad

Keypad switches have the tap and hold functions listed below. They are also used for selecting quick memories 0-9, and for direct frequency entry.

### VFO Controls (Upper row)

The upper row of numeric keypad switches is used to set up VFOs A and B. Their functions are:

<b>A / B</b>	Exchange VFO A and B contents
<b>BSET</b>	Set up VFO B and sub RX (see below)
<b>REV</b>	Exchange VFO A and B temporarily (repeater RX/TX swap in FM-RPT)
<b>A ► B</b>	Copy VFO A frequency to VFO B; tapping twice copies all other settings (also see <i>CONFIG:VFO B-&gt;A</i> )
<b>SPLIT</b>	Enable SPLIT receive/transmit

**i** If **cross-mode** operation is not allowed for the present VFO A and B modes, you'll see **SPL N/A** if you try to enable SPLIT. If cross-mode operation is allowed, the mode icon for VFO B will flash as a warning. Tap any switch to cancel the flash.

Holding **BSET** allows VFO B (and the sub receiver, if on) to be set up directly (pg. 37). As long as **BSET** is displayed, all VFO-related controls and display elements apply to VFO B. An alternative is to exchange VFOs with **A / B**, set up VFO A, then exchange them again.

### Receiver Control & Misc. (Lower Rows)

**!** Receiver control functions normally apply to VFO A/main receiver. If **BSET** is in effect, they apply to VFO B (and the sub receiver if turned on).

<b>PRE</b>	Preamp on/off (6 m: see <b>PR6</b> , pg. 45)
<b>ATT</b>	Attenuator on/off
<b>AGC</b>	AGC slow/fast (also see <i>CONFIG:AGC DCY</i> , <i>AGC HLD</i> , and other AGC menu entries)
<b>OFF</b>	AGC off/on (when off, an AF limiter is available; see <i>CONFIG:AF LIM</i> )
<b>XFIL</b>	Select next available crystal filter (see <i>CONFIG:FLX ON</i> )
<b>DUAL PB</b>	CW: APF or Dual-passband filtering (see <i>CONFIG:DUAL PB</i> ); RTTY: dual-tone filtering (pg. 30)
<b>NB</b>	Noise blanker on/off (pg. 25)
<b>LEVEL</b>	Noise blanker levels (pg. 25); use VFO A knob to setup DSP blanker, and VFO B to setup I.F. blanker
<b>NR</b>	Noise reduction on/off (pg. 25)
<b>ADJ</b>	Noise reduction parameter adjust; use VFO B knob (pg. 25)
<b>NTCH</b>	Notch filter auto/manual/off (pg. 25)
<b>MAN</b>	Manual notch frequency (pg. 25); use VFO B knob
<b>SPOT</b>	Spot tone on/off (manual), or auto-spot (if CWT is on; pg. 34)
<b>PITCH</b>	CW sidetone <b>PITCH</b> , PSK center pitch, FSK / AFSK MARK tone and shift (pg. 31), or FM tone setup (pg. 29)
<b>CWT</b>	CW/data tuning aid on/off (pg. 34); turn on to use auto-spot
<b>TEXT DEC</b>	<b>Text decode</b> , CW or DATA (pg. 33); use VFO B knob to select mode
<b>AFX</b>	Audio effects on/off (pg. 35); use <i>CONFIG:AFX MD</i> to set mode
<b>DATA MD</b>	DATA mode selection (pg. 31); use VFO B knob

## Memory Controls

### Frequency Memories

The K3 has 100 general-purpose memories (00-99), plus per-band memories (M1-M4 on each band). Each memory holds VFO A and B frequencies, modes, filter presets, antenna selection, and other settings. Each can have a text label of up to 5 characters (A-Z, 0-9, and various symbols).

**i** The **K3 Memory Editor** software application can be used to simplify setup and use of memories. Refer to our K3 software web page for details.

#### To store a general-purpose memory (00-99):

First tap **V ► M** (VFO to Memory), then locate the desired memory using the VFO A knob. The VFO A frequencies stored in each memory will be shown as you scroll through them. When you reach the desired memory number, tap **V ► M** again to store, or tap **M ► V** to cancel the operation.

#### To recall a general-purpose memory: Tap

**M ► V**, then select memory **00-99** using VFO A. Tap **M ► V** again to exit.

Memories 00-09 are **quick memories**, accessible with just two switch taps. These could be used to get to a starting point in each of 10 ham bands. Memories **M1** – **M4** are **per-band quick memories**. For example, you might set up **M1** for each band's CW segment, **M2** for the SSB segment, etc.

**i** **Memories 00-09 can act as if they were band switches; see CONFIG:MEM 0-9.**

**To store or recall quick memories:** Tap **V ► M** or **M ► V** as before, but instead of rotating VFO A, tap **0 - 9** or **M1 - M4**.

**To erase one or more memories:** While scrolling through memories to save or recall, tap **CLR**. Not applicable to per-band quick memories (**M1-M4**).

**To add or change a memory's text label:** First tap **M ► V**, then select a memory (**00-99**) using VFO A. Next, rotate VFO B to select each label position in turn as indicated by the flashing cursor. Use VFO A to change characters. After editing, tap **M ► V** again. (Labels can be edited at any time, including when you initially store a memory using **V ► M**.)

**i** **Adding an asterisk (\*) at the start of a label designates a channel-hopping memory** (pg. 40).

## Digital Voice/Audio Recorder (KDVR3)

The DVR can continuously record receive audio (up to 90 seconds). To start/stop audio record, hold **AF REC**. To start/stop playback, hold **AF PLAY**. The  icon flashes during DVR use.

Playback position (0-90 sec.) is shown on the VFO B display; "\*" appears if you're within the most recent segment. Use VFO B to change the position.

For DVR voice message record/play, see pg. 29.

## Message Record/Play Controls

Five switches provide record and playback of outgoing messages: **M1**, **M2**, **M3**, **M4** and **REC**. These switches provide single-tap play, hold-to-repeat, and other functions that are convenient for contests and for sending often-repeated text or voice messages during QSOs. CW messages can be viewed and edited using **K3 Utility**, if desired.

For details on CW message record/play, see pg. 30. The same messages can be used with CW-to-DATA (pg. 34). For voice message record/play, see **Digital Voice Recorder** (pg. 29).

**i** **M1** through **M4** can alternatively be used as tap or hold programmable function switches (pg. 21).

## RIT and XIT Controls

- RIT** RIT (receive incremental tuning) on/off.
- PF1** Programmable function switch (pg. 21)
- XIT** XIT (transmit incremental tuning) on/off.
- PF2** Programmable function switch (pg. 21)
- CLR** Sets RIT/XIT offset to 0. Hold for 2 seconds to copy present RIT offset to VFO A before clearing.

The RIT/XIT offset control sets the offset for **RIT** and **XIT**. Three LEDs above the control show at a glance whether an offset is in effect (pg. 11).

**i** If **CONFIG:RIT CLR** is set to **UNDO ON**, tapping **CLR** will alternate between **0.00** and the last non-zero offset selected, if any.



# Rear Panel

## Connector Groups

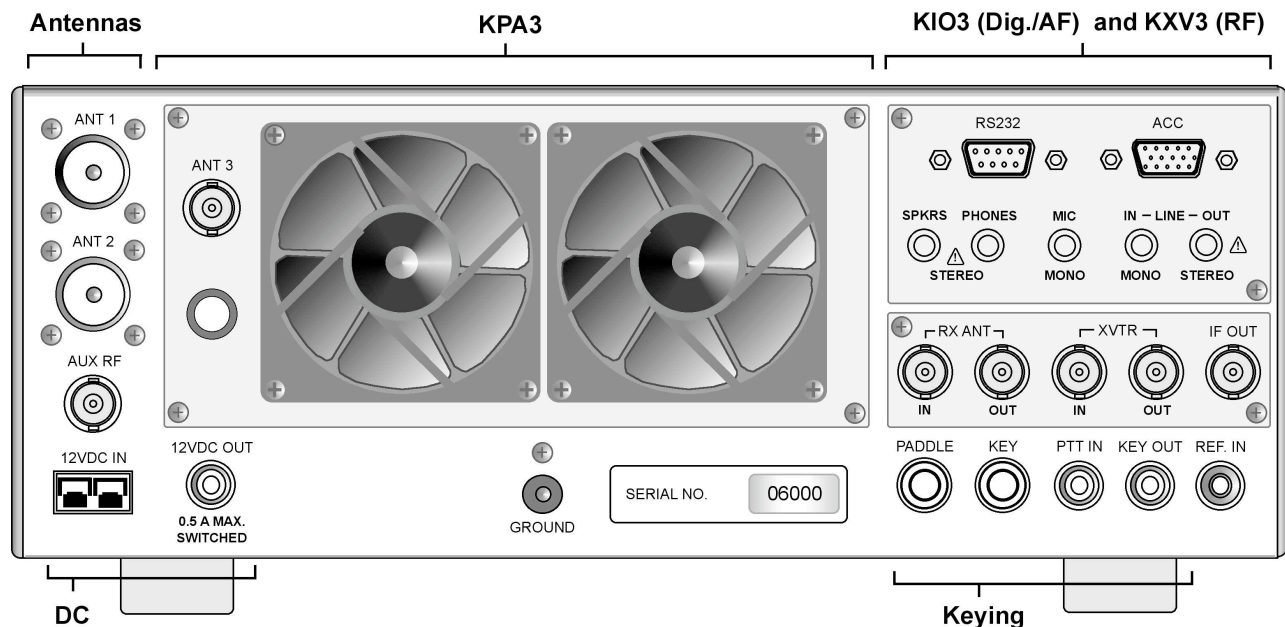

**A** The appearance of your rear panel may vary depending upon the options installed.

**Antennas:** **ANT1** (SO-239) is standard. **ANT2** (SO-239) is supplied with the KAT3 ATU option, which includes an antenna switch controlled from the front panel. Both jacks are nominally 50 ohms when the ATU is bypassed. **AUX RF** (BNC) is for use with the KRX3 option; see pg. 37 and pg. 41. **ANT3** (BNC, on the KPA3 option panel) is the antenna jack for the optional K144XV 2-m module.

**DC:** **12 VDC IN** jack is an Anderson PowerPole connector rated at 30 amps. (See *Specifications*, pg. 8, for detailed power requirements.)

**12 VDC OUT** (RCA/Phono) provides up to 0.5 A (switched) for use with accessory devices.

**Ground Terminal:** A good station ground is important for safety and to minimize local RFI.

**KPA3:** This option panel is blank in the K3/10 except for **ANT3** (see above). In the K3/100, the blank panel is replaced with the fan panel shown, which includes a **circuit breaker**.

**KIO3 (pg. 18):** The KIO3 is an upgradeable digital and audio I/O module providing computer and auxiliary control signals, single or dual (stereo) speaker outputs, line level in (mono) / out (stereo), and supplemental headphone (stereo) and mic jacks.

**KXV3:** The KXV3 provides a variety of RF I/O signals, including receive antenna in/out (pg. 41), transverter in/out (pg. 39), and a buffered I.F. output for use with panadapters such as the Elecraft P3 (pg. 45). The **KXV3A** also includes internal IF connections for the **K144XV** 2-m module.

**Keying:** **PADDLE** (1/4" phone jack) is the keyer paddle input (see *CONFIG: CW PDL* menu entry). **KEY** (1/4" phone jack) can be used with a hand key, external keyer, computer, or other keying device. **PTT IN** (RCA/Phono) is for use with a footswitch or other external transmit control device. **KEY OUT** (RCA/Phono) is the amplifier T-R relay keying output, capable of keying up to +200VDC @ 5A.

**REF IN** (SMA): External 10-MHz reference input for use with the K3EXREF option module (see *CONFIG: REF CAL* and *CONFIG: XVn OFS*).

## KIO3 Module

The KIO3 provides serial I/O, control signals, audio in/out for use with sound cards, speaker outputs, and auxiliary headphone and mic jacks.

### RS232

The RS232 port can operate at up to 38,400 baud. A straight-through cable is required. If you're using an Elecraft P3 Panadapter, the computer is connected to the P3, and the P3 is connected to the K3.

If you're building your own cable, you can use as few as three wires (RXD, TXD, and ground; see table below). DTR and RTS are optional.

**⚠ This table uses EIA standard descriptions, which are from the perspective of the PC. These differ from K2 documentation, even though the connections are functionally identical.**

Pin #	Description
1,6,8,9	Not used
2	RXD IN (data to PC from K3)
3	TXD OUT (data to K3 from PC)
4	DTR (see <b>PTT and Keying</b> , below)
5	Ground (RF isolated)
7	RTS (see <b>PTT and Keying</b> , below)

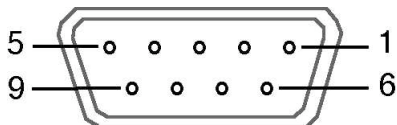

RS232 Connector (female, on KIO3 panel)

**Serial Port Setup:** Set `CONFIG:RS232` for the desired baud rate. Software should be set up at the same rate; 8 data bits, no parity, 1 stop bit.

**DTR and RTS:** These are **not** used as serial I/O handshaking lines. Instead, the K3 can use these as PTT IN or KEY IN (see `CONFIG:PTT-KEY`). The default for both signals is *inactive*. Refer to application software documentation to determine if it can use RS232 signal lines for PTT or keying.

**⚠ If a PC or other device asserts RTS or DTR while you're using the `PTT-KEY` menu entry, the K3 will enter TEST mode as a precaution.**

## ACC (Accessory I/O)

ACC connector pinouts are listed below.

**⚠ ACC is not a VGA video connector. The K3 does not provide a video output.**

Pin #	Description
1	FSK IN (see <b>FSK Input</b> )
2	AUXBUS IN/OUT (see KRC2 or XV-Series transverter instruction manual)
3	BAND1 OUT (see <b>Band Outputs</b> )
4	PTT IN (in parallel with MIC PTT)
5	Ground (RF isolated)
6	DIGOUT0 (see <b>Transverter Control</b> )
7	K3 ON signal (out) or TX INH (in) (see <b>Transverter Control, TX INH</b> )
8	POWER ON (see pg. 44)
9	BAND2 OUT (see <b>Band Outputs</b> )
10	KEYOUT-LP (10 mA keying output)
11	DIGOUT1 (see <b>DIGOUT1</b> )
12	Ground (RF isolated)
13	BAND0 OUT (see <b>Band Outputs</b> )
14	BAND3 OUT (see <b>Band Outputs</b> )
15	EXT ALC input (see <b>External ALC</b> , pg. 27)

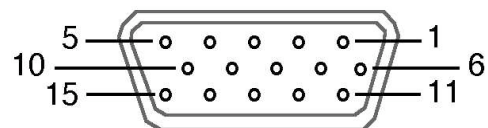

ACC Connector (female, on KIO3 panel, viewed from the back of the K3)

### FSK Input (for FSK D Data Mode)

This is a TTL input pulled up to 5V, compatible with PC outputs. When used with an RS232 signal from the PC, a level translator is required.

### DIGOUT 1

DIGOUT1 is a per-band/per-antenna open-drain output for controlling antenna switches, preamps, filters, etc. See `CONFIG:DIGOUT1`.

## Band Outputs (BAND0-BAND3)

BAND0-3 provide band selection signals. Their behavior is controlled by the *CONFIG:KIO3* menu entry (see below). Band data is based on VFO A.

**⚠ Earlier K3s may require external pullup resistors to 5 V on these lines, typically 2.2-10K.**

In tables below, **0** = 0 VDC, and **1** = 5 VDC.

With *CONFIG:KIO3* set to **NOR**, the BAND0-3 outputs are mapped based on the selected HF-6 m band as shown below. On Transverter bands, BAND0-3 will all be set to zero.

Band	BAND3	BAND2	BAND1	BAND0
160 m	0	0	0	1
80 m	0	0	1	0
60 m	0	0	0	0
40 m	0	0	1	1
30 m	0	1	0	0
20 m	0	1	0	1
17 m	0	1	1	0
15 m	0	1	1	1
12 m	1	0	0	0
10 m	1	0	0	1
6 m	1	0	1	0

If *CONFIG:KIO3* is set to **TRN**, BAND0-3 reflect the parameters of the *CONFIG:XVn ADR* menu entry, as shown below. On HF-6 m they're set to 0. Addresses **INT. TRN0-9** are used with the K3's internal 2-m transverter option (K144XV). **INT TRN0** sets all band outputs to 0, while **INT TRN1-9** have the same decodes as **TRN1-9**.

Transverter addresses are also sent to Elecraft XV-series transverters and the KRC2 via the AUXBUS line. **Note: TRN1-7** are sent as 1-7, but **TRN8** and **TRN9** are sent as 0.

ADR	BAND3	BAND2	BAND1	BAND0
TRN1	0	0	0	1
TRN2	0	0	1	0
TRN3	0	0	1	1
TRN4	0	1	0	0
TRN5	0	1	0	1
TRN6	0	1	1	0
TRN7	0	1	1	1
TRN8	1	0	0	0
TRN9	1	0	0	1

With *CONFIG:KIO3* set to **HF-TRN**, the BAND0-3 outputs follow the **NOR** table when HF-6 m bands are selected, and the **TRN** table when a transverter band is selected.

## Transverter Control

Normally, when the K3 is turned on, a 5-VDC logic signal appears on ACC pin 7 (**K3 ON**). This could be used with Elecraft XV transverters as an enable signal (pin 8 of J6 on the transverter).

However, pin 7 can alternatively be configured as a transmit inhibit *input* line for use in multi-transmitter stations. (See **TX INH**, below.) In this case it is not available as a power-on signal for Elecraft transverters. Instead, the K3's 12-VDC switched output could be used for transverter ON.

For transverter keying, you can use KEYOUT-LP signal (pin 10 of the ACC connector) or the KEY OUT jack (RCA).

With *KIO3* set to **TRN** or **HF-TRN**, the DIGOUT0 line (ACC, pin 6) will output 0 V when low power mode is selected for the current transverter band (*CONFIG:XVn PWR*). At all other times, DIGOUT0 will be floating (Hi-Z).

**i** The K3's BAND0-2 outputs emulate the Elecraft K60XV's XVTR0-2 signals when *CONFIG:KIO3* is set to **TRN** or **HF-TRN**. However, BAND0-2 on the K3 are open-drain signals, while XVTR0-2 on the K60XV are TTL.

## TX INH (Transmit Inhibit Signal)

Pin 7 of the ACC connector can be configured as a transmit inhibit input by setting *CONFIG:TX INH* to **LO=Inh** (or **HI=Inh**). Holding pin 7 low (or high) will then prevent transmit. An external 2.2 to 10 K pull-up resistor (to 5 VDC) is required.

**⚠** If *TX INH* is set to **OFF**, pin 7 reverts to its default *output* function, K3 ON (see above).

## Elecraft KRC2 Universal Band Decoder

An Elecraft KRC2 can be used with the K3 to perform station switching functions; it includes sink and source drivers for all bands. The KRC2 uses the AUXBUS rather BAND0-3 (see *CONFIG:KRC2* for 6-meter band mapping). Refer to the KRC2 instruction manual for more information.

## **SPKRS**

STEREO or MONO; 4 to 8  $\Omega$

Plugging in external speaker(s) cuts off the internal speaker. A stereo plug is recommended; tip is left speaker, ring is right. If you only have a mono plug, set *CONFIG:SPKRS* to **1** to disable right-channel audio. (Also see important note below.)

## **PHONES**

STEREO or MONO; 16  $\Omega$  min. recommended

The front and rear-panel headphone jacks are both isolated with series resistors. This allows you to use mono phones on one jack and stereo on the other, if required. You'll need stereo phones for AFX (audio effects) and stereo dual receive (with sub receiver).

**i** You can plug in headphones and speaker(s) at the same time, and hear audio in both, if you set *CONFIG:SPKR+PH* to **YES**. However, if you set *CONFIG:SPKRS* to **1**, setting *SPKR+PH* to **YES** will force mono headphone as well as speaker output. You can set *SPKRS* to **2** if you use a stereo plug at the external speaker jack, or if no external speaker is plugged in.

## **MIC**

MONO; hi- or low-Z

This jack accommodates an electret or dynamic mic. Use *MAIN:MIC SEL* to select the rear panel mic (**RP**). Tap **1** to turn on Low or High mic gain range. Tap **2** to turn bias on/off (see pg. 28 for recommendations based on mic type).

For the front-panel mic only, additional microphone gain can be enabled by tapping **3**. Use this only for very low-output mics.

The mic's PTT signal, if used, must be routed to either the PTT IN jack or the PTT line on the ACC connector (pg. 18).

## **LINE IN**

MONO, transformer-isolated; 600  $\Omega$  (nominal)

This input should be connected to your computer's soundcard output. The **MIC** gain control sets the line input level when the *MAIN:MIC SEL* menu entry is set to **LINE IN**.

**⚠** The **LINE IN** level should be set carefully to avoid transmit signal distortion due to saturation of the K3's input audio transformer. In addition, sound card gain should be set **6 to 10 dB below the level at which the sound card's output stage starts clipping**.

## **LINE OUT**

STEREO, transformer-isolated; 600  $\Omega$  (nominal)

These outputs can be connected to your computer's soundcard inputs. Normally, the left channel is main receiver audio, and the right channel is sub receiver audio (if applicable). In this case the outputs are post-AGC but pre-AF-gain.)

Use *CONFIG:LIN OUT* to set the level, or to switch from a fixed-level setting to **=PHONES**.

**⚠** **LIN OUT** settings above **10** are usually not necessary, and can in some cases cause overloading of either the K3's output transformers or the PC soundcard inputs (typically on noise peaks). Either could degrade the performance of digital demodulation software.

**⚠** Some laptop computers have only very high-gain, high-impedance mic inputs, not line-level inputs. This can make it difficult to adjust the K3's **LINE OUT** level, and can also worsen noise pickup. If your laptop has only a mic input, you may want to add a resistive attenuator between the K3 and the laptop to keep the signal-to-noise level high.

# Basic Operation

This section covers the fundamentals of K3 receive and transmit operation. It'll also get you started using each of the major operating modes.

Once you're familiar with the K3, please go on to **Advanced Operating Features** (pg. 33).

## Using Tap/Hold Switches

Most K3 switches have two functions. **Tapping** (pressing for less than 1/2 second) activates the function labeled on the switch. **Holding** (pressing for more than 1/2 sec.) activates the function labeled beneath the switch.

## Initial Power-Up

- Connect a power supply (pg. 8); antenna or dummy load; key, if used (pg. 16); mic, if used, and station ground (pg. 16).
- Tap **POWER** to turn the K3 on. The LCD should illuminate and show VFO A/B frequencies. (Tapping **POWER** again turns power off.)
- The VFO B display can show a variety of useful parameters in addition to the normal frequency display. To see these, tap **DISP** (left of the display), then rotate the VFO B knob. The VFO B display will cycle through **time**, **date**, **RIT/XIT offset**, **supply voltage**, **current drain**, etc. (pg. 36). You can use these displays to make sure the supply voltage is in range (11-15 V), and that current drain is about 1 amp (higher with sub receiver installed and turned on). Tap **DISP** to return to the normal VFO B frequency display.

## Using the Menus

There are two menus: **MAIN** and **CONFIG**. Most entries in the CONFIG menu are used for test, configuration, and alignment, and are used infrequently.

Nearly all menu entries appear in alphanumeric order. In the few exceptions to this, adjacent entries are still closely related.

## MAIN Menu

- Tap **MENU** to access the main menu. (Tapping **MENU** again exits the menu.)
- Use VFO B to scroll through the menu entries, referring to the list on pg. 52 for details.
- Change the value (or *parameter*) of any menu entry using VFO A.

## CONFIG Menu

- Hold **CONFIG** (*hold* function of the **MENU** switch) to access the CONFIG menu.
- Use VFO B to scroll through the CONFIG menu entries, referring to the list on pg. 53.

## Menu Help

Tap **DISP** to show help information about the present menu entry. For most entries, the default parameter value is shown in parentheses at the start of the help text.

## Programmable Functions

Menu entries that you'd like quick access to can be assigned to any of the 10 programmable function switches, **PF1**, **PF2**, and **M1** – **M4** (tap or hold). “**Function**” menu entries can *only* be used via such a switch assignment. (Examples, from the CONFIG menu: *VFO B->A* and *TTY LTR*.)

To set up a programmable function switch, first use **MENU** or **CONFIG** to locate the target menu entry. Next, hold **PF1** or **PF2**; *or*, tap or hold **M1** – **M4**. For example, if you tap **M2**, you'll see **M2T SET** (T for tap), while holding **M2** would show **M2H SET** (H for hold). The assigned switch can then be used as a shortcut to access that entry. **M1** – **M4** can each be assigned a tap and/or hold function.

**i** Any **M1** – **M4** switch that is used as a programmable function switch will not be available for message play. To cancel a programmable switch assignment and restore a previously-saved message, tap **REC**, then tap the buffer you'd like to restore (**M1** – **M4**), then tap **REC** again.

## Macros

Programmable switches can also be used to automate often-used sequences, or *macros*, such as “SPLIT, A>B, move VFO B up 5.” Refer to the *CONFIG:MACRO x* menu entry, *K3 Utility* help, or the *K3 Programmer's Reference*.

## Band and Mode Selection

Tap either end of **BAND** to select the desired ham band (160 through 6 meters). You can use direct frequency entry (pg. 15), or recall a frequency memory (pg. 16). Individual bands can be mapped out if not needed (see *CONFIG:BND MAP*).

Tap either end of **MODE** to select the operating mode. Hold **ALT** to select an alternate mode, if required. This include **CW REV** (pg. 30), **DATA REV** (pg. 31), **AM-S** (synchronous detection, pg. 29), and **FM +/-** (FM repeater split, pg. 29).

## Antenna Selection and Matching

### Main Antennas (ANT1 and ANT2)

If you don't have a KAT3 antenna tuner installed, connect your antenna to **ANT1**.

If you do have a KAT3 installed, you can connect antennas to both **ANT1** and **ANT2**; tap **ANT** to select. Holding **ATU** selects **AUTO** (autotune enabled) or **BYPASS** mode. In **AUTO** mode (**ATU** icon on), the antenna can be matched for best SWR by tapping **ATU TUNE**. Up to 30 ATU settings are saved for both antennas on every band. The **ATU** icon will flash briefly whenever new settings are automatically loaded.

**i** Tapping **ATU TUNE** a second time within 5 seconds starts a more extensive match search. The ATU can even be manually tuned if desired. Refer to *CONFIG:KAT3* for details.

**i** Holding **ANT** allows names to be assigned to ANT1 and 2 (e.g., 'YAGI'). These will be flashed when you switch antennas. When editing names, VFO B selects the character position to change; VFO A cycles through available characters. Setting the first character to "-" disables name display.

### Receive-Only and 2-Meter Module Antennas

With the KXV3 option installed, you can tap **RX** to select the receive-only antenna (**RX ANT IN/OUT**, pg. 39). The KRX3 sub receiver either shares the main receiver's antennas or uses an auxiliary input (**AUX RF**, pgs. 37 and 41).

If a K144XV 2-meter module is installed, connect its antenna to **ANT3**. Refer to the K144XV manual for further details.

## Using the VFOs

VFO A is both the main receive and transmit frequency, except during **SPLIT**, in which case VFO B controls the transmit frequency (pg.36). VFO B also controls the sub receiver (pg. 37).

Tap **RATE** to select 10 / 50 Hz per step. The faster rate can be changed using *CONFIG:VFO FST*. The number of counts (or steps) per VFO knob turn can be changed using *CONFIG:VFO CTS*. Tapping **RATE** briefly flashes either the 10-Hz or 100-Hz digit to indicate slow or fast tuning.

For 1-Hz steps, tap **FINE**; for wider steps, use **COARSE** (see *CONFIG:VFO CRS*). When **FINE** is in effect, a 1-Hz digit will appear in the VFO A display. When **COARSE** is in effect, the 10-Hz digit is not shown.

Tap **A ► B** once to copy VFO A's frequency to VFO B. Tapping **A ► B** a second time within 2 seconds also copies VFO A's filter setup, preamp state, and other settings to VFO B.

**A / B** exchanges VFO A and B and their settings. (Also see *CONFIG:VFO B->A*.) Pressing **REV** only exchanges the VFOs for as long as you hold it in. (Exception: When using an FM repeater offset, **REV** permanently swaps RX/TX.)

VFO B and the sub receiver can be set up directly by holding **BSET**. While **BSET** is in effect, all icons and VFO-related controls apply to VFO B (and to the sub receiver, if turned on; see pg. 37).

Holding **SUB** links/unlinks the VFOs, while a long hold (> 2 seconds) turns on diversity mode (pg. 37).

## RIT and XIT

The RIT/XIT offset control, at the far right, sets the offset for **RIT** and **XIT**. The offset is shown on the VFO B display as you adjust the control. Three LEDs show whether the offset is 0, (-) or (+).

Tap **CLR** to zero the RIT/XIT offset. Tapping it a second time restores the offset.

To copy the present RIT offset to VFO A, hold **CLR** for 2 seconds. VFO A will be moved to the new frequency before the offset is zeroed.

**i** If RIT/XIT are both off, the offset control can coarse-tune VFO A (*CONFIG: VFO CRS*). Coarse tuning steps are programmable by mode.

## Receiver Setup

This section explains how to use basic receiver controls. Setup for specific operating modes is described in later sections; see *Voice Modes* (pg. 28), *CW Mode* (pg. 30), and *Data Modes* (pg. 31).

Also see *Text Decode and Display* (pg. 33) and *Audio Effects* (pg. 35).

### Receiver Gain Controls

Use  $\odot$  **AF** — **SUB** (pg. 11) to set the desired main and sub receiver volume level. There are two overall audio volume ranges, LO and HI, which can be selected using *CONFIG:AF GAIN*.

Usually, both  $\odot$  **RF** — **SUB** controls will be set fully clockwise (main and sub receiver RF gain). You may wish to reduce RF gain to optimize receiver response to high signal levels or noise.

**i** If the sub RF gain knob has been reconfigured as squelch for both receivers, then the main RF gain knob will control RF gain for both receivers. (See *CONFIG:SQ MAIN*.)

To improve weak-signal reception, turn on the preamp using **PRE**. In the presence of extremely strong signals, you may wish to use the attenuator (**ATT**), or reduce the RF GAIN setting.

### Crystal Filter Selection

You can install as many as five crystal roofing filters in the K3's main receiver, and another five in the sub receiver. For diversity receive, matched main/sub receiver crystal filters should be used (pg. 38).

Bandwidths as narrow as 200 Hz and variable-bandwidth filters are available, thanks to the K3's low first I.F. (intermediate frequency) of 8.215 MHz. See Appendix A for recommended crystal filter bandwidths for each mode.

To select a crystal filter manually, tap **XFIL**. The **FL1-FL5** icons show the current selection. This sets the DSP passband to match the crystal filter, and removes any passband shift or lowcut/hicut.

The K3 will also select the most appropriate crystal filters automatically as you adjust the  $\odot$  **SHIFT**,  $\odot$  **WIDTH**,  $\odot$  **LO CUT**, and  $\odot$  **HI CUT** controls.

### Filter Passband Controls

As you rotate the filter controls (shift, width, hicut, locut), the associated parameter value is shown on VFO B. The *filter graphic* shows the width and location of the passband, as illustrated below. In these specific examples, segments that turned off as a result of control movement are shown in gray.

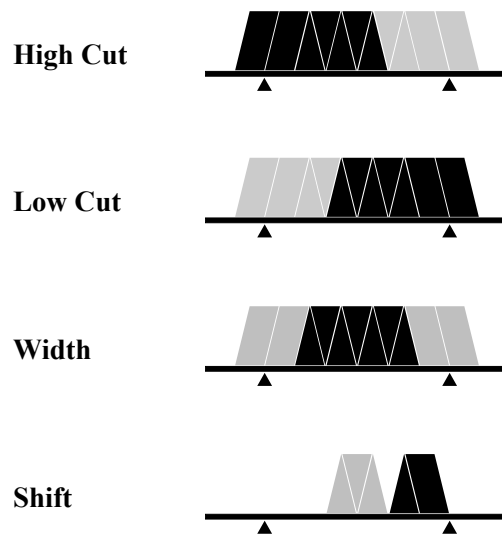

**i** Filter passband controls don't apply in FM mode. SHIFT control granularity can be set to either 10 or 50 Hz in CW and DATA modes; see *CONFIG:PB CTRL*. In Sync AM mode (**AM-S**), SHIFT selects the upper or lower sideband.

Each passband control has an integral switch. These switches are used as follows:

*Tapping* the control alternates between the two primary functions for that control, for example HICUT and WIDTH. This is indicated by the two LEDs above each control.

*Holding* a control activates its secondary function, labeled below the control.

**i** Tapping or rotating a control shows the present setting. To see the settings of both knob functions without changing them, just tap the control twice.

The secondary functions of the controls are **NORM** and **I/II**, described in the following sections.

## Filter Presets (I/II)

Each operating mode provides two ‘floating’ filter presets, **I** and **II**, which store filter settings on a per-VFO, per-mode basis (excluding FM). They are updated continuously as you change filter settings. (Fixed, per-mode ‘normal’ settings are also available as explained below.)

You can alternate between the **I** and **II** settings by holding **I/II**. This is especially useful when you’re alternating between a wide and narrow setting during contest or DX operation.

The **I** and **II** settings for VFOs A and B are independent.

## Filter Normalization (NORM)

### Standard Settings

To get quickly to a standard per-mode bandwidth and reset any passband shift or cut, hold **NORM** (normalize). The normalized AF bandwidth is 400 Hz in CW and DATA modes, 2.7 or 2.8 kHz in SSB modes, and 3.0 kHz for AM<sup>1</sup>.

**i** Whenever you normalize the filter passband, two small "wings" appear at the left and right ends of the DSP filter passband graphic as shown below.



Moving any DSP control makes the "wings" disappear, as a reminder that the passband is no longer normalized.

## Custom Settings (NORM1 and NORM2)

In addition to the K3's standard "NORM" values, you can save two of your own setups in each mode, then recall them using the **NORM** function. These setups are referred to as **NORM1** and **NORM2**.

To save a custom normalization setting:

- set up the filter passband as desired for the current mode
- hold **NORM** until you see **<- SAV ->** (3 seconds)
- rotate the knob slightly left or right to save it as **NORM1** or **NORM2**.

(The arrows to the left and right of **SAV** are a reminder that you can rotate the knob to get to the two user-defined normalization settings.)

To recall, hold **NORM** until you see **<- NOR ->** (about 1/2 second), then rotate the knob left or right to recall **NORM1** or **NORM2**.

## Narrow DSP Filter Types

For bandwidth settings of 100 Hz or lower, the K3's DSP normally uses a type of filter that minimizes ringing: the **Finite Impulse Response** or **FIR** filter.

If you'd like steeper filter skirts, and don't mind a small amount of ringing, you can select **Infinite Impulse Response** or **IIR** filters for these bandwidths. Locate **CONFIG:FLx BW** menu entry, then tap **7** until you see **IIR ON**. Both main and sub receivers will use the same setting.

**⚠** IIR filters take longer to change from one bandwidth to another, so you may hear audio artifacts when adjusting the DSP controls. If this is objectionable, use the default FIR filters.

---

<sup>1</sup> In AM mode, the I.F. bandwidth required for good fidelity is about twice the AF bandwidth. This is why a 6 kHz or wider crystal filter is needed to effectively use the 3 kHz **NORM** setting. If a 15 kHz FM filter is installed, it can be used in AM mode to provide good fidelity at even higher AF bandwidth settings.



## Reducing Interference and Noise

The K3 provides several ways to cut interference, including DSP noise reduction, manual and auto notch, and noise blanking. Also see **Audio Effects** (**AFX**, pg. 35).

There are actually two noise blankers: one at the first I.F. (KNB3 module), and the other at the 2nd I.F. (DSP).

**A** Noise reduction, noise blanking, and notch filtering should only be used when necessary. These *signal processing* techniques are extremely effective, but can introduce side effects. Sometimes, reducing the filter bandwidth is the most effective interference-reduction strategy.

### Noise Blanking

First, tap **NB** to enable I.F. and/or DSP noise blanking.

Next, hold **LEVEL** to set the DSP level (VFO A) and I.F. level (VFO B). You'll initially see **DSP OFF** and **IF OFF** on the VFO A and B displays.

Rotating VFO A clockwise will turn on the DSP NB, showing **DSP t1-1** through **DSP t3-7**. The first number shows the relative pulse integration time, and the second shows the blanking level. The higher the numbers, the more aggressive the DSP blanking action.

Rotating VFO B clockwise will turn on the IF NB, showing **IF NARn**, **IF MEDn**, or **IF WIDn**, where **n** is **1-7**. **NAR/MED/WID** refers to narrow/medium/wide blanking pulse widths, and **n** is the blanking level. Higher **n** means more aggressive blanking action. Use **NAR** width when possible to minimize strong-signal interaction effects.

**i** The **NB** icon will flash slowly if the I.F. blanker setting is too high for the present signal conditions. If this happens, use a lower setting.

Both the DSP and IF blanking settings are saved on a per-band basis. If **CONFIG:NB SAVE** is set to **YES**, the on/off status of **NB** will be also be saved for each band.

**i** The **DSP noise blanker** is in the 2<sup>nd</sup> I.F., where it can't be activated by signals outside the crystal filter passband. It can be used with high-duty-cycle and complex-waveform noise generated by computers, switching power supplies, light dimmers, etc. The **I.F. noise blanker** is in the 1<sup>st</sup> I.F., where it can use very narrow blanking widths. It is most effective at blanking AC line noise, lightning, and other very broadband noise. Often, a combination of the two is the most effective.

### Noise Reduction

Noise reduction reduces *random* background noise while preserving meaningful signals. It adds a characteristic "hollow" sound to all signals.

**NR** turns noise reduction on. It doesn't apply to DATA or FM modes, or with AGC turned off.

Hold **ADJ** to display the NR setting, which is saved per-mode. Use the VFO B knob to tailor NR for the present band conditions. In general, the higher the number, the more aggressive the noise reduction. Settings **F1-1** through **F4-4** are recommended. **F5-1** through **F8-4** use a different algorithm, where the **-x** part of the setting indicates the degree of mix between the DSP-processed and unprocessed signals (**-1** is about 50% processed, **-4** is 100%). A small **M** appears to remind you that a **Mixed** setting is in effect, e.g. **NR<sup>M</sup> F5-1**.

### Notch Filtering

Notch filtering removes interfering carriers while leaving the desired signal relatively unaffected. The K3 provides automatic and manual notch tuning.

**Auto notch** will find and remove one carrier, and in some cases more than one. (SSB mode only.)

**Manual notch** removes one carrier at a specified pitch, and can be used in CW and DATA modes as well as voice. Since manual notching sets up a fixed (rather than adaptive) notch, it can even suppress a keyed carrier, i.e. a Morse code signal.

Tap **NTCH** to turn on notch filtering (**NTCH** icon). This turns on **Auto** notch in SSB mode, and **Manual** notch in other modes (adds **◀▶** icon).

Holding **MANUAL** directly selects manual notch in any mode. Adjust the manual notch frequency using VFO B, then tap **NTCH** again to exit.

## Transmitter Setup

### Transmit Crystal Filter Considerations

For each operating mode, you must specify which I.F. crystal filter to use for transmit using the **CONFIG:FLTX** menu entry. See pg. 47 for recommended per-mode transmit filter bandwidths.

**A** Transmit signals are generated on the RF board, so the set of filters installed on the RF board must meet the transmit bandwidth requirements of all modes you plan to use. (Filters installed on the sub receiver board are used only in receive mode.)

### Transmit Status LEDs and Icons

Before putting the K3 on the air, you should be familiar with the LEDs and LCD icons that pertain to transmit operation (identified on pgs. 11 and 12). The most important of these are reviewed here.

The **TX** LED turns on during transmit. The **ΔF** (Delta-F) LED turns on if the transmit and receive frequencies differ (**SPLIT** / **RIT** / **XIT**).

The **TX** LCD icon and associated arrows show which VFO is being used for transmit. If you plan to use **SPLIT** mode, See pg. 36.

### Multifunction Transmit Controls

There are two multifunction transmit controls. Their primary functions (mode-dependent) are:

- ⊖ **SPEED** CW keyer speed in WPM
- ⊖ **MIC** Mic gain
- ⊖ **CMP** Speech compression level in dB
- ⊖ **PWR** RF output power in watts (6 m and transverter power settings are independent of other bands; also see **Per-Band Power Control**, pg. 27)

The secondary (hold) functions of these controls are:

- ⊖ **DELAY** VOX or CW semi-break-in delay
- ⊖ **MON** Voice/Data monitor or CW sidetone level.

### VOX, PTT, and QSK

In voice and data modes, use **VOX** to select VOX (pg. 13) or PTT (push-to-talk). PTT can still be used even with VOX selected. Set VOX gain and anti-vox level using **MAIN:VOX GN** and **ANTIVOX**.

In CW mode, use **VOX** to select either VOX or PTT transmit. VOX enables “user-activated” (hit-the-key) transmit, while PTT requires the use of PTT IN (pg. 17) or **XMIT** before CW can be sent.

When the **VOX** icon is on in CW mode, you can use **QSK** to select full (**QSK** icon on) or semi break-in. For more on break-in keying, see pg. 30.

### Transmit Metering

Normally, the transmit bar graph shows **SWR** and **RF** (power output). The displayed **SWR** range is 1:1 to 3:1. The **RF** control range is 0 to 12 W in 1-W units, or 0 to 110 W in 10-W units. The power scale changes from watts x1 to watts x10 at 13 watts.

In voice modes, you can use **METER** to switch to compression (**CMP**) and automatic level control (**ALC**) metering. See pg. 28 for information on adjusting the ⊖ **MIC** and ⊖ **CMP** controls.

If you have a KXV3 installed, you can use **milliwatt-level** power output. This is intended for use with transverters, but it can also allow the K3 to act as a very stable, very low-noise signal generator. To route RX and TX through the XVTR jacks on all bands, set **CONFIG:KXV3** to **TEST**.

When milliwatt-level output is in effect, rotating ⊖ **PWR** will show milliwatts on VFO A, and dBm (dB relative to 1 milliwatt) on VFO B. The RF bar graph displays power output in tenths of a mW.

### Off-Air Transmit Testing

The K3 allows you to listen to your CW keying, test your mic and compression settings, or monitor DATA tones, *without* transmitting an on-air signal. To do this, hold **TEST** (right end of the **MODE** control). While you're in TEST mode, the **TX** icon will flash slowly as a reminder that you're off air.

Hold **TEST** again to return to normal operation.

## External ALC

**⚠** External ALC should only be used to protect your amplifier during operation into a failed load, or during a prolonged overdrive condition. ALC should not be used as a way to clip or compress fast voice peaks, or as a primary means of amplifier or K3 power output control.

**⚠** DO NOT set the K3's power level to maximum and adjust amp output using the amp's ALC control. This will result in splatter and key clicks. Instead, adjust the drive on each band so it's just below ALC activation level.

### Preparing the K3 for use with External ALC

**⚠** You may need to modify the K3 to use external ALC, depending on its date of manufacture. Please refer to our K3 Modifications web page. If you turn on external ALC without making necessary modifications, power will be reduced to a very low level during transmit.

### External ALC Setup

External ALC is set up using the *CONFIG:EXT ALC* menu entry. *EXT ALC* defaults to **OFF**. To turn it **ON**, tap **1**. 6 meter external ALC can be turned on/off separately from HF.

The *EXT ALC* menu entry provides a default ALC threshold of **-4.0V**, used by many amplifiers.

If you select **CMP/ALC** metering at the K3, external ALC activity is indicated by 8 or more bars. If you select **SWR/RF** metering, the **CMP/ALC** meter icons will flash during external ALC activity to make you aware of the condition.

Some experimentation may be required to determine the proper setting of the amplifier's ALC output control, if one is provided. Start with the control set for minimum ALC output. Then adjust the K3's power output such that the amplifier is just reaching its maximum level on voice peaks (in SSB mode) or peak CW power in CW mode.

Next, adjust the amplifier's ALC output control upward until ALC action just begins (or adjust the K3's ALC threshold with the *EXT ALC* menu entry). Finally, reduce the K3's drive power just slightly to provide some safety margin. The goal is to have **no** amplifier ALC action during normal operation. If you see an ALC indication at the K3 or the amplifier, reduce the K3's power output.

## Per-Band Power Control

If the *CONFIG:PWR SET* menu parameter is set to **NOR**, power output on all HF bands follows the present setting of **☺ PWR**. (6 m and transverter bands are always independent of HF.) If you change *PWR SET* to **PER-BAND**, the power level will be saved independently on each HF band. This is especially useful with external amplifiers, or for those who use QRP levels on one band and QRO on another.

When per-band power control is used with an external amplifier, you can adjust the drive ideally on each band to prevent external ALC activation during normal operation.

### TUNE Power Level

If *CONFIG:TUN PWR* is set to **NOR**, power output during **TUNE** will follow the present setting of **☺ PWR**. If you change the *TUN PWR* parameter to a fixed power level, that level will be used during **TUNE**, whether or not you've selected per-band power control (see above).

### Transmitter RF Delay

Some amplifiers have slow relays whose switching time must be accommodated to prevent key clicks during CW operation. If your amplifier requires more than 8 ms of relay switching time, you can increase the delay from key-down to RF output at the K3 using *CONFIG:TX DLY*.

**⚠** Use the smallest value of *TX DLY* that works with your amplifier. Larger values will affect QSK and keying timing at high code speeds.

### Transmitter Inhibit

Some multi-transmitter stations require that transmitters be able to mutually inhibit each other in order to prevent simultaneous use of resources. The K3's transmit inhibit input (TX INH) can be set up for low- or high-active control (pg. 19).

### Fan Speed

The K3/100 includes two large, quiet fans. Fan speeds are normally selected automatically, but you can manually select a minimum fan speed if desired. See the *CONFIG:KPA3* menu entry.

## Voice Modes (SSB, AM, FM)

### Mode Selection

Tap either end of **MODE** to select **LSB/USB**, **AM**, or **FM** mode. Holding the left end of this control, **ALT**, selects an alternate mode. **LSB** and **USB** are alternates of each other. The alternate for **AM** is **AM-S** (synchronous AM, pg. 29). In **FM** mode, **ALT** enables a repeater offset (pg. 29).

### Microphone Selection

The K3 provides both front- and rear-panel mic jacks. Some operators use rear-panel jacks to minimize clutter around the front panel. Use **MAIN:MIC SEL** to select the front panel (**FP**) or rear-panel (**RP**) jack, low or high mic gain range, and bias voltage for electret microphones.

The front-panel mic jack is compatible with the Elecraft MH2, MD2, Proset-K2, and some other 8-pin mics (see pg. 13 for pinout and bias settings).

The rear-panel jack is 3.5 mm (1/8"). The rear-panel PTT IN jack can also be used if required.

### Voice Monitoring

Voice monitoring allows you to hear the way you'll sound on the air with your selected mic gain, compression, and TX EQ settings. For voice monitoring without any processing or delays, set **CONFIG:TX MON** to **FAST**.

To set up voice monitoring:

- Hold **TEST** to put the K3 in TX TEST mode, so you won't be transmitting (pg. 13).
- Set **MIC** high enough to hear your voice.
- Press your mic's PTT switch or tap **XMIT**.
- While speaking into the mic, adjust **MON** for the desired level. (DVR playback level can be set differently; see **CONFIG:TX DVR**).
- Exit transmit (release PTT, or tap **XMIT** again).
- You can either leave the K3 in TX TEST mode or go back to normal transmit (hold **TEST**) as you follow the instructions in the next section.

## Mic Gain and Compression Settings

See pg. 75 for a general discussion about voice-mode ALC. To set up mic gain and compression:

- Set the monitor level as described earlier.
- Optionally select TX TEST mode (pg. 13) or set power to zero. This will not affect your **CMP/ALC** bar graph readings.
- Set **CMP** to **0**.
- Hold **METER** to select **CMP/ALC** metering.
- While speaking into the microphone in a normal voice, adjust **MIC** for a peak ALC meter indication of about 5-7 bars (see below).

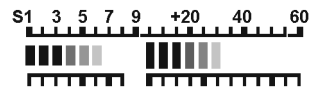

- **CMP 10 20 ALC**
- Adjust **CMP** for the desired speech compression level while speaking. The **CMP** scale shows approximate compression level.
- Hold **METER** to select **SWR/PWR** metering.
- If you were in TX TEST mode, return to normal operation by holding **TEST**.
- If you had **PWR** set to 0, set it for the desired level. Key the rig again and verify that you have about the right power output level.

**i** You can LOCK the MIC, CMP, and PWR settings if required; see **CONFIG:PWR SET**.

### Power Level for Voice Modes

Voice power may be slightly different from the CW power you see in when you use **TUNE**. Increasing mic gain cannot correct for this. Instead, use the **CONFIG:TXG VCE** menu entry (voice transmit gain). A value of -1.5 to 1.5 dB should make voice power about the same as when using **TUNE**.

**⚠** If you're using an external peak-reading wattmeter, adjust power such that speech peaks remain at or below your desired power level. The K3's RF bar graph may not capture all speech peaks, but your actual output will be close to that set with **PWR**.

## Voice Mode VOX Setup

**VOX** selects push-to-talk (PTT) or voice-operated (VOX) transmit (**VOX** icon on). VOX hold time is set with  **DELAY** (pg 14).

**MAIN:VOX GN** (VOX gain) should be set to trigger at normal speech level, but not in response to incidental noise. Start with low settings (5-10).

**MAIN:ANTIVOX** sets VOX immunity to RX audio. With the mic closer to the speaker than normal, increase ANTIVOX until the K3 doesn't switch to TX mode when listening to a loud signal.

## SSB/CW VFO Offset

The K3 can automatically offset the VFO frequency when you switch from SSB to CW mode, so other stations will hear the correct CW pitch. See **CONFIG:CW WGHT** for details.

## Digital Voice Recorder (DVR)

With the KDVR3 installed, you can record and play voice messages as well as capture received audio.

### Transmit Message Record and Playback

Tap **REC** to start recording, then tap any of **M1** - **M4**. Remaining buffer time will be displayed as you speak. Tap **REC** again to end, or **CLR** to erase.

Tap **M1** - **M4** to play. To cancel, tap **REC**. If you wish to manually assert PTT when using the DVR, see **CONFIG:KDVR3**. MIC gain has no effect during message play; the gain setting at record time is used. However, DVR monitor level can be set separately (see **CONFIG:TX DVR**).

To auto-repeat, *hold* (rather than *tap*) **M1** - **M4**. **MAIN:MSG RPT** sets the interval (1-255 seconds).

**Hold REC** to select bank 1 or 2 (4 messages each).

### Receive Audio Record and Playback

Hold **AF REC** to start/stop record. The  icon will flash slowly while recording. Only the last 90 seconds of audio will be available for playback.

Hold **AF PLAY** to start/stop play. The  icon will flash quickly during play. A seconds counter will be displayed on VFO B, along with an asterisk (\*) if you're within the most recent segment. Rotating VFO B adjusts the playback position.

## Transmit Noise Gate

The noise gate function mutes mic audio below a selected threshold; this may be useful in noisy environments. See **CONFIG:TX GATE** for details.

## AM Operation

A 6 kHz (AM) crystal filter is required for AM transmit (pg. 47). AM receive is possible with any filter from 2.7 to 13 kHz. 6 kHz is recommended.

**ALT** switches from envelope detection to sync detection (**AM-S**). Sync AM can improve copy during selective fading. When **AM-S** is in effect, rotating  **SHIFT** selects the upper or lower sideband; one or the other may improve copy.

VFO A can automatically track AM signals in **AM-S** mode. This can be useful when listening to signals mistuned from a nominal frequency. Tap **SPOT** to zero in on an AM signal one time; tap **CWT** for full-time tracking (**T** icon turns on).

**i** Use **SPLIT** if you don't want your transmit frequency to change during auto-tracking.

**i** You can also listen to AM using LSB or USB modes. A 2.7 or 2.8 kHz filter will work well.

## FM Operation

An FM crystal filter (at FL1) is required on the RF board and/or sub receiver for FM use; see pg. 46.

**i** FM mode can be disabled by setting **CONFIG:FM MODE** to **OFF**.

To setup for repeater use:

- Hold **ALT** to select simplex, TX up (+ icon), or TX down (- icon). If an offset is in effect, **REV** swaps RX/TX frequencies and offset direction.
- Set up repeater offsets with **MAIN:RPT OFS**, and VFO step size using **CONFIG:VFO CRS**.
- Hold **PITCH** to set up tone encode. VFO A selects pitch in Hz; VFO B turns tone encode on or off. If **1750** Hz is selected (for European repeaters), an 0.5-s tone burst is sent at the start of each transmission if squelch wasn't already open. Or, you can hold **PITCH** during TX to manually generate a tone burst of any length.
- To see up voice and PL tone deviation, use **CONFIG:FM DEV**.

## CW Mode

### *CW Normal and Reverse*

Select CW mode by tapping either end of **MODE**.

Hold **ALT** to alternate between CW **normal** (lower sideband RX) and **reverse** (upper sideband RX).

If you **SPOT** (or auto-spot) a CW signal (pg. 34), then switch between CW normal and reverse, the pitch of the received signal should stay the same.

### *Basic CW-Mode Controls*

In CW mode, **MON** sets the sidetone volume.

Hold **PITCH** to adjust the sidetone pitch. The peak in response of all filters will track this setting.

Use **AGC** to select slow AGC (**AGC-S**) or fast (**AGC-F**). Slow is fine for casual operating; fast is useful during contests or rapid signal fading.

Hold **QSK** to select **full break-in** (**QSK** icon on) or **semi break-in** operation. **QSK** allows others to “break” your CW transmission by sending one or two characters. With **semi break-in** selected (**QSK** off), the K3 returns to receive mode after a time delay you set using **DELAY**.

**VOX** must be turned on in CW mode to enable both full and semi break-in operation. If PTT is selected (**VOX** icon off), transmit must be activated using PTT or by tapping **XMIT**. PTT is sometimes activated using a foot switch.

**i** For ultra-fast CW full break-in at up to 100 WPM, set **CONFIG: CW QRQ** to **ON**. If **CW QRQ** is **OFF**, max speed using VOX is 60 WPM, and PTT is required for 60 to 100 WPM.

Hold **TEST** to place the K3 into TEST mode. This sets power output to zero, useful for CW practice or for off-the-air checking of recorded CW messages.

### *Other CW-Mode Configuration Settings*

Use the CONFIG menu to set up iambic keying (**CW IAMB**), paddle norm/reverse (**CW PADL**), and keying weight (**CW WGHT**). The **CW WGHT** menu entry can also be used to enable automatic SSB/CW VFO offset (pg. 29).

## *SPOT and Auto-Spot*

When calling another station, you should try to match your frequency to theirs. To facilitate this, the K3 provides both manual and automatic spotting for use with CW and DATA signals. See *Tuning Aids: CWT and SPOT* (pg. 34).

### *CW Text Decode/Display*

The K3 can decode transmitted and received CW signals, displaying the text on VFO B (pg. 33). This is especially useful when you’re learning CW, or if someone who doesn’t know CW is looking over your shoulder while you make CW QSOs. It’s also indispensable for CW-to-DATA operation (pg. 34).

### *APF and Dual Passband CW (DUAL PB)*

In CW mode, **DUAL PB** turns on either a narrow audio peaking filter (APF) or dual-passband CW (Dual PB). See pg. 35.

### *CW Message Record/Play*

**A** Messages can only be recorded using the internal keyer or the **message editor** in **K3 Utility**, not by using a hand key or external keyer.

**i** If **text decode** is on (pg. 33), CW text sent using the internal keyer is shown on VFO B (pg. 33). Use **TEST** to check messages off-air (pg. 13).

There are 8 message buffers (2 banks of 4). Each holds 250 characters. To switch banks, hold **REC**.

**Message Record:** To start recording, tap **REC**, then **M1** - **M4**. The remaining buffer space will be displayed as you send. Tap **REC** again to stop.

**Message Play:** Tap **M1** - **M4** to play. To cancel, tap **REC** or hit the keyer paddle or key.

**Message Erase:** Tap **REC**, then **M1** - **M4**, then **CLR**.

**Auto-Repeat:** To auto-repeat a message, *Hold* (rather than *tap*) **M1** - **M4**. **MAIN:MSG RPT** sets the message repeat interval (1 to 255 seconds).

**Chaining:** *Tapping* **M1** - **M4** during playback chains another message onto the message being played. *Holding* a message switch during playback chains a repeating message.

## Data Modes

You don't need a computer to get started with data modes on the K3: it can receive and display RTTY and PSK31 on its LCD (pg. 33). You can transmit in data modes using your keyer paddle (see **CW-to-DATA**, pg. 34).

Using a computer for data modes is also very convenient on the K3, as described below. If you're using AMTOR or PacTOR, also see pg. 32.

### Data Mode Connections

You can transmit and receive data with a computer in three ways:

- Connect your soundcard I/O to the K3. Use **MAIN:MIC SEL** to use LINE IN/OUT, front-panel mic jack, or rear-panel mic jack. You can use VOX or PTT to control transmit.
- Use the soundcard in receive mode, but use a PC I/O line to do direct FSK (or PSK) modulation. Connect the PC's I/O line to the "FSK IN" line on the K3's ACC connector. (If this signal originates from an RS232 port, it will require RS232-to-TTL level conversion.)
- Send and receive ASCII text via the RS232 interface. To send, insert text into a "KY" command (e.g., "KY CQ DE N6KR;"). To receive, send "TT1;" (text-to-terminal). "TT0;" turns it off. See the K3 Programmer's Reference, available at [www.elecraft.com](http://www.elecraft.com).

### Data Mode Selection

Soundcard-based data communications can be done using LSB or USB mode. However, DATA modes offer several benefits not available in SSB modes.

If you prefer to use LSB or USB, you'll need to manually set **CMP** to **0** to prevent data signal distortion. Refer to your data communications software manual to determine how to set up the VFO and computer for accurate frequency display.

To use DATA modes, tap **MODE** until the **DATA** icon appears. Next, hold **DATA MD**. The present data mode is shown on VFO B, and can be changed by rotating the VFO B knob.

The following data modes are available:

- **DATA A** can be used for all Audio-shift transmit modes, including **PSK31**, **MFSK**, **AFSK**, etc. The VFO displays the suppressed-carrier frequency, just as when SSB modes are used for data. USB is "normal" for DATA A. Compression is automatically set to 0.
- **AFSK A** also uses Audio-shift transmit, but is optimized for RTTY. The VFO displays the RTTY mark frequency, and LSB is "normal". The built-in text decoder can be used in this mode (pg. 33), as well as the dual-tone RTTY filter (DTF, pg. 32).
- **FSK D** is identical to AFSK A, except that Direct modulation is used, via FSK IN, ASCII, or the keyer paddle (pg. 34). The text decoder can be used in this mode (pg. 33), as well as the dual-tone RTTY filter (DTF, pg. 32).
- **PSK D** is a Direct-transmit mode for **PSK31**. It's the only mode that decodes and displays PSK31 signals with the text decoder (pg. 33). Like FSK D, PSK D lets you transmit via FSK IN, ASCII, or the keyer paddle (pg. 34). You can also use auto-spot with PSK D if the tuning aid is displayed (**CWT**), pg. 34).

The **DATA MD** display also shows the data speed in bps on VFO A. This is relevant only if the text decoder is on. Depending on the mode, other data speeds may be available; select them by rotating VFO A.

Also shown is the current sideband (**LSB** or **USB**). If this sideband is considered "data reverse" for the present mode, then **REV** also appears. You can use **ALT** to switch to the other sideband if required. **REV** is not recommended with CW-to-DATA (pg. 34).

### Mark/Shift and Pitch Selection (PITCH)

Hold **PITCH** to view and change the received mark tone and shift (AFSK/FSK) or center pitch (PSK).

In AFSK/FSK modes, you have a choice of mark tone/shift combinations. Use VFO A to select a tone/shift combination that's compatible with your software. A lower mark pitch makes signal tuning easier when using the K3's text decoder.

## RTTY Dual-Tone Filter (DTF)

Hold **DUAL PB** to turn on the RTTY dual-tone filter (DTF). This creates two filters, one centered on the mark tone, the other on space, which can often improve RTTY copy. The filter graphic changes to reflect this (see below).



When DTF is on, the range of the **WIDTH** control is adjusted to better match the characteristics of the filter. **SHIFT**, **LOCUT** and **HICUT** are disabled.

The dual-tone filter can be used with **AFSK A** and **FSK D**. The on/off state of DTF is saved independently for each of these modes.

## FSK Transmit Polarity

You can invert the logic level of the FSK IN line in FSK D mode using **CONFIG:FSK POL**. This should be used only with external keying via computer programs such as MMTTY; it is not recommended for use with CW-to-DATA (pg. 34).

## Mic Gain, ALC, and Monitor Level

If you're using an audio-shift transmit mode (**LSB**, **USB**, **DATA A**, or **AFSK A**), you'll need to set the **MIC** level while watching the ALC meter. You can use the same procedure outlined for voice modes (pg. 28), except that speech compression should not be used.

In all cases (SSB modes as well as DATA), you can optionally use **MON** to monitor your data signals. The procedure given for voice modes can be used (pg. 28). Voice-mode and DATA-mode monitor levels are independent.

**i** The **MIC** setting does not apply to direct modulation data modes (**FSK D** and **PSK D**), since no audio is used for transmission. However, you can still use **MON** to monitor the signals.

## AMTOR / PacTOR

AMTOR, PacTOR and similar modes can reliably transfer data – including e-mail – via HF radio networks. New modes are under development that may provide even greater reliability. Applications include maritime mobile and emergency communications where the K3's light weight and excellent receive performance are advantageous.

General information regarding K3 set up for these modes appears below.

- Frequency stability is important in these modes. A 1-PPM TCXO is available (KTCXO3-1).
- Connect modem audio I/O to the K3's LINE OUT and LINE IN jacks (for LINE OUT, use the TIP contact of a stereo plug). A PTT connection is also usually required. If the modem operates from 12 V (0.5 A or less), it can be powered from the K3's 12 VDC output.
- Set up the modem (if applicable). Settings may vary depending on the data mode being used.
- Locate **CONFIG:LIN OUT** and set it to 10. A different level may be better for your modem.
- The K3's SYNC DATA feature can be used to minimize T-R delays (it forces the same crystal filter to be used for both receive and transmit). Locate **CONFIG:SYNC DT**. Assign it to a programmable function (e.g., by holding **PF1**), then exit the menu.
- Tap **MODE** to select **DATA**.
- Select an appropriate data sub-mode by holding **DATA MD**, then rotating VFO B. **DATA A** (generic data mode, USB) is used in most cases; see pg. 31 for alternatives, such as **AFSK A**. Tap **AFX** to exit the parameter display.
- Locate **MAIN:MIC SEL** and set the audio source for data to **LINE IN**. Exit the menu.
- If you wish to use SYNC DATA, turn it on by holding **PF1** (or the switch used above). The **-S** icon will appear. A **CONFIG:PTT RLS** value of 10 to 12 may be ideal in this case.
- Some modes may have very high duty cycles; use less than full power output if required.

Refer to your application software for instructions regarding email set up and other operating details.



# Advanced Operating Features

## Text Decode And Display

The K3 can decode CW, PSK31 and RTTY. Decoded text is displayed on VFO B. In data modes, you can use the K3's internal keyer to transmit PSK31 and RTTY signals (pg. 34).

**i** When text decode is enabled, rotating the RIT/XIT offset control doesn't display the offset.

### CW Text Decode Setup

To set up CW text decode:

- Set **MODE** to CW.
- If a special VFO B display mode is in effect, cancel it by tapping **DISP**.
- Hold **TEXT DEC**, then select **CW 5-40** (lower WPM range) using VFO B. Below the **CW** icon you'll see a **T** (text decode enabled). The **TX ONLY** setting decodes only CW you send (internal keyer), so the **T** does not appear.
- Adjust the threshold (**THR**) using VFO A. Try **AUTO** or **1 - 6** (also see tips below). Tap **CWT** to exit text-decode setup.
- You'll probably want to turn on **CWT** as a tuning aid (pg. 34). This also enables auto-spot.

### CW Text Decode Tips:

- **SPOT** (or **auto-spot**) a signal first, then tune slowly until recognizable words appear.
- Noise or fading may result in invalid character decodes, causing asterisks (\*) to appear. In difficult conditions, reduce **WIDTH** to as low as 50 Hz (100-200 Hz for faster CW).
- To optimize text decode, use manual threshold settings. Start with **THR 5**. With **CWT** on, adjust the threshold so that the **CWT** bar flashes in sync with the received CW signal.
- To decode very fast CW, use **CW 30-90**.

### Received CW Speed Display:

Received CW speed (from about 10-70 WPM) can be displayed using the **WPM CHK** setting. The left end of the display shows WPM, e.g. **20w CQDX**.

### DATA Text Decode Setup

To set up text decode for DATA modes:

- Set **MODE** to DATA. Then hold **DATA MD** and select either **AFSK A**, **FSK D**, or **PSK D** mode using VFO B. Tap **AFX** to exit the data-mode display.
- For **AFSK A** or **FSK D**, hold **PITCH** and select the desired mark/shift setting. The lowest mark tone selection (915 Hz) may be more pleasant to listen to than higher tones. (The pitch for **PSK D** mode is fixed at 1010 Hz.) Tap **SPOT** to exit the pitch display.
- Hold **TEXT DEC**, then select **ON** using VFO B. Below the **DATA** icon you should now see a **T**, showing that text decode is enabled.
- Adjust the threshold (**THR**) using VFO A. Start with **THR 0**. Higher settings prevent text decode on weak signals or noise. Tap **CWT** to exit text-decode setup.
- You'll probably want to turn on **CWT** as a tuning aid (pg. 34). This also enables auto-spot (applicable to PSK31 but not RTTY).

### DATA Mode Text Decode Tips:

- Use **FINE** tuning with **PSK D**. **SPOT** (or **auto-spot**) a signal first, then tune slowly in 1-Hz steps until recognizable words appear.
- If you call CQ using PSK31 mode, keep RIT on so you can fine-tune responding stations without moving your transmit frequency.
- In difficult conditions, reduce **WIDTH** to the per-mode minimum (typically 50 Hz for PSK31, 200 Hz for narrow-shift RTTY).
- In **AFSK A** and **FSK A** modes, the RTTY dual-tone filter may help (DTF, pg. 32).
- RTTY text may shift to *figures* due to noise. If you assign **CONFIG:TTY LTR** to a programmable function switch, you can tap it to quickly shift back to *letters*.

## CW-to-DATA

You can use data modes completely stand-alone (i.e., without a computer). Just turn on **text decode** (pg. 33), and send CW using the internal keyer.

CW messages can also be used for CW-to-DATA. This makes it easy to answer a CQ, send a contest exchange, or play a “brag tape” during a QSO.

To set up for CW-to-DATA operation:

- Referring to pg. 33, use **MODE**, **DATA MD**, **TEXT DEC**, and **PITCH** to set up **text decode**. Select either **FSK D** or **PSK D** mode. A small **T** should appear below the **DATA** icon.
- Try tuning in a few stations (turn on **CWT**; pg. 34). Tips for improved copy in tough band conditions are provided on pg. 33.
- Plug a keyer into the PADDLE jack. The first time you try CW-to-DATA, set **PWR** to 0 watts or use TX **TEST** mode (pg. 13).
- All CW you send will be transmitted as data and displayed on VFO B. You’ll hear a CW sidetone, as well as PSK or FSK tones. Adjust the data monitor volume using **MON**. To adjust the CW sidetone monitor level, temporarily switch back to CW mode.
- When calling CQ, use RIT to tune in stations that reply (especially important for **PSK D**).
- Whenever you pause, the K3 will remain in a data *idle* state for about 4 seconds before dropping. To extend the timeout, send BT, which is not transmitted as data.
- To cut the idle transmit period and exit to receive mode, send “. . . - -” (**IM**mediately exit). This character is not transmitted as data.
- When recording CW messages for use during CW-to-DATA, you can add “. . . - -” at the end to cut the idle time when they’re played back.

**i** The CW abbreviation for “and” (ES) is not used in data modes and might lead to confusion. Other prosigns can be used, including KN, SK, and AR.

**i** If you set VFO B for CW mode rather than DATA mode and use cross-mode **SPLIT** (pg. 36), your CW will not be converted to DATA.

## Tuning Aids: CWT and SPOT

Tapping **CWT** turns the upper half of the S-meter into a CW/DATA tuning aid. If no bar appears in the tuning area, the threshold may be set too high; hold **TEXT DEC** and select a lower **THR** value.

When a received CW or PSK31 signal is centered in the passband, the CWT display will appear as shown below.

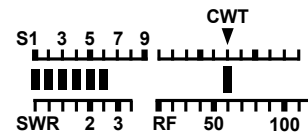

In RTTY modes (**AFSK A** and **FSK D**), mark and space tones are represented by three bars each, with mark to the left of the CWT pointer, and space to the right. When only weak signals are present in the mark/space filters, 1-3 bars will flicker on either side, leading to a “ghosting” effect, as shown here.

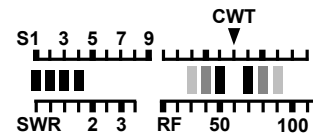

As you tune the VFO close to an RTTY signal, the number of bars will initially increase on one side or the other. Keep tuning until you see a rough balance between left and right bars. (Also see **DTF**, pg. 32, and *CONFIG:TTY LTR*.)

### Manual SPOT

If **CWT** is off, you can tap **SPOT**, then manually tune the VFO until the received signal’s pitch matches the sidetone. If you find pitch matching difficult to do, try auto-SPOT (below).

### Auto-SPOT

To use auto-spot, first turn on **CWT**. Use a narrow bandwidth (200 to 500 Hz). Tapping **SPOT** will then automatically tune in a received signal that falls within the CWT display range.

Auto-spot may not be usable if more than one signal is in the CWT range, if the signal is extremely weak, or if the code speed is very slow.

Auto-spot coarse-tunes PSK31 signals, but you’ll need to fine-tune them in 1-Hz steps (**FINE**).

## Audio Effects (AFX)

If you have stereo headphones or stereo external speakers, you can take advantage of the K3's DSP audio effects. These create an illusion of greater acoustic space. For many operators, AFX provides a less-fatiguing receiver sound.

**MAIN:AFX MD** is used to select the desired AFX setting. Available selections include **DELAY 1-5** (quasi-stereo), and **BIN**, which provides a constant phase shift between the left and right outputs.

Tap **AFX** to turn the selected effect on or off. This can be done even within the **AFX MD** menu entry.

**i** When the sub receiver is on, turning AFX on may not have any noticeable effect. This is because main/sub dual receive is already in stereo, with different material routed to each audio channel.

## APF and Dual-Passband CW Filtering

In CW mode, **DUAL PB** is used to turn on either an *Audio Peaking Filter (APF)* or *Dual-Passband Filtering*. Both are described below. **CONFIG: DUAL PB** selects the desired function.

**APF** can make a dramatic difference in copy of weak signals buried in noise. When APF is turned on, **SHIFT** fine-tunes the center pitch, and **NORM** resets the pitch to that of your sidetone. The filter graphic will be similar to that shown below.



**Dual-Passband Filtering (Dual PB)** sets up a 150-Hz-wide **focus** filter, set within a wider **context** bandwidth that is attenuated by about 20 dB. This lets you hear off-frequency CW signals, which may be useful if you're calling CQ, running a net, etc. **WIDTH** varies the width of the context filter. The filter graphic appears as above.

Hold **DUAL PB** again to exit APF or Dual PB.

**i** When using either APF or Dual PB, you should reduce the **WIDTH** setting if there are S9+20 or higher signals within the crystal filter passband. This will maintain optimal AGC performance.

## Receive Audio Equalization (EQ)

The K3 provides 8 bands of receive audio equalization via the **MAIN:RX EQ** menu entry. RX EQ can compensate for the physical acoustics of your station (room, headphones, speakers, etc.), or just to tailor the audio to your personal preference.

Two receive EQ setups are provided: one for CW mode, and the other for voice modes. RX EQ does not apply to DATA modes.

In the **RX EQ** menu entry, the VFO A display shows 8 individual vertical bar graphs. The example below shows various amounts of EQ for each band.

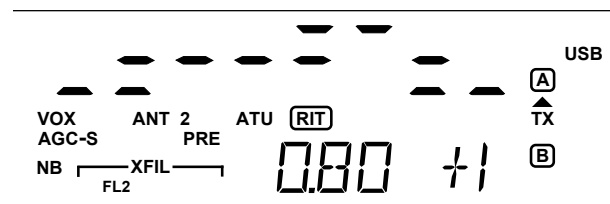

The center frequencies of the 8 audio EQ bands are 50, 100, 200, 400, 800, 1600, 2400, and 3200 Hz. To select a band to change, tap **1-8** on the keypad. For example, tapping **1** selects the 50-Hz band.

Next, rotate VFO A to specify boost or cut (+/- 16 dB). The illustration above shows the 800 Hz EQ band (**0.80** kHz) being set to **+1** dB of boost.

You can tap **CLR** to reset all of the **RX EQ** bands to **0** dB (no cut or boost).

## Transmit Audio Equalization (EQ)

Transmit audio equalization can compensate for microphones and voice variations. **MAIN:TX EQ** works exactly the same as **RX EQ**, and can be used during transmit.

Two transmit EQ setups are provided: one for SSB, the other for wideband voice modes (ESSB, AM, FM). TX EQ is not applicable to CW or DATA modes.

While adjusting **TX EQ**, you can monitor using headphones (use **MON** to set the level), or listen to your transmitted signal on another receiver.

## SPLIT and Cross-Mode Operation

Normally, VFO A is used for both receive and transmit. When **SPLIT** mode is selected, VFO B becomes the transmit VFO. In this case the **SPLT** icon turns on, the **TX** arrow points to **B** (pg. 12) and the yellow delta-F LED ( $\Delta f$ ) turns on if receive and transmit frequencies or modes differ.

Cross-mode operation is possible in some cases, such as SSB/CW. You can use **BSET** to directly change the mode of VFO B (pg. 22).

**i** You can transmit in CW when SSB mode is selected by just hitting the key or paddle; there's no need to use cross-mode split in this case. The SSB station will hear the signal at your sidetone pitch. See *CONFIG: CW WGHT*.

## Extended Single Sideband (ESSB)

An increase in SSB voice bandwidth may improve fidelity and reduce listening fatigue.

The K3's normal SSB receive bandwidth is about 2.7-2.8 kHz. If you have a 6 kHz filter installed, you can use  $\odot$  **WIDTH** to select a wider passband.

**ESSB transmit** is set up as follows:

- **A 6-kHz filter on the RF board is required.** Set this filter's bandwidth to exactly **6.00** kHz (*CONFIG: FLx BW*). It must also be enabled for AM transmit (switch to AM mode, then use *FLTX AM* to specify the filter number).
- Switch back to SSB mode. Locate *CONFIG: TX ESSB*, tap **1** to turn ESSB on, and use VFO A to select the desired transmit bandwidth. The **+** icon will turn on in the mode area of the LCD. See **cautions below**.
- ESSB, AM and FM have separate TX EQ from regular SSB, allowing you to optimize the transmit passband for these wider-bandwidth modes. See *MAIN: TX EQ*.
- Assign *TX ESSB* to a programmable function switch if you'll be turning it on/off frequently.

**⚠ Carrier and spurious signal suppression, passband shape, delay characteristics, fidelity, and other aspects of ESSB performance are not specified. Use ESSB only after carefully monitoring your signal.**

## General-Coverage Receive

The KBPF3 option module includes band-pass filters that cover the areas between ham bands. The K3 will switch between its narrow ham-band filters and the KBPF3 filters as you tune the VFOs.

A KBPF3 module can be installed on the RF board (main receiver) and/or KRX3 (sub receiver).

*CONFIG: VFO CRS* selects **COARSE** VFO tuning rate in each mode. AM coarse tuning rates include 5, 9, and 10 kHz.

**i** Sensitivity below 1.8 MHz will be reduced due to the high-pass response of the T-R switch, which protects the PIN diodes.

## VFO B Alternate Displays

The VFO B display can show time, date, RIT/XIT offset, supply voltage, current drain, KPA3 heatsink temperature (PA), and front panel temperature (FP). Tap **DISP** to turn the selected display on or off. Rotate VFO B to select the desired display.

If *CONFIG: TECH MD* is **ON**, additional VFO B alternate displays will be available. **PLL1** and **PLL2** show the main and sub synthesizer PLL voltages; if either is out of range, (\*) will appear. **AFV** shows the true RMS value of receiver AF output (mVp-p), unaffected by AF GAIN control. After the AFV reading stabilizes, you can use VFO B to select **dBV**, which is useful for comparative signal strength measurements. Also see *CONFIG: AFV TIM*.

**i** **AFV** and **dBV** apply to the sub receiver if it is turned on. In this case, you may want to select diversity mode (pg. 38) so you can tune the sub receiver's frequency with VFO A.

## Alarm and Auto Power-On

Once you've set the K3's real-time clock (*CONFIG: TIME*), you can use *MAIN: ALARM* to set an alarm. This can be used to remind you of a schedule or net, or to start warming up for a contest.

When an alarm is set, (\*) appears in the time display. (Time can be displayed by tapping **DISP**.)

**⚠** The K3 will turn **ON** automatically if it was off at alarm time. It will be on the last-used band.

## Using the Sub Receiver

The KRX3 option adds an independent, high-performance *sub receiver* to the K3. It allows you to monitor a second frequency, using different bandwidths or modes. *Diversity receive* is possible if the main and sub receivers use different antennas.

### *Dedicated Sub Receiver Controls*

**Tapping** **[SUB]** turns on the sub receiver (and **SUB** icon). VFO B then controls the sub's frequency, and also serves as the TX frequency during SPLIT.

**i** You should leave the sub off when not in use. This turns off the -3 dB passive splitter used when the sub shares the main receiver's antenna path.

**Holding** **[SUB]** links the VFOs (whether the sub receiver is on or off). The kHz decimal point of **VFO B** flashes as a reminder. VFO A is the master, moving both VFOs in tandem.

**Holding** **[SUB]** for 2 seconds or longer turns on diversity receive (pg. 38). The kHz decimal point of **VFO A** flashes as a reminder. VFO A controls both the main and sub frequencies in diversity receive, but VFO B remains independent so it can be used as the SPLIT transmit frequency.

☉ **SUB AF** gain normally sets the sub's volume level. Alternatively, **SUB AF** can be used as a main/sub balance control (see *CONFIG:SUB AF*). With stereo headphones or dual speakers, you'll normally hear main on the left and sub on the right. *CONFIG:L-MIX-R* selects various alternate combinations of main/sub audio mixing.

**⚠** *CONFIG:SPKRS* must be set to 2 if you use stereo speakers; otherwise, set it to 1.

☉ **SUB RF** gain normally sets the sub receiver's RF GAIN level. If this knob is assigned to main/sub squelch (*CONFIG:SQ MAIN*), then RF gain for main/sub is controlled by the main RF gain control.

### *BSET: Additional Sub Receiver Settings*

Normally, receive controls apply only to the main receiver. This includes SHIFT, WIDTH, **[PRE]**, **[ATTN]**, etc., as well as **[MODE]**. To change these settings for the sub receiver, first hold **[BSET]**. VFO A will show **BSET**, and the S-meter will show the sub receiver's signal level. After you've made the desired sub receiver changes, tap **[A/B]** or hold **[BSET]** to exit **BSET**.

**i** The sub receiver's band cannot be set independently unless *CONFIG:VFO IND* is set to **YES**. If it's set to **NO**, you'll see **=MAIN** when you tap **[BAND]** during **BSET**, and the sub receiver band will always be set the same as main.

### *Sub Receiver Antenna Selection*

The sub receiver gets its RF input either from the main receiver (sharing ANT 1-2 or RX ANT IN), or from its auxiliary antenna input (see pg. 41).

When using **BSET**, you can tap **[ANT]** to switch the sub between **MAIN** (shared) and **AUX** (the sub's AUX input). When **MAIN** is in effect, the **1-2** and **RX** icons show which antenna the sub is sharing with the main receiver. When **AUX** is in effect, these icons will all be off (if *CONFIG:KRX3* is set for **ANT=BNC**) or will show the non-transmit ATU antenna, **1** or **2** (if *KRX3* is set for **ANT=ATU**).

**Shortcut:** If you're not in **BSET** mode, you can quickly switch the sub between **MAIN** and **AUX** by holding **[RX ANT]**. (*Tapping* **[RX ANT]** turns RX ANT on/off for the main path.)

**⚠** The sub receiver's AUX antenna must be well-isolated from the transmit antenna to avoid activating the sub's carrier-operated relay.

**i** Using the AUX input for the sub receiver slightly improves sensitivity of both the main and sub receivers because the splitter is not used.

### *Sub Receiver Band Independence*

If *CONFIG:VFO IND* is set to **YES**, you can set the sub receiver to a different band from main. Hold **[BSET]**, then tap **[BAND]** up/down to select the sub receiver's band. If you only use band-independence for the sub occasionally, you may want to assign *VFO IND* to a programmable function switch (pg. 21).

**⚠** If the two receivers are sharing the main antenna path, putting the sub receiver on a higher-frequency band than main may result in signal loss in the sub. This is due to sharing of the main receiver's low-pass filters. If you select an incompatible band combination, the K3 briefly displays **USE AUX** as a warning. To avoid sub receiver signal loss, use the sub's AUX input.

## ***Diversity Receive***

Diversity receive can greatly improve signal copy during fading (QSB). True diversity requires a pair of identical receivers running from a common frequency reference and using two different antennas. The K3 is one of very few transceivers that offer this capability. Most offer only a low-performance sub receiver, or “dual watch” (split-I.F.) circuitry, which doesn’t provide for separate main/sub antennas.

An antenna with different polarization, or at least different orientation, should be used for the sub receiver (via its AUX input). This ensures that the two receivers will not experience the same fading characteristics.

**To turn on diversity mode:** Hold **[SUB]** for 2 seconds or longer. This sets the sub to the same frequency as main (VFO A), matches the sub’s filter bandwidth to main, and switches the sub receiver to its AUX antenna. The kHz decimal point of the VFO A display flashes as a reminder. VFO A sets the receive frequency for both main and sub in diversity mode. This leaves VFO B free for use as the transmit frequency in SPLIT mode (see details at right).

Mode and filtering changes made to the main receiver will immediately be made at the sub, as well, to preserve diversity characteristics. However, **[PRE]**, **[ATTN]** and other receive controls remain independent for the sub. These must be changed using **[BSET]**.

You can change the sub receiver’s antenna selection by holding **[BSET]**, then tapping **[ANT]**. When you’re not using BSET, holding **[RX ANT]** will accomplish the same thing, providing a convenient shortcut.

**i** The K3 saves the sub’s MAIN/AUX selection independently for diversity and non-diversity. AUX should be used for diversity, as explained above. You might use MAIN with diversity when comparing main/sub receiver gain, such as when adjusting crystal filter gain compensation (**CONFIG:FLx GN**). The built-in true-RMS voltmeter is ideal for this purpose. Entering diversity mode will allow you to tune both receivers with VFO A, while VFO B displays the voltage (see **AFV/dBV**, pg. 36).

## ***Sub Receiver Crystal Filter Considerations***

Like the main receiver, the sub has slots for up to five crystal filters. For best dynamic range, we strongly recommend the use of the narrowest filter consistent with each operating mode. CW and DATA operators should have at least one narrow filter, e.g. 400 or 500 Hz, on each receiver.

For diversity receive, we recommend using identical crystal filter configurations for the two receivers. This will ensure that both receivers have the same characteristics when strong QRM is present.

You should also use crystal filters with closely matched offsets (**CONFIG:FLx FRQ**). Otherwise, you may hear a slow phase modulation (similar to a beat note) between the two receivers on some signals. 8-pole filters are already matched (**FLx FRQ** = 0.00). Elecraft can provide pairs of 5-pole crystal filters with offsets within 40 Hz of each other on request. When setting up **FLx FRQ**, use the **average** of the filters’ marked offsets as the value entered for **both** filters (main and sub). If you enter different offsets, you’ll hear phase modulation, even if the offsets are very close.

## ***SPLIT Mode with the Sub Receiver***

With the sub receiver installed, in a sense all operation is “split,” since you listen on the sub’s frequency (VFO B) and listen/transmit on the main RX/TX frequency (VFO A). Cross-mode and even cross-band operation is possible in this case. Cross-band operation may require the use of the sub’s AUX antenna source to avoid the low-pass filter problem described on the previous page.

If you do turn on **[SPLIT]**, the VFO’s roles are reversed, with VFO B controlling the transmit frequency, and VFO A used only for receive. The advantage of this is that the receive controls are always “visible” for VFO A, while receive controls for VFO B must be accessed using **[BSET]**.

**Diversity with SPLIT:** In diversity mode you can still use SPLIT, but both receivers will be set to the frequency of VFO A. Both receivers will always be in the same mode, and will use the same filter settings.

## Receive Antenna In/Out

The **RX ANT IN/OUT** jacks, supplied with the KXV3 option, have various uses:

- **Low-noise receiving antenna:** Some operators use a Beverage, tuned loop, or other low-noise receiving antenna. You can connect such antenna to the RX ANT IN jack, then tap **RX ANT** to select it. The **RX** icon will turn on.
- **Narrowband filters or preamps:** You can "patch in" a specialized filter or preamp (e.g., the Elecraft PR6 preamp for 6 meters) between RX ANT IN / OUT. Tap **RX ANT** to switch the filter in (per-band). It will be in-line only during receive, so you can use low-power devices.
- **Test signal injection:** The RX ANT IN jack is ideal to inject a test signal, because the generator won't be damaged if you transmit.
- **Receiver comparisons:** If you connect the RX ANT OUT jack to a second receiver, and leave the RX ANT IN jack open, you can A/B test the K3 against the other receiver. When the **RX ANT** is not selected (**RX** icon off), the K3 will be receiving on its main antenna jack, and the other receiver will have no input. If you then tap **RX ANT**, the K3 will have no receive antenna, while the other receiver will be operating from the K3's main antenna.

**⚠** If you're comparing the K3 to a transceiver and using its transmit/receive antenna, be sure to set its power to 0 so you won't damage the KXV3 when you transmit.

## Buffered I.F. Output

The KXV3 provides a buffered receive I.F. signal at the IF OUT jack (~8.215 MHz). This signal is compatible with panadapters, such as the P3 (pg. 45). Refer to panadapter's manual for interfacing and operating instructions. The frequency of the receive I.F. for a given mode/filter setting can be queried by a computer using the command "**FI**;" (refer to the **K3 Programmer's Reference**).

**⚠** Use a short, high-quality coax cable between the K3 and the panadapter. Additional isolation circuitry may also be required.

## Using Transverters

Nine user-definable bands are provided for use with transverters. These can be used with the Elecraft K144XV internal 2-m module, Elecraft XV-Series, or other transverters. See pg. 18 for connections.

### Transverter Band Setup

Transverter bands are set up using the **XV** menu entries. Tap **1**–**9** within menu entries to select a transverter band to configure.

- Set **XVn ON** to **YES** to enable band **n**.
- **XVn RF** sets the operating frequency (MHz).
- **XVn IF** specifies the I.F. band (7, 14, 21, 28, or 50 MHz). Use 28 MHz for the K144XV option.
- **XVn PWR** sets maximum K3 power output for the current transverter band, in two ranges: **L .01-L1.27** specifies a power level in **milliwatts**; the RF bar graph reads in tenths of a milliwatt in this case. (Requires the KXV3 option. The KXV3 provides XVTR IN and OUT jacks for external transverters, and internal IF signal routing for the K144XV.) **H 0.0-H12.0** specifies power in **watts**, and selects the K3's main ant. jack(s) for IF output.
- **XVn OFS** can compensate for frequency offset in the transverter's oscillator. Two offsets are provided for the K144XV (see **XVn OFS**).
- **XVn ADR** specifies a transverter select address. Use **INT. TRN0-9** with the K144XV (see **XVn ADR** description for details).

**i** **For weak-signal work:** If you have a **KXV3**, you can improve isolation between XVTR IN/OUT and RX ANT IN/OUT by removing any antenna connected to RX ANT IN. If you have a **KAT3**, tap **ANT** to select the antenna (1 or 2) that has lower sensitivity on the I.F. band in use. (**Note:** The **ANT 1/2** icons are not displayed if **XVn PWR** is set for **L** power range. Use **H** temporarily to see the icons.)

**⚠ CAUTION:** When possible, use mW-level drive and the XVTR IN/OUT jacks with transverters (see **XVn PWR**). If you use high power, via ANT1 or 2, you could accidentally damage a low-level transverter.

## Scanning

The K3's scanning features let the K3 tune any band segment continuously, with or without the receiver muted. Scanning can be used to monitor any portion of a band, from a 1-2 kHz range where a station or net is expected to appear, to an entire band. (6-meter scanning range is limited to 50-54 MHz by default; contact Elecraft for details.)

Scanning while muted (normal scanning mode) allows the K3 to ignore stable carriers, unmuting only when "interesting" signals are found. Scanning unmuted ("live" scanning mode) is especially useful when listening for weak signals on very quiet bands. Both are covered below.

### Scanning Setup

To use scanning, you first need to store the desired tuning endpoints (VFO A and B) in a memory. After that, you'll be able to simply recall the memory, then start scanning. You can set up scanning ranges for various bands, modes, etc.

To set up a memory for scanning use:

- Set VFO A to the starting frequency, and VFO B to the ending frequency.
- Select the operating mode, preamp/attenuator settings, and filter bandwidth. Also select the tuning rate (using **FINE**, **COARSE** and **RATE**), which affects speed of scanning.
- Store this setting in any memory (pg. 16).

To start scanning:

- Recall a saved scanning memory using **M ▶ V**.
- Hold **SCAN** to start scanning. To scan with the receiver live (unmuted), continue to hold **SCAN** until you see **AF ON** (about 2 seconds).

To stop scanning, rotate VFO A manually, or tap any switch, key, keyer, or mic PTT switch. To restart, hold **SCAN**.

**i** If the sub receiver is on the same band as the main receiver, and the sub is turned on, you can tune VFO B/sub manually while VFO A/main is scanning.

## Channel Hopping

Scanning or manually tuning VFO A over a numbered *memory* range, rather than a *frequency* range, is referred to as **channel hopping**. This is included in the K3 primarily for use on 60 meters, 6 meters, and transverter bands, although it can be used on any band.

**i** The U.S. 60-meter channel assignments correspond to VFO settings of 5330.5, 5346.5, 5366.5, 5371.5, and 5403.5 kHz. USB is the only mode allowed on this band.

**⚠** **Memories to be used for channel hopping must be within the same band and have consecutive numbers. They also require a text label that starts with an asterisk (\*).**

To set up channel hopping:

- Set VFO A to the first frequency in the intended channel-hopping range. (VFO B does not have to be set higher than VFO A for channel hopping purposes.)
- Tap **V ▶ M**, then select a memory (**00-99**) using VFO A. For the five 60-meter channels, we suggest using memories 61-65. Start with memory 61 for 5330.5 kHz (US), or your country's first 60-meter allocation.
- Rotate VFO B to select each memory label position in turn as indicated by the cursor.
- Use VFO A to change characters. The first character must be an asterisk (\*); other label characters are optional.
- After editing, tap **V ▶ M** again.
- In the same manner, set up all other memories to be used for channel hopping.

To enable channel hopping (manually, with VFO A, or via scanning), tap **M ▶ V**, use VFO A to locate one of the memories in the sequential range set up earlier, then tap **M ▶ V** again. VFO A will now cycle through this range of memories as you turn it. To disable channel hopping, tap **RATE** or **FINE** or change bands.

To start channel-hop scanning, hold **SCAN**. You can also use "live" scanning as mentioned at left.



# Main and Sub Receiver Antenna Routing

The simplified block diagrams in this section show how antennas are routed to the main and sub receivers. Heavy lines show the default RF path. All antennas are protected from electrostatic discharge by surge arrestors. Receive-only antenna inputs, indicated by asterisks (\*), include carrier-operated relay circuitry (C.O.R.).

## Basic K3 (no KAT3 or KXV3)

As shown in Figure 1, the basic K3 is supplied with one antenna jack (ANT1, SO239). The signal from ANT 1 is routed through the **antenna input module** (KANT3) to the main receiver (as well as to the transmitter). The KRX3 sub receiver, if installed, can share the ANT 1 signal via a passive splitter and relay K1. When the sub receiver is off or is switched to its AUX RF input (dotted line), K1 bypasses the splitter so it will have no effect on either receiver.

An extra RF I/O connector location is provided (AUX RF, BNC). The sub receiver's AUX RF input can be routed to this connector internally. K1 then selects either the main RX path or AUX RF as the sub receiver's RF source. Any receiving antenna connected to AUX RF must be isolated from the transmit antennas so the sub receiver's C.O.R. will not be activated during transmit. **Note:** The sub receiver has its own full set of ham-band and optional general-coverage band-pass filters (KBPF3), but its image rejection will be best when sharing the main path, which includes the receive/transmit low-pass filters.

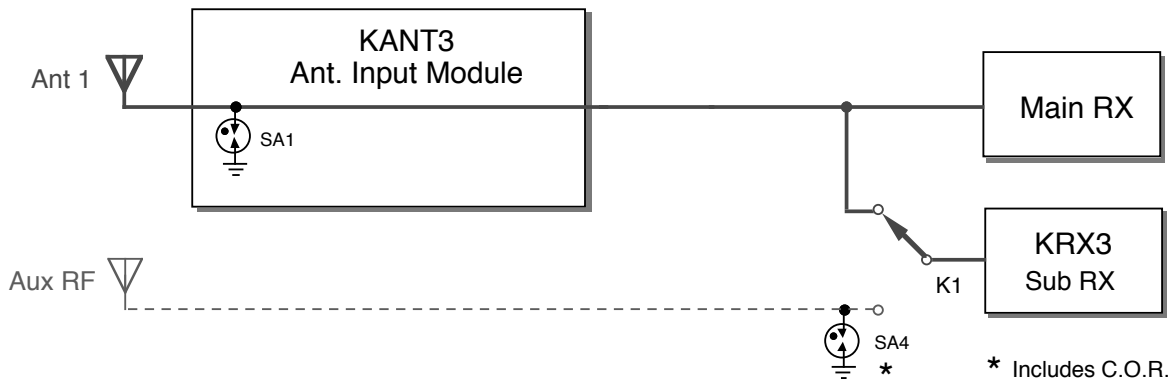

Figure 1. Basic Main/Sub Receiver Routing (no KAT3 or KXV3)

## K3 with KXV3 RF I/O Module

If the KXV3 option is installed (Figure 2), a separate receiving antenna can be connected to the RX ANT IN jack. Relay K2 then selects either ANT1 or RX ANT for the main receiver. **Note:** The low-pass filters will not be in the path when RX ANT is selected. This will rarely be an issue, since the main receiver has a full set of ham-band band-pass filters. You can use external filters with RX ANT IN if required.

Relay K1 allows the sub receiver to share the main receiver's RF source, or use its AUX RF input. This means that two receiving antennas could be used – one for each receiver. The two inputs could also be joined externally with a 'Y' adapter.

Not shown is the RX ANT OUT jack. The RX ANT IN/OUT jacks can be used together to "patch in" an external band-pass or low-pass filter or low-noise preamp such as the Elecraft PR6 (6 meters). If such a device is powered, it can be turned on or off on a per-band, per-antenna basis using the *CONFIG:DIGOUT1* menu entry.

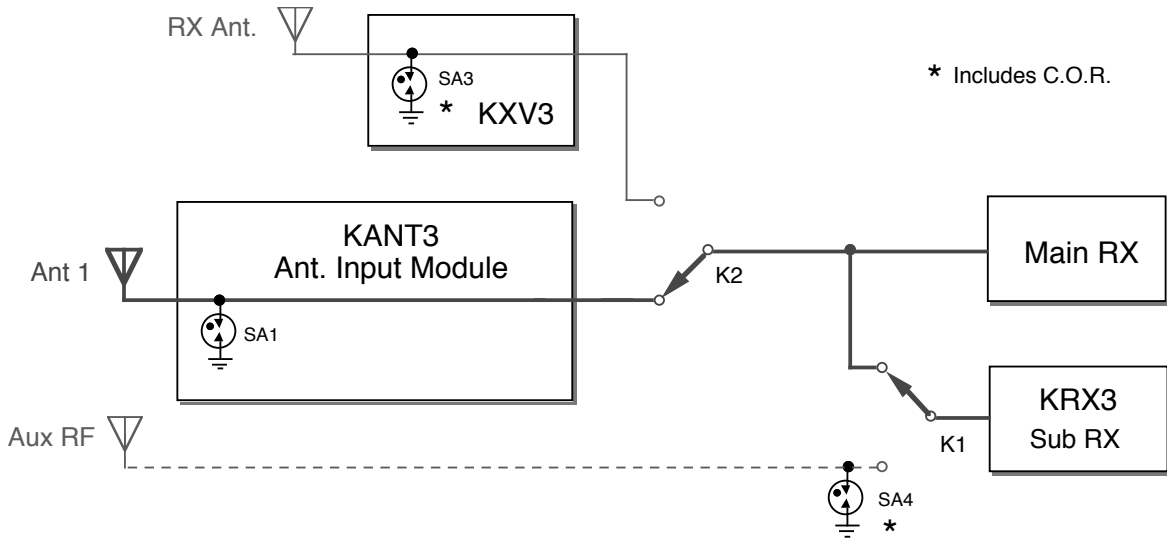
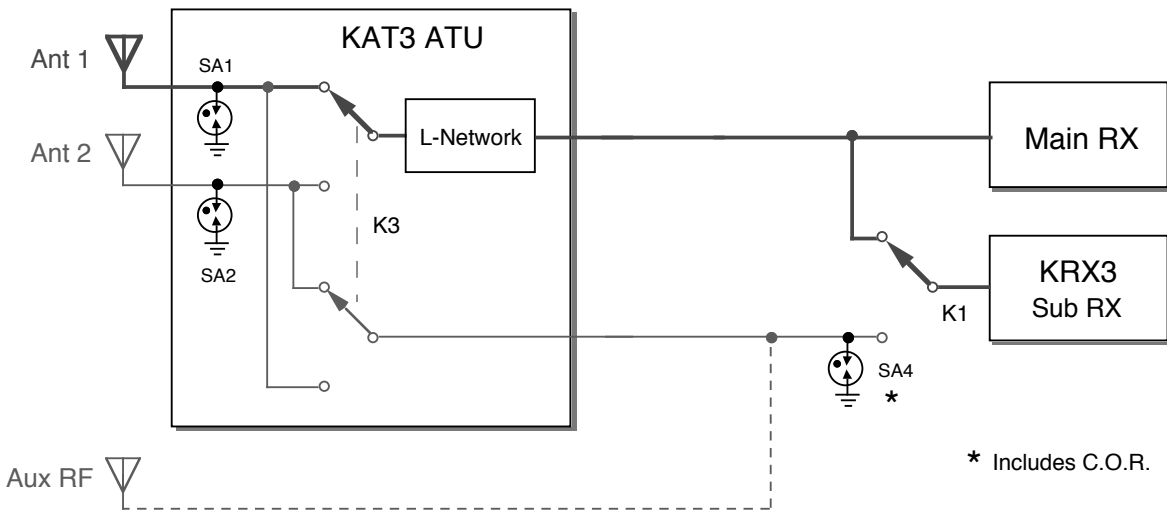

**Figure 2. Main/Sub Receiver Routing with KXV3 Installed**

### K3 with KAT3 ATU

The KAT3 internal ATU, which replaces the KANT3 antenna input module, provides a second SO239 antenna jack (ANT 2). As shown in Figure 3, relay K3 routes either ANT 1 or ANT 2 to the main RF path. The antenna *not* routed to the main path (the *non-transmit* antenna) can optionally be used as the sub receiver’s AUX RF antenna. This requires that the two antennas connected to the KAT3 be well isolated from each other. If not, the sub receiver’s carrier-operated relay may turn on during transmit. If this occurs, you must either move the two antennas farther apart, or not connect the sub receiver to the KAT3.

It may be preferable to connect the sub receiver’s auxiliary RF input to the AUX RF connector on the rear panel. A well-isolated receiving antenna can then be used with the sub receiver when required. (See *CONFIG:KRX3*, for sub receiver antenna setup.)



**Figure 3. Main/Sub Receiver Routing with KAT3 Installed**

### K3 with KAT3 and KXV3

Figure 4 shows the antenna possibilities with both the KAT3 and KXV3 installed. The main receiver can use ANT 1, 2, or RX ANT IN. The sub receiver can either share the main receiver's RF source, or use its AUX RF input. The latter can be either the non-transmit KAT3 antenna or the AUX RF BNC connector, as described earlier. In either case, the sub receiver's antenna must be isolated from the transmitting antenna.

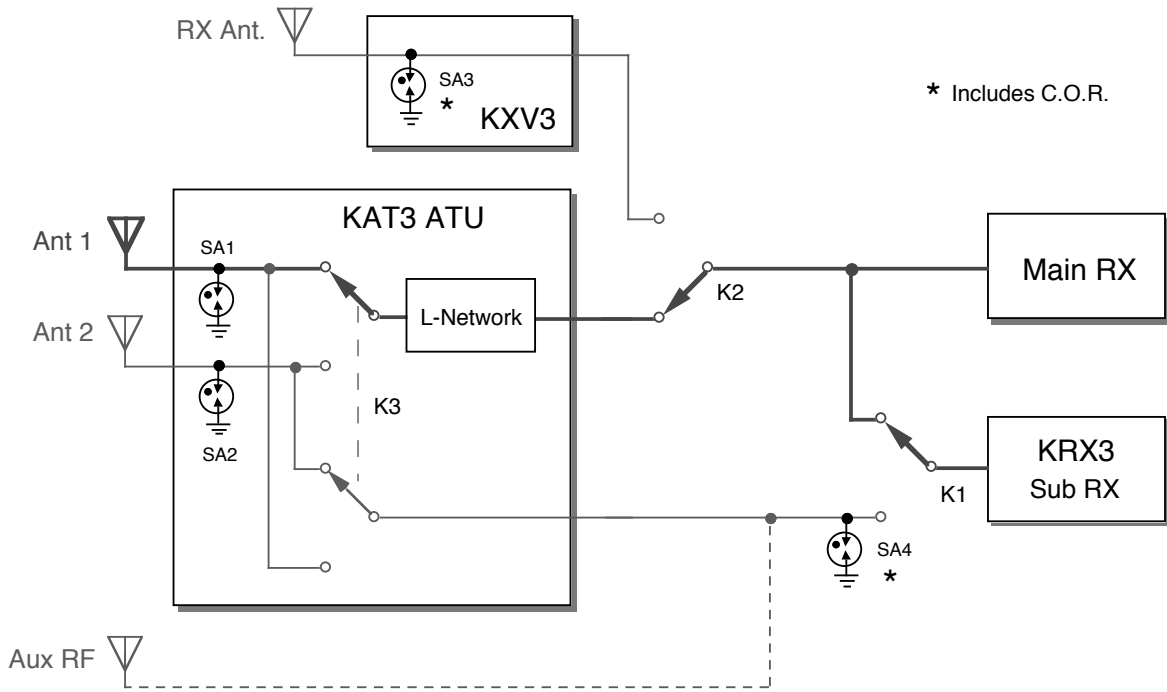

**Figure 4. Main/Sub Receiver Routing with KXV3 and KAT3 Installed**

# Remote Control of the K3

With appropriate software, any computer with an RS232 port (or a USB-to-RS232 adapter) can be used to control the K3. Connections needed for RS232 communications are covered on pg. 18.

Third-party logging and contesting software is available for various computers and operating systems. Most applications written for the K2 should work with the K3, and some provide K3-specific features.

For a list of K3-compatible software applications, including configuration requirements, please visit

[www.elecraft.com/K3/k3\\_software.htm](http://www.elecraft.com/K3/k3_software.htm)

## Remote-Control Commands

The K3 has a rich set of remote-control commands, including many commands that directly control the two DSPs. With appropriate software, various extensions to DSP functionality can be made available to the operator, including customized filters, fine control over noise reduction, per-mode parametric EQ, absolute level metering in dB, and unique tuning aids.

K3 remote-control commands use ordinary ASCII text, so they can be easily tested using a terminal emulator. For example, the command “FA;” returns the current VFO A frequency. Using the same command, you can *set* the VFO A frequency, e.g. “FA00007040000;” sets the VFO to 7.040 MHz.

Many new commands are provided in addition to the core set of commands supported by the K2. Some existing commands have been updated to directly control the sub receiver (e.g., “AGS;”, which controls sub AF gain). Please refer to the **K3 Programmer’s Reference** for further details.

## Front-Panel Switch Macros

You can set up any programmable front-panel switch (e.g. **PF1**) to execute sequences of remote-control commands directly from the K3. This is useful for automation of sequences such as: enter split mode, assign VFO A to B, move VFO B up 5, and turn on diversity receive. Refer to **K3 Utility** help or the **K3 Programmer’s Reference** for examples. Also see `CONFIG:MACRO x`.

## Remote Power On/Off

A remote-control system can pull the POWER ON line to ground (ACC connector, pg. 18) to turn the K3 ON. To turn it OFF, the controller must send the K3 a “PS0;” remote-control command via the RS232 interface, wait at least 100 ms, then deactivate the POWER ON signal. This sequence ensures that nonvolatile memory is updated correctly before shut-down.

## Automatic Antenna Control

Some antenna control units (e.g., those used with SteppIR™ antennas) can track the K3’s band and frequency by watching for “IF;” (rig information) packets from the transceiver. Some computer logging/contesting applications set up the K3 to output these messages periodically, allowing the antenna control unit to “eavesdrop.”

If you’re not using such software, or if you’re not using a computer at all, you can still set up the K3 to output “IF;” packets periodically by setting `CONFIG:AUTOINF` to **AUTO 1**. The packets are sent once per second while the VFO frequency is being changed, as well as on any band change.

**⚠ If you’re using logging/contesting software, check with the manufacturer before setting AUTOINF to AUTO 1. Some applications may not be tolerant of unsolicited “IF;” packets.**

## CW/DATA Terminal Applications

The K3 directly supports CW/PSK31/RTTY ASCII text transmit and receive via its RS232 port. Our **K3 Utility** application includes a simple Terminal function that lets you try out these modes using your computer’s keyboard and monitor.

## K3 Memory Editor

Frequency memories can be easily viewed and changed using our **K3 Memory Editor** software application. This program shows the contents of all 100 regular memories and optionally the per-band memories in a spreadsheet format.

You can also QSY directly to a memory from within the editor program using the provided buttons.

## Options and Accessories

**KPA500:** 500 Watt+ high-performance 160-6 m amplifier with built-in low-noise power supply and automatic drive-level control (*CONFIG:PWR SET*). Same size and styling as the K3.

**P3:** The P3 is a fast, very sensitive panadapter with a high-resolution display that shows signals over a 2 to 200 kHz portion of the band. It is styled to match the K3, and does not require a PC for operation.

**K144XV:** 2-meter Module; requires KXV3A. K144RFLK option locks 2 m to main reference.

**Crystal Filters:** A wide variety of roofing filters can be installed, from 200 Hz to FM bandwidths.

**KSSKT:** Stainless-steel exterior hardware kit.

**KAT3:** Wide-range internal 100-W automatic antenna tuner with dual antenna switch. The ANT2 connector is supplied with this option.

**KPA3:** Internal 100-W upgrade for the K3/10, with two large fans and separate circuit breaker.

**KDVR3:** Digital voice recorder, usable both for transmit messages and general audio recording.

**KRX3:** High-performance, fully-independent sub receiver with its own set of crystal filters, 32-bit DSP, noise blanker, general-coverage band-pass filter array (KBPF3, below), and antenna input.

**KBPF3:** General-coverage band-pass filter array that allows the K3 main and/or sub receiver to cover the entire LF and HF range of 0.5 to 30 MHz.

**KXV3:** RF I/O module, including receive antenna in/out jacks (see pg. 39), transverter interface (pg. 39), and a buffered I.F. output (pg. 39). The RX ANT IN/OUT jacks can be used to patch-in external filters or low-noise preamps.

**KTCXO3-1:** High-stability TCXO; 1 PPM nominal, typically better than 0.5 ppm (see calibration instructions, pg. 50).

**K3EXREF:** Locks the K3's synthesizer to an external reference (see *CONFIG:REF CAL*).

**PR6:** This ultra low-noise 6-m preamp connects directly to the KXV3's RX ANT IN and OUT jacks. It can be then enabled for receive on 6 m by tapping **RX ANT**, and turned on using the DIGOUT1 signal (ACC jack, pg. 18, and *CONFIG:DIGOUT1*). BYPASS jacks are provided for use of RX ANT IN/OUT on other bands.

## Firmware Upgrades

New features and improvements are available to all K3 owners via firmware upgrades. Upgrades may also be required when you install option modules.

Please visit the Elecraft K3 software page ([www.elecraft.com/K3/k3\\_software.htm](http://www.elecraft.com/K3/k3_software.htm)) to obtain our free firmware download application, **K3 Utility**. This program runs on PCs, Macs, and Linux platforms. In addition to firmware downloading, **K3 Utility** provides automated RX and TX gain calibration, a custom sign-on banner, configuration save/restore, crystal filter setup, CW/DATA message editing, and a terminal function.

**⚠ Some applications or peripheral devices may interfere with K3 downloads; check the Help information in K3 Utility if you have difficulty.**

If you don't have Internet access, you can obtain a firmware upgrade on CD. If you don't have a computer, you can send your K3 to Elecraft to be upgraded. See **Customer Service**, pg. 10.

### *Checking your Firmware Revision*

Use the CONFIG menu's *FW REVS* menu entry to determine your firmware revision. The serial number of your transceiver, if needed, can be obtained using the *SER NUM* menu entry.

### *K3 Firmware Self-Test*

If the K3 detects an error in its firmware (an incorrect **checksum**), it will flash the **TX LED** and show **MCU LD** on the LCD (with backlight off).

If this occurs, connect the K3 to your computer and reload firmware. While firmware is loading, the Delta-F LED ( $\Delta f$ ) will flash. When the download is complete, the K3 should reset and run normally.

### *Forcing a Firmware Download*

If you accidentally load an old or incompatible firmware version and find the K3 unresponsive, do the following: (1) unplug the K3 from the power supply and wait 5 seconds; (2) plug the power supply back in; (3) hold the K3's **POWER** switch in; after about 10 seconds, you'll see the **TX LED** flash (you'll also see **MCU LD** on the LCD); (4) load the correct firmware version.

# Configuration

Configuring your K3 involves installing options and crystal filters, then customizing menu settings.

Options come with their own installation manuals. Once they're installed, they must be enabled using their associated menu entries (see pg. 53).

## Crystal Filter Setup

Crystal filter installation is covered in detail in Appendix A (pg. 77). Once filters have been installed (or moved), follow the steps below.

**i** The *K3 Utility* software application can also be used to view or change crystal filter settings; click on *Configuration* tab / *Edit Crystal Filters*.

### Filter Bandwidth

- Turn the K3 on.
- Hold **CONFIG** to access the CONFIG menu.
- Locate the *FLx BW* menu entry, which will be used in the next step to set up filter bandwidths. “x” will be replaced with 1 through 5, corresponding to crystal filters FL1-FL5.
- Tap **SUB** if you're setting up sub receiver filters. The **SUB** icon will flash.
- Tap **1** or use **XFIL** to select **FL1**.
- Using VFO A, adjust the bandwidth parameter so that it matches the filter installed at the FL1 position. Use the filter information table you filled out in Appendix A.
- Select the remaining filters by tapping **2** through **5** or **XFIL**, adjusting their bandwidth parameters according to the table.
- Stay in the menu for the next filter setup step.

### Filter Frequency Offset

- Use VFO B to find the *FLx FRQ* menu entry.
- If you're setting up sub receiver filters, make sure the **SUB** icon is still flashing (tap **SUB** if necessary).
- Tap **1** or use **XFIL** to select **FL1**.
- Adjust VFO A so that the parameter matches FL1's marked frequency offset (as recorded in

the filter information table, Appendix A). The default value, **0.00**, corresponds to the nominal filter center frequency of 8215.0 kHz. Most 5-pole filters will have an offset, e.g. “-0.91”. (This has no effect on performance; firmware compensates for the offset.)

- Select the remaining filters and adjust their frequency offsets as required.

### Receive Filter Enables (Per-Mode)

You must specify which of the five crystal filters is enabled for receive in each mode.

- Use VFO B to locate the *FLx ON* menu entry.
- Tap **SUB** if you're setting up sub receiver filters.
- Tap **MODE** until the **LSB** icon appears. If you see the **USB** icon instead, hold **ALT** (left end of the **MODE** switch) to select **LSB**.
- Tap **1** or use **XFIL** to select **FL1**.
- Set *FL1 ON* to **YES** or **NO** using VFO A. You should enable both narrow and wide filters for use in SSB modes, since they may be used during copy of data, SSB, or AM signals.
- Use **XFIL** to go to FL2-FL5 in turn, and enable or disable these filters for LSB mode.
- Tap **MODE** to select each of the other modes in turn (USB, CW, DATA, AM, and FM). For each mode, set up the FL1-FL5 enables.

### Filter Loss Compensation

You can compensate for the greater loss of narrow crystal filters by specifying added per-filter gain.

- Use VFO B to find the *FLx GN* menu entry.
- Tap **SUB** to set up sub receiver filters. Otherwise, make sure the **SUB** icon is OFF.
- Tap **1** – **5** or **XFIL** to select a filter to modify.
- Use VFO A to set the gain in dB. In general, you'll want to add 1-2 dB for 400-500 Hz filters, and 3-4 dB for 200-250 Hz filters.
- Select any additional filters that require added gain, and adjust their gain amounts.

## Transmit Crystal Filter Selection (Per-Mode)

This step applies only to filters on the RF board.

- Select CW mode by tapping **MODE**.
- Use VFO B to find the *FLTX CW* menu entry.
- Rotate VFO A to select a CW transmit filter (2.7 or 2.8 kHz). **Note:** Key clicks may result if a narrower filter is selected for CW transmit.
- Tap **MODE** to select **LSB** or **USB**. The menu entry will become *FLTX SB*.
- Select the filter to be used during SSB and DATA transmit (2.7 or 2.8 kHz).
- If applicable, select a 6-kHz filter for AM and ESSB (*FLTX AM*), and 13.0 kHz for FM (*FLTX FM*).

**i** If you're using a 2.7-kHz 5-pole filter for SSB transmit, you can optionally fine-tune its *FLX FRQ* parameter to equalize LSB and USB transmit characteristics. Monitor with a separate receiver and use headphones, or have another station listen.

## Option Module Enables

K3 options can be installed at any time.

**A** Once an option has been installed, use the associated CONFIG menu entry to enable it (see below). Then turn the K3 off for 5 seconds, and back on. This allows the K3 to find and test the module.

- **KAT3** ATU module: set *KAT3* to **BYP**.
- **KBPF3** general-coverage band-pass filter module: set *KBPF3* to **NOR** (if you're installing a KBPF3 on the sub receiver, tap **SUB** while in the menu entry).
- **KXV3** RF I/O module: set *KXV3* to **NOR**.
- **KRX3** sub receiver: set *KRX3* to match your selected wiring for the sub receiver's AUX antenna: **ANT=ATU** (KAT3) or **ANT=BNC** (AUX RF jack, rear panel). For details on sub receiver antennas, see pg. 37. You may also need to set up crystal filters for the sub receiver.
- **KDVR3** voice recorder: set *KDVR3* to **NOR**.
- **KPA3** amplifier module: set the *KPA3* menu entry to **PA NOR**. See menu entry listings for information on other settings.

## Miscellaneous Setup

We suggest setting up at least the menu entries below. You may wish to review the other menu entries as well, starting on pg. 52.

### Mic Gain / Bias

*MAIN:MIC SEL* is used to select either the front- or rear-panel mic, or **LINE IN**. If a mic is selected, you can also tap **1** to select **Lo** or **Hi** mic gain range, and tap **2** to toggle mic bias on/off. See pg. 13 for Elecraft mic bias recommendations.

### AF Gain Range

*CONFIG:AF GAIN* specifies **LO** or **HI** AF gain range. The default is **HI**.

### Time and Date

*CONFIG:TIME* sets the 24-hour real-time-clock (RTC). Tap **1** / **2** / **3** to adjust HH/MM/SS using VFO A. *K3Utility* can also be used to set the time.

*CONFIG:DATE MD* selects US (**MM.DD.YY**), or EU (**DD.MM.YY**) date format using VFO A.

*CONFIG:DATE* is used to set the date. Tap **1** / **2** / **3** to adjust MM/DD/YY or DD/MM/YY.

### VFO Setup

Several CONFIG menu entries are provided to control VFO behavior:

- *VFO CRS* sets up the **COARSE** tuning increment in kHz (separate for each mode). Tap **1** to turn rounding on/off.
- *VFO CTS* specifies the number of counts per knob turn (VFO A and B): **100**, **200**, or **400**
- *VFO FST* selects the normal VFO fast tuning rate (**20** or **50** Hz)
- *VFO IND*, if set to **YES**, allows VFO B to be set to a different band than VFO A.

### Sign-On Banner

You can have your call sign or other message shown on power-up. Use *K3 Utility (Configuration tab)* to edit the message.

## VFO A Knob Friction Adjustment

The VFO A knob's spin rate can be adjusted by moving the knob in or out slightly. The rubber finger grip on the VFO A knob covers the knob's set screw, so it must be removed first.

**⚠ In the following procedure, use only your fingernails; a tool may scratch the knob.**

Using your fingernails at the point identified below, pull the finger grip forward slightly. Rotate the knob and repeat until the grip can be pulled off.

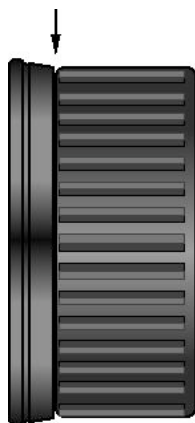

Use the supplied 5/64" (2 mm) Allen wrench to loosen the set screw.

Between the knob and front panel are two felt washers which, when compressed, reduce the spin rate. Move the knob in or out in small increments until the desired rate is obtained. (Re-tighten the set screw each time so you can spin the knob.) Then and replace the finger grip.

## VFO B Knob Friction Adjustment

Use the supplied 5/64" (2 mm) Allen wrench to loosen the VFO B knob's set screw.

Between the knob and front panel is a felt washer which, when compressed, reduces the spin rate. Move the knob in or out in small increments until the desired rate is obtained, re-tightening the set screw each time.

## Real Time Clock Battery Replacement

**⚠ K3 components or modules can be easily be damaged by ESD (electrostatic discharge). To avoid this, put on a grounded wrist strap (with 1 megohm series resistor) or touch a grounded surface before touching anything inside the enclosure. An anti-static work mat is strongly recommended.**

The battery for the real time clock/calendar is located on the left side of the RF board. To access it, turn power off, then remove the top cover as described in Appendix A.

Remove the sub receiver module (KRX3) if present.

Remove the old battery.

**⚠ If a KRX3 module (sub receiver) is installed, the battery will be protected by a plastic sleeve, which prevents shorting to the KRX3 module. Be sure to save this sleeve and replace it when the new battery is installed.**

Replace the battery with the same type of 3-V lithium coin cell (CR2032, BR2032, equivalent). The (+) terminal is clearly marked on the battery; it must be oriented as indicated by the (+) symbol on the RF board. Re-install the KRX3 module (if applicable) and the top cover.

To set the time, date, and date format, refer to the following CONFIG menu entries: *TIME*, *DATE*, and *DATE MD*. (Note: the *CONFIG:BAT MIN* menu entry refers to a battery used as the K3's DC power source, not to the 3-V battery.)



# Calibration Procedures

**⚠ All calibration procedures are firmware-based. Please do not adjust any of the trimmer capacitors or potentiometers inside the K3.**

Most calibration procedures use **Tech-Mode** menu entries. To enable these, set *CONFIG:TECH MD* to **ON**. Set *TECH MD* to **OFF** afterward.

**⚠** Before doing wattmeter or transmit gain calibration, set both *CONFIG:TUN PWR* and *PWR SET* to **NOR**.

## Synthesizer

This procedure is normally done at assembly time or by the factory.

- Hold **CONFIG** and find the *CONFIG:VCO MD* menu entry. Set the parameter fully clockwise to **CAL**. Exit the menu. The synthesizer will be tested and calibrated.
- To calibrate the 2<sup>nd</sup> synthesizer (for the sub receiver), locate *CONFIG:VCO MD* and set the parameter to **CAL**, tap **SUB** to turn on the **SUB** icon, then exit the menu.

## Wattmeter

If desired, **TUNE** power readings can be calibrated. This must be done at 5.0 W, 50 W (K3/100 only), and 1.00 mW (if the KXV3 option is installed).

### Low-Power (5 W) Wattmeter Calibration

- Switch to 20 meters. If applicable, put the ATU into bypass mode (hold **ATU**).
- Connect a 50-W capable dummy load (5 W for K3/10) and an accurate wattmeter to ANT1.
- Switch to ANT1 by tapping **ANT**.
- Set power to exactly 5.0 watts.
- Hold **CONFIG** and locate the *WMTR LP* menu entry. Stay in the menu for the next step.
- Hold **TUNE**; adjust menu parameter for a reading of 5.0 W on the external wattmeter. Then tap **XMIT** to exit TUNE. Exit the menu.

### High Power (50 W) Wattmeter Calibration

This applies to the K3/100 only. Use the same procedure as shown for 5 watts, but set power to 50 W. The wattmeter calibration menu entry name will change to *CONFIG:WMTR HP*.

### 1.0 Milliwatt Meter Calibration (KXV3)

This applies only if you have the KXV3 option.

- Set the *CONFIG:KXV3* menu entry to **TEST**, forcing all bands to use the KXV3's transverter output jack. Power will be limited to 0-1.5 mW. The wattmeter calibration menu entry name will change to *CONFIG:WMTR MW*.
- Connect a dummy load and an accurate RF voltmeter to the XVTR OUT jack.
- Set power to exactly 1.00 milliwatts (0 dBm).
- Hold **TUNE**; adjust the *WMTR MW* menu parameter for 0.224 Vrms on the external voltmeter. Then tap **XMIT** to exit TUNE.
- Set *CONFIG:KXV3* back to **NOR**.

## Transmitter Gain

This procedure is normally done at assembly time or by the factory. It compensates for per-band TX gain variation, and **must be done on every band**.

**⚠** If a computer is available, you should use the automated version of the below procedure. Run *K3 Utility* and click on the *Calibration* tab.

### Low-Power (5 W) TX Gain Calibration

- Switch to 160 meters.
- Put the ATU into bypass mode (hold **ATU**).
- Connect a dummy load to ANT1.
- Switch to ANT1 by tapping **ANT**.
- Set power to exactly 5.0 watts.
- Hold **TUNE**; VFO B should show about 5 W.
- Tap **XMIT** to exit TUNE.
- **Repeat this procedure on 80-6 meters.**

## High Power (50 W) TX Gain Calibration

This applies to the K3/100 only. Use the same procedure as shown for 5 watts, but set power to 50 W, and use a 50-W dummy load. The **TUNE** power output indication should be about 50 watts. (Use the **K3 Utility** method if a PC is available.)

## Milliwatt TX Gain Calibration (KXV3)

This applies only if you have the KXV3 option. (Use the **K3 Utility** method if a PC is available.) Connect a 50-ohm resistor to the XVTR OUT jack.

- Switch to 160 m.
- Set **CONFIG:KXV3 TEST**. This forces all bands to use the KXV3's transverter output jack, and output to be limited to 0-1.5 mW.
- Set power to exactly 1.00 milliwatts (0 dBm).
- Hold **TUNE**; output power should be about 1 mW. Then tap **XMIT** to exit TUNE.
- **Repeat the above procedure on 80-6 m.**
- Set **CONFIG:KXV3** back to **NOR**.
- Tap **MENU** to exit the menu.

## Reference Oscillator

The K3's reference oscillator is a TCXO, or *temperature-compensated crystal oscillator*. It is normally calibrated at assembly time or by the factory. There are two types: **5 ppm** and **1 ppm**.

Either TCXO can be manually calibrated using an accurate frequency counter (**Method 1**), or by zero-beating the sidetone against a reference signal (**Method 2**). Both are described at right. If a K3EXREF option module is installed, the TCXO will be automatically calibrated to an external 10-MHz reference. Refer to the K3EXREF manual.

If a K144XV module with reference lock (K144RFLK) is installed, it can be set up to track the TCXO (see **CONFIG:REF CAL**).

**⚠ Before attempting to calibrate the reference oscillator using Method 1 or 2, allow the transceiver to warm up at room temperature for at least 15 minutes (cover on).**

## Method 1 (Frequency Counter):

- Locate the **CONFIG:REF CAL** menu entry.
- Connect a frequency counter with **+/-1 Hz or better** accuracy to J1 on the reference oscillator module. Measure the exact frequency in Hz.
- Using VFO A, set the **REF CAL** parameter to match this frequency. Then exit the menu.

## Method 2 (Zero-Beating):

- Select CW mode. Set **WIDTH** to about 2.8 kHz. (A wide filter passband is necessary since you may need to move the **REF CAL** parameter a significant amount.)
- Tune the K3 to a strong broadcast station or a known-accurate reference signal. **Use the highest-frequency source you can** (e.g. WWV at 10, 15 or 20 MHz). **Set the VFO to the specified frequency of the signal.**
- Using **MON**, set the sidetone monitor level to roughly match the volume level of the received broadcast or reference signal.
- Locate **CONFIG:REF CAL**.
- Tap **SPOT** to enable the sidetone.
- Adjust the **REF CAL** frequency until the sidetone is zero-beated with the signal. As you approach the correct frequency, you'll hear an undulating "beat note" between the signals. The slower the beat note, the closer they are.
- Cancel **SPOT** and exit the menu.

## Front Panel Temperature Sensor

- Turn the K3 OFF. Allow about 15 minutes for the radio to cool to room temperature.
- Turn the K3 ON.
- Locate the *CONFIG:FP TEMP* menu entry. Adjust the parameter to match the reading of a room thermometer. **Note:** Deg. C = (deg. Fahrenheit - 32) \* 0.555.

**A** Front panel compartment temperature can be monitored continuously. Tap **DISP**, then use VFO B to select the **FP xxC** alternate display.

## PA Temperature Sensor

- Turn the K3 OFF. Allow about 15 minutes for the PA heat sink to cool to room temperature. **Do not turn the K3 ON during this period.**
- Turn the K3 ON.
- Locate the *CONFIG:PA TEMP* menu entry. Adjust the parameter to match the reading of a room thermometer. **Note:** Deg. C = (deg. Fahrenheit - 32) \* 0.555.

**A** PA heat sink temperature can be monitored continuously. Tap **DISP**, then use VFO B to select the **PA xxC** alternate display.

## S-Meter and RF GAIN Control

S-meter and RF GAIN control calibration is normally adequate using the factory settings. The optional S-meter calibration procedure below may provide better results.

**i** You can optionally linearize main and sub receiver IF gain using the “Calibrate RF GAIN” procedure in *K3 Utility (Calibration tab)*. **This should be done before S-meter calibration.**

Calibrating the S-meter requires a 1-μV/50-μV signal source (an accurate signal generator such as an Elecraft XG1 or XG2 can be used).

- Switch to a band applicable to your signal generator.
- Select CW mode.

- Set transmit power to **0.0 W** using **PWR**.
- The S-meter has both relative and absolute modes. Refer to the *CONFIG:SMTR MD* menu entry description if you wish to switch from relative to absolute. (Relative mode is easier to calibrate and is the factory default.)
- Turn the attenuator off (**ATT**).
- If you have *CONFIG:SMTR MD* set to **NOR**, turn the preamp on (**PRE**). If *SMTR MD* is set to **ABS**, turn the preamp off.
- Tap **AGC** to select slow AGC (**AGC-S**).
- Bypass the ATU, if installed, by holding **ATU**.
- Set **RF GAIN** to maximum (**fully clockwise**). (**Note:** If you’ve assigned the RF gain control for the present receiver to **squelch**, its RF gain will default to maximum unless you’re controlling RF gain from a remote-control computer application.)
- Normalize DSP filtering (hold **NORM**; pg. 14).
- Connect the signal generator to ANT1 and set it for 50 microvolts RF output.
- Tune to the frequency of the signal generator (tune for peak audio response). You can also use **auto-spot** (pg. 30) to accurately match the pitch of the signal, ensuring that it is centered in the passband.
- Locate the *CONFIG:SMTR PK* menu entry; set it to **OFF**.
- Locate the *SMTR SC* menu entry (S-meter scale). Use the VFO A knob to set it to the default value (**14**).
- Locate *SMTR OF* (S-meter offset). Adjust it for an S-9 reading. The default value (**24**) may suffice.
- Switch the signal generator to 1-μV output; the S-meter should now indicate about S-2 to S-3. If not, change *SMTR SC* by 1 unit (try 15 first, then 13, then 16, then 12). After each *SMTR SC* change, re-adjust the *SMTR OF* setting for an S-9 indication.
- When you have completed this procedure, disconnecting the signal generator should now show NO bars on the S-meter.

# Menu Functions

There are two groups of menu functions: **MAIN** and **CONFIG**. Tap **MENU** to access the MAIN menu; hold **CONFIG** to access the CONFIG menu. You can also hold **CONFIG** to switch from one menu to the other. Menu entries that you'd like quick access to can be assigned to programmable function switches (pg. 21).

Tapping **DISP** while viewing the menu shows usage information in the VFO B display area. For most entries, the default parameter value is shown in parentheses at the start of the help text.

## MAIN Menu

Entry	Default	Description
AFX MD	Delay 5	Audio Effects. Selections: <b>DELAY 1-5</b> (quasi-stereo); <b>BIN</b> (L/R phase shift)
ALARM	OFF	Set alarm/Auto-Power-On time. Tap <b>1</b> to turn alarm on/off; tap <b>2</b> / <b>3</b> to set <b>HH/MM</b> .
LCD ADJ	8	LCD viewing angle and contrast. Use higher settings if the radio is used at or above eye level. If adjusted incorrectly, bar graphs will be too light or heavy during keying.
LCD BRT	6	LCD backlight brightness. Use <b>DAY</b> in bright sunlight, <b>2</b> to <b>8</b> for indoor lighting.
LED BRT	4	LED brightness (relative to LCD backlight brightness). Exception: if <b>LCD BRT</b> is set to <b>DAY</b> , LEDs are set to their maximum brightness.
MIC SEL	FP, low range, bias off	Mic/line transmit audio source, mic gain range, and mic bias. Source selections: <b>FP</b> (front panel 8-pin <b>MIC</b> jack), <b>RP</b> (rear panel 3.5 mm <b>MIC</b> jack), and <b>LINE IN</b> (rear-panel <b>LINE IN</b> jack). Tap <b>1</b> to toggle between <b>.Low</b> and <b>.High</b> mic gain range for the selected mic. Tap <b>2</b> to turn mic <b>BIAS</b> on/off (turn on for electret mics). For the front-panel mic only, tap <b>3</b> to turn on an additional gain stage. <i>Use this only with very low-output mics.</i> An apostrophe will appear after the <b>H</b> , e.g. <b>H'</b> .
MIC+LIN	OFF	If set to <b>ON</b> , and <b>MIC SEL</b> is set for <b>FP</b> or <b>RP</b> , the present mic OR line input can be used for transmit audio. NOTE: Setting <b>MIC SEL</b> to <b>LINE</b> overrides the <b>MIC+LIN</b> menu entry (its parameter becomes "N-A"). When <b>MIC+LIN</b> is in effect, rotating the MIC control shows MIC gain. The op has to set <b>MIC SEL</b> to <b>LINE</b> temporarily to adjust <b>LINE IN</b> gain.
MSG RPT	6	Message repeat interval in seconds ( <b>0</b> to <b>255</b> ). To repeat a message, <i>hold</i> <b>M1</b> – <b>M4</b> rather than <i>tap</i> . A 6 - 10 sec. interval is about right for casual CQing. Shorter intervals may be needed during contests, and longer for periodic CW beacons.
RPT OFS	600	Sets the transmit offset (in kHz) for repeater operation, from <b>0</b> to <b>5000</b> kHz. Store per-band and per-memory. Use <b>ALT</b> to select a +/- offset or simplex operation.
RX EQ	+0 dB, each band	Receiver audio graphic equalizer. VFO A is used as an 8-band bar graph, showing boost or cut ( <b>-16</b> dB to <b>+16</b> dB in 1 dB increments) for each AF band. The 8 bands are 0.05, 0.1, 0.2, 0.4, 0.8, 1.6, 2.4 and 3.2 kHz. Tap <b>1-8</b> to select an AF band. VFO A selects boost/cut. Tap <b>CLR</b> to reset all bands to +0 dB. <b>CW RX EQ is separate from RX EQ for voice modes.</b> Not applicable to DATA.
TX EQ	+0 dB, each band	Transmit audio graphic equalizer (voice modes only). Functions the same as <b>RX EQ</b> , above. TX EQ can be adjusted during transmit. <b>SSB TX EQ is separate from TX EQ for other voice modes.</b> Not applicable to CW or DATA modes.
VOX GN	0	Adjusts the sensitivity of the VOX to match your mic and voice.
ANTIVOX	0	Adjusts immunity of the VOX circuit to false triggering by speaker audio.

## CONFIG Menu

### *Tech Mode Entries*

Menu entries that include [T] are *tech mode* entries. These are only visible if *CONFIG:TECH MD* is set to **ON**. They are normally left at their defaults. Entries further described as “**Advanced**” or “**Troubleshooting**” should be changed with caution. The default values are strongly recommended for these functions; tap **DISP** to see the default value, which appears in parentheses at the start of the help text.

### *Sub Receiver Settings*

Menu entries marked **SUB** have two settings: one for the main receiver, and one for the sub receiver. If a sub receiver is installed, the menu entries will change to identify which receiver is being set up by showing **RF** (main receiver) or **SUB** (sub receiver) at the left end of the parameter display. Also, in the **SUB** case, the **SUB** icon will flash.

Prior to adjusting sub receiver menu parameters, you should turn the sub receiver on by tapping **SUB**. This is especially important if you’re adjusting crystal filter settings, because it will allow you to hear the changes as filters are selected and modified. You should also turn SUB AF gain up and main AF gain down.

Even if the sub receiver is turned on, when you first enter the menu, **RF** will be in effect, and the **SUB** icon will be turned off. Tap **SUB** to switch to the sub receiver parameter as required.

Entry	Default	Description
2 TONE [T]	OFF	<b>(Troubleshooting.)</b> Enables built-in 2-tone generator for SSB transmit tests. The internal 2-tone generator only works if LSB or USB mode is selected. After setting 2-tone ON, exit the menu and tap XMIT. You can use ☺ <b>MIC</b> to adjust the amplitude of one of the tones; the other’s amplitude is fixed.
ADC REF [T]	5.00	Allows calibration of the voltage reference used by the K3 to measure and display certain values, such as the rig’s supply voltage. <b>(Optional.)</b> First, disconnect anything attached to the ACC jack. Next, locate the <i>ADC REF</i> menu entry. It will initially show <b>5.00</b> volts as the reference voltage. Using a DMM set to DC volts, measure the actual voltage at pin 2 of the ACC jack. This must be done <b>while the ADC REF parameter is being displayed</b> . (Note: The (-) probe of the DMM should go to the K3’s chassis ground, e.g. at the GROUND lug.) Finally, use VFO A to set the <i>ADC REF</i> menu parameter to what you measured at pin 2.
AF GAIN	HI	Sets AF gain range. Available selections are <b>HI</b> or <b>LO</b> .
AFSK TX	FIL OFF	If set to <b>FIL ON</b> , a 400-Hz transmit audio filter is added (via DSP) in order to maximize transmit signal to noise ratio. This may be useful in high-noise computer environments. Applies only to AFSK-A mode (RTTY).
AF LIM	NOR	<b>(Advanced.)</b> Adjustable AF output limiter for use when AGC is turned off. This can protect your ears if a large signal appears. Signals or noise above the threshold will sound highly distorted due to the limiting action, reminding you to back down the AF or RF gain. Typical settings for those who often turn AGC off are 17 to 23; some experimentation will be required.
AFV TIM [T]	1000	<b>(Advanced.)</b> Integration time for <b>AFV</b> and <b>dBV</b> displays in ms. See VFO B alternate display information (pg. 36).

AGC DCY	NOR	AGC decay characteristic; applies to both fast and slow AGC. <b>NOR</b> selects traditional linear decay. The <b>SOFT</b> setting can reduce IMD caused by traditional AGC, and is especially useful in “pileup” conditions, in some cases making it unnecessary to turn AGC off. Also see <i>AGC HLD</i> , below, which can reduce AGC IMD even further.
AGC HLD	0.00	SLOW AGC “hold” time. Specifies the number of seconds that the SLOW AGC level is held after the signal drops. This can be used to reduce IMD caused by traditional AGC, and is especially useful in “pileup” conditions, in some cases making it unnecessary to turn AGC off. Also see <i>AGC DCY</i> , above.
AGC PLS [T]	NOR	<b>(Advanced.)</b> <b>NOR</b> enables AGC noise pulse rejection.
AGC SLP [T]	12	<b>(Advanced.)</b> Higher values result in ‘flatter’ AGC (making signals at all amplitudes closer in AF output level).
AGC THR [T]	5	<b>(Advanced.)</b> Sets AGC onset point; a higher number moves the onset up.
AGC-F [T]	120	<b>(Advanced.)</b> Sets fast AGC decay rate; a higher number means faster decay.
AGC-S [T]	20	<b>(Advanced.)</b> Sets slow AGC decay rate; a higher number means faster decay.
AUTOINF [T]	NOR	<b>(Advanced.)</b> If set to <b>AUTO 1</b> , the K3 will send band data on its RS232 port for use with devices such as the SteppIR™ antenna on every band change. (Note: This setting may not be compatible with PC software applications that use the “AI” remote control command.)
BAT MIN	11.0	Low-battery warning threshold; <b>11.0</b> recommended. (This refers to a battery used as the K3’s DC power supply, not to the 3-V backup battery for the real-time clock.) If the voltage drops below this level, the operator will be alerted with a <b>BAT LOW</b> message. The menu parameter flashes if this occurs within the menu, so the level can be easily tested.
BND MAP	{band} In	Allows you to remove one or more bands from the <b>BAND</b> rotation. Use <b>BAND</b> up/down to select bands, then set them to <b>In</b> or <b>Out</b> using VFO A. (Works with transverter bands, too.) You can still get to mapped-out bands using memory recall, direct frequency entry, or computer-control commands.
CW IAMB	A	Iambic keying mode ( <b>A</b> or <b>B</b> ). Both modes produce self-completing dots and dashes. Mode B is more efficient for operators who use “squeeze” keying (pressing both paddles at once), because an extra dot or dash is inserted on squeeze release. Mode A lacks this feature, which may be more appropriate for those who only press one paddle at a time (often called “slap” keying).
CW PADL	TIP=DOT	Specifies whether left keyer paddle (“tip” contact on the plug) is <b>DOT</b> or <b>DASH</b> .
CW QRQ	OFF	<b>(Advanced)</b> Set to <b>ON</b> to provide CW keying speeds of up to 100 WPM and much faster break-in at all speeds. The internal keyer range becomes 8-100 WPM in this case. <b>Caution: In QRQ mode, the delay from key down to first RF out may be as little as 4 to 5 milliseconds. This may be too fast for some external amplifiers. You may be able to slightly increase the CONFIG:TX DLY setting to compensate, but you should then listen to your signal on another receiver to ensure that your CW keying doesn’t exhibit excessive jitter (per-element variation). This is more likely to occur with external keyers.</b> <b>Note:</b> If you use SPLIT, RIT, XIT, or cross-mode, QRQ mode will be temporarily turned off. Filter passband SHIFT/LOCUT/HICUT cannot be used when CW QRQ is in effect.

CW WGHT	1.15	<p>Adjusts element/space timing ratio (weight) for the internal keyer.</p> <p><b>Additional functions of this menu entry, via numeric keypad (Advanced):</b></p> <p>Tap <b>1</b> to select <b>SSB -CW</b> (default) or <b>SSB +CW</b> (allows CW in SSB modes).</p> <p>Tap <b>2</b> to select <b>@ = STOP</b> ('@' character terminates KY-packet transmission; default) or <b>@ = 'AC'</b> ('@' in a KY packet is sent as .---. [<b>@</b>] in CW mode).</p> <p>Tap <b>3</b> to select <b>OLD</b> or <b>NEW QSK</b> (default). <b>NEW</b> reduces AF keying artifacts.</p> <p>Tap <b>4</b> to select <b>VOX NOR</b> (default) or <b>AUTO OFF</b>. The <b>AUTO OFF</b> setting turns CW VOX <i>off</i> on power-up, avoiding accidental keying by attached PCs, etc.</p> <p>Tap <b>5</b> to select automatic VFO offset on SSB/CW mode change (<b>VFO OFS</b>) or no offset (<b>VFO NOR</b>, default). Automatic offset is often used on 6 meters, where mixed-mode QSOs are necessary during fading. <b>Note:</b> Pitch matching will be more accurate if USB is paired with CW REV, and LSB with CW normal.</p>
DATE	N/A	Real-time-clock date, shown as in the format selected by <b>CONFIG:DATE MD</b> (MM.DD.YY or DD.MM.YY). Tap <b>1</b> / <b>2</b> / <b>3</b> to select month / day / year.
DATE MD	US	Select <b>US</b> (MM.DD.YY) or <b>EU</b> (DD.MM.YY) date formats.
DDS FRQ [T]	{DDS freq}	<b>(Troubleshooting.)</b> Controls DDS tuning directly to check DDS XFIL range for synthesizer troubleshooting purposes. Rotate VFO A CCW and CW to find limits where <b>L</b> (lock) changes to <b>U</b> (unlock). Correct DDS frequency is restored after exiting the menu and rotating either VFO.
DIGOUT1	OFF	<p>DIGOUT1 is a general-purpose open-drain output signal on the ACC connector (pin 11). <b>OFF</b> = floating; <b>ON</b> = pull the line to ground.</p> <p>DIGOUT1 is per-band, and also per-antenna if the KAT3 ATU is installed. It can be used to turn an Elecraft PR6 preamp on when you switch to 6 meters, control a remote antenna switch, etc.</p> <p>Max. load current (<b>ON</b>) is 15 mA; max. load voltage (<b>OFF</b>) is 25 VDC.</p>
DUAL PB	APF	Assigns one of two specialized filter functions to the <b>DUAL PB</b> switch in CW mode: <b>APF</b> (audio peaking filter) or <b>NOR</b> (Dual-Passband Filtering, or Dual PB). See pg. 35 for details on the two functions.
EXT ALC [T]	OFF t-4.0	<b>(Advanced)</b> Set to <b>ON</b> only if using external ALC with a high-power amplifier. This may require modifications to your K3's RF and KIO3 modules (see pg. 27 for details). When set <b>ON</b> , the K3's external ALC threshold ( <b>-4.0</b> V by default) can be varied.
FLx BW <b>SUB</b>	2.70 (FL1)	<p>Crystal filter <b>FL1-5</b> bandwidth in kHz, where x=1 to 5 (FL1-FL5). Tap <b>1-5</b> to select a specific filter, or tap <b>XFIL</b> (<b>6</b>) to select the next filter. Then set the bandwidth to that marked on the crystal filter. (If desired, the value entered can be slightly different from the marked value. For example, you might set the bandwidth of the 8-pole, 400-Hz filter to <b>0.45</b> kHz rather than <b>0.40</b> kHz. This delays automatic filter switching by the WIDTH control to 0.45, which may be advantageous if you believe the 400-Hz filter still performs well at 450 Hz.)</p> <p><b>Note:</b> An easier-to-use alternative to the <b>FLx</b> menu entries is the <b>Edit Crystal Filters</b> function of our PC software application, <b>K3 Utility</b>. It shows all filter setups in a single window.</p> <p>Tap <b>7</b> to turn IIR DSP filters on (<b>IIR ON</b>) or off (<b>IIR OFF</b>, default) for the 100 and 50 Hz bandwidths. IIR filters have steeper skirts and slightly more ringing than the default FIR filters.</p>

FLx FRQ <b>(SUB)</b>	0.00 (FL1)	Crystal filter <b>FLx</b> center freq as offset from nominal (8215.0 kHz). Use the offset value specified on the crystal filter's label or PC board, if any. For example, if an Elecraft 5-pole, 200-Hz filter were labeled "-0.91", adjust VFO A for <b>-0.91</b> .
FLx GN <b>(SUB)</b>	0 dB (FL1)	Crystal filter <b>FLx</b> loss compensation in dB. <b>0 dB</b> recommended for wide filters; <b>2 dB</b> for 400 or 500 Hz filters, and <b>4 dB</b> for 200 or 250 Hz filters.
FLx ON <b>(SUB)</b>	ON (FL1), per-mode	Used to specify which filters are available during receive. Each filter must be set to <b>ON</b> or <b>OFF</b> in <i>each</i> mode. You can tap <b>(MODE)</b> within the menu entry.
FLTX {md}	FL1 (all modes)	Used to specify which crystal filter to use during TX. {md} = <b>CW/SB/AM/FM</b> . Choose filters with bandwidths as follows: SSB, 2.7 or 2.8 kHz (also applies to data); CW, 2.7 or 2.8 kHz; AM, 6 kHz; FM, 12 kHz or higher. The FM filter, if present, must be installed in FL1. <b>Note:</b> If you're using a 2.7-kHz 5-pole filter for SSB transmit, you can optionally fine-tune its FLx FRQ parameter to equalize LSB / USB transmit characteristics. Monitor your signal on a separate receiver, using headphones.
FM DEV	5.0	<b>(Advanced)</b> FM voice deviation in kHz. Tap <b>(1)</b> to change the function to <b>PL DEV</b> (PL tone deviation). <b>Note:</b> The deviation setting for sub-audible tones (CTCSS) is separate from that for the European standard tone (1750 Hz). Before adjusting <b>PL DEV</b> , select the desired pitch with the <b>(PITCH)</b> switch.
FM MODE	ON	If set to <b>OFF</b> , FM will be removed from the mode selections.
FP TEMP	N/A	Used to calibrate the front panel temperature sensor, which reads in degrees C. To convert °F to °C, use Deg. C = (deg. F-32) * 0.555.
FSK POL	1	<b>0</b> = Inverted FSK transmit data polarity, <b>1</b> = Normal data polarity. For use only with external FSK-D keying via programs such as MMTTY. Not recommended for CW-to-DATA use.
FW REVS	N/A	Rotate VFO A to see firmware revisions: MCU ( <b>uC</b> ), main DSP ( <b>d1</b> ), aux DSP ( <b>d2</b> , if KRX3 is present), flash parameters ( <b>FL</b> ), and KDVR3 controller ( <b>dr</b> ).
KAT3	Not Inst	KAT3 ATU mode; normally set to <b>BYP</b> or <b>AUTO</b> (outside the menu, <b>(ATU)</b> alternates between the two). Modes <b>L1-L8</b> , <b>C1-C8</b> , and <b>Ct</b> are used to test KAT3 relays. Mode <b>LCSET</b> allows manual adjustment of L/C/net settings (you must exit the menu first). When in <b>LCSET</b> mode, tapping <b>(ATU TUNE)</b> shows the L and C values; C is changed with VFO A, L is changed with VFO B, and <b>(ANT)</b> toggles between <b>Ca</b> and <b>Ct</b> .  Tapping <b>(CLR)</b> within this menu entry clears stored LC data for the present band.
KBPF3 <b>(SUB)</b>	Not Inst	If KBPF3 option is installed: set to <b>NOR</b> , exit menu, and turn power off/on.
KDVR3	Not Inst	If KDVR3 option is installed: set to <b>NOR</b> , exit menu, and turn power off/on. <b>Note:</b> Normally, playing DVR transmit messages automatically asserts PTT. To use manual PTT with DVR transmit (via a footswitch or external sequencing equipment), tap <b>(1)</b> within the KDVR3 menu entry until you see <b>USE PTT</b> .
KIO3	NOR	Determines function of BAND0-3 outputs on ACC connector. See pg. 19.
KNB3 <b>(SUB)</b>	NOR	<b>(Troubleshooting)</b> The K3 can't be used without a KNB3; <b>Not Inst</b> setting is for troubleshooting only.
KPA3	Not Inst	Set to <b>PA NOR</b> if KPA3 100-W amp installed. Set to <b>PAIO ON</b> if KPA3 is not installed, but the KPAIO3 transition PC board is. Other settings include <b>PA BYP</b> (disables KPA3 if installed), PA fan test settings ( <b>PA FN1-FN4</b> or <b>PAIO FN1-FN4</b> ), and <b>PAIO BYP</b> (if transition board is installed, but not the KPA3 module, this setting can be used to test the high power bypass relay).



KRC2	--	<p>Controls the KRC2 band decoder's accessory output settings. Shows <b>ACC OFF</b> or <b>ACC1-3</b> if a KRC2 is detected; -- if not.</p> <p>To ensure compatibility with both old and new KRC2 firmware, two different 6 meter band decodes are provided. Tap <b>[1]</b> to select <b>BAND6=B6</b> (addr=10) or <b>BAND6=B10</b> (addr=9). Refer to the KRC2 manual for further details.</p>
KRX3	Not Inst	<p>If KRX3 option (sub receiver) is installed, set the parameter to match your selected sub receiver AUX RF source: <b>ANT=ATU</b> (the KAT3's non-transmit antenna) or <b>ANT=BNC</b> (the AUX RF BNC jack on the rear panel). Turn power off, then back on.</p>
KXV3	Not Inst	<p>If KXV3 or KXV3A option is installed: set to <b>NOR</b>, exit menu, and turn power off/on. This option provides RX ANT IN/OUT jacks, low-level transverter I/O (XVTR IN/OUT), and a buffered I.F. output. The updated KXV3A supports the internal 2-m module (K144XV).</p> <p>If <b>KXV3</b> is set to <b>TEST</b>, the K3 will use low power (0.10 to 1.50 mW) on all bands, including HF and transverter bands. RF input/output is via the XVTR IN/OUT jacks in this case. Used for troubleshooting. Note: To access the TEST setting, <b>KXV3</b> must first be set to <b>NOR</b>, then K3 power turned off/on.</p>
LCD TST	OFF	<p>Rotating VFO A to turn on all LCD segments for test purposes.</p>
LIN OUT	NOR 010	<p>Sets the LINE OUT level. LINE OUT connections go to PC soundcard inputs. Settings above 10 may result in overdrive of the soundcard or saturation of the KIO3's isolation transformers; monitor signals using the PC to avoid this.</p> <p><b>Note:</b> Normally, <b>LIN OUT</b> sets a fixed-level receive-only output for main/sub (L/R), compatible with digital modes. Tapping <b>[1]</b> switches <b>LIN OUT</b> to <b>=PHONES</b>, where the line outputs match headphone audio, audio level is controlled by AF/SUB gain controls, and both RX and TX audio are available.</p>
MACRO x	Function	<p>Used to assign macros (sequences of remote-control commands) to any of the K3's programmable function switches. For example, a single macro can do the equivalent of "SPLIT, up 2 kHz, turn on diversity mode"; setup transmit EQ for a specific operator; configure the K3 for a contest, etc.</p> <p>Macros must first be created using <b>K3 Utility</b> and sent to the K3. Next, locate the <b>MACRO x</b> menu entry, tap <b>[1]-[8]</b> to select a macro number (x), then hold the desired programmable switch (e.g. <b>PF1</b>) to assign that macro to it. For details, see <b>K3 Utility</b> help or the <b>K3 Programmer's Reference</b>.</p>
MEM 0-9	NOR	<p>If the parameter is set to <b>BAND SEL</b>, frequency memories 0-9 ("quick memories") will act like band switches. Once this mode has been selected, exit the menu, then use <b>[V] ► [M]</b> to assign individual bands to keypad switches 0-9. For example, use <b>[BAND]</b> to get to 160 m, tap <b>[V] ► [M]</b>, then tap <b>#1</b>. From then on, tapping <b>[M] ► [V]</b>, then <b>#1</b>, will take you to your last-used frequency on 160 m, just as if you had used the <b>[BAND]</b> switch.</p> <p>This menu entry also controls the behavior of memory recall (<b>[M] ► [V]</b>) when selecting memories 00-99 using VFO A:</p> <p>Normally, when you tap <b>[M] ► [V]</b>, rotating VFO A through memories 00-99 switches the receiver to the indicated frequency as soon as the VFO stops moving. You can change this behavior by tapping <b>[1]</b> in the <b>MEM 0-9</b> menu entry. This alternates between <b>M&gt;V NOR</b> ("live" memory recall) and <b>M&gt;V DLY</b> ("delayed"). In the latter case, the receiver will not switch to new frequencies until you tap <b>[M] ► [V]</b> to return to normal operation.</p>

MIC BTN	OFF	Set to <b>ON</b> if your mic has UP/DOWN buttons compatible with the K3's front-panel mic jack. Not applicable to the Elecraft MH2 or MD2 microphones. <b>Tapping</b> UP/DOWN once moves the VFO up/down one step (based on current tuning rate); <b>holding</b> UP/DOWN moves up/down continuously. If frequency moves up/down continuously, your mic is not compatible; set <b>MIC BTN OFF</b> .
L-MIX-R	A B	Sets left/right mix of main (A) and sub (B) audio. Default is main full left, sub full right. A setting of <b>AB B</b> would provide main/sub mixing on the left, etc.
NB SAVE	NO	Set to <b>YES</b> to save noise blanker on/off state per-band. Noise blanker levels, both DSP and I.F., are always saved per-band regardless of this setting.
PA TEMP	N/A	If a KPA3 (100-W PA module) is installed, shows KPA3 heat sink temperature and allows it to be adjusted. See calibration procedure on pg. 51. If you're operating at high power from a battery, and voltage is dropping enough to cause an erroneous <b>HI TEMP</b> indication, tap <b>1</b> in this menu entry to select <b>R ONLY</b> (receive only) temperature sensing, rather than the default ( <b>T AND R</b> ).
PB CTRL	Shift=.05	<b>(Advanced)</b> Specifies the granularity of the passband SHIFT control on a per-mode basis: <b>.05</b> (default) or <b>.01</b> kHz. Select the desired mode first, then select the desired granularity. <b>Limitations:</b> Only applies to CW and DATA modes. Selecting <b>.01</b> kHz reduces the SHIFT range and disables HI CUT and LO CUT. May interfere with spurious signal removal ( <b>CONFIG:SIG RMV</b> ), i.e. "removed" signals may not be shifted the right amount, and thus may again be audible.
PTT-KEY	OFF-OFF	<b>(Advanced)</b> Allows selection of <b>RTS</b> or <b>DTR</b> RS232 lines to activate PTT or key the K3. (See pg. 18 for connections.) Example: if the parameter is set to <b>RTS-DTR</b> , then the RTS line will activate PTT, and DTR will key the rig. <b>Note:</b> If a computer or other device asserts RTS or DTR <i>while</i> you're in this menu entry, the K3 will switch to <b>TEST</b> mode (zero output) as a precaution. The <b>TX</b> icon will flash as a reminder. To avoid this, make sure software has flow control and/or keying options turned OFF while you're changing the <b>PTT-KEY</b> selection.
PTT RLS	20	<b>(Advanced)</b> Provides a delay between release of PTT and dropping of the transmit carrier; intended for use with fast turn-around data protocols such as AMTOR and PacTOR. (No effect in CW, FSK D, or PSK D modes.) A value of 20 or higher may be needed to ensure accurate data transmission with these protocols. If sync data or <b>-S</b> is in effect (see <b>SYNC DT</b> ), a lower value, typically 10 to 12, is optimal. Also see AMTOR/PacTOR (pg. 32).
PWR SET	NOR	If set to <b>NOR</b> , the power level on each band follows the present setting of the PWR control. If set to <b>PER-BAND</b> , the power level is saved on each band. This is especially useful with external amplifiers (see ALC discussion on page 75.) If a KPA500 is connected to the K3 via the ACC cable, two sets of per-band power settings are saved: one for "barefoot" operation, one for use with the amp. When the amp is used, an asterisk appears as PWR is rotated (e.g. <b>30 W*</b> ). Tap <b>1</b> to <b>LOCK</b> or <b>UNLOCK</b> the MIC, CMP, and PWR controls.
REF CAL <b>[T]</b>	49380000 Hz	Used to calibrate the K3's reference oscillator. VFO A is used to set the reference oscillator frequency in Hz. Typically it will be 49380.000 +/- 1000 Hz. Refer to page 50 for manual reference oscillator calibration details.  If a K3EXREF option is installed and connected to an external 10-MHz reference, the <b>REF CAL</b> parameter will be calibrated automatically about 10-15 seconds after power-up. An asterisk will appear in the menu entry name (e.g. <b>REF*CAL</b> ); the asterisk flashes as long as data is being received from the K3EXREF. Tapping <b>1</b> saves the automatically derived value as the default (manual) value. This is not required, but is useful if the external reference is ever disconnected.

RFI DET	NOR	<b>NOR</b> enables detection of high RFI at the K3's antenna in receive mode (see <b>HI RFI</b> warning, <b>Troubleshooting</b> ). Set to <b>OFF</b> to disable the warning.
RIT CLR	UNDO OFF	When this parameter is set to "UNDO ON", tapping RIT/XIT <b>[CLR]</b> will alternate between <b>0.00</b> and the present RIT/XIT offset, if any.
RS232	4800 b	RS232 communications rate in bits per second (bps). During firmware download (via the K3FW PC program), the baud rate is set automatically to 38400 baud, but it is then restored to the value selected in this menu entry.
SER NUM	N/A	Your K3's serial number, e.g. <b>05000</b> . Cannot be changed.
SIG RMV [T]	NOR	<p><b>(Advanced) OPTIONAL SPURIOUS SIGNAL REMOVAL:</b> Can be used to remove fast-tuning receiver "birdies" that are audible even with an antenna connected. (An alternative in SSB mode is to turn on auto-notch.)</p> <p><b>Limitations:</b> Applies only to CW/SSB/DATA modes, and only to the main receiver. In CW and DATA modes, <i>SIG RMV</i> should not be used in combination with a <i>CONFIG:PB CTRL</i> setting of <b>Shift=.01</b>.</p> <p><b>STEPS:</b> <b>(1)</b> Select the desired band (for transverter bands, use the I.F.), as well as the desired mode. <b>(2)</b> Adjust the DSP controls (SHIFT/WIDTH or LO/HI CUT) to the settings you use most often. <b>(3)</b> Locate a birdie to be removed. A birdie is "fast-tuning" if a small change in the SHIFT control (e.g. 50 Hz) moves the birdie about 400 Hz or more (with a narrow filter selected, this small shift may move it completely out of the passband). Such birdies result from UHF harmonics of the VFO. <i>If you test a birdie using SHIFT, be sure to return SHIFT to its original setting before continuing, because SHIFT affects the birdie frequency.</i> <b>(4)</b> Change the <i>SIG RMV</i> parameter to <b>0</b>. This saves information about the birdie, including VFO frequency, mode, bandwidth, and SHIFT value. <b>(5)</b> Try different parameter values, starting with <b>-1</b> or <b>1</b>, to see if the birdie can be removed (shifted out of the audible passband). Each time you change the parameter, exit the menu and see if the birdie has disappeared. (Each <i>SIG RMV</i> entry applies to a single 100-Hz VFO segment, e.g. from 28135.30 to 28135.39, so you'll have to tune slowly through that 100-Hz range using 10-Hz steps to make sure the birdie has been completely removed.) You may hear a slight tuning artifact as you tune in and out of the affected VFO segment. <b>(6)</b> Repeat steps 3 through 5 for the adjacent 100-Hz VFO segments if required to completely remove the birdie. <b>(7)</b> Repeat steps 2 through 6 for different DSP control settings you use in the present mode. <b>Note:</b> If you change your CW sidetone pitch, you may need to re-do the procedure for signals removed in CW mode.</p> <p><b>To undo SIG RMV:</b> If you tap <b>[CLR]</b> while you're in the <i>SIG RMV</i> menu entry, all birdie information for the present band will be permanently deleted.</p>
SMTR OF	024	S-Meter offset; see calibration procedure (pg. 51).
SMTR SC	014	S-Meter scale. Typically set so that S-9 = 50 $\mu$ V and S-2 to S-3 = 1 $\mu$ V with Preamp on, AGC ON, and WIDTH of 500 Hz. See calibration procedure (pg. 51).
SMTR PK	OFF	Set to <b>ON</b> for peak-reading S-meter. (Not applicable in FM mode.)
SMTR MD	NOR	<b>(Advanced)</b> S-meter mode: When set to <b>NOR</b> , preamp/attenuator on/off will affect the S-meter. (The default values of <i>SMTR OF</i> and <i>SMTR SC</i> apply to <b>NOR</b> .) If set to <b>ABS</b> , the S-meter reading will stay fairly constant with different preamp/attenuator settings, but <i>SMTR OF</i> and <i>SMTR SC</i> must be re-aligned.
SPLT SV	NO	If set to <b>YES</b> , <b>[SPLIT]</b> , <b>[RIT]</b> , and <b>[XIT]</b> on/off states are saved per-band.
SPKRS	1	Set to <b>2</b> if using two external speakers. This enables binaural effects in conjunction with the <b>[AFX]</b> switch, as well as stereo dual-receive if the sub receiver is installed. For further details on sub receiver use, see pg. 37.

SPKR+PH	NO	<b>YES</b> = Speaker is ON, even when headphones are plugged into PHONES jack. See detailed discussion on pg. 20.
SQ MAIN	0	This menu entry normally sets the main receiver squelch value ( <b>0-29</b> ). If VFO A is rotated fully clockwise, the parameter changes to <b>=SUB POT</b> . Squelch for both main and sub receivers will then be controlled by the SUB RF/SQL knob, and both main and sub RF gain will be controlled by the MAIN RF/SQL knob.  <b>Note:</b> By default, squelch applies only to FM mode. Tapping <b>[1]</b> while in this menu entry alternates between <b>SQL=ALL</b> (all-mode squelch) and <b>SQL=FM</b> .
SQ SUB	0	This menu entry normally sets the sub receiver squelch value ( <b>0-29</b> ). But if <b>SQ MAIN</b> is set to <b>=SUB POT</b> , then <b>SQ SUB</b> will also change to <b>=SUB POT</b> . Squelch for the sub receiver will then be controlled by the SUB RF/SQL knob, and both main and sub RF gain will be controlled by the MAIN RF/SQL knob.
SUB AF	NOR	If set to BALANCE, then the SUB AF GAIN control becomes main/sub AF balance when the sub is turned on (including diversity mode). In this case MAIN AF GAIN controls the AF gain level for both receivers. When SUB AF is at 12 o'clock, both receivers will be at full volume (main left, sub right). If SUB AF is rotated fully counter-clockwise, you'll hear only the main receiver. If it's rotated fully clockwise, you'll hear only the sub receiver. At intermediate settings you'll hear both. A balance control is very useful for contesting and split operation. But it can also save a lot of AF gain control adjustment (i.e., matching main and sub), since MAIN AF controls both main and sub receiver audio.
SW TEST [T]	OFF	<b>(Troubleshooting)</b> To turn on switch test, rotate VFO A until the parameter becomes <b>SCN ADC</b> . Then hold any switch to see its scan row and column ADC reading. You can also rotate any of the four potentiometers to see their associated ADC readings (main/sub AF gain and main/sub RF gain). If the SUB RF pot is mapped to main/sub squelch, you must switch to FM mode to see its readings.
SW TONE	OFF	If set to <b>ON</b> , enables audible switch feedback tones. (Note: For <i>voice</i> feedback on switch press, you may wish to use our K3 Voice program for the PC.)  <b>Tones generated:</b> In general, a <i>low-to-high</i> tone pair is generated when a switch function is turned on, and <i>high-to-low</i> when it is turned off. Following <b>ATU TUNE</b> , SWR <= 2:1 results in a normal tone; <= 3:1 a medium-pitch tone; and over 3:1, a high-pitched tone. If <b>CONFIG:RIT CLR</b> is set to <b>UNDO ON</b> , tapping <b>CLR</b> a second time (RIT clear "un-do") produces a unique low-to-high tone pair.  Some switches do not generate tones because they might interfere with received or transmitted audio (e.g. <b>REV</b> , and <b>M1-M4</b> message play).
SYNC DT	Function	<b>(Advanced)</b> When SYNC DT (sync data) is activated in either SSB or DATA modes, T/R switching times are reduced to optimize for modes such as AMTOR and PacTOR. The "-S" icon turns on. <b>Do not use SYNC DT for normal SSB/DATA communications.</b> Cannot be changed within the menu; assign to a programmable function. Also see <b>CONFIG:PTT RLS</b> (PTT release delay).
TECH MD	OFF	Set to <b>ON</b> to enable <b>Tech Mode</b> menu entries (those marked with [T] in this list). <b>(Advanced)</b> Tap <b>[1]</b> or <b>[2]</b> to show main or aux DSP internal error information. Tap <b>CLR</b> to clear the error information (parameters will then be <b>FFFF</b> ).
TIME	N/A	Real-time-clock view/set. Tap <b>[1]</b> / <b>[2]</b> / <b>[3]</b> to set HH / MM / SS. To see the time and other displays during normal operation, tap <b>DISP</b> (see pg. 36).
TTY LTR	Function	Performs an RTTY FIGS to LTRS shift when the text decoder is enabled in RTTY modes. Cannot be changed within the menu itself; must be assigned to a programmable function switch.

TUN PWR	NOR	If set to <b>NOR</b> , <b>TUNE</b> power level follows the POWER knob. Otherwise, establishes a fixed power level for <b>TUNE</b> , overriding the present POWER knob setting. <b>Note1:</b> <i>TUN PWR</i> does not pertain to <b>ATU TUNE</b> , which always uses 5 or 10 W and is internally controlled. It also does not apply to transverter bands using the low-power KXV3 output (XVTR OUT). <b>Note2:</b> see <i>CONFIG:PWR SET</i> for per-band power control.
TX ALC [T]	ON	<b>(Troubleshooting.)</b> Set to <b>OFF</b> to disable both <i>internal</i> and <i>external</i> transmit ALC (overrides <i>EXT ALC</i> setting). Used when adjusting band-pass filters in TX mode, or for troubleshooting. Set parameter to <b>ON</b> during normal operation.
TX DLY	NOR 008	<b>(Advanced)</b> For use with external amplifiers that have slow relays; sets the time from KEY OUT jack (active low) to first RF in 1-ms steps. To minimize loss of QSK speed, use the shortest delay that works with your amp. Most will work with the default (minimum) setting of 8 ms. <b>CAUTION: If you use any setting above 008, and you're using an external keyer in CW mode, you should listen to your keying on another receiver. At some code speeds and keyer weight settings, your CW keying may exhibit excessive jitter (per-element variation) that can be heard on the air.</b> <b>Note:</b> If <i>CW QRQ</i> is set to <b>ON</b> , the minimum delay from KEY OUT to first RF will be somewhat shorter (approx. 4 to 5 ms rather than 8 ms).
TX DVR	NOR	<b>(Advanced)</b> Set to <b>IND</b> to allow independent control of the DVR transmit playback level, and the monitor normal transmit speech monitor level. In this case, holding the MON knob a second time alternates between DVR level and MON level. Useful for operators who don't normally use the transmit monitor, but would like to hear DVR playback audio during transmit.
TX ESSB	OFF 3.0	<b>(Advanced)</b> Extended SSB transmit bandwidth ( <b>3.0</b> to <b>4.0</b> kHz) or <b>OFF</b> . Tap <b>1</b> to turn on/off, and rotate VFO A to select the bandwidth. (Also see pg. 36.) If you turn ESSB on/off frequently, you might want to assign this menu entry to a programmable function switch (PF1, PF2, or M1-M4).
TX GATE	OFF 0	<b>(Advanced)</b> The TX noise gate can be used to suppress transmitted audio below a certain level, e.g. that of an amplifier fan. Tap <b>1</b> within the <i>TX GATE</i> menu entry to turn the noise gate on/off. Use VFO A to set the desired threshold. Since there's no visual indication that transmit audio is below the threshold, you should adjust it using the transmit voice monitor (MON), ideally while using headphones. Set the threshold high enough to cut off transmit audio due to local noise, but not so high that it causes your voice to drop out too frequently. The <i>TX GATE</i> threshold can be adjusted in <b>TX TEST</b> mode.
TX INH [T]	OFF	<b>(Advanced)</b> If set to <b>LO=INH</b> or <b>HI=INH</b> , an external logic signal can inhibit transmit (see pg. 19). When transmit is inhibited, the TX LCD icon flashes.
TX MON	NOR	<b>(Advanced)</b> When set to <b>NOR</b> , voice monitor audio will be delayed due to DSP signal processing, and will reflect the sound of speech compression, if applicable. <b>FAST</b> may be preferable if you're distracted by these effects. In this case, monitor audio will be "dry" (unprocessed).

TXGN{pwr} [T]	00	<p><b>(Troubleshooting.)</b> Shows transmit gain constant for the present band and power mode, where {pwr} = <b>LP</b> (0-12W), <b>HP</b> (13-120W), or <b>MW</b> (0.1-1.5 mW). The gain constant is updated whenever the <b>TUNE</b> function is activated on a given band <i>at one of three specific power levels</i>: 5.0 W, 50 W, and 1.00 milliwatt. See transmit gain calibration procedure, pg. 49.</p> <p>On 80 m with high power (&gt; 13 W) selected, you should see <b>PR80</b> as part of the <b>TXGN</b> parameter display. This indicates that the preamp is turned on during QRO transmit on 80 m, and is the default. It should only be turned off for troubleshooting purposes; this is done by tapping <b>PRE</b>.</p> <p>If <b>TX ALC</b> (above) is <b>OFF</b>, the <b>TXGN</b> parameter can be set manually, at very fine resolution. This should only be done for troubleshooting purposes.</p>
TXG VCE [T]	0.0 dB	<p><b>(Advanced)</b> Balances voice transmit peak power in relation to CW peak power in <b>TUNE</b> mode. Typically set between -1.5 to 1.5 dB.</p>
VCO MD [T] <b>SUB</b>	NOR xx (varies w/ VFO freq)	<p><b>(Troubleshooting.)</b> VCO L-C range view/change/calibrate. Once the VCO is calibrated (pg. 49), the parameter which appears here will include <b>NOR</b>. You can change the setting to troubleshoot VCO L-C ranges. When finished, set the parameter back to <b>NOR 127</b>, then exit the menu and change bands to restore the original setting. <b>Note 1:</b> In this menu entry only, the main/sub receiver prefix (<b>RF</b> or <b>SUB</b>) is not displayed at all times. However, the <b>SUB</b> icon will flash as usual when <b>SUB</b> is tapped. <b>Note 2:</b> Tapping <b>8</b> before starting a VCO CAL will force it to use “manufacturing” PLL voltage tolerances (<b>TOL=MFG</b> is flashed on VFO B). These tolerances are more stringent than normal. This might be useful for those using the K3 over a wider temperature range.</p> <p><b>VFO Tuning Noise Reduction (Advanced):</b> Tapping <b>1</b> in this menu entry alternates between <b>SPI 1</b> (default) and <b>SPI 2</b>. The <b>SPI 2</b> setting may eliminate a weak “ticking” noise sometimes heard in the vicinity of 5, 28, or 50 MHz while rotating the VFO. Older K3s will require a simple RF board modification before the <b>SPI 2</b> setting can be used; without the modification, synthesizer tuning errors may occur, and <b>SPI 2</b> may not be effective. Contact Elecraft for details.</p>
VFO B->A	Function	Copies VFO B’s frequency to VFO A. Cannot be used within the menu itself; must be assigned to a programmable function switch.
VFO CRS	Per-mode	Per-mode coarse tuning rate (hold <b>COARSE</b> and tune VFO A or B). Tap <b>1</b> to turn rounding on/off. Also applies to the RIT/XIT tuning knob if <b>CONFIG:VFO OFS</b> is set to <b>ON</b> , and both RIT and XIT are turned OFF.
VFO CTS	200	VFO counts per turn ( <b>100</b> , <b>200</b> , or <b>400</b> ). Smaller values result in easier fine-tuning of VFO; larger values result in faster QSY. Doesn’t apply to the <b>COARSE</b> tuning rate, which always uses 100 counts per turn.
VFO FST	50 Hz	Specifies the faster of the two VFO tuning rates ( <b>RATE</b> ). The faster rate is <b>50</b> Hz per step by default, but can be set to <b>20</b> Hz if desired. In this case, <b>VFO CTS = 400</b> is recommended to ensure adequate fast-QSY speed.
VFO IND	NO	If set to <b>YES</b> , VFO B can be set to a different band than VFO A, which allows listening to two bands at once (main/sub). See pg. 37 for independent main/sub band considerations.
VFO OFS	OFF	If <b>ON</b> , the RIT/XIT offset control can be used to tune VFO A in large steps when both <b>RIT</b> and <b>XIT</b> are turned off. The step sizes vary with mode (see <b>VFO CRS</b> ), and are the same as the <b>COARSE</b> VFO tuning rates.
WMTR {pwr} [T]	100	Wattmeter calibration parameter. {pwr} is the power mode: <b>LP</b> (0-12W), <b>HP</b> (13-120W), or <b>MW</b> (0.1-1.5 mW). See calibration procedure (pg. 49).
XVn ON	NO	Tap <b>1</b> – <b>9</b> to select applicable transverter band ( <b>1 - 9</b> ). Set parameter to <b>YES</b> to turn the transverter band on.

XVn RF	144	Lower edge for transverter band n ( <b>1-9</b> ); <b>0-24999</b> MHz. (Tap <b>1</b> – <b>9</b> to select applicable transverter band.) Normally, <b>144</b> would be used for the K144XV internal 2-m module. But if the K144XV is being used as an IF for a higher-band transverter, you can set it to the lower edge of the higher band.
XVn IF	28	Specify K3 band to use as the I.F. for transverter band n ( <b>1-9</b> ). (Tap <b>1</b> – <b>9</b> to select the transverter band.) I.F. selections include <b>7</b> , <b>14</b> , <b>21</b> , <b>28</b> , and <b>50</b> MHz. Use <b>28</b> MHz for the K144XV internal 2-m module.
XVn PWR	L .01	Sets upper limit on power level for XVTR band n. (Tap <b>1</b> – <b>9</b> to select band.) <b>H x.x</b> ( <b>H</b> igh power level) specifies a value in watts, and use of the main antenna jack(s). This should be used with caution, as you could damage a transverter left connected to these antenna jacks accidentally. <b>L x.xx</b> ( <b>L</b> ow power level) specifies a value in milliwatts, which requires the KXV3 option. <b>L 1.00</b> is recommended for the K144XV internal 2-m module. (If <i>CONFIG:PWR SET</i> is set to <b>PER-BAND</b> , the K3 will save the last-used power setting on each band. This is especially useful for transverter bands.)
XVn OFS	0.00	Offset ( <b>-9.99</b> to <b>+9.99</b> kHz) for transverter band n ( <b>1-9</b> ). (Tap <b>1</b> – <b>9</b> to select transverter band.) Compensates for oscillator/multiplier chain errors.  <b>If the present transverter band is assigned to the K144XV internal 2-m module</b> (by setting <i>XVn ADR</i> to <b>INT. TRN0-9</b> ), the <i>XVn OFS</i> parameter will show either <b>144</b> or <b>146</b> at the left end of the display, depending on whether you have the VFO tuned to 144-145.999999 or 146-148 MHz. You can enter an offset for each of these band segments, which correspond to the 116 and 118 MHz crystals on the K144XV, respectively. (You must have the 2-m band selected before setting these parameters.) These offset values are normally set up at the factory, and are also noted on a label on the K144XV module.  <b>If a K144RFLK module is also installed</b> , the K144XV’s 2-m frequency will be locked to the K3’s 49.380-MHz reference. The <i>XVn OFS</i> parameters can be automatically calculated in this case. Tap ‘0’ on the keypad in the <i>XVn OFS</i> menu entry until you see <b>REFLOCK</b> displayed. The <i>XVn OFS</i> parameter will then be locked to the <i>REF CAL</i> value, which you’ll need to calibrate. Or, you can use an external reference and the K3’s K3EXREF option.
XVn ADR	TRNn or INT. TRNn	This menu entry assigns optional band-decode addresses ( <b>TRN1-9</b> , or <b>INT. TRN0-9</b> ) to each transverter band. Addresses <b>TRN1-9</b> are used to automatically select external transverters, while addresses <b>INT. TRN0-9</b> are used to select the Elecraft K144XV internal 2-meter transverter.  Addresses <b>TRN1-TRN9</b> and <b>INT. TRN0-9</b> can be sent to the BAND DATA outputs on the KIO3 for use with third-party transverters (BAND0-3; see pg. 19 and <i>CONFIG:KIO3</i> ). Addresses <b>TRN1-TRN7</b> are compatible with Elecraft XV-series transverters and the Elecraft KRC2 band decoder, so they are sent on the “AUXBUS” serial control line (TRN8 and TRN9 are sent as 0 on the auxBus). Tap <b>1</b> – <b>9</b> to select the desired transverter band, then rotate VFO A to select the desired decode address.  <b>Example 1:</b> To configure an Elecraft K144XV internal 2 m transverter as XVTR band 1, set <i>XV1 RF</i> to <b>144</b> MHz, <i>XV1 IF</i> to <b>28</b> MHz, and <i>XV1 ADR</i> to <b>INT. TRN0</b> (or any of <b>INT. TRN 1-9</b> as needed for external address decode).  <b>Example 2:</b> To configure an Elecraft XV432 external transverter as XVTR band 2, set up <i>XV2 RF</i> as <b>432</b> MHz, <i>XV2 IF</i> as <b>28</b> MHz, and <i>XV2 ADR</i> as <b>TRN1</b> (or whatever address matches the DIP switch selection inside the transverter).

# Troubleshooting

The most common symptoms and their causes are listed below, in three categories (general, transmit, and receive). Most problems are related to firmware or control settings. Subsequent sections cover **Parameter Initialization** (pg. 66) and **Module Troubleshooting** (pg. 67). If the problem persists, please contact Elecraft support (see pg. 10) or post a question on our email reflector.

## *General*

- **ERR** (error) message appears on the LCD (**ERR PL1**, etc.): Refer to Module Troubleshooting (pg. 67).
- **Can't turn power off:** An external device or the KIO3 or KPA3 module may be pulling the POWER ON line low. Disconnect external devices one at a time. If that doesn't reveal the problem, unplug the KIO3's digital I/O board, then the KIO3 main board, then the KPA3. Also see **Module Troubleshooting** (pg. 67).
- **General problem with transmit and/or receive:** Many problems can be caused by low power supply voltage or by a noisy or intermittent supply. Check your power supply's on/off switch, voltage, fuses (if applicable), and DC cabling. The K3 provides both voltage and current monitoring (pg. 36). Also see *Transmit* and *Receive* troubleshooting sections, below.
- **General problem with firmware behavior:** (1) Check all relevant menu settings (see MAIN and CONFIG menu listings in the previous section). In addition to the information in the manual, each menu entry provides help text by tapping **DISP**. (2) Try loading the latest microcontroller and DSP firmware. Review the release notes for changes that may be related to your symptoms. (3) If the above suggestions don't help, you can try reinitializing the firmware (pg. 64). **Be sure to save important parameter settings first.**
- **Bands missing from **BAND** switch rotation:** See *CONFIG:BND MAP*.
- **NEW K3UTIL SOFTWARE REQUIRED message appears on the LCD:** This indicates that you must install a new version of the K3's firmware upgrade program (*K3 Utility*) in order to load the latest K3 firmware. After installing the new version of *K3 Utility*, reload all new firmware (MCU, DSP, etc.).
- **FPF LOAD PENDING message appears on the VFO A and B displays:** Use our *K3 Utility* software application to load the **FPF** data file from a PC. Refer to *K3 Utility*'s help information for details.
- **N/A message (Not Applicable):** The function you're trying to use does not apply in the present context.
- **Mode icon flashes:** This is a reminder that you're about to set the K3 up for cross-mode **SPLIT** operation (VFOs in different modes). Tap any key to clear. To view and change VFO B's mode, use **BSET**.
- **VFO B is blank:** You may have CW or DATA text decode display turned on (**TEXT DEC**, pg. 30) with the **THR** (threshold) control set too high for text decode to proceed.
- **VFO A or B display doesn't change when the corresponding knob is rotated:** You may have the affected VFO locked (pg. 14).

## *Transmit*

- **BND END:** Attempt to transmit out of the allowed ham band.
- **TX LED on all the time:** This could indicate that PTT is being held on by external equipment. (Verify that *CONFIG:PTT-KEY* is set to **OFF-OFF** if not keying via the RS232 connector. Try disconnecting everything connected to the ACC and RS232 connectors.) Also check VOX gain (unplug mic if necessary).
- **HI CUR or HI SWR warning (K3/100):** Check load Z and supply voltage. If voltage is low and/or load Z is under 50 ohms, current can go up for a given requested power level. Reduce power if necessary.
- **HI TEMP warning (K3/100):** When operating QRO from a battery, low voltage may cause an erroneous temperature reading (see *CONFIG:PA TEMP* for details). Otherwise, PA heat sink temperature has exceeded 84C (PA drops into bypass mode). Check fans, power supply voltage and current, and load



impedance. Allow heat sink to cool. Reduce power if necessary. Make sure the *CONFIG:PA TEMP* menu entry is calibrated (allow heat sink to cool to room temperature, then compare menu reading to actual).

- **ALC OFF** is displayed on VFO A during transmit: Set *CONFIG:TX ALC* to **ON**. ALC should only be turned off during band-pass filter alignment (**do not adjust filters without consulting Elecraft support**).
- **Can't transmit in CW mode:** (1) Make sure the key or keyer paddle is plugged into the correct jack. (2) You must have VOX selected (**VOX** icon on) in order to use hit-the-key CW. (3) You may be in **SPLIT** mode, with VFO B set for a voice or data mode. Tap **A/B** or use **BSET** to check VFO B's mode.
- **Can't key external amplifier in CW mode:** Some amplifiers require a longer delay from keyline activation to first RF. See *CONFIG:TX DLY*. (**Caution:** Long *TX DLY* settings may affect keyer timing.)
- **Key clicks in QSK CW mode with an external amplifier:** This may be due to a slow amplifier relay (use *CONFIG:TX DLY*) or incorrect application of external ALC (see *CONFIG:EXT ALC* and pg. 27).
- **Can't use the mic in voice modes:** You may be in **SPLIT** mode, with VFO B set for CW or data mode rather than a voice mode. Tap **A/B** or use **BSET** to check VFO B's mode.
- **No power output:** You may have routed RF through the KXV3's XVTR IN/OUT jacks, either by switching to a transverter band, or by setting *CONFIG:KXV3* to **TEST**. Also try redoing TX GAIN cal (pg. 49).
- **Relay heard switching during keying:** If this happens only above a certain power level, transmit signal leakage may be activating the carrier-operated-relay circuitry on either the KXV3 module (RF I/O) or the KRX3 (sub receiver). You must improve isolation between transmit and receive antennas or decrease output power. If a relay switches during keying even at very low power levels, it could be due to: (1) SPLIT operation with different bands and/or modes, or the receive VFO tuned outside any ham band; or (2) VFO A is tuned such that a relay switches during T/R due to incorrect VCO calibration (re-run VCO CAL).

## Receive

- **HI RFI warning:** A high-power transmitter may be coupling into the K3's antenna in receive mode. The warning occurs when the ANT1 or 2 input signal exceeds about 1 to 2 W. Also see *CONFIG:RFI DET*.
- **HI SIG warning:** An extremely strong, sustained signal (e.g., a broadcast station's carrier) may be causing excessive post-mixer amplifier current when operating on the present band. The K3 will automatically turn the preamp OFF, and in extreme cases will also turn the attenuator ON.
- **HI CUR or SPKRS=1 warning:** **HI CUR** may indicate a shorted left speaker channel; the K3 will reduce AF gain. **SPKRS=1** may indicate that *CONFIG:SPKRS* is set to **2**, but a mono external speaker plug is in use, shorting the right speaker channel to ground. The K3 automatically sets *SPKRS* to **1**.
- **No received signal:** Check (1) receiver being squelched (if RF/SQL controls are assigned to squelch via *CONFIG:SQ MAIN* or *SQ SUB*, rotate squelch controls fully counter-clockwise); (2) RF GAIN too low (set RF gain controls fully clockwise); (3) bandwidth too narrow (set  $\odot$  WIDTH or tap **XFIL**), and also verify filter configuration settings); (4) switching to an open receive antenna on the KXV3 (RX ANT IN); (5) switching the KAT3 to an open antenna jack; (6) *CONFIG:REF CAL* parameter not adjusted properly; (7) *CONFIG:KXV3* may be set to **TEST**, which routes all RF through the XVTR IN/OUT jacks.
- **Received signal level too low:** (1) Try setting *CONFIG:AF GAIN* to **HI**; (2) check headphone and speaker plugs and cables; (3) make sure that *CONFIG:RX EQ* settings are either flat or have not been set for a large amount of cut; (4) recheck filter configuration, including *CONFIG:FLx BW*, *FLx GN*, and *FLx FRQ*; (5) verify that *CONFIG:REF CAL* is properly adjusted; (6) make sure RF GAIN is set to maximum.
- **Spurious signals ("birdies"):** All high-dynamic range receivers exhibit some birdies. Most will be inaudible with an antenna connected. If you find a birdie that's audible above normal band noise, see the *CONFIG:SIG RMV* menu entry. Autonotch may be useful for removing birdies in voice modes.
- **VFO tuning noise:** If you hear a weak "ticking" noise on some bands while tuning the VFO, even with an antenna connected, refer to *CONFIG:VCO MD* (**VFO Tuning Noise Reduction**).

## Parameter Initialization

Menu parameters are stored in non-volatile memory (EEPROM and/or FLASH). It is possible, though rare, for parameters to become altered in such a way as to prevent the firmware from running correctly. If you suspect this, you can reinitialize parameters to defaults, then restore a previously-saved configuration (or re-do all configuration steps manually; no test equipment is required).

- If you have a computer available to do configuration save and restore, run the **K3 Utility** program, then use the **Configuration** function to save your present firmware configuration.
- If you don't have access to a computer, you should write down your menu parameter settings. The most important are **CONFIG:FLx BW** and **CONFIG:FLx FRQ** (for each installed filter <x>, also tap **SUB** to obtain sub receiver crystal filter settings, if applicable). You should also note the settings of option module enables (all CONFIG menu entries starting with 'K', e.g. **CONFIG:KAT3**). If you don't record your crystal filter and option settings, you may have to remove the K3's top cover (and sub receiver, if installed) to verify which options as well as crystals filters are installed, as well as the frequency offsets noted on the crystal filters (depends on filter type).
- Turn the K3 OFF (using the K3's POWER switch, not your power supply).
- While holding in the SHIFT/LO knob (which is also labeled **NORM** below), turn power ON by tapping the K3's POWER switch. Let go of the SHIFT/LO knob after about 2 seconds. You should now see **EE INIT** on the LCD.
- When **EE INIT** completes after a few seconds, you may see **ERR PL1** or other error messages due to initialization. Tap **DISP** to clear each message.
- If you have a computer, restore all parameters using the **Configuration** function of the **K3 Utility** program.
- If you don't have a computer, manually re-enter all menu parameters that you wrote down, above, then re-do firmware configuration and calibration (starting on pg. 46). You can omit any steps pertaining to parameters you've already restored manually.
- See if the original problem has been resolved.

## Module Troubleshooting

The K3 is a highly modular transceiver. With the information provided here, you'll be troubleshooting to the module level, not to the component level. In many cases, problems can be resolved by changing a menu setting, loading new firmware (pg. 45) or initializing parameters to factory defaults (see below).

A full set of schematics can be found on our web site. **Due to the use of fine-pitch ICs in the K3, most signal tracing must be done very carefully using fine-tip probes.** Please do not attempt this unless you have experience in troubleshooting surface-mount assemblies; otherwise, you could damage your K3.

**⚠ DO NOT ADJUST ANY TRIMMER CAPACITORS OR POTENTIOMETERS** unless you have access to appropriate lab test equipment and have consulted Elecraft support regarding the proper settings. All trimmers have been aligned at the factory, and if misadjusted could degrade performance.

### *Error Messages (ERR xxx)*

An error message may be displayed on VFO B at power-up or during normal operation. In most cases error messages are due to a problem with a single option module, and may be due to incorrect firmware configuration.

**If you see an error message on VFO B (ERR XXX):** Write down the error message, as well as any associated error data shown on the VFO A display (e.g. **E 00005**). Then tap any switch to clear the error code. Multiple errors may occur; in this case, write down each of the messages and VFO A data, if any, before you clear them.

**See Error Msg table (next page) for details on specific ERR messages and their associated data values.**

### *Module Removal*

**⚠ TURN OFF THE POWER SUPPLY OR DISCONNECT THE POWER SUPPLY CABLE before removing or installing modules. If you drop a metal tool inside the K3 with power still applied, you can short a power supply or control line, resulting in damage to the RF board or other modules.**

**Module de-installation procedure:** To see if an option module is the cause of an error message, you must *de-install* it as described below, or you may not be able to tell if removing the module had any effect:

- Turn off power.
- Remove the module.
- Set the associated CONFIG menu entry to **NOT INST.** (See *CONFIG:KAT3*, etc.) **Note:** If the affected module is on the KRX3 (sub receiver), you must tap **SUB** to display its configuration setting. Otherwise the setting shown applies to the main receiver. This applies to the KBPF3 and KNB3 modules, as well as crystal filters, all of which are duplicated on the RF and sub receiver boards.
- Turn power off and wait at least 5 seconds.
- Turn power back on.

## Error Message List

\* = See module de-installation instructions on previous page.

Error Msg	Problem	Troubleshooting steps
ERR 12V	The <b>circuit breaker</b> on the KPA3 module may be open. PA drops into bypass mode, fans switch to level 2, and PA temp display mode is not available.	Check for short from PA module's 12V line to ground. If there's no short, try resetting the circuit breaker. If there is a short, remove the KPA3 module. Set <b>CONFIG:KPA3</b> to <b>PAIO ON</b> . While waiting for a replacement, you can use the K3 at reduced power.
ERR AT3	KAT3 not responding	* <b>De-install</b> the KAT3 module (see above). If this eliminates the error message, the KAT3 may be defective. You can substitute a KANT3 antenna input module temporarily, if available.
ERR BP1	No response from RF board BPF shift registers	* <b>De-install</b> option modules one at a time
ERR BP2	No response from KBPF3 option shift registers	* <b>De-install</b> KBPF3 on RF board
ERR BP3	No response from sub RX BPF shift registers	* <b>De-install</b> the KRX3 module, including the SUBIN and SUBOUT boards
ERR BP4	No response from sub RX KBPF3 option	* <b>De-install</b> the KBPF3 module on KRX3
ERR DS1	No main DSP SPI echo	Reload DSP1 firmware
ERR DS2	Main DSP SPI echo not inverted	Reload DSP1 firmware
ERR DS3	No AUX DSP SPI echo	Reload DSP2 firmware. Note: <b>CONFIG:KRX3</b> must be set to <b>NOT INST</b> unless the KRX3 option is installed, which includes the aux DSP module (DSP2) and 2 <sup>nd</sup> synthesizer.
ERR DS4	AUX DSP SPI echo not inverted	Reload DSP2 firmware. Note: <b>CONFIG:KRX3</b> must be set to <b>NOT INST</b> unless the KRX3 option is installed, which includes the aux DSP module and 2 <sup>nd</sup> synthesizer.
ERR DSE	Missing echo from a DSP command	Reload DSP1 firmware (and DSP2 firmware, if applicable).
ERR DSG	DSP internal gain error	Turn K3 off and back on to clear the error condition. Please report this to Elecraft, along with DSP internal error information. (In the <b>TECH MD</b> menu entry, tap <b>1</b> and <b>2</b> to get main/aux DSP info, respectively.)
ERR DSX	Extended DSP command timeout	Reload DSP1 firmware (and DSP2 firmware, if applicable).
ERR DVR	Digital Voice Recorder not found	DVR module may be defective or incorrectly installed, or the MCU or DSP firmware may require updating.
ERR EE1	On-chip EEPROM read/write test failed	MCU may be defective (front panel). Try re-loading MCU firmware first; then try initializing parameters (pg. 66).

ERR EE2	External EEPROM read/write test failed	EEPROM may be defective (front panel). However, this message may also appear if power is turned off/on too rapidly, or if the power supply voltage “bounces” during turn-on due to inadequate regulation. If the power supply is not at fault, try re-loading MCU firmware first; then try initializing parameters (pg. 66).
ERR FP3	Missing display text in flash memory	Try re-loading FPF (flash memory).
ERR FW2	General firmware problem	Try re-loading MCU firmware first; then try initializing parameters (pg. 66).
ERR IF1	RF board IF <b>GROUP</b> not responding (A6810 or KNB3-U2)	<b>*De-install</b> the KNB3 module on RF board. <b>Note:</b> The K3 cannot be operated without a KNB3, because this module includes T-R switching circuitry. Do not attempt to bypass it using jumpers.
ERR IF2	Sub RX IF GROUP not responding (A6810 or KNB3-U2)	<b>*De-install</b> the KNB3 module on KRX3 first (tap SUB when in the KNB3 menu entry). <b>Note:</b> The sub receiver can be operated without a KNB3 if a jumper is placed between pins 1 and 7 of J78 on the KRX3 module.
ERR IO1	MISO line stuck low (asserted)	<b>*De-install</b> option modules one at a time. If no failing option module can be found, there may be a problem on the RF board.
ERR IO3	KIO3 not responding	The KIO3 may be defective. <b>Note:</b> The K3 <i>can</i> be operated temporarily without the KIO3 installed. You’ll need to use headphones, and there will be no computer or AF I/O available on the rear panel.
ERR KEY ERR PTT	Attempt to key the transmitter or activate PTT during power-on	Usually caused by an external device shorting KEY or PTT to ground; disconnect such devices until they’re initialized properly. Also see <i>CONFIG:PTT-KEY</i> . If necessary, try removing the KIO3 module or its digital I/O daughter board.
ERR LPF	No response from LPF shift registers	<b>*De-install</b> option modules one at a time. If no failing option module can be found, there may be a problem on the RF board.
ERR PA1	KPAIO3 module not responding	<b>*De-install</b> the KPA3 module and set <i>CONFIG:KPA3</i> to <b>PAIO ON</b> . If this eliminates the error message, the problem is likely to be on the KPA3 module. If not, the problem may be on the KPAIO3 module; remove it as well, and set <i>CONFIG:KPA3</i> to <b>NOT INST</b> .

ERR PL1/2  ERR SY1/2 ERR SY3/4 ERR SY5/6  ERR VCO ERR VC4	VPLL out of range on band change (to view actual PLL voltage, set <i>CONFIG: TECH MD</i> to <b>ON</b> , then tap <b>DISP</b> and use VFO B to locate the <b>PLL 1</b> and <b>PLL 2</b> voltage displays).  General problem with PLL, VCO, or other circuitry on a synthesizer module.  VCO calibration errors. VFO A will show error data, e.g. <b>E 00039</b> ; report this value to Elecraft customer support.	Verify that the oscillator can on the KREF3 is fully plugged in and is not in backwards. Make sure all internal cables are plugged in, specifically the cables between the KREF3 and KSYN3 modules (synthesizers). Try re-calibrating the applicable VCO ( <i>CONFIG:VCO MD</i> ) (tap SUB within the menu entry if you saw ERR PL2, to make sure you're calibrating the sub receiver's synthesizer). If this doesn't work, try removing the 2 <sup>nd</sup> synthesizer (for the sub receiver), and set <i>CONFIG:KRX3</i> to <b>NOT INST</b> . If this eliminates the error, the sub synth may be defective. You can also try swapping it with the main synth to see if it can be calibrated in this slot.
ERR REF	Missing KREF3 module	Verify that the oscillator can on the KREF3 is fully plugged in. Make sure all internal cables are plugged in between the KREF3 and other modules. If this doesn't help, the problem may be on the KREF3 module or the RF board. Note: The K3 cannot be used without a KREF3 module.
ERR RXF	Invalid receive crystal filter bandwidth	The crystal filter selected for receive is too wide for the current operating mode. If <i>CONFIG:CW QRQ</i> is <b>ON</b> , the maximum allowed receive crystal filter bandwidth is 2.8 kHz. To turn off filters by mode, use K3 Utility or <i>CONFIG:FLx ON</i> .
ERR TXF	Invalid transmit crystal filter bandwidth	The crystal filter selected for TX (with <i>CONFIG:FLTX</i> ) is either too narrow or too wide. You must specify a filter that is 2.7 or 2.8 kHz wide for CW/DATA/SSB, 6 kHz for AM, and 13.0 kHz for FM).
ERR TXG	Transmit gain constant out of range	This usually indicates a problem with band-pass filter alignment or one of the low-pass filters. In either case it could affect one or two bands. Consult Elecraft support before attempting to realign band-pass filters; all settings are aligned at the factory.
ERR XV3	KXV3 not responding	<b>*De-install KXV3 module</b>

# Theory Of Operation

Please refer to the block diagram of the K3 shown at the end of this section. Schematics and additional details can be found on the Elecraft web site. Only basic modules are covered here; for option module circuit details, refer to the individual instruction manuals (KPA3, KBPF3, KXV3, KRX3, PR6).

## RF BOARD

The RF PCB (Printed Circuit Board) is the heart of the K3 transceiver, both physically and electrically. During assembly, it serves as an attachment point for other PCBs as well as chassis panels, acting as the glue that holds things together. During operation, the RF board provides signal routing to and from all modules.

Over two-thirds of the RF board's components are surface mount devices (SMDs), located on the bottom side of the board. These are pre-installed and tested at the factory. The use of SMDs minimizes stray coupling in RF circuits, reduces system cost, and allows the K3 to fit in a modest-size enclosure, compatible with home or field operation.

The RF board is divided into several functional areas, which are described below.

### *Low-Pass Filters (LPFs)*

The relay-switched low-pass filters, used during both transmit and receive, are located in the back-right corner of the RF board. These filters can easily handle 100 watts, and are common to both the K3/10 and K3/100. Some LPFs cover one band, while others cover two bands that are close in frequency. The input to the LPF section comes from the KPA3 100-W amplifier module, if installed; if there's no KPA3, the input comes from the 10-W amplifier (see below). The output of the low-pass filters is routed through the forward/reflected power bridge, then on to either the antenna input module (KANT3), or the KAT3 automatic antenna tuner, which plugs in at far right.

### *Low-Power Amplifier (LPA) and T/R Switching*

The large hole near the back-middle area of the RF PCB is where the 10-W low-power amplifier module plugs in. The LPA has three connectors that mate with the RF board, and its power transistors attach to the rear bottom cover, which serves as a heat sink. This construction method allows the 10-W module to be tested separately during production. Also in this area is the T/R (transmit/receive) switch, but you'll need to turn the RF board upside down to see most of the components. The K3's T/R switch uses high-power, high-isolation PIN diodes rather than relays, resulting in no switching noise during keying.

### *Low Power Amplifier (LPA)*

The low-power amplifier module is capable of up to 12 W power output, and in the case of the K3/10, is the final amplifier stage. In the K3/100, it provides drive to the KPA3 module. The LPA has three gain stages, the last two of which use high-power MOSFET transistors to allow coverage up through 6 meters. At the input to the first gain stage is a 5-dB attenuator, which is switched in under firmware control at certain power levels to optimize transmit gain distribution.

### *Band-Pass Filters (BPFs)*

At back-left is the bank of ham-band BPFs. These filters are just wide enough to cover each ham band, so they provide good rejection of IMD products during both transmit and receive. Hi-Q components, including large toroids, ensure low loss and high signal-handling capability. General coverage receive capability can be added to the K3 with the KBPF3 option, which includes another 8 band-pass filters that cover all of the areas from 0.5 to 28 MHz that are not covered by the filters on the RF board. The KBPF3 module mounts directly above the

main BPF array, and due to its very short connections, has no effect on the performance of the main BPFs during ham-band operation.

### ***First I.F. Stages***

The front-left portion of the RF board is dedicated to the receive/transmit first I.F. (intermediate frequency) circuitry, most of which is on the bottom of the board. The first I.F. is 8.215 MHz, which is low enough to permit the construction of high-quality, narrow-band crystal filters, but high enough to offer good image rejection. The I.F. stages are reversible; i.e., they're used in one direction in receive mode, and the other during transmit. In receive mode, the filtered signal from the BPFs is first routed through a relay-switched attenuator, then to a low-noise diode-switched preamp, high-level switching mixer, and post-mixer amp. The signal next encounters the noise blanker (KNB3), then the crystal filters (see below),

### ***Crystal Filters and 2<sup>nd</sup> I.F.***

In either receive or transmit mode, the I.F. signal is routed to one of up to five plug-in, 8.215-MHz crystal filters (FL1-FL5). These can be fixed-bandwidth, or in the case of FL3-FL5, optionally variable-bandwidth. Following the crystal filters is the receive I.F. and second mixer, which mixes the 8.215 MHz down to an I.F. of 15 kHz for use by the digital signal processor module (DSP). Excellent 2<sup>nd</sup>-I.F. image rejection is obtained by cascading an additional crystal filter just ahead of the second mixer. There's also a 15 kHz transmit I.F., which is mixed up to 8.215 MHz on the KREF 3 module, which plugs in near the front-middle of the RF board.

### ***Support Circuitry***

Several other modules plug into the RF board. The KPAIO3, located at the back edge of the RF board, is a vertically mounted board used as an interface between the RF board and the KPA3 100-W amp module. It provides current sensing, bypass relay, and other functions for the KPA3, and eliminates the need for any interconnecting cables. The KIO3 and KXV3, in the back left corner, provide RF, audio, and digital I/O. The main synthesizer, used for the main receiver as well as the transmitter, plugs in at front left and is attached to the front shield. To the right of this is the reference oscillator module (KREF3), as well as the second synthesizer, used for the sub receiver. These also attach to the front shield. The Front Panel/DSP module plugs in at the very front of the RF board. Finally, at the far right you'll find two low-noise linear voltage regulators, one for 5 volts and the other 8 volts. Both are heat-sunked to the right side panel.

### ***Noise Blanker***

There are two noise blanker subsystems in the K3: the KNB3 module, and a DSP-based blanker (see *DSP* on pg. 74). The KNB3 is a narrow I.F. pulse blanker that plugs into the RF board. Its broad input bandwidth ensures minimum stretching of fast noise pulses, so it's ideal for suppressing noise from power lines, thunderstorms, and auto ignitions. The DSP blanker can be used on many other types of noise, including radar and other noise with complex waveforms that might cause heavy intermodulation if an I.F. blanker were engaged. Using the two blankers in combination is often extremely effective.

The KNB3 includes a triple-tuned bandpass/time-delay filter, wide-range AGC, and a noise gate. You can think of the noise gate as a switch that is normally closed, allowing received signals to pass unimpeded. When a noise pulse appears, it is amplified to a high level and used to trigger a *one-shot* circuit. This opens the noise gate very briefly (from 5 to about 100 microseconds) to blank the noise pulse. Both the threshold at which blanking action occurs and the length of time the gate is opened are under control of the operator.

### ***1<sup>st</sup> Mixer***

The 1<sup>st</sup> mixer combines signals from the input band-pass filters with the output of the synthesizer to obtain the 1<sup>st</sup> I.F., at 8.215 MHz. The mixer is based on a video switching IC with very low ON resistance, resulting in low loss and high signal-handling capability. Since this type of mixer requires low drive, there's very little leak-



through of the local oscillator (synthesizer) signal. The mixer also incorporates a balanced VHF low-pass filter to suppress both internally and externally generated VHF/UHF spurs. This keeps the K3's HF spur complement extremely low, despite the use of a down-conversion system architecture.

## **KAT3 (ATU) and KANT3**

The basic K3/10 includes a KANT3 antenna input module. If you've ordered a KAT3 antenna tuner, the KANT3 is not required and will not be supplied with the kit. In either case, the module plugs into the RF board at the back-right corner. Both the KANT3 and KAT3 provide antenna surge protection, as well as resistors for bleeding off static DC charge. The KAT3 provides a wide-range, switchable C-in/C-out L-network for matching a variety of antennas with SWR as high as 10:1 (100 W) or 20:1 (10 W). There are 8 inductors and 8 capacitors in the L-network, each switched with a DPDT relay for high reliability. The KAT3 also includes a second antenna jack and associated switching relay. There's an additional jack on the board for routing the unused (non-transmit) antenna to the KRX3 sub receiver module.

## **KIO3 (AF/Digital I/O)**

All audio and digital/computer I/O is routed through the KIO3. The KIO3 is made up of three PC boards: Main, Audio IO and Digital IO.

The Main KIO3 board plugs directly into the RF board. It includes a relay to disconnect the right speaker channel in case a mono speaker is plugged into the external speaker jack, isolation transformers for Line In and Line Out signals, a connection point for the internal speaker, a low-noise oscillator to provide voltages for the RS232 serial interface, and various control line inputs and outputs for external transverters, band decoders, and the like. This board also contains a differential output microphone amplifier to equalize the gain between the front and rear microphone jacks, as well as to provide noise immunity for the microphone signal from the rear panel area.

Circuitry to allow use of the serial port RTS or DTR signal lines as PTT and/or KEY inputs is also located on this board. This feature is to support logging and control programs which may use these lines for controlling transmit/receive switching or CW keying.

The Digital IO board plugs into the KIO3 Main board. It includes a DE-9 serial port connector for use with an external PC, and a DE-15 accessory connector for external band decoders (such as the KRC-2), transverters (such as the Elecraft XV-series), and similar devices. It is also the connector to which direct FSK or PSK signaling is applied.

The Audio IO board includes three stereo outputs: headphone jack, speaker jack, and a transformer-isolated Line Out jack. It also provides two monophonic inputs: microphone and an isolated Line In. The Microphone jack can provide bias for an electret microphone when enabled via the *MAIN:MIC SEL* menu entry.

Both Digital and Audio IO boards include extensive bypassing and decoupling to help prevent RF signals getting into the radio through cables attached to their respective connectors.

## **Front Panel and DSP**

The Front Panel is a large plug-in module that includes both the Front Panel and DSP boards, as well as the Aux DSP (if a sub receiver is installed) and digital voice recorder module (if the KDVR3 option is installed).

### ***Front Panel Board***

This board provides the K3's user interface: 35 custom-labeled switches; two dual-concentric potentiometers for gain and squelch control; seven shaft encoders; custom, 240-segment, high-contrast LCD; and 13 discrete LED

indicators. Mic and headphones can be plugged into the front panel, or optionally at the rear panel (see KIO3 description, pg. 73).

The Front Panel PCB also includes the microcontroller unit (MCU), which manages the operation of the K3. All inputs, whether from a switch, knob or external PC, are recognized and acted on by the MCU. All control outputs – such as switching from transmit to receive, sending a CW code element, adjusting the transmitter power, controlling LED brightness, etc. – are produced by the MCU.

The Front Panel also contains a large amount of EEPROM memory for parameter storage, and FLASH memory for program storage. This allows the K3 to be re-programmed with the newest firmware by a simple download from the Internet. It also enables the K3 to remember your favorite settings, particular configuration preferences, and the last setting of controls when power is removed from the radio.

### ***DSP Board***

The K3's Digital Signal Processing (DSP) capabilities provide a rich set of features to help combat QRM and QRN while generating some of the cleanest signals to be found in Amateur radio today. A 32-bit floating point DSP is used for highest performance.

In receive, a 15 kHz IF signal from the RF board is buffered and then digitized by a 24-bit Analog to Digital Converter (ADC). This provides over 100 dB of dynamic range within the passband of the selected crystal (roofing) filter. After the ADC, the DSP converts the signal into a floating point value so dynamic range is not compromised during further processing. Noise blanking and limiting, AGC, amplification, IF and AF filtering are all done within the DSP. Several noise blanking algorithms (methods) are available in the DSP, and a sophisticated AGC system is employed. AM, FM, SSB and CW detectors are also implemented by the DSP. Various audio effects, such as Quasi-Stereo and Binaural, are provided here as well as combining the audio signals from the KRX3 (if installed).

After processing, the resulting audio signals are generated in a stereo 24-bit Digital to Analog Converter (DAC) and applied to separate amplifiers for headphones (front and rear) and speaker. A separate 24-bit DAC and amplifier provide Line Out signals that are not affected by the AF Gain control. This output is typically used by sound card digital mode software.

In transmit, Line In, rear or front Microphone signals are sent to a 24-bit ADC and then processed by the DSP. In speech modes (SSB, AM and FM) and soundcard-based data modes, VOX is derived from these signals as well as receive audio. Microphone equalization, bandpass limiting, conversion to 15 kHz IF, envelope clipping and filtering (if applicable) are all done in DSP, then the signal is passed to another 24-bit DAC and presented to the RF board as a 15 kHz IF signal. Direct FSK, direct PSK and CW signals are generated within the DSP for those modes.

Thus, the DSP is responsible for all signal processing between audio and the 15 kHz IF for both receive and transmit. Like all other modules in the K3, the DSP is managed by the MCU.

The DSP board is piggybacked onto the Front Panel board as part of the Front Panel assembly. The Auxiliary DSP (used if the KRX3 Second Receiver Option is installed) and the KDVR3 option plug into the DSP board.

### **KREF3 (Ref./2<sup>nd</sup> LO)**

The KREF3 module's 49.380-MHz temperature-compensated crystal oscillator (TCXO) is the signal source for the K3's synthesizers. The high-stability TCXO option is typically better than +/- 0.5 PPM over the 0 to 50 C temperature range. This signal is also divided by 6 to provide the 8.230-MHz 2<sup>nd</sup>-LO signal used by the second receive and transmit mixers. In addition to the TCXO and dividers, the KREF3 provides the 2<sup>nd</sup> transmit I.F. mixer, which converts the DSP's 15-kHz transmit I.F. output to 8.215 MHz. This signal passes through a wide crystal filter to ensure rejection of mixer products before being routed to the RF board. The KREF3 obtains its DC and low-frequency I/O signals via an 8-pin connector on the RF board, but its RF outputs are fed to the RF board (and sub receiver) via coax cables. The K3EXREF option locks the KREF3 to an external reference.

## KSYN3 (Synthesizer)

Low phase noise is key to both receiver and transmitter performance. In the K3's synthesizer module (KSYN3), we start with a clean, wide-range voltage-controlled oscillator (VCO). The VCO frequency is placed near the desired band of operation using 128 carefully-selected L-C combinations, which keep the ratio of fixed capacitance to tunable capacitance (varactor diodes) as high as possible.

The VCO is held exactly on frequency by a phase-locked-loop IC (PLL), which samples the VCO output continuously and compares it to its high-stability reference input. The PLL's reference input is obtained from a direct-digital-synthesis (DDS) IC, which is tunable in about 0.2-Hz steps. The reference for the DDS itself is the 49.380-MHz signal from the KREF3 module.

To keep the synthesizer's output signal virtually spur-free, the DDS is followed by a 4-pole crystal filter. This eliminates both directly-occurring spurs and the Nyquist sampling spurs that normally accompany a DDS-driven PLL system.

The combination of all of these noise-minimization techniques results in very low phase noise and negligible discrete spur content.

## Firmware

### Overview

The K3 is controlled by a Microchip PIC18F8722 microcontroller (MCU) on the Front Panel PCB module. It uses a highly-optimized, custom operating system to efficiently handle many complex tasks. In contrast, many transceivers at the K3's performance level embed the equivalent of a complete PC (personal computer) running a conventional operating system. This may simplify software development, but at the cost of higher power consumption, greater RF interference and noise, and slower power up/down cycles.

At the highest level, the K3's MCU firmware runs a continuous *executive loop*. Within this loop, calls are made to handlers for the all user interface elements (switches, potentiometers, encoders, LEDs, LCD, etc.), I/O (RS232 command handling, AUXBUS, SPI peripheral control, T/R switching), and process control (timers, state machines, etc.). In addition, a fast interrupt handler runs every 200 microseconds to service high-speed events such as optical encoder state changes and incoming serial data. This interrupt handler also provides fine-timing services for other functions and state machines, such as RTTY or PSK31 text encode/decode.

The main and aux DSPs are peripherals of the MCU. They execute an extensive set of commands, allowing the MCU to specify operating mode, BFO frequencies, keying waveform start/stop, sidetone pitch, AF and IF gain, filter bandwidth and position, and many other parameters. In some cases the MCU polls the DSP for information periodically. For example, if voice VOX is enabled, the MCU polls every few milliseconds to see if the present mic level is above the user's specified VOX threshold, in which case the rig will be switched to TX mode.

### Transmit ALC and Per-Band Power Control

To eliminate transmit splatter, all ALC in the K3 is applied *before* the narrow first-I.F. crystal filter. However, with some vocalizations, speech energy may build up within a narrow crystal filter to produce a slight peaking effect. Because of this, the user should set the K3's power output level such that it peaks at or below the safe level for any external amplifier under all speech conditions.

To facilitate this, optional per-band power control can be used (see *CONFIG:PWR SET*). This compensates for per-band gain variation in the external amp or the K3 itself, reducing the need for ALC. For example, all crystal filters have a small amount of ripple (typ. +/- 0.5 to 1.0 dB) that can result in a slight difference in average power output between LSB and USB with some voice characteristics. But since you typically use only one of the two sidebands on a given ham band, per-band power control can conveniently compensate for small variations.

# K3 Block Diagram

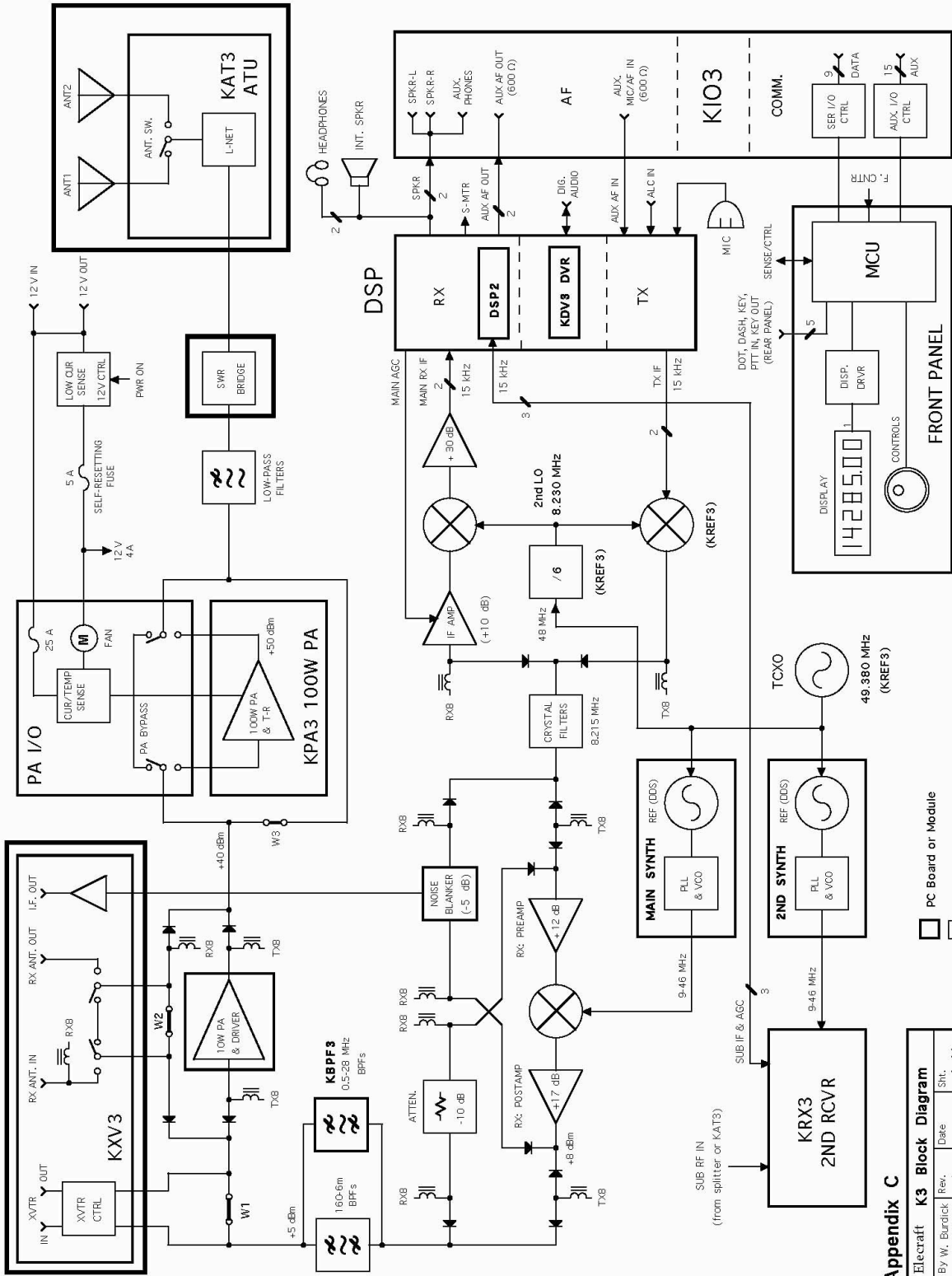

PC Board or Module  
 Functional Block

**Appendix C**

Electcraft K3 Block Diagram			
By W. Burdick	Rev. A	Date 6/6/07	Sheet 1 of 1

# Appendix A: Crystal Filter Installation

**⚠** Damage to your K3 due to electrostatic discharge (ESD) can occur if you don't take proper precautions. Such damage is *not* covered by the Elecraft warranty, and could result in costly repairs. We recommend that you use an anti-static mat and wear a conductive wrist strap with a series 1-megohm resistor. An alternative is to touch an unpainted, grounded metal surface frequently while you are working. Do this only when you are not touching any live circuits with your other hand or any part of your body.

**⚠** To avoid marring the finish, place a soft cloth under cabinet panels; do not lay them directly on your work surface. Also, do not use a power screwdriver of any kind, as it can slip and gouge the paint.

## Installation Procedure

- Disconnect the power cable and all other external cables from the K3.
- Remove *only* the top-cover screws identified in the drawing below.
- Press gently at the indicated point near the back edge (X), then lift off the top cover at the front. Unplug the speaker, then set the top cover aside in a safe place.

**⚠** The screws that hold the top cover in place are an important part of the K3's structural design. Please be sure to re-install all of them afterward.

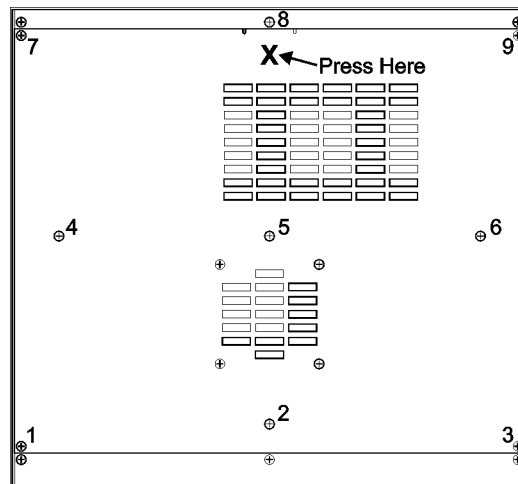

**⚠** Put on your wrist strap or touch a grounded surface before touching any K3 components or modules in the following steps.

- If you have the sub receiver installed (KRX3), refer to its manual for removal instructions.
- If you have the 2-m module installed (K144XV), refer to its manual for removal instructions.

- Locate the crystal filters you presently have installed in slots FL1 - FL5 on the RF board (or sub receiver).

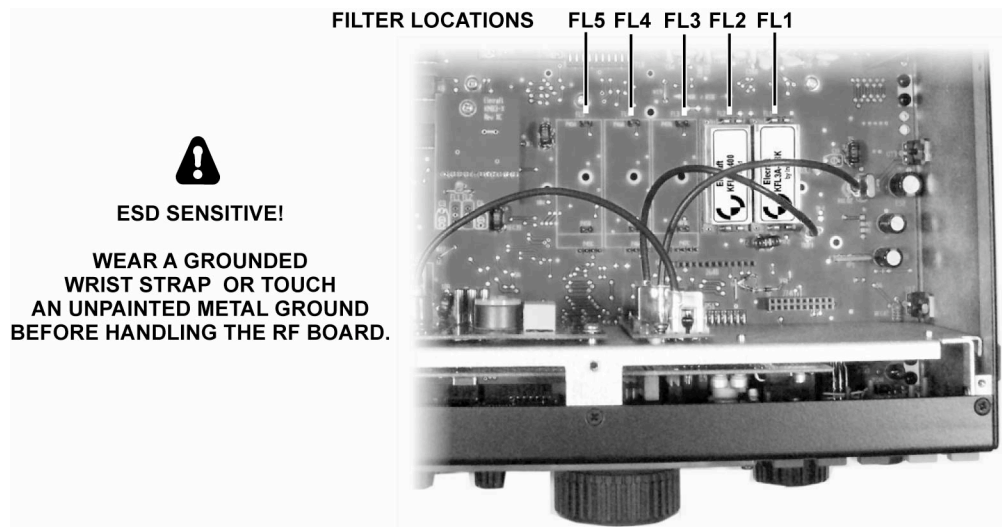

- i** There may be a mix of 5-pole filters (below left) and 8-pole filters (right).

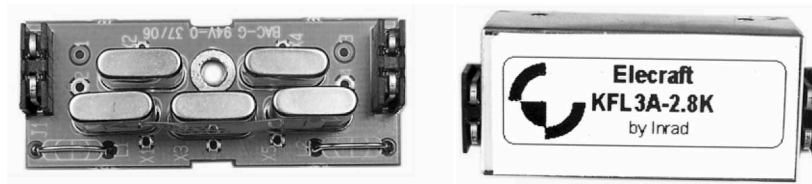

- Review the information below to ensure that your crystal filter setup conforms to K3 requirements.

You can install up to five crystal filters (FL1-FL5) on the RF board, and five on the sub receiver (KRX3). FM operation requires a 13 kHz wide filter. AM transmit requires a 6 kHz filter, and SSB/DATA/CW transmit requires a 2.7 or 2.8 kHz filter; other bandwidths can be used for receive in these modes. Filters as narrow as 200 Hz can be used for CW and narrow-band data receive. A mix of 5-pole and 8-pole filters can be used.

**There are two rules regarding where these filters can be installed in the K3 and how they're used:**

**Rule #1:** If you plan to use a particular filter for both *transmitting* and *receiving* (main receiver), you'll need to install it on the **RF board**. You can optionally install a filter of the same or similar bandwidth on the sub receiver for receive-only use. (This is recommended since it will keep the receivers identical.)

**Rule #2:** You can install any filter in any slot, and can leave any slot empty in anticipation of installing a crystal filter there later. However, you should install the **widest** filter closest to **FL1**, the **next widest** to its **left**, etc. Here are two examples that could each apply to either receiver, assuming you follow the rules above:

FL1	6 kHz (AM)	FL1	{saved for FM filter}
FL2	2.7 kHz (SSB/CW/DATA)	FL2	6 kHz (AM)
FL3	1.8 kHz (SSB/CW/DATA)	FL3	2.8 kHz (SSB/CW/DATA)
FL4	500 Hz (CW/DATA)	FL4	{saved for variable-bandwidth filter}
FL5	200 Hz (CW/DATA)	FL5	400 Hz (CW/DATA)

Fill in the table below (include sub receiver info, if applicable). Use pencil, since you may change the configuration later. **BANDWIDTH** can be obtained from the model number of each filter. 5-pole filters have a **FREQ OFFSET** marked on the side of one of the crystals, e.g. “-0.85”. The offset for all 8-pole filters is 0.00.

RF BOARD (MAIN RX & TX)			SUB RECEIVER (RX ONLY)		
POSITION	BANDWIDTH	FREQ OFFSET	POSITION	BANDWIDTH	FREQ OFFSET
FL1			FL1		
FL2			FL2		
FL3			FL3		
FL4			FL4		
FL5			FL5		

**If you'll be changing RF board filters:** Turn the K3 upside down, placing a soft cloth beneath it. Remove the seven black pan head screws retaining the front bottom cover, then lift the cover off.

Remove the screws holding any existing filters that you'll need to move to obtain the order listed above (on both the RF board and sub receiver).

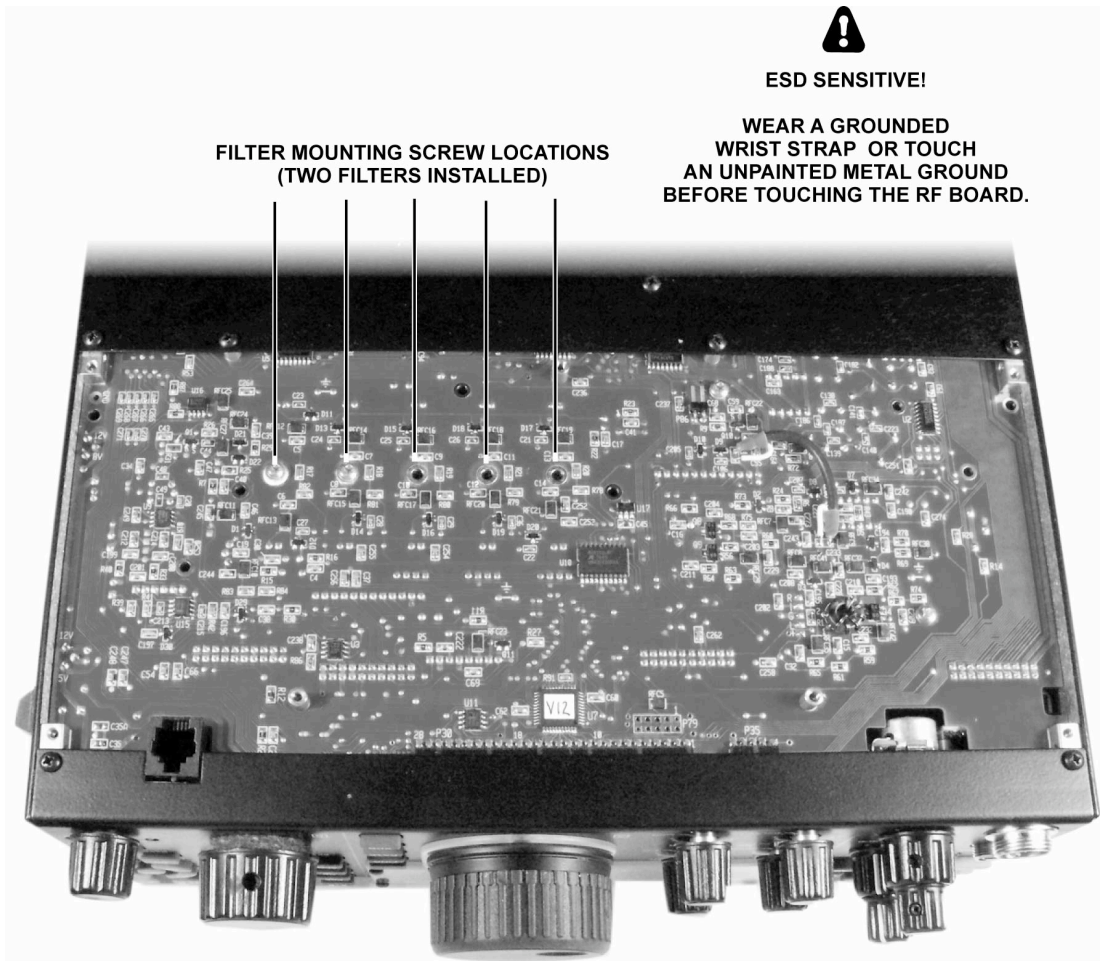

Turn the K3 right side up. Unplug all filters to be repositioned (*those whose mounting screws have been removed*). Lift the filters at each end carefully, first one end then the other, until the connectors separate.

Reposition the filters as required. They will only fit one way. If you put one in backwards, it will not fit within its outline, and the standoff will not line up with the screw hole in the RF board (or sub receiver board).

Turn the K3 (or sub receiver module) upside down again. Install the mounting hardware shown below.

**⚠ Filters may be supplied with either a black 3/16" or bright-plated 1/4" pan-head screw. A screw longer than 1/4" may extend into the 8-pole filter unit and damage it.**

**⚠ Do not over-tighten the screws. Excess torque may pull out the threaded standoff.**

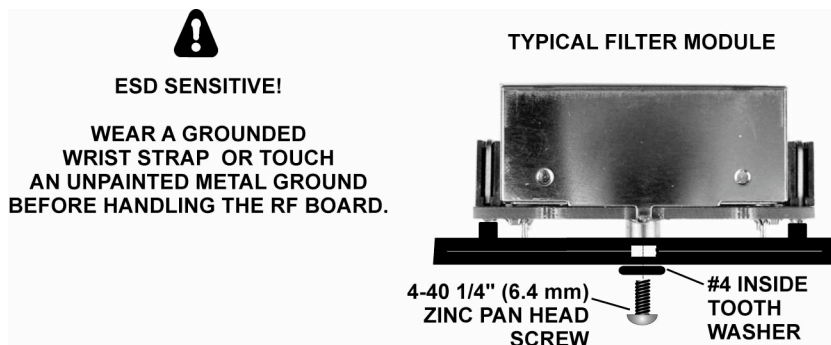

Re-install the bottom cover (if applicable) using seven 4-40 x 3/16" black pan head screws. Replace the screws securely, but do not over tighten them. All screws must be used to maintain shielding performance.

**i** The top cover and sub receiver (if applicable) will be re-installed in at later step.

Turn to **Crystal Filter Setup** (pg. 46). Follow all instructions for the main receiver and transmitter.

If you have the KRX3 option, re-install the sub receiver module as described in the KRX3 manual. Then turn to **Crystal Filter Setup** and follow all instructions for the sub receiver.

Position the top cover on the K3, with its rear tab inserted *under* the top edge of the rear panel. Then plug the speaker wire into P25 on the KIO3 board at the left rear of the K3.

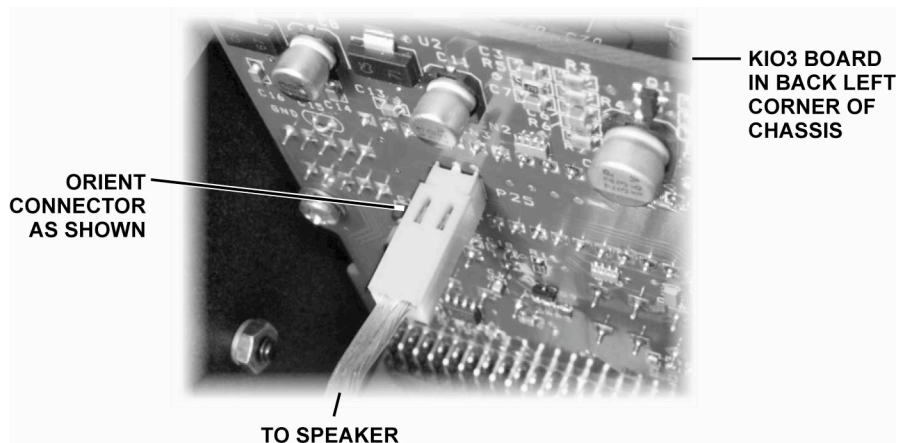

Secure the top cover with 4-40 x 3/16" flat head screws at all locations.

***This completes crystal filter installation.***



# Index

- 12 VDC IN, 17
- 12 VDC OUT, 17
- 1-Hz Tuning, 22
- Accessory 12 VDC Output, 17
- Accessory I/O (ACC), 18
- AF Balance Control, 37, 60
- AF Gain Range, 53
- AF Limiter, 53
- AFSK A Mode, 31
- AFV (Audio Voltmeter), 36, 53
- AFX (Audio Effects), 35
- AGC, 15, 54
- Alarm Function, 6, 36
- ALC, 26, 27, 28, 61, 75
- ALC OFF Warning, 65
- ALC, External, 18, 27, 55, 65
- ALT Switch (Alternate Modes), 22, 30
- Alternate Displays, 36
- AM Mode, 28, 29, 78
- Amplifier Keying Delay, 61
- Amplifier Module, 10 W, 71
- Amplifier Module, 100 W, 47, 56
- ANT3, 17
- Antenna, 5, 6, 17, 39, 41, 45, 49, 51, 65
- Antenna Naming, 22
- APF, 35
- A-to-D Converter Reference, 53
- Attenuator, 15
- Audio Effects (AFX), 20, 35, 74
- Audio Peaking Filter (APF), 35
- Auto Info (AI Mode), 54
- Auto Power-On, 18, 36, 44, 64
- Automatic Antenna Tuner, 22, 56
- Automatic Level Control, 26, 27, 28
- Auto-Spot, 34
- AUX RF, 37, 41
- AUXBUS, 8, 18, 19, 63
- Band Independence (Main/Sub), 62
- Band Mapping, 13, 22, 54
- Band Outputs (BAND0-3), 18, 19, 56
- Band Switching, 13, 57
- Band-Pass Filters, 71
- Bar Graph, 12
- Binaural Audio (AFX), 7, 59, 74
- Block Diagram, 76
- Break-In Delay, 14, 26
- Break-In Keying (QSK), 30
- Buffered I.F. Output, 17, 45, 57
- Calibration Procedures, 49
- Channel Hopping, 40
- Circuit Breaker, 17, 68
- Clock/Calendar, 60
- Compression, 14, 26, 28
- CONFIG Menu, 21, 46, 52, 53, 60
- Configuration, 7, 46, 66
- Connector Groups, 17
- Control Groups, 11
- Cross-Mode Operation, 6, 34, 36
- Crystal Filter Bandwidth, 23
- Crystal Filter Center Frequency, 9, 46
- Crystal Filter Enables, 46
- Crystal Filter Installation, 46, 77, 80
- Crystal Filter Setup, 14, 46, 78, 80
- Crystal Filter, Transmit, 26, 47, 70
- Crystal Filter, Variable Bandwidth, 23, 72, 78
- Current Drain, 7, 21, 36
- Customer Support, 10, 45, 70
- CW Keying Weight, 30, 36, 55
- CW Mode, 30
- CW Normal, 30
- CW Reverse, 12, 13, 22, 30
- CW Speed Display, 33
- CW, Break-In (QSK), 30
- CW, Off-Air Keying, 26, 53
- CW, Sending in SSB mode, 55
- CW, Very High Speed (QRQ), 30, 54
- CWT (CW/DATA Tuning Aid), 34
- CW-to-DATA, 16, 30, 31, 34
- DATA A Mode, 31
- DATA Mode, 31
- DATA Reverse, 12, 13, 22
- Date, 47, 55
- dBV (Audio dB Meter), 36, 53
- Digital Voice Recorder, 7, 16, 29, 56, 73
- DIGOUT0, 18, 19
- DIGOUT1, 18, 41, 45, 55
- Direct Frequency Entry, 15
- Display (LCD), 12, 52
- DSP, 7, 45, 74
- Dual Passband Filtering, 5, 15, 35
- DVR Monitor Level, 29, 61
- Error Messages (ERR xxx), 67
- ESSB, 36, 61
- External ALC, 18, 27, 55, 65
- External Reference, 17
- Fan Panel, 5, 17
- Fan Speed, 27
- Filter Graphic, 12, 14, 23, 32
- FINE Tuning, 22
- Firmware Upgrades, 3, 45

FM, 56  
 FM Deviation, 56  
 FM Mode, 13, 28, 29  
 FP ACC, 13  
 Frequency Entry, Direct, 15  
 Frequency Memories, 16  
 Frequency Range, 8, 40  
 Friction Adjustment, VFO Knob, 48  
 Front Panel, 11  
 Front Panel Accessory Connector, 13  
 FSK, 31, 32  
 FSK D Mode, 31  
 FSK IN, 18, 31, 32  
 Full Break-In (QSK), 13, 30  
 Ground Terminal, 17  
 Headphones, 13, 20, 57, 60  
 HI CUR Warning, 64, 65  
 HI RFI Warning, 65  
 HI SIG Warning, 65  
 HI SWR Warning, 64  
 HI TEMP Warning, 64  
 HICUT (High Cut), 5, 23, 32  
 I/II, 12, 14, 23, 24  
 Iambic Keying, 54  
 IF OUT, 39  
 Intermediate Frequency (I.F.), 23, 72  
 K144XV, 45  
 K3 Utility PC Application, 44, 45, 46, 64, 66  
 KANT3, 41, 42, 68, 71, 73  
 KAT3, 8, 22, 42, 47, 55, 56  
 KBPF3, 9, 36, 56, 68, 71  
 KDVR3, 16, 29  
 KEY OUT, 17, 19, 61  
 Keyboard, 44  
 Keyer Paddle, 17, 30, 54  
 Keyer Speed, 5, 11, 26  
 Keying Weight, 30  
 Keypad, 11  
 KIO3, 6, 18, 55, 64, 69  
 KNB3, 25, 56, 67, 69, 72  
 KPA3, 47, 56  
 KPAIO3, 56, 69, 72  
 KRC2, 57  
 KREF3, 74  
 KRX3, 48, 68, 69, 77  
 KSYN3, 70, 75, 76  
 KTCXO3-1, 32, 45  
 KXV3, 41  
 LCD Test, 57  
 LEDs, 13  
 LINE IN, 20, 31, 32, 47, 52, 73  
 LINE OUT, 20, 32, 57  
 LOCUT (Low-Cut), 5, 32  
 Low-Pass Filter, 37, 41, 70, 71, 73  
 LPA, 71  
 M1-M4, 6, 11, 16, 29, 30  
 Macros, 21, 44  
 MAIN Menu, 21, 52  
 Memories, 16, 57  
 Memory Label, 16, 40  
 Menu Help, 21  
 Message Record/Play, 16, 30  
 Mic Gain, 11, 20, 28, 32, 47, 52  
 MIC Up/Down Buttons, 58  
 Microphone, 28, 73, 74  
 Mode Selection, 15, 22, 28, 56  
 Noise Blanker (NB), 9, 25, 56, 67, 69, 72  
 Noise Reduction (NR), 6, 11, 25, 44  
 NORM1/2 (Filter Normalization), 14, 24  
 Normalizing Filter Passband, 14, 24  
 Notch Filtering, 6, 12, 15, 25  
 Numeric Keypad, 11  
 Option Module Enables, 47, 66  
 Options, 8, 45, 46  
 PA Interface Module, 56, 68, 69, 72  
 Panadapter, 39  
 Parameter Save/Restore, 66, 68, 69, 74  
 Passband Control Granularity, 23, 58  
 PF1, PF2, 6, 16, 21, 32  
 PLL voltage, 36, 70  
 Pot Test (SW TEST), 60  
 Power Control Locking, 14  
 POWER ON Signal, 18, 44, 64  
 Power Supply, 8  
 Preamp, 12  
 Presets, 24  
 Primary Controls, 11, 13  
 Programmable Function Switch, 6, 11, 16, 21, 29, 30, 32  
 PSK D Mode, 31  
 PSK31, 31  
 PTT (Push To Talk), 18, 26, 29, 58, 64, 69  
 PTT Release Delay, 58  
 QSK, 30  
 Quasi-Stereo (AFX), 35, 52, 74  
 Quick Memories, 8, 15, 16  
 Quick-Start Guide, 4, 7  
 Real Time Clock, 47, 48  
 Rear Panel, 7, 17  
 Receive Antenna, 39  
 Receiver Setup, 23  
 REF IN, 17  
 Reference Oscillator, 50, 58, 70, 72, 74, 75  
 Reference, External, 17  
 Remote Control, 7, 8, 44, 54  
 Remote Power-On, 18, 44, 64

**Repeater Offset, 29, 52**  
**RF Board, 71**  
**RF GAIN, 51**  
**RFI Detection, 59**  
**RIT, 6, 11, 14, 16, 22, 62**  
**RIT/XIT Offset, 7, 14, 16, 21, 22, 33, 36, 62**  
**Roofing Filter, 7, 23, 74**  
**RS232, 18, 31, 44, 54, 58, 59, 64, 73**  
**RTC, 47**  
**RTTY, 31, 32**  
**RTTY Letters Shift, 60**  
**RX ANT IN/OUT, 39**  
**RX EQ, 35, 52, 65**  
**Scanning, 6, 14, 40**  
**Semi-Break-In, 5, 14, 26**  
**Serial I/O, 18**  
**Serial Number, 59**  
**SHIFT, 12, 14, 23**  
**Sidetone, 30**  
**S-Meter, 12, 51, 59**  
**Speaker, 35, 37, 59, 60**  
**Specifications, 8**  
**Speech Compression, 14, 26, 28**  
**SPKRS=1 Warning, 65**  
**SPLIT and Cross-Mode Operation, 6, 14, 26, 36, 65**  
**SPLIT Save (Per Band), 59**  
**Spot, 15, 30**  
**Spurious Signal Removal (Receive), 59**  
**Squelch, 14, 60**  
**SSB +CW, 55**  
**SSB Mode, 28**  
**SSB, Selecting Alternate Sideband, 12, 28**  
**SSB/CW VFO Offset, 29, 30**  
**Sub Receiver, 5, 17, 37, 41, 42, 43, 47, 53, 57**  
**Supply Voltage, 8**  
**Switch Test, 60**  
**Switch Tones, 60**  
**Sync Data, 32, 58, 60**  
**Synthesizer, 36, 49, 55, 68, 70, 72, 75, 76**  
**Tap/Hold Switch Functions, 11, 21**  
**TCXO, 8, 32, 45, 50, 74**  
**Tech Mode Menu Entries, 60**  
**Temperature Sensor, 51, 56, 58, 64**  
**Terminal Emulator, 44**  
**Text Decode and Display, 23, 30, 33**  
**Theory Of Operation, 71**  
**Time, 47**  
**Transmit Crystal Filter, 26, 47, 70**  
**Transmit Gain Calibration, 49, 62**  
**Transmit Inhibit, 18, 19, 27, 61**  
**Transmit Noise Gate (Voice Modes), 29, 61**  
**Transmitter Setup, 26**  
**Transverter, 8, 9, 18, 19, 39, 49, 57, 65**  
**Transverter Control, 62**  
**Troubleshooting, 64**  
**Tune Power, 61**  
**Tuning Aids, 34**  
**Tuning Rate, VFO, 6, 22, 36, 47, 62**  
**TX EQ, 5, 6, 28, 35, 52**  
**TX LED, 6, 26, 45, 64**  
**TX TEST, 5, 12, 18, 26, 28, 30, 34, 58**  
**TXGN, 62**  
**VCO Calibration, 49, 62**  
**VFO B Alternate Displays, 36**  
**VFO B to A Copy, 62**  
**VFO Counts per Turn, 62**  
**VFO Knob Friction Adjustment, 48**  
**VFO Tuning Controls, 6, 22, 36, 47, 62**  
**Voice Modes, 5, 23, 28**  
**VOX Delay, 14**  
**VOX, Voice Modes, 13, 29**  
**Wattmeter, 28, 49, 62**  
**WIDTH, 12, 14, 23**  
**XFIL, 15, 46, 56**  
**XIT, 6, 11, 14, 16, 22, 62**  
**XVTR IN/OUT, 9, 39, 49, 57, 65**