

h
communications
**OPERATING and SERVICE
INSTRUCTIONS**



the hallicrafters co.
MANUFACTURERS OF RADIO AND ELECTRONIC EQUIPMENT, CHICAGO 24, U.S.A.

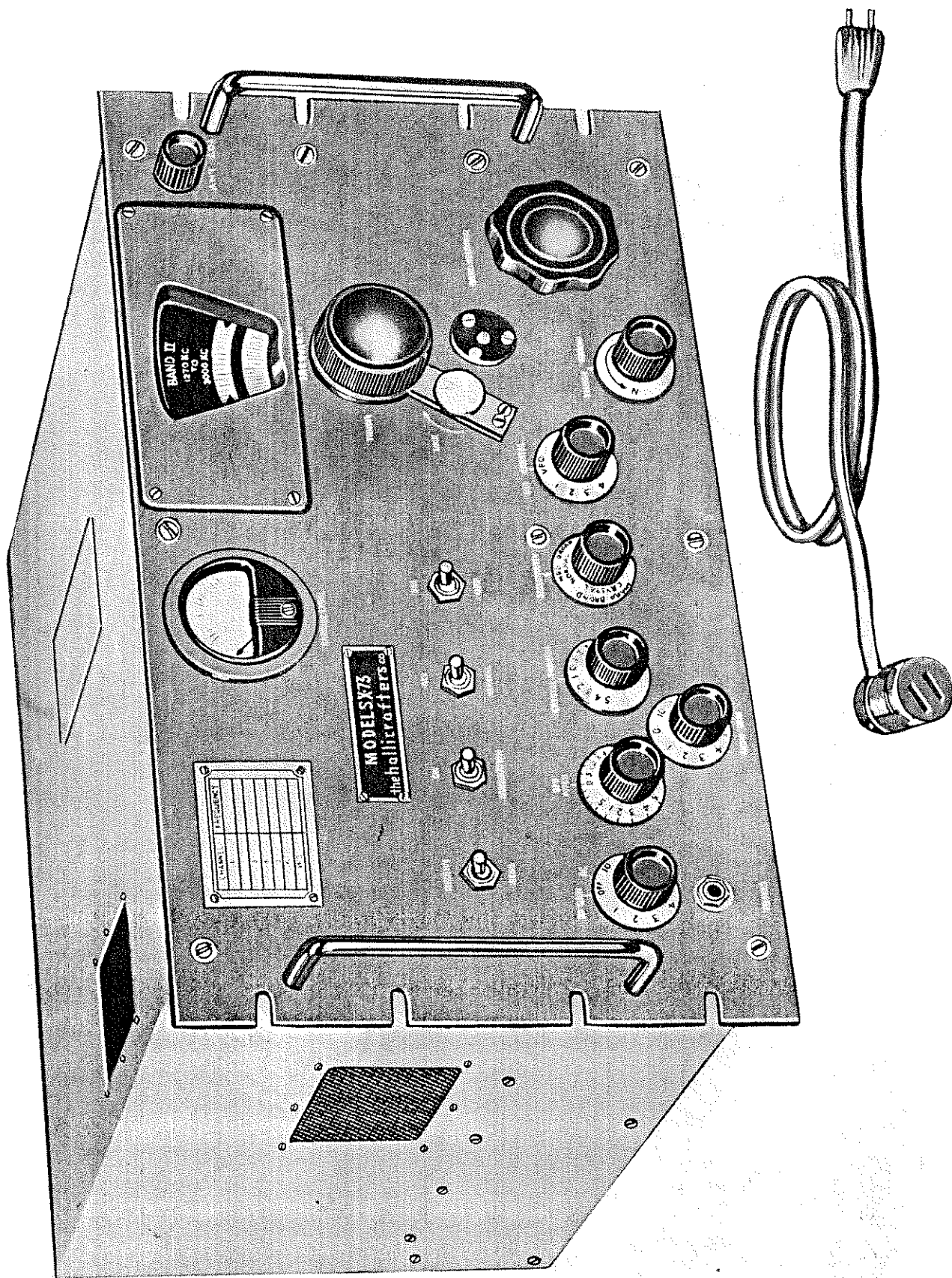

Fig. 1. Hallicrafters Communication Receiver Model SX-73

TABLE OF CONTENTS

HEADING	PAGE
GENERAL DESCRIPTION	1
INSTALLATION	2
OPERATION	3
CIRCUIT DESCRIPTION	5
SERVICE OR OPERATING QUESTIONS	7
SERVICE INSTRUCTIONS	8
LUBRICATION	8
MECHANICAL ADJUSTMENTS	8
ALIGNMENT PROCEDURES	9
IF ALIGNMENT	10
RF ALIGNMENT	12
RF TURRET ALIGNMENT	12
SERVICE PARTS LIST	20, 21, 22, 23

LIST OF ILLUSTRATIONS

FIGURE 1. HALLICRAFTERS COMMUNICATION RECEIVER MODEL SX - 73	1
FIGURE 2. CONNECTIONS FOR OPERATING.	2
FIGURE 3. OPERATING CONTROLS.	4
FIGURE 4. BLOCK DIAGRAM	6
FIGURE 5. LUBRICATION OF DIAL DRIVE MECHANISM.	8
FIGURE 6. LUBRICATION POINTS, BOTTOM.	8
FIGURE 7. LUBRICATION POINTS, TOP.	8
FIGURE 8. IF ALIGNMENT DIAGRAM	11
FIGURE 9. RF ALIGNMENT DIAGRAM	12
FIGURE 10. SELECTIVITY CURVES	14
FIGURE 11. TYPICAL AF RESPONSE CURVE	15
FIGURE 12. SECOND MIXER AND 6.455 mc OSCILLATOR CHASSIS, BOTTOM VIEW	15
FIGURE 13. RECEIVER CHASSIS, TOP VIEW.	16
FIGURE 14. IF AND AUDIO CHASSIS, BOTTOM VIEW.	17
FIGURE 15. RF CHASSIS, BOTTOM VIEW.	18
FIGURE 16. TUBE LOCATION DRAWING	19
FIGURE 17. VOLTAGE AND RESISTANCE CHART	24
FIGURE 18. + VOLTAGE DISTRIBUTION DIAGRAM	25
FIGURE 19. RESISTOR - CAPACITOR BOARD, LOCATION DIAGRAM	26
FIGURE 20. SCHEMATIC DIAGRAM	27

HALLICRAFTERS COMMUNICATION RECEIVER

MODEL SX-73

TECHNICAL CHARACTERISTICS

Frequency range: .54 to 54 mc.

BAND I	540 to 1,270 kc (kilocycles)
BAND II	1.27 to 3 mc.
BAND III	3 to 7 mc.
BAND IV	7 to 13.8 mc.
BAND V	13.8 to 29.7 mc.
BAND VI	29.7 to 54 mc.
Crystal-controlled channels	Six channels in 1.5- to 29.7-mc range.
Receiver Type	Superheterodyne, single or double conversion.
Types of signals which may be received	cw, icw, mcw (tone and voice), and carriershift radioteletype
Number of tubes	19.
Intermediate frequencies	455 kc and 6 mc.
Dial calibration accuracy	Within .2 percent.
Power Input	95/105/117/130/190/210/234/260 volts, 50 to 60 cps (cycles per second), single-phase. Approximately 120 watts.
Antenna input	Balanced antenna input; 50 to 200 ohms.
Antenna	Balanced double or single wire and ground.
Weight	58 pounds.

DESCRIPTION

The Hallicrafters model SX-73 is a 19 tube radio communications receiver built to the highest standard of precision quality. All components meet or exceed rigid JAN (Joint Army and Navy) requirements for electronic equipment. The receiver covers the frequency range of .54 to 54 megacycles in six continuous wave bands and provides for the reception of AM, CW, and MCW signals over the entire frequency range. A single conversion superheterodyne circuit is employed for the reception of frequencies between .54 and 7 megacycles. Excellent image rejection is achieved by employing a double conversion superheterodyne circuit for the reception of all signals of higher frequency.

Tuning is accomplished by means of a single control that operates both the main tuning and bandsread dial scales. A precision anti-backlash gear train provides extremely close calibration and accurate resetability. A tuning lock provides positive locking action without affecting the frequency setting. Provision has also been made for fixed frequency reception on any number of channels from one to six in the frequency range of 1.5 to 29.7 megacycles. This is accomplished by installing a separate crystal to control the local oscillator frequency for each of the predetermined channels. These crystals are not supplied with the receiver.

Band switching is accomplished by means of an ingeniously designed rotary turret that places the appropriate coils adjacent to their respective tuning capacitor sections. This arrangement assures greater stability and maximum sensitivity at a high signal to noise ratio. Extreme sensitivity is also facilitated by the use of two tuned radio frequency stages on all bands.

The selectivity of the receiver may be varied over a wide range to provide optimum performance for various types of signals under all receiving conditions. In addition to manual control over the bandpass characteristic of the i-f stages the receiver is provided with a crystal filter network and phasing control. This combination together with an effective automatic noise limiter circuit insures the best possible reception under the most adverse receiving conditions.

Audio output from the receiver may be fed to either an external speaker or to headphones (not supplied with the receiver). A special "audio input" connector has been provided to permit use of the audio section separately if desired.

The receiver is also provided with an "i-f output" connector which will supply ample power at 455 kc to operate associated equipment such as carrier shift teletype. Provision has been made for the connection of a remote Send - Receive switch when the receiver is used in conjunction with a transmitter.

The Hallicrafters model SX-73 is complete with a self contained regulated power supply and is designed to operate from a power source supplying 95 - 260 volts, 50 - 60 cycles AC. Taps are provided on the power transformer at appropriate steps within this voltage range. Power is connected by means of a detachable line cord supplied with the receiver. An AC power outlet has been included on the rear of the chassis that operates independently of the receiver power switch.

INSTALLATION

The receiver is designed to mount in a standard 19 inch radio relay rack. The sides of the front panel are provided with slots to accommodate machine screws for mounting purposes. Two handles are provided on the front of the receiver for convenient carrying or handling. All connections such as power, antenna terminals, speaker, and special purpose connectors are located on the rear of the receiver chassis. Access to the tubes, internal controls, antenna and i-f coax connectors, and crystals, and terminals is gained by removing the top and rear dust covers which are retained by means of dzus fasteners.

UNPACKING - Carefully remove the receiver from the shipping carton taking special care to observe all shipping tags and labels for special instructions before removing or destroying them. Install all tubes that may be separately packaged. Refer to fig. 16 for an illustration showing tube location.

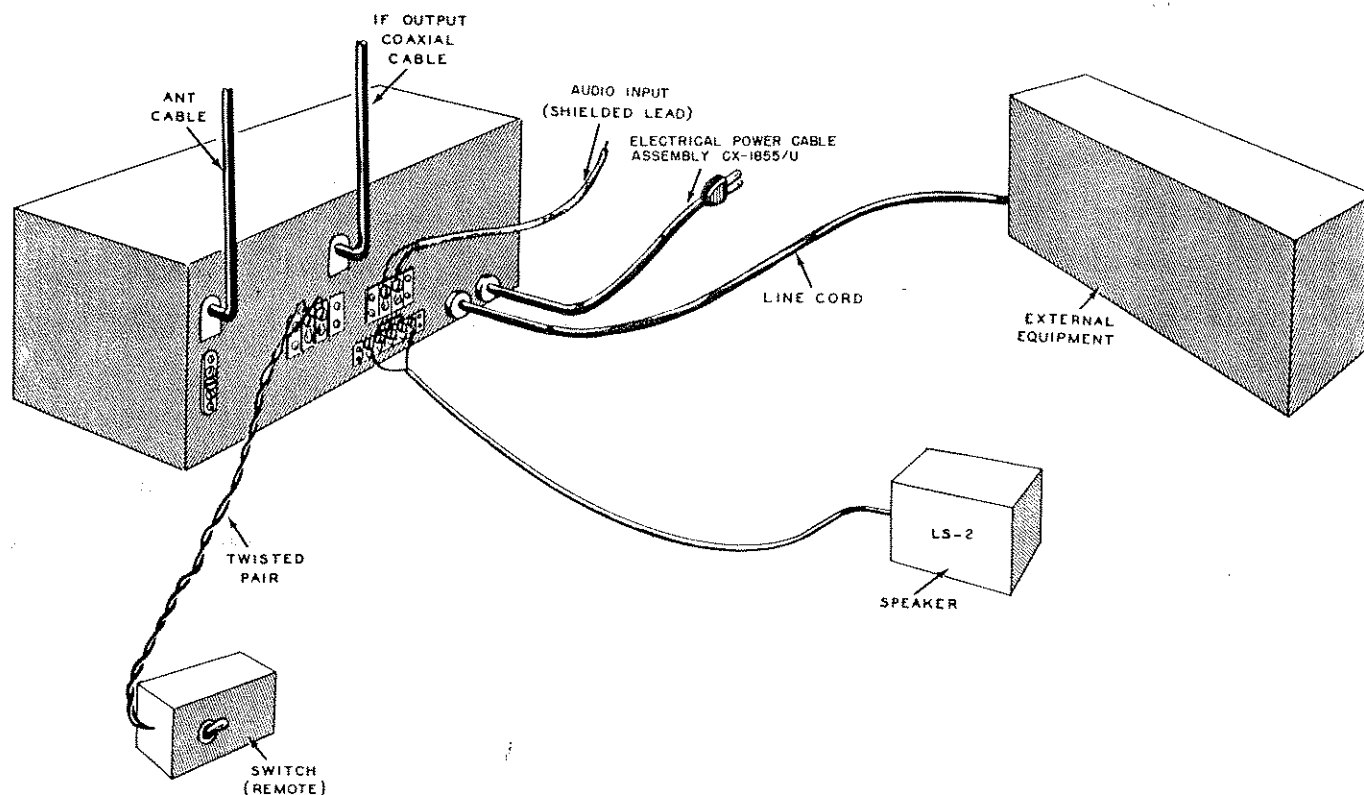

Fig. 2. Connections for Operating

SPEAKER - Connect the speaker, if used, to the AUDIO OUTPUT terminal strip (E4) on the rear of the chassis (fig. 2). The audio output is designed to match either a 150 or 600-ohm load by connecting the secondary speaker windings of the audio output transformer, T35, in series or just using one of the secondary windings. Normally, when matching a speaker to a line, the 600-ohm output is preferred. In this case the secondary may be connected in series by connecting a jumper wire across terminals 2, and 4 on the AUDIO OUTPUT terminal strip (E4). If a speaker of the permanent magnet type is used with a low-impedance voice coil (3 to 50 ohms), a matching transformer should be used between the receiver audio output and the speaker. A headset may be plugged into the PHONES jack J3 on the front panel. The headphone output is designed to accommodate various impedances that headphones usually require. Radio-teletype equipment is connected through an RF Cable Assembly (not supplied) to jack J2 on the top rear of the chassis. Connect a 600-ohm 2-watt load resistor across terminals 1 and 5 of the AUDIO OUTPUT strip E4 if no external equipment is to be connected to this output, and place a jumper wire across terminals 2, and 4.

ANTENNA - Attach a single wire antenna and ground or a balanced antenna and ground to antenna terminal strip E1. A coaxial cable connector J1 is provided for use with twin coaxial cable lead-ins. The external ground connection should consist of a good earth ground approximately 6 feet below the surface. To satisfy this requirement, a metallic pipe or stake driven into the earth or connection to a part of a metallic underground water system should be used.

REMOTE STANDBY SWITCH - To provide a remote connection for a stand-by switch the connecting wires must be connected to the SEND/REC. terminal strip E2 on the rear of the chassis (fig. 2). To make connections to this terminal strip, the terminal strip cover must be removed by taking out the two retaining screws.

AUDIO USE ONLY - Sometimes it will be desirable to use the audio amplifier of the receiver without using the rest of the receiver. To do this, the audio signal is fed into the AUDIO IN terminal strip E3, which is the audio input to the 1st a-f amplifier. Hum reduction can be accomplished by using a shielded-type lead for this connection.

POWER CONNECTION - Plug the female receptacle of power cord W1 to the A-C INPUT plug P1 located on the rear of the chassis. Connect the other end of the power cord to a single-phase 50 to 60 cps power source which can supply the correct voltage for the receiver input. The receiver can be used with the following voltages: 95/105/117/130/190/210/234/260 volts.

CAUTION: Make sure receiver power transformer T34 primary is set to the same voltage as the power source. Refer to the schematic diagram for the proper connections. The location of transformer T34 can be found in figure 14.

OPERATION

TABLE I SHOWING THE FUNCTION OF OPERATING CONTROLS

Control	Function
BAND SELECTOR (turret)	Selects the band containing the desired frequency.
TUNING (C1)	Selects desired frequency by means of a dial mechanism and ganged tuning capacitors. A scale indicates the frequency. It has a dial LOCK to prevent any change in frequency after once set.
ANT ADJ (C22)	Tunes secondary of antenna transformer.
ANL-OFF (S3)	Switches a series type automatic noise limiter into the circuit to reduce noise peaks of electrical interference.
AGC-MANUAL (S...)	Selects either AGC or MANUAL operation and places CARRIER LEVEL meter in operation in the AGC position.
CW-MODULATION (S5)	Turns the bfo (beat-frequency oscillator) on in the CW position to provide a beat note which can be heard when receiving an unmodulated carrier.
RECEIVE-SEND (S6)	Stand-by switch which makes or breaks screen B _t to the r-f (radio-frequency) and i-f sections of the receiver.
RF GAIN-AC (R83, S7)	Turns the a-c power on and OFF and also controls the r-f gain of the receiver.
BFO PITCH (C183)	Varies the bfo signal $\pm 3,000$ cps. The audio signal is then varied from 0 to 3,000 cps.
CRYSTAL PHASING (C161)	Tunes out unwanted interference or signals when the SELECTIVITY switch is in any of the crystal positions.
SELECTIVITY (S1)	A gang switch selects different degrees of i-f expansion in bandwidth and also inserts an i-f crystal filter in the crystal positions.
VFO CRYSTAL (S2)	Switches to either VFO or crystal high-frequency oscillator, and also selects one of six crystals in the crystal position.
CRYSTAL VERNIER (C125)	Varies the frequency of the crystal HFO slightly ($\pm 0.005\%$) to compensate for crystal tolerances.
AUDIO GAIN (R94)	Adjusts the audio level to the audio amplifiers.
PHONES (J3)	Provided to allow the use of a headset when desired.
CARRIER LEVEL meter (M1)	Indicates in db (decibels) the input signal strength. (Zero reference is 50-uv (microvolt) input signal.)

OPERATING PROCEDURES

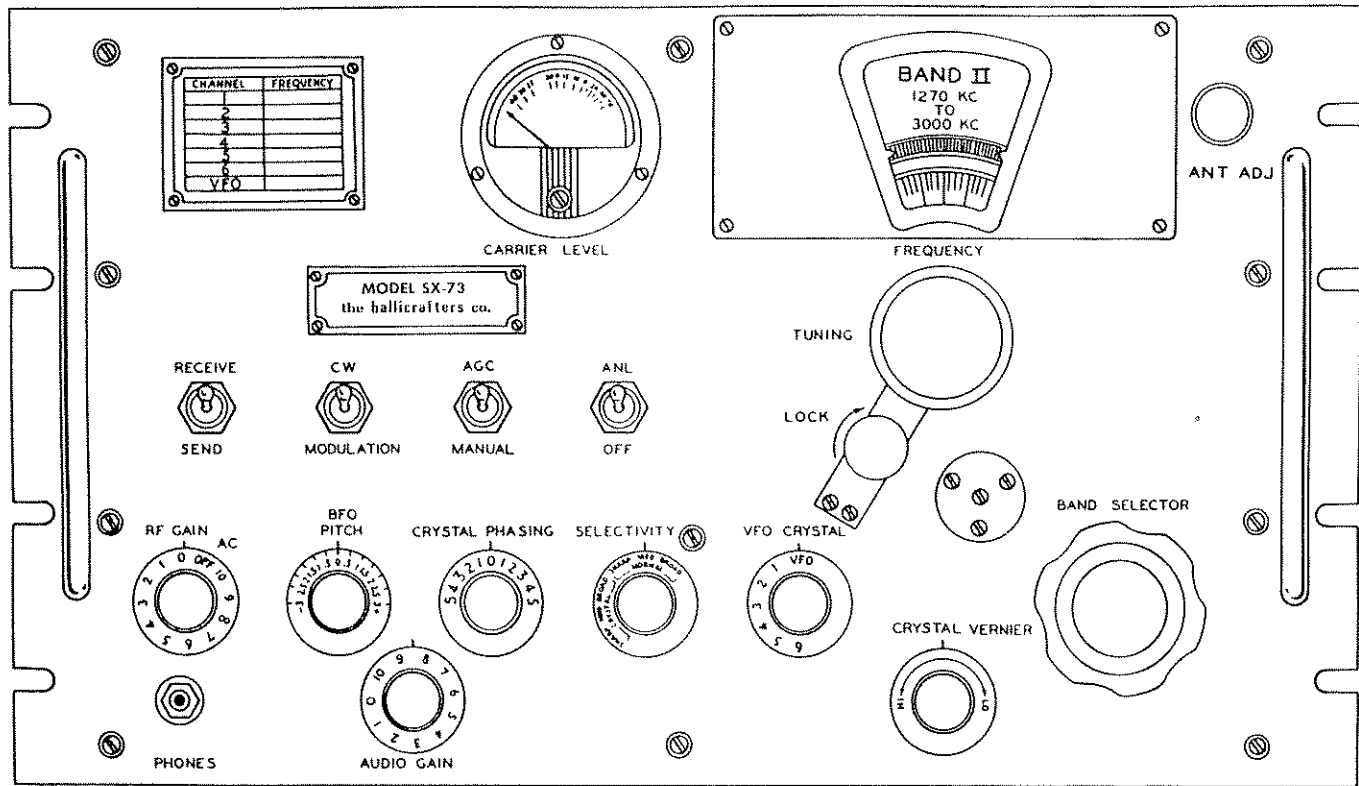

Fig. 3. Operating Controls

TO PLACE IN OPERATION - Set the front panel controls as follows:

TABLE 2

Control	Position	Control	Position
RECEIVE-SEND	RECEIVE	CRYSTAL PHASING	0
CW-MODULATION	MODULATION	SELECTIVITY	NORMAL MED
AGC-MANUAL	AGC	VFO CRYSTAL	VFO
ANL-OFF	OFF	CRYSTAL VERNIER	Mid
BFO PITCH	0	ANT ADJ	As required
AUDIO GAIN	5		

Turn the RF GAIN-AC control fully clockwise to turn on the receiver. The pilot lights will light, and in approximately 2 minutes noise will be heard from the headset or speaker.

RADIOTELEPHONE OPERATION - VFO OPERATION - Turn the VFO-CRYSTAL switch to the VFO position.

Set the BAND SELECTOR to the band which contains the frequency range of the signal to be received. When the desired band is selected, the band number will appear at the top of the tuning dial above the frequency calibrations on BANDS I, II, and III, and below on BANDS IV, V and VI.

Place the CW-MODULATION switch in the MODULATION position.

The desired frequency is tuned by turning the TUNING control. The frequencies for each band tuned are read directly from the dial scale. Tune the ANT ADJ until the maximum output is obtained from the receiver. (The CARRIER LEVEL meter will indicate peak if the AGC-MANUAL switch is in the AGC position.)

The AGC-MANUAL switch may be used as desired with this type of operation. When the switch is in the AGC position the CARRIER LEVEL meter is connected in the circuit; but when the switch is in the MANUAL position, the meter circuit is open. The CARRIER LEVEL meter gives an approximate indication of the input level of various tuned signals as they are received from the antenna. The meter is graduated in db and adjusted so that a 50-uv input at the antenna will produce a reading of 0 db on the meter. An adjustment for 0 db is obtained by setting METER ZERO potentiometer R87. Reference levels of other r-f signal inputs may then be read directly on the meter. With no signal being received, the CARRIER LEVEL meter needle will have a tendency to move off the left-hand side of the scale. An input level of 3 uv will produce a sufficient d-c (direct-current) voltage change in the agc circuit to bring the needle on the CARRIER LEVEL meter up to the beginning of its scale. Other indications on the scale will be dependent on the amount of voltage developed in the agc circuit and, therefore, on the incoming r-f signal strength.

If noise is present along with the received signal, place the ANL-OFF in the ANL position.

Bandwidth of the receiver may be varied by means of the SELECTIVITY switch. The crystal positions should not be used for anything but c-w operation; otherwise, the bandwidth will be so narrow that speech will be unintelligible.

When the receiver is used in conjunction with a transmitter, the RECEIVE-SEND switch (S6) can be used as a stand-by switch for the receiver during transmission; therefore, the receiver is always ready for instant use. For convenience, a remote control switch may be used for this action. Connect the SPST (single-pole, single throw) switch across the SEND/REC. terminal board E2 and maintain RECEIVE-SEND switch S6 in the SEND position.

Adjust the AUDIO GAIN control, R94, to obtain the desired output for the headset, loudspeaker, or other external equipment being used.

CRYSTAL OPERATION - Turn the VFO CRYSTAL switch from the VFO position to one of the six crystal positions. This position should be the desired frequency.

Six crystal channels may be used to facilitate receiver tuning to regularly assigned frequencies for any particular area operation. The frequencies which may be assigned lie within the range of 1,500 kc to 29.7 mc. When a frequency is assigned, choose a crystal which will produce a beat frequency with the incoming frequency to set up the desired i.f. in the output of the 1st mixer (V3). The crystal oscillator frequency to be used, whether it is the fundamental or a second or third harmonic, always must be above the incoming signal frequency by a difference equal to the i.f. For example, if the incoming signal frequency is between 1.5 mc. and 7 mc, the crystal oscillator must produce a frequency 455 kc higher than the signal frequency. If the incoming signal frequency is between 7 mc and 29.7 mc, the crystal oscillator must produce a frequency 6 mc higher than the incoming frequency.

Continue with the same procedure used for VFO (variable frequency oscillator) operation.

The CRYSTAL VERNIER control is used to tune the crystal oscillator to the correct frequency. It can vary the crystal frequency slightly, either higher or lower than the resonant frequency of the crystal. The correct procedure in using the control is to get the desired signal, and then use the CRYSTAL VERNIER control to obtain a peak output.

CW RECEPTION - The procedure for listening to c-w reception with either vfo or crystal operation is the same as the procedure used in receiving radiophone reception, except for the following differences:

- (1) Turn the CW-MODULATION switch to the CW position.
- (2) Adjust the BFO PITCH control to obtain the desired tone.
- (3) Place the AGC-MANUAL switch in the MANUAL or AGC position.
- (4) The SELECTIVITY control can be set to the position giving the clearest signal with the least interference. When using the crystal positions, the CRYSTAL PHASING control will further adjust the bandwidth and tune out unwanted signals or interference. In the CRYSTAL-SHARP position, the CRYSTAL PHASING control is very critical.
- (5) The other controls can be adjusted in the same manner used for radiophone reception.

CIRCUIT DESCRIPTION

The circuit of the SX-73 communications receiver is of the superheterodyne type employing single conversion at signal frequencies up to 7 megacycles and double conversion at higher signal frequencies. The intermediate frequencies used are 455 kc on single conversion and 6 mc and 455 kc on double conversion. Provision is also made for six crystal controlled oscillator frequencies from 1.5 mc to 29.7 mc.

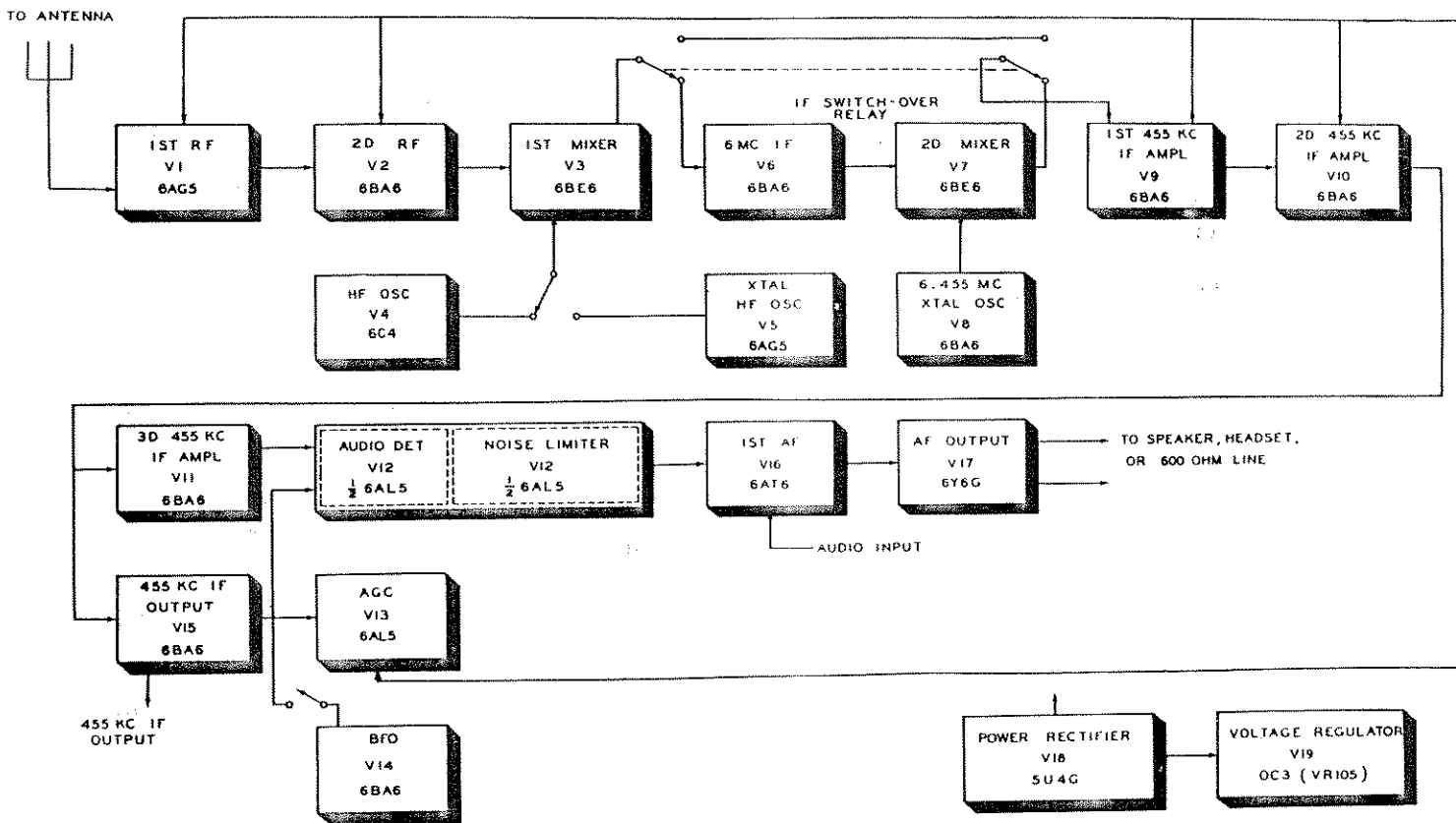

Fig. 4. Block Diagram

The signal from the antenna is coupled to the 1st r-f amplifier (V1) through antenna transformer T6. After amplification, it is impressed on the grid of the 2d r-f amplifier (V2). The use of two pentode stages of r-f amplification gives sufficient gain for a good signal-to-noise ratio. From the 2d r-f amplifier (V2), the signal goes to the 1st mixer (V3) where it is combined with the signal from either the variable-frequency h-f oscillator (V4) or crystal h-f oscillator V5, depending on the position of the VFO CRYSTAL switch. In the signal frequency range of 540 kc to 7 mc, the frequency of the variable-frequency oscillator is always 455 kc higher than the signal frequency, so that the output of the 1st mixer (V3), which is the result of the combination, contains a 455 kc signal. This signal goes to the grid of the 1st 455-kc i-f amplifier (V9). From the frequency range of 7 mc to 54 mc, a better image rejection ratio can be obtained if the intermediate frequency is increased. Therefore, in this frequency range, the variable-frequency oscillator is always 6 mc above the signal frequency. Thus, the output of the first mixer (V3) (in which the signal and the output of the variable-frequency oscillator are combined) contains a 6-mc signal.

When the receiver is tuned to a frequency, in the range of 7 mc to 54 mc, the i-f switch-over relay (K1) feeds the 6-mc output of the 1st mixer (V3) to the grid of the 6-mc i-f amplifier (V6) where it is amplified and where sufficient selectivity is provided to give a high degree of image rejection. However, more amplification and greater selectivity are required before detection. Therefore, the output of the 6-mc i-f amplifier (V6) goes to the 2d mixer (V7). The output of a 6.455-mc crystal-controlled oscillator (V8) also is injected into this 2d mixer (V7). As a result of the combination of these two signals, the output of the 2d mixer (V7) contains a 455-kc signal. This output then is fed through the i-f switch-over relay (K1) to the grid of the 1st 455-kc i-f amplifier (V9) for further amplification. Note that when the receiver is tuned to a signal in the frequency range from 540 kc to 7 mc, the output of the 1st mixer (V3) goes directly to the grid of the 1st 455-kc i-f amplifier (V9) so that when the signal reaches this point, the operation is the same regardless of the frequency to which the receiver is tuned.

The 455-kc signal which goes to the 1st 455-kc i-f amplifier (V9) is amplified successively by the 1st (V9), 2d (V-10), and 3d (V11) 455-kc i-f amplifier stages which also provide the proper degree of selectivity. Provision has been made for variation of this selectivity according to the requirements at hand.

After it has passed through the 3d 455-kc i-f stage (V11), the amplified signal is sent to the audio detector (1/2 of V12) where it is demodulated and fed into the 1st a-f amplifier (V16). The output of V16 is coupled to the a-f output stage (V17) which amplifies the signal with power enough to actuate headphones or speakers, or to feed a 600-ohm audio transmission line. The noise limiter (1/2 of V12) can be switched in between the audio detector (1/2 of V12) and the 1st a-f amplifier (V16) when the reduction of static pulses or other electrical disturbances is desirable.

In order to have a good agc system without causing audio distortion, an agc duo-diode (V13) is connected in such a position in the circuit that it is isolated from the normal signal channels. The output of the 2d 455-kc i-f amplifier stage (V10) is transformer-coupled to the grid of the 3d 455-kc i-f amplifier stage (V11) and also to the grid of the i-f output stage (V15). The output of this tube, which couples into the agc system, also is isolated from the normal signal channel. The agc tube (V13) couples the negative bias, which the operator selects with the RF GAIN-AC control (R83), to the control grids of tubes V1, V2, V9, and V10. The rectified i-f signal superimposes additional negative voltage to the grid input circuit when a strong signal is tuned. The stronger the incoming signal, the greater the negative bias. Conversely, a small signal strength allows the over-all amplification to be greater. This produces a self-balancing arrangement in which the audio output voltage is held fairly constant even though the r-f signal strength varies greatly.

In order to hear c-w signals, a beat-frequency oscillator (V14) is used. It generates a signal which is combined with the i-f signal at the audio detector (1/2 of V12) which detects both to produce an audio beat note which is amplified by the audio amplifiers (V16 and V17). The frequency of beat-frequency oscillator V14 can be varied slightly above and below 455 kc to give the most effective audio note. During the silent periods between transmitter pulses, no 455-kc signal will be present at the detector input, and no beat note will be sent through the audio stages.

Some communication equipment, for example radioteletype, requires i-f output facilities. To give this service, a separate i-f amplifier stage (V15) has been provided. The signal from the 2d 455-kc i-f amplifier (V10) goes to the grid of V15 where it is amplified. The output is transformer-coupled to a low-impedance level so that it can be connected by coaxial cable to the external equipment. The i-f output stage also furnishes a signal to the agc circuit.

A meter (M1) is provided to help in tuning and to give an approximate indication of the relative strength of the incoming signal. The meter circuit measures the voltage in the agc circuit when the AGC-MANUAL switch is in the AGC position. The meter circuit is not connected when the switch is in the MANUAL position. The amount of current through the meter is proportional to the average magnitude of the incoming signal.

The receiver operates from an a-c source (50 to 60 cycles) only. Source voltage of 95 through 260 volts can be used by the selection of the proper tap on the power transformer (T34). Rectifier tube V18 is a full-wave rectifier which supplies d-c plate power to the other tubes in the receiver. V-19 is a regulator tube which provides constant plate voltage (regardless of the normal power source voltage fluctuations) to the critical circuits. Resistor R80 (ballast tube) provides constant filament voltage.

SERVICE OR OPERATING QUESTIONS - For further information regarding operation or servicing of the receiver, contact your dealer. Make no service shipments to the factory as the Hallicrafters Co. will not accept the responsibility for unauthorized shipments. Factory type service is available at any HALLI-CRAFTERS AUTHORIZED SERVICE CENTER which displays the sign shown at the right. For the location of the SERVICE CENTER nearest you, consult your dealer or telephone directory.



The Hallicrafters Company reserves the privilege of making revisions in current production of equipment and assumes no obligation to incorporate these revisions in earlier models.

SERVICE INSTRUCTIONS

LUBRICATION - Mechanical parts to be lubricated are illustrated in figures 5, 6, and 7. Use a good grade of light lubricating grease and light machine oil. Extreme care should be exercised to prevent grease or oil from splashing on the electrical components, wiring, and turret or switch contacts during lubrication. Frequent oiling of the tuning capacitor bearings will protect the points most subject to wear.

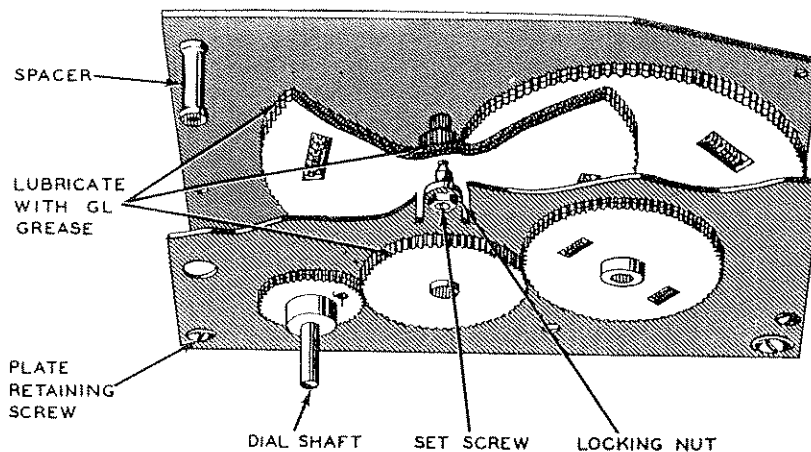

Fig. 5. Lubrication of Dial Drive Mechanism

MECHANICAL ADJUSTMENTS

ADJUSTMENT OF TUNING DIAL CLUTCH - The clutch is located inside the TUNING dial knob. Remove the snap-on cap, using a knife or a thin blade screwdriver. Tighten or loosen the selflocking nut to adjust the spring tension. Do not adjust for too much friction, since this clutch protects the dial-drive mechanism by slipping when the gears jam.

Caution: Undue pressure on the dial-drive shaft might distort the shaft or gears.

SETTING DIAL SCALE WITH TUNING GANG. The dial scale must be set to read the correct frequency as the tuning gang tunes the receiver. Turn the TUNING knob counterclockwise until it hits the stop (reference lines on the dial should be under the pointer). In this position, a space of .062 inch should separate the bar on top of the stator plates and the fiber strip across the rotor plates. If the space is not correct, it should be adjusted as follows:

- (1) Loosen the setscrews on the front section of the tuning gang shaft coupling.
- (2) Place a .062-inch gage between the stator and rotor plate stops, and move the rotor to cause a tight fit for the gage.
- (3) Tighten the coupling setscrews.

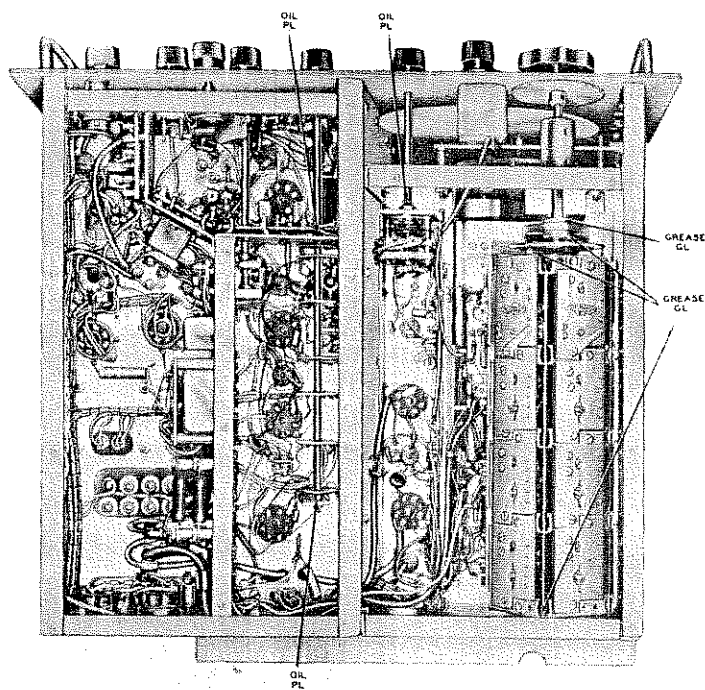

Fig. 6. Lubrication Points, Bottom

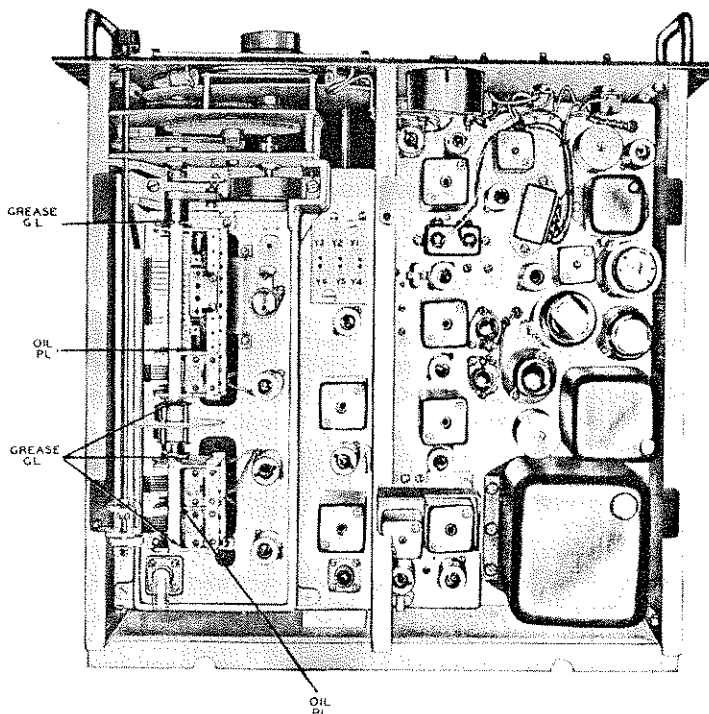

Fig. 7. Lubrication Points, Top

CENTERING OF TURRET CONTACTS - The turret contacts touch the stationary contacts when the turret is stopped in any one of the six positions. The purpose of the detent is to stop the turret contacts in the center area of the fixed contacts. The detent spring may be slid back or forward to achieve this position of the contacts. Loosen the two screws that hold the spring, and, with the detent roller in a notch, turn the turret until the contacts are in perfect alignment, then tighten the screws. If too much or too little turret shaft end-play is encountered, adjust by turning the shaft bushing nut for more or less clearance between the nut and detent plate.

ADJUSTMENTS OF DIAL MASKS

The band number and mask opening should be centered horizontally when the turret is in a detent position. Adjustment may be made in the following manner if the mask is not set correctly.

1. Loosen the two Allen head setscrews on the dial mask drive gear (located on the bottom of the chassis on the front panel end of the turret extension shaft).
2. Place the turret in a detent position.
3. Turn the dial mask drive gear until the dial mask is positioned correctly.
4. Retighten the drive gear setscrews.
5. A small circular plate located directly under the TUNING knob is the positioning guide for the dial mask idler gear. If the mask binds or does not operate smoothly, the idler gear may need adjustment. Slightly loosen the three screws on the circular plate, and move the plate until satisfactory operation is obtained. Retighten the screws to secure the plate in this position.

ALIGNMENT AND ADJUSTMENT PROCEDURES

TEST EQUIPMENT REQUIRED FOR ALIGNMENT

SIGNAL GENERATOR - The signal generator required for alignment must cover a frequency range of from 450 kc to 55 mc, unless more than one generator is used. It should be possible to modulate it 30 percent with an a-f of 400 cps with either an external or internal a-f oscillator. The output must be continuously variable from zero to .5 volt (500,000 uv) with a low impedance connection (50 ohms or less).

OUTPUT METER - A visual indication of the receiver output signal is necessary for alignment. A power output meter provides this indication, and also supplies the proper 600-ohm load across the secondary of audio output transformer T35. Terminals 2 and 4 should be shorted together, and the meter should be connected to terminals 1 and 5. Set the meter to read approximately 50 mw at 1/4 or 1/2 scale. An alternate method of indicating the output is by the use of an a-c reading output meter. For this method, a 600-ohm load resistor must be connected in place of the power output meter. The a-c output meter is connected across the resistor and the 10-volt scale is used. The signal generator should be adjusted to indicate 5 or 6 volts on the meter. This indicates approximately 50 mw output.

HEADSET AND SPEAKER - When alignment of the bfo is made, either a speaker or headset is used to listen to the beat frequencies to determine when a null is approached. The headset may be plugged into the PHONES jack (J-3) provided on the front panel. A speaker can be connected to the AUDIO OUTPUT terminals (E-4) on the rear of the receiver. Short terminals 2 and 4 together and connect the speaker to terminals 1 and 5.

FREQUENCY METER - Very accurate h-f oscillator settings may be made by the use of a frequency meter in conjunction with the signal generator.

ALIGNMENT TOOL - A standard fiber or phenolic alignment tool with a screw-driver end may be used to align most of the circuit adjustments. The top of some of the i-f transformer coils have a larger hollow-screw adjustment. These may be adjusted with a screw driver with a suitable size blade. Use a phenolic rod for the bottom slug adjustment when going through top adjusting screw.

ALIGNMENT PROCEDURES

If the instructions contained in this paragraph are followed, complete alignment of the receiver may be made from the top of the receiver. To accomplish this, the receiver must be removed from its mounting (rack, case, etc.). Remove the top dust cover by sliding it to the rear of the chassis and lifting it off. Refer to figures 8 and 9 for location of the necessary alignment adjustments. Be careful in making these adjustments; damage to the cores of the coils can result if adjustments are forced past their limits. To make some of the adjustments it will be necessary to use a long insulated type screw driver tool. It is recommended that the alignment be made in the order given; otherwise, false readings or unsatisfactory alignment may result. Allow about 15 or 20 minutes for the receiver and test equipment to warm up prior to alignment. In connecting the r-f signal generator to antenna input terminal E1, the output impedance of the signal generator must be known. This is required because it is imperative that the dummy load, including the series resistance of the signal generator, be exactly 100 ohms (example: signal generator impedance 50 ohms, plus dummy antenna 50 ohms, equal 100 ohms). A very low output impedance of the signal generator, about .75 to 1 ohm, is

best suited for alignment of this receiver. Always begin by feeding a signal into the receiver using a small signal to start with and then increasing it after an indication is seen on the output meter. This will prevent either overloading the receiver or damage to the output meter. As the adjustments are peaked, sufficient output may be obtained to move the meter needle off scale. Reduce the output from the signal generator or damage to the meter may result. Normally, a center-scale reading on the meter is preferred for a reference setting. Since the receiver is very sensitive, any electrical interference in the immediate vicinity may cause erratic signal indication when alignment is being made. If this is the case, alignment should be made in a well-shielded grounded room, such as a standard screen room used for radio testing purposes. The construction of the i-f transformers is such that both the top and bottom tuning slugs may be adjusted from the top of the shield can. The top slug adjustments require a wide-blade screw driver. The bottom requires a phenolic rod which is narrow enough to fit through the hole in the top adjustment. The bottom adjustment is the primary on all the transformers, while the secondary is the top adjustment.

Set the front panel controls to the following positions before attempting to align the receiver.

- (1) SELECTIVITY (S1) NORMAL SHARP.
- (2) RECEIVE-SEND (S6) RECEIVE.
- (3) CW-MODULATION (S5) MODULATION.
- (4) AGC-MANUAL (S4) MANUAL.
- (5) ANL-OFF (S3) OFF.
- (6) BAND SELECTOR BAND I.
- (7) VFO-CRYSTAL (S2) VFO.
- (8) AUDIO GAIN (R94) Approximately half clockwise rotation.
- (9) CRYSTAL PHASING (C161) 0.
- (10) BFO PITCH (C183) 0.
- (11) TUNING (C1 and C2) Lowest frequency indicated on tuning dial.
- (12) RF GAIN-AC (R83, S7) Full clockwise rotation.
- (13) ANT ADJ. As required.

NOTE - Any changes in the above settings will be given in the particular procedure requiring those changes.

IF ALIGNMENT PROCEDURE

The alignment is made with the signal generator connected at the first mixer grid. The adjustments are tuned, starting from the second detector and working toward the 2d mixer.

CAUTION: The 455-kc i-f stage alignment is necessary before any other alignment is attempted. If this alignment is not performed correctly, all the alignment thereafter will be in error, and the receiver will have to be completely re-aligned before calibration and operation will be correct.

TABLE 2

455-KC I-F ALIGNMENT CHART

Band selector is set to	Signal generator frequency	Dummy load	Connect signal generator to	Adjust for maximum (in given order)
BAND I	455 kc (400 cps, modulation 30%)	600-ohm load across terminals 1 and 5 of E4. Also connect 2 and 4 together.	Stator C2A mixer grid circuit V 3 (top of chassis.)	L56, L55, L53, L52, L50, L49, L47, and L46.

I-F OUTPUT ALIGNMENT - After the 455-kc i-f alignment is complete, the 455-kc i-f output should be aligned. Connect a 72-ohm coaxial cable with a connector to jack J2. Place a 72-ohm terminating resistor across the open end of the cable. Connect a sensitive a-c type vtvm (vacuum-tube voltmeter) across the resistor. Apply a 455-kc signal as for the 455-kc i-f alignment; do not use modulation. Set the signal generator to give a reading on the meter of from .1 to .2 volt. Tune L57 for a maximum reading on the meter. Do not allow the output to go above .25 volt, since this may overload the i-f system, thereby making the adjustment of L57 sluggish and inaccurate. An alternate method of correctly aligning the i-f output without the use of a sensitive a-c vtvm is accomplished as follows:

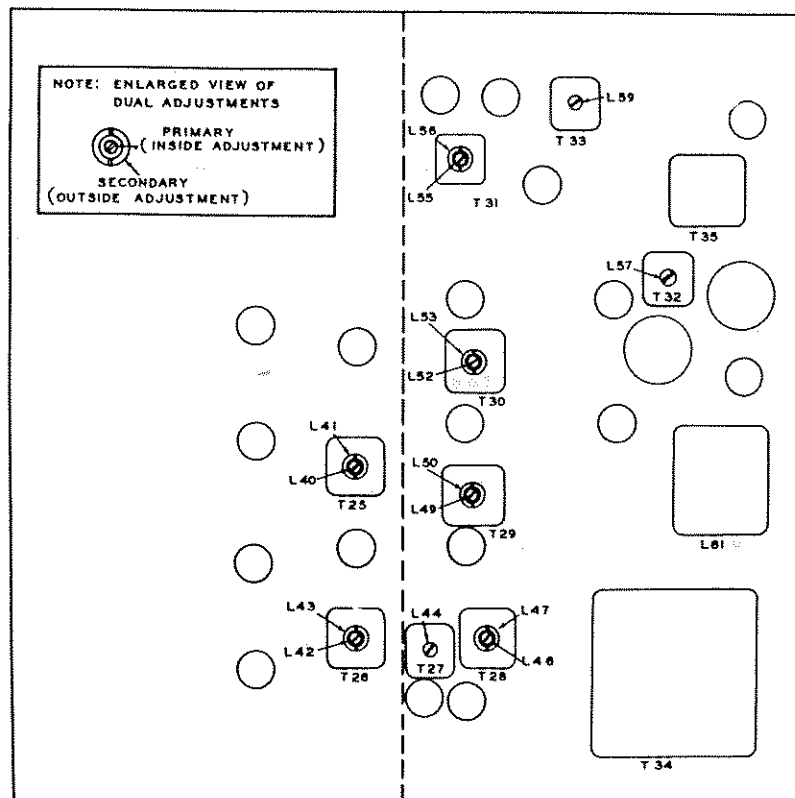

Fig. 8. IF Alignment Diagram

- (1) Place the AGC MANUAL switch to the AGC position.
- (2) Apply a strong 455-kc signal (approximately 10,000 uv) to the 1st mixer grid.
- (3) Adjust L57 for a maximum indication on the CARRIER LEVEL meter.

BFO ALIGNMENT

- (1) Connect a speaker or headset to the receiver.
- (2) Change CW MODULATION switch, S5, to the CW position.
- (3) Set BFO PITCH control, C183, to 0.
- (4) Apply a 455-kc signal as for the 455-kc i-f alignment.
- (5) If an audio note is heard, tune L59 until a zero beat is obtained.
- (6) Check the bfo by turning BFO PITCH control, C183, in either direction. An audio note which changes frequency with rotation should be heard each side of the zero mark if the bfo is correctly aligned.
- (7) Turn the BFO INJ. control, R82, located on the rear of the chassis to its normal setting.

ADJUSTMENT OF I-F BANDWIDTH IN CRYSTAL POSITION. - Ordinarily, it should not be necessary to adjust the bandwidth of the 455-kc i-f stages. However, if adjustment is necessary, care must be taken because it is a very tedious operation. The adjustment consists of setting three capacitors (C162, C163, and C164) which are used when the SELECTIVITY switch is in one of the CRYSTAL positions. The correct procedure is as follows:

- (1) Set the ANL-OFF switch to ANL.
- (2) Connect a d-c vtvm from either terminal on the ANL-OFF switch to ground (on top of chassis).
- (3) Apply a 455-kc unmodulated signal as for i-f alignment. Adjust the amplitude to about -10 volts on the vtvm.
- (4) Adjust signal generator frequency to give 5 volts on each side of maximum, and note difference frequency on signal generator. (The signal generator must have a vernier, or a frequency meter must be used to select these points.)
- (5) Adjust the proper capacitor and note bandwidth. Repeat until the 6-dbm (decibel per meter) down bandwidth is as follows:

CRYSTAL SHARP (C162) - between 170 and 230 cps. CRYSTAL MED (C163) - between 425 and 575 cps. CRYSTAL BROAD (C164) - between 1,200 and 1,500 cps.

6-MC I-F ALIGNMENT. Place the BAND SELECTOR switch in the BAND IV position. The 6.455-mc oscillator, V8, must be oscillating before the 6-mc i-f alignment can be made. To check this, place a d-c vtvm from ground (chassis) to the junction of R106 and C211 (feed through capacitor). Approximately minus 1 volt should be read on the meter when the stage is oscillating. If no voltage is present, T27 should be tuned. Unscrew the core until the circuit falls out of oscillation (approximately 1/8 inch out of can). Now screw the core in until the circuit just starts oscillating again, then turn in another one-quarter turn from this position to insure stable oscillation.

6-MC ALIGNMENT CHART. In making the 6-mc alignment, you should first determine whether the 455-kc i-f stages are functioning properly. If they do not appear to be operating properly, realign them according to the instructions in the preceding paragraph. Make sure that the BAND SELECTOR is set to BAND IV, which is the lowest double-superheterodyne band. Tune C140 first, since this is a coaxial cable compensator. Then work from the output end of the 6-mc stages toward the 1st mixer.

TABLE 3

BAND SELECTOR is set to	Signal generator frequency	Dummy load	Connect signal generator to	Adjust for maximum (in given order)
BAND IV (TUNING switch set to low end of band).	6 mc	600-ohm load across terminals 1 and 5 of E4 with 2 and 4 shorted.	Stator C2A mixer grid circuit V3.	C140, L43, L42, L41, and L40.

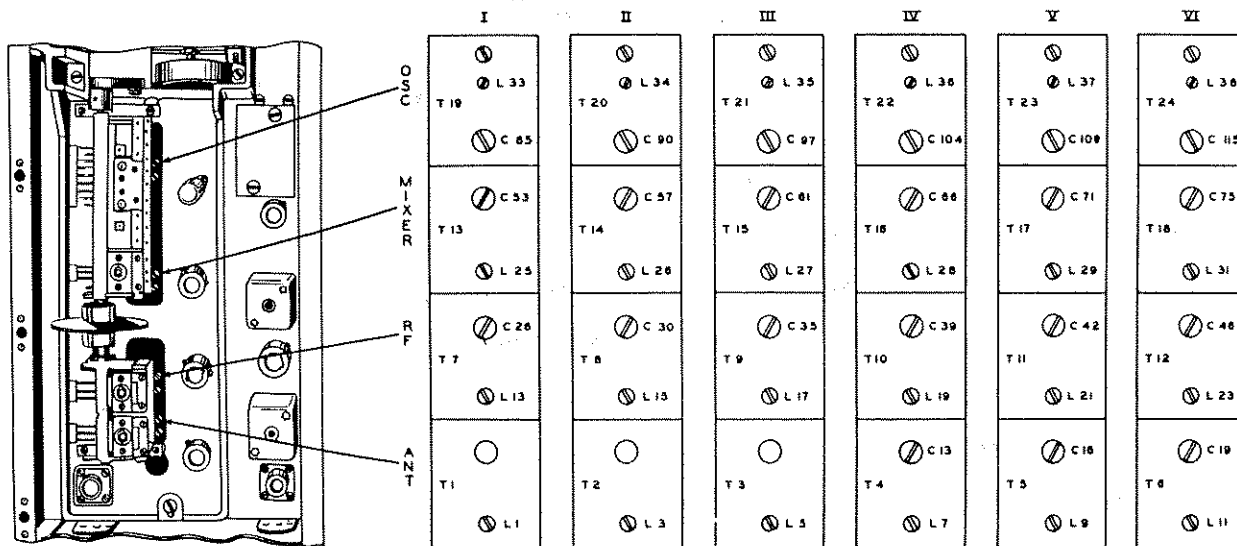

Fig. 9. RF Alignment Diagram

R-F ALIGNMENT

Connect one terminal A of E1 antenna terminal strip to ground. Connect the signal generator through a 100-ohm dummy antenna from ground to the other terminal A of E1. It may be necessary to repeat the alignment adjustments several times.

NOTE. The 100-ohm dummy antenna should include the generator impedance.

R-F TURRET ALIGNMENT CHART

Figure 9 shows the location and layout view of the turret r-f adjustments. In making the r-f alignment, the signal generator and the receiver TUNING dial are set to the desired frequency as indicated in the alignment chart. First, tune the oscillator i-f (low frequency) adjustment which is a core in the coil. After the adjustment is peaked, continue down the turret (this is down each column on the chart) and adjust all the i-f adjustments in order from the mixer to the antenna. After the i-f end of each band is tuned, the dial and signal generator should be set to the high end of the band and the correct adjustments peaked at that end. It may be necessary to go back to the low end and readjust to the high end of the band, and readjust several times before the alignment at either end will not affect the alignment at the opposite end of any band. The h-f ends of BANDS I, II, and III do not have trimmers therefore, in order to get a maximum indication for a peak, the ANT ADJ control on the front panel must be tuned. Do not disturb any other adjustments on the turret; these are factory-set trimmers and padders to compensate for production tolerances.

TABLE 4

	End of band						
BAND Number		I	II	III	IV	V	VI
Tuning frequency	Low	570 kc	1.35 mc	3.20 mc	7.30 mc	14.5 mc	29.0 mc
	High	1.24 mc	2.9 mc	6.80 mc	13.3 mc	28.0 mc	54.0 mc
Signal generator frequency	Low	570 kc	1.35 mc	3.2 mc	7.3 mc	14.5 mc	29. mc
	High	1.24 mc	2.9 mc	6.8 mc	13.3 mc	28. mc	54. mc
Oscillator adjustments to be peaked	Low	L33	L34	L35	L36	L37	L38
	High	C85	C91	C97	C104	C109	C115
1st mixer adjustments to be peaked	Low	L25	L26	L27	L28	L29	L31
	High	C53	C57	C61	C66	C71	C75
R-f adjustments to be peaked	Low	L13	L15	L17	L19	L21	L23
	High	C26	C30	C35	C39	C42	C46
Antenna adjustments to be peaked	Low	L1	L3	L5	L7	L9	L11
	High	none	none	none	C13	C16	C19

NOTE - Oscillator adjustments are peaked above the signal frequency. The second harmonic of the hfo (high-frequency oscillator) is used on BAND VI.

CARRIER LEVEL METER ADJUSTMENT

CARRIER LEVEL meter M1 must be adjusted under certain conditions to allow a fairly accurate reading to be obtained as far as measurement of receiver signal strength is concerned. These are the conditions under which the meter adjustment should be checked:

With the set turned off, the meter needle should be at rest on the last dial scale marking on the left end of the scale. A mechanical adjusting screw is provided on the front of the meter to make this condition possible.

With the set on and the AGC-MANUAL switch in the AGC position, the RF GAIN-AC control at maximum, the SELECTIVITY switch at the NORMAL MED position, and the receiver tuned to a 50-uv signal (signal generator output injected through 100-ohm resistance at antenna terminals), the needle should indicate 0 db on the meter scale. The METER ZERO control (R87) on the rear of the chassis is used to adjust the meter reading for this condition. The above adjustment should be made on BAND III, 5.0 mc.

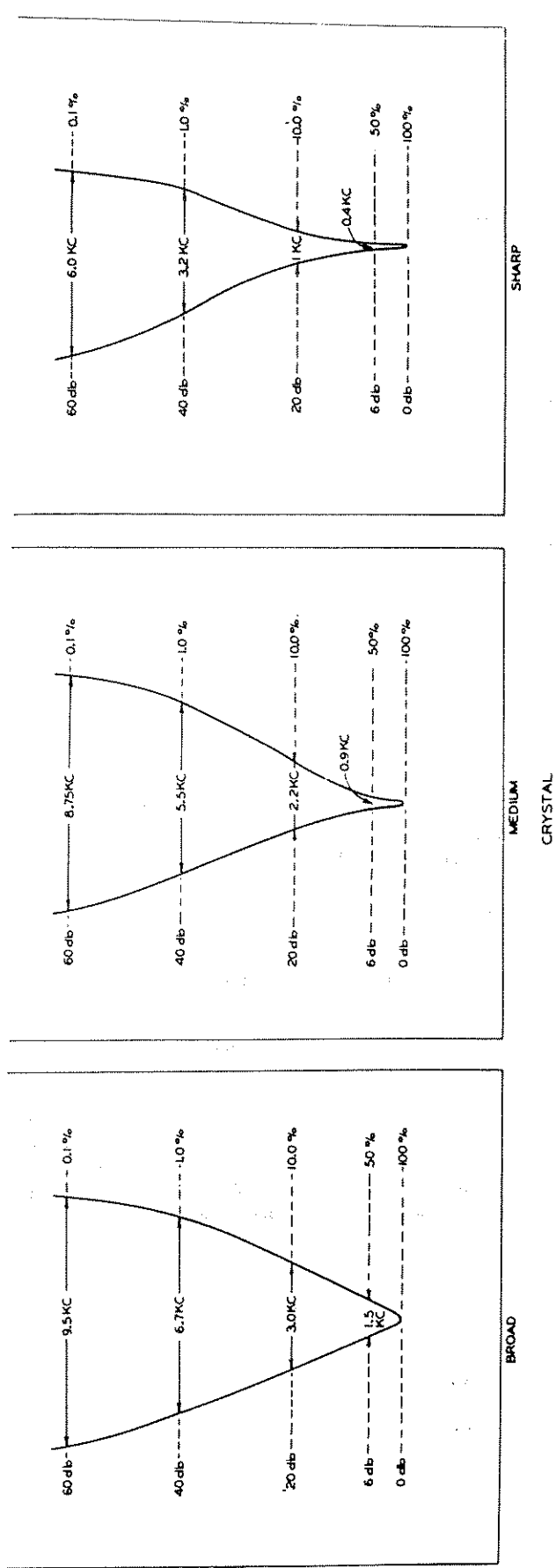
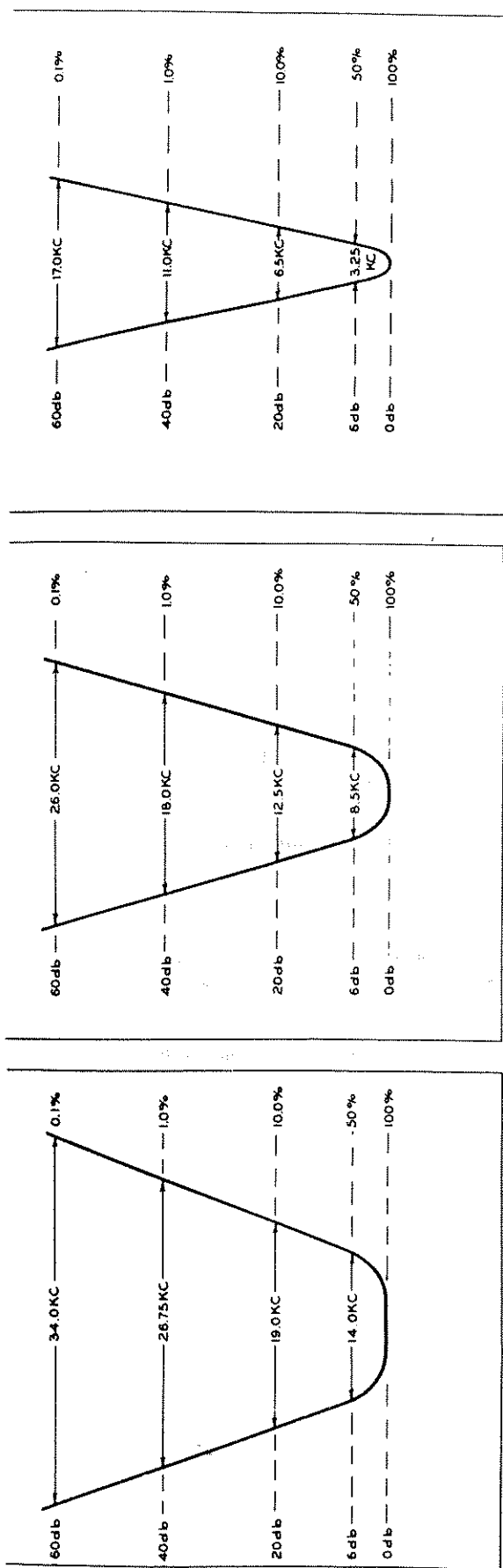

Fig. 10. Selectivity Curves for Different Positions of the Selectivity Control

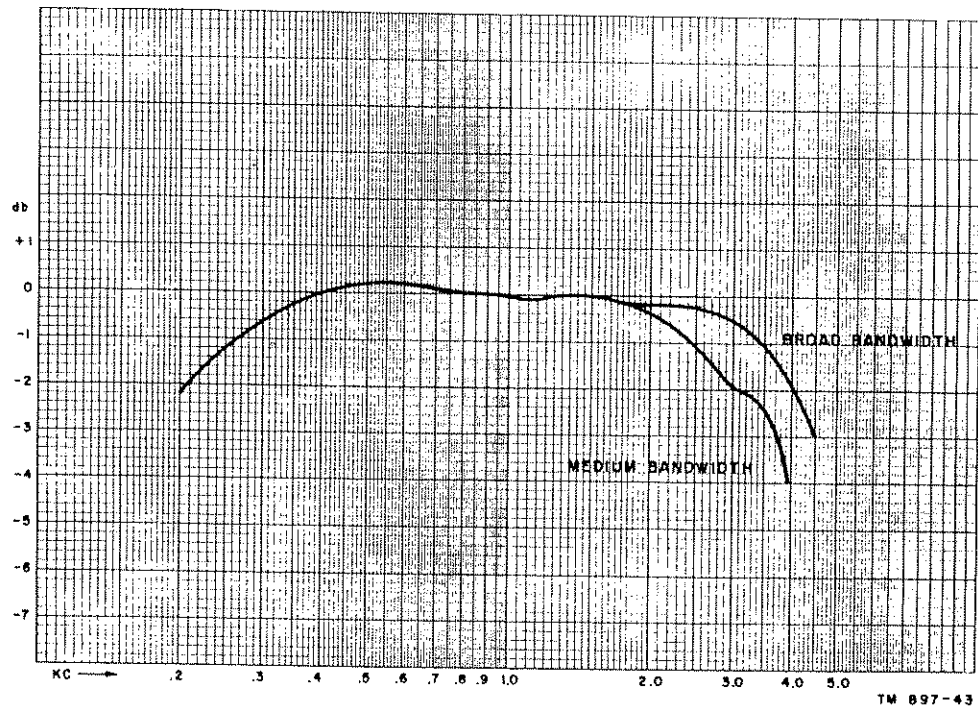

Fig. 11. Typical AF Response Curve

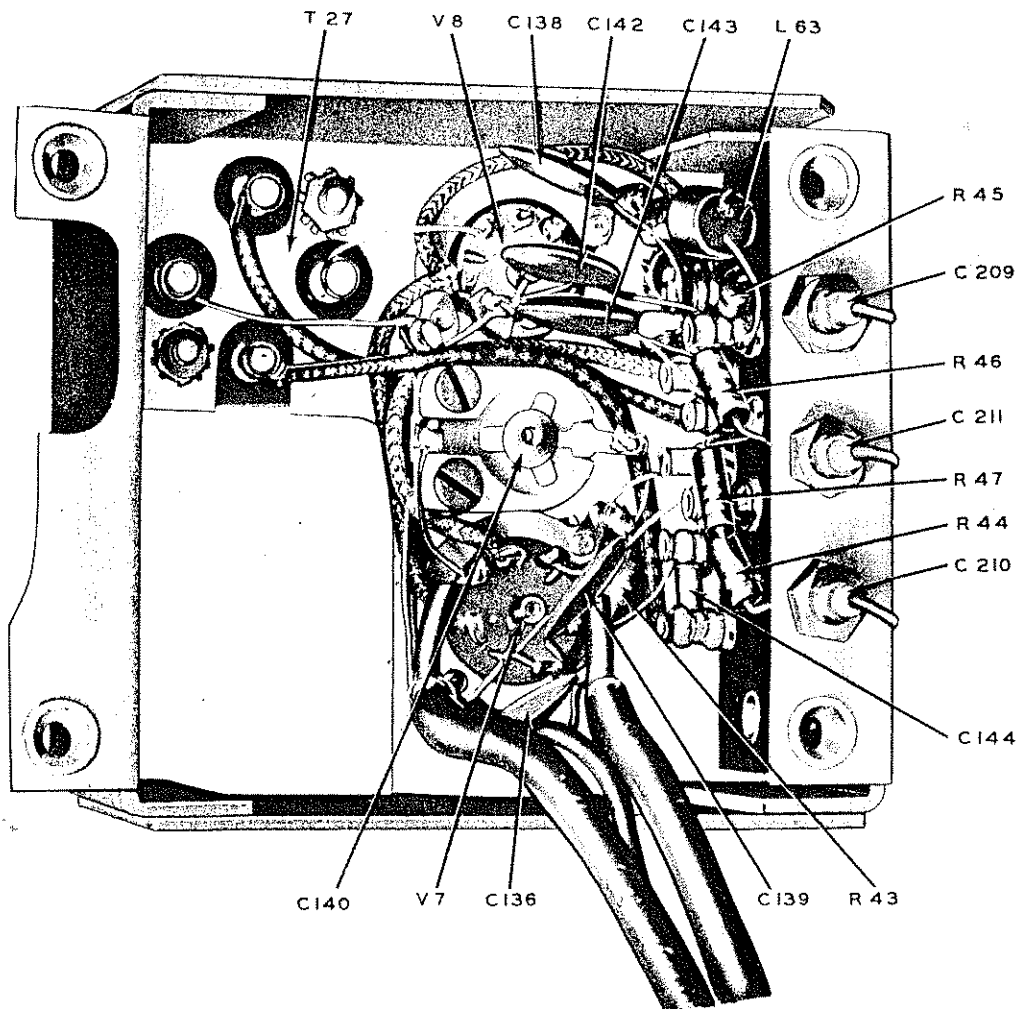

Fig. 12. Second Mixer and 6.455 mc Oscillator Chassis, Bottom View

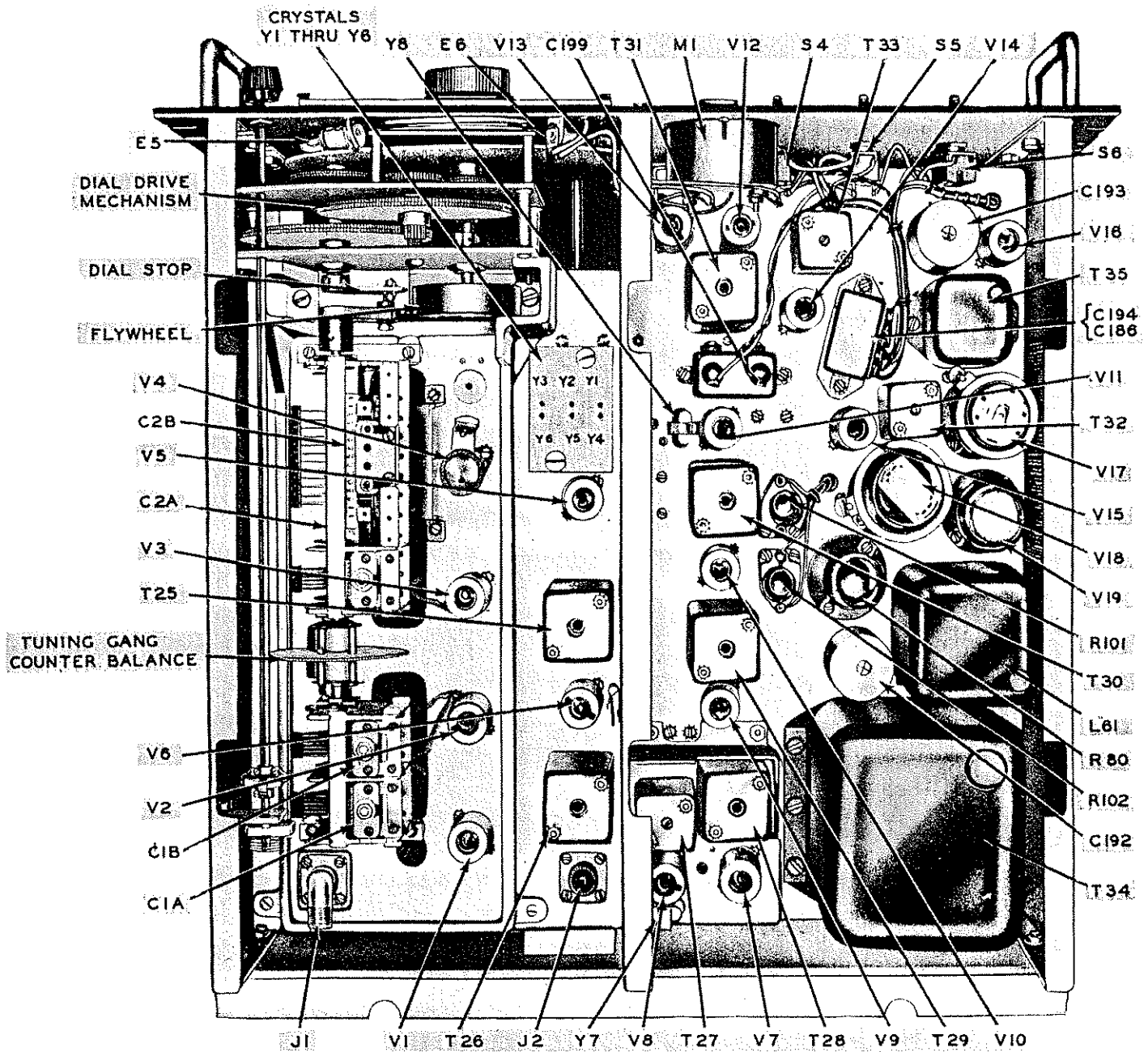

Fig. 13. Receiver Chassis, Top View

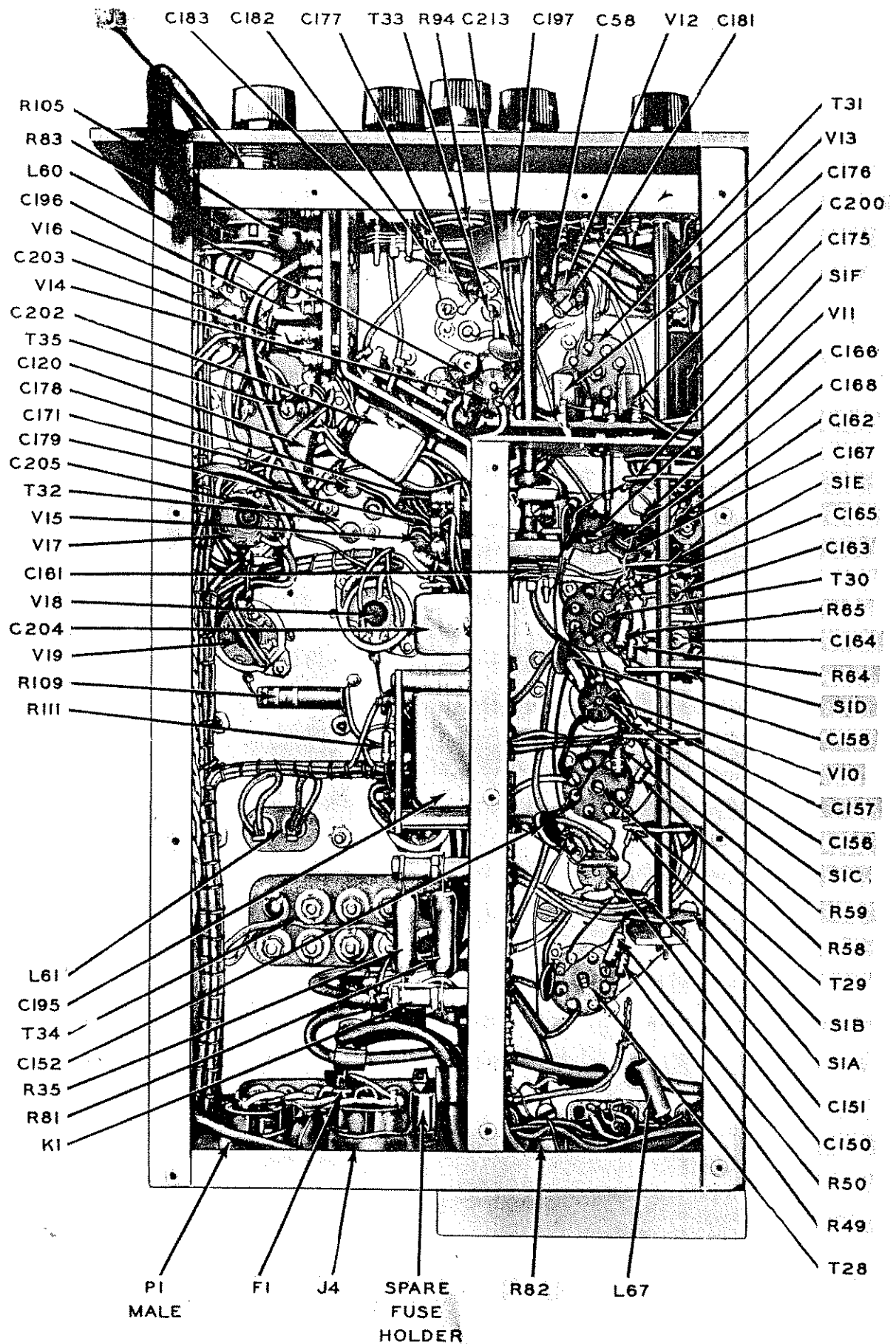

Fig. 14. IF and Audio Chassis, Bottom View

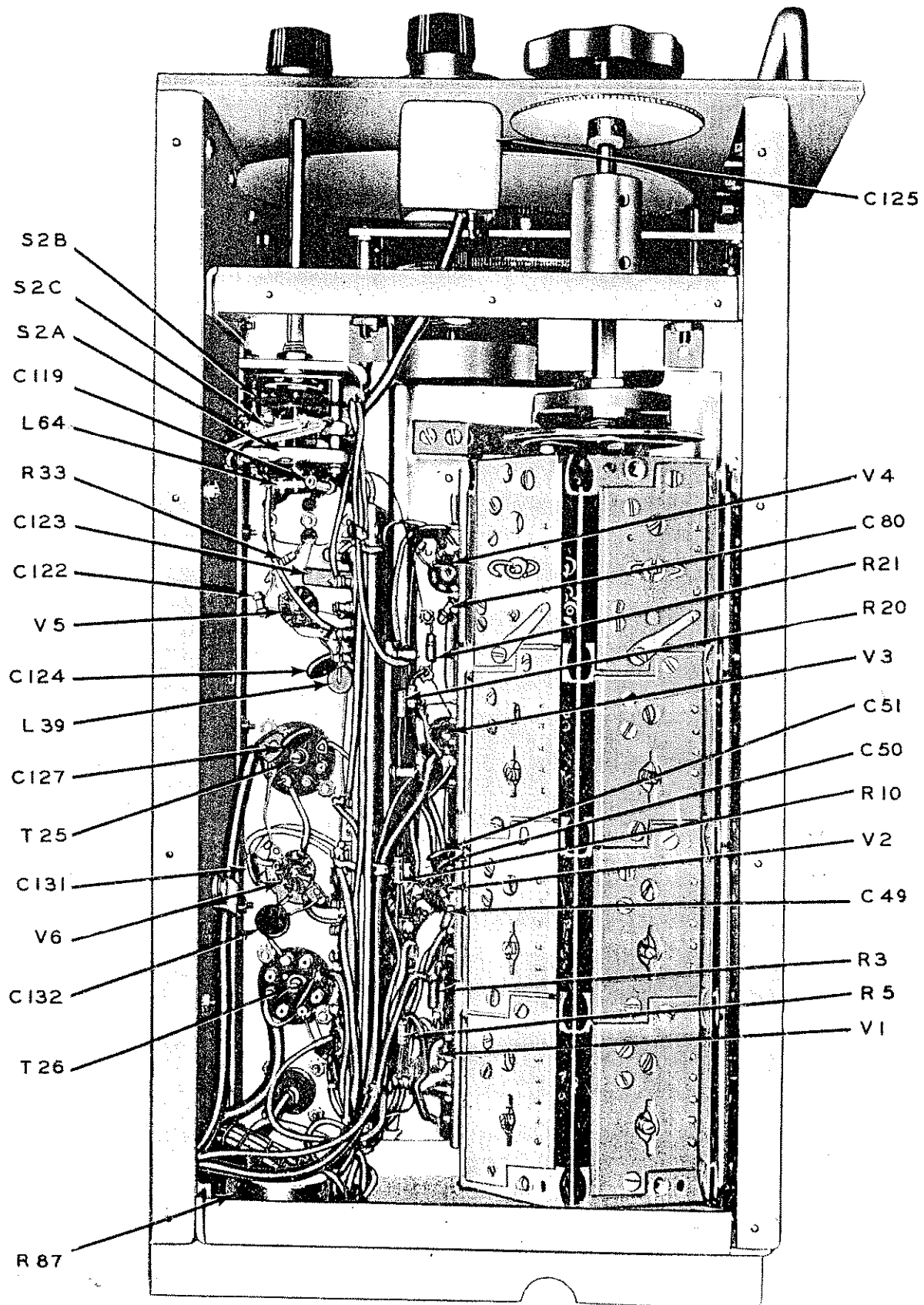

Fig. 15. RF Chassis, Bottom View

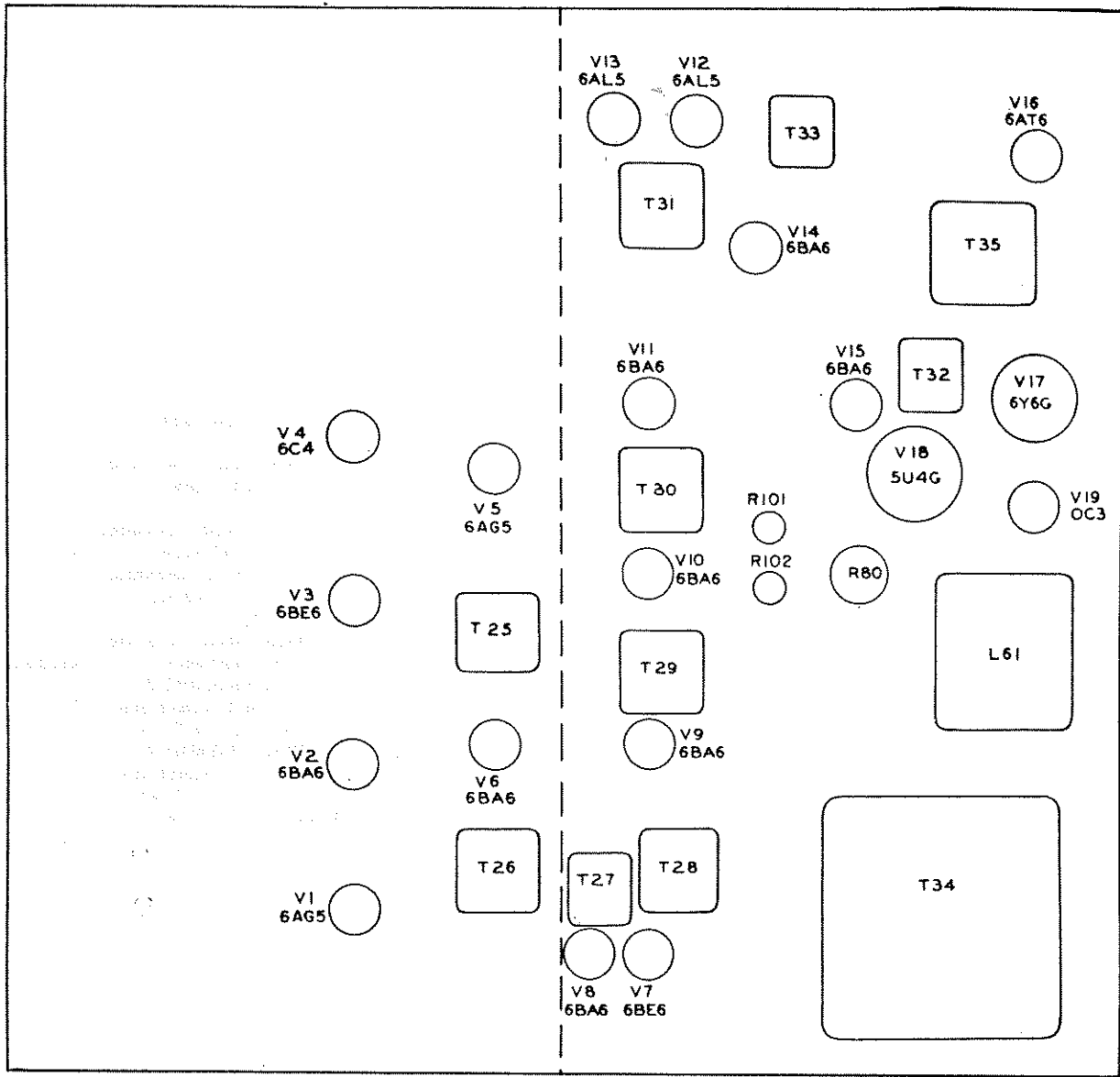

Fig. 16. Tube Location

SERVICE PARTS LIST

Schematic Symbol	Description	Hallicrafters Part Number	Schematic Symbol	Description	Hallicrafters Part Number
O-13	BEARING, roller; for detent	77B388	C-91,98	CAPACITOR, fixed: ceramic; 10 uuf ±5%; 500 vdcw; part of T-20 and 21	-----
O-14,26	BEARING, sleeve; for phase capacitor and antenna adjustment shafts	77B414	C-3,9,12,41,70	CAPACITOR, fixed: ceramic; 15 uuf ±10%; 500 vdcw; part of T-1,3,4,11 and 17 respectively	-----
O-15,16	BEARING, sleeve; for SELECTION switch and VFO CRYSTAL switch shafts	72A002	C-86	CAPACITOR, fixed: ceramic; 18 uuf ± 5%; 500 vdcw; part of T-19	-----
O-17	BEARING, sleeve; front bearing for BAND SELECTOR turret shaft	77B338	C-6	CAPACITOR, fixed: ceramic; 18 uuf ±10%; 500 vdcw; part of T-2	-----
O-18	BEARING, sleeve; for dial mask idler gear	77A344	C-81,87,93,99	CAPACITOR, fixed: ceramic; 22 uuf ± 5%; 500 vdcw; part of T-19,20,21 and 22 respectively	-----
O-19	BEARING, sleeve; rear bearing for BAND SELECTOR turret shaft	77B350	C-38,65	CAPACITOR, fixed: ceramic 22 uuf ±10%; 500 vdcw; part of T-10 and 16	-----
E-1	BOARD, terminal; antenna and ground binding post	88B724	C-141	CAPACITOR, fixed: ceramic; 27 uuf ±10%; 500 vdcw;	47J20UJ270K
E-2,3	BOARD, terminal; SEND/REC and AUDIO IN	88B418	C-18	CAPACITOR, fixed: ceramic; 27 uuf ±10%; 500 vdcw; part of T-6	-----
E-4	BOARD, terminal; AUDIO OUTPUT	88B417	C-100	CAPACITOR, fixed: ceramic; 33 uuf ±5%; 500 vdcw; part of T-22	-----
E-7	BOARD, terminal; 6 term; resistor mounting (455 kc output)	88B640	C-21,49,80,144,171	CAPACITOR, fixed: ceramic; 33 uuf ±10%; 500 vdcw	47J20UJ330K
E-8	BOARD, terminal; 10 term; resistor and choke mounting (BFO)	88B644	C-40	CAPACITOR, fixed: ceramic; 33 uuf ±10%; 500 vdcw; part of T-10	-----
E-9	BOARD, terminal; 11 term; resistor, choke, and capacitor mounting (6455 kc crystal oscillator)	88B674	C-189	CAPACITOR, fixed: ceramic; 39 uuf ±10%; 500 vdcw	47J20UJ390K
E-10	BOARD, terminal; 12 term; resistor and capacitor mounting (automatic noise limiter)	88B647	C-103	CAPACITOR ASSEMBLY: ceramic; c/o 2 capacitors in parallel; part of T-22	-----
E-11	BOARD, terminal; 12 term; resistor and capacitor mounting (2nd detector)	88B646	C-110	CAPACITOR ASSEMBLY: ceramic; c/o 2 capacitors in parallel; part of T-23	-----
E-12	BOARD, terminal; 14 term; resistor and capacitor mounting (1st audio)	88B643	C-177	CAPACITOR fixed: ceramic; 47 uuf ±5%; 500 vdcw	47J20UJ470J
E-13	BOARD, terminal; 14 term; resistor mounting (RF and oscillator chassis)	88B642	C-54,74	CAPACITOR, fixed: ceramic; 47 uuf ±10%; 500 vdcw; part of T-17 and T-18	-----
E-14	BOARD, terminal; 30 term; resistor, choke, and capacitor mounting (6 mc IF)	88B641	C-45	CAPACITOR, fixed: ceramic; 56 uuf ±10%; 500 vdcw; part of T-12	-----
E-15	BOARD, terminal; 38 term; resistor mounting (455 kc IF chassis)	88B645	C-82,105,111	CAPACITOR, fixed: ceramic; 47 uuf ±5%; 500 vdcw; part of T-19, 23 and 24 respectively	-----
W-1	CABLE ASSEMBLY, power input	87B1758	C-122	CAPACITOR, fixed: ceramic; 56 uuf ±10%; 500 vdcw	47J25UJ560K
C-32,36,43,47,67,76	CAPACITOR, fixed: ceramic 2.2 uuf ±20%; 500 vdcw; part of T-8,9,11,12,16 and 18 respectively	-----	C-116	CAPACITOR ASSEMBLY: ceramic; c/o 2 capacitors in parallel; part of T-24	-----
C-72	CAPACITOR, fixed: ceramic; 12 uuf ±10%; 500 vdcw; part of T-5	-----	C-68,69	CAPACITOR, fixed: ceramic, part of T-16	-----
C-28,55,59,63	CAPACITOR, fixed: ceramic; 3.3 uuf ±20%; 500 vdcw; part of T-7,13,14, and 15 respectively	-----	C-4	CAPACITOR, fixed: ceramic, 100 uuf ±10%; 500 vdcw	47J25UJ101K
C-34,48,62	CAPACITOR, fixed; ceramic; 5 uuf ±1 uuf; 500 vdcw; part of T-9,12 and 15 respectively	-----	C-106	CAPACITOR, fixed: ceramic; 100 uuf ±5%; 500 vdcw; part of T-23	-----
C-181	CAPACITOR, fixed: ceramic; 5 uuf	47J20UJ050D	C-64	CAPACITOR, fixed: ceramic; 100 uuf ±10%; 500 vdcw; part of T-15	-----
C-166	CAPACITOR, fixed: ceramic; 6 uuf ±5 uuf; 500 vdcw	47J20UJ060D	C-89	CAPACITOR, fixed: ceramic; 120 uuf ±5%; 500 vdcw; part of T-20	-----
C-165	CAPACITOR, fixed; ceramic; 10 uuf ±5 uuf; 500 vdcw	47J20UJ100F	C-33,37,60	CAPACITOR, fixed: ceramic; part of T-8,9,and 14 respectively	-----
C-44,73	CAPACITOR, fixed: ceramic; 10 uuf ±.5 uuf; 500 vdcw; part of T-11 and 17	-----			

SERVICE PARTS LIST (Cont.)

Schematic Symbol	Hallicrafters Part Number	Description	Part Number
C-96		CAPACITOR, fixed: ceramic; 270 uuf ±5%; 500 vdcw; part of T-21	
C-119		CAPACITOR, fixed: ceramic; 390 uuf ±10%; 500 vdcw	47J35UJ391K
C-209,210,211		CAPACITOR, fixed: ceramic; 2300 uuf -20%; +50%; 500 vdcw	47A228
C-112		CAPACITOR ASSEMBLY: c/o one 350 uuf capacitor ±5% tolerance, 500 vdc. temperature coefficient N5200, and one 1670 uuf silver mica capacitor, ±2% tolerance, 500 vdc, connected in parallel; part of T-24	
C-56		CAPACITOR, fixed: ceramic; 220 uuf ±5%; 500 vdcw; part of T-13	
C-23,24,25,50,51,52,58,78,79,118,124,117,127,131,132,136,138,139,142,143,146,150,151,152,156,157,158,167,168,174,178,179,187,188,205,206,212,213		CAPACITOR, fixed: ceramic; 10,000 uuf +80% -20%; 450 vdcw	47A217
C-182		CAPACITOR, fixed: mica; 180 uuf ±5%; 500 vdcw	47J20E181J
C-84		CAPACITOR, fixed: mica; 220 uuf ±2%; 500 vdcw; part of T-19	
C-102		CAPACITOR, fixed: mica; 270 uuf ±2%; 500 vdcw; part of T-22	
C-108		CAPACITOR, fixed: mica; 390 uuf ±5%; 500 vdcw; part of T-23	
C-88		CAPACITOR, fixed: mica; 560 uuf ±2%; 500 vdcw; part of T-20	
C-29		CAPACITOR, fixed: mica; 820 uuf ±10%; 500 vdcw; part of T-7	
C-94		CAPACITOR, fixed: mica; 1200 uuf ±5%; 500 vdcw; part of T-21	
C-123,196		CAPACITOR, fixed: mica; 2200 uuf ±10%; 500 vdcw	47J30B222K
C-120		CAPACITOR, fixed: mica; 3300 uuf ±10%; 500 vdcw	47J30B332K
C-176,190,191,200,201,203		CAPACITOR, fixed: molded paper; 10,000 uuf ±20% 600 vdcw	46J35A103M
C-197		CAPACITOR, fixed: molded paper; 50,000 uuf ±10%; 300 vdcw	46J42A503K
C-175		CAPACITOR, fixed: paper; 100,000 uuf ±20%; 600 vdcw	46J43E104M
C-186A,186B,194A,194B		CAPACITOR, fixed: paper; 2 sect; 100,000 uuf ±15% ea sect; 600 vdcw	46J53B4DF104L
C-202		CAPACITOR, fixed: paper; 500,000 uuf ±10%; 600 vdcw	46J53B1FF504K
C-198,199		CAPACITOR, fixed: paper; 1 uuf +20% -10%; 600 vdcw	46J53B1FB105V
C-204		CAPACITOR, fixed: electrolytic; 25 uf; 25 vdcw	45J63C250F
C-192A,192B,193A,193B		CAPACITOR, fixed: electrolytic; 2 sect; 40 uf ea sect; 350 vdcw	45J42C400P
C-195		CAPACITOR, fixed: electrolytic; 50 uf; 50 vdcw	45J63A500G
C-8,11,14,17		CAPACITOR, variable; ceramic; 1.5 to 9.0 uuf; Sickles FW	44B400
C-85,92,97,104,109,115		CAPACITOR, variable: air; 2.15 to 14.58 uuf; part of T-19,20,21,22,23 and 24 respectively	
C-26,30,35,53,57,61		CAPACITOR, variable: ceramic; 2.5 uuf to 13 uuf part of T-7,8,9,13,14 and 15 respectively	
C-13,16		CAPACITOR, variable: ceramic; 4.0 uuf to 25 uuf; part of T-4 and 5	
C-140,162,163,164		CAPACITOR, variable: ceramic; 7.0 to 45 uuf	44J11D450
C-19,39,42,46,66,71,75,83,90,95,101,107		CAPACITOR, variable: ceramic; 7.0 to 45 uuf; part of T-6,10,11,12,16,17,18,19,20,21,22 and 23 respectively	
C-161		CAPACITOR, variable: air dielectric; 3.5 uuf to 25 uuf; 500 v 60 cyc RMS test	48B233
C-22		CAPACITOR, variable: air dielectric; 3.5 uuf to 25 uuf	48B256
C-125		CAPACITOR, variable; air dielectric; 6.3 uuf to 100 uuf; 500 v 60 cyc RMS test	48B245
C-183		CAPACITOR, variable; air dielectric; 3.5 uuf to 25 uuf; 500 v 60 cyc test	48B234
C-1A-B		CAPACITOR, variable; air dielectric; 2 sect; 10 to 218 uuf	48D235
C-2A,2B		CAPACITOR, variable; air dielectric; mixer section 10 to 218 uuf, osc section 15 to 223 uuf	48D236
H-1,42,43		CLAMP, cable; 15/16 in. lg x 1/2 in. wd x 7/16 in. h o/a	76A533
H-2,3,4,5,44		CLAMP, cable; 13/16 in. lg x 1/2 in wd x 11/32 in. h o/a	76A626
H-8,9,10,11,45		CLAMP, cable; 3/4 in. lg x 1/2 in wd x 17/64 in. h o/a	76-627
H-35,37		CLAMP, tube; for V-4 and V-17	76B681
H-36		CLAMP, tube; for V-18	76-680
O-11,12		CLIP for Allen head set screw wrench	76A163
L-39		COIL, RF: choke; crystal oscillator plate impedance	53-213
L-60		COIL, RF: choke; BFO plate impedance	53A033
L-63,67		COIL, RF: choke; filament choke for tubes V-7 and V-8	53B009
L-64,65		COIL, RF: choke; crystal oscillator plate impedance	53-214
O-20,21		COLLAR, spacing: capacitor mounting spacer	73A562
J-1		CONNECTOR, receptacle; antenna input	10A132
J-2		CONNECTOR, receptacle; 455 kc IF output	10A056
P-1		CONNECTOR, receptacle; a-c power input	10A047
P-2		CONNECTOR, male contact; antenna input	10A092
P-3		CONNECTOR, plug; male plug part of power input cable, W-1	
J-4		CONNECTOR, receptacle; a-c convenience outlet	10A361

SERVICE PARTS LIST (Cont.)

Schematic Symbol	Description	Hallicrafters Part Number	Schematic Symbol	Description	Hallicrafters Part Number
J-9	CONNECTOR, receptacle; female connector part of power input cable, W-1	-----	H-38	POINTER, indicator; main frequency	76B684
E-16	CONTACT ASSEMBLY, turret coil; antenna section; 5 contacts	88B652	L-61	REACTOR, filter choke	56C112
E-17,18,19	CONTACT ASSEMBLY, turret coil; oscillator, mixer and RF sections; 4 contacts	88B683	K-1	RELAY; armature type	21B105
E-20	CONTACT ASSEMBLY, turret coil; antenna section; 2 contacts	88B681	R-49,58,64	RESISTOR, fixed: comp; 3.3 ohm \pm 10%; 1/2 w	23X20BF033K
E-21,22	CONTACT ASSEMBLY, turret coil; mixer and RF sections; 3 contacts	88B682	R-105	RESISTOR, fixed: WW; 3.5 ohm \pm 10%; 2 w	24J55G3R5
E-23	CONTACT ASSEMBLY, turret coil; oscillator section; 2 contacts	88B680	R-50,59,65	RESISTOR, fixed: comp; 8.2 ohm \pm 10%; 1/2 w	23X20BF082K
O-34	COUPLING, rigid; band selector shaft	29B151	R-109	RESISTOR, fixed: comp. 39 ohm, \pm 10%; 2 w	23J40BF390K
O-35,36	COUPLING, flexible; for antenna adjustment and crystal phasing shafts	29B146	R-4,10,39,61	RESISTOR, fixed: comp; 68 ohms \pm 10%; 1/2 w	23J20BF680K
Y-7	CRYSTAL UNIT, 6455 kc	19-1247	R-115	RESISTOR, fixed: comp; 100 ohm \pm 10%; 1/2 w; part of T-1	-----
Y-8	CRYSTAL UNIT, 455 kc	19-1248	R-18,21,43,67,74	RESISTOR, fixed: comp; 150 ohm \pm 10%; 1/2 w	23J20BF151K
O-22	DRIVE, dial; main and vernier dial	71D188	R-99	RESISTOR, fixed: comp; 220 ohm \pm 10%; 1/2 w	23J40BE221K
F-1	FUSE, cartridge; 2 amp 250 volt	39A307	R-35	RESISTOR, fixed: WW; 280 ohm \pm 10%; 15 w	24J20G281
E-24,25	FUSEHOLDER, extractor post type	6A374	R-81	RESISTOR, fixed: WW; 400 ohm \pm 10%; 4 w	24J20G401
	GEAR, spur type; dial mask mounting gear	26B081	R-1,8,17,28	RESISTOR, fixed: comp; 470 ohm \pm 10%; 1/2 w	23J20BF471K
	GEAR, spur type; dial mask drive gear	26B082	R-55	RESISTOR, fixed: comp; 560 ohm \pm 10%; 1/2 w	23J20BF561K
	GEAR, spur type; idler gear for driving dial mask	26B083	R-52	RESISTOR, fixed: comp; 680 ohm \pm 10%; 1/2 w	23J20BF681K
H-15,16	HANDLE, carrying	30A192	R-34,53	RESISTOR, fixed: comp; 1000 ohm \pm 10%; 1/2 w	23J20BF102K
E-26,27	INSULATOR, bushing; electrical insulator in coupling to main TUNING shaft	8B1177	R-7	RESISTOR, fixed: comp; 1000 ohm \pm 10%; 1/2 w; part of T-7	-----
E-50,51	INSULATOR, plate; insulator detent arm	8B1316	R-54,111	RESISTOR, fixed: comp; 1500 ohms \pm 10%; 1/2 w	23J20BF152K
J-3	JACK, phones	36A042	R-88,100	RESISTOR, fixed: comp; 2200 ohm \pm 10%; 1/2 w	23J20BF222K
	KNOB, BFO PITCH control	15B249	R-13,14,15,16	RESISTOR, fixed: comp; 2200 ohm \pm 10%; 1/2 w; part of T-13,14,15 and 16 respectively	-----
	KNOB, VFO CRYSTAL switch	15B251	R-6,12,36,48,57,63,69,75,79,103,5	RESISTOR, fixed: comp; 2700 ohm \pm 10%; 1/2 w	23J20BF272K
	KNOB, CRYSTAL VERNIER control	15B252	R-26,27	RESISTOR, fixed: comp; 470 ohm \pm 10%; 1/2 w; part of T-23 and 24	-----
	KNOB, RF GAIN - AC control	15B253	R-110	RESISTOR, fixed: comp; 5600 ohms \pm 10%; 1 w	23J30BF562K
	KNOB, AUDIO GAIN control	15B254	R-86	RESISTOR, fixed: comp; 8200 ohm \pm 10%; 1/2 w	23J20BF822K
	KNOB, SELECTIVITY control	15B255	R-95,106,113,11,20	RESISTOR, fixed: comp; 10,000 ohms \pm 10%; 1/2 w	23J20BF103K
	KNOB, CRYSTAL PHASING control	15B250	R-24,25	RESISTOR, fixed: comp; 10,000 ohms \pm 10%; 1/2 w; part of T-21 and 22	-----
	KNOB, black phenolic; TUNING control	15B184	R-19,62,68,104	RESISTOR, fixed: comp; 22,000 ohm \pm 10%; 1/2 w	23J20BF223K
	KNOB, BAND SELECTOR control	15B307	R-33,56	RESISTOR, fixed: comp; 27,000 ohm \pm 10%; 1/2 w	23J20BF273K
	KNOB, antenna adjust	15B347	R-44,47	RESISTOR, fixed: comp; 33,000 ohm \pm 10%; 1/2 w	23J20BF333K
	KNOB, BFO injection	15B463	R-22,23	RESISTOR, fixed: comp; 39,000 ohm \pm 10%; 1/2 w; part of T-19 and 20	-----
E-5,6	LAMP, dial; GE Mazda #44; 6-8 volt 1/4 amp	39A003	R-45,46,32,97	RESISTOR, fixed: comp; 47,000 ohm \pm 10%; 1/2 w	23J20BF473K
R-101,102	LAMP, incandescent; GE Mazda #7C7-120	39A026	R-84	RESISTOR, fixed: comp; 82,000 ohm \pm 10%; 1 w	23J30BF823K
J-5,6	LAMPHOLDER, miniature bayonet	86B110	R-3,51,60,66,78,116	RESISTOR, fixed: comp; 100,000 ohm \pm 10%; 1/2 w	23J20BF104K
J-7,8	LAMPHOLDER, candelabra screw base	86-100	R-96	RESISTOR, fixed: comp; 150,000 ohm \pm 10%; 1/2 w	23J20BF154K
H-18	LOCK, dial; clamp type;	41B14709			
H-17	MASK dial; band and frequency indicator	83C375			
M-1	METER, 0-50 microamps; CARRIER LEVEL indicator	82-178			
H-19 thru 34	NUT, anchor; for tube sockets X-1 thru X-16	76A608			
N-1	PLATE, channel-frequency identification	13B597			

SERVICE PARTS LIST (Cont.)

Schematic Symbol	Description	Hallcrafters Part Number	Schematic Symbol	Description	Hallcrafters Part Number
R-89,107,112	RESISTOR, fixed: comp; 220,000 ohm $\pm 10\%$; 1/2 w	23J20BF224K	T-32	TRANSFORMER, IF: 455 kc output	50C467
R-117	RESISTOR, fixed: comp; 330,000 ohm $\pm 10\%$; 1/2 w	23J20BF334K	T-33	TRANSFORMER, IF; BFO 455 kc transformer	50C466
R-73,77,98	RESISTOR, fixed: comp; 470,000 ohm $\pm 10\%$; 1/2 w	23J20BF474K	T-34	TRANSFORMER, power	52C198
R-40	RESISTOR, fixed: comp; 680,000 ohm $\pm 10\%$; 1/2 w	23J20BF584K	T-1	TRANSFORMER, antenna; band 1	51D1206
R-2,9,91	RESISTOR, fixed: comp; 1 meg $\pm 10\%$; 1/2 w	23J20BF105K	T-2	TRANSFORMER, antenna; band 2	51D1207
R-108	RESISTOR, fixed: comp; 2.2 meg $\pm 10\%$; 1/2 w	23J20BF225K	T-3	TRANSFORMER, antenna; band 3	51D1208
R-80	RESISTOR, thermal; ballast tube	24-924	T-4	TRANSFORMER, antenna; band 4	51D1209
R-87	RESISTOR, variable: WW; 1500 ohm $\pm 10\%$; 75 w	25J20A1SA152AK	T-5	TRANSFORMER, antenna; band 5	51D1210
R-82	RESISTOR, variable; comp; 5000 ohms $\pm 20\%$ 2.25 w at 70° C	25B884	T-6	TRANSFORMER, antenna; band 6	51D1211
S-7, R-83	RESISTOR, variable; comp. 5000 ohms $\pm 20\%$ 2.25 w	25B886	T-7	TRANSFORMER, rf; band 1	51D1212
R-94	RESISTOR, variable; comp; 2 meg. $\pm 20\%$; 2.25 w at 70° C	25B883	T-8	TRANSFORMER, rf; band 2	51D1213
O-3,4	RETAINER, crystal holder	75B181	T-9	TRANSFORMER, rf; band 3	51D1214
O-5	RETAINER, tube; for V-17	76-624	T-10	TRANSFORMER, rf; band 4	51D1215
O-23,24	RING, retainer; for CRYSTAL PHASING shaft	76A552	T-11	TRANSFORMER, rf; band 5	51D1216
	SCALE, main tuning	83B380	T-12	TRANSFORMER, rf; band 6	51D1217
	SCALE, vernier indicator	83C374	T-13	TRANSFORMER, mixer; band 1	51D1218
O-25	SHAFT, extension; for CRYSTAL PHASING capacitor C-161	74B322	T-14	TRANSFORMER, mixer; band 2	51D1219
O-31	SHAFT, turret	74B308	T-15	TRANSFORMER, mixer; band 3	51D1220
O-32	SHAFT, antenna adjustment	74B371	T-16	TRANSFORMER, mixer; band 4	51D1221
O-33	SHAFT, extension; turret	74B372	T-17	TRANSFORMER, mixer; band 5	51D1222
O-37,38	SHIELD, light	86A037	T-18	TRANSFORMER, mixer; band 6	51D1223
O-39	SHIELD, co-ax cable receptacle	10A055	T-19	TRANSFORMER, oscillator; band 1	51D1224
E-33 thru 43, 45,46,47	SHIELD, tube; for tubes V-1,2, 3,5 thru 11,14,15 and 16	69A277	T-20	TRANSFORMER, oscillator; band 2	51D1225
E-44,48	SHIELD, tube; for tubes V-12 and V-13	69A160	T-21	TRANSFORMER, oscillator; band 3	51D1226
X-21 thru 28	SOCKET, crystal	6A320	T-22	TRANSFORMER, oscillator; band 4	51D1227
X-1,2,3,5	SOCKET, tube; miniature 7 pin; tubes V-1,2,3 and 5	6A252	T-23	TRANSFORMER, oscillator; band 5	51D1228
X-4	SOCKET, tube; miniature 7 pin; tube V-4	6A372	T-24	TRANSFORMER, oscillator; band 6	51D1229
X-6 thru 16	SOCKET, tube; octal	6A317	V-1,5	TUBE, electron: type 6AG5; 1st RF and crystal oscillator	90J6AG5
O-9,10	SPRING, helical extension type	75B185	V-2,6,8,9,10, 11,14,15	TUBE, electron; type 6BA6; 2nd RF, 6 mc IF, 6.455 mc oscillator, 1st 455 kc IF, 2nd 455 kc IF, 3rd 455 kc IF, BFO. IF output	90J6BA6
H-39,40,41	STUD, terminal	11A315		TUBE, electron: type 6BE6; 1st mixer, 2nd mixer	90J6BE6
S-1A to F	SWITCH, rotary; SELECTIVITY	60C394		TUBE, electron: type 6C4; VFO	90J6C4
S-2A,B,C	SWITCH, rotary; VFO-CRYSTAL	60C384	V-3,7	TUBE, electron: type 6AL5; detector and automatic noise limiter, automatic volume control	90J6AL5
S-3,6	SWITCH, toggle: spst; ANL-OFF and SEND-RECEIVE	60JST42A	V-4	TUBE, electron: type 6AT6; 1st AF amplifier	90J6AT6
S-4	SWITCH, toggle: dpdt; AGC-MANUAL	60JST52N	V-12,13	TUBE, electron: type 6Y6G; audio output	90J6Y6G
S-5	SWITCH, toggle: dpst; CW-MODULATION	60JST52K	V-18	TUBE, electron: type 5U4G; rectifier	90J5U4G
T-35	TRANSFORMER, audio output	55C146	V-19	TUBE, electron: type 0C3W/VR105; voltage regulator	90JOC3W/VR105
T-25	TRANSFORMER, IF: 6 mc input	50C459	H-12	WRENCH, Allen head set screw; for front panel knobs	33-427
T-26	TRANSFORMER, IF: 6 mc output	50C460	H-13	WRENCH, Allen head set screw; for couplings	33-428
T-27	TRANSFORMER, IF: 6.455 crystal oscillator	50C461			
T-28	TRANSFORMER, IF; 1st 455 kc i-f transformer	50C462			
T-29	TRANSFORMER, IF; 2nd 455 kc i-f transformer	50C463			
T-30	TRANSFORMER, IF; 3rd 455 kc i-f transformer	50C464			
T-31	TRANSFORMER, IF; 4th 455 kc i-f transformer	50C465			

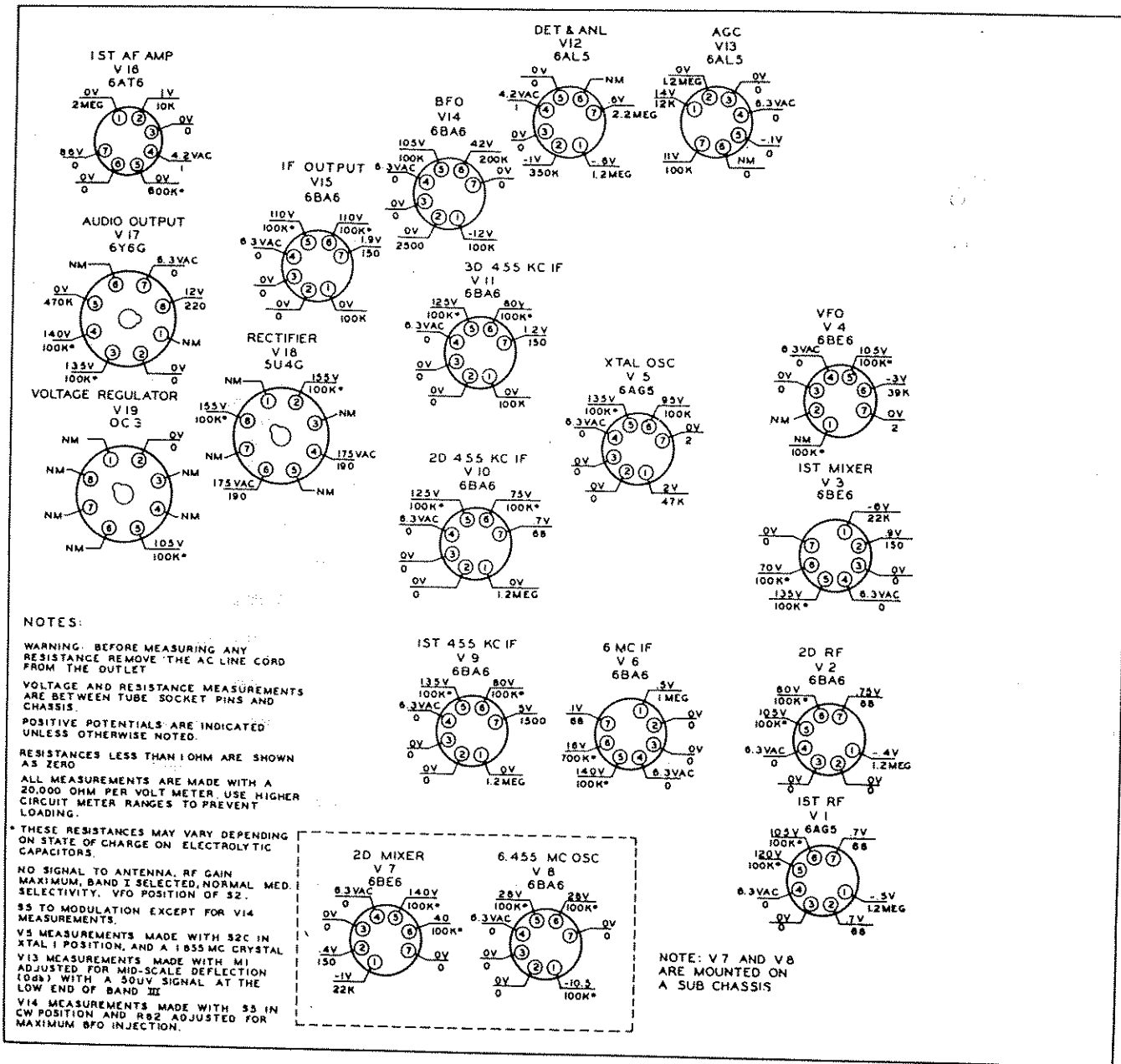
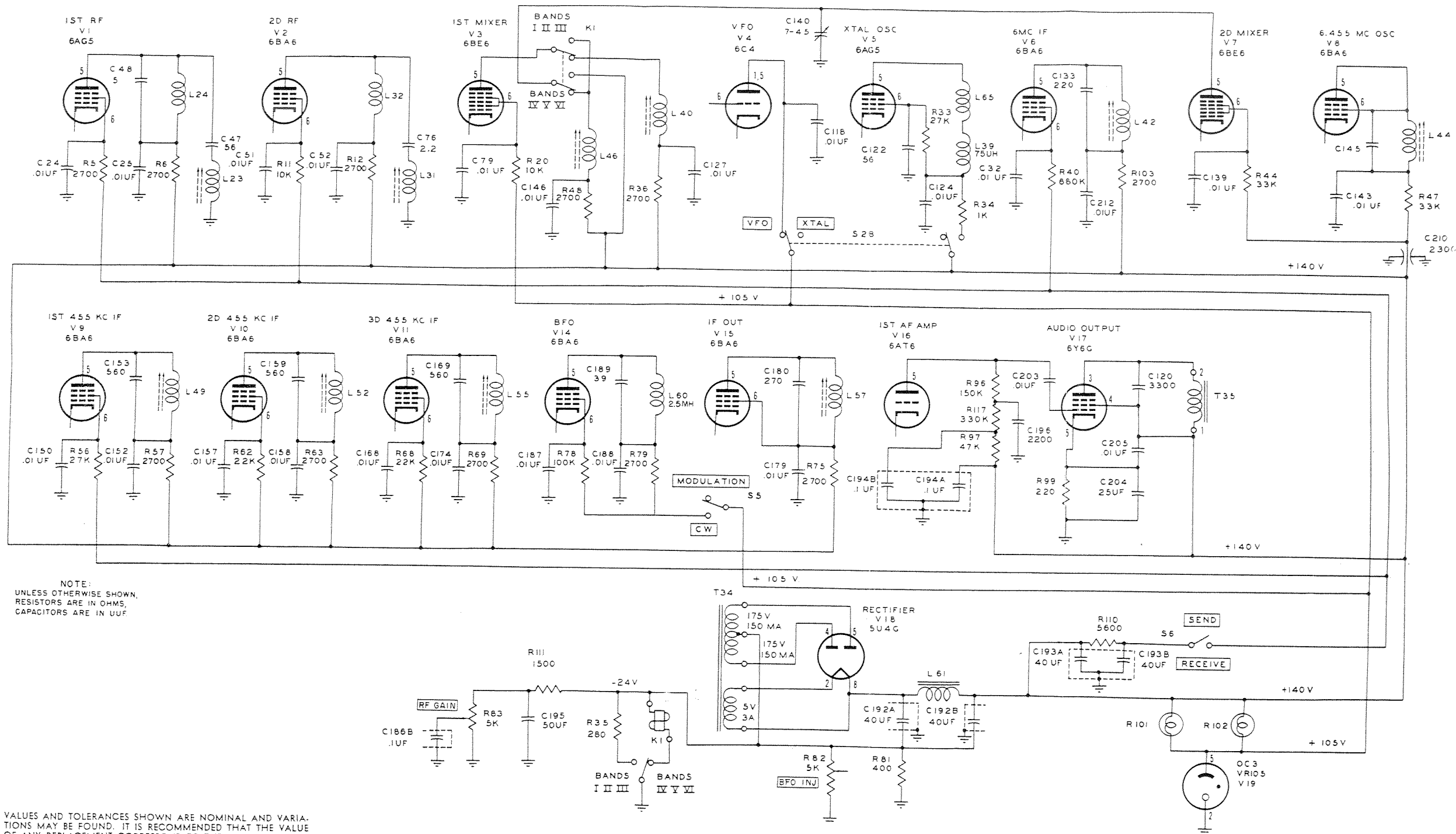

Fig. 17. Voltage and Resistance Chart



NOTE:
UNLESS OTHERWISE SHOWN,
RESISTORS ARE IN OHMS,
CAPACITORS ARE IN UUF

VALUES AND TOLERANCES SHOWN ARE NOMINAL AND VARIATIONS MAY BE FOUND. IT IS RECOMMENDED THAT THE VALUE OF ANY REPLACEMENT CORRESPOND TO THE NOMINAL VALUE OF THE PART BEING REPLACED.

Fig. 18. +B Voltage Distributions

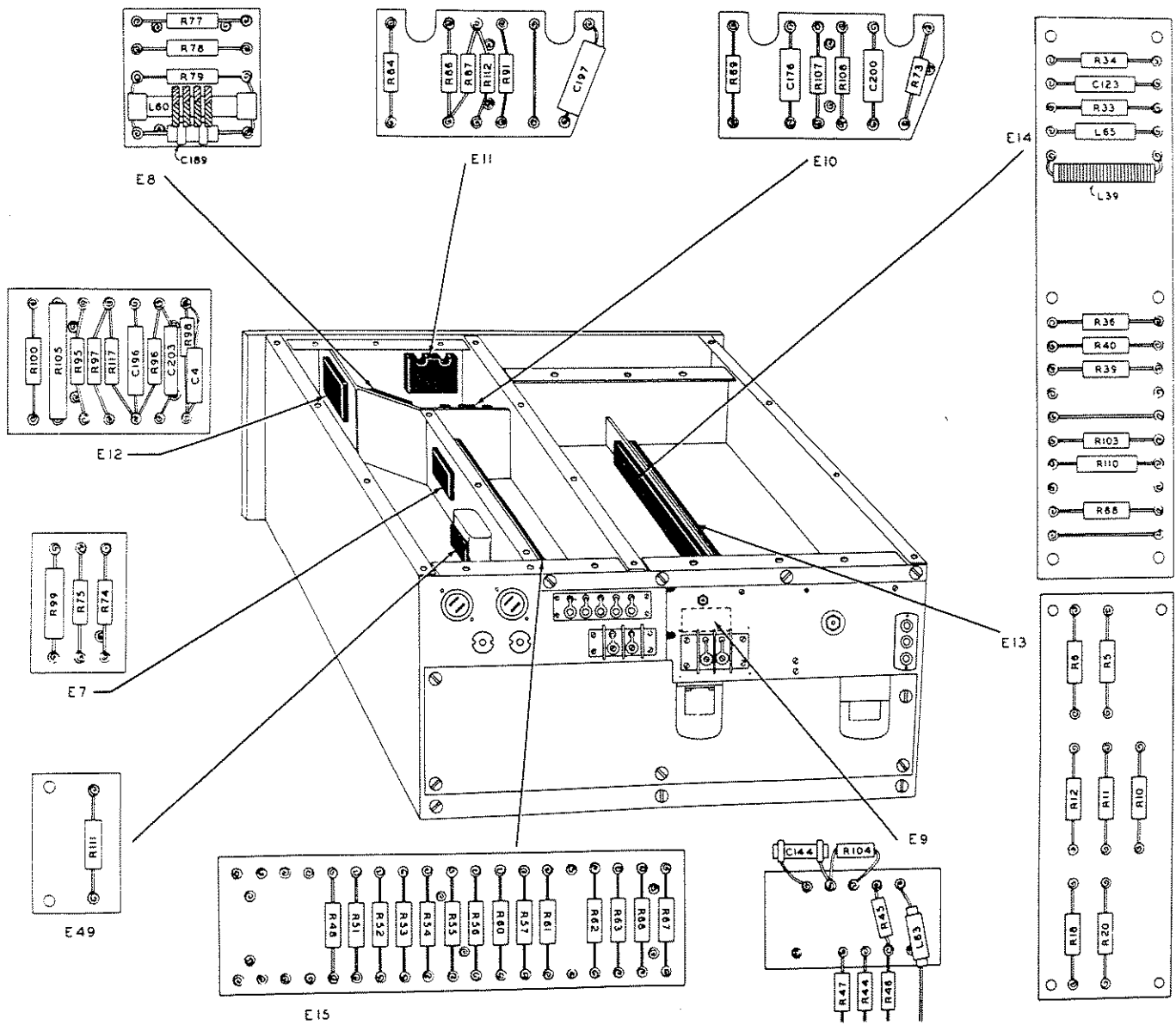
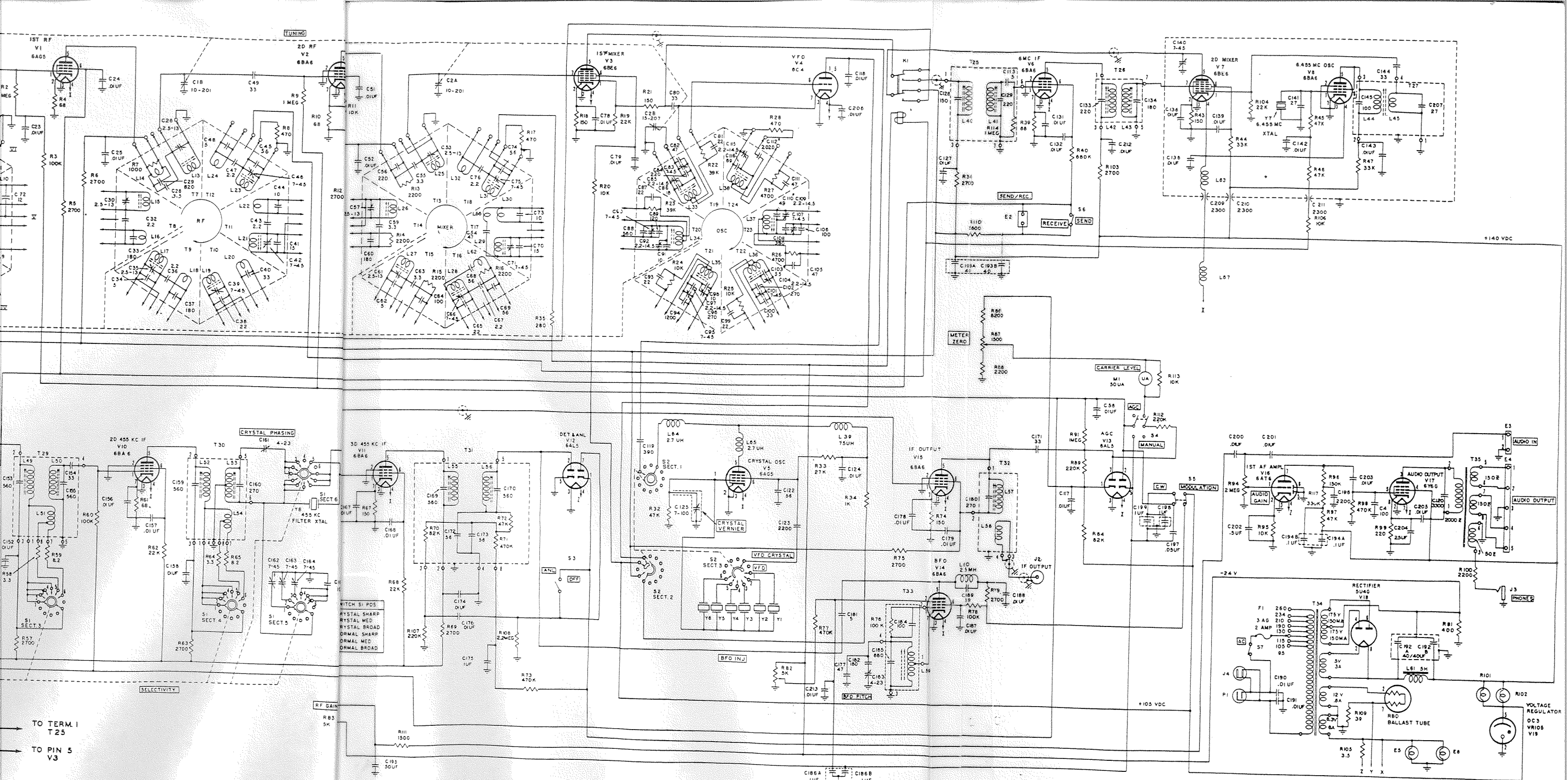

Fig. 19. Resistor-Capacitor Board, Location Diagram



NOTES:
 RESISTANCE VALUES IN OHMS UNLESS OTHERWISE SPECIFIED.
 CAPACITANCE VALUES IN UUF UNLESS OTHERWISE SPECIFIED.
 C12 CONSISTS OF ONE 1870 UUF CAPACITOR CONNECTED IN PARALLEL WITH ONE 350 UUF CAPACITOR.
 C103 CONSISTS OF A .33UUF CAPACITOR AND A 22UUF CAPACITOR CONNECTED IN PARALLEL.
 C110 CONSISTS OF A .22UUF CAPACITOR AND AN 27UUF CAPACITOR CONNECTED IN PARALLEL.
 C116 CONSISTS OF A .22UUF CAPACITOR AND A .47UUF CAPACITOR CONNECTED IN PARALLEL.
 C209, C210 AND C211 ARE FEEDTHRU CAPACITORS AS TURNED IS TURNED CLOCKWISE (INDICATED BY ARROW) THE SEQUENCE OF BAND SETTING WILL BE 1 THRU 52 SHOWN IN VFO POSITION.

SWITCHES ARE VIEWED FROM END OPPOSITE CONTROL. KNOBS

Fig. 20. Schematic Diagram

VALUES AND TOLERANCES SHOWN ARE NOMINAL AND VARIATIONS MAY BE FOUND. IT IS RECOMMENDED THAT THE VALUE OF ANY REPLACEMENT CORRESPOND TO THE NOMINAL VALUE OF THE PART BEING REPLACED.

RF TURRET CONTACT

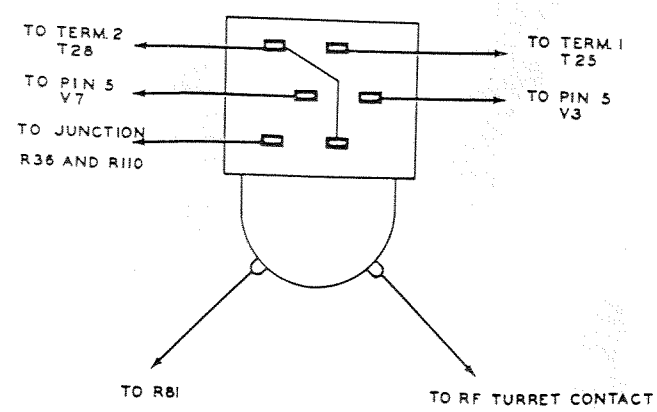
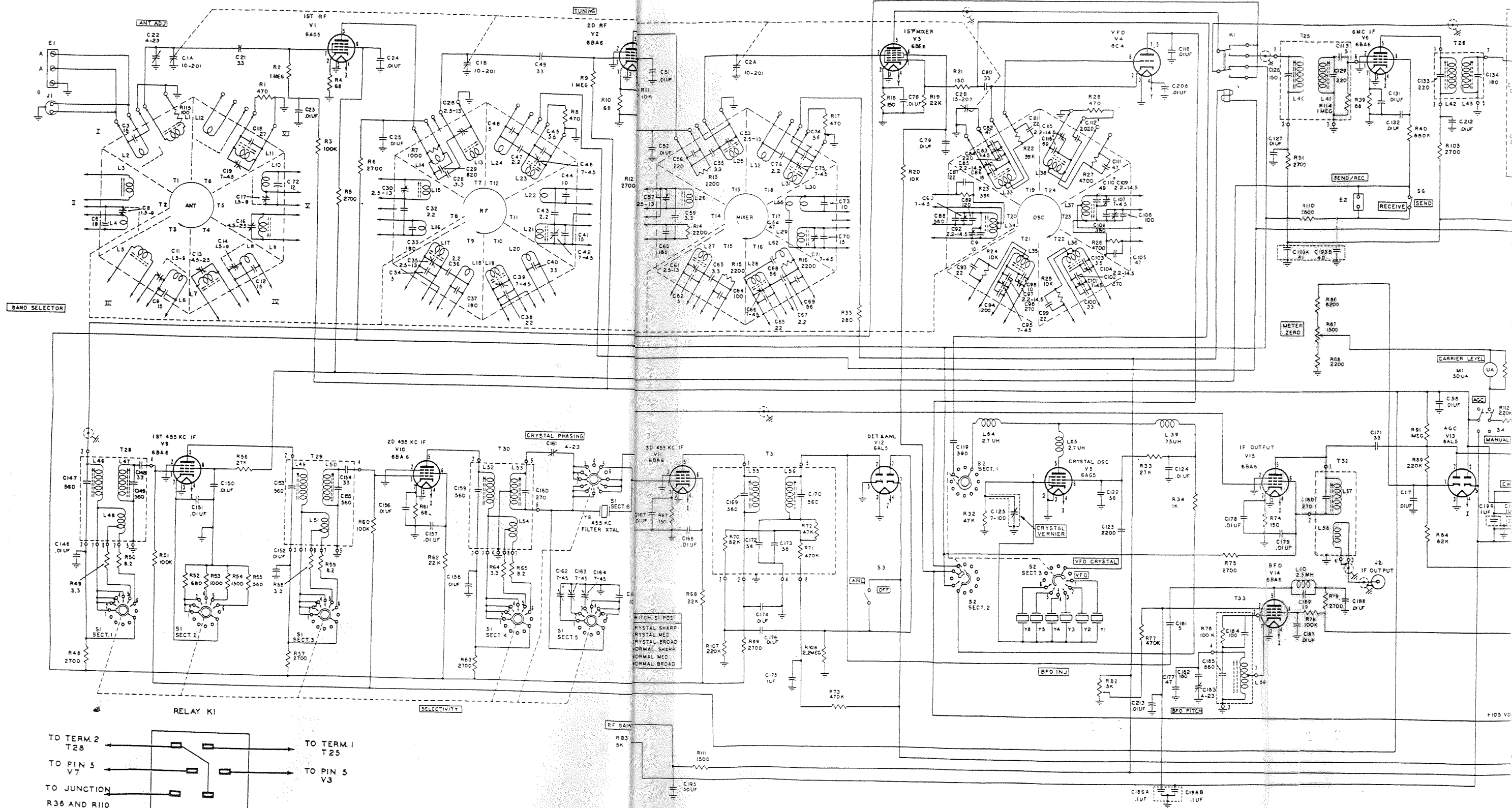

1-f switch-over relay connections.

NOTES:
 RESISTANCE VALUES IN OHMS UNLESS OTHERWISE SPECIFIED
 CAPACITANCE VALUES IN UUF UNLESS OTHERWISE SPECIFIED
 C112 CONSISTS OF ONE 1870 UUF CAPACITOR CONNECTED IN PARALLEL WITH ONE 350 UUF CAPACITOR
 C103 CONSISTS OF A 33UUF CAPACITOR AND A 22UUF CAPACITOR CONNECTED IN PARALLEL
 C110 CONSISTS OF A 22UUF CAPACITOR AND AN 27UUF CAPACITOR CONNECTED IN PARALLEL
 C116 CONSISTS OF A 22UUF CAPACITOR AND A 47UUF CAPACITOR CONNECTED IN PARALLEL
 C209, C210 AND C211 ARE FEDBACK CAPACITORS
 AS TURRET IS TURNED CLOCKWISE (INDICATED BY ARROW) THE SEQUENCE OF BAND SETTING WILL BE 1 THRU 32
 S2 SHOWN IN VFO POSITION

SWITCHES ARE VIEWED FROM END OPPOSITE CONTROL KNOB

Fig. 20. Schematic Diagram

VALUES AND TOLERANCES SHOWN MAY BE FOUND. IT IS RECOMMENDED THAT ANY REPLACEMENT CORRESPOND TO THE PART BEING REPLACED.