

**HQ-110A
COMMUNICATIONS
RECEIVER**

**TECHNICAL
DESCRIPTION
AND
OPERATING
INSTRUCTIONS**

HAMMARLUND

Hammarlund Manufacturing Company
A Gianni Scientific Co.
53 West 23rd Street, New York 10, N. Y.
Export Department: 13 East 40th Street, New York 16, N. Y.

THE HQ-110A COMMUNICATIONS RECEIVER

INSTRUCTION AND SERVICE INFORMATION
FOR RECEIVERS STARTING WITH SERIAL #8900

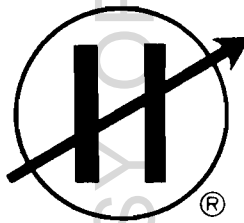

ESTABLISHED 1910

ISSUE 1

In order to receive the full unconditional 90-day warranty against defective material and workmanship in this receiver, the warranty card must be filled out and mailed within two weeks of purchase. Please refer to serial number of warranty in correspondence.

THE HAMMARLUND MANUFACTURING CO.
A GIANNINI SCIENTIFIC CO.
53 West 23rd Street New York 10, N. Y.



Figure 1. The HQ-110A Communications Receiver

TUBE COMPLEMENT

Symbol	Type	Tube	Function
V1	6BZ6	Pentode	RF Amplifier
V2	6BE6	Pentagrid Converter	Mixer
V3	6BE6	Pentagrid Converter	Converter
V4	12AX7	Twin Triode	Q-Multiplier, First AF Amplifier
V5	6BA6	Pentode	First IF Amplifier
V6	6AZ8	Triode-Pentode	Linear Detector—Second IF Amplifier, BFO
V7	6BJ7	Triple Diode	Detector, Noise Limiter, AVC
V8	6AQ5	Pentode	AF Output
V9	6BZ6	Pentode	Crystal Calibrator Oscillator
V10	6C4	Triode	HF Oscillator
V11	OB2	Gas Filled Diode	Voltage Regulator
V12	5U4-GB	Twin Diode	Rectifier

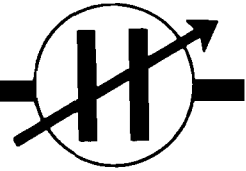

INTRODUCTION

The Hammarlund HQ-110A is an all-new amateur communications receiver representing entirely new concepts in electrical and mechanical design. It will provide years of top performance with minimum maintenance. The HQ-110A has a self-contained power supply operating from a 60 cps, 105-125 volt AC source. Power consumption is 80 watts. The Hammarlund HQ-110AC incorporates a telechron automatic electric clock-timer in its design. The export model, HQ-110AE, now available, will operate from a 50 or 60 cps, 115-230 volt AC source, See Figure 13 for Wiring Instructions.

The HQ-110A is a superheterodyne receiver with a frequency coverage of the amateur bands as follows:

- 160 meter band, 1.8 to 2.0 mc, calibrated in 5 KC divisions.
- 80 meter band, 3.5 to 4.0 mc, calibrated in 5 KC divisions.
- 40 meter band 7.0 to 7.3 mc, calibrated in 5 KC divisions
- 20 meter band, 14.0 to 14.4 mc, calibrated in 5 KC divisions
- 15 meter band, 21.0 to 21.6 mc, calibrated in 10 KC divisions.
- 10 meter band, 28.0 to 30.0 mc, calibrated in 20 KC divisions.
- 6 meter band, 50.0 to 54.0 mc, calibrated in 50 KC divisions.

A 2 Meter scale is provided for use with a converter which has an output in the 6 meter band. Double conversion is employed for the 40, 20, 15, 10 and 6 meter bands.

A single control provides extremely fine tuning for the separation of crowded signals. A very high signal-to-noise ratio, plus the famous Hammarlund noise limiter circuit, permits full use of the receiver's excellent sensitivity on the weakest signal. A

Q-Multiplier is provided for varying the selectivity of the receiver.

A new audio output circuit feature is the Auto-Response, which automatically narrows and widens the frequency range of the audio output, according to the gain required. This feature permits higher fidelity reception on stronger signals, while providing the sharp cutoff required in receiving communications under adverse conditions. A second advantage of the Hammarlund Auto-Response is the rapid damping of the audio power in the speaker voice coil which greatly minimizes undesirable speaker "hangover." The receiver may be used with either speaker or headphones. Fast acting AVC maintains a constant audio level. Adequate filtering practically eliminates AC power ripple.

The HQ-110A is equipped with a stable beat frequency oscillator which provides the operator with a continuous range of audio tones when receiving telegraphic code signals. When used in conjunction with the Q-Multiplier, single signal reception is assured.

A 100 KC crystal-controlled oscillator is incorporated to provide 100 KC check points for precise calibration on all seven bands.

A linear detector is provided for the optimum reception of SSB and CW signals.

An "S" meter is provided to obtain accurate readings on received phone signals and to assure "on-the-nose" tuning. A send-receive switch is provided to silence the receiver while transmitting.

Large, comfortable controls in logical groupings are provided for greatest operating ease. The new futuristic front panel is clearly marked to permit full attention to the operation at hand.

The HQ-110A was designed with you in mind. You'll have many hours of pleasure and use in operating this truly fine communications instrument.

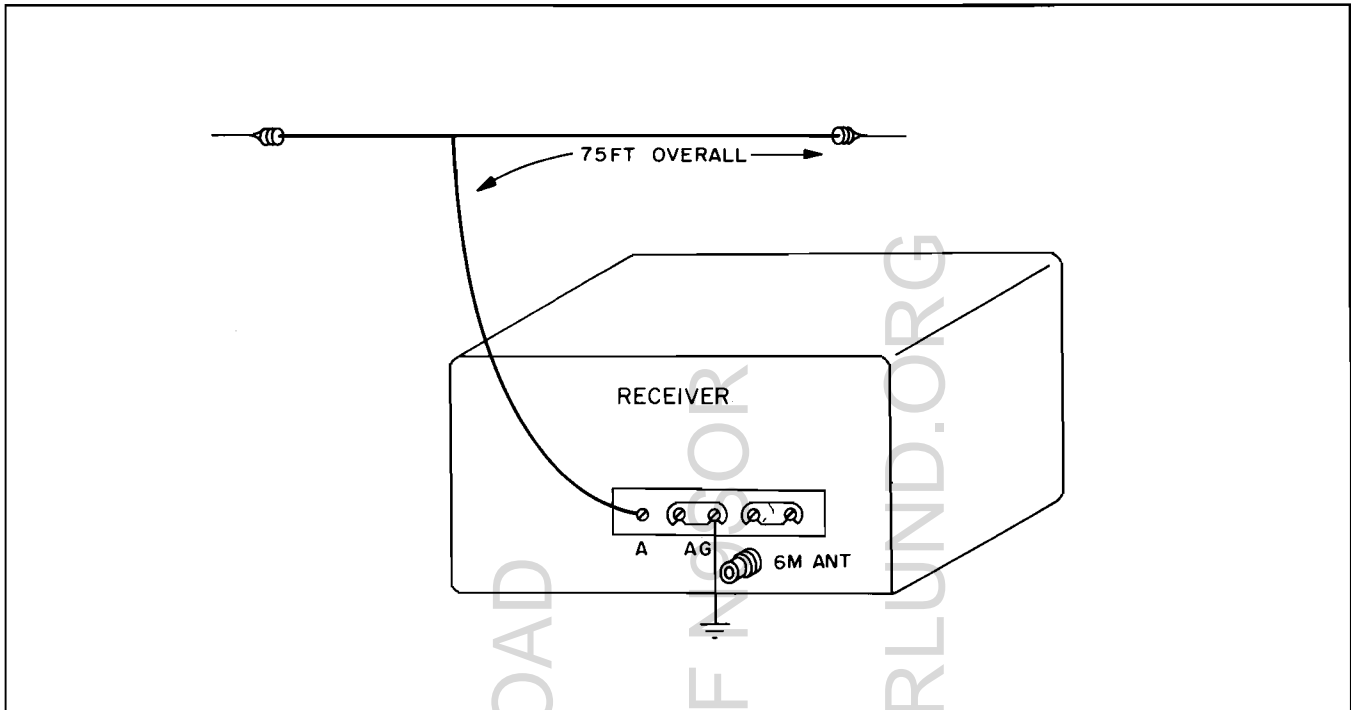

Figure 2. Installation of Single-wire Antenna

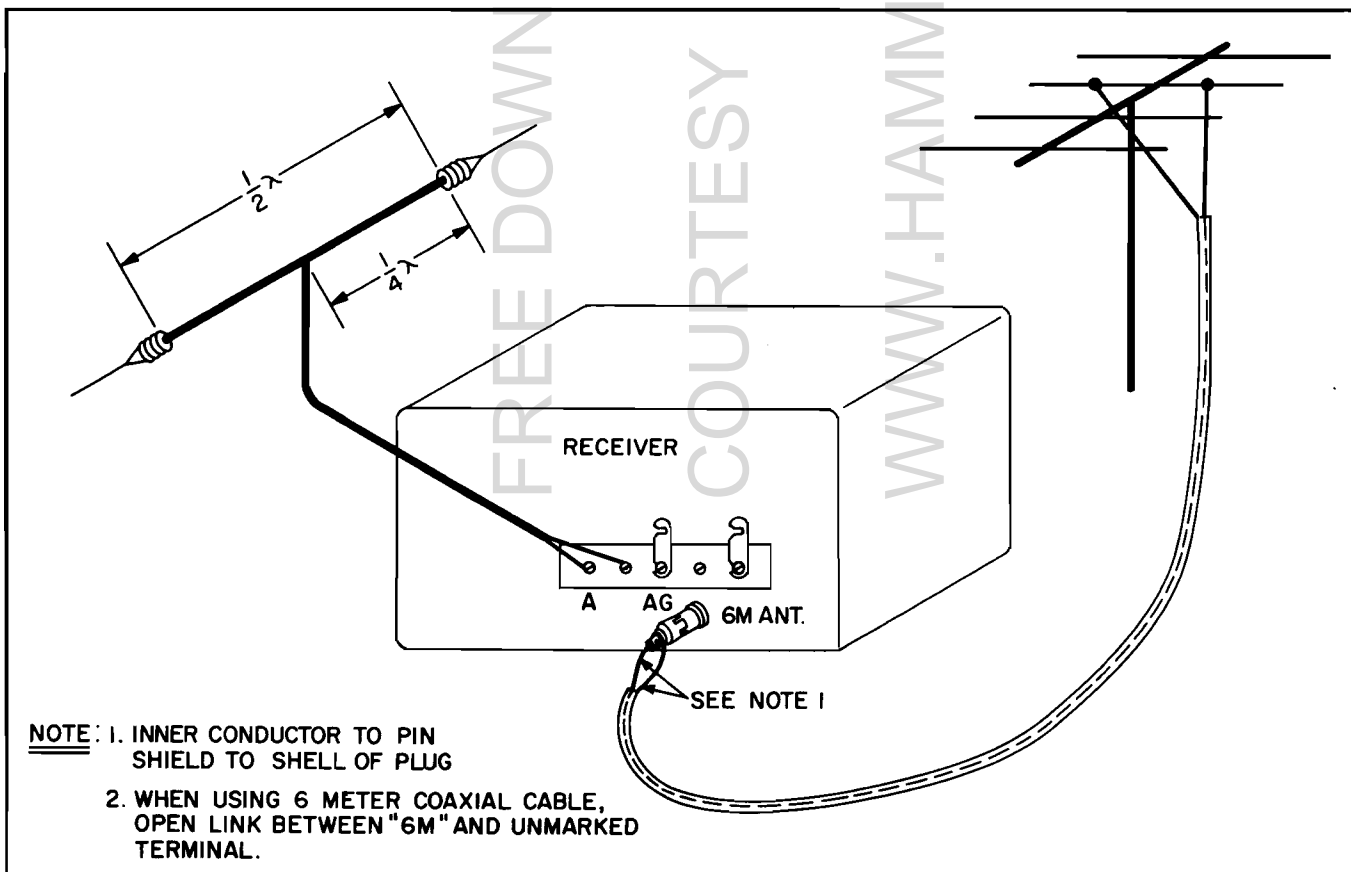
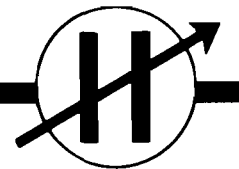

Figure 3. Installation of Folded Dipole Antenna



INSTALLATION

UNPACKING

Unpack the receiver carefully. Make sure the tubes, associated tube shields and pilot lamps are in place.

SPEAKER CONNECTION

Connect a 3.2 ohm permanent magnet dynamic speaker (Hammarlund S-100 Speaker) to the two terminals marked SPKR. on the rear of the chassis. (Note Figure 4.) For best performance do not place speaker on top of receiver cabinet.

POWER CONNECTIONS

Before inserting attachment plug into power outlet, make certain power source is of proper voltage and frequency. (Refer to paragraph one of INTRODUCTION.)

INSTALLING ANTENNA

The HQ-110A is designed to operate with a single wire or a balanced type antenna. The front panel antenna trimmer control (Figure 5) permits a good match to most antennae systems of 50 to 600 ohms.

For general coverage, single wire antennae of 20 to 50 feet length will provide surprisingly good reception. A long single wire outdoor antenna, such as the one shown in figure 2, will generally provide entirely satisfactory performance. This wire may be 50 to 150 feet long.

For best reception, the antenna should be isolated as much as possible from neighboring objects and at right angles to power lines or busy highways so as to minimize possible interference pickup.

Optimum performance on a particular amateur band or other narrow tuning range will be obtained by using a tuned half-wave dipole or folded dipole fed with 300 ohm transmission line or other suitable lead-in, as shown in figure 3.

To tune the one-half wave length dipole, the following formula for the length of the antenna may be used:

$$\text{Length (feet)} = \frac{468}{\text{Freq. MCS}}$$

Each half (1/4 wave length) is half the length found from the above formula.

A one-half wave dipole can be used on 6 meters but a commercial beam will perform better.

A separate coax socket input is provided for 6 meters. The terminal strip may also be used as a separate 6 meter input. In either case the jumper must be removed from across the 6 meter antenna terminal strip. If the jumper is left in place and only a low frequency antenna connected to the normal input terminals this antenna will be in the circuit on the 6 meter position.

A socket J3 is provided on the rear skirt for powering a preamplifier such as the Ameco model #PV 50 meter preamplifier. Refer to the schematic diagram for wiring information. Where a 6 meter preamplifier is used the input should be to the 6 meter antenna connector or strip with the link open.

POWER SOCKET RATINGS:

6.3 V @ .15 amperes 250 V @ 15 Milliamperes

When using plug-in Silicon Rectifier Part No. PL 39143-GI:

6.3V @ .5 Amperes 250 V & 30 Milliamperes

A good ground, although not always necessary, will generally aid in reception and reduce stray line hum. Reversal of polarity of power cord plug may possibly further reduce line hum in some locations.

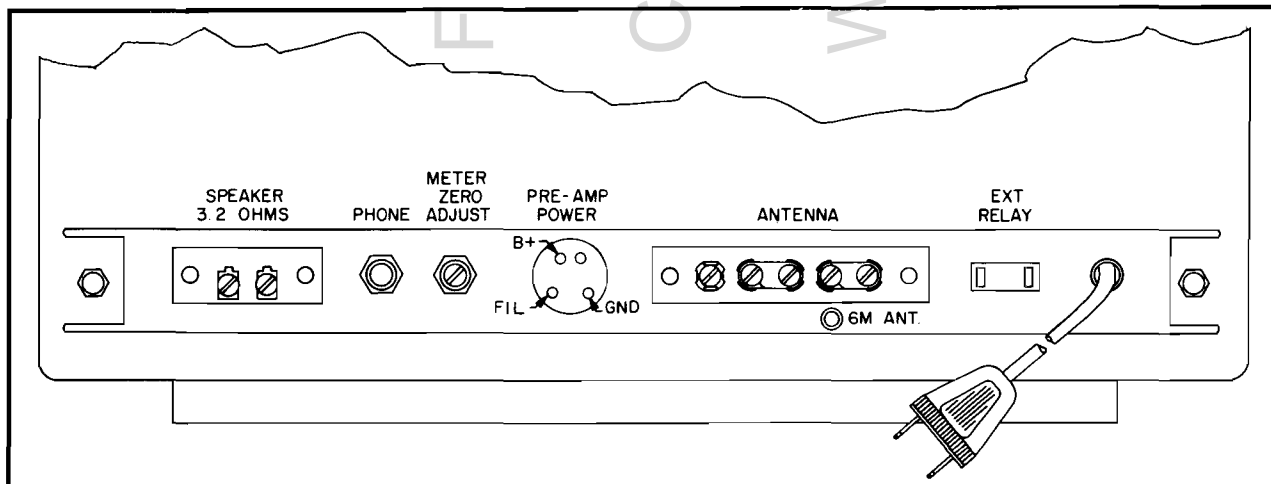
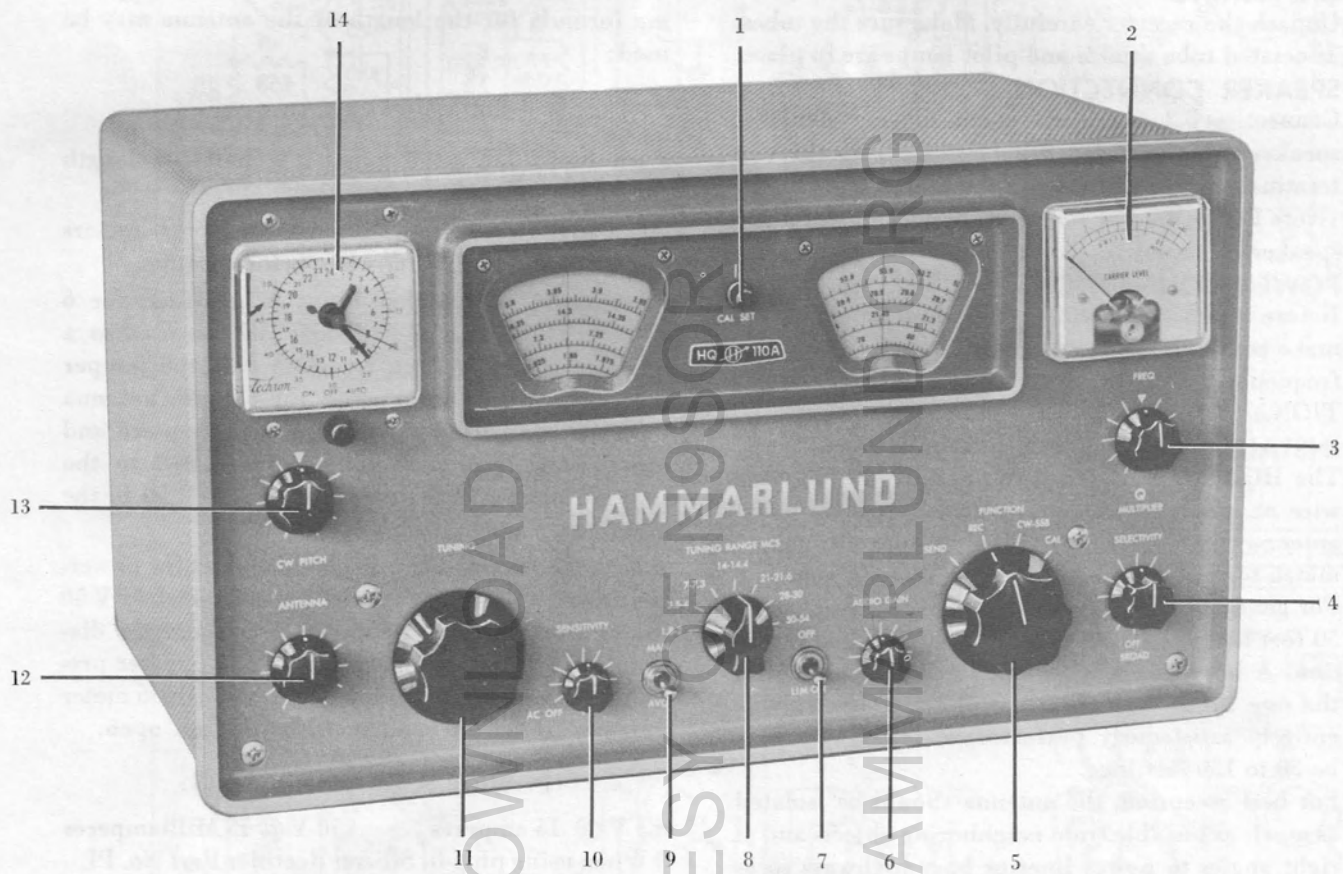
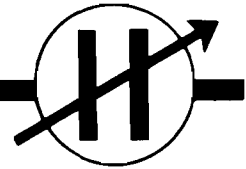

Figure 4. Connection Points at Rear of Chassis



INDEX NO.	CONTROL	INDEX NO.	CONTROL
1	CAL SET Control	8	TUNING RANGE Switch (Band Selector)
2	"S" Meter (Carrier Level)	9	MAN-AVC Switch
3	FREQ. Control (Q-Multiplier)	10	SENSITIVITY Control
4	SELECTIVITY Control (Q-Multiplier)	11	TUNING Control
5	FUNCTION Switch	12	ANTENNA Trimmer
6	AUDIO GAIN Control	13	CW PITCH Control (Beat Frequency Oscillator)
7	LIM Switch (Noise Limiter)	14	Telechron Automatic Clock (Timer)

Figure 5. Location of Controls



OPERATION

AM RECEPTION

For AM reception the position of the controls should be as follows:

FUNCTION Switch	Receive (REC)
TUNING RANGE Switch	Set to desired frequency range
MAN - AVC Switch	AVC
FREQ. Control	Set pointer to triangular marker
CAL SET Control	Set to vertical marker
LIM Switch	As required
TUNING Control	Tune for highest "S" meter reading on signal
ANTENNA Trimmer	Tune for highest "S" meter reading on signal
SELECTIVITY Control	Fully counterclockwise*
SENSITIVITY Control	Fully clockwise**
AUDIO GAIN Control	Adjust for required level***

*Normally for AM reception, the Q-Multiplier is switched OFF (fully counterclockwise) for maximum bandwidth. However, the Q-Multiplier may be useful in eliminating interference from closely adjacent signals at some sacrifice in the fidelity. The bandwidth is narrowed by clockwise rotation of the SELECTIVITY control

**For normal AM reception, the SENSITIVITY control is fully clockwise. The "S" meter calibration holds only in this position on AVC operation. In the presence of extremely strong signals, the SENSITIVITY control may be reduced to prevent overloading.

***A feature of the audio system is the variable negative feedback employed. Maximum feedback is provided at low settings of the AUDIO GAIN control for the best quality reception of strong signals. As the AUDIO GAIN control is increased, the feedback decreases so that on reception of weak signals additional selectivity is provided by the audio system. This results in an increased signal-to-noise ratio. A further advantage is the critical damping of the speaker for elimination of speaker "hangover." This upgrades the reception of speech and decreases the noise output of the receiver. A further advantage is the reduction of distortion at low settings of the AUDIO GAIN control.

CODE SIGNAL RECEPTION

For CW code reception the position of the controls should be as follows:

FUNCTION Switch	CW-SSB
TUNING RANGE Switch	Set to desired frequency range
MAN - AVC Switch	MAN
FREQ. Control	Set pointer to triangular marker*
CAL SET Control	Set to vertical marker
CW PITCH Control	Pointer on triangular marker for zero beat tuning and then offset either left or right for desired pitch
TUNING Control	Tune for zero beat
ANTENNA Trimmer	Tune for maximum response
SELECTIVITY Control	"ON" and advanced as required**
SENSITIVITY Control	Adjust for desired output level
AUDIO GAIN Control	Clockwise to 12 or 2 o'clock position

*The FREQ. control will peak the selectivity curve to the left or right over the pass band of the IF amplifier permitting a high degree of the control of selectivity for closely adjacent interfering signals.

**The broadest position of the SELECTIVITY control (corresponding to a 6 db bandpass of 3 KCS) is with the control turned clockwise just sufficiently to operate its switch. This puts the Q-Multiplier in operation. Further clockwise rotation of the control narrows the bandwidth until a position is reached, just short of oscillation, where the bandwidth is of the order of 100 cycles. The control should be adjusted below the point of oscillation and to the desired bandwidth as required by interference.

SSB RECEPTION

For SSB reception the position of the controls should be as follows:

FUNCTION Switch	CW-SSB
TUNING RANGE Switch	Set to desired frequency range
MAN-AVC Switch	MAN
FREQ. Control	Set pointer to triangular marker
CAL SET Control	Set to vertical marker



TUNING Control	Tune for maximum clarity
ANTENNA Trimmer	Tune for maximum response
SELECTIVITY Control	"ON" but not advanced beyond switch*
SENSITIVITY Control	As required**
AUDIO GAIN Control	Clockwise to 12 or 2 o'clock position****
CW PITCH Control	Approximately 1 division left or right****

*The SELECTIVITY control should only be advanced beyond the switch "ON" position if required to increase the selectivity due to interference.

**The SENSITIVITY control should be advanced only sufficiently to provide the required output. The use of a minimum SENSITIVITY control setting insures that no overload distortion occurs in the receiver.

***Operating with the AUDIO GAIN control advanced 1/2 to 2/3 rotation insures sufficient power output while permitting the reduced SENSITIVITY operation described above.

****The CW PITCH control is set approximately 1 division to the right or left of the triangular marker, depending on whether the upper or the lower side band, respectively, is transmitted. The CW PITCH control is adjusted for maximum clarity, once the signal has been tuned in. There will be a correct setting of this control for each sideband and once these two settings are determined, they should be noted for future use in SSB reception.

CALIBRATE

For dial calibration checking, the FUNCTION switch is set at the CAL position and the other controls should be set as listed under CODE SIGNAL RECEPTION. The receiver is aligned with the CAL SET control set at the vertical marker and should be closely correct. The CAL SET control is used to accurately reset the dial indicator lines if they are found to be slightly off calibration at any point on the dials where correct calibration is desired. The receiver is tuned to produce a zero beat response with the PITCH control set at the triangular marker, on any 100 KCS multiple in the desired band. The CAL SET control is then used to reset the dial indicator to the correct marker. If the dial

calibration should be found to be beyond the range of the CAL SET control, the HF Oscillator will require readjustment (see under SERVICE AND REALIGNMENT).

On switching from the CW-SSB position to the CAL position, an increase in level will be noticed. This is done deliberately to provide additional gain for the higher-order harmonics of the 100 KCS crystal calibrator, regardless of whether the receiver is in MAN or AVC position.

Note

As only the amateur bands are covered by this receiver it is not possible to compare the 100 KCS freq. calibrator against WWV. The 100 KCS crystal-controlled oscillator has been accurately set at the factory. This, plus the fact that a very low drift .005% crystal is employed, will insure sufficient accuracy for all practical purposes. For those who desire frequency accuracy of the crystal calibrator in the order of cycles, the procedure outlined on Page 14 should be employed.

EXTERNAL RELAY CONNECTION

A standard power receptacle is provided on the rear apron of the chassis for the connection of an external relay-operated switch. This receptacle accommodates a standard power plug and when so used the SEND position of the FUNCTION SWITCH is not used. A jumper plug, provided for normal without relay switching, is removed from the receptacle when using the relay switching.

The usual antenna change-over relay equipped with a set of normally closed contacts is suggested. The choice of this relay will depend on the particular antenna system involved, such as whether a co-ax relay or one for open wire line is employed. In either case the extra set of contacts to control the receiver will be necessary.

TELECHRON AUTOMATIC CLOCK-TIMER

If your receiver is equipped with the built-in Telechron Automatic Clock-Timer, the following instructions should be noted:

Every radio-frequency device is stable only at predetermined operating temperatures. In order to eliminate waiting for the receiver to warmup to operating temperature, the Telechron Timer automatically turns on the receiver ahead of anticipated operating time. This is accomplished by setting the



hand of the timer (small knob at rear of receiver) to approximately one-half hour before operating time. The front panel control under Timer is then set to "Auto" position. The function switch is set to REC. The receiver is then automatically turned on at the desired time.

The clock hands are set by the rear knob. "Push in" and turn the knob to set the switch timing hand and "pull out" and turn the knob to set the clock hands. The front switch is set to AUTO and the function switch is set to REC. when it is desired to use the automatic clock switch for pre-warming the receiver before operation or for use as an alarm to turn the receiver on to a pre-tuned station. To use the function switch normally, the clock switch should be left in the ON position.

The clock will continue to run as long as the receiver line cord is connected to the power outlet, and is extremely useful for checking sign-in periods and schedules.

If your receiver is not equipped with the standard Telechron Automatic Clock-Timer, and you would care to have the accessory added, The Clock Kit, with full installation instructions, may be purchased from your local Hammarlund dealer.

Instructions for connecting the standard clock-timer are as indicated in figure 12.

The Export Model Clock-Timer HQ-110AE is now available from your local Hammarlund Dealer. This automatic Clock-Timer will operate from a 50-60 CPS, 115-230 Volt AC source. Instructions for connecting the export model Clock-Timer are as indicated in Figure 13.

CIRCUIT THEORY

The HQ-110A is a superheterodyne receiver covering the 6, 10, 15, 20, 40, 80 and 160 meter amateur frequency bands. Double conversion is employed in the 6 through 40 meter bands. Twelve tubes are used, including the Rectifier and Voltage Regulator of the self-contained power supply. The circuitry of the receiver includes a 100 KCS crystal calibrator, a Q-Multiplier for full control of selectivity, an effective noise limiter and a separate highly stable Beat Frequency Oscillator.

PRESELECTION

The antenna input coupling and RF amplifier stage provide the necessary preselection and gain for high performance and rejection of undesired signals. The high signal level at the mixer grid, V2, contributes to a favorable signal-to-noise ratio.

Both grid and plate circuits of the RF stage are tuned; individual tuning coils are selected for each band.

The antenna compensating capacitor, adjustable from the front panel, permits the receiver to be resonated for optimum performance with the particular antenna in use.

CONVERTER STAGE

A high degree of oscillator stability is attained by the use of a separate mixer (6BE6), V2, and an independent oscillator (6C4), V10.

The output signal from RF amplifier, V1, is hetero-

dyned with the output of the local high frequency oscillator, V10, and electronically combined within the mixer tube, V2. On the 80 and 160 meter bands, the local oscillator is 455 KCS above the signal frequency. On the 10 to 40 meter bands, the local HF Oscillator is 3035 KCS above the signal frequency. On the 6 meter band, the local HF Oscillator is 3035 KCS below the signal frequency.

When operating in the 6 to 40 meter bands, the difference frequency of 3035 KCS is heterodyned with the output of the 2580 KCS crystal controlled oscillator and electronically combined within the converter tube, V3, to produce the 455 KCS final intermediate frequency.

Low-loss tube sockets, low-loss phenolic, temperature compensating capacitors, and stable, coaxial glass trimmer all contribute to oscillator stability. Additional frequency stability is attained by applying regulated voltage to the oscillator circuit and by the rugged construction of the entire HF oscillator section assembly.

Q-MULTIPLIER

The Q-Multiplier circuit employed in this receiver provides a means of peaking any signal within the pass band of the IF amplifier. The degree of peaking is controlled by the SELECTIVITY control. The bandwidth varies from 3 KCS with the SELECTIVITY control switch just "ON" to approximately 100



eps with the control just below the oscillation point. If interference is experienced caused by two stations operating very close to one another, the Q-Multiplier may be employed under these circumstances to minimize, if not eliminate, the interference by the improved selectivity or the decreased bandwidth proper adjustment will provide. The proper use of the Q-Multiplier can actually enhance many times the results obtained with the receiver. In view of this, it is suggested that a little time be spent in learning just how to properly adjust the Q-Multiplier frequency and selectivity controls under different receiving conditions. As the Q-Multiplier SELECTIVITY control is advanced, a decided decrease in noise will be apparent. This is due to the narrowing of the pass band. On AM phone signals this control will usually be between the 7 and 11 o'clock positions. The FREQUENCY control should then be adjusted for clarity of signal or for minimum adjacent channel interference. The SELECTIVITY control may be advanced progressively more for SSB and CW reception. The more this control is advanced, the more critical the setting of the FREQUENCY control becomes. The CW PITCH control will also affect the Q-Multiplier FREQUENCY control setting. Advancing the SELECTIVITY control too far will cause the Q-Multiplier to oscillate. This should be avoided and the best setting of this control for CW reception is just below the oscillation point, where maximum peaking occurs. The Q-Multiplier is a very handy tool in the hands of an experienced operator and, unfortunately, it is beyond the scope of this instruction manual to attempt to be more definite than we have.

IF AMPLIFIER

Nine stable tuned circuits, in three stages of IF amplification, V3, V5, and V6A, contribute to sensitivity and selectivity. On the 80 and 160 meter bands, the Intermediate frequency is 455 KCS. On the 6 to 40 meter bands, the first conversion is to an Intermediate frequency of 3035 KCS, employing two tuned circuits and the second conversion is to the 455 KCS Intermediate frequency employing seven tuned circuits. Iron core permeability-tuned

transformers improve performance and add to the ease of adjustment.

AVC SYSTEM

Automatic Volume Control minimizes fading and signal strength variations by controlling the gain of the RF stage, V1, and the IF stage, V5. As a result, a comfortable and constant level of audio is maintained. The AVC voltage for the RF Amplifier tube, V1, is provided with a delay voltage which prevents the AVC from operating on the RF Amplifier tube on extremely weak signals, thus maintaining the maximum sensitivity and signal-to-noise ratio.

"S" METER (CARRIER LEVEL)

The "S", or Tuning, Meter is provided to assist in tuning and to give an indication of relative signal strength. Because the meter readings are proportional to AVC voltage, it is operative only in the AVC position and on AM reception. In the MAN position of the MAN-AVC switch, the meter pointer will not indicate the signal strength. However, the meter pointer will assume various positions, including slightly off scale, depending on the setting of the SENSITIVITY control and the FUNCTION switch. In any operating position of the FUNCTION switch, receiver overload is indicated by a reverse reading of the meter.

The meter, which is calibrated to 40 db over S-9, is factory adjusted so that a signal input of approximately 50 microvolts gives a reading of S-9. Each "S" unit indicates a 6 db increase, equivalent to doubling signal strength. Should meter readjustment be necessary:

1. Set FUNCTION switch to REC.
2. Set front panel SENSITIVITY control to "10."
3. With receiver off, mechanically zero pointer with a fine screwdriver.
4. With AVC on and the ANT. terminals shorted, adjust the pointer to zero with ZERO ADJ potentiometer R19.

DETECTOR AND NOISE LIMITER

One section of the 6BJ7 tube, V7, is used for the second detector and AVC system for the IF amplifier. This system produces a minimum of distortion.

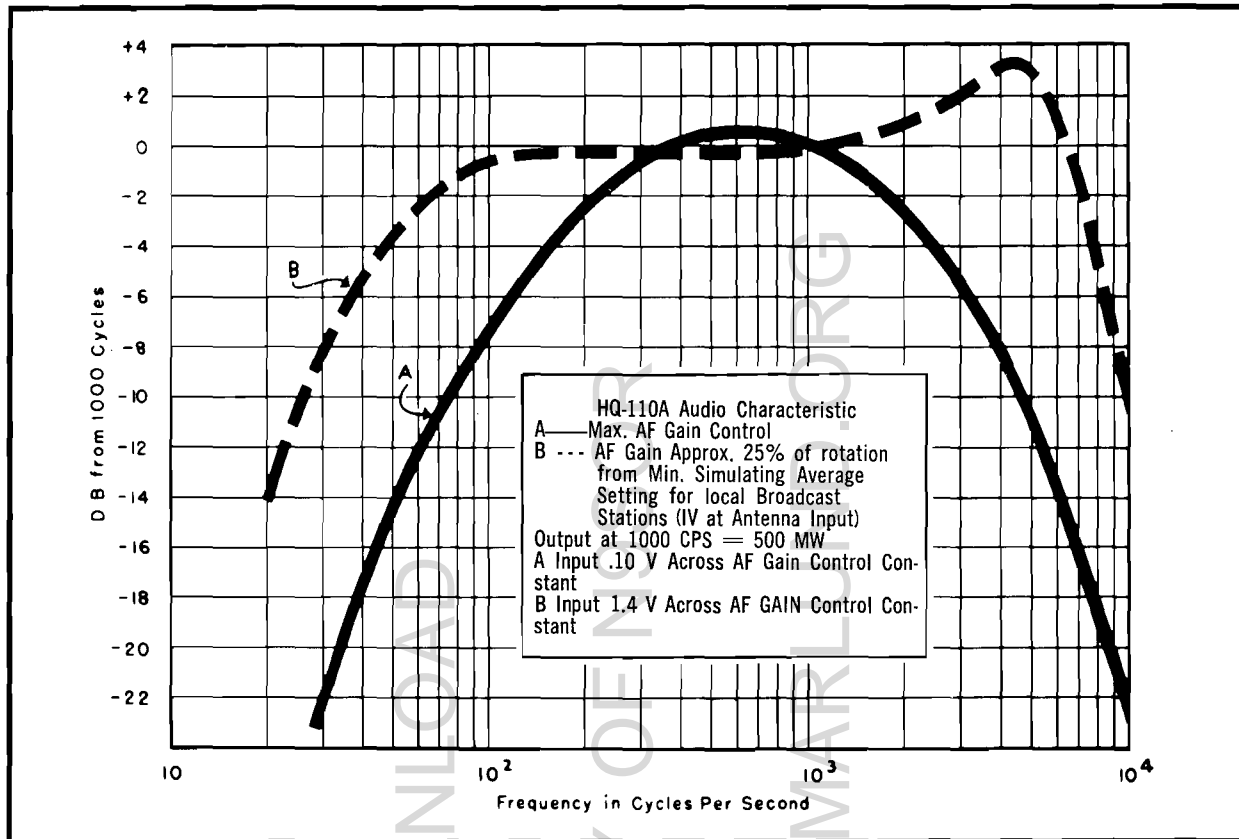
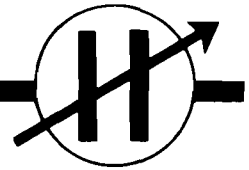

Figure 6. Auto-Response Curve

One section of the V7 operates as a series, self-adjusting noise limiter. It will reduce automobile ignition and other types of impulse noise to a minimum.

Intelligibility is not affected by the noise limiter, although it may be switched off if desired. The third section of the V7 provides delayed AVC for the RF amplifier tube.

BEAT FREQUENCY OSCILLATOR (BFO)

The triode section of the (6AZ8) V6B is used for the beat frequency oscillator. The CW PITCH control is used to vary the beat tone. Each calibration division of this control represents approximately 1000 cycles. When receiving single side band transmission, the generally accepted procedure of setting the beat frequency oscillator approximately 2000 cycles above or below zero beat should be employed. In other words, if the beat frequency oscillator CW PITCH control is set two degrees clockwise or counterclockwise from the center position, optimum single side band reception will usually be obtained. Whether the beat frequency oscillator control will

be set clockwise from zero beat will depend on whether upper or lower side band is being transmitted. If the beat frequency oscillator is on the wrong side of zero beat, it will be impossible to obtain intelligibility of the single side band signal when the dial is tuned very slowly through the single side band signal. Should such a condition arise, merely rotate the CW PITCH control from the two degrees counterclockwise to the two degrees clockwise position and then very carefully adjust the tuning for intelligible speech. Here again experience is the best teacher. The stability of both the high frequency oscillator employed in this receiver plus the excellent mechanical rigidity will provide excellent single side band reception. Refer to the above paragraph on the Q-Multiplier for improved single side band reception.

CRYSTAL CALIBRATOR

A (6BZ6) tube, V9, a hermetically sealed quartz crystal unit and associated components, provide a highly stable 100 KC crystal-controlled oscillator.



An adjustable ceramic trimmer capacitor is provided for accurately adjusting the oscillator frequency against an external standard frequency such as WWV. It provides signal markers at 100 KC intervals throughout the tuning range of the receiver.

LINEAR DETECTOR

The pentode section of the (6AZ8) V6A functions as a linear detector for CW and SSB reception, resulting in a clear undistorted beat note on CW and

greater ease of tuning and freedom from interference on SSB reception.

AUDIO AMPLIFIER

The first audio stage is a resistance coupled voltage amplifier employing the other section of the (12AX7) V4B. The audio output stage is a (6AQ5) beam power amplifier, V8, providing an undistorted output level of at least one watt.

SUGGESTED PROCEDURE FOR ELIMINATING COMMON TROUBLES

1. Most of the trouble that has developed has been due to one or more defective tubes. In the event your receiver has excessive hum or erratic "S" meter operation, the two tubes most likely to cause this condition is V7 in the schematic diagram on Page 19 of our Instruction Manual, this is a 6BJ7 or V6A, the 6AZ8 tube type may also develop internal shorts.
2. Failure of the "Q" multiplier to operate properly or another possible source of excessive hum may be due entirely to the 12AX7, V4A and V4B, since this is a combined "Q" multiplier tube and first audio amplifier. Please do not rely too much on testing the tubes in a tube tester unless they are completely dead, when internal shorting occurs, there is a possibility that a tube tester will not prove reliable. This is due to the fact that most tube testers do not provide a means of testing excessive heater to cathode leakage, which is the most common cause of hum complaints. It is therefore, suggested that any suspicious tube be replaced with a new one, since this is by far the best method of definitely eliminating this possible cause of complaint.
3. Excessive oscillator drift which would be most noticeable on all of the high frequency bands plus a microphonic condition is usually the result of a poor type 6C4 high frequency oscillator or V10 in the schematic diagram. This tube is also capable of producing a poor beat note that may have a ripple in it, especially noticeable on the high frequency bands.
4. Excessive drift can also be attributed to a poor 6BE6 employed in position V2. In addition, the 6BE6 employed in V2 can also cause hum modu-

lation which will be most noticeable on the two high frequency bands. Sometimes merely interchanging the 2 6BE6 tubes employed in Positions V2 and V3 may produce a noticeable improvement. If this is not the case, we would suggest the purchase of another 6BE6.

5. It is normal for less output to be obtained in the CW/SSB position than in the Receive or Calibrate position. To compensate for the slight loss in level, merely advance the audio control should this be required.

CALIBRATION COMPLAINTS:

Please remember that the 100 kc calibrator was built into the HQ-110A receiver as a means of detecting dial error. The incorporation of the 100 kc crystal oscillator does not mean that you will find the 100 kc markers exactly at 100 kc intervals, insofar as dial reading are concerned. Obviously, if the 100 kc calibrator would line up at each of the 100 kc dial markers, there would be no point in incorporating the 100 kc crystal calibrator. Dial error in the order of 5 to 10 kc for the lower frequency bands, and 25 to 50 kc error on the 10 and 6 meter bands, is within our production tolerance. The procedure for correcting frequency deviations in excess of those previously specified will usually involve only a minor adjustment of the high frequency oscillator trimmer capacitor.

Please refer to Pages 11 thru 14 of your instruction manual where the various alignment points are clearly indicated. All of the oscillator trimmer adjustments are clearly marked in figure 8, and obviously the proper trimmer for the particular band is the only adjustment to make. Please be sure, therefore, before attempting to make minor frequency

(Continued on page 20)



SERVICE AND ALIGNMENT PROCEDURE

NOTE

Before servicing this receiver, disconnect from power source and remove all lead-wires attached to terminal connections at rear of chassis apron. Carefully turn the receiver up onto the front panel face on a smooth clean surface. Remove the two No. 10 hex machine screws at the extreme ends of the chassis apron at the rear of the cabinet, and the knob from the clock adjustment shaft if receiver is so equipped. Lift cabinet straight up and off of chassis. To reassemble, use reverse procedure.

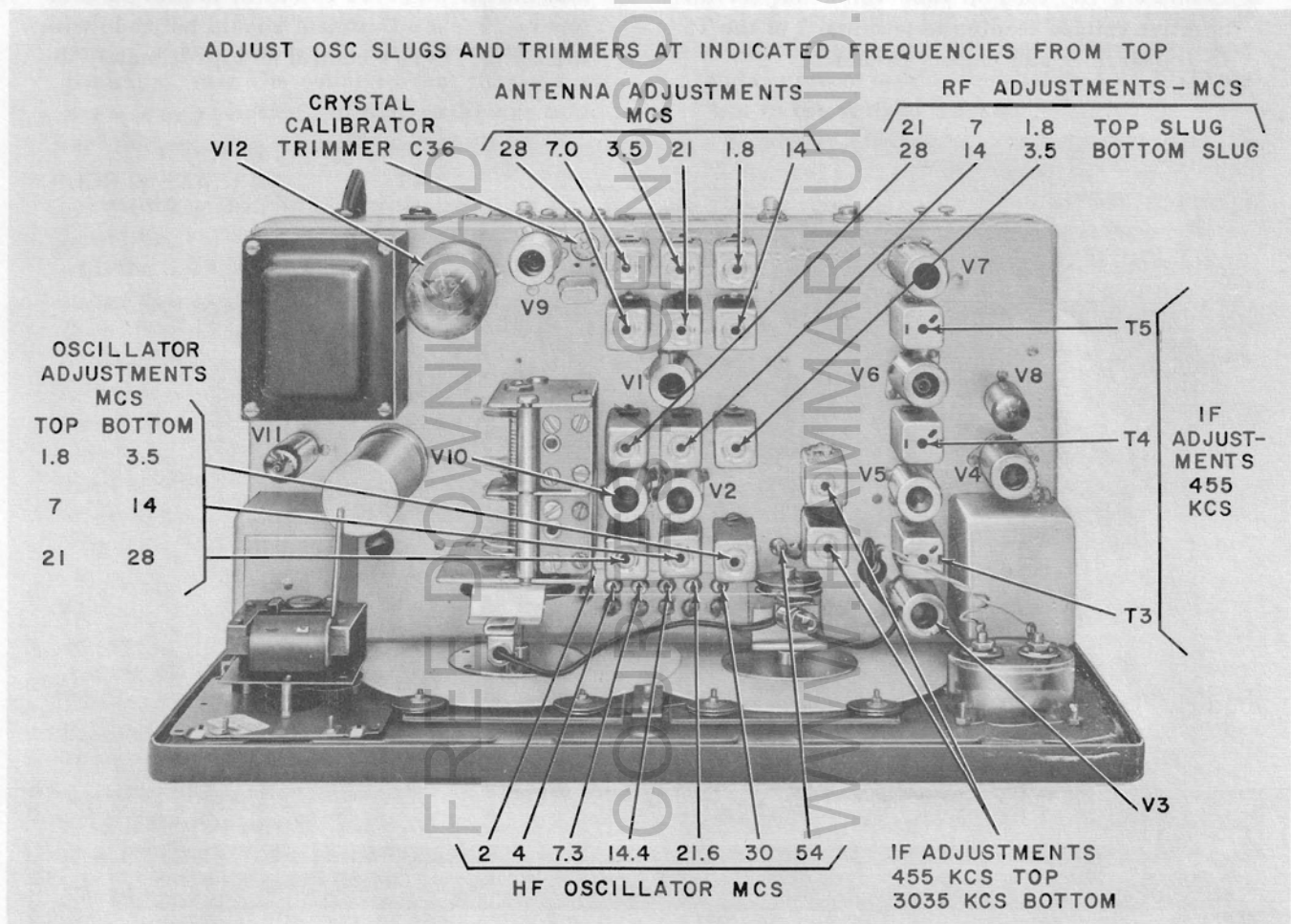



IF ALIGNMENT

Note

Use a non-metallic alignment tool such as General Cement Co. No. 5097, or equal.

- a. Connect the output cable of a 455 KCS unmodulated, signal generator to the bus lead of the (6BE6) V2 mixer grid. The frequency accuracy of the generator may be checked with sufficient precision by picking up its second harmonic (910 KCS) in any receiver whose calibration at 910 KCS has been checked as correct and then adjusting the generator frequency.
- b. Connect a DC vacuum tube voltmeter, set for negative voltage reading to terminal 2 of the T5 IF transformer and chassis ground.

- c. Set the receiver controls as follows:

CAL SET control on marker
 FUNCTION switch on REC.
 Tuning dial on 1.8 mc
 Noise limiter (LM) switch on OFF
 AUDIO GAIN control at minimum
 SELECTIVITY control OFF
 TUNING RANGE switch on 1.8 - 2.0 mc
 MAN - AVC switch on MAN.
 SENSITIVITY control on 3 from maximum

- d. During alignment, adjust the generator output and the SENSITIVITY control to prevent overloading. Final adjustment should be made with the SENSITIVITY control at approximately the

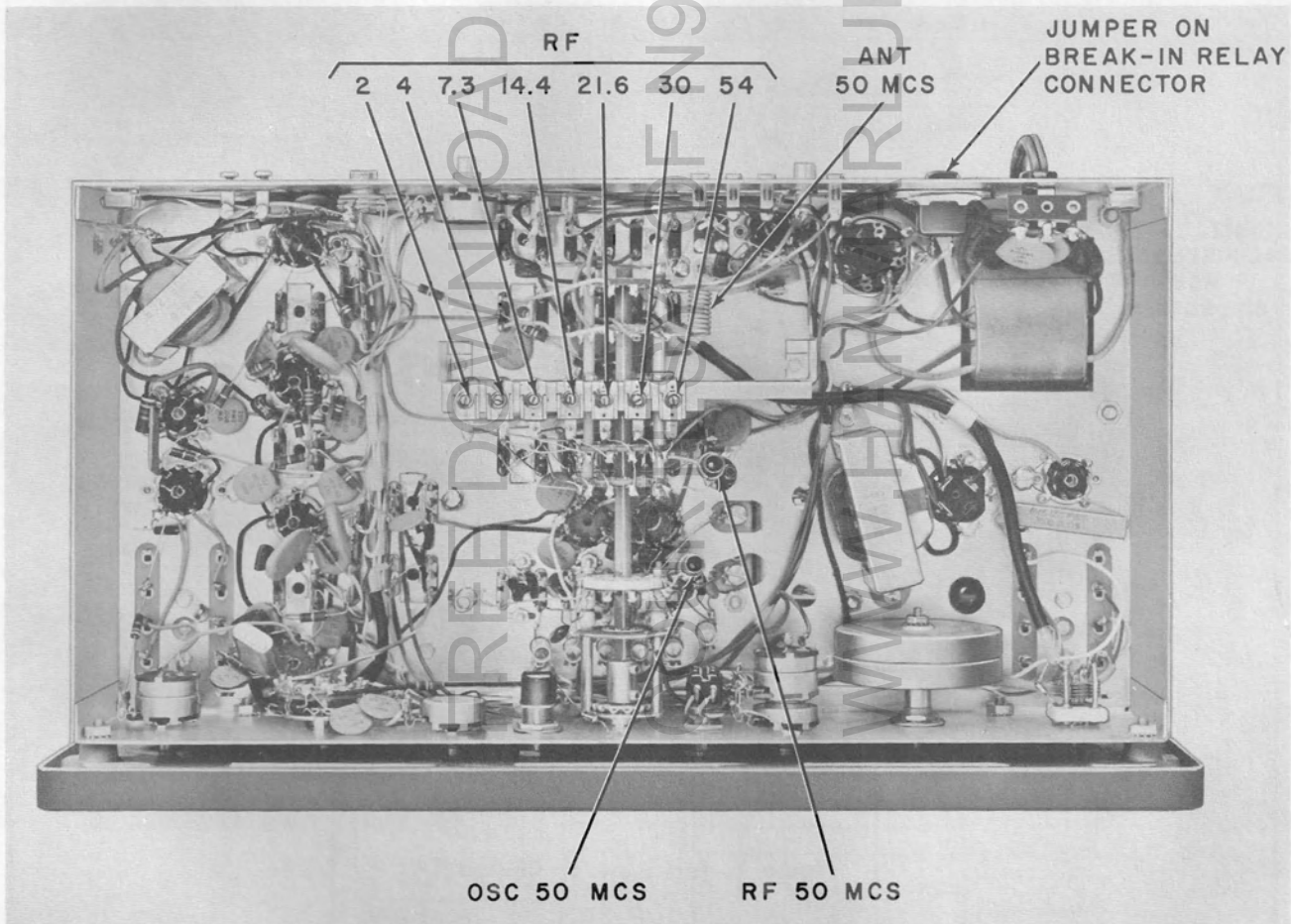
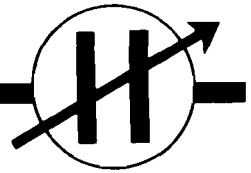

Figure 8. Bottom View of Chassis



- third indice from its maximum (clockwise) position. Adjust each of the three IF transformers, T3, T4 and T5, for maximum meter reading. Topside adjustments are secondaries or grid circuits; bottom of chassis adjustments are primary or plate circuits. Adjust the top slugs of T1 and T2 for maximum Meter Reading.
- e. Turn the SELECTIVITY control clockwise to a position below the oscillating point. With its collar set-screw loosened to permit the frequency shaft to turn without hindrance by the stop, adjust the **FREQ.** control to obtain a maximum meter indication. The input signal must be adjusted to a value just sufficient to obtain a good meter swing. This adjustment is the center frequency of the pass band. While the meter is at maximum, turn the collar so that the long set screw is in a position 180 degrees directly opposite the stop lug. Holding it in this position, tighten the set screw, making sure that the shaft has not turned by checking the zero setting.
 - f. Turn the **FUNCTION** switch to **CW-SSB** and with the **CW PITCH** control stop collar loosened, adjust the **CW PITCH** control for zero beat. Turn the collar so that the long set screw is in a position 180 degrees from the stop lug. Holding it in this position, tighten the set screws, making sure that the shaft has not turned from the zero beat position.
 - g. Turn the **FUNCTION** switch to **REC** and the other controls as shown under "c." Set the **TUNING RANGE** switch to 7.0 - 7.3 MCS. Set the unmodulated signal generator frequency to 3035 KCS. Using a non-metallic alignment tool, such as General Cement Co. No. 8282, or equal, adjust the bottom cores of the transformers T1 and T2 for maximum meter reading. During this alignment, adjust the generator output and the **SENSITIVITY** control to prevent overloading.
 - h. With the **MAN - AVC** switch on **AVC**, the **SENSITIVITY** control at maximum, with grid, pin 1, of the V1 amplifier tube grounded, and with no signal input, adjust the **METER ZERO ADJUST.** potentiometer at the rear of the chassis for a reading of zero on the "S" meter.
- b. All RF and oscillator slug adjustments are made from the top of the shield cans. 50-54 mcs, RF coils do not have slugs. The RF coil of this band is "knifed" for adjustment of inductance. A slight spreading of the turns decreases the inductance. Pushing the turns slightly closer together increases the inductance. The OSC coil slug for this band is at the underside of the chassis.
 - c. Connect the unmodulated, signal generator output cable to the antenna and ground terminals of the receiver, with the A terminal adjacent to the G terminal jumped together. Leave the vacuum-tube voltmeter connected as for IF alignment.
 - d. Set the controls the same as for IF alignment, "c." above. Adjust the **SENSITIVITY** control as required to obtain a sufficient voltmeter reading and to prevent overloading. Set the **CAL SET** control to the vertical marker.
 - e. The oscillator adjustment is made first. The RF is adjusted next to obtain maximum amplitude. The antenna slugs are adjusted last. A certain amount of interaction will occur between the oscillator and RF adjustments, particularly on the higher frequency bands. Final adjustment should be accomplished by combined or alternate adjustment of the oscillator and RF for maximum amplitude.

Note

The trimmer adjustments, if required, should be the final adjustments for each band.

- f. Note that the oscillator frequency in the HQ-110A is on the high side of the signal frequency, except on the 6 meter band, 50-54 mcs, where it is on the low side of the signal. Therefore, it is necessary to make sure that the oscillator frequency is not adjusted below the signal frequency which would be an image response of the signal on all bands except 50-54 mcs where the reverse is true.
- g. It will be necessary to repeat low and high end alignment adjustments of each band since the adjustments are interdependent. The process should be repeated until maximum amplitude is obtained at both alignment frequencies of each band.
- h. On the 6-meter band, a shift in oscillator frequency occurs upon replacing the receiver in the cabinet, with the result that the dial reads approximately 50 KCS, or one division low. This condition may be corrected as follows:
 - (1) After alignment in the normal manner with the receiver out of the cabinet, adjust the

RF ALIGNMENT

Note

Use a non-metallic alignment tool such as General Cement Co. No. 8282, or equal.

- a. The slugs and trimmers, having been factory adjusted, should require a minimum amount of adjustment for any realignment.



slug of T23, the 6-meter oscillator coil, until a 50.00 KCS signal is received at approximately 50.05 on the dial.

- (2) Place the chassis in the cabinet, or place a metal plate (such as a cookie sheet) over the bottom of the chassis. The dial reading should be approximately correct. If it is not, readjust the slug of T23 as required.

Note

The receiver should be warmed up at least one-half hour before final oscillator frequency adjustments are made for the dial calibration check.

CALIBRATOR ALIGNMENT

The crystal calibrator is factory adjusted to zero-beat with the Bureau of Standards Radio Signal WWV. If minor adjustments are determined neces-

sary, to re-zero the calibrator, an external receiver capable of receiving station WWV on any one of its operating frequencies is necessary since the tuning bands of HQ-110A do not include any one of these frequencies.

To re-zero the calibrator, connect A wire to the antenna terminal of the HQ-110A farthest away from the ground terminal. The other end of this wire is connected to the antenna terminal of the receiver used for Heterodyning. During this procedure the link between the ground terminal and nearest antenna terminal of HQ110A should be open, to improve the output of the calibrator into the heterodyning receiver. Tune in a strong signal on any one of the WWV frequencies and zero-beat the calibrating oscillator with WWV by slowly rotating ceramic trimmer C-36 at the top rear of the chassis.

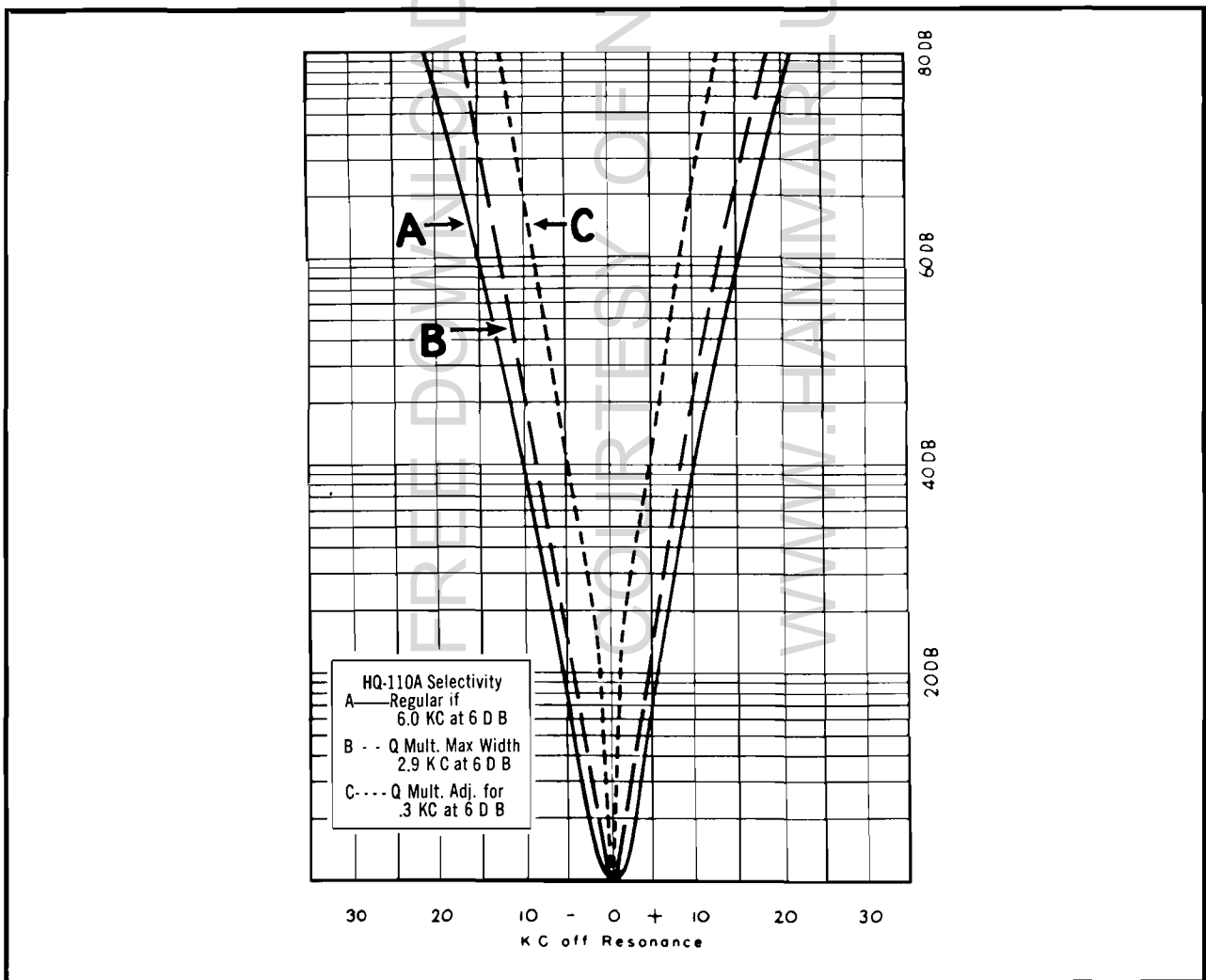

Figure 9. Selectivity Curves

TABLE 1. TUBE SOCKET VOLTAGES

Measured from tube socket pins to chassis with vacuum tube voltmeter. AUDIO GAIN minimum. BAND SELECTOR on 7.0 - 7.3 MCS. Noise Limiter OFF. MAN-AVC on MAN. SENSITIVITY Control maximum except where noted. Function switch on CW-SSB, except where noted. SELECTIVITY control ON but counterclockwise. Line voltage 117. No signal input.

SOCKET PIN NUMBERS									
TUBE	1	2	3	4	5	6	7	8	9
V1 RF 6BZ6	—	1.4 4.2 Sens Min	—	6.3 ac	235	105	—	—	—
V2 MIXER 6BE6	Approx. — 4.8	1.9	—	6.3 ac	215	105	—	—	—
V3 CONVERTER 6BE6	— 3.2	—	—	6.3 ac	233	82	—	—	—
V4 Q-MULT-1st AF 12AX7	233	—	2.5	6.3 ac	6.3 ac	88	—	8	—
V5 1st IF 6BA6	—	—	6.3 ac	—	230	105	2.3 68 (SENS MIN)	—	—
V6 LIN DET-2nd IF BFO 6AZ8	200	145	2.75 68 (SENS MIN)	6.3 ac	—	—	0	67	Approx. — 4.6
V7 DET-LIM-AVC 6BJ7	—	— .6 ON REC	—	6.3 ac	—	—	2.2 on REC	— .34 on REC	— .34 on REC
V8 AF OUTPUT 6AQ5	—	13.2	6.3 ac	—	260	240	—	—	—
V9 CALIBRATOR 6BZ6	— 12 to — 58 on CAL	9.2 on CAL	—	6.3 ac	105 to 84 on CAL	91 to 82 on CAL	9.2 on CAL	—	—
V10 HF OSC 6C4	100	—	—	6.3 ac	—	Approx. — 6	—	—	—
V11 VOLTAGE REG. OB2	105	—	—	—	105	—	—	—	—
V12 RECTIFIER 5U4-GB	—	270	—	235 ac	—	235 ac	—	270	—

TABLE 2. TUBE SOCKET RESISTANCES

Measured from tube socket pins to chassis with vacuum tube ohmmeter with pin 1 of V6, 6AZ8, temporarily grounded except as noted. AUDIO GAIN ON but counterclockwise; Noise Limiter switch ON; SENSITIVITY control maximum except where noted; MAN - AVC on MAN; FUNCTION switch on CW-SSB except where noted; TUNING RANGE on 7.0 - 7.3 MCS.

TUBE	SOCKET PIN NUMBERS								
	1	2	3	4	5	6	7	8	9
V1 RF 6BZ6	470K	180 1.7K Sens Min	0	—	4.7K	8.7K	0	—	—
V2 MIXER 6BE6	22K	160	0	—	15K	8.7K	0	—	—
V3 CONVERTER 6BE6	22K	1.6	0	—	5.7K	12K	0	—	—
V4 Q MULT-1st AF 12AX7	5.7K	2.2 Meg	14.3K 4.3K Sel max	—	—	505K	1 Meg	2.2K	0
V5 1st IF 6BA6	100K	0	—	0	5.7K	8.7K	150 10K Sens min	—	—
V6 LIN. DET-2nd IF BFO 6AZ8	4.7K*	38K	200 10K Sens min	—	0	100K 110K Sens min	0	52K	47K
V7 DET-LIM-AVC 6BJ7	0	195K	0	—	0	470K ON AVC	4.7K	2.2 Meg	2.2 Meg
V8 AF OUTPUT 6AQ5	500K	430	—	0	5.3K	4.7K	500K	—	—
V9 CALIBRATOR 6BZ6	470K	4.7K	0	—	Inf 475K on Cal	Inf 105K on Cal	4.7K	—	—
V10 HF OSC 6C4	9.7K	—	0	—	—	47K	0	—	—
V11 VOLTAGE REG. OB2	8.7K	—	—	—	8.7K	—	0	—	—
V12 RECTIFIER 5U4-GB	—	5.1 K	—	60	—	63	0	5.1K	—

Note* With pin 1 of V6 ungrounded and with pin 6 of V8, 6AQ5 grounded.

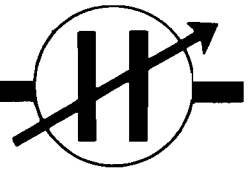

HQ-110A PARTS LIST

SCHEMATIC DESIGNATION	DESCRIPTION	HAMMARLUND PART NO.
CAPACITORS		
C1	Variable, Tuning	T41604-5
C2	Temp. Comp. Disc. 110 MMF, N750 ±5%, 1000V.	K23010-5
C3, 4, 5, 6, 7 C8	Disc. Ceramic .01 MF +80 -20%, 600V.	M23034-19
C8	Temp. Comp. Disc. 110 MMF, N750 ±5%, 1000V.	K23010-5
C9, 10, 11, 12	Disc Ceramic .01 MF +80 -20%, 600V.	M23034-19
C13	Dur-Mica DM-15 20 MMF ±.5 MMF, 500V.	K23006-17
C14	Dur-Mica DM-19 560 MMF ±5%, 500V.	K23027-6
C15	Dur-Mica DM-20 3300 MMF ±5%, 500V.	K23041-2
C16	Dur-Mica DM-19 1100 MMF ±2%, 500V.	K23027-2
C17	Dur-Mica DM-19 510 MMF ±5%, 500V.	K23720-3
C18, 19	Disc Ceramic .01 MF +80 -20%, 600V.	M23034-19
C20, 21	Disc Ceramic .04 MF +80 -20%, 600V.	M23034-12
C22, 23, 24	Disc Ceramic .01 MF +80 -20%, 600V.	M23034-19
C25	Disc Ceramic .04 MF +80 -20%, 600V.	M23034-12
C26, 27	Disc Ceramic .01 MF +80 -20%, 600V.	M23034-19
C28	Disc Ceramic .01 MF GMV, 1000V.	M23034-20
C29, 30, 31, 32	Disc Ceramic .01 MF +80 -20%, 600V.	M23034-19
C33	Disc Ceramic .005 MF GMV, 1000V.	M23034-10
C34	Disc Ceramic .01 MF +80 -20%, 600V.	M23034-19
C36	Variable, Trimmer 8-50 MMF	K23038-5
C37	Dur-Mica DM-15 100 MMF ±10%, 500V.	K23006-1
C39	Variable, Antenna Tuning 3-2-25.0 MMF	K34454-G24
C40, 41	Mica Trimmer, 3-35 MMF	K23043-5
C42, 43, 44, 45, 46	Mica Trimmer, 1.5-20 MMF	K23043-6
C48	Dur-Mica DM-15 24 MMF ±.5 MMF, 500V.	K23006-48
C49, 50, 51	Variable, Trimmer 1-8 MMF	K23008-2
C52	Dur-Mica DM-15 243 MMF ±5%, 300V.	K23006-27
C53	Temp. Comp. Disc, 15 MMF N330 ±5%, 1000V.	K23010-42
C54	Variable, Trimmer 1-8 MMF	K23008-2
C55	Temp. Comp. Disc, 35 MMF N330 ±5%, 1000V.	K23010-44
C56	Variable, Trimmer, 1-8 MMF	K23008-2
C57	Temp. Comp. Disc. 15 MMF N330 ±5%, 1000V.	K23010-42
C58	Variable, Trimmer 1-8 MMF	K23008-2
C59	Temp. Comp. Disc. 4.7 MMF N750 ±5%, 1000V.	K23010-6
C60	Variable, Trimmer 1-8 MMF	K23008-2
C61	Dur-Mica DM-15 7 MMF ±.5 MMF, 500V.	K23006-24
C62, 63	Dur-Mica DM-15 47 MMF ±.5 MMF, 300V.	K23006-47
C64	Dur-Mica DM-15 100 MMF ±10%, 500V.	K23006-1
C65	Disc Ceramic .01 MF +80 -20%, 600V.	M23034-19
C66, 67	Dur-Mica DM-30 4300 MMF ±5%, 500V.	K23042-2
C68	Dur-Mica DM-19 510 MMF ±5%, 500V.	K23027-3
C69	Dur-Mica DM-15 3 MMF ±.5MMF, 500V.	K23006-18
C70	Disc Ceramic .01 MF +80 -20%, 600V.	M23034-19
C71, 72	Disc Ceramic .01 MF GMV, 1400V.	M23034-26
C73, A, B, C	Electrolytic, 60, 40 MF 450V, 25 MF 50V.	K15504-64
C74	Dur-Mica DM-15 56 MMF ±.5 MMF, 500V.	K32006-67
C75	Dur-Mica DM-15 66 MMF ± 3%, 300V.	K23006-113
C77	Dur-Mica DM-15 47 MMF ±.5 MMF, 300V.	K23006-47
C78	Dur-Mica DM-15 2 MMF ±.5 MMF, 500V.	K23006-37
C79	Temp. Comp. Disc 4.7 MMF N470 ±5%, 1000V.	K23010-8
C80	Dur-Mica DM-19 2100 MMF ±2%, 500V.	K23027-13
C81	Temp. Comp. Ceramic 130 MMF N750 ±5%, 1000V.	K23063-92E



HQ-110A PARTS LIST (Continued)

SCHEMATIC DESIGNATION	DESCRIPTION	HAMMARLUND PART NO.
CAPACITORS		
C82	Temp Comp. Disc. 8 MMF N220 $\pm 5\%$, 1000V.	K23010-43
C83	Temp. Comp. Disc. 12 MMF N750 $\pm 5\%$, 1000V.	K23010-19
C84	Dur-Mica DM-15 12 MMF $\pm 5\%$, 500V.	K23006-94
C85	Dur-Mica DM-15 10 MMF $\pm 10\%$, 500V.	K23006-8
C86	Dur-Mica DM-15 24 MMF $\pm .5$ MMF, 500V.	K23006-48
C87	Dur-Mica DM-15 6 MMF $\pm .5$ MMF, 500V.	K23006-63
II, I2	Lamp, Incandescent Pilot No. 47 6.3V, 15A	K16004-1
J1	Phone Jack	K35608-1
J2	Power Outlet, (Relay Jack)	K35013-1
J3	Connector, Female (Pre-Amp Power)	K41138-1
J4	Connector, Female (6M)	K41144-1
COILS		
L1	Coil and Ferrule Assembly.	K26215-G2
L2	RF Choke, 2.5 MHY	K15627-1
L3	BFO Coil and Ferrule Assembly	K38989-G1
L4	Filter Reactor, 8 HY-100 MA, 375 ohms DC	K38939-1
L5	RF Choke, 38 MHY	K15629-1
L6	RF Choke, 240 MHY	K15629-2
M1	Meter, "S" (Carrier Level)	K26149-4
RESISTORS		
(NOTE: ALL RESISTORS FIXED $\pm 10\%$ $\frac{1}{2}$ W. UNLESS OTHERWISE SPECIFIED)		
R1	10 ohms	K19309-1
R2	180 ohms $\pm 5\%$ $\frac{1}{2}$ W.	K19309-260
R3	Variable 1.5K and 10K Dual with R24 and S5	K38940-1
R4	10 ohms	K19309-1
R5	470K	K19309-113
R6	100K	K19309-97
R7	22K	K19309-81
R8	160 Ohms $\pm 5\%$, $\frac{1}{2}$ W.	K19309-199
R9	47K	K19309-89
R10, 11	4300 Ohms $\pm 5\%$, $\frac{1}{2}$ W.	K19309-213
R12	Variable (Selectivity) 10K (with tandem switch S1)	K15378-4
R13	2.2 Meg	K19309-129
R14	1K	K19309-49
R15	100K	K19309-97
R16	1K	K19309-49
R17	150 Ohms $\pm 5\%$, $\frac{1}{2}$ W.	K19309-259
R18	1.2K $\pm 5\%$, $\frac{1}{2}$ W.	K19309-268
R19	Variable, (Meter Adj.) 200 Ohms	K15368-6
R20, 21	100K	K19309-97
R22	33K	K19309-85
R23	4.7K	K19309-65
R24	Variable, 10K (See R3)	
R25	1.0 Meg	K19309-121
R26	2.2 Meg	K19309-129
R27	470K	K19309-113
R28	220K	K19309-105
R29	4.7K	K19309-65
R30	Variable, (Audio) 1.0 Meg	K26218-3
R31	47 Ohms	K19309-17
R32	100 Ohms	K19309-25
R33	2.2K	K19309-57
R34	430 Ohms $\pm 5\%$, 1 W.	K19310-212
R39	100K	K19309-97
R40	160 Ohms $\pm 5\%$, $\frac{1}{2}$ W.	K19309-199
R41	1K	K19309-49
R42, 43	47K	K19309-89
R44	10K	K19309-73

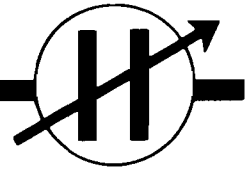

HQ-110A PARTS LIST (Continued)

SCHEMATIC DESIGNATION	DESCRIPTION	HAMMARLUND PART NO.
RESISTORS		
R45	3K \pm 10%, 10 W.	K19337-2
R46	22K	K19309-81
R47	22 Ohms	K19309-9
R48	300K \pm 5%, 1/2 W.	K19309-184
SWITCHES		
S1	Selectivity, (ON-OFF) SPST (Part of R12)	
S2	Limiter, (ON-OFF) SPST	K38857-1
S3	(MAN-AVC) DPST	K38949-1
S4	Function	K38948-1
S5	Line (ON-OFF) SPST (Part of R3)	
S6A	Wafer	K38952-1
S6B, C	Wafer (Shorting)	K38952-2
S6D	Wafer (Shorting)	K38952-3
S6E, F	Oscillator	M39073-1
TRANSFORMERS		
T1, T2	IF, Comp. 3035 and 455 KC	M26402-2
T3	IF, 455 KC	K38992-1
T4	IF, 455 KC	K38829-2
T5	IF, 455 KC	K38829-1
T6	Output, Max PWR 5w, Imp. Match; 10,000 Ohms Pri to 4 Ohms Voice Coil	K38828-1
T7	Antenna Coil Assembly, B and 1, 1.8 to 2.0 MC	K38926-1
T8	Antenna Coil Assembly, Band 2, 3.5 to 4.0 MC	K38927-1
T9	Antenna Coil Assembly, Band 3, 7.0 to 7.3 MC	K38928-1
T10	Antenna Coil Assembly, Band 4, 14.0 to 14.4 MC	K38929-1
T11	Antenna Coil Assembly, Band 5, 21.0 to 21.6 MC	K38930-1
T12	Antenna Coil Assembly, Band 6, 28.0 to 30.0 MC	K38931-1
T13	Antenna Coil Assembly, Band 7, 50.0 to 54.0 MC	K38943-1
T14	Power, Pri; 115V-60 Cycle, Sec; 230-0-230V-110MA	M38938-1
T14 (Export)	Power, Pri; 115-230V-60 Cycles, Sec; 230-0-230V-110MA	M38938-2
T16	RF Coil Assembly, Bands 1 and 2, 1.8-2.0 and 3.5-4.0 MC	K38932-1
T17	RF Coil Assembly, Bands 3 and 4, 7.0-7.3 and 14.0-14.4 MC	K38933-1
T18	RF Coil Assembly, Bands 5 and 6, 21.0-21.6 and 28.0-30.0 MC	K38934-1
T19	RF Coil Assembly, Band 7, 50.0-54.0 MC	K38944-2
T20	HF Osc Coil Assembly, Bands 1 and 2, 1.8-2.0 and 3.5-4.0 MC	K38935-2
T21	HF Osc Coil Assembly, Bands 3 and 4, 7.0-7.3 and 14.0-14.4 MC	K38936-2
T22	HF Osc Coil Assembly, Bands 5 and 6, 21.0-21.6 and 28.0-30.0 MC	K38937-2
T23	HF Osc Coil Assembly, Band 7, 50.0-54.0 MC	K38945-2
TUBES		
V1	Electron, 6BZ6	K16388-1
V2, V3	Electron, 6BE6	K16284-1
V4	Electron, 12AX7	K16300-1
V5	Electron, 6BA6	K16283-1
V6	Electron, 6AZ8	K16394-1
V7	Electron, 6BJ7	K16397-1
V8	Electron, 6AQ5	K16387-1
V9	Electron, 6BZ6	K16388-1
V10	Electron, 6C4	K16288-1
V11	Electron OB2	K16375-1
V12	Electron, 5U4GB	K16215-2
Y1	Crystal, Quartz 2.58 MC	K38972-2
Y2	Crystal, Quartz 100KC	K38661-1
Z1	RC Printed Network (Audio)	K38846-1
Z2	RC Printed Network (Diode Load-AVC-LIM)	K38885-1
Z3	RC Printed Network (Calibrator)	K38981-1



HQ-110A PARTS LIST (Continued)

SCHEMATIC DESIGNATION	DESCRIPTION	HAMMARLUND PART NO.
MISCELLANEOUS ITEMS		
CMC (STD.) CMC (EXPORT)	Clock, Telechron Auto-Timer	K38874-G2
	Clock, Telechron Auto-Timer (115-230V)	K38874-G3
	Crystal, Panel Clock Window	M38877-1
	Knob, 3/4" Dia.	K26216-3
	Clock Shaft	K26379-1
	Snap Button	K29619-9
	Shell	K41140-1
	Connector, Male	K41139-1
	Plug	K35610-1
	Knob, 2" Dia., White Line	K26226-2
	Knob, 3/4" Dia.	K26216-2
	Knob, 1" Dia.	K26224-1
	Knob, 1 1/8" Dia. (Pointer)	K26229-1
	Knob, 2" Dia.	K26226-1
Instruction Manual Issue 1	41383-1	

Continued from page 10

corrections, that the proper trimmer is selected, then make the adjustments very slowly and carefully.

This procedure is only being incorporated in this resume for the experienced amateur operator, in an effort to avoid the return of the receiver with the resultant delay. If you are in the least bit hesitant about making these adjustments, please do not attempt it. We might also point out at this time that any minor adjustments of the oscillator will in no way effect the tracking of the oscillator with the R. F. and mixer circuits involving complete realignment of the front end of the receiver. Complete realignment of the front end should only be attempted when the necessary equipment and knowledge is available.

HAMMARLUND MFG. CO.
MARS HILL, N.C.

MODEL NO. HQ-110A

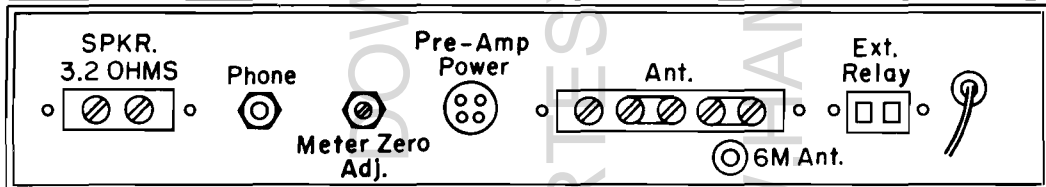
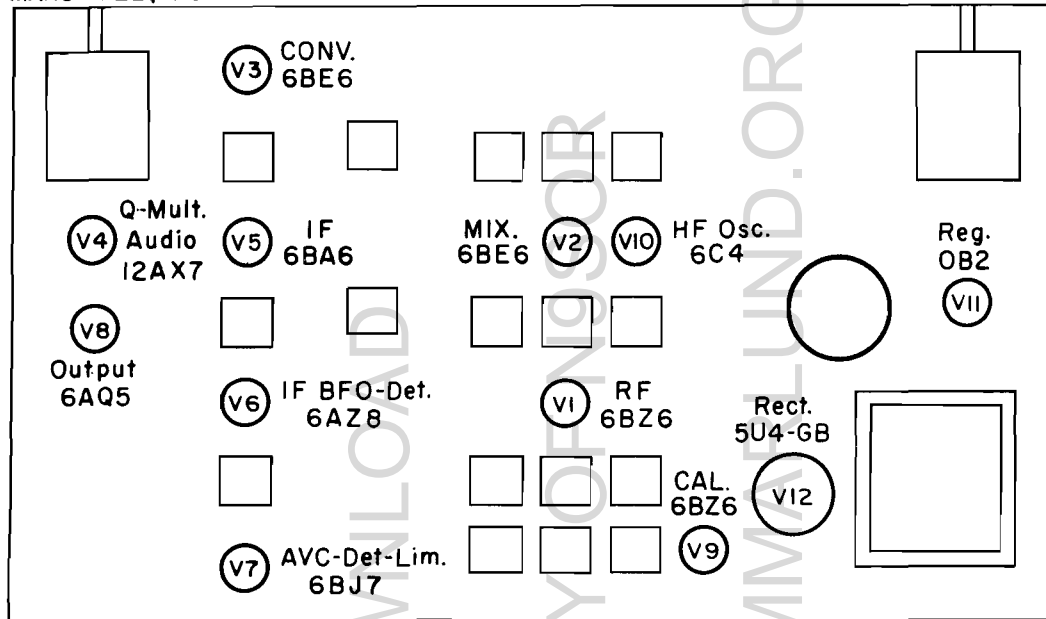

PT. 39118

Component Location Diagram

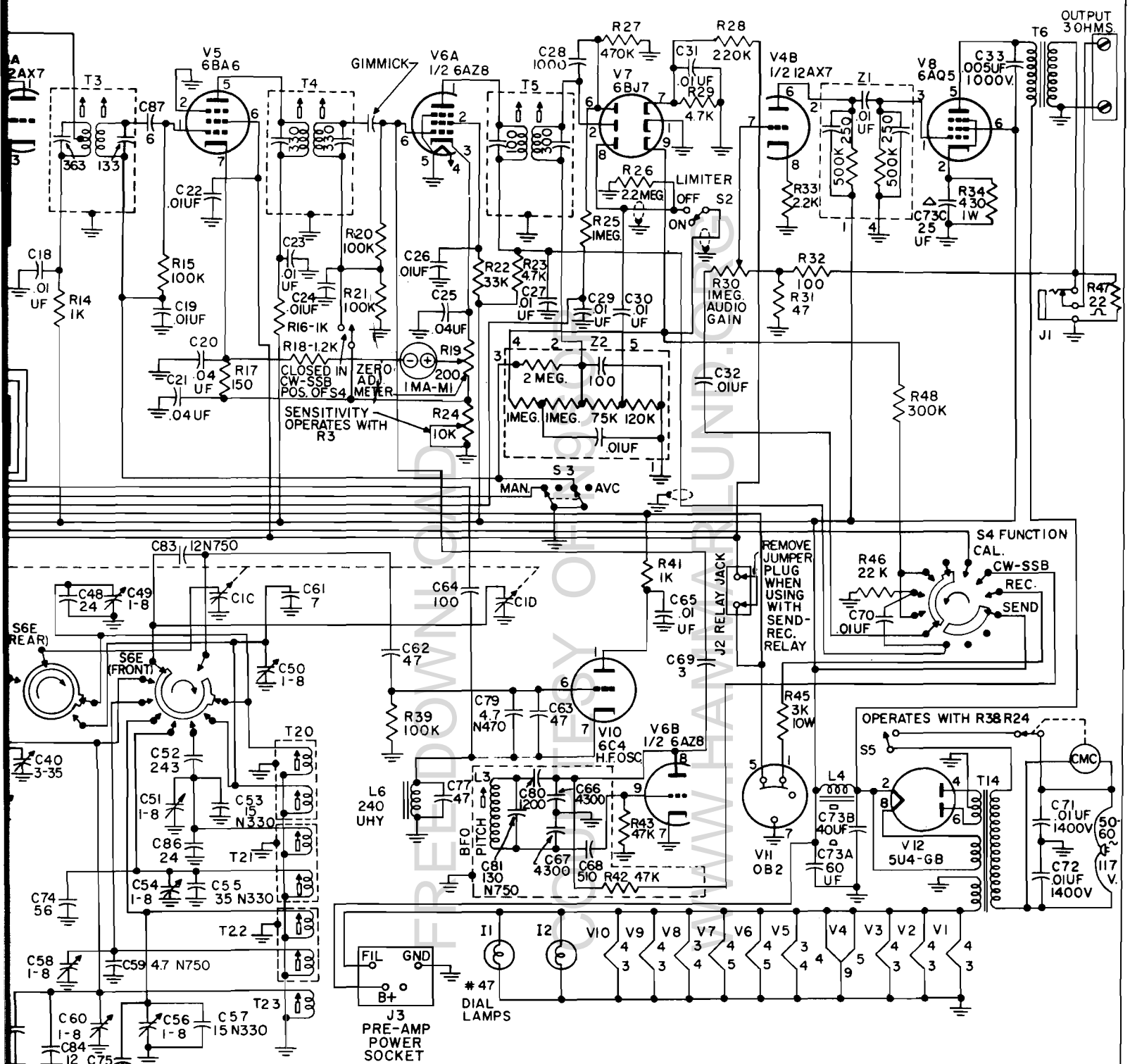

2W AND VALUE IN OHMS. UNLESS
 IN MICRO-MICRO FARADS UNLESS
 D.

Figure 10. Hammarlund HQ-110A Communications Receiver, Schematic Diagram

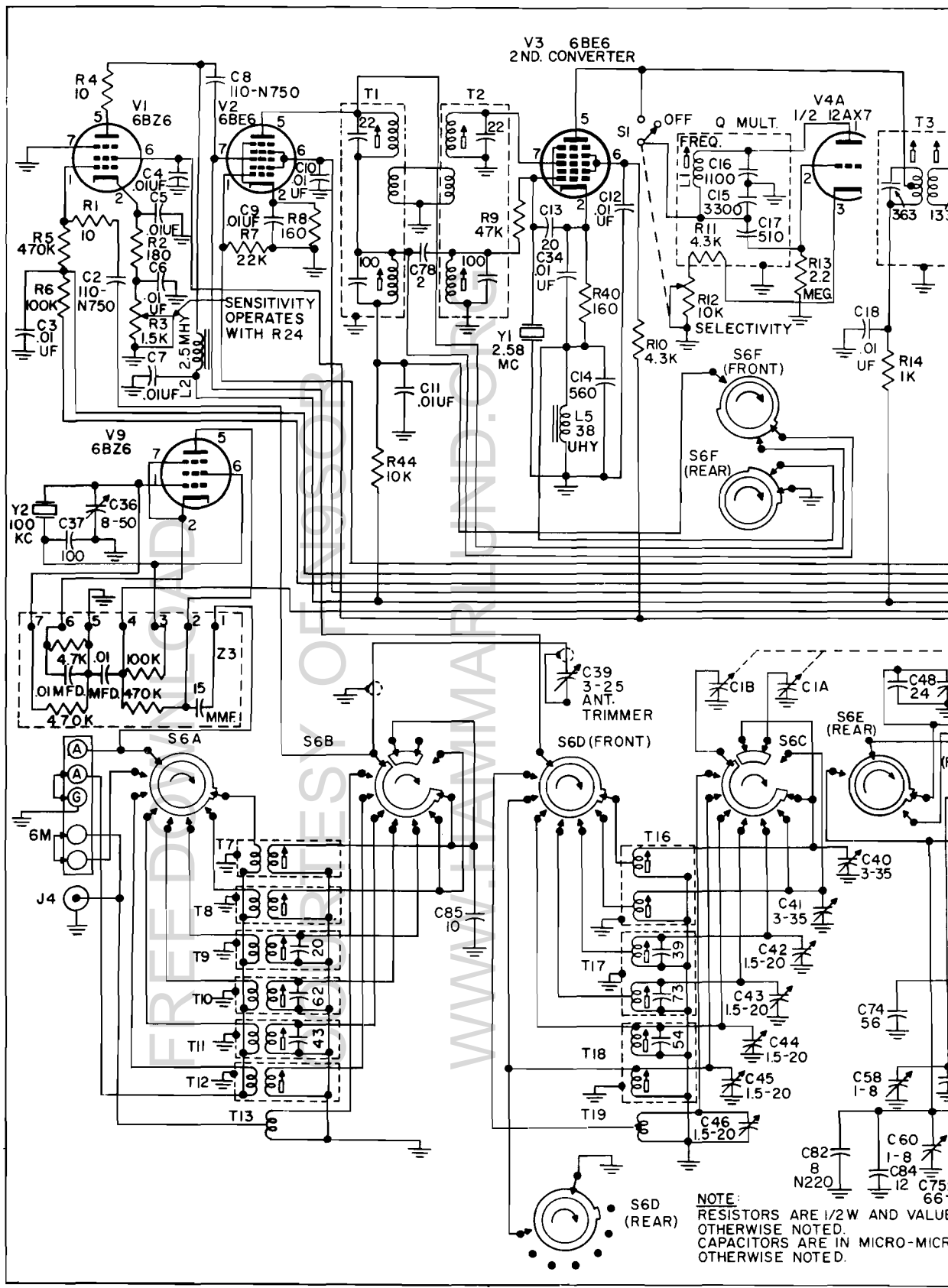

NOTE:
RESISTORS ARE 1/2W AND VALUE OTHERWISE NOTED.
CAPACITORS ARE IN MICRO-MICR OTHERWISE NOTED.

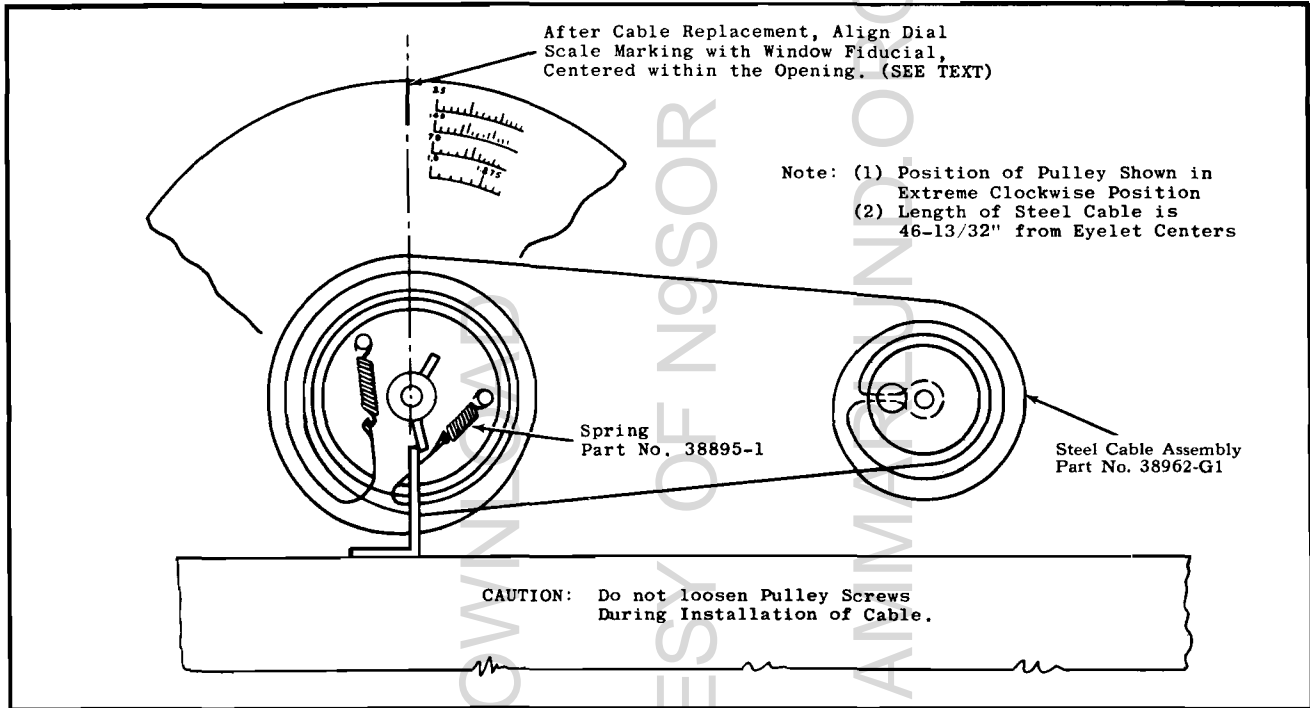
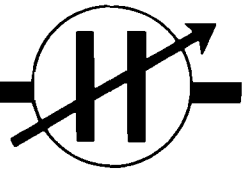

Figure 11. Installation of Dial Cable Assembly

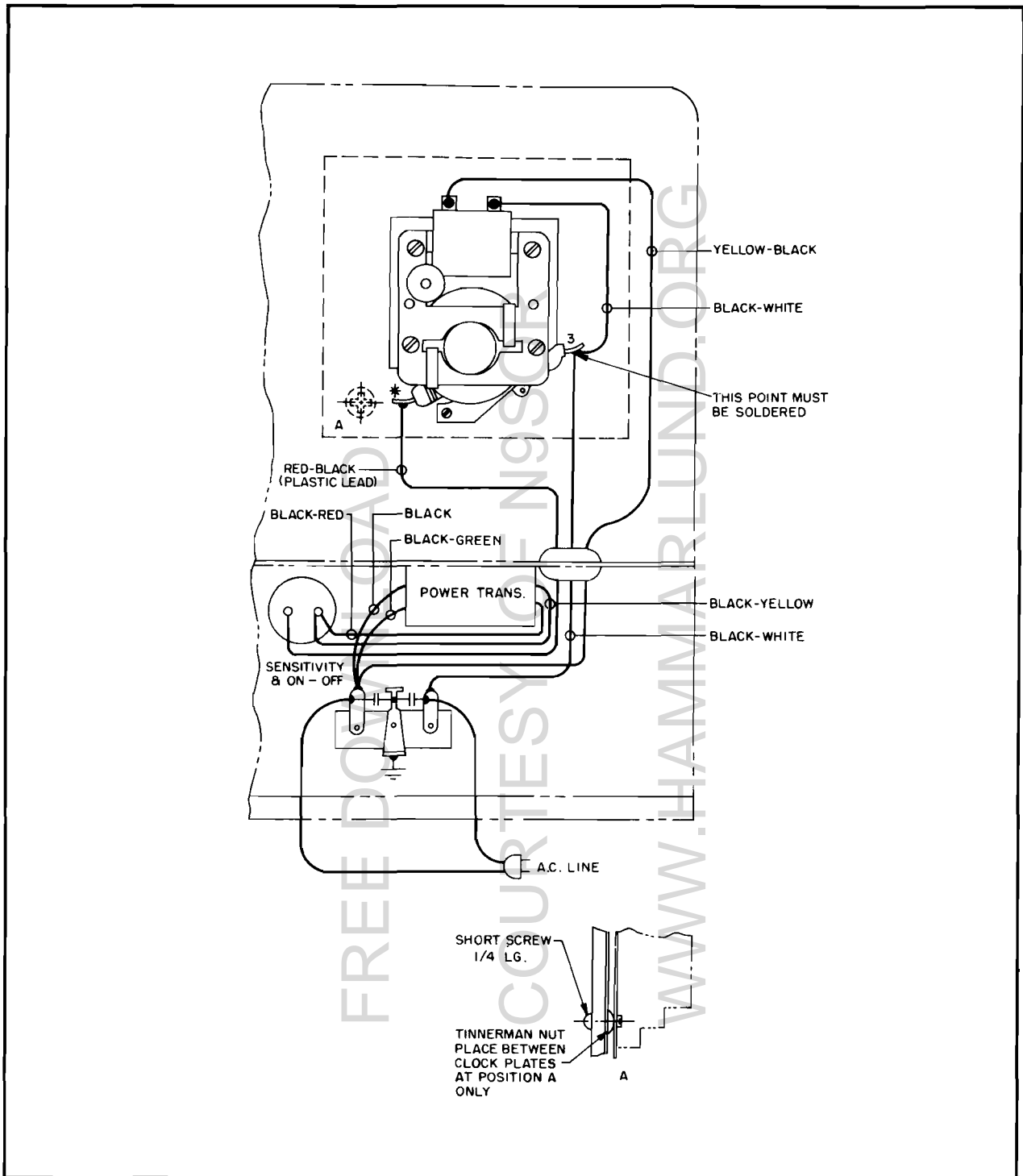

Figure 12. Standard Clock (115V 50 or 60 CPS) Wiring Diagram

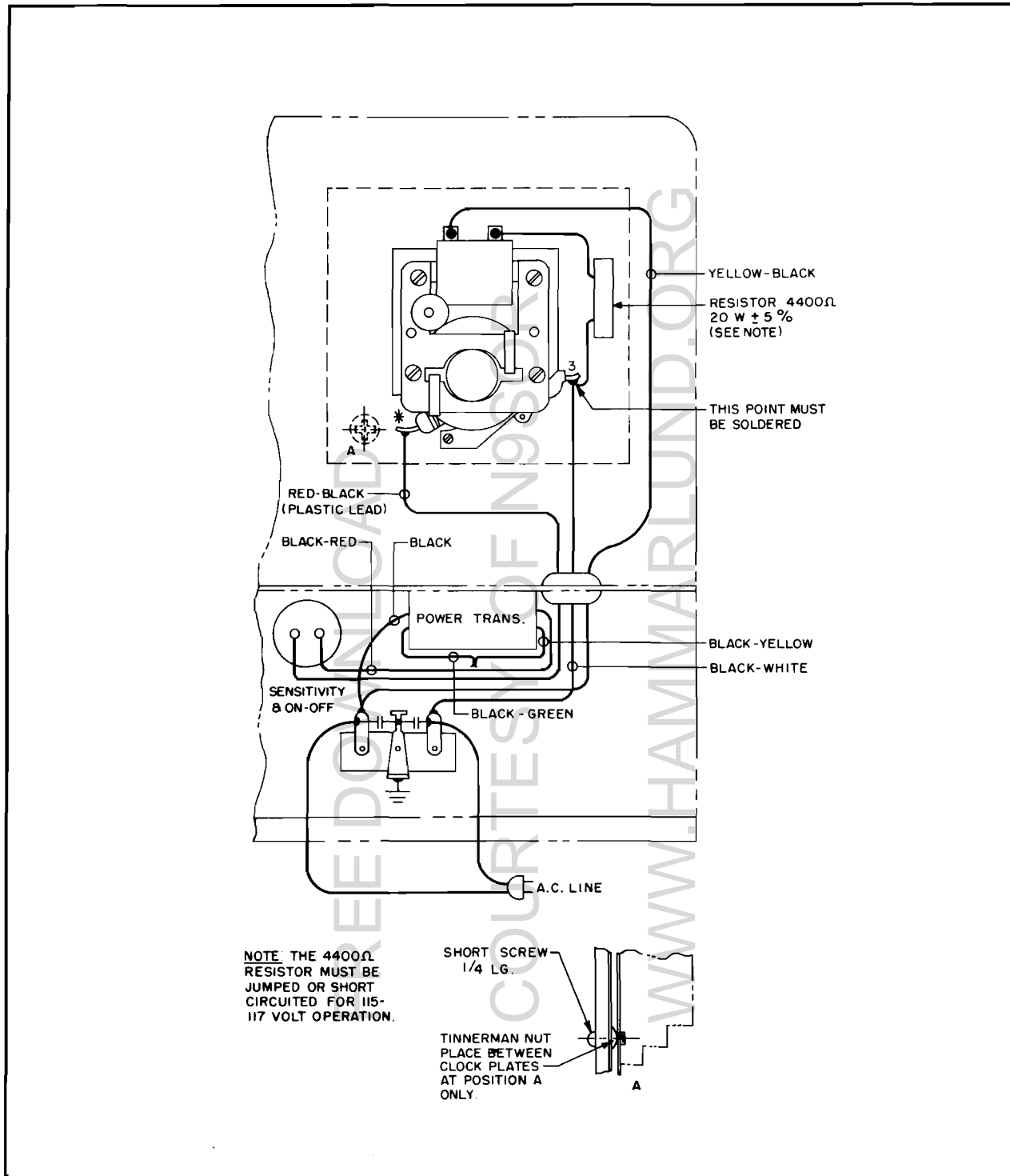

Figure 13. Export Model Clock (230V 50 or 60 CPS) Wiring Diagram



MEMORANDA

FREE DOWNLOAD

COURTESY OF N9SOR

WWW.HAMMARLUND.ORG

THE HAMMARLUND MANUFACTURING COMPANY
Standard Warranty

The Hammarlund Manufacturing Company, warrants this equipment to be free from defects in workmanship and materials under normal and proper use and service for the uses and purposes for which it is designed, and agrees to repair or replace, without charge, all parts thereof showing such defects which are returned for inspection to the Company's factory, transportation prepaid, within a period of 90 days from date of delivery, provided such inspection discloses to the satisfaction of the Company that the defects are as claimed, and provided also, that the equipment has not been altered, repaired, subjected to misuse, negligence or accident, or damaged by lightning, excessive current or otherwise, or had its serial number or any part thereof altered, defaced, or removed. Tubes shall be deemed to be covered by the manufacturer's standard warranty applicable thereto, and such items shall be and are hereby excluded from the provisions of this warranty. Pilot lamps and fuses are not guaranteed for length of service.

Except as herein specifically provided, no warranty, express or implied, other than that of title, shall apply to any equipment sold hereunder. In no event shall the Company be liable for damages by reason of the failure of the equipment to function properly or for any consequential damages.

This Warranty is valid for the original owner of the equipment, and is contingent upon receipt of the Warranty Registration Card by the Company. No equipment shall be returned to the factory for repairs under warranty unless written authorization is obtained by the Company, and the equipment is shipped prepaid by the owner. The Company maintains Authorized Service Stations, names and locations of which will be sent upon request of the owner.

The Hammarlund Manufacturing Company

A *Giannini Scientific Co.*

53 West 23rd Street, New York 10, N. Y.

Export Department: 13 East 40th Street, New York 16, N. Y.



The policy of the Hammarlund Manufacturing Company, is one of continued improvement in design and manufacture wherever and whenever possible, to provide the highest attainable quality and performance. Hence, specifications, finishes, etc. are subject to change without notice and without assumption by Hammarlund of any obligation or responsibility to provide such features as may be changed, added or dropped from previous production runs of this equipment.

Hammarlund Manufacturing Company

A *Giannini Scientific Co.*

53 West 23rd Street, New York 10, N. Y.

Export Department: 13 East 40th Street, New York 16, N. Y.

DO NOT MAKE ANY RETURNS WITHOUT AUTHORIZATION FROM EITHER NEW YORK OFFICE OR FACTORY. ALL AUTHORIZED RETURNS SHOULD BE SHIPPED TO FACTORY, HAMMARLUND MANUFACTURING CO., MARS HILL, NORTH CAROLINA. DO NOT SHIP TO NEW YORK OFFICE.

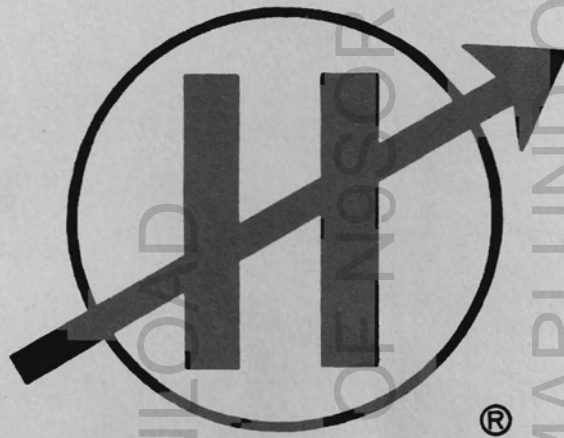

®

ESTABLISHED 1910

FREE DOWNLOAD
COURTESY OF NOSOR
WWW.HAMMARLUND.ORG