

Assembly
and
Operation
of the



75-METER
SSB TRANSCEIVER

Model HW-12A



Scanned by W1ATV

HEATH COMPANY
BENTON HARBOR,
MICHIGAN 49022

TABLE OF CONTENTS

Introduction,	2
Parts List,	3
Step-By-Step Assembly	
Circuit Board Assembly,	6
Parts Mounting-Chassis,	18
Cable Assembly Wiring,	20
Function Switch Wiring,	27
Top Chassis And Front Panel Assembly,	28
Final Wiring-Chassis Bottom,	30
Final Wiring-Chassis Top,	32
Initial Test,	33
Power Supply Connections,	36
Alignment And Adjustment,	39
Final Assembly,	42
Installation,	45
Noise Suppression Troubleshooting Chart,	49
Operation,	50
In Case Of Difficulty,	52
Factory Repair Service,	53
Troubleshooting Chart,	54
Specifications,	56
Circuit Description,	58
Chassis Photographs,	64
Circuit Board X-Ray Views (fold-out from page),	66
Replacement Parts Price List,	67
Schematic,(fold-out from page),	69

INTRODUCTION

The Heathkit Model HW-12A Amateur Transceiver is a 75-meter SSB (single-sideband) transmitter and receiver designed for both mobile and fixed station use. The receiver and transmitter are locked together with a continuously running VFO (variable frequency oscillator) to insure that both sections operate at the same frequency. The low frequency VFO is temperature compensated to provide stable operation.

Provisions have been made for both PTT (push-to-talk) and VOX (voice operated transmitter) operation. Other features include ALC (automatic level control) to prevent the transmitter from overloading, and AVC (automatic volume control) to maintain constant receiver output over a wide range of input signal strength.

An accessory socket is wired into the circuit so the Heathkit plug-in Crystal Calibrator can be used with the Transceiver to provide accu-

rate frequency checks at 100 kHz intervals. A connection on the rear of the Transceiver makes the Transceiver easily usable with linear amplifiers. Power for the Transceiver can be obtained from the Heathkit Model HP-13 (12 VDC) or Model HP-23 (120 VAC Power Supplies). Equivalent power supplies may also be used.

NOTE: This Manual uses the new IEEE (Institute of Electrical and Electronic Engineers) international standard term "hertz" as the basic unit of frequency. The terms are used as follows:

Hz (hertz) = cps (cycles per second).

kHz (kilohertz) = kc (kilocycles per second).

MHz (megahertz) = mc (megacycles per second).

Refer to the "Kit Builders Guide" for complete information on unpacking, parts identification, tools, wiring, soldering, and step-by-step assembly procedures.

PARTS LIST

The key numbers in parentheses in the Parts List are keyed to the numbers on the Parts Pictorial (fold-out from Page 5).

NOTE: When more than one number is on a package, disregard all but the part number, as listed below.

To order replacement parts, refer to the Replacement Parts Price List and use the Parts Order Form furnished with this kit.

PART No.	PARTS Per Kit	DESCRIPTION	PART No.	PARTS Per Kit	DESCRIPTION
RESISTORS			Disc		
1/2 Watt			(5)21-60	7	18 pf
(1)1-1	1	47 Ω (yellow-violet-black)	21-32	6	47 pf
1-3	3	100 Ω (brown-black-brown)	21-49	2	68 pf
1-66	1	150 Ω (brown-green-brown)	21-21	1	200 pf
1-45	5	220 Ω (red-red-brown)	21-13	7	500 pf
1-4	2	330 Ω (orange-orange-brown)	21-35	3	.005 μ fd 1.6 KV
1-9	8	1000 Ω (brown-black-red)	21-57	25	.005 μ fd
1-14	3	3300 Ω (orange-orange-red)	21-31	30	.02 μ fd
1-16	6	4700 Ω (yellow-violet-red)	Mylar*		
1-19	1	6800 Ω (blue-gray-red)	NOTE: Mylar capacitors may be marked with color bands or stamped with the value.		
1-20	9	10 K Ω (brown-black-orange)	(6)27-73	1	.047 μ fd (yellow-violet-orange)
1-22	4	22 K Ω (red-red-orange)	27-85	1	.22 μ fd (wide red-yellow)
1-25	12	47 K Ω (yellow-violet-orange)	27-81	3	.47 μ fd (yellow-violet-yellow)
1-26	11	100 K Ω (brown-black-yellow)	27-47	6	.1 μ fd (brown-black-yellow)
1-29	8	220 K Ω (red-red-yellow)	Other Capacitors		
1-35	11	1 megohm (brown-black-green)	(7)25-54	2	10 μ fd tubular electrolytic
1-37	5	2.2 megohm (red-red-green)	(8)25-135	1	20 μ fd vertical electrolytic
1-70	1	22 megohm (red-red-blue)	(9)26-104	1	Double-section variable
			26-35	1	Single-section variable
Other Resistors			COILS		
(2)1-28-1	1	100 K Ω 1 watt (brown-black-yellow)	NOTE: Some of the coils or transformers may have a plastic insert which can rattle, this is normal.		
3-2-2*	1	.33 Ω 2 watt (orange-orange-silver)	(10)40-509	1	Crystal filter
(3)1-21-2	1	20 Ω 2 watt (red-black-black)	(11)40-516	1	Driver grid
1-17-2	1	6800 Ω 2 watt (blue-gray-red)	40-513	1	Driver plate
1-22-2	2	12 K Ω 2 watt (brown-red-orange)	(12)40-510	1	Final plate
			(13)52-25	1	VFO
*NOTE: This resistor is a 2 watt wire-wound resistor, but is the same size as a 1 watt composition resistor.			CHOKES-TRANSFORMERS		
CAPACITORS			(14)45-58	1	13 μ h bifilar choke
Mica			(15)45-51	1	15 μ h choke
(4)20-96	3	36 pf	(16)45-3	1	1 mh choke
20-102	2	100 pf	(17)45-4	1	1.1 mh choke
20-112	2	310 pf	(18)45-47	1	2 mh choke
20-131	2	360 pf	(19)51-55	1	Audio output transformer
20-122	3	1000 pf	(20)52-63	3	2.305 MHz transformer
20-127	2	1300 pf			

PART No.	PARTS Per Kit	DESCRIPTION	PART No.	PARTS Per Kit	DESCRIPTION
CONTROLS-SWITCHES			CABLE-WIRE-SLEEVING		
(21)10-130	1	200 Ω bushing-mount control	134-140	1	Cable assembly
(22)10-17	1	1 megohm bushing-mount control	343-7	1	Coaxial cable
(23)10-57	2	10 K Ω tab-mount control	344-50	1	Black hookup wire
10-58	1	100 K Ω tab-mount control	344-52	1	Red hookup wire
10-127	2	1 megohm tab-mount control	346-1	1	Small sleeving
(24)12-73	1	1 megohm/25 K Ω dual tab-mount control	346-2	2	Large sleeving (clear)
(25)60-13	2	DPDT slide switch	KNOBS		
(26)63-427	1	5-position rotary with/snap switch	(40)462-7	1	Push-on
CRYSTALS			(41)462-106	1	11/16" diameter
(27)404-196	1	2303.3 kHz	(42)462-191	4	1-1/8" diameter
404-197	1	2306.7 kHz	(43)462-210	1	2" diameter
404-203	Package consisting of the following:		(44)462-218	1	Lever
(28) 404-191	2	2305.100 kHz			
404-192	2	2303.500 kHz			
DIODES-TUBES-LAMPS			GENERAL		
(29)58-26-1	5	Germanium diode (brown-white-brown)	69-34	1	Relay
(30)57-27	5	Silicon diode	73-1	4	Rubber grommet
411-11	5	6AU6 tube	(45)75-52	1	Slide switch insulator
411-91	1	6BE6 tube	85-69-9	1	Circuit board
411-124	3	6EA8 tube	(46)259-20	48	Terminal
411-161	1	6EB8 tube	(47)260-7	1	IF transformer mounting clip
411-185	2	6GE5 tube	(48)261-4	4	Small rubber foot
411-24	1	12AT7 tube	(49)261-9	2	Medium rubber foot
411-69	1	12BY7 tube	(50)261-21	2	Large rubber foot
412-1	2	#47 pilot lamp	407-99	1	Meter
412-11	1	NE2 neon lamp	(51)431-14	2	2-lug terminal strip
CONNECTORS-SOCKETS-PLUGS			(52)435-1	1	11-pin plug mounting ring
(31)432-38	1	Male connector	(53)455-11	1	Split bushing
(32)432-39	1	Female connector	(54)455-52	1	Lever knob bushing
(33)434-42	4	Phono socket	464-29-1	1	Plastic dial
(34)434-44	2	Pilot lamp socket	490-1	1	Alignment tool
(35)434-112	6	7-pin tube socket	490-5	1	Nut starter*
434-105	1	8-pin tube socket	597-308	1	Kit Builders Guide
434-79	6	9-pin tube socket	597-260	1	Parts Order Form
434-140	2	12-pin tube socket	391-34	1	Blue and white label
(36)434-118	2	11-pin tube socket		1	Manual (See front cover for part number.)
(37)438-4	4	Phono plug			Solder
(38)438-29	1	11-pin plug			
(39)440-1	2	11-pin plug cap			

*See Page 3 of the Kit Builders Guide.



<u>PART No.</u>	<u>PARTS Per Kit</u>	<u>DESCRIPTION</u>	<u>PART No.</u>	<u>PARTS Per Kit</u>	<u>DESCRIPTION</u>
METAL PARTS			#6 Hardware		
(55) 204-576	1	Gimbal bracket	(73) 250-170	9	#6 x 1/4" sheet metal screw
(56) 90-265	1	Cabinet	(74) 250-56	23	6-32 x 1/4" screw
(57) 206-312	1	Final shield	(75) 250-89	4	6-32 x 3/8" screw
(58) 204-182	1	Final shield mounting bracket	(76) 250-13	6	6-32 x 1" screw
(59) 204-453	1	Pilot lamp mounting bracket	(77) 250-27	2	6-32 x 2" screw
(60) 100-596-2	1	Chassis	(78) 252-3	31	6-32 nut
(61) 100-43	1	Dial mounting plate	(79) 253-2	2	#6 fiber shoulder washer
(62) 204-732	1	Switch lever mounting bracket	(80) 254-1	39	#6 lockwasher
(63) 266-90	1	Switch lever	(81) 255-5	4	#6 x 3/4" spacer
(64) 100-597	1	Front panel	(82) 255-10	2	#6 x 1-1/2" spacer
			(83) 259-1	5	#6 solder lug
			#8 Hardware		
			(84) 250-43	7	8-32 x 1/4" setscrew
			(85) 253-9	6	#8 flat washer
			#10 Hardware		
HARDWARE			(86) 250-83	8	#10 x 1/2" sheet metal screw
#3 Hardware			(87) 250-54	2	10-32 x 5/8" screw
(85) 250-49	4	3-48 x 1/4" screw	(88) 252-49	2	10-32 x 1-1/4" knurled nut
(66) 252-1	4	3-48 nut	(89) 253-19	2	#10 flat washer
(67) 254-7	4	#3 lockwasher	(90) 254-3	2	#10 lockwasher
			(91) 255-44	2	#10 shoulder spacer
			1/4" Control Hardware		
#4 Hardware			(92) 252-39	1	1/4-32 nut
(68) 250-213	14	4-40 x 5/16" screw	(93) 253-39	1	1/4" flat washer
(69) 250-273	20	4-40 x 3/8" screw	(94) 253-36	1	1/4" spring washer
(70) 252-15	8	4-40 nut	(95) 254-14	1	1/4" lockwasher
(71) 252-89	20	4-40 push-on nut	3/8" Control Hardware		
(72) 254-9	14	#4 lockwasher	(96) 252-7	2	3/8-32 nut
			(97) 253-10	2	3/8" flat washer
			(98) 254-5	2	3/8" lockwasher

AUDIO FREQUENCIES
400 to 3100 Hz

IF FREQUENCY
2303.3 to 2306.7 kHz

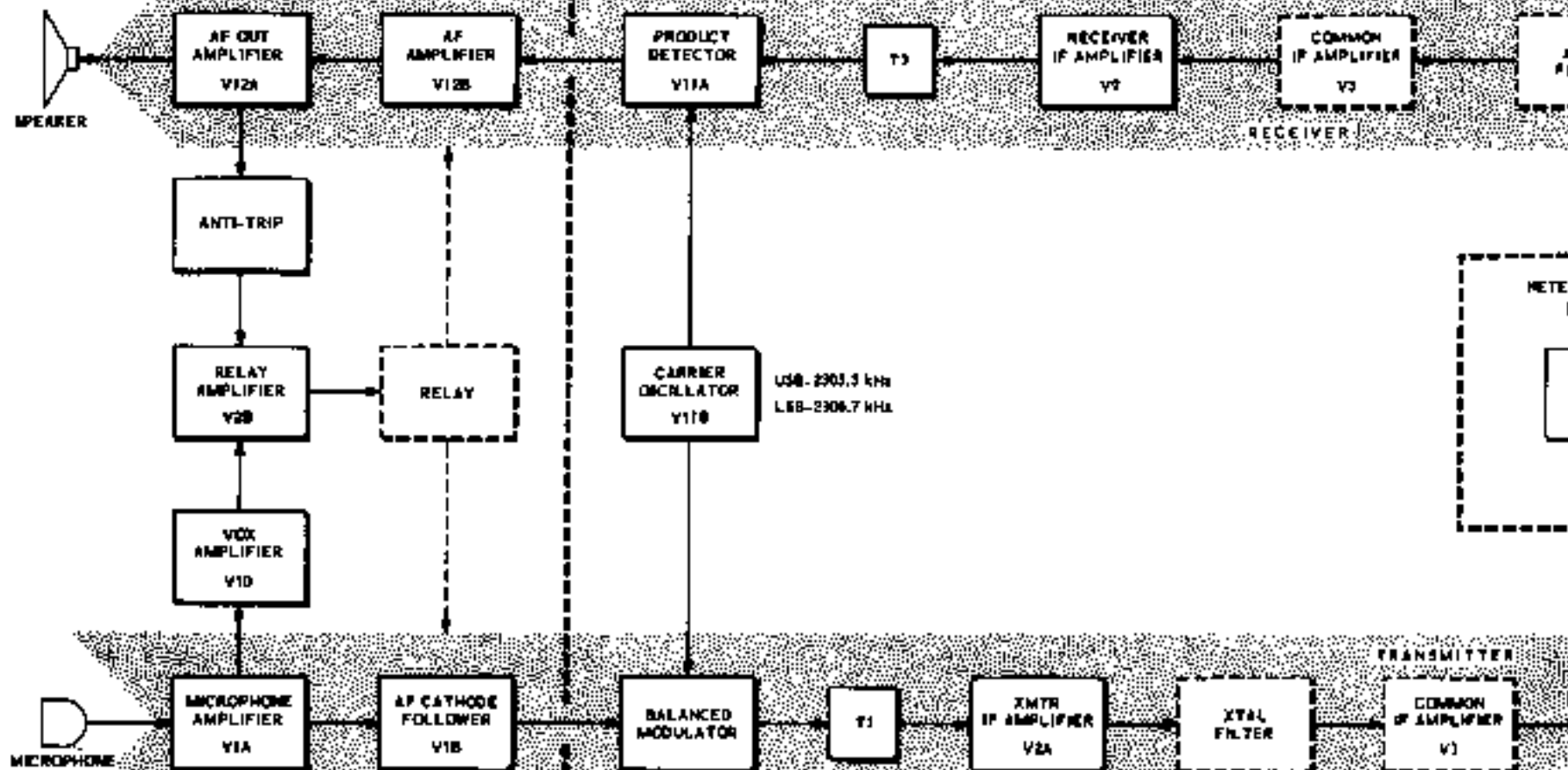

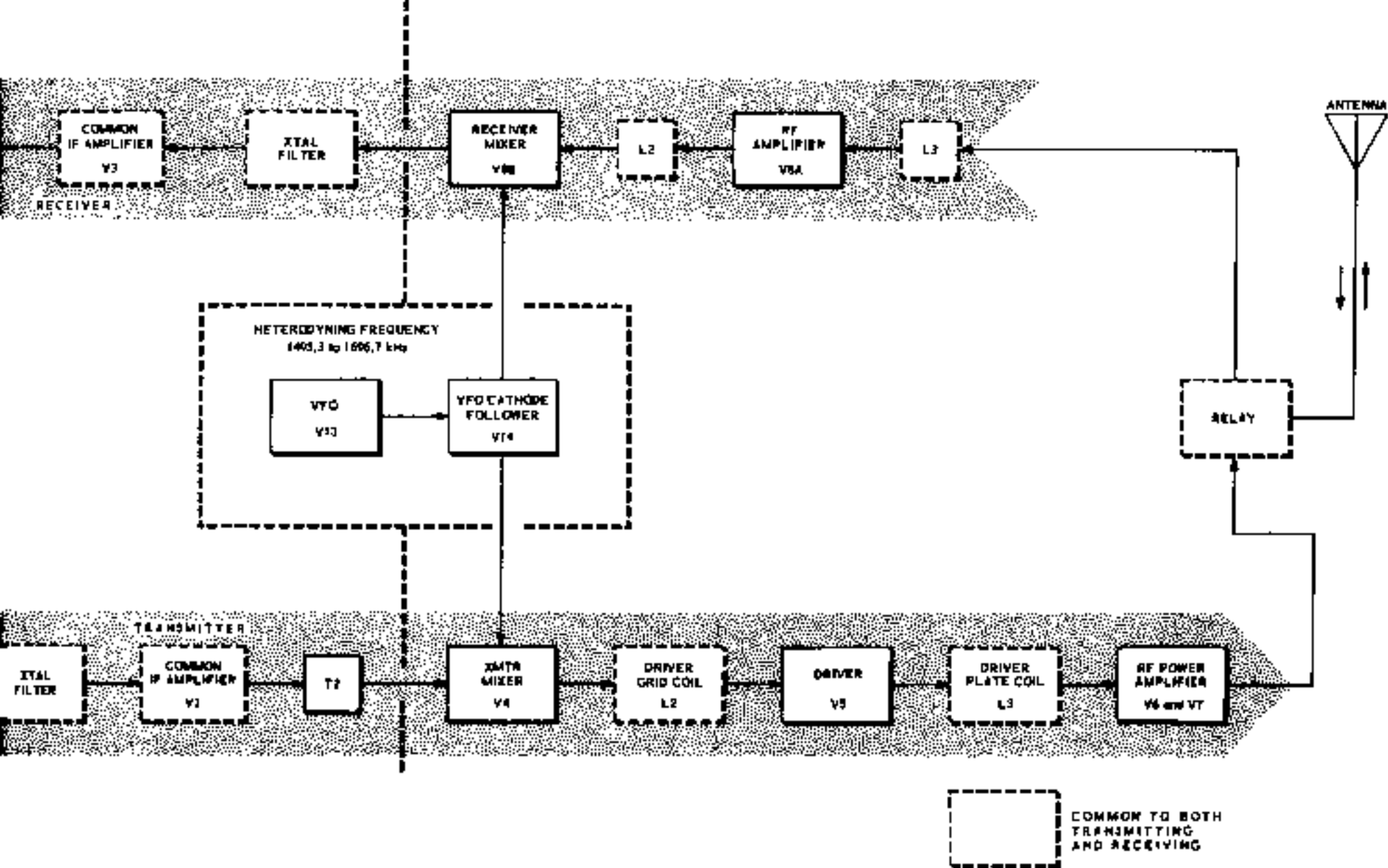

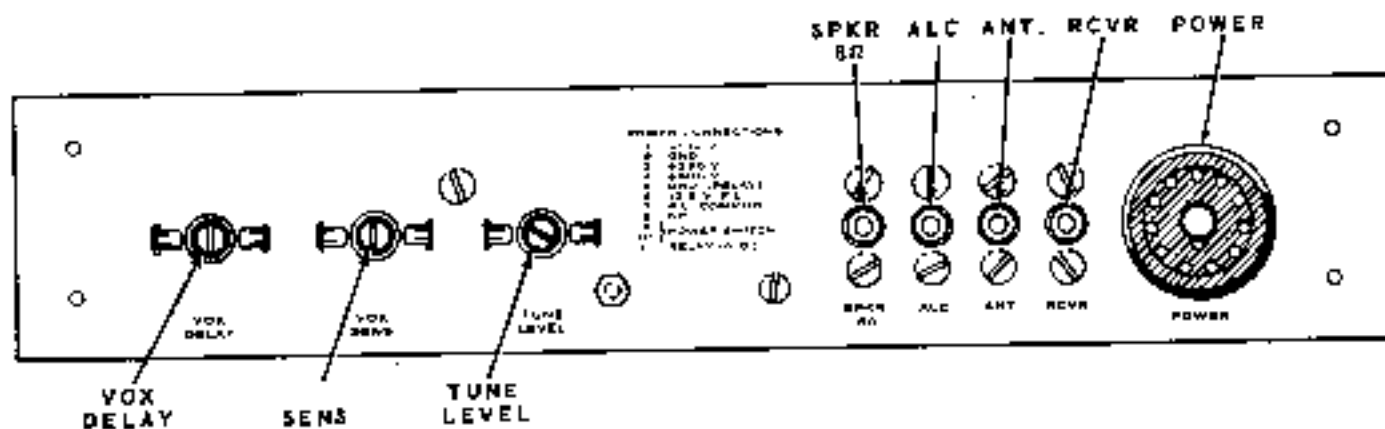
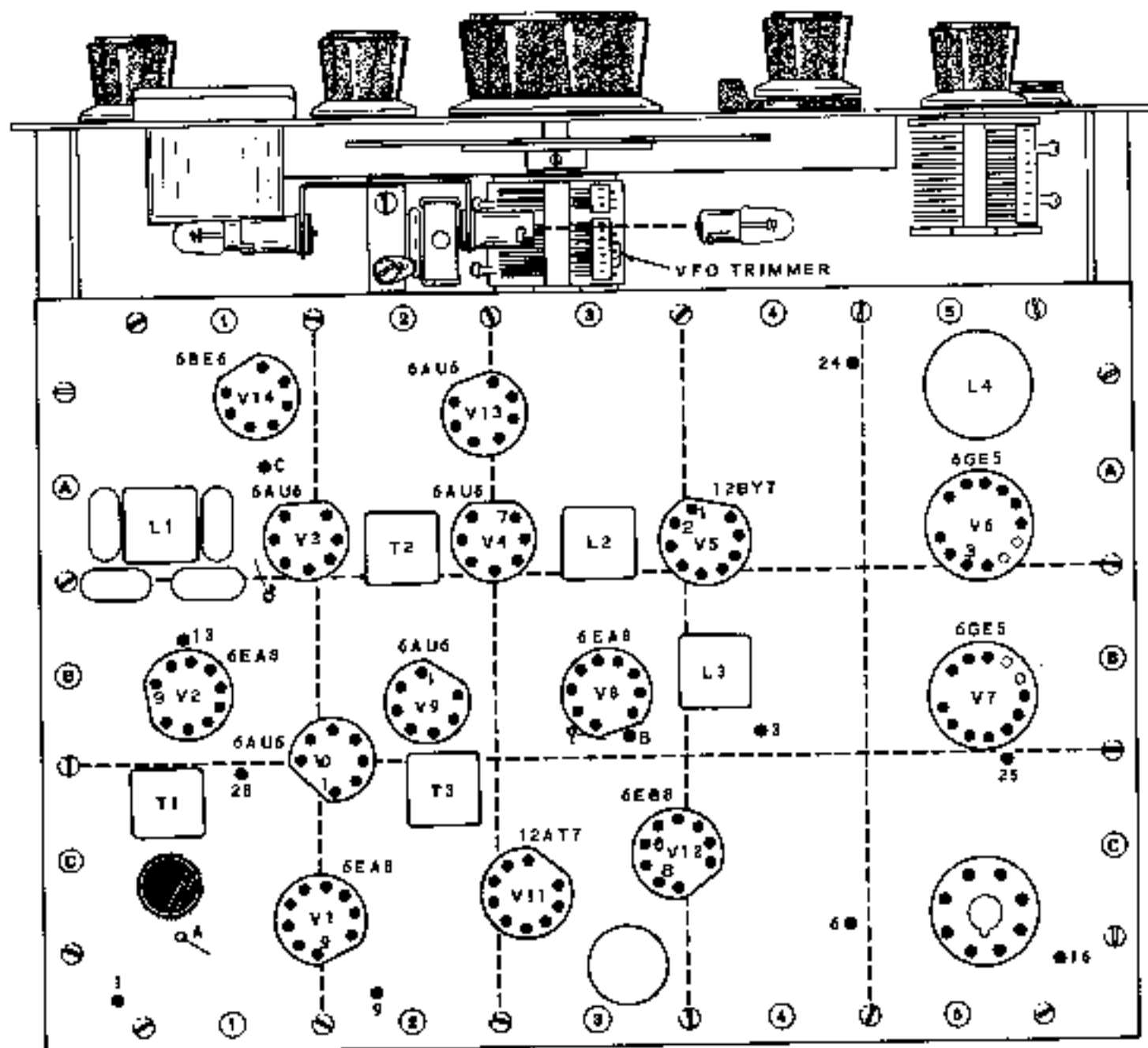
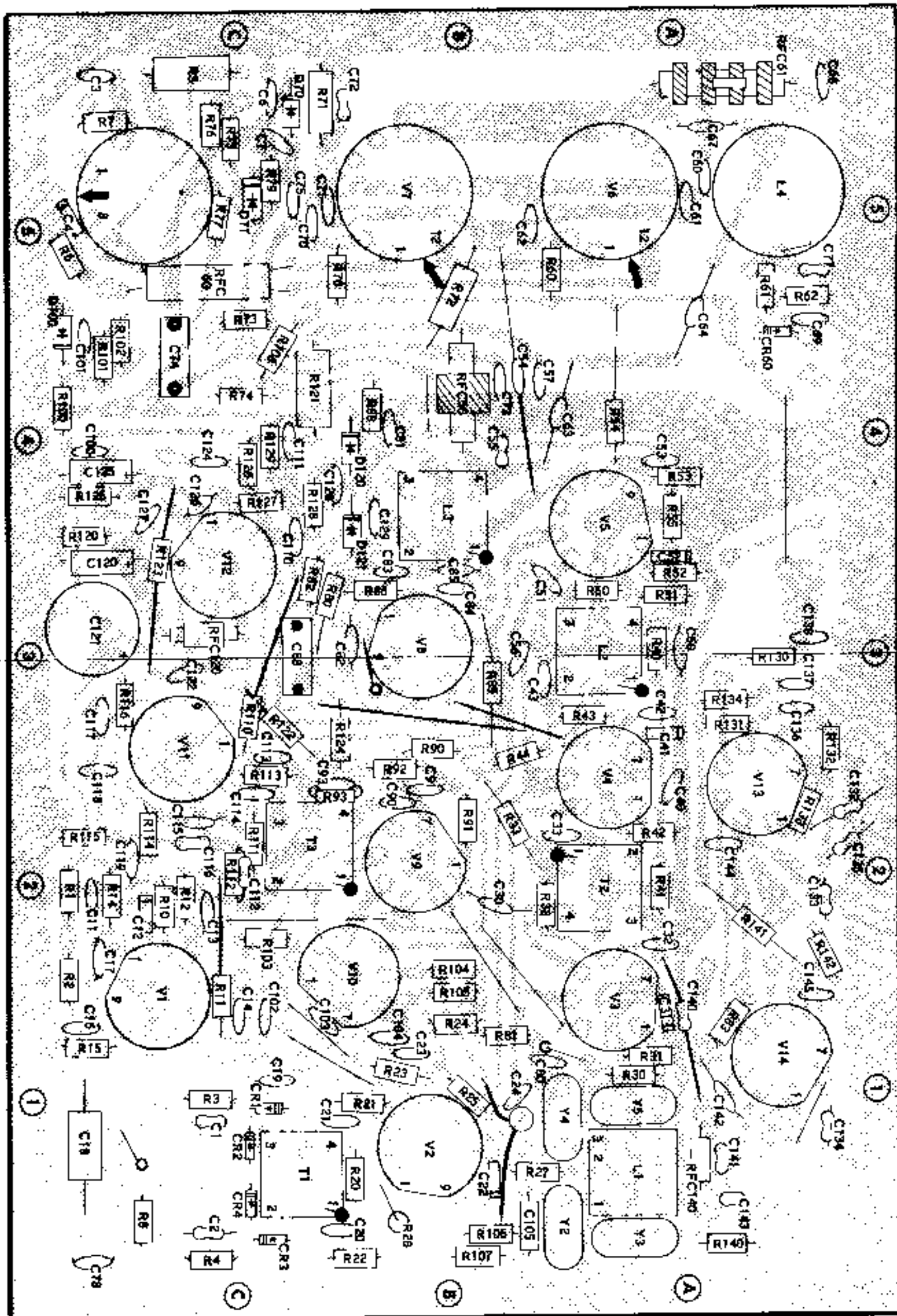
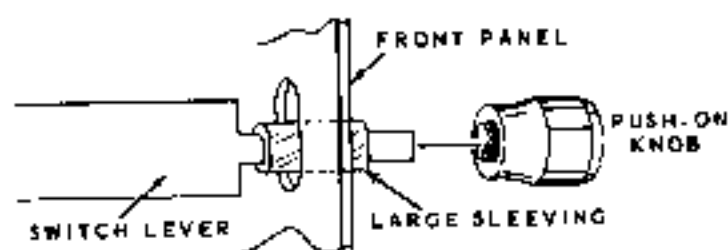

FIGURE 1-1

CIRCUIT BOARD X-RAY VIEW

(VIEWED FROM FOIL SIDE)





Detail 2-9A

- () Refer to Detail 2-9A, and install a 1/4" length of large sleeving and the push-on knob on the switch lever at the LSB/USB location of the front panel. Work the sleeving into the slot of the front panel.
- () Turn all the control, switch, and capacitor shafts fully counterclockwise.
- () Refer to Detail 2-9B, and install the knob bushing on the large shaft at the Receiver Gain position. Position the knob as shown and push the lever knob on the bushing. Support the rear of this control with your finger when pushing the knob on the knob bushing.
- () Start 8-32 x 1/4" setscrews in the tapped holes of the 1-1/8" and 2" diameter knobs.

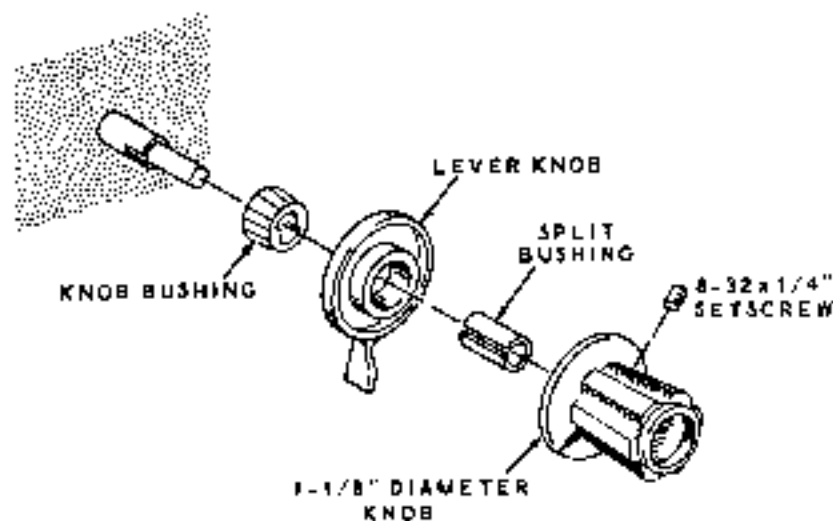

Detail 2-9B

- () Insert a split bushing in one of the 1-1/8" diameter knobs, and install this knob at the Receiver Gain location. Position the pointer as shown.
- () Install the 2" diameter knob at the Tuning location.
- () Install 1-1/8" diameter knobs on the remaining shafts. Position the knob pointer at the Mic Gain location at the 7 o'clock position. The other pointers should be at the fully counterclockwise markings on the panel.

INITIAL TEST

Before installing the tubes and pilot lamps, the following resistance checks should be performed. If the actual resistance readings vary more than $\pm 20\%$ from those listed, refer to the In Case Of Difficulty section of the Manual on Page 53.

Connect the common test lead of an ohmmeter to the chassis and the positive lead to the Test Points listed in the following chart.

NOTE: The internal wiring of most ohmmeters is such that the positive terminal of the ohmmeter battery is connected to the positive (red) test lead, and the negative terminal is connected to the negative (black) test lead. In some ohmmeters, this wiring is reversed and erroneous

readings will be obtained when making these measurements. Try reversing the ohmmeter test leads if the measurements do not check out correctly the first time. Also, try different ohmmeter ranges. Diodes conduct in a non-linear manner giving different resistance readings on different ohmmeter ranges.

Refer to Figure 1-1 (fold-out from Page 28) for the locations of the test points. Set the controls as follows:

Sideband switch: LSB.
 FUNCTION: PTT.
 Meter switch: BIAS SET.
 All other controls: Fully counterclockwise.

<u>TEST POINT</u>	<u>RESISTANCE</u>	<u>TEST POINT</u>	<u>RESISTANCE</u>
() POWER plug pin 1	33 K Ω	() Tube socket V12 pin 8	35 K Ω
() POWER plug pin 2	1000 Ω	() Tube socket V12 pin 6	120 Ω
() POWER plug pin 3	31 K Ω	() Tube socket V1 pin 9	1 to 2 megohm (varies with setting of MIC GAIN control)
() POWER plug pin 4	Infinity	() Tube socket V10 pin 1	0 Ω
() POWER plug pin 5	0 Ω	() Tube socket V2 pin 9	23 megohm
() POWER plug pin 6	Infinity	() 6 in section 4C	0 to 500 K Ω (varies with setting of VOX SENS control)
() POWER plug pin 7	0 Ω	() 9 in section 2C	0 Ω
() POWER plug pin 8	Infinity	() MIC #1	Infinity
() POWER plug pin 9	Infinity	() MIC #2	23 megohm
() POWER plug pin 10	Infinity	() 16 in section 5C	0 Ω
() POWER plug pin 11	Infinity	() Set FUNCTION switch to VOX	
() 28 in section 1C	9 K Ω	() Tube socket V10 pin 1	2 megohm
() A in section 1C	200 Ω to 500 Ω	() Tube socket V2 pin 9	23 megohm
() B in section 3B	250 K Ω	() 9 in section 2C	0 Ω
() C in section 1A	3300 Ω	() MIC #2	23 megohm
() 13 in section 1B	220 Ω	() Set FUNCTION switch to CAL	
() Tube socket V4 pin 7	330 Ω	() 16 in section 5C	131 K Ω
() Tube socket V5 pin 1	150 Ω	() MIC #2	23 megohm
() Tube socket V5 pin 2	200 K Ω to 2,3 megohm		
() Tube socket V6 pin 3	85 K Ω		
() Tube socket V9 pin 1	1.25 megohm		



<u>TEST POINT</u>	<u>RESISTANCE</u>	<u>TEST POINT</u>	<u>RESISTANCE</u>
() Set FUNCTION switch to TUNE		() ANT socket	0.4 Ω , then press relay for 10 K Ω
() Tube socket V10 pin 1	2 megohm	() RCVR socket	0.1 Ω
() Tube socket V2 pin 9	0 Ω		
() 9 in section 2C	0 to 20 K Ω (varies with setting of TUNE LEVEL control)		
() MIC#2	0 Ω		
() Set FUNCTION switch to PTT and the Meter switch to OPERATE TUNE			
NOTE: Use the OHMS X100 range, Just touch the test point and note that the S Meter deflects; do not attempt to measure the resistance.		NOTE: Use the proper ohmmeter ranges for each of the following tests.	
() 13 in section 1B	S Meter deflects a small amount (direction depends on ohmmeter polarity)	() 1 in section 1C	15 K Ω , then press relay for 330 Ω
() Set FUNCTION switch to TUNE and use OHMS X100 range		() 3 in section 4B	330 Ω , then press relay for 120 K Ω
() 24 in section 4A	S Meter deflects	() 27 in section 3C	0 to 22 K Ω (varies with setting of RF ATTN control)
() Set FUNCTION switch to PTT and the Meter switch to BIAS SET. Use OHMS X1 range.		() G in section 3C	0 to 1 megohm (varies with setting of AF VOL control)
() 25 in section 5C.	Meter deflects (opposite direction)	() Tube socket V6 pin 3	80 K Ω , press relay for 70 K Ω
() SPKR socket	0.4 Ω	() ALC socket	2.2 megohm (may be 30 K Ω with ohmmeter leads reversed)
() POWER plug pin 11	Infinity, then press relay for 0 Ω		
		This completes the Initial Tests.	
		() Install the tubes in their respective sockets. The tube numbers are lettered on the circuit board. Support the circuit board from underneath with your finger while installing tubes to prevent damage to the circuit board.	
		() Install the pilot lamps in their sockets. Be sure the one lamp does not touch the case of the meter.	

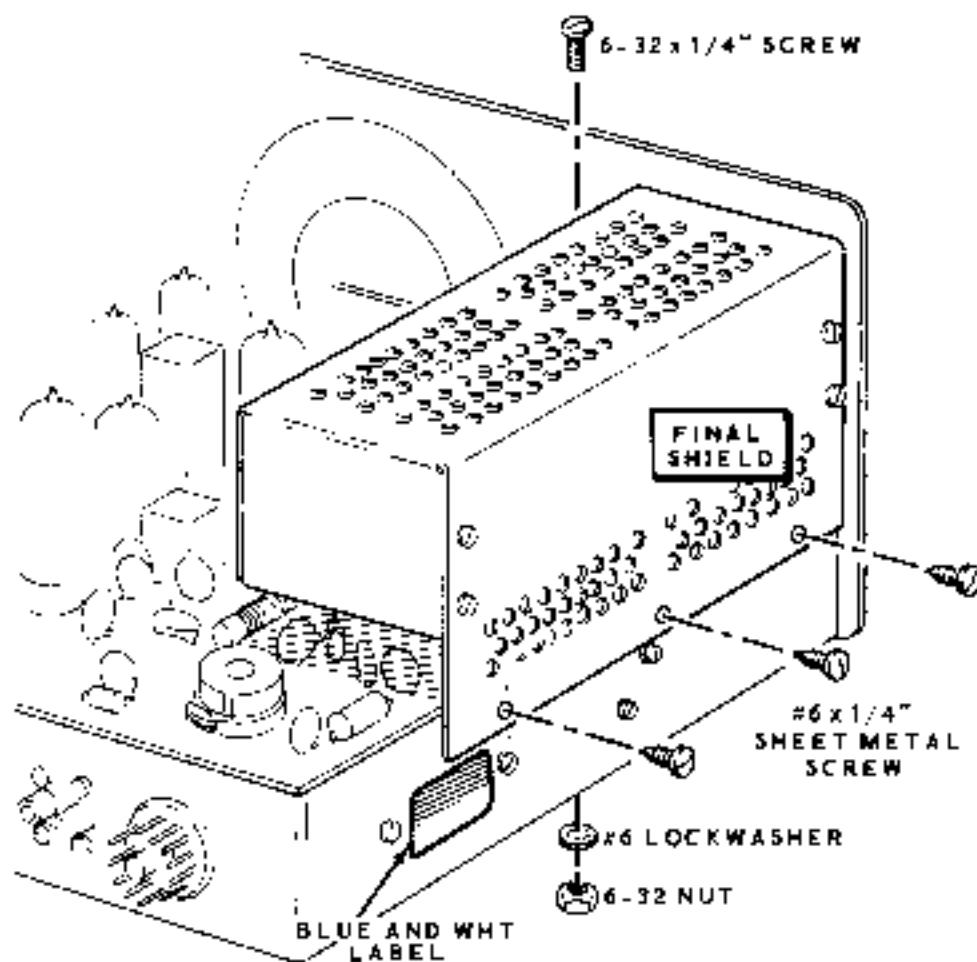

PICTORIAL 2-10

Refer to Pictorial 2-10 and Detail 2-10A for the following steps.

- () Install 4-40 hardware in the eight endholes of the final shield,
- () Mount the final shield mounting bracket on the final shield with 6-32 x 1/4" hardware.
- () Mount the final shield on the chassis with three #6 x 1/4" sheet metal screws in the

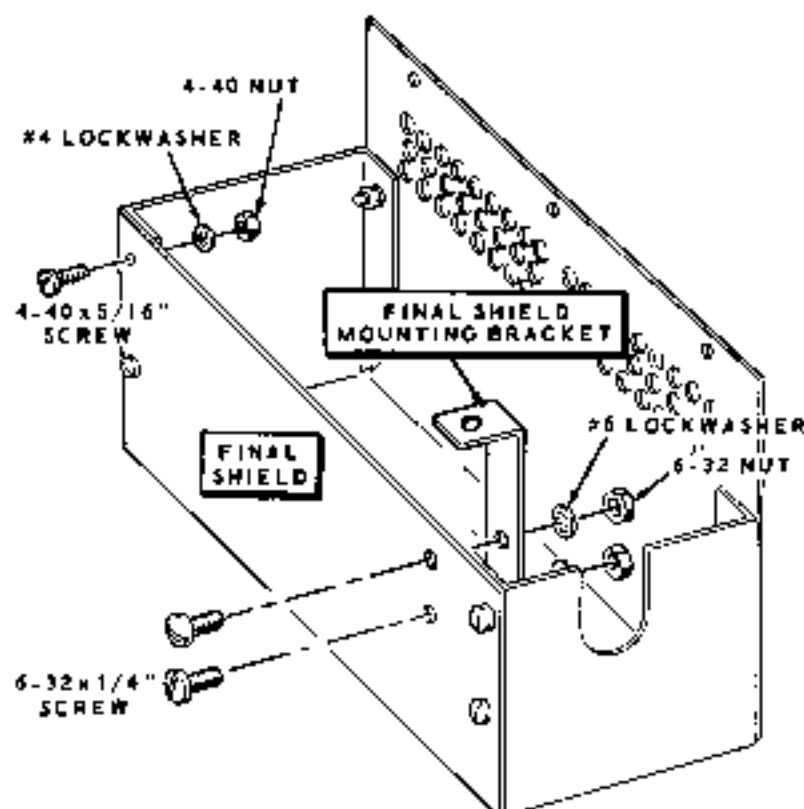

Detail 2-10A

side of the chassis, and 6-32 x 1/4" hardware in the top of the chassis. Fit the front of the shield between the front panel and the Final Tune capacitor.

- () Carefully peel away the backing paper from the blue and white identification label. Then press the label onto the side of the chassis. Be sure to refer to the numbers on this label in any communications you have with the Heath Company about this kit.

POWER SUPPLY CONNECTIONS

This Transceiver was designed to operate with the Heathkit Models HP-13 (12 VDC power source) and HP-23 (120 VAC power source) Power Supplies. The following information will help you wire the 11-pin socket (supplied with the Transceiver) for the power cable of the Power Supply you intend to use.

HP-13 POWER SUPPLY CONNECTIONS

CAUTION: Be sure the alternate connection in the low voltage DC circuit of the HP-13 Power

Supply is connected for +250 volts output as outlined in the HP-13 Manual. Be sure the charging limit of the automobile voltage regulator is set to not exceed 14.5 volts.

Refer to Figure 2-1 for the following steps.

- () Install the 11-pin socket cap over the free end of the 8-wire cable from the HP-13 Power Supply, as shown.

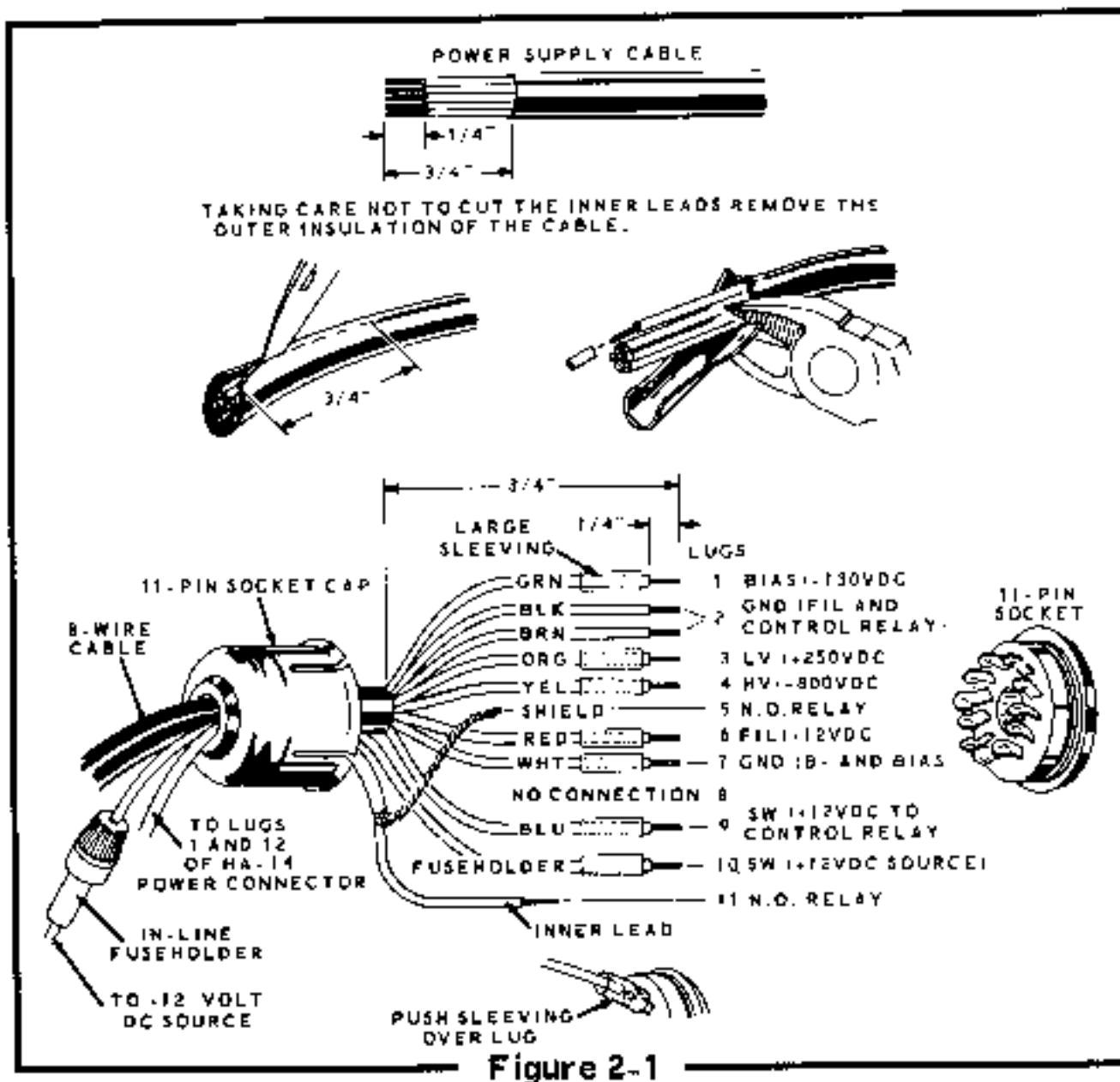

- () Remove 3/4" of the outer insulation from the end of the 8-wire cable. Then remove 1/4" of insulation from the end of each wire.
 - () Melt a small amount of solder on each of the exposed wire ends to hold the small strands of wire together.
 - () Insert the lead from the cap end of the fuseholder (an in-line fuseholder with lead is supplied with the HP-13 Power Supply) through the socket cap as shown.
 - () Cut seven 5/8" lengths of large sleeving and slip them over the indicated wires.
 - () Connect the wires of the 8-wire cable, the fuseholder lead, and the coaxial cable (if the HA-14 Linear Amplifier is used) to the 11-pin socket lugs as shown. Solder each connection.
 - () Push the lengths of sleeving over the lugs of the socket.
 - () Snap the socket cap onto the 11-pin socket. **IMPORTANT:** When using the HP-13 Power Supply with the Transceiver, be sure the Bias control of the Power Supply is in its fully clockwise position. This setting will supply full bias voltage to pin 9 of the power socket.
- If the Heathkit HA-14 Linear Amplifier is used, a coaxial cable, that has its inner lead connected to lug 12 and its shield connected to lug 1 of the HA-14 power connector, should be inserted through the socket cap as shown.

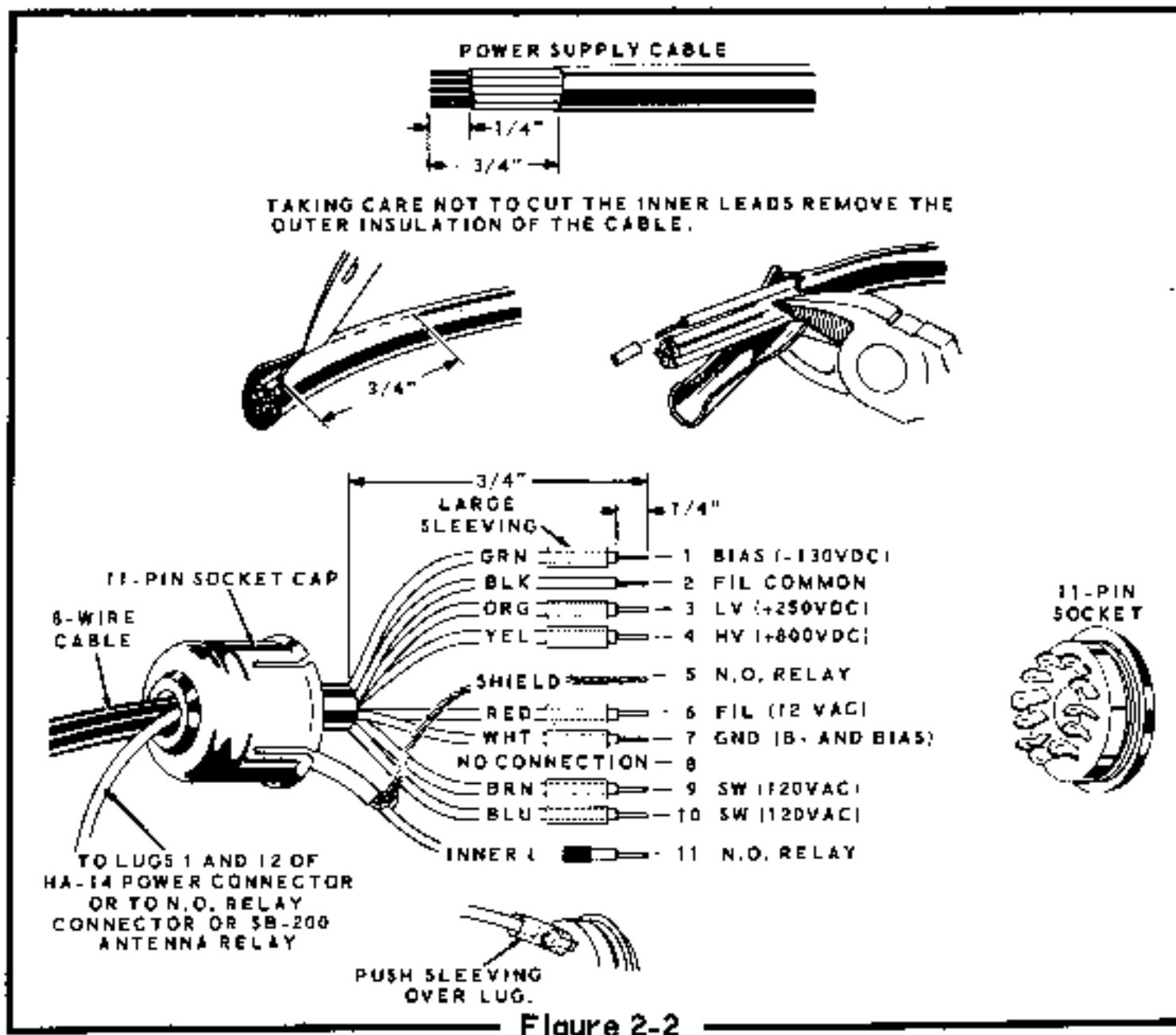

Figure 2-2

HP-23 POWER SUPPLY CONNECTIONS

CAUTION: Be sure the alternate connection in the low voltage DC circuit of the HP-23 Power Supply is connected to +250 volts DC output as outlined in the HP-23 Manual.

Refer to Figure 2-2 for the following steps.

- () Install the 11-pin socket cap over the free end of the 8-wire cable from the Power Supply.
- () Remove 3/4" of the outer insulation from the end of the 8-wire cable. Then remove 1/4" of insulation from the end of each wire.
- () Melt a small amount of solder on each of the exposed wire ends to hold the small strands of wire together.

If the Heathkit Model HA-14 Linear Amplifier is to be used, a coaxial cable from the HA-14 power connector should be inserted through the

socket cap as shown. Use the coaxial cable with the inner lead connected to lug 12 and the shield to lug 1 of the HA-14 power connector. For the SB-200 and other Linear Amplifiers, use a piece of coaxial cable through the cap to bring out the relay connections.

- () Cut seven 5/8" lengths of large sleeving and slip them over the indicated wires.
- () Connect the wires of the 8-wire cable and the coaxial cable (if a Linear Amplifier is used) to the 11-pin socket lugs as shown. Solder each connection.
- () Push the lengths of sleeving over the lugs of the socket.
- () Snap the socket cap onto the 11-pin socket.

NOTE: With the above connections, the Bias control in the HP-23 Power Supply is inoperative. Proper bias settings are accomplished with the Bias control in the Transceiver.

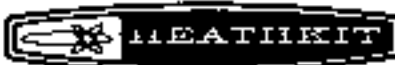

ALIGNMENT AND ADJUSTMENT

Refer to Figure 1-1 (fold-out from Page 28) for the following steps.

Set the controls as follows:

RF ATTN: fully clockwise,
 VOX SENS, VOX DELAY, AF VOL, and TUNE LEVEL: half rotation,
 BIAS ADJ and MIC GAIN: fully counterclockwise,
 Meter switch: BIAS SET,
 FUNCTION switch: OFF,
 Sideband switch: LSB,
 S METER ADJ: fully counterclockwise,
 CARRIER NULL: any position.

Using an ohmmeter, make the following resistance checks at the Power plug:

<u>TEST POINT</u>	<u>RESISTANCE</u>
Pin 1	37 K Ω
Pin 3	33 K Ω
Pin 4	Infinity

If any of these resistance readings vary more than $\pm 20\%$, refer to the In Case Of Difficulty section of the Manual before proceeding.

RECEIVER ALIGNMENT

NOTE: Phono plugs are provided for making connections to the sockets on the rear of the Transceiver. Refer to Figure 2-3 for wiring a phono plug to a coaxial cable.

Connect an 8 Ω speaker (a 3.2 Ω to 16 Ω speaker may be used with reduced efficiency) to the SPKR socket, and a 50 Ω dummy load to the ANT socket. With the power supply wired according to the instructions in the Power Supply section of the Manual, connect it to the Transceiver Power plug. Make sure the VOX DELAY control is at the center of its rotation. The relay will click during the first few seconds of warmup. This is normal.

() Turn the FUNCTION switch to PTT. The pilot lamps and the tube filaments should light. Watch to see that the meter remains at zero; if it should start to deflect, the

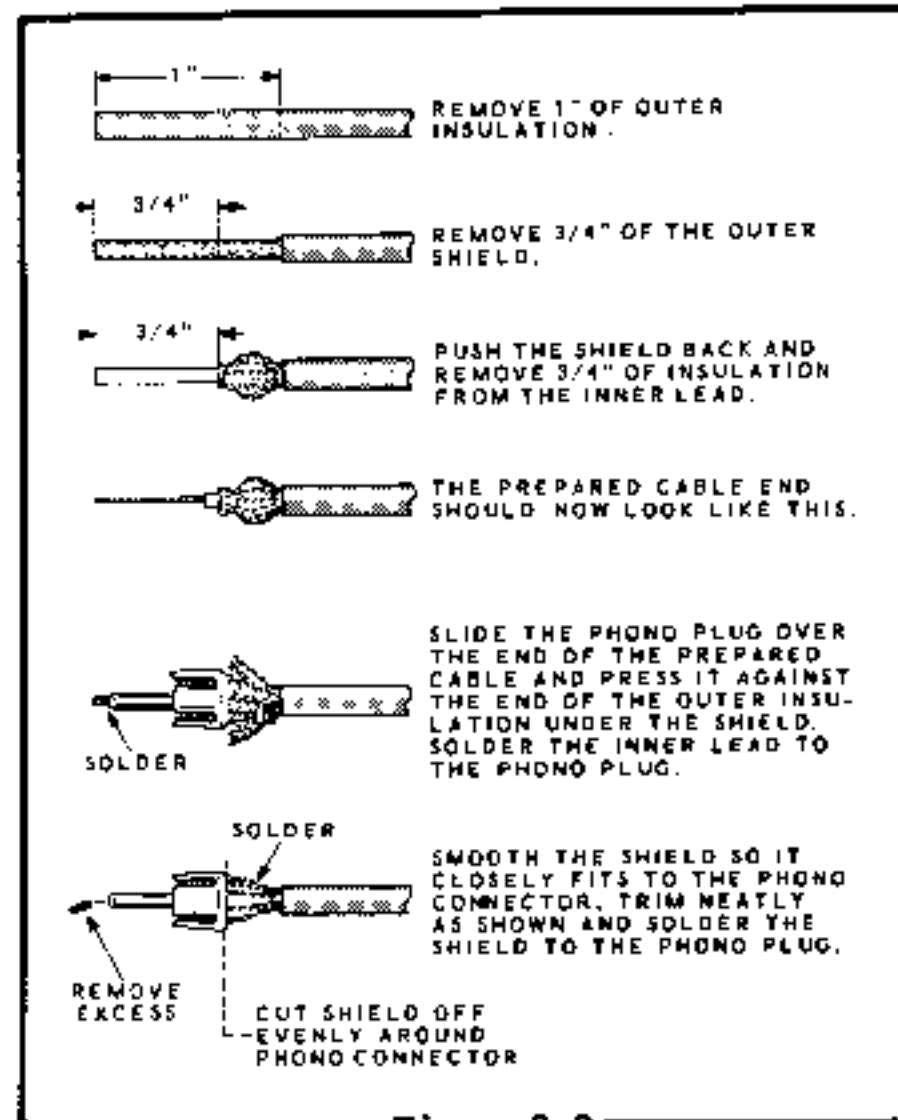

Figure 2-3

Transceiver should be turned off immediately, as the bias circuit of tube stages V6 and V7 is probably shorted and must be corrected before proceeding.

- () Place the Meter switch in the OPERATE TUNE position and adjust the S METER ADJ control for a zero indication on the meter.
- () Remove the dummy load from the ANT socket and plug an antenna into the ANT socket.
- () Turn up the AF VOL control until noise is heard in the speaker. Tune up and down the band with the VFO. Stations should be heard if there is any local activity.
- () Tune in a station that gives approximately a midscale (S9) meter reading.

- () Adjust the top and bottom slugs of receiver IF transformer T3 for the highest meter reading. Use the short end of the alignment tool for the top slug, and the long end of the alignment tool for the bottom slug. When passing the long end of the alignment tool through the top slug to reach the bottom slug, be careful not to disturb the adjustment of the top slug.
- () Repeat the adjustment of T3 for the highest meter reading.
- () Turn the FUNCTION switch to OFF.
- () Turn the VFO dial fully counterclockwise until the plates of the VFO capacitor are fully closed.
- () Loosen the setscrew of the dial. Rotate the dial so that the end of the white strip near the 3.8 marking is aligned with the hair-line and tighten the setscrew. Check to see that full rotation of the dial does not cause any drag or rubbing. If it does, move the dial or knob slightly on the shaft, then recalibrate and retighten the setscrew with the spring washer compressed about half way.
- () Bend the pilot lamp bracket and adjust the lamp positions for best illumination of the dial and meter.

VFO CALIBRATION

Disconnect the antenna from the Transceiver and plug the dummy load into the ANT socket.

The following steps present two ways to check the dial calibration with two different types of receivers. Use the method that applies to the type of receiver available.

Calibration With A Standard AM Broadcast Receiver

- () Connect one end of a short wire to the antenna terminal of the broadcast receiver. Place the other end of this wire near tube V14 in the Transceiver.
- () Tune the receiver dial to a station of known frequency between 1495 kHz and 1695 kHz. Now, add 2305 kHz to this dial frequency and set the VFO dial to the sum of these

two frequencies.

Example:

Receiver frequency:	1540 kHz
Add:	<u>2305 kHz</u>

Set VFO dial to: 3845 kHz

- () With the Sideband switch in LSB, set the FUNCTION switch to PTT and allow the Transceiver to warm up.
- () Adjust the slug of coil L5 until the VFO is heard in the speaker of the receiver. Coil L5 will normally have to be turned counterclockwise, as viewed from the top of the chassis. The VFO trimmer need not be adjusted at this time.
- () Turn the FUNCTION switch to OFF.

This alignment should calibrate the VFO fairly closely. However, do not operate the Transceiver near the ends of the VFO dial until the VFO calibration is checked with a crystal calibrator or a very accurate amateur receiver.

Calibration With Amateur Band Receiver

NOTE: The following procedure gives the correct dial readings for zero beat (carrier frequency) in LSB only. In USB, the dial reading is 3.4 kHz higher than the carrier frequency.

- () Connect one end of a short wire to the antenna terminal of the receiver. Place the other end of this wire near tube V4 in the Transceiver.
- () Temporarily remove V5, the 12BY7 tube.
- () With the Sideband switch in the LSB position, turn the FUNCTION switch to TUNE and allow the Transceiver to warm up.
- () Move the Meter switch to BIAS SET. The meter should indicate "0." If it is not at "0," check to see that the BIAS ADJUST control is in its fully counterclockwise position. If the meter still will not reach "0," turn the Transceiver OFF and check the bias circuitry before proceeding.
- () Set the dials of the receiver and Transceiver to 3.9 megahertz. The receiver should be operated in the CW mode.



NOTE: The VFO trimmer can be adjusted in the following step by inserting an insulated screwdriver through the large hole in the side of the final shield.

- () Adjust coil L5 clockwise (from the top of the chassis) until the Transceiver signal is heard in the amateur receiver speaker. Check the VFO dial calibration by setting the dials of both the receiver and Transceiver first to 3.8 megahertz and then to 4.0 megahertz. The calibration should check near these points, and any dial variations should be corrected by adjusting coil L5 at 3.8 megahertz and the trimmer on the VFO variable capacitor at 4.0 megahertz.
- () Turn the FUNCTION switch to OFF.
- () Replace tube V5.

Crystal Calibrator Check Of VFO Dial Settings

The preceding adjustments of the VFO will only be as accurate as the receiver used. The calibration can be accurately checked by using the Heathkit plug-in Crystal Calibrator as an accessory with the Transceiver. The Crystal Calibrator accuracy should be checked against WWV by using a receiver other than the one in the Transceiver to set the Calibrator at 5, 10, or 15 megahertz. Other 100 kHz calibrators can be used by connecting their output to the antenna socket.

NOTE: The following procedure gives the correct dial readings for zero beat (carrier frequency) in LSB only. In USB, the dial reading is displaced and reads 3.4 kHz higher than the carrier frequency.

- () Plug the Crystal Calibrator into the calibrator socket of the Transceiver.
- () With the antenna plugged into the ANT socket, place the FUNCTION switch in the CAL position, the Sideband switch in the LSB position, and the Meter switch in the OPERATE TUNE position. Allow sufficient time for the Calibrator to warm up.
- () Check the calibration accuracy of the VFO at the 3.8, 3.9, and 4.0 megahertz settings of the VFO dial of the Transceiver. Any dial variations should be corrected by adjusting coil L5 at 3.8 megahertz and the VFO trimmer at 4.0 megahertz. Repeat until the dial checks with the calibrator signals.

- () Turn the FUNCTION switch to OFF.

TRANSMITTER ALIGNMENT

Bias Setting

- () Connect the dummy load to the ANT socket.
- () Remove V5, the 12BY7 tube.
- () Set the FUNCTION switch to TUNE and the Meter switch to BIAS SET.
- () Then adjust the BIAS ADJ control for a reading of S3 on the meter. There is a small triangle above the "3" on the meter to indicate the proper bias setting.
- () Turn the FUNCTION switch to OFF, and replace tube V5.

IF Amplifier Adjustment

- () With the VFO dial set to 3.8, turn the FUNCTION switch to the TUNE position and the Meter switch to TUNE OPERATE. The meter should indicate some output.
- () Adjust the FINAL TUNE control for maximum output, which should give a reading of over S3 on the Transceiver meter. If the meter goes above S9, adjust the CARRIER NULL control to drop the level to S9. If the output level is too low, adjust the CARRIER NULL and/or TUNE LEVEL to obtain an S3 reading.
- () Adjust both slugs of transformer T2 for a maximum meter indication.

Balanced Modulator Adjustment

- () Connect a voltmeter across the dummy load (if your dummy load provides a DC voltmeter connection), or to connector 24 (section 4A on the circuit board), or use a VTVM with an RF probe positioned near the dummy load. Do not connect the RF probe to the dummy load as there is sufficient voltage output to burn out the diodes of some RF probes.

NOTE: If a voltmeter is not available, the panel meter may be used, with reduced accuracy. Set the FUNCTION switch to TUNE and the TUNE LEVEL control to its fully counterclockwise position. Another receiver can also be used as a null indicator.

- () Place the FUNCTION switch in the PTT position. Allow the Transceiver to warmup for at least one-half hour before adjusting the balanced modulator.
 - () With the Sideband switch in the LSB position, press the PTT switch or ground lug 2 of the MIC socket with a short wire, and adjust the CARRIER NULL control for a minimum signal indication on the meter.
 - () Using the long end of the alignment tool, turn the bottom slug of transformer T1 two full turns toward the bottom of its travel (clockwise from the top of the chassis).
 - () Adjust the top slug of T1 for a maximum signal indication. This should take only a very slight turn of the slug. If the slug is turned down too far, a larger, but false peak will appear.
 - () Again, adjust the CARRIER NULL control for a minimum signal indication.
- NOTE: The signal level should now become quite low, and if a VTVM and RF probe are being used, the probe should be connected to the center pin (pin 2) of the ANT socket.
- () Now adjust the bottom slug of T1 back up into the transformer. As the slug is adjusted, there will be a dip to a minimum indication. Adjust the slug for this minimum (dip) indication.
- () Readjust the CARRIER NULL control and the bottom slug of transformer T1 for the lowest possible minimum signal indication. The adjustments are now quite critical; turn them slowly. Repeat this adjustment until the best null is obtained.
 - () Change the Sideband switch to USB and check the null. Repeat the adjustment in the previous step for both the LSB and USB positions, until the best null setting is obtained. Measured RF voltage should be 0.5 volts or less at null.
 - () Disconnect the voltmeter (or VTVM) from the Transceiver and if used, the wire connected between lug 2 of the MIC socket and the chassis.
 - () Turn the FUNCTION switch to TUNE and the Meter switch to OPERATE TUNE.
 - () Adjust the TUNE LEVEL control to obtain a meter reading between S3 and S6. This reading will normally vary as you tune across the band, and between LSB and USB.

Driver Tuning

The driver tuning coils, L2 and L3, are preset at the factory and need no further adjustment.

FINAL ASSEMBLY

FIXED STATION-MOBILE CONSIDERATIONS

Before installing the Transceiver in the cabinet, determine whether it will be used for fixed station or mobile operation, or both. For fixed station use only, perform the steps under "For Fixed Stations;" for mobile use only, perform the steps under "For Mobile Stations." If you plan to use the Transceiver alternately in fixed station and mobile installations, perform the steps in both sections.

Refer to Pictorial 2-11 for the following steps.

NOTE: If a microphone clip is to be used (supplied with your microphone), it may be installed on either end of the cabinet, so the microphone can be lifted up and out, or so the microphone can be pulled toward the front and out. Use 6-32 x 1/4" hardware to mount the microphone clip.

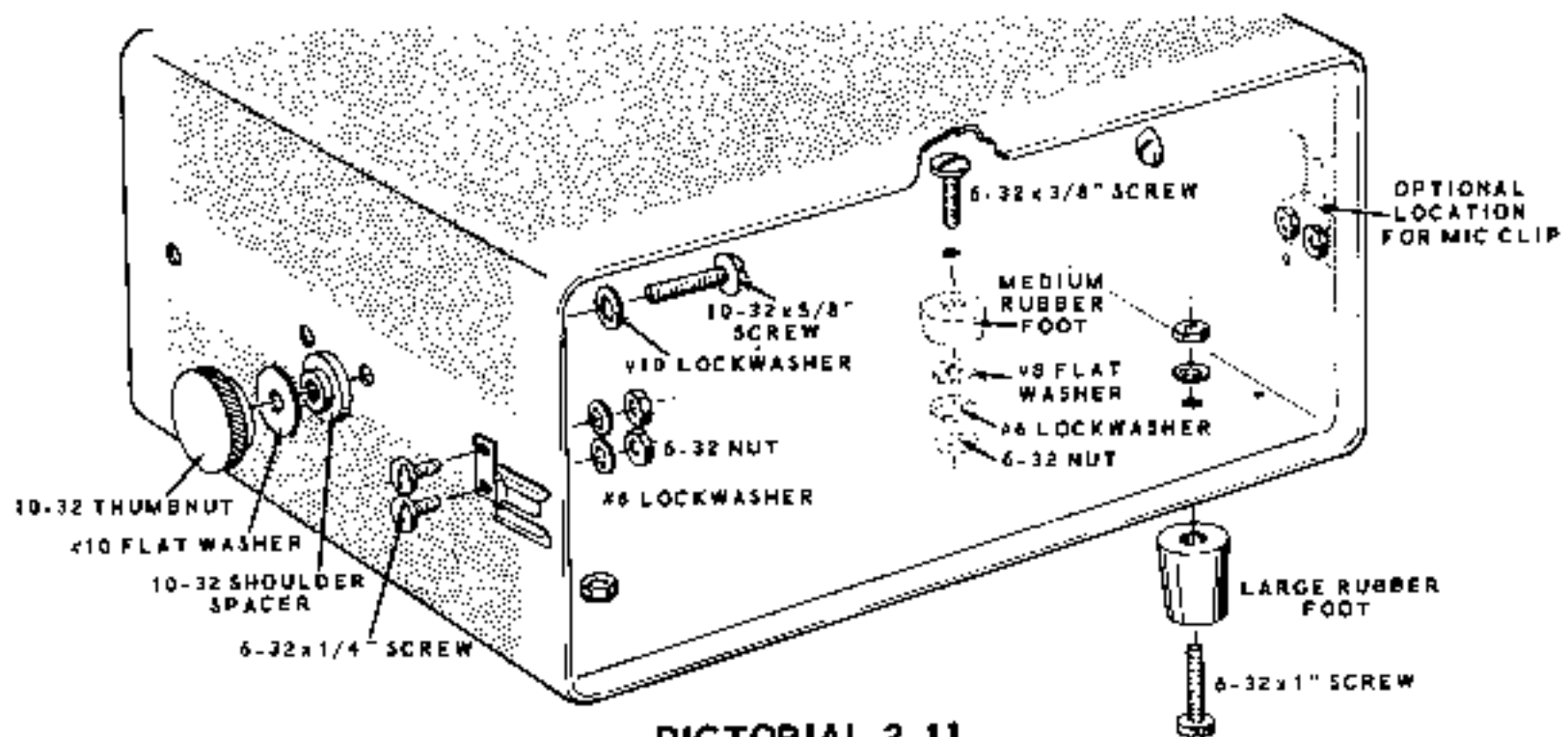

PICTORIAL 2-11

For Fixed Stations

- () Install the medium rubber feet at the rear holes in the bottom of the cabinet, using 6-32 x 3/8" hardware and #8 flat washers.
- () Install large rubber feet at the front holes (nearest the perforated area) in the bottom of the cabinet, using 6-32 x 1" hardware.

For Mobile Stations

Determine whether the Transceiver is to be mounted under the dash or on the floor of the automobile. See Figure 3-1. If under-the-dash mounting is preferred, there are two holes

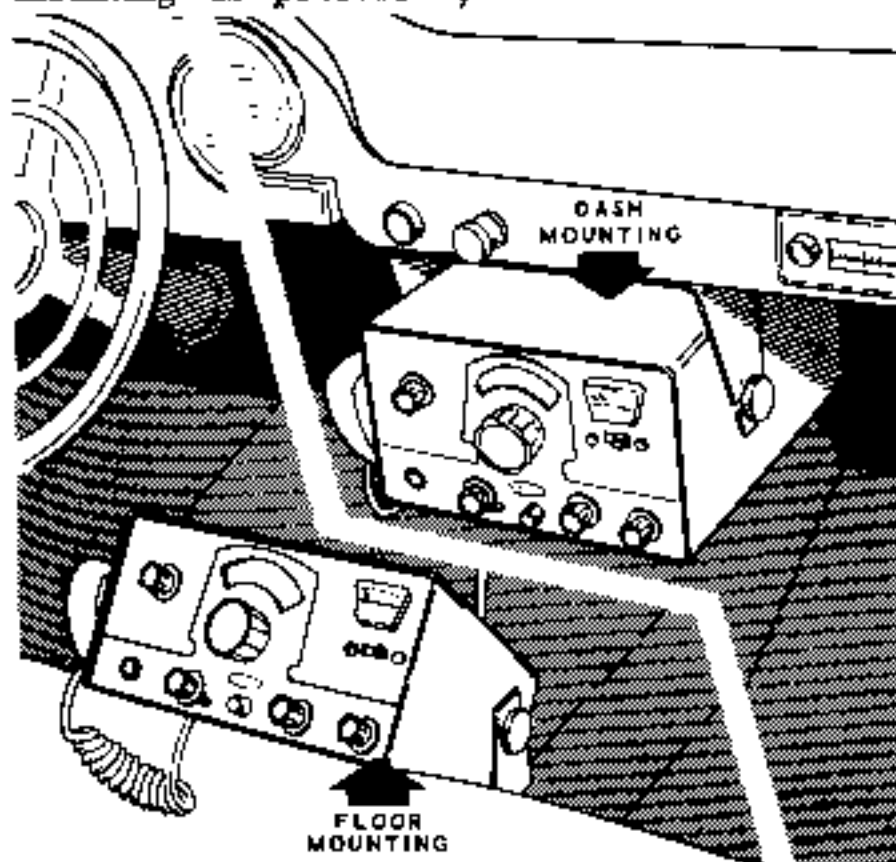
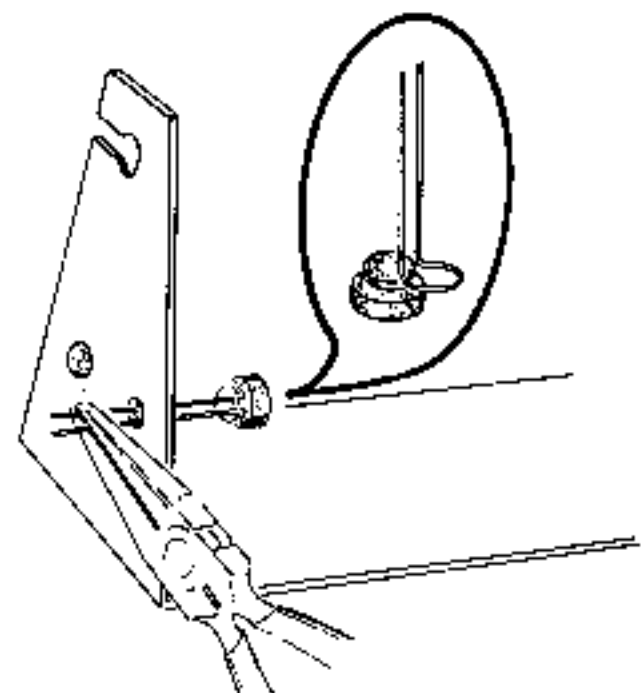

Figure 3-1

near the center on each side of the cabinet which can be used for mounting. For floor mounting, the holes at the rear on each side of the cabinet can be used. Choose the holes that will provide best balance for your installation.

- () Mount the gimbal bracket hardware in the cabinet holes decided upon. Use 10-32 x 5/8" screws, #10 lockwashers, 10-32 shoulder spacers, #10 flat washers, and 10-32 thumbnuts. See Pictorial 2-11.
- () Refer to Detail 2-11A, and install four small rubber feet into the gimbal bracket. This is easily done by looping a length of bare wire around the groove of the rubber foot and passing the wire through the hole in the gimbal bracket. Pull on the wire until the rubber foot is properly seated in the hole.



Detail 2-11A

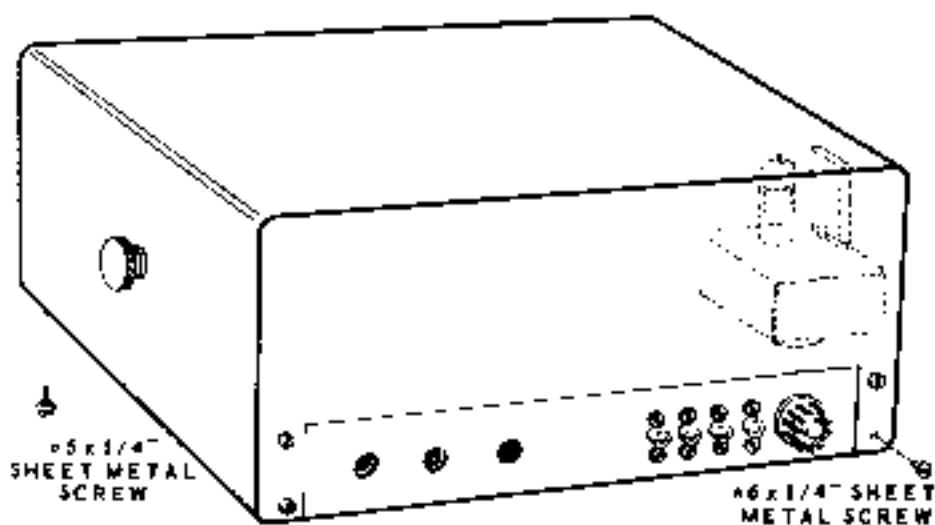

PICTORIAL 2-12

CRYSTAL CALIBRATOR MOUNTING

Refer to Pictorial 2-12 for the following steps.

If the Heathkit plug-in Crystal Calibrator is to be used with the Transceiver, plug it into the Calibrator socket of the Transceiver.

CABINET MOUNTING

Refer to Pictorial 2-12 for the following steps.

- () Slide the Transceiver chassis into the cabinet. If the Crystal Calibrator is used, be careful not to damage it when sliding the Transceiver into the cabinet.
- () Secure the chassis in the cabinet with six #6 x 1/4" sheet metal screws, four in the back and two in the bottom. Be sure the screws do not hit any of the wires under the chassis.

MICROPHONE

Any high impedance crystal, dynamic, or ceramic microphone with an output rating between -45 db and -80 db can be used with the Transceiver.

Figure 3-2 shows how most communication microphones can be wired for VOX, PTT, or both types of operation. The only difference in wiring to change the microphone from just PTT operation to both types of operation, is the addition of the jumper wire in the microphone. This additional wire keeps the audio lead from being opened when the microphone button is released, thus permitting VOX operation with the Transceiver. When wired

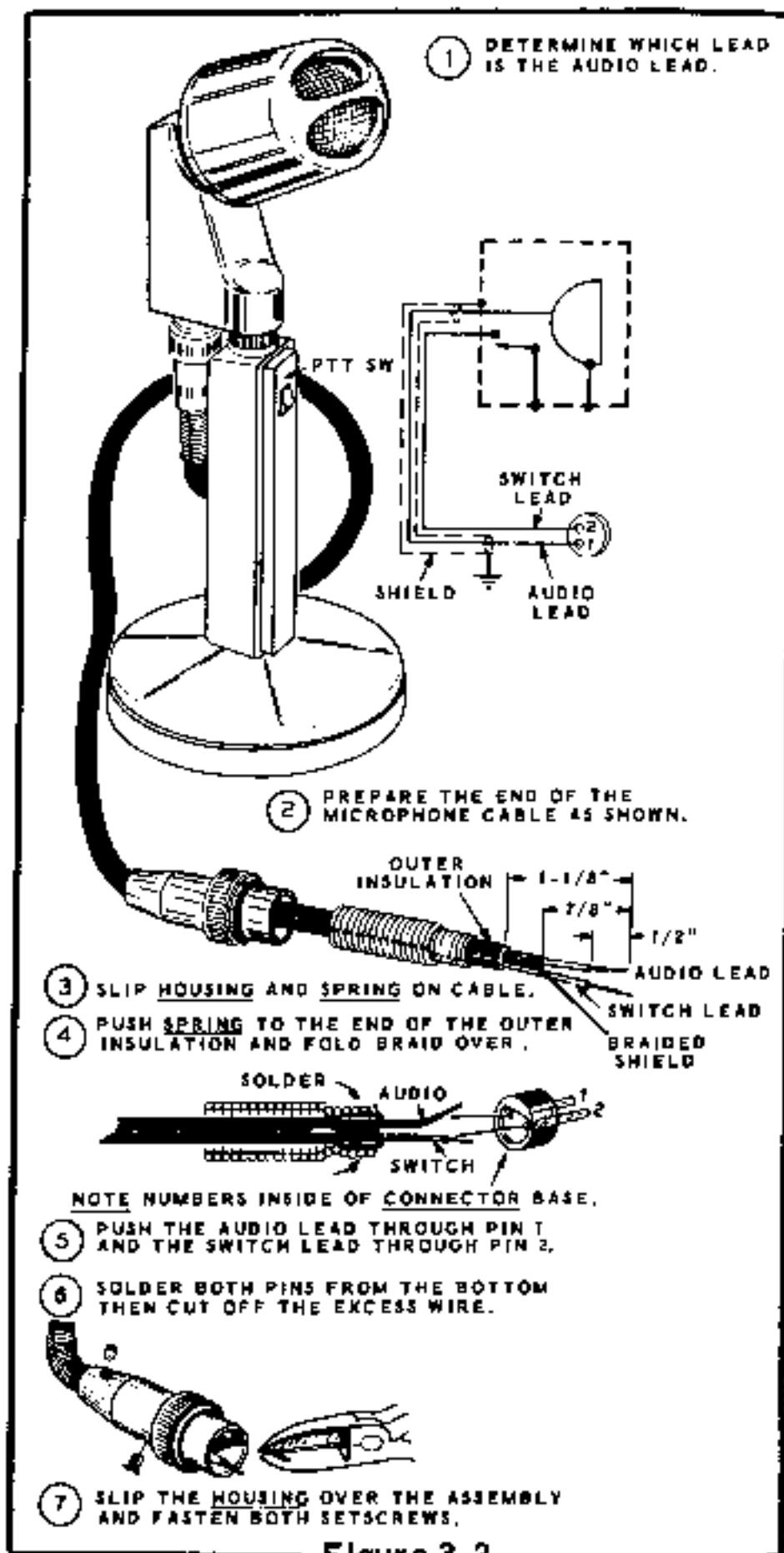

Figure 3-2

in this manner the switch of the microphone will actuate the relay of the Transceiver for PTT operation.

A microphone without a switch can be used for VOX operation if you install the male microphone connector supplied with this Transceiver. The audio lead should be connected to pin #1 and the shield should be connected to the spring of the connector.

INSTALLATION

FIXED STATION

The Transceiver must be placed in a location with adequate ventilation because of the amount of heat given off by the tubes. Inadequate ventilation could cause considerable damage to the circuit components.

The power supply can be mounted in the SB-600 Speaker cabinet (if used) or in some other out-of-the-way place, since it is controlled by the FUNCTION switch of the Transceiver.

Because the Transceiver requires about 300 watts of power when transmitting, it should not be operated from an already heavily loaded AC outlet.

The Transceiver should be grounded to a ground rod or cold water pipe. Make the ground connection to the Transceiver at one of the side-band switch mounting screws.

A doublet antenna fed by RG-58 or RG-59 cable, or an inverted "Vee" type antenna fed with coaxial cable will work very well with the Transceiver. Other types of antennas using high impedance

end-feeding, off-center feeding, open wire lines, or 300 Ω twin lead, can be used if an antenna coupler is used between the antenna and Transceiver. The antenna used must provide a low SWR (standing wave ratio) to the Transceiver for successful operation. Lightning arrestors on the antenna are a must. The antenna should be disconnected and grounded, and the Transceiver should be taken off the air when a lightning storm is near.

The FINAL TUNE knob should peak near the center third of rotation with a properly matched antenna. Connect an SWR bridge to the antenna and make sure the SWR is below 1.5 to 1. Power for operating the bridge may be obtained by carrier output in the TUNE position of the FUNCTION switch.

Use an 8 Ω speaker capable of handling one watt of audio power.

Two typical installations are shown in Figures 4-1 and 4-2. Figure 4-1 shows a basic hookup suitable for either fixed station or mobile operation.

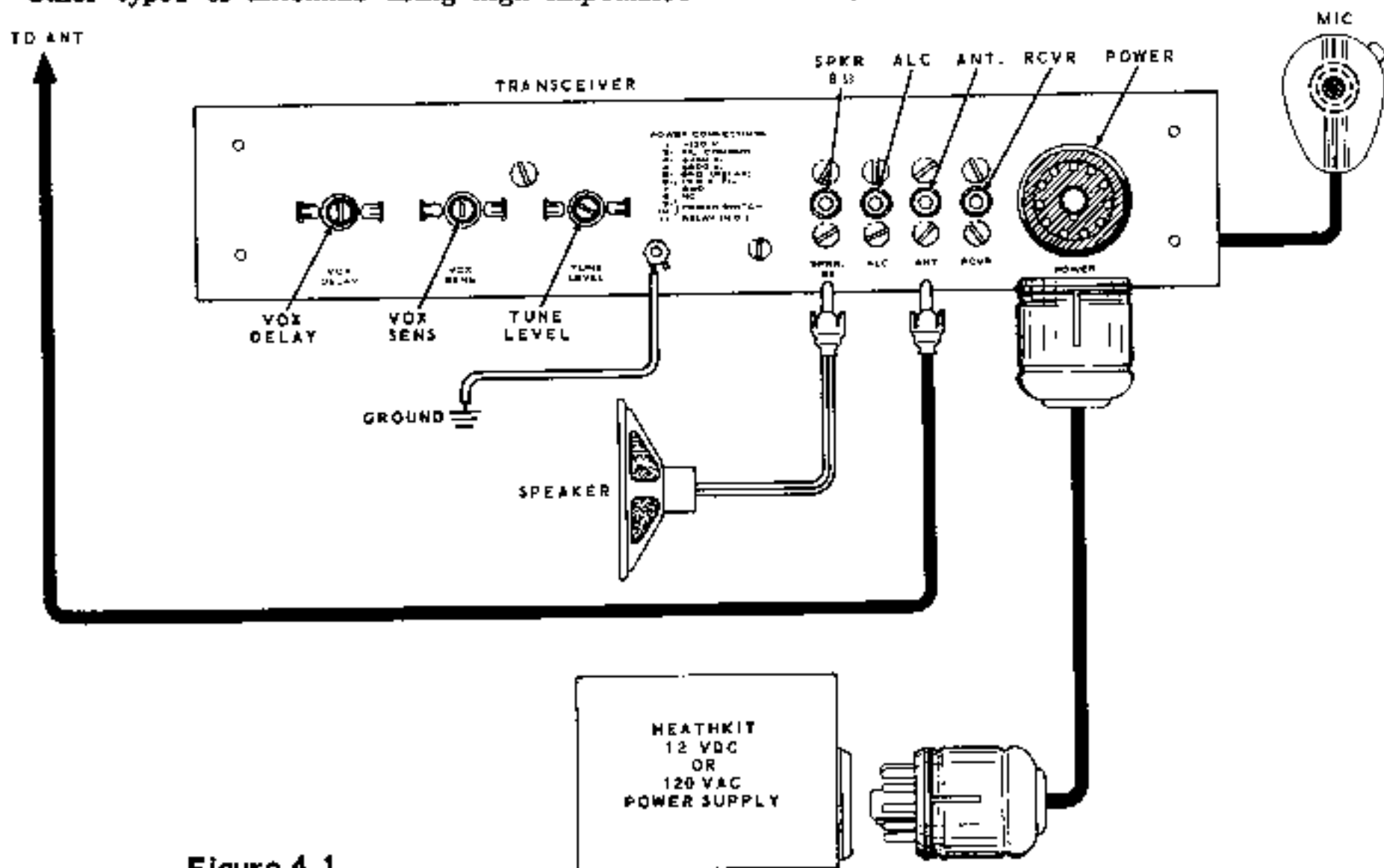

Figure 4-1

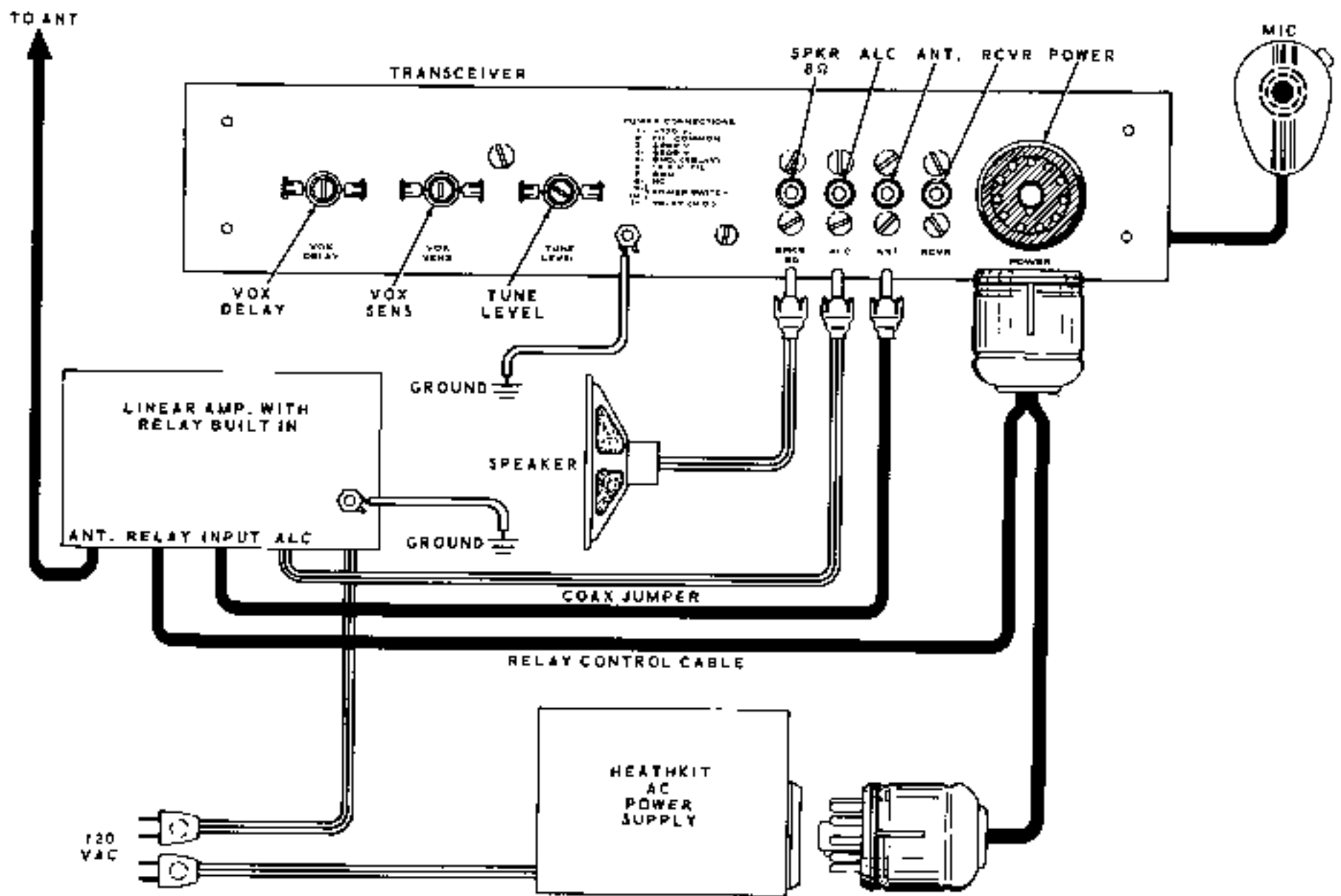

Figure 4-2

Figure 4-2 shows a fixed station installation using a linear amplifier with a built-in antenna relay switched by the Transceiver.

CAUTION: Remember that one side of the External Relay connection in the Transceiver is connected to the chassis. Therefore, it should not be connected to 120 volt AC lines for relay switching. The AC voltage could cause the Transceiver chassis to be "hot," creating a shock hazard. The switching circuit of an AC external relay must be isolated from the Transceiver by using an isolation transformer.

If low voltage DC is used on the relay switching line, be very careful to get the polarity of the voltage connected properly. The grounded DC lead must be connected to the outside of the plug (chassis). Maximum contact ratings of the relay are: 1 ampere at 28 VDC or 120 VAC, non inductive.

MOBILE

Transceiver

The preferred location for the Transceiver for mobile operation is under the dash, although you may desire to mount the unit on the floor. See Figure 3-1 (on Page 43). The gimbal bracket should be mounted in the desired location in the automobile, using the #10 x 1/2" sheet metal screws. The starting holes for these screws should be made with a 9/64" drill, being careful not to drill into existing wiring or instruments. Keep all Transceiver cables clear of the automobile pedals and control cables.

Any cables that have to go through the fire wall will usually fit through existing grommets. If it is necessary to make holes through a sheet metal partition, a long tapered punch usually works better than a drill. A drilled holes leaves sharp edges which can cut the wires. When a punch is



driven through the metal, the sharp edge is rolled back and a smooth hole will result. Be sure to leave enough extra cable so the Transceiver can be removed from the gimbal bracket and operated, to permit adjusting the rear apron controls.

Be sure the voltage regulator of the automobile is set to not exceed 14.5 volts.

Antenna

Mount the antenna according to the manufacturer's instructions. Be sure to make a good ground connection between the shield of the coaxial cable and the car body at the antenna base.

Low-frequency antennas with loading coils must be carefully tuned, as a small change in antenna length changes the SWR considerably. The frequency range of a whip antenna on 75 meters is usually only about 25 kHz; beyond this range, loading becomes difficult or impossible without readjusting the antenna. The resonant frequency of the antenna can usually be located by noting the point of maximum noise when tuning the receiver across the band. As the antenna is adjusted, this point will move.

IMPORTANT NOTE: To make a loaded whip antenna present a 50 Ω load to match the coaxial cable on 75 meters, a capacitor usually must be connected between the base of the antenna and ground. This can be done inside the automobile body as shown in Figure 4-3, or between the antenna and one of the mounting screws, using two solder lugs, as shown in Figure 4-4. A 1000 pf mica capacitor, which is supplied with this kit for this purpose, can be used with most antennas; but a capacitor of a different value, between 300 pf and 1500 pf, may be required for proper operation of the antenna. The antenna will require retuning when the capacitor is installed.

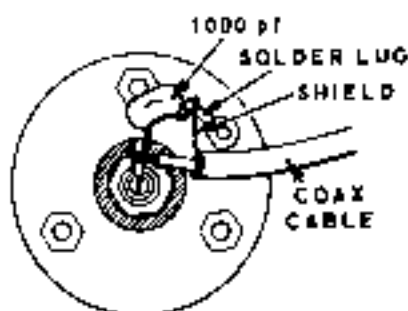

Figure 4-3

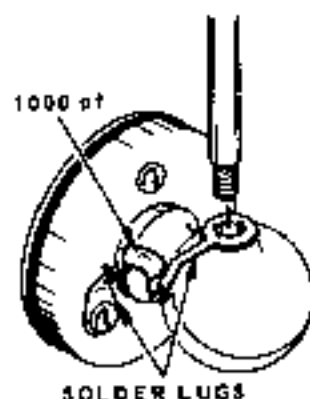

Figure 4-4

A whip antenna that is properly tuned on 75 meters will have a high peak of receiver activity for about 25 kHz around the antenna's resonant frequency. Turn on the receiver and tune through the band to discover where this high peak of receiver activity is at for the present setting of your antenna. Then adjust the length of the whip in 1/4 inch increments and retune the receiver until the peak of receiver activity is centered around the frequency at which you normally operate. The antenna can then be tuned as described in the following steps.

- () 1. Connect an SWR meter in series with the lead to your antenna.
- () 2. Set the SWR meter to the "forward" position.
- () 3. Turn the Meter switch on your Transceiver to BIAS SET. If the meter needle does not point to the small triangle near "3" on the meter, perform the Bias Setting steps on Page 41.
- () 4. Turn the FUNCTION switch to TUNE, and place the Meter switch in the OPERATE-TUNE position.
- () 5. Connect a microphone to the MIC connector.
- () 6. Whistle or hum into the microphone while adjusting the MIC GAIN control for a full-scale meter indication on the SWR bridge.
- () 7. Whistle or hum at the same level and switch the SWR meter to the "reverse" position. Note the SWR reading.
- () 8. Switch the SWR meter to the "forward" position. Then set the transmitter to higher and lower frequencies, and repeat steps 6 and 7 at each frequency, until you find the minimum SWR.
- () 9. Set the transmitter to the desired operating frequency. Then adjust the length of the antenna as follows:

A. If the point of the lowest SWR is lower than the desired operating frequency, shorten the antenna as described below.

B. If the point of lowest SWR is higher than the desired operating frequency, lengthen the antenna as described below.

C. Change the antenna length in 1/4" increments and repeat steps 2, 6, and 7 at each new length until the minimum SWR is obtained. The SWR should be about 1.2 or less at the desired frequency. NOTE: It may be necessary to add a capacitor at the base of the antenna, as described previously, if you cannot get the SWR down to about 1.2.

NOTE: With a properly matched antenna, the FINAL TUNE knob will peak in the center third of its rotation. Since this peak is very broad, due to the fixed input capacitors of the pi network and the limited range of the FINAL TUNE capacitor, there will be only a small rise in the meter indication as the peak is tuned. Meter peaks may also occur slightly beyond the range of the FINAL TUNE capacitor, due to off-resonance operation or the varying of the antenna load impedance at different operating frequencies. However, since the output pi network has a very low Q, the output efficiency will not be much less under these conditions.

Connect the cables and mount the Transceiver in the gimbal bracket. Then position the Transceiver as desired and tighten the thumbnuts.

Accessories

The Heath Mobile Speaker can be installed in an automobile, or a car radio speaker (3.2 to 16 Ω) may be used with reduced efficiency.

Noise Suppression

To obtain good noise suppression, you must suppress electrical interference at its source, so it does not reach the input of the receiver. Once it has been radiated, noise cannot be suppressed by bypassing, etc.

It is difficult to determine the source of various types of noise, particularly when several items are contributing to the noise. Follow the procedure outlined below to isolate and identify the various items that may be producing the major noise interference.

In most cases, one source of interference will mask others. Consequently, it will be neces-

sary to suppress the strongest item first, and then continue with the other steps. Figure 4-5 shows a typical ignition system and the suggested placement of noise suppression components.

1. Position the vehicle in an area that is free from other man-made electrical interference, such as power lines, manufacturing processes, and other automobiles.
2. With the Transceiver turned on, drive the automobile at medium speed. Then let up on the gas, and turn the ignition switch off and to the accessory position. Allow the vehicle to coast in gear. If the noise stops, the major source of interference is from the ignition system.
3. If the noise interference continues from step 2, but at a reduced level, both the ignition and generator systems are at fault.
4. If the noise has a "whine" characteristic, changes in pitch with varying engine speed, and is still present with the ignition off, then the generator is the major source of interference.
5. A distinct but irregular clicking noise, or "hash," that disappears with the engine idling, indicates the voltage regulator is at fault.
6. A steady popping noise that continues with ignition off indicates wheel or tire static interference. This is more pronounced on smooth roads.
7. The same type of interference as in step 6, but more irregular when on bumpy roads, particularly at slow speeds, indicates body static.

Refer to the Troubleshooting Chart on Page 49 and Figure 4-5 (fold-out from Page 51) to help determine how to suppress most noise interference. Naturally, not all vehicles will require suppression to the extent shown in Figure 4-5, but some stubborn cases may require all the suppression components shown, plus shielding of the ignition system.

Bonding of various parts of the automobile may also be necessary, starting from the hood and continuing to the trunk, even including bonding of the transmission line every few feet from the antenna.

Noise Suppression Troubleshooting Chart

TYPE OF NOISE	POSSIBLE CAUSE	RECOMMENDED REMEDY
Loud popping increasing to buzz with increased engine speed.	Ignition system.	<ol style="list-style-type: none"> 1. Replace plugs with resistor type. 2. Loose crimped connections should be cleaned and soldered. 3. Place resistors in distributor system.
Whine; varies with engine speed.	Generator.	<ol style="list-style-type: none"> 1. 0.1 μfd coaxial-type capacitor in series with the armature ("A" lead). 2. Clean commutator. 3. Replace brushes. 4. Ground generator shaft. 5. Parallel trap (#10 wire-coil and suitable capacitor) in series with armature lead, tuned to operating frequency.
Distinct but irregular clicking noise.	Voltage regulator.	<ol style="list-style-type: none"> 1. 0.1 μfd coaxial-type capacitor in series with the battery (B) and armature (A) leads. 2. A series combination of a .002 μfd mica capacitor and a 4 Ω carbon resistor to ground from the field (F) terminal. All components should be mounted as shown in the diagram, close to the voltage regulator.
Same as above.	Energy transfer to primary system.	<ol style="list-style-type: none"> 1. Install bypass capacitors as follows: 0.1 μfd coaxial in the lead from the ignition switch to the coil; 0.5 μfd at the battery lead to the ammeter; 0.5 μfd at the gas gauge; 0.5 μfd at the oil signal switch; 0.5 μfd at the headlight and taillight leads; 0.5 μfd at the accessory wiring from the engine compartment.
Loud popping noise that changes from one type road to another. Most pronounced on concrete.	Wheel static.	<ol style="list-style-type: none"> 1. Install front wheel static collectors (available from most automotive distributors). These should be checked every 5000 miles for excessive wear.
Same as above.	Tire static.	<ol style="list-style-type: none"> 1. Injection of anti-static powder into tire through valve stem.
Irregular popping noise when on bumpy roads, particularly at slow speeds.	Body static.	<ol style="list-style-type: none"> 1. Tighten all loose screws. 2. Use heavy flexible braid and bond the engine to the frame and fire wall. Bond the control rods, speedometer cable, exhaust pipes, etc., to the frame.

If an extensive amount of suppression is required, the engine should be retimed and tuned up at a reputable garage.

OPERATION

NOTE: IT IS NECESSARY TO HAVE AN AMATEUR RADIO OPERATOR AND STATION LICENSE (GENERAL CLASS PRIVILEGES) TO PLACE THIS TRANSCEIVER ON THE AIR. Information regarding licensing and amateur frequency allocations may be obtained from publications of the Federal Communications Commission or the American Radio Relay League.

FUNCTION OF OPERATING CONTROLS

Figure 5-1 contains a brief description of the function of each control. Read the control descriptions carefully; then proceed with the following information.

VFO

Tune the VFO for the most natural-sounding voice when receiving.

Since they are already locked together in frequency, it is not necessary to zero beat the receiver frequency with the transmitter. Therefore, be careful not to disturb the VFO dial during a contact because your transmitted signal frequency will change.

SIDEBAND SELECTION

The lower sideband (LSB) is generally used on the 75-meter band. Shifting from the lower to the upper sideband (USB) causes a shift in the operating frequency of 3.4 kHz. This makes it necessary to retune the VFO to get back on the same operating frequency. The dial will read 3.4 kHz high in the USB position.

RECEIVING

The Transceiver is quite simple to operate, since there is little tuning to do after it is aligned. Turn the Transceiver on by placing the FUNCTION switch in the PTT position. After a short warmup period, stations should be heard by tuning the VFO dial. The volume is adjusted by the RF ATTN and AF VOL controls.

With the Meter switch in the OPERATE TUNE position, and the RF ATTN control at the maximum clockwise position, the meter will indicate received signal strength in "S" units, and db over S9. Normally, the RF ATTN control is

operated at this maximum clockwise position. If signals are extremely strong, the RF ATTN control can be reduced to give the desired volume level, but the S METER reading will be reduced, since this control can attenuate the input signal by as much as 30 db.

TRANSMITTING

After an operating frequency has been selected by tuning the VFO dial, turn on the transmitter by placing the FUNCTION switch in the TUNE position. Then change the Meter switch to OPERATE TUNE, and adjust the FINAL TUNE control for a maximum indication on the meter. This indicates proper tuning and maximum output power. Now put the transmitter "on the air" by placing the FUNCTION switch in the PTT or VOX position.

The meter will indicate ALC voltage while you are transmitting, when the Meter switch is set to OPERATE TUNE. As the operator talks, the meter should deflect a couple of S units, indicating maximum output peaks. The meter may rest above or below the zero mark while transmitting without harm. (The Heath Monitorscope can also be used with the Transceiver in fixed-station operation to provide a visual display of transmitter output.)

If the Meter switch is placed in the BIAS SET position while you transmit, the meter will indicate plate current variations of the final RF amplifiers. Normal talking should produce peaks at about S6 on the meter, with loud steady tones resulting in full-scale peaks. If the peaks of average talking levels are above S9, the MIC GAIN is set too high, and should be reduced to where the S6 level peaks are produced.

To keep the transmitter in peak operating condition, it should be adjusted periodically as directed in the Alignment and Adjustment section of the Manual. The BIAS ADJ control setting should also be checked and adjusted whenever power supplies are changed. After alignment has been completed and the carrier properly nulled, the bias level can be checked and adjusted anytime by observing the meter in the BIAS SET position when the PTT button is pressed, with no modulation.

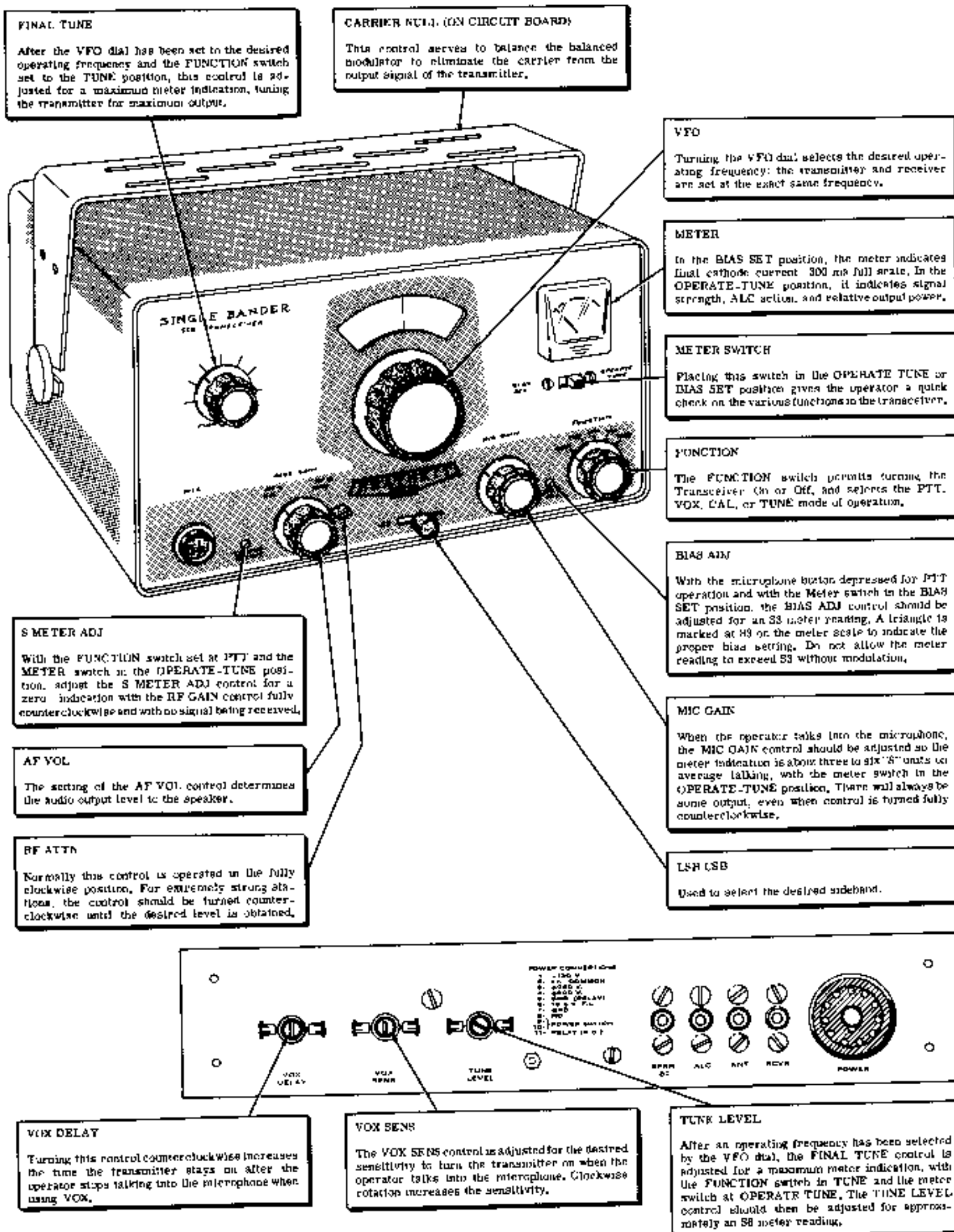

Figure 5-1

VOX

To use the voice controlled relay, place the **FUNCTION** switch in the **VOX** position. Adjust the **VOX SENS** control for the microphone sensitivity desired to turn on the transmitter. The **VOX DELAY** control should be adjusted for the hold-in time desired after the operator stops talking.

ANTENNA

The antenna must have a low SWR (standing wave ratio), since the output of the Transceiver has fixed loading and a limited tuning range. The antenna tuning should be checked with a reflected power meter or SWR bridge to make sure it has an SWR of 1.5 to 1, or less. Operation with a high SWR will result in overloading the output tubes. When using an SWR bridge, a carrier may be obtained for tuning the antenna by switching the **FUNCTION** switch to the **TUNE** position. Do not overload the SWR bridge when transmitting SSB, since the peak output power is much higher than the output power in the **TUNE** position.

The antenna must be matched to, and fed with, 50 Ω coaxial cable for best results; the transmitter is not designed to load into random lengths of wire or open-wire transmission lines.

Special care must be taken with mobile installations, since short-loaded and center-loaded antennas are very critical to tune. An operating frequency change of 10 or 20 kHz will often change the antenna tuning considerably. Better antennas, with loading coils, have higher "Q" and sharper tuning. Follow the antenna manufacturer's instructions carefully to obtain proper adjustment.

CRYSTAL CALIBRATION

The Heathkit plug-in Crystal Calibrator will provide convenient, accurate signals at 100 kHz intervals for receiver dial checking. The Crystal Calibrator can be plugged into the calibrator socket of the Transceiver. It is turned on by placing the **FUNCTION** switch in the **CAL** position. Do not transmit when in the **CAL** position because of possible interference.

SHIPPING INFORMATION

If you should find it necessary to return your Transceiver to the Heath Company, refer to the Shipping Instructions in the Kit Builders Guide. Also, if you have the plug-in Crystal Calibrator,

some packing material should be placed around it to keep it in place in the kit. Otherwise it may work loose and break the tubes in the Transceiver during shipping.

IN CASE OF DIFFICULTY

1. Recheck the wiring. Trace each lead in colored pencil on the Pictorial as it is checked. It is frequently helpful to have a friend check your work. Someone who is not familiar with the unit may notice something consistently overlooked by the builder.
 2. About 90% of the kits that are returned for repair do not function properly due to poor connections and soldering. Therefore, many troubles can be eliminated by reheating all connections to make sure that they are soldered as described in the Proper Soldering Techniques section of the Kit Builders Guide.
 3. Check to be sure that all tubes and cable connections are in their proper locations. Make sure that all tubes light up properly.
 4. Check the tubes with a tube tester or by substitution of tubes of the same types that are known to be good.
 5. Check the values of the parts. Be sure that the proper part has been wired into the circuit, as shown in the Pictorial diagrams and as called out in the wiring instructions.
 6. Check for bits of solder, wire ends, or other foreign matter, which may be lodged in the wiring.
 7. If, after careful checks, the trouble is still not located and an ohmmeter and voltmeter are available, check the resistance and voltage readings against those shown in Figures 6-1, 6-2, 6-3, and 6-4. NOTE: All voltage readings were taken with an 11 meg-ohm input digital voltmeter. Voltages may vary as much as $\pm 10\%$.
 8. A review of the Circuit Descriptions will help you to know where to look for trouble.
 9. Check the power supply and antenna.
- NOTE: To aid in servicing or troubleshooting the Transceiver, refer to the Circuit Board X-Ray Views and Chassis Photos shown in Figures 7-1 through 7-3 on Pages 64 through 66.
- Breaks in the foil of the circuit board can be detected by placing a bright light under the foil side of the board and looking through the board from the lettered side. A break will appear as a hair-line crack in the foil.

TROUBLESHOOTING CHART

TRANSMITTER DIFFICULTIES	POSSIBLE CAUSE
CARRIER NULL control changes carrier level, but not to a low enough level.	<ol style="list-style-type: none"> 1. FUNCTION switch in TUNE position, inserting carrier. 2. Crystal diodes CR1 through CR4 installed backwards or are faulty. 3. Transformer T1 incorrectly aligned. 4. Microphone picking up noise.
No relative power indication.	<ol style="list-style-type: none"> 1. Resistor R61 burned out, due to transmitting without antenna. 2. Antenna shorted. 3. TUNE LEVEL set too low. 4. Faulty diode CR60.
Chopped or broken modulation, especially on peaks.	<ol style="list-style-type: none"> 1. MIC GAIN control set too high. 2. Faulty microphone cable or connections. 3. Receiver cutoff bias line partially shorted. Check voltages and resistances.
Radical change in BIAS SET reading.	<ol style="list-style-type: none"> 1. FUNCTION switch in TUNE position. 2. Changed power supplies without rechecking transmitter adjustment. 3. Faulty BIAS ADJ control.
Transceiver locked in transmit mode.	<ol style="list-style-type: none"> 1. VOX DELAY control set too high. 2. Push-to-talk button stuck in depressed position. 3. Tube V10 faulty.
Plates of RF final amplifier tubes get red hot.	<ol style="list-style-type: none"> 1. No bias on tubes. Check voltages and resistance. 2. No antenna; antenna open or shorted. 3. Antenna plugged into wrong socket. 4. Power supply voltage too high.
Very low input to grids of RF final amplifier tubes from driver V5.	<ol style="list-style-type: none"> 1. Coils L2 and L3 improperly installed. Check color dot markings. 2. T2 not aligned properly.
Very low output, receiver works ok.	<ol style="list-style-type: none"> 1. Antenna plugged into RCVR socket instead of ANT socket.



RECEIVER DIFFICULTIES	POSSIBLE CAUSE
Receiver squeals and oscillates with no antenna connected.	<ol style="list-style-type: none"> 1. Transmitter cutoff bias line partially shorted, turning on portions of the transmitter. Check voltages and resistances. 2. Jumper wire not installed between pins 5 and 6 of tube socket V14. 3. Faulty capacitor C121.
Received signals cannot be tuned in properly.	<ol style="list-style-type: none"> 1. Wrong sideband. 2. Sideband switch in dead spot, push switch to desired position.
Poor sensitivity.	<ol style="list-style-type: none"> 1. Jumper wire between D and D installed wrong.
No sound from speaker.	<ol style="list-style-type: none"> 1. RCVR GAIN controls turned down. 2. Speaker unplugged or faulty. 3. Unit is transmitting. 4. Relay is not grounding receiver cut-off line. 5. Tube V11 or V12 faulty.
Sidebands reversed.	<ol style="list-style-type: none"> 1. Sideband switch assembly wired incorrectly.

GENERAL DIFFICULTIES	POSSIBLE CAUSE
Receive RF burns when removing antenna connector.	<ol style="list-style-type: none"> 1. Transmitter tripped on by noise when in VOX operation. 2. FUNCTION switch in TUNE position.
Transceiver chassis "hot" causing electrical shock with linear amplifier connected.	<ol style="list-style-type: none"> 1. Ungrounded high voltage connected to external relay connection. See Installation section of Manual.
Filaments stay lit when Transceiver is turned OFF.	<ol style="list-style-type: none"> 1. Improper power supply connections.
Meter reads backwards.	<ol style="list-style-type: none"> 1. Meter improperly wired. 2. Meter switch improperly wired. 3. S METER ADJ control not set properly.
No output from VFO, V14.	<ol style="list-style-type: none"> 1. Wrong or faulty tube in socket V13 or V14. 2. VFO capacitor shorted by improper installation of mounting screw.
VOX cycles.	<ol style="list-style-type: none"> 1. VOX SENS control set too high. 2. Faulty microphone cord or connection. 3. Section C of relay making poor contact. 4. Ambient noise level too high.

SPECIFICATIONS

RECEIVER SECTION

Frequency Coverage,	3.8 to 4.0 megahertz.
Receiving Mode,	Lower or upper sideband.
Sensitivity,	1 microvolt of input signal will provide at least a 15 db signal-plus-noise to noise ratio.
Selectivity,	2.7 kilohertz at 6 db down. 6 kilohertz at 50 db down.
Intermediate Frequency (IF),	2.305 megahertz.
Image Rejection,	100 db.
IF Rejection,	50 db.
Antenna Input Impedance,	50 Ω , unbalanced.
Receiver Audio Response,	400 to 3000 hertz.
Receiver Audio Power Output,	1 watt.
External Speaker Impedance,	8 Ω impedance.

TRANSMITTER SECTION

Frequency Coverage,	3.8 to 4.0 megahertz.
Transmitting Mode,	Lower or upper sideband.
Frequency Stability,	Drift less than 200 hertz per hour after warmup.
RF Power Input,	200 watt P.E.P.
Output Impedance,	50 Ω , unbalanced.
Transmitter Audio Response,	400 to 3100 hertz.
Microphone,	High impedance crystal, ceramic, or dynamic (between -45 db and -60 db output).
Unwanted Sideband Suppression,	45 db minimum below peak output with 1000 Hz modulation.
Carrier Suppression,	45 db minimum below peak output.



CONTROLS

Front Panel,	VFO tune. FINAL TUNE. Meter switch, FUNCTION. S METER ADJ. RF ATTN. AF VOL. MIC GAIN. BIAS ADJ. Sideband switch.
Circuit Board,	CARRIER NULL.
Chassis Rear,	VOX DELAY. VOX SENS. TUNE LEVEL.

GENERAL

	12.6 V, AC or DC	800 V DC B+	250 V DC B+	-130 V DC Bias
Power Requirements -				
Transmit,	3.75 amp	250 ma peak	100 ma	5 ma
Receive,	3.75 amp	-0-	65 ma	5 ma
Crystal Calibrator (Accessory),3 amp	-0-	2 ma	-0-

Tube Complement,	3 - 6EA8: Microphone amplifier and AF cathode follower - Transmitter IF amplifier and relay amplifier - RF amplifier and receiver mixer. 5 - 6AU6: VFO - VOX amplifier - IF amplifiers (2) - Transmitter mixer. 1 - 6BE6: VFO cathode follower. 1 - 12BY7: Transmitter driver. 1 - 12AT7: Product detector and carrier oscillator. 1 - 6EB8: AF amplifier and AF output. 2 - 6GE5: Transmitter RF output.
Cabinet Dimensions,	6-1/4" high x 12-1/4" wide x 10" deep. Add 1" to height, width, and depth for gimbal bracket, knobs, and connecting plugs.
Net Weight,	12 lbs.

Equipment Used To Prepare Specifications.

Heathkit IM-11 VTVM with 309-C RF Probe,
 Heathkit HO-10 Monitorscope,
 Heathkit IG-72 Audio Generator,
 Heathkit IM-12 Distortion Meter,
 Heathkit HN-31 Antenna,
 Panoramic Radio Products, Inc. "Panalyzer,"
 Model SB-12A,
 Hewlett Packard, Signal Generator, Model 606A,
 Tektronix Oscilloscope, Model 515A,
 Esterline Chart Recorder, Model AW,
 Boonton RF Voltmeter, Model 91-CA,
 Dynascan Digital Voltmeter, Model III.

Equipment Needed To Check And Calibrate. . .

VTVM and RF Probe,
 Dummy load,
 Reflected power meter,
 Frequency standard,
 Crystal-calibrated receiver, covering the 75-
 meter band, or an accurate broadcast receiver.

The Heath Company reserves the right to discontinue instruments and to change specifications at any time without incurring any obligation to

incorporate new features in instruments previously sold.

CIRCUIT DESCRIPTION

The circuit of the Transceiver may be more easily understood if you refer to the Schematic Diagram (fold-out from Page 67) and Block Diagram (fold-out from Page 56) while reading the Circuit Description.

SCHEMATIC DIAGRAM

The letter-number designations on the Schematic Diagram are used to identify resistors, capacitors, chokes, etc. Each of these designations is related by its first number or two to the tube stage in which it is used. For instance, the resistors in tube stage V1 are designated R10, R11, etc. In tube stage V12 they are marked R120, R121, etc. This system of circuit component designation is used throughout the Schematic.

Numbers in diamonds on the Schematic refer to the terminals on the circuit board and the color coding of the cable assembly wires. Numbers 1 through 9 indicate solid colors; numbers 10

through 18 refer to wires with a white background and a single color stripe; and numbers 20 through 28 refer to wires with a white background and two identical color stripes. The numbers can be related to wire colors by using the same color code as used for resistors: brown = 1, red = 2, orange = 3, etc.

TRANSMITTER SECTION

Microphone Amplifier V1A

Voice signals from the microphone are coupled through capacitor C12 to the grid of microphone amplifier tube V1A. The amplified signal at the plate of V1A is coupled through C14 to the Mic Gain control, and through capacitor C102 to the VOX (voice operated transmitter) circuit. The setting of the Mic Gain control determines the amount of modulation. Since V1A supplies signals for modulation and for VOX, it operates during both receiving and transmitting. Capacitor C201 bypasses to ground



any RF signal picked up by the microphone push-to-talk switch lead.

Audio Frequency Cathode Follower

The audio signal from the Mic Gain control is applied to AF (audio frequency) cathode follower stage V1B. This stage matches the tube impedance to that of the balanced modulator. Bypass capacitor C19 keeps the modulator RF voltages from reaching V1B. During receiving, the relay cuts off V1B and a number of other transmitter stages.

Balanced Modulator

When the audio signal from V1B and the RF signal from carrier oscillator V11B are applied to the 4-diode balanced modulator, two different frequencies are produced. This ring-type balanced modulator uses diodes CR1 through CR4.

One of the two signals produced by the balanced modulator is the sum of the audio and carrier frequencies; the other signal is the difference between the audio and carrier frequencies. These signals are the upper and lower sidebands.

The carrier signal is applied across the modulator diode ring in a balanced circuit, consisting of one winding of transformer T1, capacitors C1 and C2, resistors R3 and R4, and the Carrier Null control. The Carrier Null control is used to balance out the carrier signal in the modulator, leaving only the upper and lower sideband signals at the modulator output.

The output from the balanced modulator is the result of combining the audio and carrier signals. Neither the audio or carrier signals appear in the output, but the effect of the audio signals unbalancing the nulled circuit at an audio rate produces the sum-and-difference frequencies called sidebands. With no audio, there is no output from the balanced modulator.

With the Function switch in the Tune position, a DC voltage is applied to the balanced modulator through resistors R1 and R2. This voltage can be adjusted with the Tune Level control. This DC voltage is used to unbalance the modulator to provide a steady output signal for transmitter tuning purposes.

Transmitter IF Amplifier

NOTE: Throughout the Circuit Description, it will be assumed that the Sideband switch is in the LSB position.

The sideband signals from the balanced modulator are coupled through transformer T1 and then are amplified by transmitter IF amplifier V2A. These signals are then applied to a crystal filter, consisting of crystals Y2 through Y5, and coil L1. The crystal filter eliminates the upper sideband, and permits the lower sideband to pass through to common IF amplifier V3 for additional amplification. (If the Sideband switch were in the USB position, the lower sideband would have been eliminated and only the upper sideband would pass through the crystal filter.)

Stage V2 is turned off while receiving by applying additional negative DC voltage to its grid through the secondary of transformer T1. This control voltage is impressed on the ALC (automatic level control) line, which is also used to control the gain in a number of other transmitter stages to prevent overloading. Overloading can be detected by observing the action of the meter. Normally the meter rests at or slightly below zero; however, if the operator talks too loud or if the Mic Gain control is set too high, the transmitter section would overload. This causes a change in ALC voltage which increases the bias, reducing transmitter gain and causing meter deflection to indicate ALC action.

Common IF Amplifier V3

When transmitting, V3 amplifies the lower sideband signal from the crystal filter, and then applies this signal to IF transformer T2. When receiving, the receiver IF signal is amplified by V3 and is then applied to receiver IF amplifier V9.

Transmitter Mixer V4

Transmitter mixer V4 receives two signals simultaneously; one is the SSB signal from T2, and the other is the VFO (variable frequency oscillator) signal from V13 and V14, which is coupled through the secondary of transformer T2. Tube V4 produces the frequency sum of these signals, which is at the proper operating frequency. This signal is applied to the primary of coil L2. (Tube V4 is cut off by bias voltage from the ALC line when receiving).

Coil L2, which has two windings, is broad-tuned to cover the 75-meter band. This coil is also used when receiving, and is then connected to receiver RF amplifier V8A and receiver mixer V8B.

Driver V5

Driver V5 receives the signal voltage from coil L2 through parasitic suppressor resistor R50. The ALC line is also connected to V5 to control transmitter gain, and to cut off the driver when receiving. Single-tuned coil L3 and double-tuned coil L2 form a bandpass device that covers the frequencies of the 75-meter band without the necessity of tuning the driver stage. Voltage for bridge neutralization of final amplifier tubes V6 and V7 is fed through capacitors C63 and C64 to the bottom of coil L3, and across C55. The small winding of coil L3 is used for the input signal from the antenna when receiving.

RF Final Amplifiers

RF Final Amplifiers V6 and V7 are connected in parallel. High voltage plate connections are under the chassis. The grids are connected by a long foil strip on the circuit board. This strip is bypassed at its ends by capacitor C61 and C71 to suppress VHF oscillations. Cathode resistor R71 is a meter shunt for measuring cathode current when the meter switch is in the Bias Set position.

Tubes V6 and V7 are operated as linear amplifiers, with high power sensitivity. Grid load resistor R72 is connected to the Bias Adj control through R73, to allow adjustment of the grid voltage for proper operation. The Bias Adj control is grounded through resistors R75 and R203 when transmitting. When receiving, this control is grounded through resistors R76 and R77 to increase the grid bias to cut off the final tubes.

Automatic Level Control (ALC)

No grid current is drawn by tubes V6 and V7 in normal linear operation; however, when higher than normal grid drive is applied, grid current will flow and change the bias voltage. This higher-than-normal grid drive, caused by too much audio signal, makes the bias voltage change at an audio rate. This varying bias voltage is coupled through capacitor C75 to diodes D70 and D71, which rectify the signal to

develop the negative ALC voltage, which is applied to V2A, V4, and V5. Resistors R78 and R79, along with capacitor C74, filter this voltage and provide the proper time delay for ALC action. The entire ALC circuit is biased above ground by resistors R76 and R77 to cut off the transmitter section when receiving.

Transmitter Output Circuit

The plates of the RF amplifier tubes are connected to the supply voltage by choke RFC61. Their signal is coupled to the pi-section output circuit through capacitor C67. Output coil L4 is tuned by the Final Tune capacitor. Antenna loading is fixed by capacitor C77 for a 50 Ω load. With the Function switch in the Tune position, a sampling of the output voltage from resistors R61 and R62, and diode CR60, gives a meter indication to indicate proper adjustment of the Final Tune capacitor.

TRANSMIT-RECEIVE RELAY SWITCHING

Switching between transmitting and receiving is done by the relay. Section A of the relay switches the antenna, and section C switches the bias voltages.

Section B of the relay, which is connected to the external relay connection at the Power plug, can be used to control external equipment, such as a linear amplifier or antenna relay. Because one side of the external relay connection is grounded to the Transceiver chassis, the connection must not be used to switch any voltage in a circuit that operates above ground, as the chassis would become "hot," causing a possible shock hazard.

VOX AMPLIFIER V10 AND RELAY AMPLIFIER V2B

The Transceiver can be switched from receive to transmit by either the push-to-talk or the VOX method. VOX Amplifier V10 is normally operated in a saturated condition; that is, with very low plate voltage and maximum plate current. Positive half cycles of the voice signals from V1A have no effect on V10. However, the negative half cycles cause the plate current to drop, thus increasing plate voltage. This increased plate voltage fires the neon lamp, providing a positive switching action. The voltage from the neon lamp is then amplified by relay

detector V11A. Also a signal from carrier oscillator V11B is fed to the cathode of V11A. A heterodyne mixing action takes place in V11A, resulting in an output signal which is the difference frequency of these two signals; an audio signal. Capacitors C111 and C112 bypass any RF signal coming from V11A, but permit the audio signal to pass through to AF amplifier V12B. The output from V12B is fed to the AF output amplifier V12A through the AF Vol control, and to the AVC circuit.

Automatic Volume Control

Audio voltage is coupled to diodes D120 and D121 through resistor R128 and capacitor C128. The diodes and capacitor C129 form a voltage doubler, producing a negative DC voltage proportional to the signal strength. Full AVC voltage is applied to the grid of receiver RF amplifier V8A to prevent overloading by strong received signals.

Capacitor C129 in the AVC circuit charges quickly to furnish a fast AVC response time, while the charging of larger capacitor C88 gives a slow AVC release time. Resistors R80, R122, R123, and R124, with capacitor C123, divide the AVC voltage applied to V9 and V12A and provide decoupling. To provide delayed AVC,

resistor R123 is returned to the cathode of V12B rather than to ground. This balances the AVC voltage (which is caused by noise when no signal is being received) with a small positive voltage to improve receiver sensitivity at low signal levels.

CARRIER OSCILLATOR

Carrier oscillator V11B supplies an RF signal to the balanced modulator, and a heterodyning signal to product detector V11A. Tube V11B is a Colpitts type oscillator. Crystal Y1 or Y6 determines the operating frequency to accurately maintain the proper frequency relationship with the crystal filter bandpass frequencies. Capacitors C117 and C118 provide feedback to maintain oscillation. The output is taken from the junction of capacitors C115 and C116. The crystal for the desired sideband is selected by the Sideband switch.

Audio Frequency Output Amplifier V12A

Amplified audio signals from V12A are fed to the speaker socket through output transformer T4. To provide maximum intelligibility, the frequency response of the output stage is limited to the voice frequency range by a sharp-cutoff, high frequency, degenerative feedback loop. High frequencies across RFC120 causes its impedance to rise. The high frequencies are re-



amplifier V2B, which operates the relay. Capacitor C105 and resistor R107 form a delay network that establishes the time the relay stays closed after being tripped. The length of time is determined by the setting of the VOX Delay control.

ANTI-TRIP CIRCUIT

Because the VOX stages operate on both transmit and receive, the speaker signals during receive must be kept from tripping the relay when receiving. This is done by taking a portion of the audio signal from AF output stage V12A, rectifying it with diode D100 to produce a positive voltage, and feeding this voltage to the grid of V10 from the VOX Sens control. This voltage tends to increase the plate current of V10; signals from the microphone (picked up from the speaker) tend to decrease the plate current. Therefore with both signals present at the grid of V10, the signals cancel each other, preventing the speaker from tripping the VOX circuit. Speaking into the microphone produces signals not present in the speaker circuit, permitting the VOX circuit to function normally. The VOX Sens control not only adjusts for proper anti-trip voltage, but also determines the sensitivity of the VOX circuit.

PUSH-TO-TALK CIRCUIT

With the Function switch in the PTT (push-to-talk) position, V10 is disabled by grounding its grid, and V2B is made to operate and close the relay when its grid is grounded (shorting the bias) by the push-to-talk switch in the microphone. The Function switch, in the PTT position, also makes the VOX delay circuit inoperative by removing C105 from ground. Push-to-talk operation with the Function switch in the VOX position uses the VOX delay circuit, causing the receiver to "delay" before coming on after the microphone button is released. The Function switch in the Tune position turns the transmitter on by grounding the grid of V2B.

RECEIVER SECTION

Radio Frequency Amplifier V8A And Receiver Mixer V8B

The incoming signal is connected to RF amplifier V8A through coil L3. The amplified signal from V8A is then coupled through coil L2 to

receiver mixer V8B. During receiving, cutoff bias is removed from the receiver section to permit tubes V8A, V8B, V9, and V12A to operate. V8A is controlled by bias from the AVC (automatic volume control) circuit. AVC in the receiver is similar to ALC in the transmitter, in that it maintains a constant receiver output (gain) even though the incoming signal level may vary considerably. The cutoff voltage on the bias line is controlled by section C of the relay.

The RF ATTN control varies the cathode bias on RF amplifier V1, to permit receiver gain to be reduced, to prevent overloading on very strong signals. This reduction in RF gain will also be reflected in lower meter indications. Operating at a reduced RF gain, however, does not disturb the AGC circuitry, nor will it cut off the receiver completely. It simply reduces strong signals to a level that can be handled by the receiver to provide minimum cross modulation or desensitization.

Crystal Filter

The signal from mixer V8B is coupled to the crystal filter through capacitor C80, which is small in value to avoid upsetting the input impedance of the filter. The crystal filter exhibits the same characteristics in receiving as in transmitting; it shapes the IF passband to have steep sides, a flat top, and a narrow bandwidth. This permits good selectivity for SSB reception in crowded amateur bands.

Common IF Amplifier V3 And Receiver IF Amplifier V9

Signals from the crystal filter are amplified by common IF amplifier V3 and then fed to receiver IF amplifier V9. The cathode and screen of tube V9 are connected directly to those of tube V2A. The meter, which is connected in this circuit, indicates received signal strength in S units, as the AVC voltage changes the current in V9. The meter functions as an ALC indicator when transmitting, without any switching. The gain of V9 is controlled by the AVC voltage applied through resistors R91 and R92.

Product Detector V11A And Audio Frequency Amplifier V12B.

The amplified signal from V9 is coupled through IF transformer T3 to the grid of product de-



turned out-of-phase to the grid of V12B by C126. This signal cancels out the incoming high frequency audio and noise signals at the grid of V12B. Capacitor C120 is a low frequency bypass to ground, and capacitor C127 serves as a parasitic oscillation suppressor.

VFO

Variable frequency oscillator V13 is also a Colpitts type oscillator, which operates at low frequencies for maximum stability. Coil L5 provides the necessary inductance, while capacitors C132, C133, and C134 form a divider for oscillator feedback and output connections. C205 is a negative temperature coefficient capacitor for temperature correction. The oscillator output is taken from the junction of capacitors C133 and C134, and is applied to V14. The harmonics are suppressed by capacitor C134. The signal output from V14 is connected to receiver mixer V8B through capacitor C142, and to transmitter mixer V4 through a filter circuit comprised of choke RFC140, and capacitors C140 and C141. The filter circuit separates the VFO frequencies from the IF and RF signals also present at this point, thus stopping signal leakthrough which would cause spurious oscillation in the IF stages.

ACCESSORY CRYSTAL CALIBRATOR

The accessory plug-in crystal calibrator is turned on by applying B+ to it. This occurs when the Function switch is in the CAL position. The calibrator filament circuit is grounded internally to the calibrator chassis. For this reason, the calibrator chassis must not be grounded to the Transceiver chassis. Resistor R6 is the calibrator plate current return; resistor R5 drops the calibrator filament voltage to 6 volts.

FILAMENTS

The filament wiring of the Transceiver is a series-parallel arrangement that balances the filament voltage without wasting power in dropping resistors. This filament arrangement allows the use of both 6 volt and 12 volt filament tubes in the Transceiver design. The filaments of RF power amplifiers V6 and V7 are isolated by choke RFC60 to prevent RF energy from getting to the other tube filaments.

POWER SUPPLY

Operating voltages for the Transceiver are provided by an external power supply. The power supply is turned on or off by the Function switch, which is wired through the Transceiver Power plug to the external power supply.



REPLACEMENT PARTS PRICE LIST

To order parts, use the Parts Order Form furnished with this kit. If a Parts Order Form is not available, refer to Replacement Parts in the Kit Builders Guide.

PART No.	PRICE Each	DESCRIPTION	PART No.	PRICE Each	DESCRIPTION
RESISTORS			Mylar		
1/2 Watt			27-73	.15	.047 μ fd
1-1	.10	47 Ω	27-85	.25	.22 μ fd
1-3	.10	100 Ω	27-61	.45	.47 μ fd
1-66	.10	150 Ω	27-47	.20	.1 μ fd
1-45	.10	220 Ω	Other Capacitors		
1-4	.10	330 Ω	25-54	.40	10 μ fd tubular electrolytic
1-9	.10	1000 Ω	25-135	.75	20 μ fd vertical electrolytic
1-14	.10	3300 Ω	26-104	2.45	Double-section variable
1-16	.10	4700 Ω	26-35	1.65	Single-section variable
1-19	.10	6800 Ω	COILS		
1-20	.10	10 K Ω	40-509	.75	Crystal filter
1-22	.10	22 K Ω	40-516	1.90	Driver grid
1-25	.10	47 K Ω	40-513	1.20	Driver plate
1-26	.10	100 K Ω	40-510	.80	Final plate
1-29	.10	220 K Ω	52-25	.65	VFO
1-35	.10	1 megohm	CHOKES-TRANSFORMERS		
1-37	.10	2.2 megohm	45-58	.55	13 μ h bifilar choke
1-70	.10	22 megohm	45-51	.25	15 μ h choke
Other Resistors			45-3	.30	1 mh choke
1-28-1	.10	100 K Ω 1 watt	45-4	.40	1.1 mh choke
3-2-2	.25	.33 Ω 2 watt	45-47	.30	2 mh choke
1-21-1	.35	20 Ω 2 watt	51-55	1.75	Audio output transformer
1-17-2	.20	6800 Ω 2 watt	52-63	1.10	2.305 MHz transformer
1-22-2	.20	12 K Ω 2 watt	CONTROLS-SWITCHES		
CAPACITORS			10-130	.75	200 Ω bushing-mount control
Mica			10-17	.55	1 megohm bushing-mount control
20-96	.15	36 pf	10-57	.35	10 K Ω tab-mount control
20-102	.15	100 pf	10-58	.35	100 K Ω tab-mount control
20-112	.25	310 pf	10-127	.35	1 megohm tab-mount control
20-131	.25	360 pf	12-73	1.70	1 megohm/25 K Ω dual tab-mount control
20-122	.30	1000 pf	60-13	.20	DPDT slide switch
20-127	.40	1300 pf	63-427	3.40	5-position rotary with/snap switch
Disc			CRYSTALS		
21-60	.10	18 pf	404-196	3.75	2303.3 kHz
21-32	.10	47 pf	404-197	3.75	2306.7 kHz
21-49	.20	68 pf	404-203	17.75	Package
21-21	.10	200 pf	consisting of the following:		
21-13	.10	500 pf	404-191	2305,100 kHz	} Matched set
21-35	.15	.005 μ fd 1.6 KV	404-192	2303,500 kHz	
21-57	.10	.005 μ fd			
21-31	.10	.02 μ fd			

<u>PART No.</u>	<u>PRICE Each</u>	<u>DESCRIPTION</u>	<u>PART No.</u>	<u>PRICE Each</u>	<u>DESCRIPTION</u>
DIODES-TUBES-LAMPS			GENERAL		
56-26-1	.35	Germanium diode	69-34	5.00	Relay
57-27	.60	Silicon diode	73-1	.10	Rubber grommet
411-11	1.00	6AU6 tube	75-52	.10	Slide switch insulator
411-91	1.20	6BE6 tube	85-69-9	5.00	Circuit board
411-124	1.50	6EA8 tube	259-20	.05	Terminal
411-161	2.20	6EB8 tube	260-7	.05	IF transformer mounting clip
411-185	1.95	6GE5 tube	261-4	.05	Small rubber foot
411-24	1.45	12AT7 tube	261-9	.05	Medium rubber foot
411-69	1.55	12BY7 tube	261-21	.20	Large rubber foot
412-1	.15	#47 pilot lamp	407-99	9.85	Meter
412-11	.20	NE2 neon lamp	431-14	.10	2-lug terminal strip
CONNECTORS-SOCKETS-PLUGS			435-1	.10	11-pin plug mounting ring
432-38	1.10	Male connector	455-11	.10	Split bushing
432-39	1.10	Female connector	455-52	.10	Lever knob bushing
434-42	.10	Phono socket	464-29-1	1.15	Plastic dial
434-44	.15	Pilot lamp socket	490-1	.10	Alignment tool
434-112	.10	7-pin tube socket	490-5	.10	Nut starter
434-105	.15	8-pin tube socket	331-6	.15	Solder
434-79	.15	9-pin tube socket		2.00	Manual (See front cover for part number.)
434-140	.20	12-pin tube socket	METAL PARTS		
434-118	.40	11-pin tube socket	204-576	1.45	Gimbal bracket
438-4	.10	Phono plug	90-265	6.60	Cabinet
438-29	.40	11-pin plug	208-312	1.05	Final shield
440-1	.20	11-pin plug cap	204-182	.10	Final shield mounting bracket
CABLE-WIRE-SLEEVING			204-453	.10	Pilot lamp mounting bracket
134-140	5.90	Cable assembly	100-596-2	2.60	Chassis
343-7	.05/ft	Coaxial cable	100-43	.25	Dial mounting plate
344-50	.05/ft	Black hookup wire	204-732	.10	Switch lever mounting bracket
344-52	.05/ft	Red hookup wire	266-90	.10	Switch lever
346-1	.05/ft	Small sleeving	100-597	1.35	Front panel
346-2	.05/ft	Large sleeving (clear)	HARDWARE		
KNOBS			#3 Hardware		
462-7	.10	Push-on	250-49	.05	3-48 x 1/4" screw
462-106	.10	11/16" diameter	252-1	.05	3-48 nut
462-191	.70	1-1/8" diameter	254-7	.05	#3 lockwasher
462-210	1.05	2" diameter			
462-218	.25	Lever			



<u>PART No.</u>	<u>PRICE Each</u>	<u>DESCRIPTION</u>	<u>PART No.</u>	<u>PRICE Each</u>	<u>DESCRIPTION</u>
#4 Hardware			#10 Hardware		
250-213	.05	4-40 x 5/16" screw	250-83	.05	#10 x 1/2" sheet metal screw
250-273	.05	4-40 x 3/8" screw	250-54	.05	10-32 x 5/8" screw
252-15	.05	4-40 nut	252-49	.45	10-32 x 1-1/4" knurled nut
252-89	.05	4-40 push-on nut	253-19	.05	#10 flat washer
254-9	.05	#4 lockwasher	254-3	.05	#10 lockwasher
			255-44	.10	#10 shoulder spacer
#6 Hardware			1/4" Control Hardware		
250-170	.05	#6 x 1/4" sheet metal screw	252-39	.05	1/4-32 nut
250-56	.05	6-32 x 1/4" screw	253-39	.05	1/4" flat washer
250-89	.05	6-32 x 3/8" screw	253-36	.05	1/4" spring washer
250-13	.05	6-32 x 1" screw	254-14	.05	1/4" lockwasher
250-27	.05	6-32 x 2" screw			
252-3	.05	6-32 nut	3/8" Control Hardware		
253-2	.05	#6 fiber shoulder washer	252-7	.05	3/8-32 nut
254-1	.05	#6 lockwasher	253-10	.05	3/8" flat washer
255-5	.10	#6 x 3/4" spacer	254-5	.05	3/8" lockwasher
255-10	.15	#6 x 1-1/2" spacer			
259-1	.05	#6 solder lug			
#8 Hardware					
250-43	.05	8-32 x 1/4" setscrew			
253-9	.05	#8 flat washer			

The above prices apply only on purchases from the Heath Company where shipment is to a U.S.A. destination. Add 10% (minimum 25 cents) to the price when ordering from an authorized Service Center or Heathkit Electronic Center to cover local sales tax, postage and handling. Outside the U.S.A. parts and service are available from your local Heathkit source and will reflect additional transportation, taxes, duties and rates of exchange.

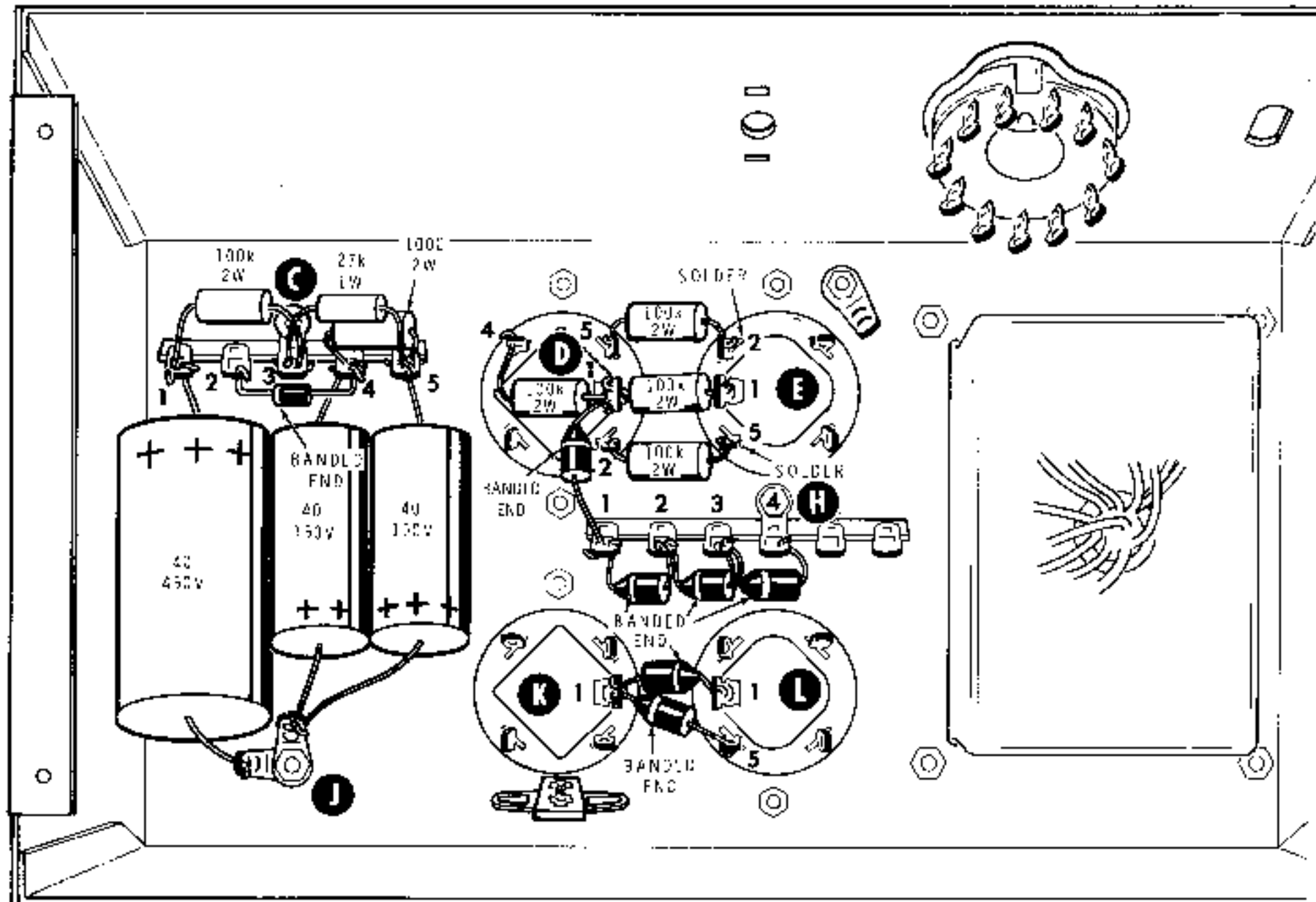

PICTORIAL 6

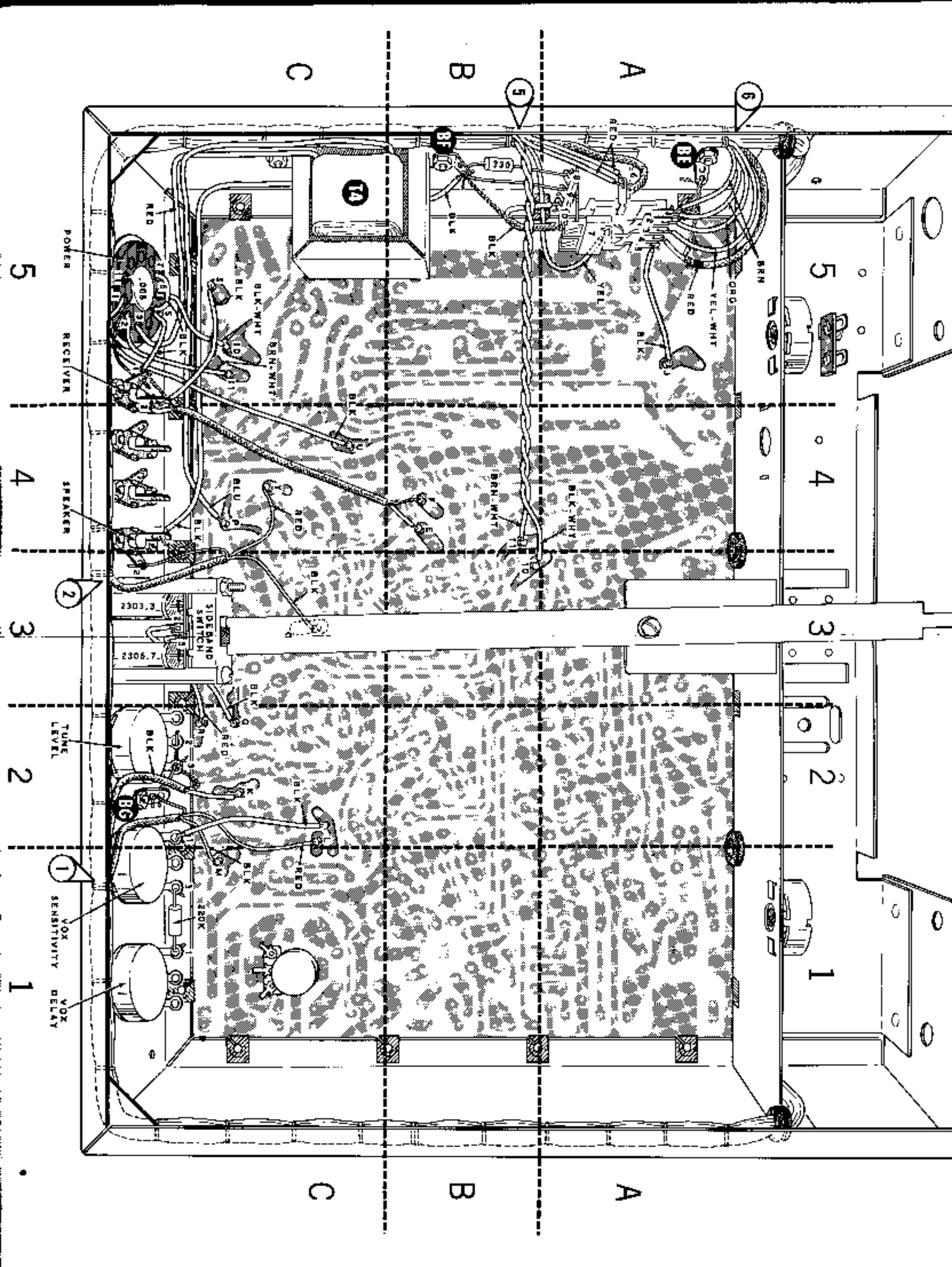

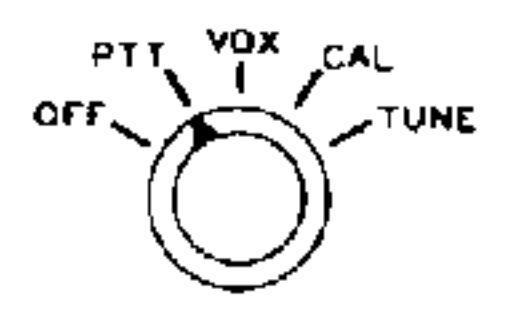
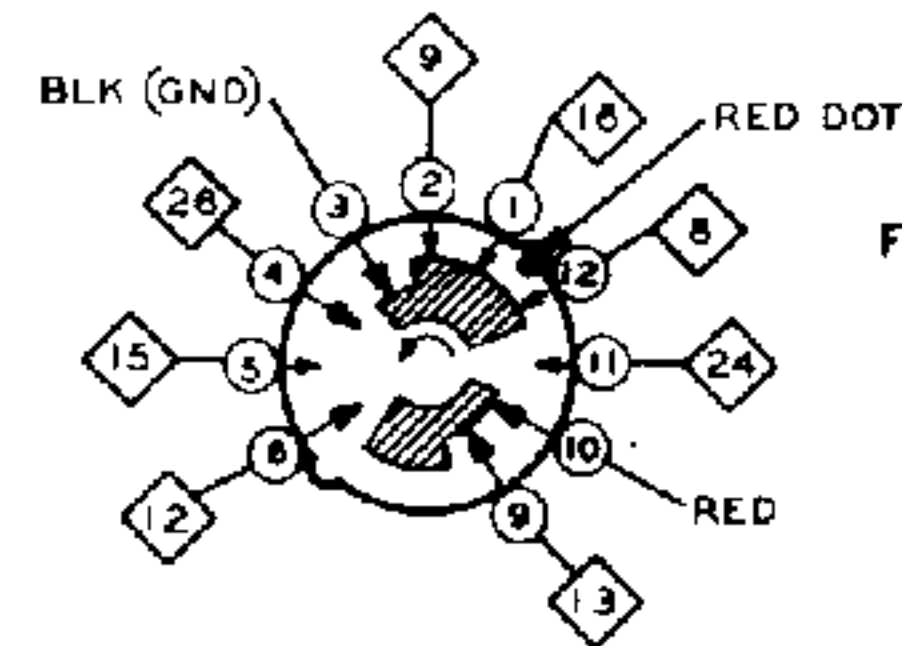
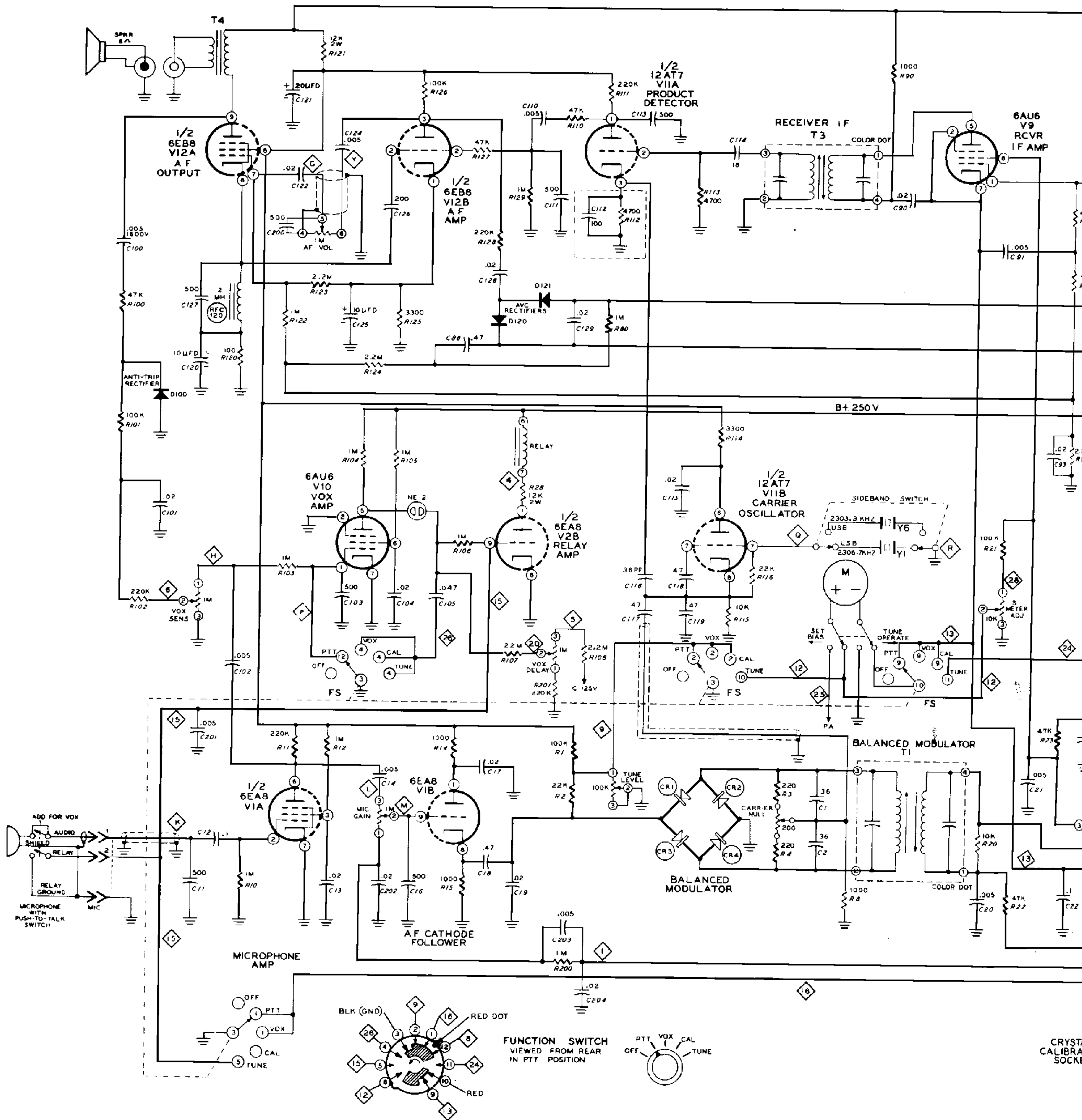

CRYSTAL
CALIBRAT
SOCKET

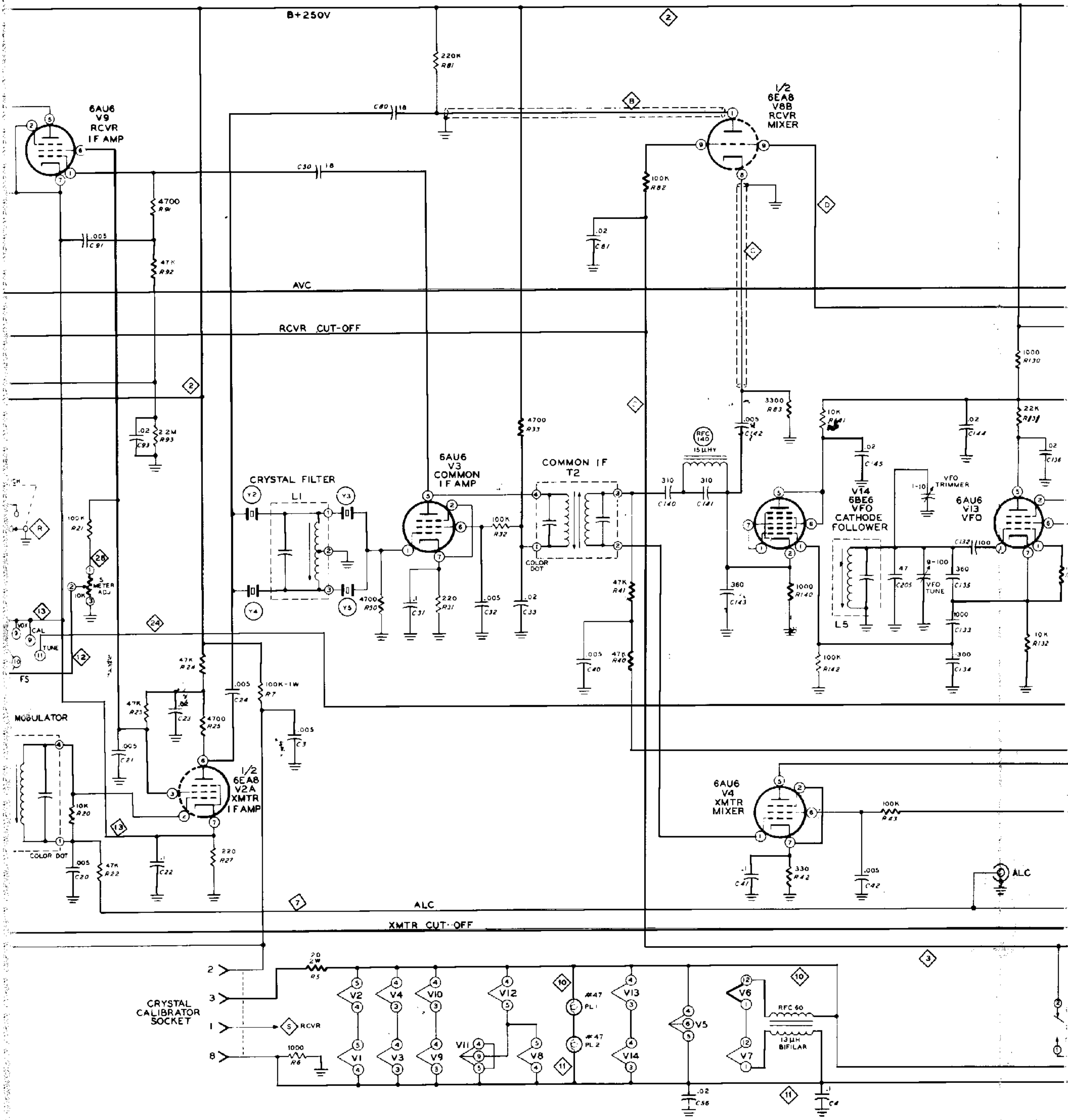

SCHEMATIC OF THE HEATHKIT® 75-METER SSB TRANSCEIVER MODEL HW-12A

NOTES:

1. RESISTOR AND CAPACITOR NUMBERS ARE IN THE FOLLOWING GROUPS:
 - 1-9 PARTS MOUNTED ON THE CIRCUIT BOARD NOT ASSOCIATED TO A TUBE STAGE.
 - 10-149 PARTS MOUNTED ON THE CIRCUIT BOARD.
 - 200-299 PARTS ON THE CHASSIS.
2. ALL RESISTORS ARE 1/2 WATT UNLESS MARKED OTHERWISE. RESISTOR VALUES ARE IN OHMS (K=1000, MEG=1,000,000).
3. CAPACITOR VALUES LESS THAN 1 ARE IN μ F. VALUES OF 1 AND ABOVE ARE IN pF, UNLESS THEY ARE MARKED OTHERWISE.
4. RESISTORS AND CAPACITORS ARE NUMBERED ACCORDING TO THE ASSOCIATED TUBES. EXAMPLES:

R43

RESISTOR PART OF TUBE CIRCUIT V4

THE NUMBER FOR THIS PARTICULAR RESISTOR

C141

CAPACITOR PART OF TUBE CIRCUIT V14

THE NUMBER FOR THIS PARTICULAR CAPACITOR
5. REFER TO THE CHASSIS PHOTOGRAPHS AND CIRCUIT BOARD X-RAY VIEWS FOR THE PHYSICAL LOCATION OF PARTS.
6. SEE FIGURES 6-1, 6-2, 6-3, and 6-4 FOR RESISTANCE AND VOLTAGE MEASUREMENTS.
7. \diamond DENOTES WIRE COLOR CODE OR CIRCUIT BOARD TERMINAL.

