

Assembly
and
Operation
of the



20-METER
SSB TRANSCEIVER

MODEL HW-32



HEATH COMPANY,
BENTON HARBOR,
MICHIGAN

TABLE OF CONTENTS

Specifications.	2
Introduction.	4
General Circuit Description.	5
Construction Notes.	6
Parts List.	7
Proper Soldering Techniques.	9
Circuit Board Wiring And Soldering.	11
Step-By-Step-Procedure.	12
Step-By-Step Assembly -	
Circuit Board Assembly.	12
Parts Mounting - Chassis.	22
Chassis Wiring - Bottom.	24
Cable Assembly Wiring.	26
Chassis Wiring - Top.	34
Initial Test.	35
Resistance Chart.	35
Power Supply.	37
Alignment.	40
Final Assembly.	43
Installation.	45
Operation.	49
In Case Of Difficulty.	50
Circuit Board X-Ray Views.	54
Troubleshooting Chart.	56
Circuit Description.	57
Service Information.	62
Schematic. . . . (fold-out from page).	63
Warranty.	64

SPECIFICATIONS

RECEIVER SECTION

Frequency Coverage.	14.20 to 14.35 megacycles.
Receiving Mode.	Upper sideband.
Sensitivity.	1 microvolt of input signal will provide at least a 15 db signal plus noise-to-noise ratio.
Selectivity.	2.7 kilocycles at 6 db. 6 kilocycles at 50 db.
Intermediate Frequency (IF).	2.305 megacycles.
Image Rejection.	60 db.
IF Rejection.	65 db.
Antenna Input Impedance.	50 Ω , unbalanced.
Receiver Audio Response.	400 to 3000 cps.
Receiver Audio Power Output.	1 watt.
External Speaker Impedance.	8 Ω impedance.

TRANSMITTER SECTION

Frequency Coverage.	14.20 to 14.35 megacycles.
Transmitting Mode.	Upper sideband.
Frequency Stability.	Drift less than 200 cps per hour after warmup.
RF Power Input.	200 watts P.E.P.
Output Impedance.	50 Ω , unbalanced.
Transmitter Audio Response.	400 to 3100 cps.
Microphone.	High impedance crystal, ceramic, or dynamic (10 millivolts minimum output).
Unwanted Sideband Suppression.	45 db minimum below peak output with 1000 cps modulation.
Carrier Suppression.	45 db minimum below peak output.



CONTROLS

Front Panel.	VFO tune. FINAL TUNE. Meter switch. FUNCTION. S-METER ADJ. RF GAIN. AF GAIN (with pull-out switch for accessory crystal calibrator). VOX DELAY. VOX.
Circuit Board.	CARRIER NULL.
Chassis Rear.	MIC GAIN. TUNE LEVEL. FINAL BIAS.

GENERAL

	12.6 V, AC or DC Filament	800 V DC B+	250 V DC B+	-130 V DC Bias
Power Requirements - Transmit.	3.75 amp	250 ma peak	100 ma	5 ma
Receive.	3.75 amp	-0-	65 ma	5 ma
Crystal Calibrator (Accessory).3 amp	-0-	2 ma	-0-
Tube Complement.	3 - 6EA8: Microphone amplifier and AF cathode follower - Transmitter IF amplifier and relay amplifier - RF amplifier and receiver mixer. 5 - 6AU6: VFO-VOX amplifier - IF amplifiers (2) - Transmitter mixer. 1 - 6BE6: Heterodyne oscillator mixer. 1 - 12BY7: Transmitter driver. 1 - 12AT7: Product detector and carrier oscillator. 1 - 6EB8: AF amplifier and AF output. 2 - 6GE5: Transmitter RF output.			
Cabinet Dimensions.	6-1/4" high x 12-1/4" wide x 10" deep. Add 1" to height, width, and depth for gimbal bracket, knobs, and connecting plugs.			
Net Weight.	12 lbs.			
Shipping Weight.	15 lbs.			

Equipment Used To Prepare
Specifications.

Heath IM-11 VTVM with 309-C RF Probe.
Heath HO-10 Monitorscope.
Heath IG-72 Audio Generator.
Heath IM-12 Distortion Meter.
Heath HN-31 Antenna
Panoramic Radio Products, Inc. "Panalyzer,"
Model SB-12A.
General Radio Co., Signal Generator, Model
1001-A.
Tektronix Oscilloscope, Model 515A.
Esterline Chart Recorder, Model AW.
Boonton RF Voltmeter, Model 91-CA.

Equipment Used To Check And Calibrate.

VTVM and RF probe.
Frequency standard.
Crystal Calibrated receiver, covering the 20
Meter band, or an accurate broadcast receiver.

All prices are subject to change without notice.
The Heath Company reserves the right to discon-
tinue instruments and to change specifications at

any time without incurring any obligation to
incorporate new features in instruments pre-
viously sold.

INTRODUCTION

NOTE: An Amateur Radio License that provides
General Class privileges is required to operate
this Transceiver on the air.

The Heathkit Model HW-32 Amateur Transceiver
is a 20-meter SSB(single-sideband) transmitter
and receiver designed for both mobile and fixed
station use.

The receiver and transmitter are locked to-
gether with the continuously running VFO to
insure that both sections operate at the same
frequency. The low frequency VFO is tempera-
ture compensated to provide stable operation.

Provisions have been made for PTT (push-to-
talk) operation. A VOX (voice operated trans-

mitter) circuit is designed into the Transceiver.
Other features include ALC (automatic level con-
trol) to prevent the transmitter from overload-
ing, and AVC (automatic volume control) to main-
tain constant receiver output over a wide range
of input signal strength.

An accessory socket is wired into the circuit
for the Heathkit Model HRA-10-1 Crystal Cali-
brator to provide accurate frequency checks at
100 kc intervals. Connection on the rear of the
Transceiver for switching an external antenna
relay makes the Transceiver easy to connect
to a linear amplifier. Power for the Transceiver
can be obtained from Heathkit mobile or fixed
station Power Supplies. Equivalent power sup-
plies can be used.

GENERAL CIRCUIT DESCRIPTION

This brief circuit description is intended only to familiarize you with the Transceiver. We suggest that you read this information before proceeding with assembly. A more detailed circuit description can be found on Page 57. You may want to study the detailed circuit description as time allows after assembly is completed.

When reading this circuit description, it may be helpful to follow the circuit on the Block Diagram. In the Block Diagram, the receiver stages are located across the top, the transmitter stages across the bottom, and stages common to both the receiver and transmitter are located through the center.

TRANSMITTER OPERATION

There are two ways to actuate the Transceiver relay to change from receive to transmit operation; first, by the PTT (push-to-talk) method where a pushbutton switch in the microphone is used to close the relay circuit; or second, by the VOX (voice operated transmitter) method.

In VOX operation, the voice sounds which are transformed into electrical impulses by the microphone are amplified by microphone amplifier stage V1A. These signals go to VOX amplifier V10 and to AF (audio frequency) cathode follower V1B. These electrical impulses are amplified by the VOX amplifier and then by relay amplifier V2B to a level that will operate the relay. When the relay is switched to the transmit position, it turns off certain tubes in the receiver section and turns on certain tubes in the transmitter section, as indicated by the dashed lines on the Block Diagram. The tubes in both sections that are not switched by the relay remain in operation for both transmitting and receiving.

With the transmitter switched on by either the PTT or VOX method, the amplified voice voltage from V1A is sent to AF cathode follower V1B, which properly matches the low impedance of the diode type balanced modulator. The balanced modulator mixes the voice frequencies with a signal from carrier oscillator stage V11B. The modulator uses these two signals to develop two new signals; one is the sum of these two signals, and the other is the difference between

these two signals. With the modulator balanced, the carrier signal is cancelled out and the resulting output of the modulator is a "double sideband, suppressed carrier" signal at the carrier frequency (IF).

The output of the modulator is fed through transformer T1, which is tuned to aid in balancing the modulator. From T1, the signals are amplified by transmitter IF amplifier V2A. From V2A, the amplified signals go to the crystal filter, which passes only the lower sideband signal and rejects the upper sideband signal. The lower sideband signal from the crystal filter is amplified by IF amplifier V3. This signal then passes through IF transformer T2 to transmitter mixer stage V4. In the mixer, the signal is combined with a signal from VFO (variable frequency oscillator) heterodyne oscillator-mixer stage V14. This mixing results in a single sideband signal at the correct transmitter output frequency.

The VFO signal is produced by tunable oscillator stage V13. The VFO signal from V13 goes to VFO heterodyne oscillator-mixer V14 for isolation. This signal is used in the mixer stages of both the receiver and transmitter, thus locking the transmitter and receiver to the same operating frequency.

The signal from transmitter mixer stage V4 is fed through receiver-transmitter bandpass coil L2 and then is amplified by RF driver V5. Output signal from the driver is applied through bandpass coil L3 to RF power amplifier tubes V6 and V7. Here the power level is greatly increased and then is fed to the antenna through section A of the relay.

To obtain maximum transmitter output without overloading, a portion of the driver output signal is fed back to preceding stages to adjust their gain automatically as needed. This is called ALC (automatic level control).

RECEIVER OPERATION

For receiving, the antenna is connected through the relay to receive-transmit bandpass coil L3. From coil L3, the signal is applied to RF amplifier stage V8A. From V8A, the signal passes

through receive-transmit bandpass coil L2 to receiver mixer stage V8B. In V8B, the incoming signal is mixed with the variable frequency signal from V14 to produce the IF signal. The IF signal from V8B passes through the crystal filter, receive-transmit IF amplifier V3, and then to receiver IF amplifier V9. The crystal filter passes only the IF signal and rejects all others.

Amplified signal from V9 is fed through IF transformer T3 to product detector V11A. In the product detector, the incoming signal is mixed with a signal from the carrier oscillator to produce an output signal that contains only the received voice frequencies.

The voice frequency signal is amplified by AF amplifier V12B. A portion of this amplified signal is used to obtain a control voltage which is fed

back to some of the preceding stages to maintain the volume at a constant level over a wide range of received signal strength. This is called AVC (automatic volume control). Finally, the voice signal is amplified by AF output amplifier V12A and is then applied to the speaker output of the Transceiver.

To keep the speaker output from tripping the transmitter VOX stages, a portion of the receiver output signal is fed to an anti-trip circuit to keep the relay from switching to transmit operation.

POWER SUPPLY

Operating voltages for the Transceiver are obtained from a separate power supply. The voltage and current values required are listed in the Specifications section of the manual.

CONSTRUCTION NOTES

This manual is supplied to assist you in every way to complete your kit with the least possible chance for error. The arrangement shown is the result of extensive experimentation and trial. If followed carefully, the result will be highly stable and dependable performance. We suggest that you retain the manual in your files for future reference, both in the use of the equipment and for its maintenance.

UNPACK THE KIT CAREFULLY AND CHECK EACH PART AGAINST THE PARTS LIST. In so doing, you will become acquainted with the parts. Refer to the information on the inside covers of the manual to help you identify the components. If some shortage or parts damage is found in checking the Parts List, please read the Replacements section and supply the information called for therein. Include all inspection slips in your letter to us.

Resistors generally have a tolerance rating of 10% unless otherwise stated in the Parts List. Tolerances on capacitors are generally even greater. Limits of +100% and -20% are common for electrolytic capacitors.

We suggest that you do the following before work is started:

1. Lay out all parts so that they are readily available.
2. Provide yourself with good quality tools. Basic tool requirements consist of a screwdriver with a 1/4" blade; a small screwdriver with a 1/8" blade; long-nose pliers; wire cutters, preferably separate diagonal cutters; wire strippers, or a penknife, for stripping insulation from wires; a soldering iron (or gun) and rosin core solder. A set of nut drivers and a nut starter, while not necessary, will aid extensively in construction of the kit.

Most kit builders find it helpful to separate the various parts into convenient categories. Muffin tins or molded egg cartons make convenient trays for small parts. Resistors and capacitors may be placed with their lead ends inserted in the edge of a piece of corrugated cardboard until they are needed. Values can be written on the cardboard next to each component. The illustration shows one method that may be used.

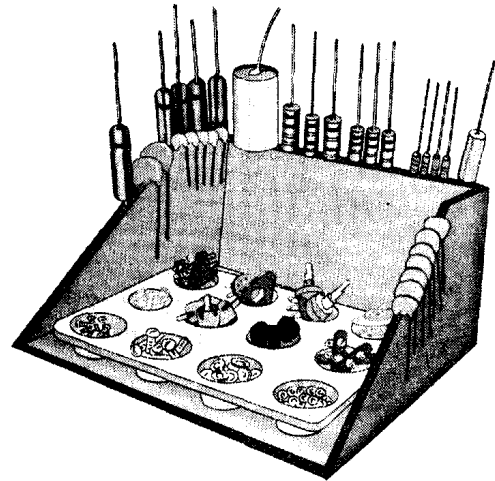

PARTS LIST

The numbers in parentheses in the Parts List are keyed to the numbers on the Parts Pictorial to aid in parts identification.

<u>PART No.</u>	<u>PARTS Per Kit</u>	<u>DESCRIPTION</u>	<u>PART No.</u>	<u>PARTS Per Kit</u>	<u>DESCRIPTION</u>
<u>Resistors</u>			<u>Resistors (cont'd.)</u>		
(1) 1-1	1	47 Ω 1/2 watt (yellow-violet-black)	1-25	13	47 K Ω 1/2 watt (yellow-violet-orange)
1-3	4	100 Ω 1/2 watt (brown-black-brown)	1-26	14	100 K Ω 1/2 watt (brown-black-yellow)
1-66	2	150 Ω 1/2 watt (brown-green-brown)	1-29	7	220 K Ω 1/2 watt (red-red-yellow)
1-45	5	220 Ω 1/2 watt (red-red-brown)	1-35	13	1 megohm 1/2 watt (brown-black-green)
1-4	2	330 Ω 1/2 watt (orange-orange-brown)	1-38	1	3.3 megohm 1/2 watt (orange-orange-green)
1-9	9	1000 Ω 1/2 watt (brown-black-red)	1-70	1	22 megohm 1/2 watt (red-red-blue)
1-14	2	3300 Ω 1/2 watt (orange-orange-red)	(2) 3-B2	1	.33 Ω 2 watt (orange-orange-silver-gold)
1-16	6	4700 Ω 1/2 watt (yellow-violet-red)	(3) 1B-21	1	20 Ω 2 watt (red-black-black)
1-20	9	10 K Ω 1/2 watt (brown-black-orange)	1B-17	1	6800 Ω 2 watt (blue-gray-red)
1-22	6	22 K Ω 1/2 watt (red-red-orange)	1B-22	2	12 K Ω 2 watt (brown-red-orange)

PART No.	PARTS Per Kit	DESCRIPTION	PART No.	PARTS Per Kit	DESCRIPTION
<u>Capacitors</u>			<u>Diodes-Crystals-Tubes-Lamps</u>		
(4) 20-96	3	36 μuf mica	19) 56-M4	5	Crystal diode (red-green-violet)
20-102	4	100 μuf mica	20) 57-27	4	Silicon diode
20-108	1	200 μuf mica	Set of crystals (#404-203) consisting of:		
20-106	1	390 μuf mica	21) 404-191	2	Crystal filter
20-127	3	1300 μuf mica	404-192	2	Crystal filter
20-30	2	22 μuf mica	404-197	1	Carrier oscillator crystal
(5) 21-60	6	18 μuf disc	404-199	1	Heterodyne oscillator crystal
21-32	6	47 μuf disc	411-11	5	6AU6 tube
21-13	7	500 μuf disc	411-91	1	6BE6 tube
21-35	3	.005 μfd disc - 1.6 KV	411-124	3	6EA8 tube
21-57	26	.005 μfd disc	411-161	1	6EB8 tube
21-31	33	.02 μfd disc	411-185	2	6GE5 tube
21-95	5	.1 μfd disc	411-24	1	12AT7 tube
(6) 25-54	2	10 μfd tubular electrolytic	411-69	1	12BY7 tube
(7) 25-135	1	20 μfd electrolytic	(22) 412-1	2	#47 pilot lamp
(8) 27-26	1	.03 μfd Mylar * (Polyester film)	(23) 412-11	1	Neon lamp
27-34	1	.2 μfd Mylar	<u>Hardware</u>		
27-20	2	.4 μfd Mylar	(24) 250-49	4	3-48 x 1/4" screw (in bag)
26-35	1	Final tune variable	(25) 250-213	26	4-40 x 5/16" screw
(9) 26-89	1	VFO tune variable	(26) 250-170	8	#6 sheet metal screw
<u>Controls-Switches-Relay</u>			(27) 250-56	17	6-32 x 1/4" screw
(10) 10-130	1	200 Ω miniature control	(28) 250-89	4	6-32 x 3/8" screw
(11) 10-57	2	10 K Ω tab-mount control	(29) 250-13	6	6-32 x 1" screw
10-58	1	100 K Ω tab-mount control	(30) 250-16	1	8-32 x 3/16" setscrew
10-127	2	1 megohm tab-mount control	(31) 250-83	8	#10 x 1/2" sheet metal screw
(12) 10-131	1	10 K Ω control	(32) 250-54	2	10-32 x 5/8" screw
10-67	1	1 megohm control	(33) 252-1	4	3-48 nut (in bag)
19-66	1	500 K Ω control with pull switch	(34) 252-15	20	4-40 nut
(13) 60-2	1	DPDT slide switch	(35) 252-3	21	6-32 nut
63-330	1	4-position rotary with snap switch	(36) 252-39	1	1/4" nut
69-34	1	Relay	(37) 252-7	5	Control nut
<u>Coils-Chokes-Transformers</u>			(38) 252-49	2	10-32 thumbnut
(14) 40-509	1	Crystal filter coil	(39) 253-1	2	#6 fiber flat washer
40-515	1	Driver plate coil	(40) 253-2	2	#6 fiber shoulder washer
40-518	1	Driver grid coil	(41) 253-9	6	#8 flat metal washer
40-520	1	VFO heterodyne mixer coil	(42) 253-39	1	1/4" flat washer
52-25	1	VFO coil	(43) 253-10	4	Control flat washer
52-63	3	2.305 mc IF transformer	(44) 254-7	4	#3 lockwasher (in bag)
40-512	1	Power amplifier coil	(45) 254-9	24	#4 lockwasher (in bag)
(15) 45-58	1	13 μh RF (bifilar) choke	(46) 254-1	27	#6 lockwasher
(16) 45-3	2	1 mh RF choke	(47) 254-3	2	#10 lockwasher
(17) 45-4	1	1.1 mh RF choke	(48) 254-14	1	1/4" lockwasher
(18) 45-47	1	2 mh RF choke	(49) 254-5	2	Control lockwasher
51-55	1	Audio output transformer	(50) 255-5	4	#6 x 3/4" spacer
			(51) 255-44	2	10-32 shoulder spacer
			(52) 259-1	5	#6 solder lug
			(53) 259-10	2	Control solder lug
			(54) 259-20	45	Solder terminal
			(55) 260-7	1	Transformer mounting clip
			(56) 435-1	1	Octal plug ring

*DuPont Registered Trademark

<u>PART No.</u>	<u>PARTS Per Kit</u>	<u>DESCRIPTION</u>	<u>PART No.</u>	<u>PARTS Per Kit</u>	<u>DESCRIPTION</u>
<u>Cable Assembly-Shielded Cable-Wire-Sleeving</u>			<u>Metal Parts</u>		
134-83	1	Cable assembly	90-265	1	Cabinet
343-7	1	Single-conductor shielded cable	(65) 100-M43	1	Dial plate
347-3	1	Double-conductor shielded cable	100-M442F929	1	Chassis
344-1	1	Hookup wire	100-M455	1	Front panel
346-1	1	Sleeving	(66) 204-M564	2	Angle bracket
340-1	1	Bare wire	(67) 204-M453	1	Pilot lamp mounting bracket
			204-M576F	1	Gimbal bracket
<u>Connectors-Sockets-Plugs</u>			<u>Miscellaneous</u>		
(57) 432-38	1	Microphone connector (male)	(68) 73-1	4	Rubber grommet
(58) 432-39	1	Microphone connector (female)	85-69F923P1	1	Circuit board
(59) 434-112	6	7-pin tube socket	261-4	4	Small rubber foot
(60) 434-105	1	8-pin tube socket	261-9	2	Medium rubber foot
434-79	6	9-pin tube socket	261-21	2	Large rubber foot
(61) 434-4	2	Octal socket	407-99	1	Meter
434-140	2	12-pin tube socket	464-M29F926	1	Plastic dial
(62) 434-42	4	Phono socket	489-1	1	Sandpaper
434-44	2	Pilot lamp socket	490-1	1	Alignment tool
(63) 438-25	4	Phono plug	331-6	1	Solder
438-6	1	Octal plug	595-633	1	Manual
(64) 440-1	2	Octal plug cap			
<u>Knobs</u>					
462-106	1	Small knob			
462-122	5	Pointer knob			
462-189	1	Large knob			

PROPER SOLDERING TECHNIQUES

Only a small percentage of customers find it necessary to return equipment for factory service. By far the largest portion of malfunctions in this equipment is due to poor or improper soldering.

If terminals are bright and clean and free of wax, frayed insulation, and other foreign substances, no difficulty will be experienced in soldering. Correctly soldered connections are essential if the performance engineered into a

kit is to be fully realized. If you are a beginner with no experience in soldering, a half-hour's practice with some odd lengths of wire may be a worthwhile investment.

For most wiring, a 25 to 100 watt soldering iron or its equivalent in a soldering gun is very satisfactory. A lower wattage iron than this may not heat the connection enough to flow the solder smoothly. Keep the iron tip clean by wiping it from time to time with a cloth.

This completes the wiring of the Transceiver. Check to see that all connections are soldered, and shake out any wire clippings or solder splashes.

- () Referring to Detail 19A, install pointer knobs on the Final Tune, Function, RF Gain, AF Gain, and VOX shafts. With the shafts turned fully counterclockwise, the pointers of the knobs should be aligned with the most counterclockwise marking on the front panel; the AF Gain control knob setscrew should be tightened against the flat of the shaft.

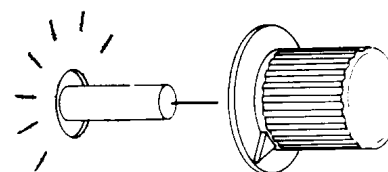

Detail 19A

- () Install the large knob on the shaft of the VFO Tune capacitor.

INITIAL TEST

Before installing the tubes or pilot lamps, the following resistance checks should be performed. If the actual resistance readings vary more than $\pm 20\%$ from those listed, refer to the In Case Of Difficulty section of the manual on Page 50.

Set the controls and switches as indicated at the top of the resistance chart. Connect the common test lead of an ohmmeter to the chassis and make the checks listed in the following chart.

NOTE: The internal wiring of most ohmmeters is such that the positive terminal of the ohmmeter battery is connected to the positive (red) test lead, and the negative battery terminal is connected to the negative (black) test lead. In some

ohmmeters, this wiring is reversed and erroneous readings will be obtained when making these measurements. Try reversing the ohmmeter test leads if the measurements do not check out correctly the first time.

Refer to Pictorial 20 (fold-out from Page 47) for the locations of the test points.

Set the controls as follows:

FUNCTION Switch: OFF.

Meter Switch: BIAS SET.

All other controls: Fully counterclockwise.

RESISTANCE CHART

TEST POINT	RESISTANCE
Power Plug pin 1	30 K Ω
Power Plug pin 2	0 Ω
Power Plug pin 3	50 K Ω (10 K Ω *)
Power Plug pin 4	Infinity
Power Plug pin 5	Infinity
Power Plug pin 6	Infinity
Power Plug pin 7	1000 Ω
Power Plug pin 8	Infinity
28 in section 1C	10 K Ω
A in section 1C	200 to 500 Ω

TEST POINT	RESISTANCE
B in section 3B	250 K Ω
C in section 1A	3300 Ω
13 in section 1B	220 Ω
Tube socket V4 pin 7	330 Ω
Tube socket V5 pin 1	150 Ω
Tube socket V5 pin 2	200 K Ω
Tube socket V6 pin 3	75 K Ω
Tube socket V9 pin 1	1.25 megohm
Tube socket V12 pin 8	40 K Ω (20 K Ω *)
Tube socket V12 pin 6	120 Ω

*With OPTIONAL resistors installed.

TEST POINT	RESISTANCE
Tube socket V1 pin 9	1 to 2 megohm (adjusts with MIC GAIN control)
Tube socket V10 pin 1	2 megohm
Tube socket V2 pin 9	20 megohm
6 in section 4C	0 to 1 megohm (adjusts with VOX control)
9 in section 2C	20 K Ω
Mic #1	10 megohm, minimum
Mic #2	20 megohm
16 in section 5C	Infinity with AF GAIN switch "in;" 50 K Ω (10 K Ω *) with AF GAIN switch "out."
Set the FUNCTION switch to PTT.	
Tube socket V10 pin 1	0 Ω
Tube socket V2 pin 9	20 megohm
9 in section 2C	0 Ω
Mic #2	20 megohm
Set the FUNCTION switch to VOX.	
Tube socket V10 pin 1	2 megohm
Tube socket V2 pin 9	25 megohm
9 in section 2C	0 Ω
Mic #2	20 megohm
Set the FUNCTION switch to TUNE.	
Tube socket V10 pin 1	2 megohm
Tube socket V2 pin 9	100 K Ω
9 in section 2C	0 to 20 K Ω (adjust with TUNE LEVEL control)
Mic #2	0 Ω
Set the FUNCTION switch to PTT and the Meter switch to OPERATE TUNE.	

*With OPTIONAL resistors installed.

TEST POINT	RESISTANCE
NOTE: Use the OHMS x 100 scale. Just touch the test point and note that the meter deflects; do not attempt to measure the resistance.	
13 in section 1B.	S Meter deflects (direction depends upon ohm-meter polarity)
Set the FUNCTION switch to TUNE and use the OHMS x 100 scale.	
H in section 4A	S Meter deflects
Set the FUNCTION switch to PTT and the Meter switch to BIAS SET. Use the OHMS x 1 scale.	
25 in section 5C	S Meter deflects (opposite direction)
Set the FUNCTION switch to OFF.	
SPKR jack	0.4 Ω
RELAY jack	Infinity, then press relay for 0 Ω
ANT jack	0.4 Ω , then press relay for 10 K Ω
RCVR jack	0.1 Ω
1 in section 1C	15 K Ω , then press relay for 0 Ω
3 in section 4B	0 to 10 K Ω (adjusts with RF GAIN control) then press relay for 100 K Ω

This completes the Initial Tests. If all resistance readings were in agreement with the chart (or within $\pm 20\%$), install the tubes in their proper sockets, and the pilot lamps in the pilot lamp sockets. See Pictorial 20 (fold-out from Page 47). Adjust the pilot lamp bracket so the lamp clears the meter and dial.

CAUTION: When installing the tubes, support the circuit board from underneath with a finger to prevent circuit board damage.

POWER SUPPLY

The Transceiver is designed and wired to operate with the Heath Model HP-13 (12 VDC) Power Supply, and the Model HP-23 (120 VAC) Power Supply.

Other power supplies may be used, however, their use may require one or more of the OPTIONAL changes to the Transceiver circuit board to provide proper screen voltage to the output tubes. The older Heath Model HP-20 (120 VAC) Power Supply with proper termination of the power cable, and the Model HP-10 (12 VDC) Power Supply with slight modification can also be used with the Transceiver. These two Power Supplies will be discussed later.

NOTE: Connectors are supplied for connecting the power supply cables to the Transceiver.

HEATH HP-13 POWER SUPPLY

Referring to Figure 1A, wire the octal socket (with cap) of the Transceiver to the Power Supply cable as follows:

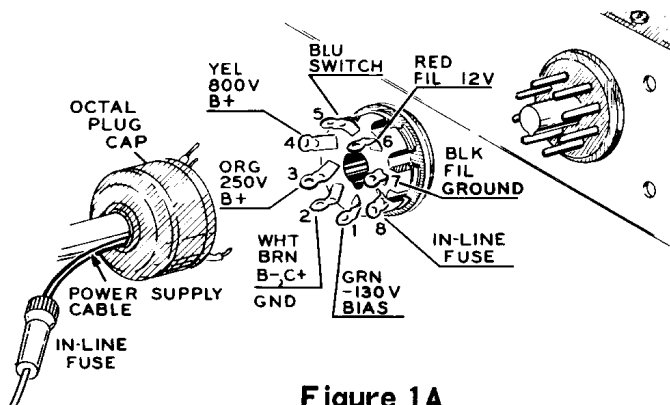

Figure 1A

SOCKET PIN#	CABLE WIRE COLOR
1	Green - Bias (-130 V)
2	White and Brown - Ground (B-, C+)
3	Orange - B+ (250 V - Low tap)
4	Yellow - B+ (800 V)
5	Blue - Switch
6	Red - Filament (12 VDC)
7	Black - Filament (Ground)
8	In-line fuse lead

The other end of the cable should be connected to the 15-pin cable connector as directed in the Power Supply manual.

HEATH HP-23 POWER SUPPLY

Referring to Figure 1B, wire the octal socket (with cap) of the Transceiver to the Power Supply cable as follows:

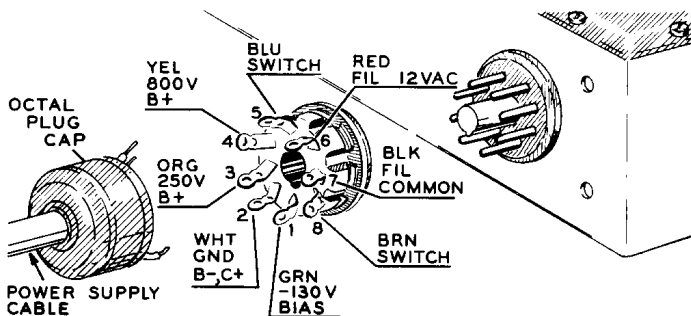

Figure 1B

SOCKET PIN#	CABLE WIRE COLOR
1	Green - Bias (-130 V)
2	White - Ground (B-, C+)
3	Orange - B+ (250 V - Low tap)
4	Yellow - B+ (800 V)
5	Blue - Switch
6	Red - Filament (12 VAC)
7	Black - Filament (12 VAC)
8	Brown - Switch

The other end of the cable should be connected to the 11-pin plug as directed in the Power Supply manual.

HEATH HP-20 POWER SUPPLY

The HP-20 Power Supply can be used as is, without modification. The octal socket with cap should be wired on the Transceiver end of the power cable according to Figure 1B. An octal plug with cap should be wired to the Power Supply end of the cable, using the same wire colors and pin numbers called out in Figure 1B. Be sure to use the correct pin numbers, as molded into the plug.

NOTE: The OPTIONAL resistors mentioned below are not supplied in the kit. These resistors can be obtained from a local parts supplier.

1. Remove the long jumper in section 4A of the Transceiver circuit board.

2. Install a 1000 Ω 4 to 7 watt resistor and a 10 K Ω 7 to 10 watt resistor at the OPTIONAL locations in section 4A of the circuit board. These resistors should be placed about 1/4" above the circuit board to prevent heat damage to the board. Use 1/2" of sleeving on each lead.
3. Install the short OPTIONAL jumper at V in section 4A of the circuit board.

When wired in this manner, the Transceiver will not turn the Power Supply On or Off, therefore, the Power Supply switch must be used for this purpose. Turning the Transceiver FUNCTION switch to the OFF position will leave the Transceiver turned On, as in the TUNE position.

If you wish, the HP-20 can be modified as follows so that it can be switched On and Off with the FUNCTION switch of the Transceiver.

Refer to Figure 2 for the following steps.

1. Connect a wire from lug 2 of switch A (S-3) to lug 8 of socket P (S-1).
2. Connect a short wire from lug 4 of terminal strip HH (S-4) to lug 5 of socket P (S-1).

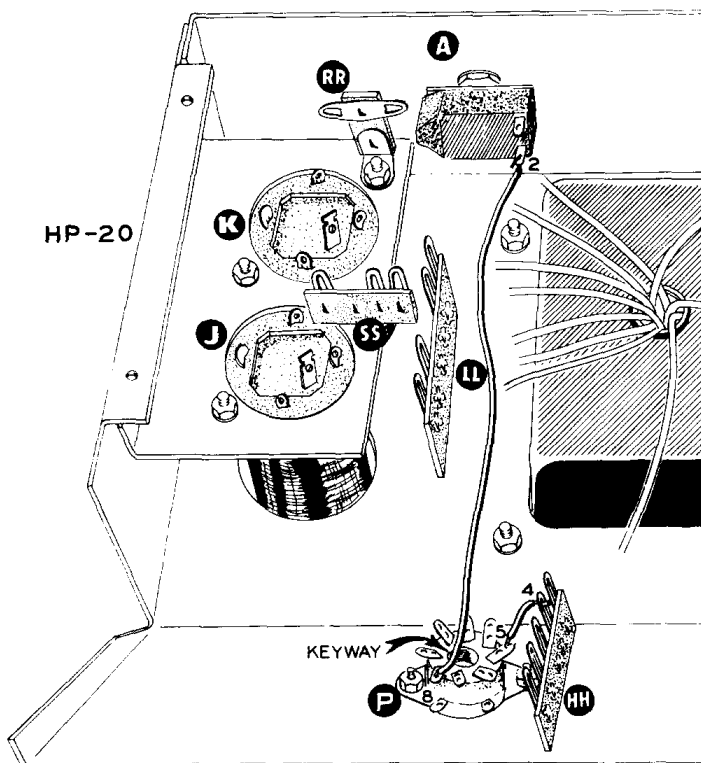

Figure 2

Now the switch of either the Transceiver or the Power Supply will turn the Power Supply On and Off. The switch of the Power Supply should be left in the Off position at all times; use the Transceiver FUNCTION switch to switch the system On and Off.

If the HP-20 Power Supply is alternately used with another piece of equipment, its On-Off switch will function normally if pins 5 and 8 of the power cable connector at the Power Supply are not used.

HEATH HP-10 POWER SUPPLY

Connect the octal socket with cap to the Transceiver end of the power cable according to Figure 1B.

Connect an octal plug with cap to the Power Supply end of the power cable as follows:

PLUG PIN#	CABLE WIRE COLOR
1	Green (S-1)
2	White (S-1)
3	Orange (S-1)
4	Yellow (S-1)
5	Red (S-1)
6	No connection
7	Blue and Black (S-2)
8	Brown (S-1)

NOTE: The OPTIONAL resistors mentioned below are not supplied in the kit. These resistors can be obtained from a local parts supplier.

1. Remove the long jumper in section 4A of the Transceiver circuit board.
2. Install a 1000 Ω 4 to 7 watt resistor and a 10 K Ω 7 to 10 watt resistor at the OPTIONAL locations in section 4A of the circuit board. These resistors should be placed about 1/4" above the circuit board to prevent heat damage to the board. Use 1/2" of sleeving on each lead.
3. Install the short OPTIONAL jumper at V in section 4A of the circuit board.

Where conservation of primary current is important, such as in mobile use, about 1 ampere of current can be saved when operating in the receive mode by making the following changes, if the OPTIONAL resistors have been installed.

() Remove the short OPTIONAL jumper in section 4A of the circuit board. Connect one end of a wire to point V on the foil side of the circuit board. Pass this wire through grommet AA and along the cable assembly to the relay. Connect the wire end to lug 3 of the relay, with the yellow-white wire of the relay. With the relay wired in this manner, bleeder current will flow only when the Transceiver is operated in the transmit mode. However, the Ext Relay jack can no longer be used to control an external circuit, such as a linear amplifier, therefore, this modification is not always practical.

ALTERNATE POWER SUPPLY CONSIDERATIONS

Power supplies other than those previously mentioned may be used with the Transceiver.

The power supply used must meet the requirements listed in the Specifications of this manual, with the following possible exception: If the power supply meets all requirements except that its B+ screen voltage is too high (275 to 325 volts), the following changes can be made on the Transceiver circuit board. These changes will provide the proper screen voltage to tubes V5, V6, and V7. NOTE: The OPTIONAL resistors mentioned below are not supplied in the kit. These resistors can be obtained from a local parts supplier.

1. Remove the long jumper in section 4A of the circuit board.
2. Install a 1000 Ω 4 watt resistor and a 10 K Ω 7 watt resistor at the OPTIONAL locations in section 4A of the circuit board. These resistors should be placed about 1/4" above the circuit board to prevent heat damage to the board. Use 1/2" of sleeving on each lead.
3. Install the short OPTIONAL jumper at V in section 4A of the circuit board. NOTE: Be sure the power cable of the power supply has #18 or larger wire for the filament circuit. All other wires can be as small as #22 wire.

ALIGNMENT

Refer to Pictorial 20 (fold-out from Page 47) for the following steps.

Set the controls as follows:

RF GAIN: full clockwise.

VOX, VOX DELAY, AFGAIN, and TUNE LEVEL: half rotation.

FINAL BIAS and MIC GAIN: fully counterclockwise.

Meter Switch: BIAS SET.

FUNCTION switch: OFF.

Using an ohmmeter, make the following resistance checks at the Power plug:

Pin 1: 30 K Ω

Pin 3: 50 K Ω (10 K Ω when using optional resistors)

Pin 4: Infinity

If any of these resistance readings vary more than $\pm 20\%$, refer to the In Case Of Difficulty section of the manual before proceeding.

RECEIVER ALIGNMENT

NOTE: Phono plugs are provided for making connections to the sockets on the rear of the Transceiver.

Connect an 8 Ω speaker (a 3.2 to 16 Ω speaker may be used with reduced efficiency) to the SPKR socket and a 50 Ω dummy load to the ANT socket. With the power supply wired according to the instructions in the Power Supply section of the Manual, connect it to the Transceiver Power plug. Make sure the VOX DELAY control is at the center of its rotation.

1. Turn the FUNCTION switch to PTT. The pilot lamps and the tube filaments should light. Watch to see that the meter remains at zero; if it should start to deflect, the Transceiver should be turned off immediately, as the bias circuit of tube stages V6 and V7 is probably shorted and must be corrected before proceeding. The relay will click during the first few seconds of warm-up. This is normal.



2. Place the Meter switch in the OPERATE TUNE position and adjust the S METER ADJ control for a zero indication on the meter.
3. Remove the dummy load from the ANT socket and plug an antenna into the ANT socket.
4. Turn up the AF GAIN control until noise is heard in the speaker. Tune up and down the band with the VFO. Stations should be heard if there is any local activity.
5. Tune in a station that gives approximately an S2 meter reading.
6. Adjust the top and bottom slugs of receiver IF transformer T3 for the highest meter reading. Use the short end of the alignment tool for the top slug, and the long end of the alignment tool for the bottom slug. When passing the long end of the alignment tool through the top slug to reach the bottom slug, be careful not to disturb the adjustment of the top slug.
7. Repeat the adjustment of T3 for the highest meter reading.
8. Turn the FUNCTION switch to OFF.
9. Turn the VFO dial fully counterclockwise until the plates of the VFO capacitor are fully closed.
10. Rotate the calibrated dial so that the end of the white stripe near the .35 marking is aligned with the hairline and tighten the setscrews. Check to see that full rotation of the dial does not cause any drag or rubbing. If it does, move the dial or knob slightly on the shaft, then retighten the setscrew.
11. Bend the pilot lamp bracket and also adjust the position of the lamp sockets to obtain the best illumination of the dial and meter.

VFO CALIBRATION

NOTE: VFO heterodyne mixer coil L5 has been factory pretuned, therefore, do not attempt any adjustment of this coil.

Disconnect the antenna from the Transceiver and plug the dummy load into the ANT socket.

Following are two ways in which to check the dial calibration with two different types of receivers. Use the method that applies to the type of receiver available.

CALIBRATION WITH A STANDARD AM BROADCAST RECEIVER

1. Connect one end of a short wire to the antenna terminal of the receiver. Place the other end of this wire near tube V14 in the Transceiver.
2. Set the receiver dial to 1620 kc and the VFO dial to .35.
3. Set the FUNCTION switch to PTT and allow the Transceiver to warm up.
4. Adjust the slug of coil L6 until a whistle is heard in the speaker of the receiver. Coil L6 will normally have to be turned in a counterclockwise direction, viewed from the top of the chassis.
5. Turn the FUNCTION switch to OFF.

This alignment should provide fairly close calibration of the VFO. However, operation of the Transceiver near the ends of the VFO dial should be avoided until the VFO calibration is checked with a crystal calibrator or a very accurate amateur receiver.

CALIBRATION WITH AMATEUR BAND RECEIVER

1. Connect one end of a short wire to the antenna terminal of the receiver. Place the other end of this wire near tube V4 in the Transceiver.
2. Temporarily remove V5, the 12BY7 tube.
3. Turn the FUNCTION switch to TUNE and allow the Transceiver to warm up.
4. Set the dials of the receiver and Transceiver to 14.25 megacycles. The receiver should be operated in the CW mode.

5. Adjust coil L6 until the Transceiver signal is heard in the amateur receiver speaker. Check the VFO dial calibration by setting the dials of both the Receiver and Transceiver first to 14.20 megacycles, then to 14.30 megacycles. The calibration should check at these points. Any dial variations should be corrected by adjusting coil L6 at 14.35 megacycles and C131B (the trimmer on the VFO variable capacitor) at 14.20 megacycles. Repeat until the dial checks with the amateur receiver dial.
6. Turn the FUNCTION switch to OFF.

CRYSTAL CALIBRATOR CHECK OF VFO DIAL SETTINGS

The preceding adjustments of the VFO will only be as accurate as the receiver used. The calibration can be accurately checked by using the Heath Model HRA-10-1 Crystal Calibrator as an accessory with the Transceiver. The Crystal Calibrator accuracy should be checked against WWV by using a receiver other than the one in the Transceiver to set the calibrator at 5, 10, or 15 megacycles.

1. Plug the Crystal Calibrator into the calibrator socket of the Transceiver.
2. With the antenna plugged into the ANT socket, place the FUNCTION switch in the PTT position, and the Meter switch in the OPERATE TUNE position.
3. Turn on the Crystal Calibrator by pulling the AF GAIN control knob "out." Allow sufficient time for the Calibrator to warm up.
4. Check the calibration accuracy of the VFO at the 14.20 and 14.30 megacycle settings of the VFO dial of the Transceiver. Any dial variations should be corrected by adjusting coil L6 at 14.30 megacycles and C131B (the trimmer on the VFO variable capacitor) at 14.20 megacycles. Repeat until the dial checks with the calibrator signals.
5. Turn the FUNCTION switch to OFF.

TRANSMITTER ALIGNMENT

BIAS SETTING

1. Connect the dummy load to the ANT socket.
2. Remove V5, the 12BY7 tube.
3. Set the FUNCTION switch to TUNE and the METER switch to BIAS SET.
4. Then adjust the FINAL BIAS control for a reading of S3 on the meter. There is a small triangle above the "3" on the meter to indicate the proper bias setting.
5. Turn the FUNCTION switch OFF, and replace V5, the 12BY7 tube.

RF AMPLIFIER ADJUSTMENT

1. Connect a voltmeter across the dummy load, if your dummy load provides a DC voltmeter connection, or use a VTVM with an RF probe positioned near the dummy load. Do not connect the RF probe to the dummy load as there is sufficient voltage output to burn out the diodes of some RF probes.
2. With the VFO dial set to .25, place the FUNCTION switch in the TUNE position and the Meter switch to TUNE-OPERATE. The voltmeter should indicate some output.
3. Adjust the FINAL TUNE control for maximum output, which should give a reading of over S3 on the Transceiver meter. If the meter goes above S9, adjust the CARRIER NULL control to drop the level to S9.
4. Adjust both slugs of transformer T2 for a maximum meter indication.

BALANCED MODULATOR ADJUSTMENT

With the voltmeter lead still connected to the dummy load or with the VTVM RF probe near the dummy load, place the FUNCTION switch in the PTT position. Allow the Transceiver to warm up for at least one-half hour before adjusting the balanced modulator.

1. Press the PTT switch, or ground lug #2 of the MIC socket with a short wire, and adjust the CARRIER NULL control for a minimum signal indication on the test meter.

2. Using the long end of the alignment tool, adjust the bottom slug of transformer T1 to the bottom of its travel (clockwise from the top of the chassis).
3. Adjust the top slug of T1 for a maximum signal indication. This should require a very slight core adjustment. There is a greater but false peak if the core is screwed down too much.
4. Again, adjust the CARRIER NULL control for a minimum signal indication.

NOTE: The signal level should now become quite low, and if a VTVM and RF probe are being used, the probe should be connected to the center pin (pin 2) of the ANT socket.

5. Now adjust the bottom slug of T1 back up into the transformer. As the slug is adjusted, there will be a dip to a minimum

indication. Adjust the slug for the minimum (dip) indication.

6. Readjust the CARRIER NULL control and the bottom slug of transformer T1 for the lowest possible minimum signal indication. The adjustments are now quite critical; turn them slowly. Repeat this adjustment until the best null is obtained.
7. Disconnect the test meter from the Transceiver and if used, the wire connected between lug 2 of the MIC socket and the chassis.
8. Turn the FUNCTION switch to TUNE and the Meter switch to OPERATE TUNE.
9. Adjust the TUNE LEVEL control to increase the meter reading to an S3 to S6 indication.

DRIVER TUNING

The driver tuning coils are preset at the factory.

FINAL ASSEMBLY

FIXED STATION-MOBILE CONSIDERATIONS

Before installing the Transceiver in the cabinet, determine whether it will be used for fixed station or mobile operation, or both. For fixed station use only, perform the steps under Fixed Station Installation; for mobile use only, perform the steps under Mobile Installation. If you plan to use the Transceiver alternately in fixed station and mobile installations, perform the steps in both sections.

Refer to Pictorial 21 for the following steps.

NOTE: If a microphone clip is to be used (supplied with your microphone), it may be installed on either end of the cabinet, so the microphone can be lifted up and out, or so the microphone can be pulled toward the front and out. Use 6-32 x 1/4" screws, #6 lockwashers, and 6-32 nuts to mount the microphone clip.

FIXED STATION INSTALLATION

- () Install the medium rubber feet at the rear holes in the bottom of the cabinet, using 6-32 x 3/8" screws, #8 flat metal washers, #6 lockwashers, and 6-32 nuts.
- () Install large rubber feet at the front holes in the bottom of the cabinet, using 6-32 x 1" screws, #6 lockwashers, and 6-32 nuts.

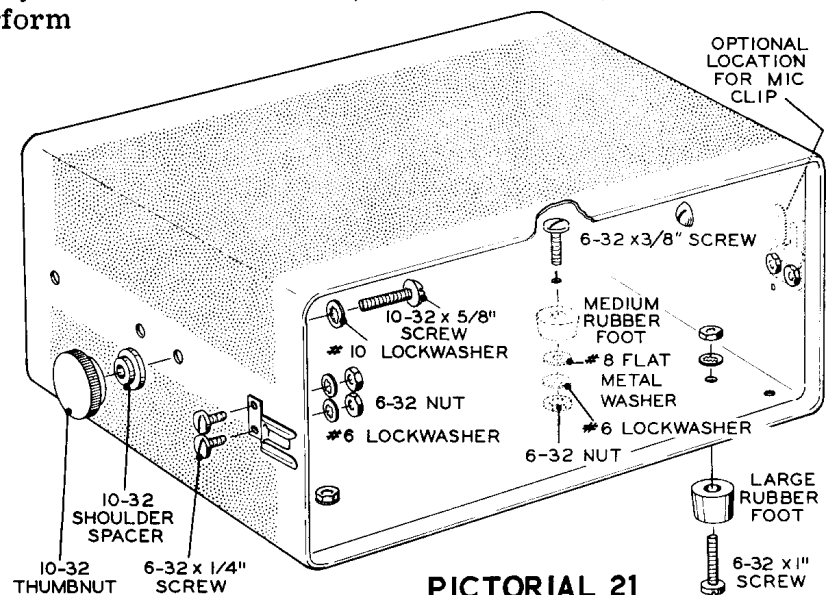

PICTORIAL 21

Figure 4A

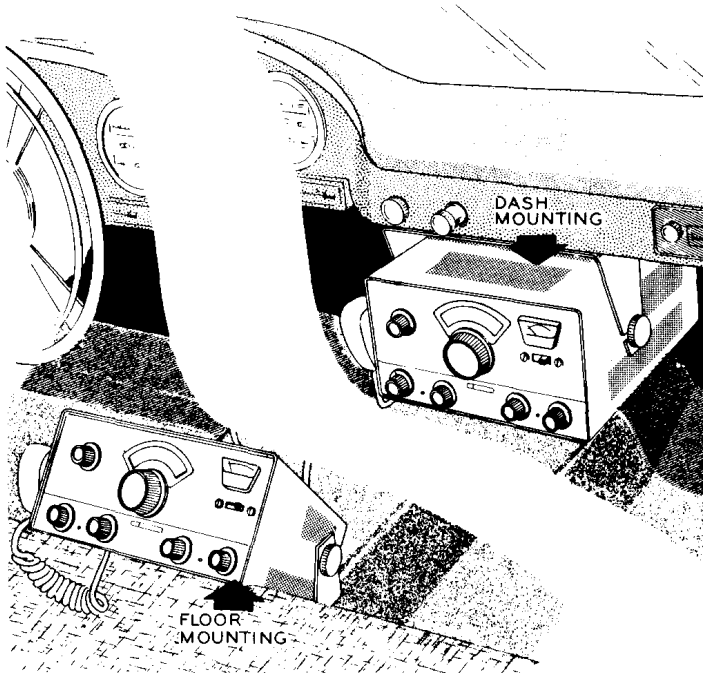
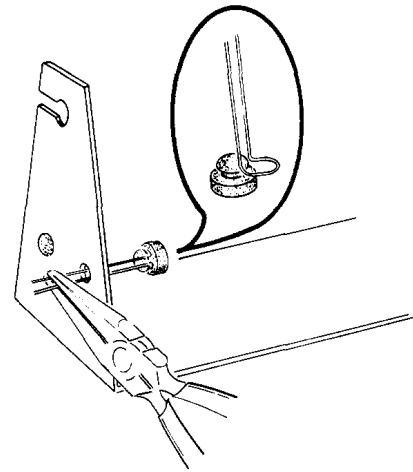

Figure 4B

MOBILE INSTALLATION

Determine whether the Transceiver is to be mounted under the dash or on the floor of the automobile. See Figures 4A and 4B. If under-the-dash mounting is preferred, there are two holes near the center on each side of the cabinet which can be used for mounting. For floor mounting, the holes at the rear on each side of the cabinet can be used. Choose the holes that will provide best balance for your installation.

- () Mount the gimbal bracket hardware in the cabinet holes decided upon. Use 10-32 x 5/8" screws, #10 lockwashers, 10-32" shoulder spacers, and 10-32 thumbnuts.
- () Referring to Detail 21A, install four small rubber feet into the gimbal bracket. This is easily done by looping a length of bare wire around the groove of the rubber foot and passing the wire through the hole in the gimbal bracket. Pull on the wire until the rubber foot is properly seated in the hole.



Detail 21A

CRYSTAL CALIBRATOR MOUNTING

Refer to Pictorial 22 for the following steps.

If the Heath HRA-10-1 Crystal Calibrator is to be used with the Transceiver, perform the following steps before mounting the Transceiver in the cabinet.

- () Referring to Detail 22A, remove screws A and B from the Calibrator.
- () Mount the angle brackets to the Calibrator at locations A and B, using #6 fiber flat washers, #6 fiber shoulder washers, #6 lockwashers, and 6-32 x 3/8" screws. Be sure the fiber shoulder washers are centered properly in the larger holes of the angle brackets.
- () Plug the Calibrator into the Calibrator socket of the Transceiver.

CABINET MOUNTING

Refer to Pictorial 22 for the following steps.

- () Slide the Transceiver chassis into the cabinet.
- () Secure the chassis in the cabinet, using six #6 x 1/4" sheet metal screws, four through the back and two through the bottom.
- () If the Heath Crystal Calibrator is used, fasten it to the rear of the cabinet with two #6 x 1/4" sheet metal screws.

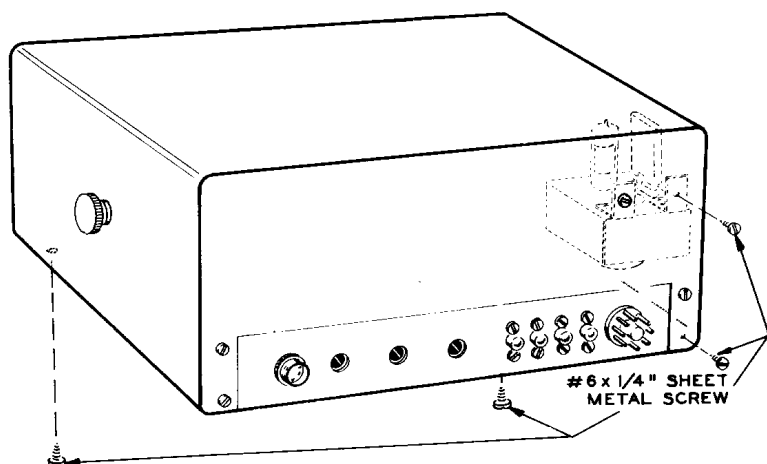

PICTORIAL 22

MICROPHONE

Any high impedance crystal, dynamic, or ceramic microphone having a minimum output of 10 millivolts can be used with the Transceiver.

Pictorial 23 shows how most communications type microphones can be wired for VOX, PTT, or both types of operation. The only difference in wiring to change the microphone from just PTT operation to both types of operation, is the addition of the jumper wire in the microphone. This additional wire keeps the audio lead from being opened when the microphone button is released, thus permitting VOX operation with the Transceiver. When wired in this manner the switch of the microphone will actuate the relay of the Transceiver for PTT operation.

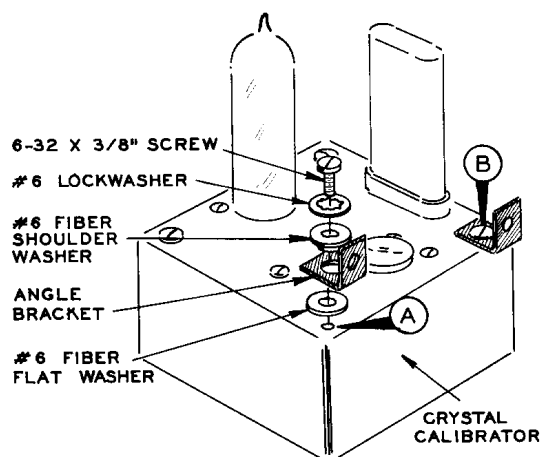

Detail 22A

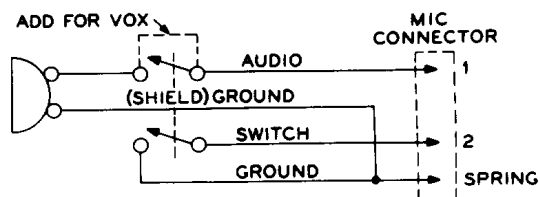
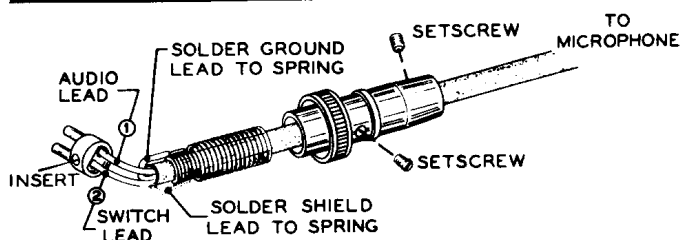

PICTORIAL 23

A microphone not having a switch will be satisfactory for VOX operation by installing the male microphone connector supplied. The audio lead should be connected to pin #1 and the shield should be connected to the spring of the connector.

INSTALLATION

FIXED STATION

The Transceiver must be placed in a location with adequate ventilation because of the amount of heat given off by the tubes. Inadequate ventilation could cause considerable damage to the circuit components.

The power supply can usually be located under a table or some other out-of-the-way place, since it is controlled by the FUNCTION switch of the Transceiver.

Because the Transceiver requires about 300 watts of power when transmitting, it should not be operated from an already heavily loaded AC outlet.

The Transceiver should be grounded to a ground rod or cold water pipe. Make the ground connection to the Transceiver at one of the cabinet mounting screws.

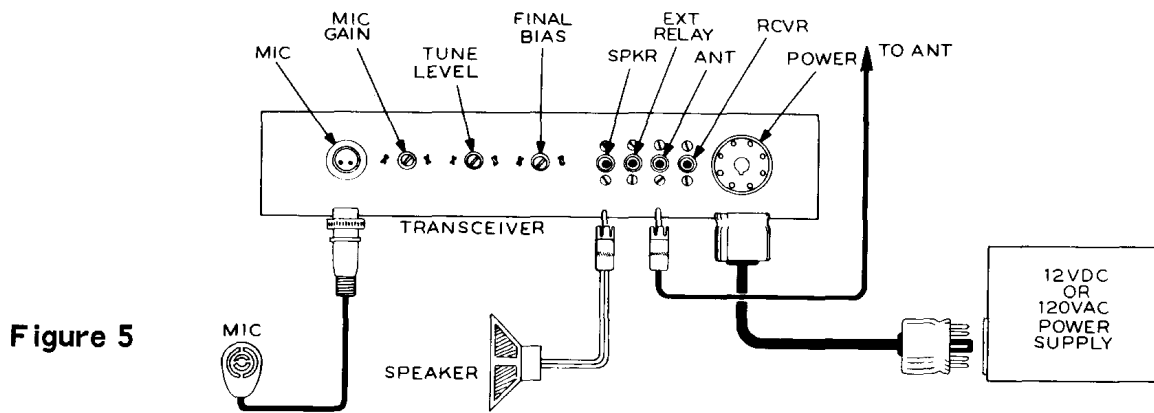

A doublet antenna fed by RG-58 or RG-59 cable, or an inverted "Vee" type antenna fed with coax cable will work very well with the Transceiver. Other types of antennas using high impedance end-feeding, off-center feeding, open wire lines, or 300 Ω twin lead, can be used if an antenna coupler (see ARRL Antenna Handbook) is used between the antenna and Transceiver. The antenna used must provide a low SWR (standing wave ratio) to the Transceiver for successful operation. Lightning arrestors on the antenna are a must. The antenna must be grounded, and the Transceiver should be taken off the air when a lightning storm is near.

The FINAL TUNE knob will peak in the center third of rotation with a properly matched antenna. Do not use an antenna that will not tune through a "peak" in TUNE.

Connect an SWR bridge, if available, to the antenna and make sure the SWR is below 1.5 to 1. Power for operating the bridge may be obtained in the TUNE position of the FUNCTION switch.

Use an 8 Ω speaker capable of handling one watt of audio power.

Three typical installations are shown in Figures 5, 6, and 7. Figure 5 shows a basic hookup suitable for either fixed station or mobile operation. Figure 6 shows a fixed station installation using a linear amplifier with a built-in antenna relay switched by the Transceiver.

CAUTION: Remember that one side of the EXT RELAY socket in the Transceiver is connected to the chassis. Therefore, it should not be connected to 120 volt AC lines for relay switching. The AC voltage could cause the Transceiver chassis to be "hot," creating a shock hazard.

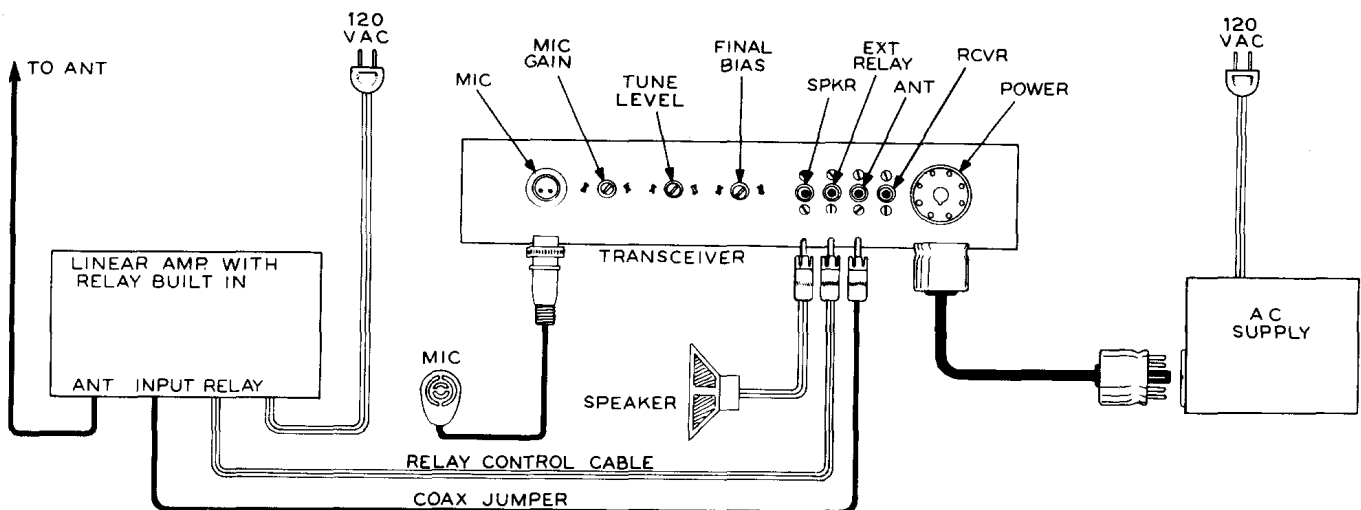

Figure 6

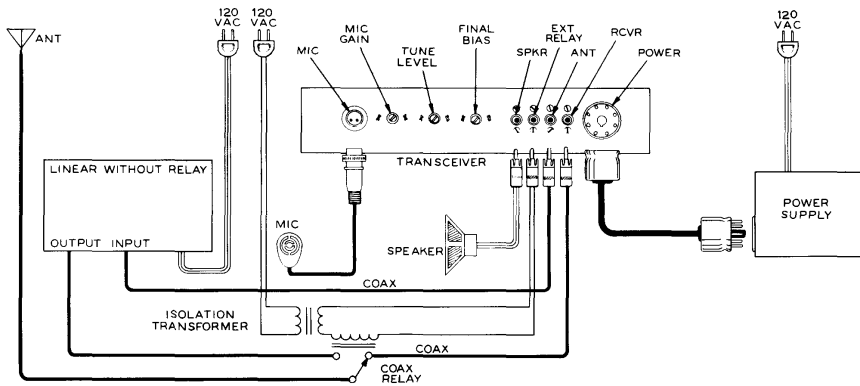

Figure 7

The switching circuit of an AC external relay must be isolated from the Transceiver by using an isolation transformer.

If low voltage DC is used on the relay switching line, be very careful to get the polarity of the voltage connected properly. The grounded DC lead must be connected to the outside (chassis) of the plug.

Figure 7 shows a setup incorporating a linear amplifier which does not have a built-in relay. When using a separate antenna relay in this manner, a suitable isolation transformer must be used to operate the relay and isolate the AC line voltage from the Transceiver chassis.

MOBILE

The preferred location for mobile operation is under the dash, although you may desire to mount the unit on the floor. See Figures 4A and 4B. The gimbal bracket should be mounted in the desired location in the automobile, using the #10 sheet metal screws. The starting holes for these screws should be made with a 9/64" drill, being careful not to drill into existing wiring or instruments. Keep all Transceiver cables clear of the automobile pedals and control cables.

Any cables that have to go through the fire wall will usually fit through existing grommets. If it

is necessary to make holes through a sheet metal partition, a long tapered punch usually works better than a drill. A drilled hole leaves sharp edges which can cut the wires. When a punch is driven through the metal, the sharp edge is rolled back and a smooth hole will result.

Be sure to leave enough extra cable so the Transceiver can be removed from the gimbal bracket and operated, to permit adjusting the rear apron controls.

Mount the antenna according to the manufacturer's instructions. Be sure to make a good ground connection between the shield of the coax cable and the car body at the antenna base. Low frequency antennas with loading coils must be carefully tuned, as a small change in antenna length changes the SWR considerably.

The FINAL TUNE knob will peak in the center third of rotation with a properly matched antenna. Do not use an antenna that will not tune through a "peak" in TUNE. Check the SWR if an SWR bridge is available. The SWR must be less than 1.5 to 1.

The Heath Mobile Speaker can be used for installation in an automobile, or a car radio speaker (3.2 to 16 Ω) may be used.

Connect the cables and mount the Transceiver in the gimbal bracket. Position as desired and tighten the thumbnuts.

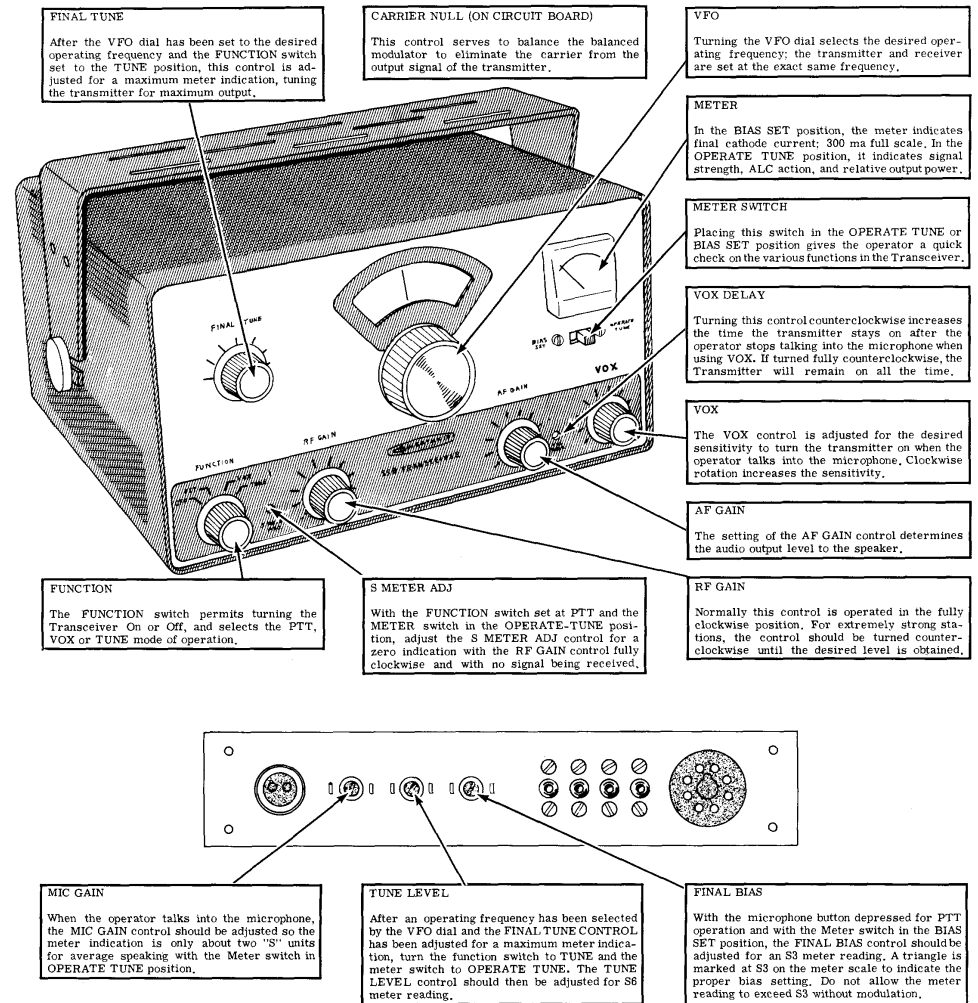

Figure 9

FINAL TUNE
After the VFO dial has been set to the desired operating frequency and the FUNCTION switch set to the TUNE position, this control is adjusted for a maximum meter indication, tuning the transmitter for maximum output.

CARRIER NULL (ON CIRCUIT BOARD)
This control serves to balance the balanced modulator to eliminate the carrier from the output signal of the transmitter.

VFO
Turning the VFO dial selects the desired operating frequency; the transmitter and receiver are set at the exact same frequency.

METER
In the BIAS SET position, the meter indicates final cathode current; 300 ma full scale. In the OPERATE TUNE position, it indicates signal strength, ALC action, and relative output power.

METER SWITCH
Placing this switch in the OPERATE TUNE or BIAS SET position gives the operator a quick check on the various functions in the Transceiver.

VOX DELAY
Turning this control counterclockwise increases the time the transmitter stays on after the operator stops talking into the microphone when using VOX. If turned fully counterclockwise, the Transmitter will remain on all the time.

VOX
The VOX control is adjusted for the desired sensitivity to turn the transmitter on when the operator talks into the microphone. Clockwise rotation increases the sensitivity.

AF GAIN
The setting of the AF GAIN control determines the audio output level to the speaker.

RF GAIN
Normally this control is operated in the fully clockwise position. For extremely strong stations, the control should be turned counterclockwise until the desired level is obtained.

FUNCTION
The FUNCTION switch permits turning the Transceiver On or Off, and selects the PTT, VOX or TUNE mode of operation.

S METER ADJ
With the FUNCTION switch set at PTT and the METER switch in the OPERATE-TUNE position, adjust the S METER ADJ control for a zero indication with the RF GAIN control fully clockwise and with no signal being received.

MIC GAIN
When the operator talks into the microphone, the MIC GAIN control should be adjusted so the meter indication is only about two "S" units for average speaking with the Meter switch in OPERATE TUNE position.

TUNE LEVEL
After an operating frequency has been selected by the VFO dial and the FINAL TUNE CONTROL has been adjusted for a maximum meter indication, turn the function switch to TUNE and the meter switch to OPERATE TUNE. The TUNE LEVEL control should then be adjusted for S6 meter reading.

FINAL BIAS
With the microphone button depressed for PTT operation and with the Meter switch in the BIAS SET position, the FINAL BIAS control should be adjusted for an S3 meter reading. A triangle is marked at S3 on the meter scale to indicate the proper bias setting. Do not allow the meter reading to exceed S3 without modulation.

In some mobile installations you may find that ignition or generator noise is too high for satisfactory operation. Figure 8 shows a number of

ways in which this type of noise can be suppressed. Use as many of these suggestions as necessary to obtain the desired results.

CAUTION
 THE VOLTAGE REGULATOR SHOWN IS ONLY REPRESENTATIVE. BATTERY, ARMATURE AND FIELD CONNECTIONS MAY NOT BE IN ORDER INDICATED. DO NOT BYPASS FIELD WINDING WITHOUT A RESISTOR IN SERIES. CHECK TERMINAL LOCATION CAREFULLY.

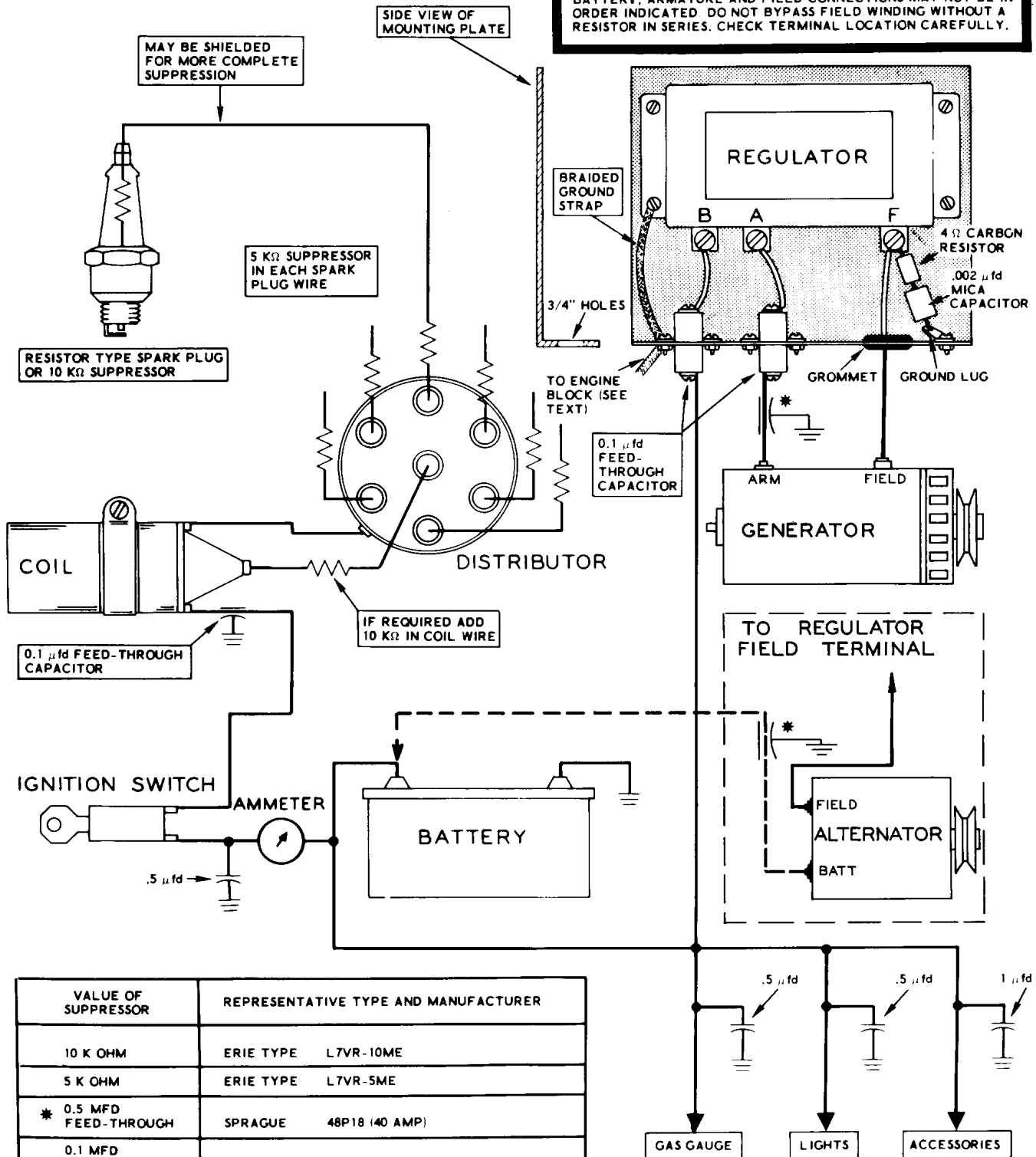

Figure 8

OPERATION

NOTE: IT SHOULD BE NOTED THAT AN AMATEUR RADIO OPERATOR AND STATION LICENSE (GENERAL CLASS PRIVILEGES) IS REQUIRED TO PLACE THIS TRANSCEIVER ON THE AIR. Information regarding licensing and amateur frequency allocations may be obtained from publications of the Federal Communications Commission or the American Radio Relay League.

FUNCTION OF OPERATING CONTROLS

Figure 9 contains a brief description of the function of each control. Read the control descriptions carefully, then proceed with the following information.

VFO

Since the transmitter and receiver are locked together in frequency, it is not necessary to "zero" the receiver frequency with the transmitter. Therefore, care must be taken that the VFO dial is not disturbed during a contact because your transmitted signal frequency will change.

RECEIVING

Operation of the Transceiver is quite simple, since there is little tuning to do once the alignment has been completed. Turn the Transceiver on by placing the FUNCTION switch in the PTT position. After a short warmup period, stations should be heard by tuning the VFO dial. The volume is adjusted by the RF and AF GAIN controls. With the meter switch in the OPERATE TUNE position the meter will indicate received signal strength in "S" units, and db over S9. Normally the RF GAIN control is operated at its maximum clockwise position, where the meter indicates the strength of received signals in S units. If signals are extremely strong, the RF GAIN control can be reduced to give the desired level. The S Meter reading is affected by the setting of the RF GAIN control.

TRANSMITTING

After an operating frequency has been selected by tuning the VFO dial, place the FUNCTION switch in the TUNE position, turning on the transmitter. With the Meter switch in the OPERATE TUNE position, adjust the FINAL TUNE control

for a maximum indication on the meter, indicating proper tuning for maximum output power. Transmitting with the FUNCTION switch in the PTT or VOX position gives a meter indication of the ALC voltage. As the operator talks, the meter should deflect a couple of S units, indicating maximum output peaks. (The Heath Monitor scope can be used with the Transceiver in fixed-station operation to provide a visual display of transmitter output.) The meter may read below the zero mark while transmitting without harm.

The meter switch may be placed in the BIAS SET position while transmitting to observe plate current variations of the final RF AMPLIFIERS. Normal talking should produce peaks at about S6 on the meter, with loud steady tones resulting in half-scale to full-scale peaks. If the peaks of average talking levels are above S6, the MIC GAIN is set too high, and should be reduced to provide the S6 level.

To keep the Transmitter in peak operating condition, it should be adjusted periodically as directed in the Alignment section of the manual. The BIAS control should be adjusted as directed in the Alignment instructions. The BIAS control setting should be checked and adjusted as necessary whenever power supplies are changed.

After alignment has been completed and the carrier properly nulled, the bias level can be checked anytime by observing the meter in the BIAS SET position when the PTT button is pressed, with no modulation.

VOX

To use the voice controlled relay, place the FUNCTION switch in the VOX position. Adjust the VOX control for the microphone sensitivity desired to turn on the transmitter. The VOX DELAY control should be adjusted for the hold-in time desired after the operator stops talking. Maximum counterclockwise setting of the control will keep the transmitter ON all the time.

ANTENNA

The antenna must have a low SWR, since the output of the Transceiver has fixed loading and a limited tuning range. The antenna tuning should be checked with a reflected power meter or SWR

bridge to make sure it has an SWR of 1-1/2 to 1, or less. Operation with a high SWR will result in overloading the output tubes. When using a SWR bridge, carrier may be obtained for tuning the antenna by switching the FUNCTION switch to the TUNE position. Care must be taken that the SWR bridge is not overloaded when transmitting SSB, since the peak output power is much higher than the output in TUNE. The antenna must be matched to, and fed with, 50 Ω coax cable for best results; the transmitter is not designed to load into random lengths of wire or open-wire transmission lines.

Special care must be taken with mobile installations, since short loaded and center loaded antennas are very critical to tune. An operating

frequency change of about 50 kc will often change the antenna tuning considerably. Better antennas with loading coils have higher "Q" and sharper tuning. Follow the antenna manufacturer's instructions carefully to obtain proper adjustment.

CRYSTAL CALIBRATION

Convenient, accurate signals at 100 kc intervals for receiver dial checking can be obtained by using the Heath Crystal Calibrator. The Crystal Calibrator can be plugged into the calibrator socket of the Transceiver. It is turned on by pulling out the AF GAIN control knob.

IN CASE OF DIFFICULTY

1. Recheck the wiring. Trace each lead in colored pencil on the Pictorial as it is checked. It is frequently helpful to have a friend check your work. Someone who is not familiar with the unit may notice something consistently overlooked by the constructor.
2. It is interesting to note that about 90% of the kits that are returned for repair, do not function properly due to poor connections and soldering. Therefore, many troubles can be eliminated by reheating all connections to make sure that they are soldered as described in the Proper Soldering Techniques section of this manual.
3. Check to be sure that all tubes are in their proper locations. Make sure that all tubes light up properly.
4. Check the tubes with a tube tester or by substitution of tubes of the same types and known to be good.
5. Check the values of the parts. Be sure that the proper part has been wired into the circuit, as shown in the pictorial diagrams and as called out in the wiring instructions.
6. Check for bits of solder, wire ends or other foreign matter which may be lodged in the wiring.
7. If, after careful checks, the trouble is still not located and a voltmeter is available, check voltage readings against those shown in Figures 11 and 12. NOTE: All voltage readings were taken with an 11 megohm input vacuum tube voltmeter. Voltages may vary as much as 10%.
8. A review of the Circuit Description will prove helpful in indicating where to look for trouble. Also check power supply and antenna.

NOTE: To aid in servicing or troubleshooting the Transceiver, refer to the Resistance and Voltage readings on Figures 10 through 12 and the Circuit Board X-Ray Views shown in Figures 13 and 14 on Pages 54 and 55.

Breaks in the foil of the circuit board can easily be detected by placing a bright light under the foil side of the board and looking through the board from the lettered side. A break will appear as a hair-line crack in the foil.

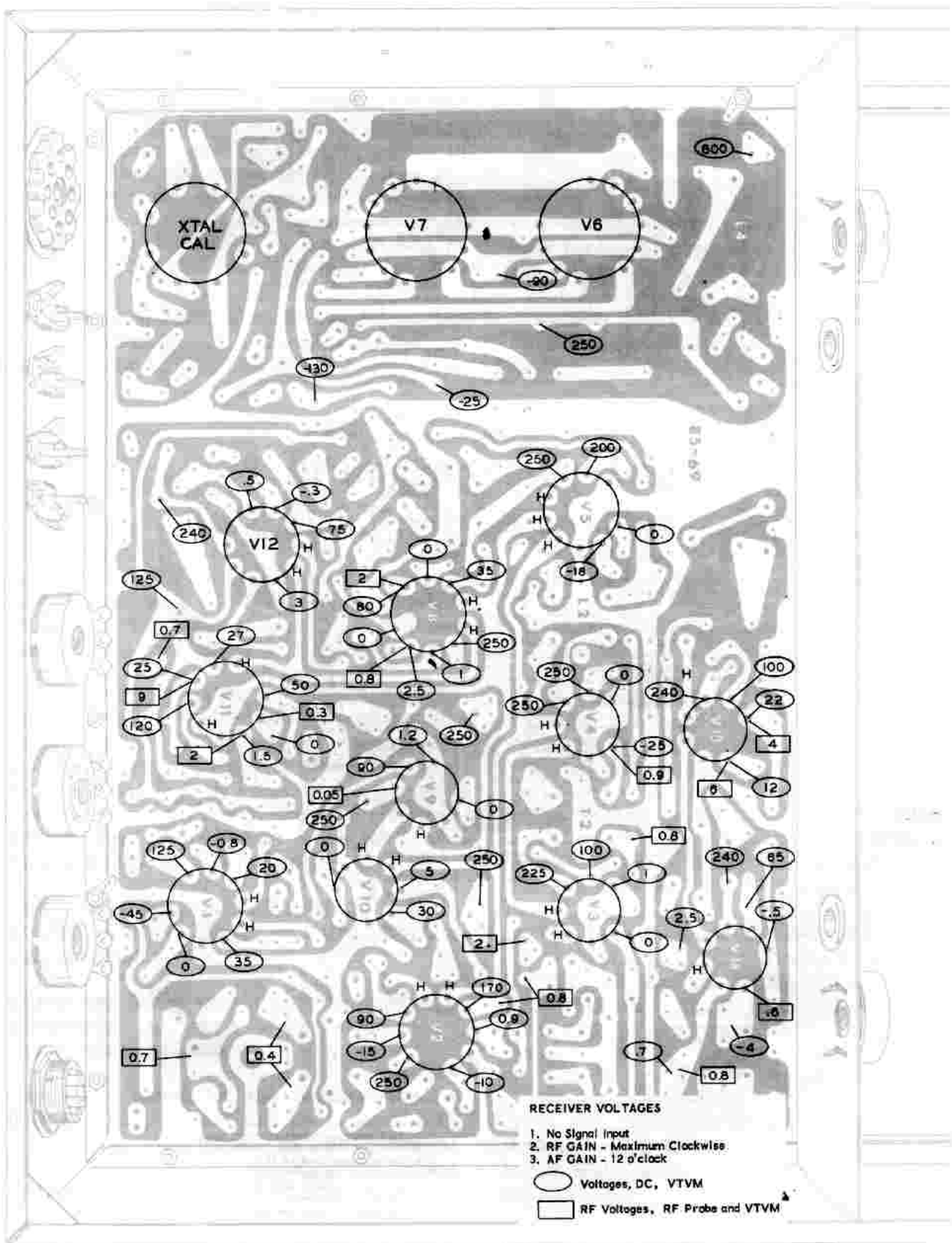

Figure 11

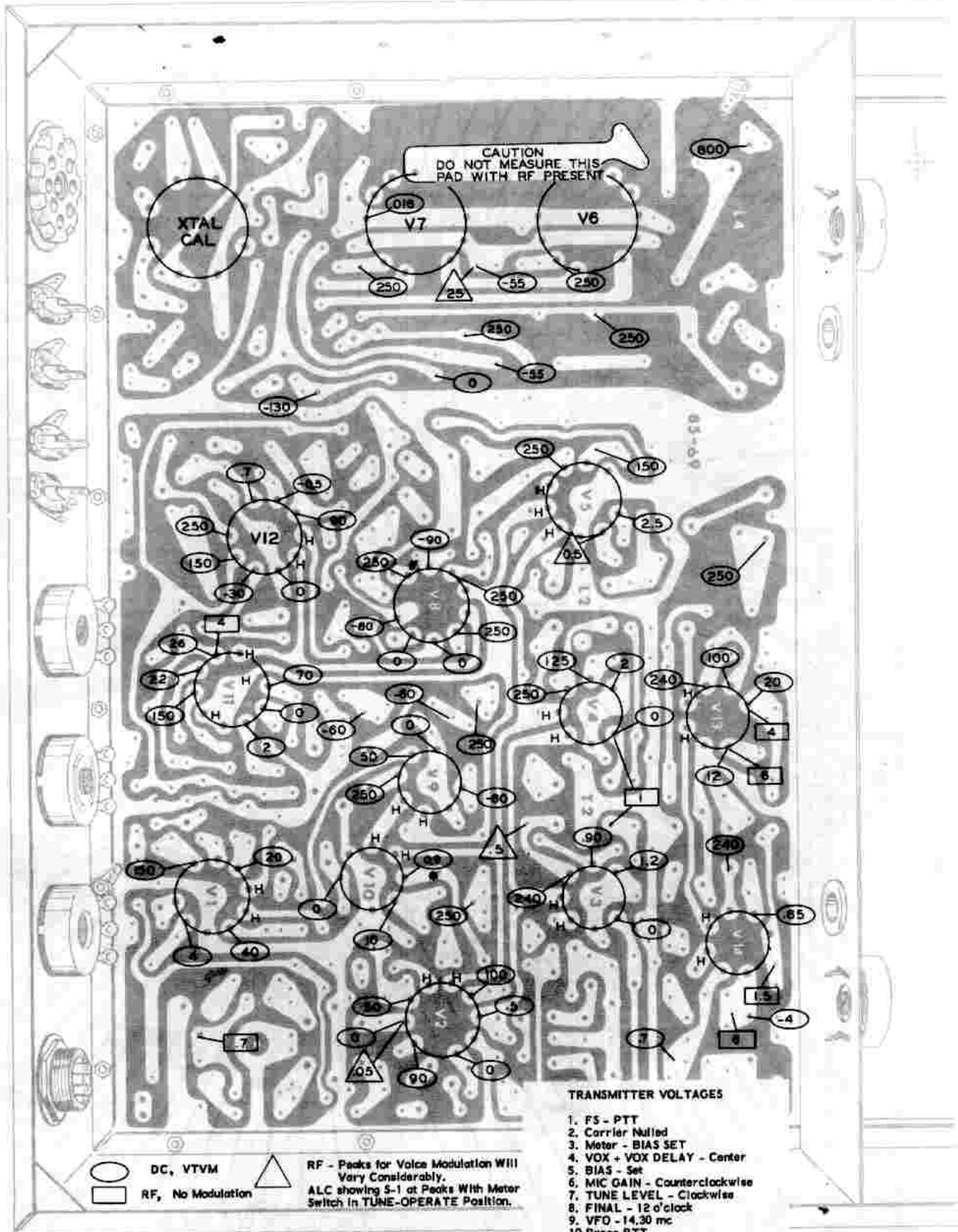
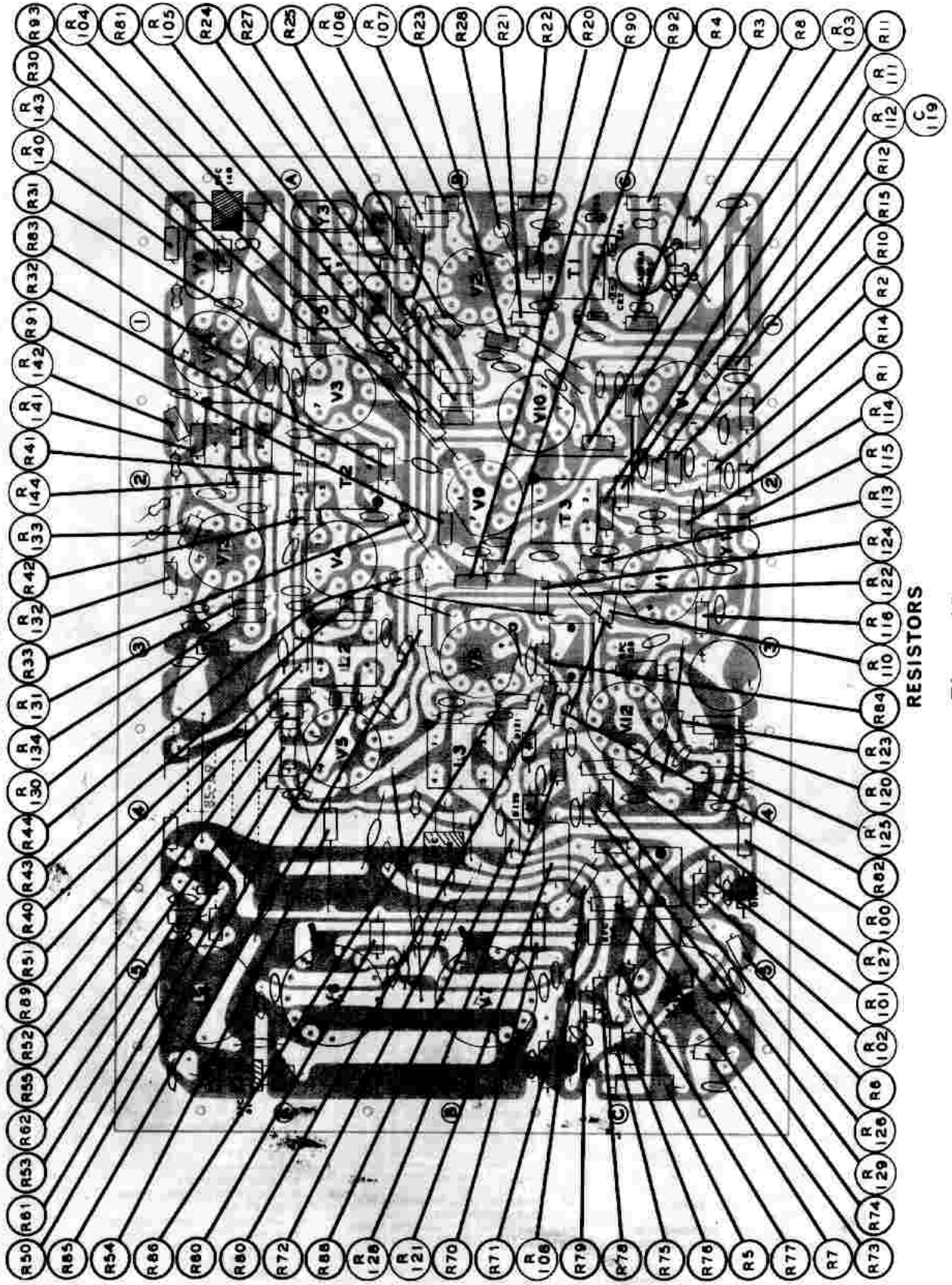

Figure 12

CIRCUIT BOARD X-RAY VIEWS

THE X-RAY VIEWS OF THE CIRCUIT BOARD ARE PROVIDED TO AID IN TROUBLESHOOTING

(VIEWED FROM FOIL SIDE)



RESISTORS

Figure 13

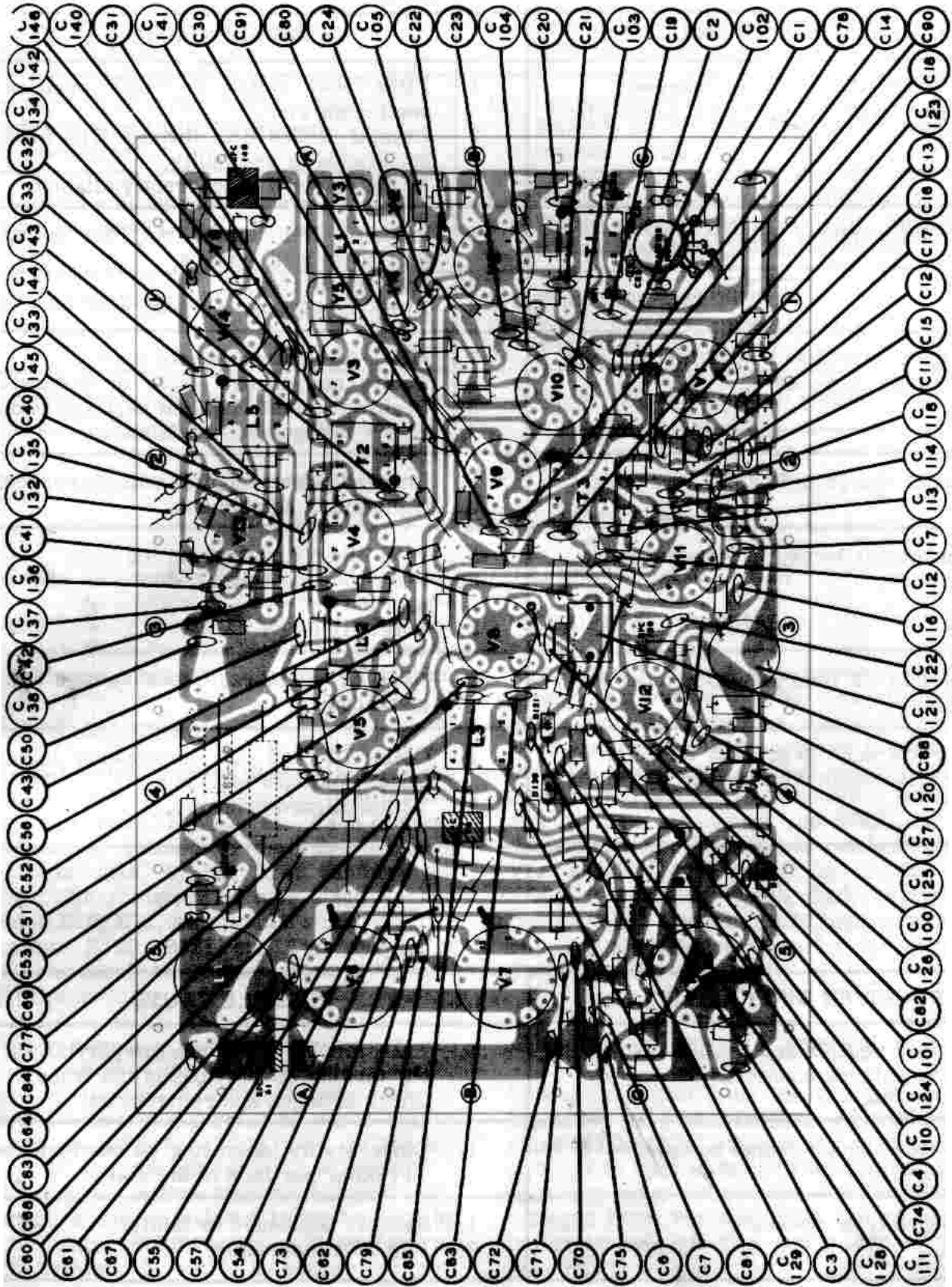

(CAPACITORS)

Figure 14

TROUBLESHOOTING CHART

TRANSMITTER DIFFICULTIES	POSSIBLE CAUSE
CARRIER NULL control changes carrier level, but not to a low enough level.	<ol style="list-style-type: none"> 1. FUNCTION switch in TUNE position inserting carrier. 2. Crystal diodes CR1 through CR4 installed backwards or are faulty. 3. Transformer T1 incorrectly aligned.
No relative power indication.	<ol style="list-style-type: none"> 1. Resistor R61 burned out, due to transmitting without antenna. 2. Antenna shorted. 3. TUNE LEVEL set too low.
Chopped or broken modulation, especially on peaks.	<ol style="list-style-type: none"> 1. MIC GAIN control set too high. 2. Faulty microphone cable or connections. 3. Receiver cutoff bias line partially shorted. Check voltages and resistances.
Radical change in BIAS SET reading.	<ol style="list-style-type: none"> 1. Changed power supplies without rechecking transmitter adjustment.
Transceiver locked in transmit mode.	<ol style="list-style-type: none"> 1. VOX DELAY control set too high. 2. Push-to-talk button stuck in depressed position. 3. Tube V10 faulty.
Plates of RF final amplifier tubes get red hot.	<ol style="list-style-type: none"> 1. No bias on tubes. Check voltage and resistances.
Very low input to grids of RF final amplifier tubes from driver V5.	<ol style="list-style-type: none"> 1. Coils L2 and L3 improperly installed. Check color dot markings. 2. T2 not aligned properly.

RECEIVER DIFFICULTIES	POSSIBLE CAUSE
Receiver squeals and oscillates with no antenna connected.	<ol style="list-style-type: none"> 1. Transmitting cutoff bias line partially shorted, turning on portions of the transmitter. Check voltages and resistances.
Received signals cannot be tuned in properly.	<ol style="list-style-type: none"> 1. Other station operating on other sideband. Try other portions of the dial.
No sound from speaker.	<ol style="list-style-type: none"> 1. Speaker unplugged or faulty. 2. Unit is transmitting.

GENERAL DIFFICULTIES	POSSIBLE CAUSE
Receive RF burns when removing antenna connector.	1. Transmitter tripped on by noise when in VOX operation.
Transceiver chassis "hot" causing electrical shock with linear amplifier connected.	1. Ungrounded high voltage connected to EXT RELAY socket. See Installation section of manual.
Filaments stay lit when Transceiver is turned OFF.	1. Improper power supply connections. 2. Power Supply (HP-20) still turned on. 3. HP-10 Power Supply not modified.
Meter reads backwards.	1. Meter improperly wired. 2. Meter switch improperly wired. 3. S METER ADJ control not set properly.
No output from VFO, V14.	1. Wrong or faulty tube in socket V13 or V14.

CIRCUIT DESCRIPTION

This Circuit Description is a detailed explanation of the Transceiver circuits that were covered only briefly in the General Circuit Description on Page 5. All circuit references in this description concern the Schematic Diagram.

SCHEMATIC DIAGRAM

The circled letter-number designations on the Schematic Diagram are used to identify resistors, capacitors, chokes, etc. Each of these designations is related to the tube stage in which it is used, by the first number; for instances, the resistors in tube stage V1 are designated R10, R11, etc. In tube stage V12 they are marked R120, R121, etc. This system of circuit component designation is used throughout the Schematic.

Numbers in diamonds on the Schematic refer to the color coding of the cable assembly wires. Numbers 1 through 9 indicate solid colors; numbers 10 through 18 refer to wires with a white background and a single color stripe; and numbers 20 through 28 refer to wires with a white background and two identical color stripes. The numbers can be related to wire colors by using the same color code as used for resistors: brown = 1, red = 2, orange = 3, etc.

TRANSMITTER SECTION

MICROPHONE AMPLIFIER V1A

Voice signals from the microphone are coupled through capacitor C12 to the grid of microphone amplifier tube V1A. The amplified signal at the plate of V1A is coupled through C14 to the Mic Gain control, and through capacitor C102 to the VOX (voice operated transmitter) circuit. The setting of the Mic Gain control determines the amount of modulation. Since V1A supplies signals for modulation and for VOX, it operates during both receiving and transmitting. Capacitor C10 bypasses to ground any RF signal picked up by the microphone push-to-talk switch lead.

AUDIO FREQUENCY CATHODE FOLLOWER

The audio signal from the Mic Gain control is applied to AF (audio frequency) cathode follower stage V1B. This stage matches the tube impedance to that of the balanced modulator. Bypass capacitor C19 keeps the modulator RF voltages from reaching V1B. During receiving, the relay cuts off V1B and a number of other transmitter stages.

BALANCED MODULATOR

When the audio signal from V1B and the RF signal from carrier oscillator V11B is applied to the 4-diode balanced modulator, two different frequencies are produced. This ring-type balanced modulator uses diodes CR1 through CR4.

One of the two signals produced by the balanced modulator is the sum of the audio and carrier frequencies; the other signal is the difference between the audio and carrier frequencies. These signals are the upper and lower sidebands.

The carrier signal is applied across the modulator diode ring in a balanced circuit, consisting of one winding of transformer T1, capacitors C1 and C2, resistors R3 and R4, and the Carrier Null control. The Carrier Null control is used to balance out the carrier signal in the modulator, leaving only the upper and lower sideband signals at the modulator output.

The output from the balanced modulator is the result of combining the audio and carrier signals. Neither the audio or carrier signals appear in the output, but the effect of the audio signals unbalancing the nulled circuit at an audio rate produces the sum-and-difference frequencies called sidebands. With no audio, there is no output from the balanced modulator.

With the Function switch in the Tune position, a DC voltage is applied to the balanced modulator through resistors R1 and R2. This voltage can be adjusted with the Tune Level control. This DC voltage is used to unbalance the modulator to provide a steady output signal for transmitter tuning purposes.

TRANSMITTER IF AMPLIFIER

The sideband signals from the balanced modulator are coupled through transformer T1 and then are amplified by transmitter IF (intermediate frequency) amplifier V2A. These signals are then applied to the crystal filter, consisting of crystals Y2 through Y5, and coil L1. The crystal filter eliminates the upper sideband, and permits the lower sideband to pass through to common IF amplifier V3 for additional amplification.

Stage V2 is turned off while receiving by applying additional negative DC voltage to its grid

through the secondary of transformer T1. This control voltage is impressed on the ALC (automatic level control) line, which is also used to control the gain in a number of other transmitter stages to prevent overloading. Overloading can be detected by observing the action of the meter. Normally the meter rests at or slightly below zero; however, if the operator talks too loud or if the Mic Gain control is set too high, the transmitter section would overload. This causes a change in ALC voltage which increases the bias, reducing transmitter gain and causing meter deflection to indicate ALC action.

COMMON IF AMPLIFIER V3

When transmitting, V3 amplifies the lower sideband signal from the crystal filter and then applies this signal to IF transformer T2. When receiving, the receiver IF signal is amplified by V3 and is then applied to receiver IF amplifier V9.

TRANSMITTER MIXER V4

Transmitter mixer V4 receives two signals simultaneously; one is the SSB signal from T2, and the other is the variable frequency signal output from V14, through the secondary of transformer T2. Tube V4 produces the difference frequency between these signals, which is at the proper operating frequency. This signal is applied to the primary of coil L2. (Tube V4 is cut off by bias voltage from the ALC line when receiving.) Coil L2, which has two windings, is broad-tuned to cover the 20 meter band. This coil is also used when receiving, and is then connected to receiver RF amplifier V8A and receiver mixer V8B.

DRIVER V5

Driver V5 receives the signal voltage from coil L2 through parasitic suppressor resistor R50. The ALC line is also connected to V5 to control transmitter gain, and to cut off the driver when receiving. Single-tuned coil L3 and the double-tuned coil L2 form a bandpass device that covers the frequencies of the 20 meter band without the necessity of tuning the driver stage. Voltage for bridge neutralization of final amplifier tubes V6 and V7 is fed through capacitors C63 and C64 to the bottom of coil L3, and across C55. The small winding of coil L3 is used for the input signal from the antenna when receiving.



RF FINAL AMPLIFIERS

RF final amplifiers V6 and V7 are connected in parallel. High voltage plate connections are under the chassis. The grids are connected by a long foil strip on the circuit board. This strip is bypassed at its ends by capacitors C61 and C71 to suppress VHF oscillations. Cathode resistor R71 is a meter shunt for measuring cathode current when the meter switch is in the Bias Set position.

Tubes V6 and V7 are operated as linear amplifiers, with high power sensitivity. Grid load resistor R72 is connected to the Final Bias control through R73, to allow adjustment of the grid voltage for proper operation. The Final Bias control is grounded through resistor R75 when transmitting. When receiving, this control is grounded through resistors R76 and R77 to increase the grid bias to cut off the final tubes.

AUTOMATIC LEVEL CONTROL

No grid current is drawn by tubes V6 and V7 in normal linear operation; however, when higher than normal grid drive is applied, grid current will flow and change the bias voltage. This higher-than-normal grid drive, caused by too much audio signal, makes the bias voltage change at an audio rate. This varying bias voltage is coupled through capacitor C75 to diode D70, which rectifies the signal to develop the DC negative ALC voltage which is applied to V2A, V4, and V5. Resistors R78 and R79, along with capacitor C74, filter this voltage and provide the proper time delay for ALC action. The entire ALC circuit is biased above ground by resistors R76 and R77 to cut off the transmitter section when receiving.

TRANSMITTER OUTPUT CIRCUIT

The plates of the RF amplifier tubes are connected to the supply voltage by choke RFC61. Their signal is coupled to the pi-section output circuit through capacitor C67. Output coil L4 is tuned by Final Tune capacitor C65. Antenna loading is fixed by capacitor C77. With the Function switch in the Tune position, a sampling of the output voltage from resistors R61 and R62, and diode CR60, gives a meter indication to indicate proper adjustment of the Final Tune capacitor.

RELAY-TRANSMIT-RECEIVE SWITCHING

Switching between transmitting and receiving is done by the relay. Section A of the relay switches the antenna, and section C switches the bias voltages.

Section B of the relay is connected to the Ext Relay socket on the rear of the Transceiver, and can be used to control external equipment, such as a linear amplifier or antenna relay. Because one side of the Ext Relay socket is grounded to the Transceiver chassis, the socket must not be used to switch any voltage in a circuit that operates above ground, as the chassis would become "hot," causing a possible shock hazard.

VOX AMPLIFIER V10 AND RELAY AMPLIFIER V2B

The Transceiver can be switched from receive to transmit by either the push-to-talk or the VOX method. VOX Amplifier V10 is normally operated in a saturated condition, that is, with very low plate voltage and maximum plate current. Positive half cycles of the voice signals from V1A have no effect on V10, however, the negative half cycles cause the plate current to drop, thus increasing plate voltage. This increased plate voltage fires neon lamp NE2, providing a positive switching action. The voltage from the neon lamp is then amplified by relay amplifier V2B, which operates the relay. Capacitor C105 and resistor R107 form a delay network that establishes the time the relay stays closed after being tripped. The length of time is determined by the setting of the VOX Delay control.

ANTI-TRIP CIRCUIT

Because the VOX stages operate on both transmit and receive, the speaker signals during receive must be kept from tripping the relay when receiving. This is done by taking a portion of the audio signal from AF output stage V12A, rectifying it with diode D100 to produce a positive voltage, and feeding this voltage to the grid of V10 from the VOX control. This voltage tends to increase the plate current of V10; signals from the microphone (picked up from the speaker) tend to decrease the plate current. Therefore

with both signals present at the grid of V10, the signals cancel each other, preventing the speaker from tripping the VOX circuit. Speaking into the microphone produces signals not present in the speaker circuit, permitting the VOX circuit to function normally. The VOX control not only adjusts for proper anti-trip voltage, but also determines the sensitivity of the VOX circuit.

PUSH-TO-TALK CIRCUIT

With the Function switch in the PTT (push-to-talk) position, V10 is disabled by grounding its grid, V2B is made to operate and close the relay by grounding its grid (shorting the bias) with the push-to-talk switch in the microphone. The Function switch in the PTT position also makes the VOX delay circuit inoperative by removing C105 from ground. Push-to-talk operation with the Function switch in the VOX position uses the VOX delay circuit, causing the receiver to "delay" before coming on after the microphone button is released. The Function switch in the Tune position turns the transmitter on by grounding the grid of V2B.

RECEIVER SECTION

RADIO FREQUENCY AMPLIFIER V8A AND RECEIVER MIXER V8B

The incoming signal is connected to RF amplifier V8A through coil L3. The amplified signal from V8A is then coupled through coil L2 to receiver mixer V8B. During receiving, cutoff bias is removed in the receiver section to permit tubes V8A, V8B, V9, and V12A to operate. V8A is controlled by bias from the AVC (automatic volume control) circuit. AVC in the receiver is similar to ALC in the transmitter, in that it maintains a constant receiver output (gain) even though the incoming signal level may vary considerably. The cutoff voltage on the bias line is controlled by section C of the relay.

CRYSTAL FILTER

The signal is coupled from mixer V8B to the crystal filter through C80, which is small in value to avoid upsetting the input impedance of the filter. The crystal filter exhibits the same characteristics in receiving as in transmitting;

it shapes the IF passband to have steep sides, a flat top, and a narrow bandwidth. This permits good selectivity for SSB reception in crowded amateur bands.

COMMON IF AMPLIFIER V3 AND RECEIVER IF AMPLIFIER V9

Signals from the crystal filter are amplified by common IF amplifier V3 and then fed to receiver IF amplifier V9. The cathode and screen of tube V9 are connected directly to those of tube V2A. The meter, which is connected in this circuit, indicates received signal strength in S units, as the AVC voltage changes the current in V9. The meter functions as an ALC indicator when transmitting without any switching. The gain of V9 is controlled by the AVC voltage applied through resistors R91 and R92.

PRODUCT DETECTOR V11A AND AUDIO FREQUENCY AMPLIFIER V12B

The amplified signal from V9 is coupled through IF transformer T3 to the grid of product detector V11A. Also, a signal from carrier oscillator V11B is fed to the cathode of V11A. A heterodyne mixing action takes place in V11A, resulting in an output signal which is the difference frequency of these two signals; an audio signal. Capacitors C111 and C112 bypass any RF signal coming from V11A, but permit the audio signal to pass through to AF amplifier V12B. The output from V12B is fed to the AF output amplifier V12A through the AF Gain control, and to the AVC circuit.

AUTOMATIC VOLUME CONTROL

Audio voltage is coupled to diodes D120 and D121 through resistor R128 and capacitor C128. The diodes and capacitor C129 form a voltage doubler, producing a negative DC voltage proportional to the signal strength. Full AVC voltage is applied to the grid of receiver RF amplifier V8A to prevent overloading by strong received signals.

Capacitor C129 in the AVC circuit charges quickly to furnish a fast AVC response time,

while the charging of larger capacitor C88 gives a slow AVC release time. Resistors R80, R122, R123, and R124, with capacitor C123, divide the AVC voltage applied to V9 and V12A and provide decoupling. To provide delayed AVC, resistor R123 is returned to the cathode of V12B rather than to ground. This balances the AVC voltage (caused by noise when no signal is being received) with a small positive voltage to improve receiver sensitivity at low signal levels.

AUDIO FREQUENCY OUTPUT AMPLIFIER V12A

Amplified audio signals from V12A are fed to the speaker socket through output transformer T4. To provide maximum intelligibility, the frequency response of the output stage is limited to the voice of frequency range by a sharp-cutoff, high frequency, degenerative feedback loop. High frequencies across RFC120 cause its impedance to rise. The high frequencies are thus returned out-of-phase to the grid of V12B. This signal cancels out the incoming high frequency audio and noise signals at the grid of V12B. Capacitor C120 is a low frequency bypass to ground, and capacitor C127 serves as a parasitic oscillation suppressor.

CARRIER OSCILLATOR

Carrier oscillator V11B supplies an RF signal to the balanced modulator, and a heterodyning signal to product detector V11A. Tube V11B is a Colpitts type oscillator. Crystal Y1 determines the operating frequency to accurately maintain the proper frequency relationship with the crystal filter bandpass frequencies. Capacitors C117 and C118 provide feedback to maintain oscillation. The output is taken from the junction of capacitors C115 and C116.

VFO

Variable Frequency Oscillator V13 is also a Colpitts type of oscillator which operates at low frequency for maximum stability. Coil L6 provides the necessary inductance, while capacitors C132, C133, and C134 form a divider for oscillator feedback and output connections. C130 is a negative temperature coefficient capacitor which compensates for changes in temperature thereby maintaining correct calibration of the VFO dial. The oscillator output is taken from the junction of capacitors C133 and C134 and is applied to heterodyne oscillator-mixer V14. Harmonics are suppressed by capacitor C134.

The heterodyne oscillator-mixer stage consists of a fixed crystal-oscillator circuit using part of V14, crystal Y6, capacitors C141, C146, and R143. Choke RFC140 and resistor R140 provide a DC path to ground, and cathode bias for V14. Capacitor C146 provides feedback to maintain the circuit in an oscillating condition and resistor R143 provides the DC return for the fixed crystal-oscillator grid circuit. The internal tube elements connected to pin #6 of V14 provide B+ voltage (plate) for this oscillator circuit.

The VFO heterodyne coil L5 is essentially a bandpass filter which passes the "difference" signal produced by VFO stage V13 and the fixed crystal-oscillator section of V14. This resultant beat frequency signal is applied through L5 and capacitor C142 to the receiver-mixer V8B, and to the grid of transmitter-mixer V4 through one-half of common IF transformer T2.

ACCESSORY CRYSTAL CALIBRATOR

The accessory plug-in crystal calibrator is turned on by pulling out the knob of the AF Gain control. The calibrator filament circuit is grounded internally to the calibrator chassis. For this reason, the calibrator chassis must not be grounded to the transceiver chassis. Resistor R6 is the calibrator plate current return; resistor R5 drops the calibrator filament voltage to 6 volts.

FILAMENTS

The filament wiring of the Transceiver is a series-parallel arrangement that balances the filament voltage without wasting power in dropping resistors. This filament arrangement allows the use of both 6 volt and 12 volt filament tubes in the Transceiver design. The filaments of RF power amplifiers V6 and V7 are isolated by choke RFC60 to prevent RF energy from getting to the other tube filaments.

POWER SUPPLY

Operating voltages for the Transceiver are provided by an external power supply. The power supply is turned on or off by a switch on the rear of the Transceiver Function switch. This off-on switch is wired through the Transceiver power plug to the external power supply.

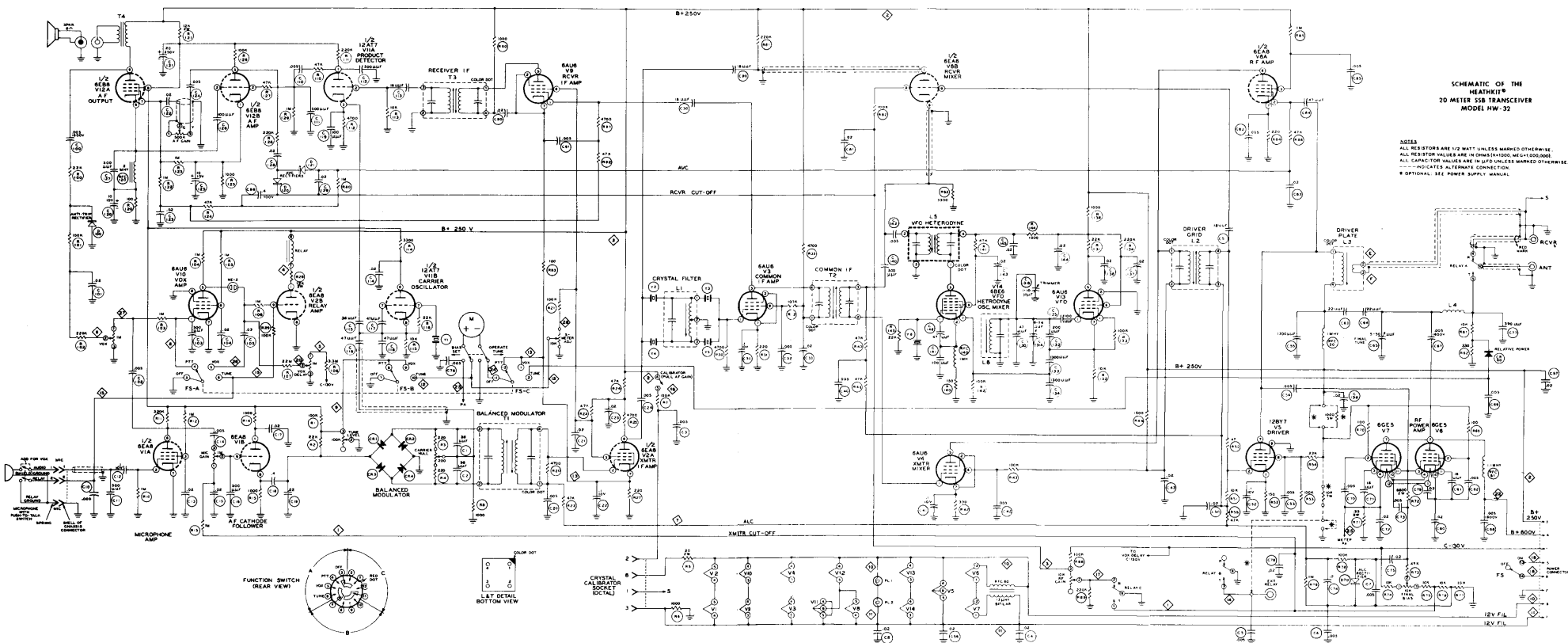

**SCHEMATIC OF THE
HEATHKIT®
20 METER 5B TRANSCEIVER
MODEL HW-32**

NOTES
 ALL RESISTORS ARE 1/2 WATT UNLESS MARKED OTHERWISE.
 ALL RESISTOR VALUES ARE IN OHMS UNLESS OTHERWISE MARKED.
 ALL CAPACITOR VALUES ARE IN P.F. UNLESS MARKED OTHERWISE.
 --- INDICATES ALTERNATE CONNECTION.
 * OPTIONAL. SEE POWER SUPPLY MANUAL.



HEATH COMPANY

BENTON HARBOR, MICHIGAN 49023

YUKON 3-3961

TWX-616-983-3897

Dear Customer:

This bulletin covers modifications for the HW-12, HW-22 and HW-32. The necessary components for your particular transceiver will be sent at no charge. Make the changes pertaining to your transceiver only.

In the HW-12; Replace capacitors C-4 and C-56 with .022 μ fd mylar capacitors
Another capacitor should be installed in the small holes adjacent to the 1,000 Ω resistor in section 3A.
Resistor R-72 should be increased in size to 2 watts.
Replace R-77 with a 10K 1/2 watt resistor.

In the HW-22; Replace capacitors C-4, C-56 and C-138, with .022 μ fd mylar capacitors
Install a .022 μ fd mylar capacitor on the foil side of the circuit board from pin 3 of V-13 to ground.
Also, install a .001 μ fd capacitor directly across pins 2 and 7 of V-1.

KEEP THESE LEADS AS SHORT AS POSSIBLE. WE CANNOT STRESS THIS POINT ENOUGH SINCE LONG LEADS COULD CAUSE ADDITIONAL OSCILLATION.

Next, increase the size of R-72 to 2 watts and install a 33 Ω 1/2 watt resistor from lug 4 of the plate tuning capacitor to the bottom lug of the final tank coil nearest the RF choke.

The changes for the HW-32 are the same as those for the HW-22; except,

that an additional bypass capacitor at location C-8 should be replaced. In all cases, make certain the SWR on the antenna system is well below 1.5:1. Keep the microphone gain control as low as possible to the consistent with full output. If the delay control is set too high, this could also effect operation.

HW-12	HW-22	HW-32
3-27-27 .022 μ fd Mylar	4-27-27 .022 μ fd Mylar	5-27-27 .022 μ fd Mylar
1-1B-17 6.8K Ω 2 watt	1-21-14 .001 μ fd 500V	1-21-14 .001 μ fd 500V
1-1-20 10K 1/2 watt	1-1B-2 4.7K 2 watt	1-1B-17 6.8K Ω 2 watt
	1-1-103 33 Ω 1/2 watt	1-1-103 33 Ω 1/2 watt

HW-32 MODIFICATION

RE: HW-32

Problem: Oscillation with load impedance higher than 50Ω

Solution: Eliminate ground loop effects

250-212 2-56 screw ea 5

340-1 Bare Wire 6"

- () Punch a small hole in the upper surface of the shield cans of T2, T3, L2, L3, and L5 as indicated in the attached pictorial. Use a sharp awl or ice pick.
- () Put a 2-56 screw in each hole
- () Using bare wire, connect L5 (S-1) to T-2 (S-1), soldering the wire to the screw heads.
- () Similarly, connect a bare wire from L3 (S-1) to L2 (S-2) and to T3 (S-1).

