

The HOWES CTX80 is an 80M amateur band CW (Morse) transmitter.

Brief Specification.

Output power: adjustable up to about 5W RF.
Spurious outputs: Harmonics well suppressed, worst case (second harmonic) better than 40dB down. Key click suppression built in.
Crystal frequency: 3.5795 supplied as standard. Provision for external VFO, and two other crystals on PCB.
Output conditions: 50 Ohm unbalanced output, VSWR of better than 2:1 recommended. Output transistor will survive a bad match.
Supply voltage: Nominal 13.5V DC supply @ approx 500mA.

TOOLS REQUIRED:

Soldering iron about 30W, small side cutters, long-nosed pliers, small trimming tool for L1 and VR1. You will need a power meter/swr meter and a 50 Ohm load for testing the unit. A reasonable multimeter will be useful for checking coil windings and current consumption. A sharp knife for scraping the coil insulation

BUILDING THE KIT.

Start by winding the coils for this project, this way you will be able to sit down and assemble the PCB at one go - it won't take you very long to do. Refer to the coil winding details on the parts list 2 sheet, make sure you do the winding in a quiet spot (turn the sets off if you are in the shack), the wire is quite fine and it is almost impossible to count how many turns you have wound if something distracts you half way through! When you have wound the coils it is a good idea to coat them with a little clear varnish to hold the windings in place. While this is drying, read the rest of this paperwork through. and check you have all the right parts and tools to hand. I would recommend you fit the parts in the order they appear in the parts list, resistors first, then capacitors, semiconductors and coils last. The part number given in the parts list corresponds to a part number printed on the circuit board so assembly is very easy. The crystal can be put in whichever "xtal" position you prefer. Make sure you put the electrolytic capacitors in the right way round. Keep all component leads as short as possible.



Make sure that you clean the ends of the coil wires so that they solder well. Scraping the insulating off with a sharp knife is probably the best. When the coils are soldered to the tracks, check with a multimeter that there is a very low resistance between the tracks at the ends of the coil, this will make sure that there is no dry joint on the coil leads. These are the most likely places to cause trouble, as these leads are not ready tinned for obvious reasons.

When you have finished assembly of the board, check all the parts are in the right places, the capacitors are the right way round (electrolytic devices only) and that the soldering looks bright and good. Resolder any suspect joints with a little fresh solder. Hold the board up to a bright light, looking at the wiring side so that the tracks are in silhouette, check that there are no shorts or splashes of solder between tracks. We find that nearly all problems that occur with our kits are due to poor soldering or shorts across tracks. Component failures are very rare with the quality of parts we supply.

When you are sure all is well, connect up a power meter or swr bridge and a 50 Ohm dummy load of at least 5W rating. Link the crystal to terminal "B" on the board, and a morse key to the "K" and "E" terminals. Connect the module to a suitable power supply - the right way round please! Negative earth. Set VR1 to half way. Now press the key, hopefully there is no smoke, and probably no indication on the power monitoring meter! Adjust the core of L1 until there is an output, now adjust for maximum output consistent with the oscillator restarting when you release and depress it again. At the very peak of output, the oscillator tends not to restart reliably, this is correct, simply adjust it so it does. You can now set VR1 for the desired output power. Do not hold the key down for long periods at full power, the heatsink is rated for normal CW use.

Refer to the wiring details and install the CTX80 in a metal case.

RESISTORS		Description	Fitted	Checked
Part No.	Value			
R1	33k	Orange Orange Orange		
R2	100k	Brown Black Yellow		
R3	270R	Red Violet Brown		
R4	47R	Yellow Violet Black		
R5	10k	Brown Black Orange		
R6	1k0	Brown Black Red		
R7	1k0	Brown Black Red		
R8	10k	Brown Black Orange		
R9	47R	Yellow Violet Black		
R10	2R2	Red Red Gold		
R11	47R	Yellow Violet Black		

PLEASE NOTE

R12 is not fitted to CTX80.

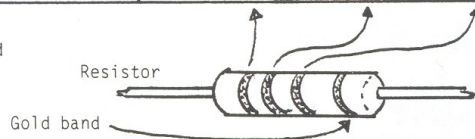

VR1 470R preset resistor.

CAPACITORS		Description	Fitted	Checked
Part No.	Value			
C1	1nF	Marked .001 or 102		
C2	.1µF	" 104K		
C3	470pF	" 470 or N47		
C4	1nF	" .001 or 102		
C5	1nF	" .001 or 102		
C6	.1µF	Marked 104K		
C7	.1µF	" 104K		
C8	.1µF	" 104K		
C9	100µF	" 100µF 25V		
C10	100µF	" 100µF 25V		
C11	.1µF	Marked 104K		
C12	560pF	" 560 2.5%		
C13	1200pF	" 1.2n		
C14	680pF	" 680 2.5%		
C15	.1µF	" 104K		
C16	100µF	" 100µF 25V		
C17	100pF	" 101		

160m (1.8M) in brackets

(1200pt)
(10n)
(100pt)

(1800pt)
(2200pt)

NOTE C9, C10 and C16 are Electrolytic capacitors and MUST be installed the correct way round. The lead indicated by the "-" signs on the side of the component must go to the hole marked "-" on the circuit board. The longer of the two leads of the capacitor (the +ve lead) goes to the hole marked "+".

TRANSISTORS

TR1, TR2 & TR3 are BC237B devices they should be installed in the board as the outline printed on the board shows.

TR4 is a BD135 and should be bolted to the heatsink and board with the nut and bolt provided. The mica washer provided must be placed between the transistor and the heatsink. The metal insert in the transistor is the side of the device that must be towards the heatsink. When you have bolted TR4 in place check with a multimeter on its' ohms range that the transistors' center lead is not shorted to the bolt or heatsink. If it is, check the mica washer is not damaged or inserted incorrectly.

INDUCTORS

These are quite simple to wind, but do make sure you get the exact number of turns stated on each coil.

L1 This is the most trouble to wind, a method of holding the wires in place as you go is needed. You can glue or tape the first turn at the bottom of the former to hold it in place or you can make a small jig as shown in the diagram, this is the best solution. The windings can then be held in place with a coat of clear varnish. L1 needs about 30" of enamelled wire (765mm).

NOTE When the transmitter has been tested, fix the core of L1 to prevent it moving with a drop of "copydex" or wax.

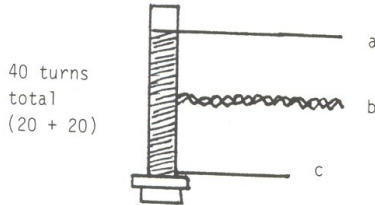

Letters refer to holes marked on PCB.
Wind 20 turns, then twist the wire together for about 1" or so (30mm) to make the center tap, continue winding in the same direction for another 20 turns.

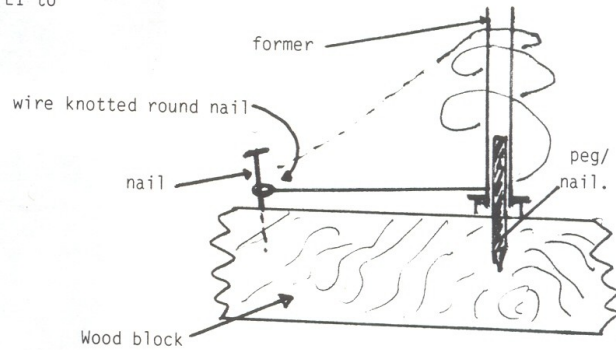

Winding Jig

L2 This is wound on the two hole balun core. Use the plastic insulated wire supplied. Enamelled wire should not be used for winding this transformer. Be careful when you strip the ends! There are four turns on the primary winding, and one on the secondary. The two windings are shown on separate diagrams for clarity, **wind both on the same core!**

(RAD STRIP)

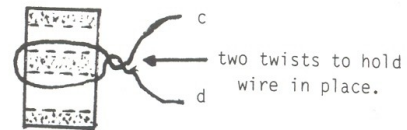
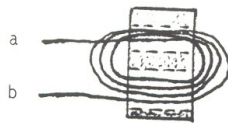

L3 This is wound on the BLACK toroid core. There are 12 turns of enamelled wire, be carefull not to scrape the enamel as you wind it.

Use 8" (205mm) of wire.

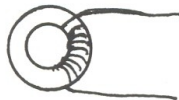

(RED/GRN BAND)

L4 and L5 These are wound on the green and white toroids. L4 has 20 turns, L5 has 35 turns. Both use enamelled wire. L4 requires 13" of wire, L5 requires 22". (330 and 560 mm respectively).

L4 1sturns on T50-2



L5/C14 to standard filter tables.

Wire up the CTX80 in a metal case as shown:-

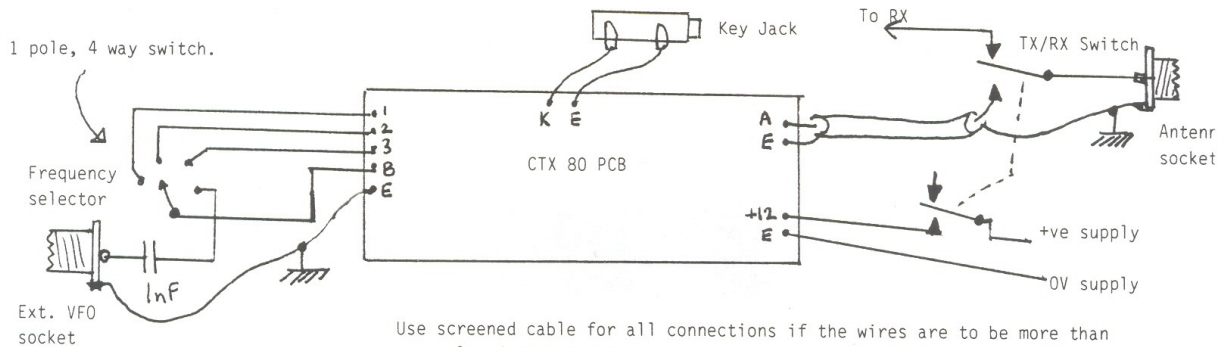

Use screened cable for all connections if the wires are to be more than a couple of inches long. Keep all wiring to do with the crystal selection well away from the output wiring. The TX/RX switch is a double pole change-over type. You could use a relay to switch the unit instead.

You could add a HOWES ST2 side-tone unit to monitor your transmitted morse. There is provision to add an AM modulator (if you really want to) by removing R10 and feeding points "g" and "h" to a suitable modulator. If the transmitter is to be keyed for long periods, then the addition of a larger heatsink is a good idea, if not essential. R10 can be replaced with a link to produce a slight increase in output power. This resistor is added to help protect the output device while testing the unit. It is slightly over-run, this is done on purpose, it makes a good fuse in case of problems!

The CTX80 like other transistor transmitters should not be run into high SWR antenna systems. An SWR of less than 1.5:1 is recommended, higher SWRs of more than 2:1, while unlikely to cause damage, should be avoided. With certain bad mismatch impedances it is possible for the output stage to become unstable. This is unlikely to occur at less than 3:1 SWR. This need to avoid bad mismatches is common to most solid state designs, but we have not at the time of writing managed to "blow up" a CTX80 PA transistor, they are pretty robust.

Brief Circuit Description.

The CTX80 is a simple transmitter. It is not as simple as some, but we do not think you can get good performance with less parts. TR1 is a crystal oscillator, or buffer amplifier if an external VFO is fed to point "B" in place of the crystal. L1 is tuned to the operating frequency by a dust iron core. The signal from L1 is coupled to a buffer amplifier, TR2. This stage has unity voltage gain, but prevents the oscillator "chirping" as the unit is keyed, by providing isolation between TR1 and TR3. TR2 has a preset resistor (VR1) in its emitter lead, this adjusts the voltage fed to TR3, the driver transistor. TR3 is keyed in its emitter lead. R11 and C9 shape the keying waveform to prevent key clicks. TR3 can be keyed by a "straight" key or an electronic keyer as long as it has the correct keying polarity. (+ve volts appear on "K" with respect to "E"). L2 couples the signal to TR4, the PA stage. L3 is an RF choke, C12, L4, C13, L5 & C14 form a low-pass filter as well as matching the output of TR4 to a 50 Ohm impedance. TR4 produces a maximum of about 5W in this design, but it has a much higher power rating and seems to survive mismatches without any problem. At certain complex impedances, rather than the 50 Ohm the TX should feed, it is possible for the output to become unstable, so high SWRs should be avoided in case of any spurious oscillation being caused by them. With a simple design we have found it is not possible to build a low cost PA that is totally unconditionally stable under all complex impedance loads. The CTX80 is very stable in normal use. We think this design gives a much better performance than most QRP transmitter designs that have been published, we hope you will agree. The CTX80 should help put some fun into amateur radio. Good DX!

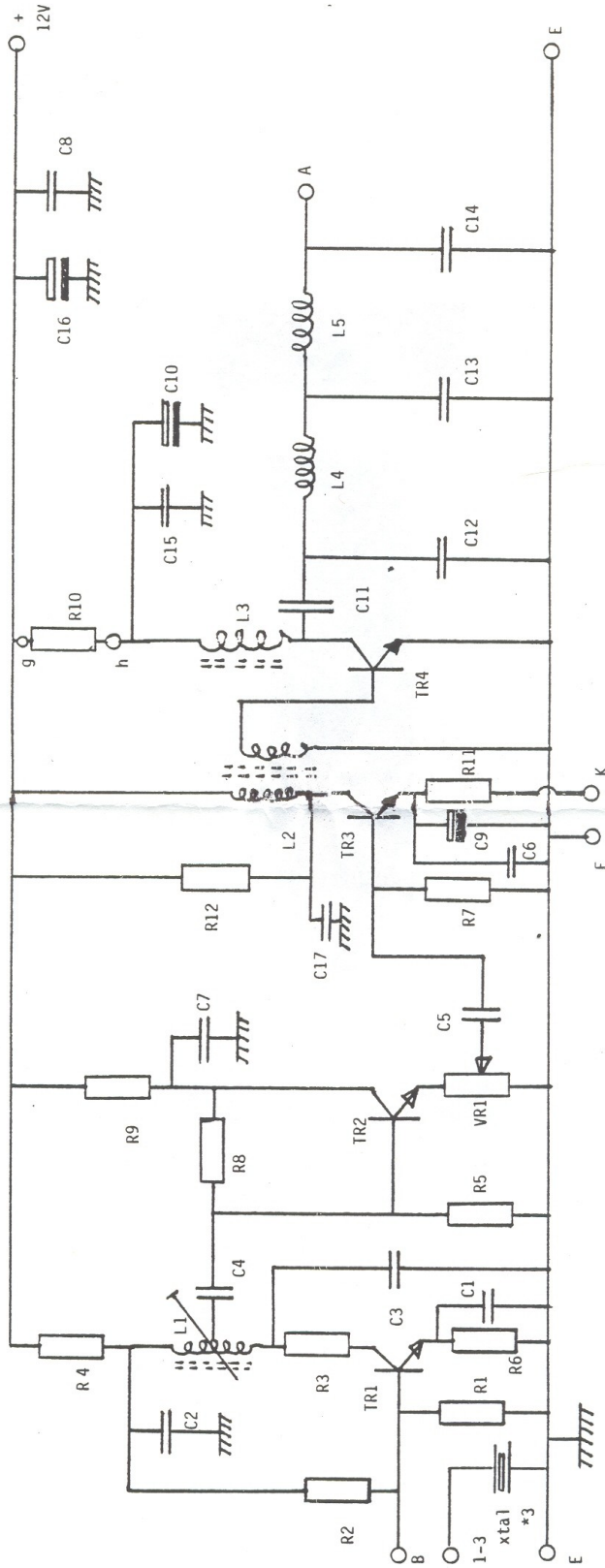

NOTE VR1 should not be turned fully clockwise. The key shaping is impaired if VR1 is advanced more than about three-quarters of its travel, this will lead to a less clean, "clicky" signal.

Positions for 3 HC18 crystals on PCB, or HC25 types.

VR1 sets output power level. Key-down should not be maintained for long periods at higher power settings of VR1, unless a larger heatsink is fitted to TR4.

R10 may be replaced by a wire link for higher output levels. Beware of overheating TR4.

C.M.HOWES COMMUNICATIONS

(0327) 60178

Eydon, Daventry,
Northants NN11 6PT

Suggested values for converting
CTX80 to 160m band.

$$C3 = 1200 \text{ pF}$$

$$C4 = .01 \mu\text{F}$$

$$C5 = 100 \text{ pF}$$

$$C12 = 1800 \text{ pF}$$

$$C13 = 2200 \text{ pF}$$

$$L4 = 15 \text{ turns on T50-2}$$

L5 & C14 to form rest of O/P filter
for 160m band (see standard filter
table)

D.A.