

**PANAXIS**

**AM – 100**

**AM BROADCAST**

**TRANSMITTER**

**PANAXIS COMPANY**  
**WAS BOUGHT BY**  
**PROGRESSIVE CONCEPTS**  
**ON OCTOBER 11, 2007**  
**NEED ANY INFORMATION ON PAST**  
**PANAXIS ELECTRONICS PLEASE CONTACT**

**Eric Hoppe**  
**Progressive Concepts**  
**305 South Bartlett Road**  
**Streamwood, IL 60107**  
**PHONE. 630.736.9822 Fax: 630.736.0353**  
**[www.progressive-concepts.com](http://www.progressive-concepts.com)**

**COMPILED BY JEFF MORRISON APRIL 14, 2015**

# **TABLE OF CONTENT**

## **PAGE**

- 1) THE AM – 100 PLANS PACKAGE**
- 2) AM 100 & AM 5 ENCLOSURE CHANGES & CIRCUIT MODIFICATIONS**
- 3) CONSTRUCTION PLANS AM – 100 AM BROADCAST BAND TRANSMITTER SPECIFICATIONS, THEORY OF OPERATION, CARRIER FREQUENCY GENERATION**
- 4) THEORY OF OPERATION, CONT'D., & LINEAR CHOPPER & CARRIER CONTROL**
- 5) THEORY OF OPERATION, CONT'D., & LINEAR CHOPPER & CARRIER CONTROL**
- 6) THEORY OF OPERATION, CONT'D., & LINEAR CHOPPER & CARRIER CONTROL LOAD IMPEDANCE & MODULATION**
- 7) SCHEMATIC, FIG. 1**
- 8) PARTS LIST & PARTS SOURCES**
- 9) ASSEMBLY INSTRUCTIONS, PARTS IDENTIFICATIONS**
- 10) ASSEMBLY INSTRUCTIONS, CONT'D. , FIG.2**
- 11) FINAL ASSEMBLY INSTRUCTIONS, CIRCUIT BOARD LOCATIONS**
- 12) FINAL ASSEMBLY INSTRUCTION, CONT'D. FRONT PANEL FIG. 4A, BACK PANEL FIG. 4B, ARTWORK FIG. 5**
- 13) FINAL ASSEMBLY INSTRUCTION, CONT'D. & TESTING & OPERATION**
- 14) TESTING & OPERATION CONT'D. & OPTIONAL MODIFICATIONS**
- 15) OPTIONAL MODIFICATIONS CONT'D. MODULATION**
- 16) AM – 100 PC ART WORK & TOP OF COMPONENT SIDE FIG. 2**
- 17) PICTURE**

## THE AM-100 PLANS PACKAGE

Your AM-100 plans package actually contains two sets of plans. One set covers the construction of the AM-100 transmitter, the other covers the power supply. Both should be read carefully before actual construction begins. If you have purchased a kit from us be sure to check if all parts are in the kit. Notify us immediately if any parts are missing. Defective parts and missing parts will be replaced.

The PS-700 power supply was originally developed as part of our FMS stereo FM transmitter kit. However it is also quite suitable for the AM-100. Where it says "FMS" in the plans simply substitute AM-100 instead. The AM-100 works well with the + and - 12 volts supplied by the PS-700 supply although the AM-100 calls for + and - 15 volts. If you so desire you can change the voltage regulators to the 15 volt types. These would be the LM340T-15 instead of the LM340T-12 and a LM320T-15 instead of a LM320T-12. Other code numbers include a 7815 instead of a 7812 and a 7915 instead of a 7912.

FCC Rules are quite specific about what is acceptable in the way of broadcasting without a license. It is allowed, but with restrictions. These include:

- (a) If connected to an antenna the transmitter input power must not exceed 100 mW.
- (b) The antenna length, including transmission line, must not exceed 10 feet.
- (c) Field intensity must be less than 15 microvolts/M at a distance of  $157/\text{freq (MHz)}$ .
- (d) Harmonics and spurious signals outside the band must be less than about 1 mW.
- (e) No harmful interference may be caused to any licensed radio station.

These and other stipulations are covered in Part 15 of the FCC Rules. You can request a special information sheet concerning "Low Power Communications Devices" from the FCC for further details. **DO NOT TELL THE FCC YOU ARE GOING TO BROADCAST.** Just get the information, read it, and then determine what you want to do. The FCC rarely bothers anyone unless they have received a complaint or have other knowledge that someone is abusing the Rules. Don't use profanity, don't interfere with other radio signals, don't get your neighbors angry, and try to stay within the Rules- you shouldn't have any trouble.

There are also provisions for broadcasting through coax cables, special "leaky" cables, and the ac power lines. These include special techniques of coupling and distribution. We strongly recommend reading our book **CARRIER-CURRENT TECHNIQUES** which covers these subjects. Also covered in our book are ways to extend your coverage area with repeaters, how to make impedance matching transformers, etc.

## AM100 AND AMS ENCLOSURE CHANGES

We are in the process of changing the AM100 and AMS enclosure. Complete documentation is not available yet. This sheet plus the original assembly instructions however should give you enough information to complete the unit.

The main differences are:

- (1) The new enclosure is larger
- (2) The audio (RCA jacks) connectors are now on the rear panel
- (3) All boards are mounted with 4-40 screws, 1/4" aluminum spacers, and matching nuts.

Front panel: LED is on the right, power switch on the left

Rear panel: RF output jack is on the left, AC power cord with strain relief is on the right. Audio (RCA) jacks are in the center.

The enclosure has a thin plastic film on it. This is for protection while drilling holes and during other assembly procedures. It may be removed after the unit has been tested and is ready for operation. After its removal you should remove the 4 disks from the black rubber pad - these are the "feet" for the enclosure. Stick one at each corner of the bottom of the enclosure.

## CIRCUIT MODIFICATIONS

Page 6: R2 should be listed as 1.0K

Page 7: R2 should be listed as 1.0K (Brn/Blk/Red) same as R5  
R4 should be listed as 1.0K (Brn/Blk/Red) same as R5

The LM349 quad op-amp has been replaced with type TL074 (lower noise)

The 4018 IC may have a suffix of B, BC, BE, or BF

Page 8: C7 was originally a fixed value ceramic disc. Its been replaced with a miniature trimmer capacitor. Although the drawing shows a rectangle (near + end of C12) for C7, it is actually round now.

Page 9: The position of the pc boards is essentially the same except the newer enclosure has more room. See above for connector changes.

Page 12: After the initial tuning of C13 for maximum output you should apply audio and fine tune it. If the modulation (loudness) appears to be better while tuning EITHER SIDE of maximum output, then you may have "negative modulation". Correct this by lowering the signal level to L2. This can be done either by reducing the capacity of C7 (trimmer) or making the value of R24 smaller, or both. After adjusting C7 you will have to go back and "touch up" C13. Ultimately tune for the loudest and cleanest sound using C13, C7, and R16.



## CONSTRUCTION PLANS

## AM - 100 BROADCAST BAND TRANSMITTER

(AM0)

The AM-100 is a low power transmitter with an operating frequency between 540 KHz and 1600 KHz (Standard Broadcast Band). It has a maximum output power of 100 mW to conform with FCC Rules. It will match a number of antenna and cable impedances which are most often encountered in low power broadcasting. It is crystal controlled for excellent frequency stability. An "on board" programmable frequency divider allows the use of a higher frequency crystal, which when divided down produces the final frequency of transmission. A "carrier control" circuit raises the effective carrier power during high modulation peaks thus avoiding undesirable distortion and splatter.

A linear amplifier of up to 5 watts may be installed in the same cabinet. This would be used for driving cables and/or power lines for "carrier-current" operation.

SPECIFICATIONS

Audio Response	20-20 KHz (greater than needed for AM)
Distortion	.5% or less at 100 % modulation
Noise	50 dB below 100 % modulation
Audio Input Impedance	10,000 ohms unbalanced
Audio Level	.3 volts rms for 100 % modulation
Carrier Stability	.005% (crystal controlled)
Carrier Power	100 mW (legal limit)
Output Impedance	Inf. down to 50 ohms direct, transformer line drive (less than 50 ohms)
Power Requirements	+,- 12 volts at 200 mA DC, or 117v AC

THEORY OF OPERATIONCarrier Frequency Generation

An oscillator circuit consisting of  $Q_1$ ,  $L_1$ ,  $C_2$ ,  $R_1$ , and a crystal (X) produces a frequency of up to 6 MHz. Its output is loosely coupled thru  $C_3$  to the input of the programmable divider (4018B). The output of the 4018B (pin 1) is determined by the frequency division selected, as follows:

- Pin 4 shorted to Pin 1 = divide by 4
- Pin 6 shorted to Pin 1 = divide by 6
- Pin 11 shorted to Pin 1 = divide by 8
- Pin 13 shorted to Pin 1 = divide by 10

Odd number division requires two programming pins connected to the output pin. To avoid improper operation of the divider these pins must be connected by means of diode gates. Pin numbers are as follows:

Pins 4 and 6 to Pin 1 = divide by 5

Pins 6 and 11 to Pin 1 = divide by 7

Pins 11 and 13 to Pin 1 = divide by 9

These 7 divisions were the only ones selected for the AM-100 as they prove to be the most effective when the oscillator is operated with a 6 MHz crystal. Divisions of 2 (3 MHz) and 3 (2 MHz) would be outside of the broadcast band.

Selection of various frequencies is accomplished by setting the appropriate switches of the pc mount DIP switch, as follows:

<u>Switch activated</u>	<u>Carrier Frequency</u>	<u>Switch activated</u>	<u>Carrier Frequency</u>
1	1500 KHz	3	750 KHz
1 and 2	1200 KHz	3 and 4	667 KHz
2	1000 KHz	4	600 KHz
2 and 3	857 KHz		

Of course other frequency crystals can be used as you desire. The crystal frequency must be less than 6 MHz however as this is near the maximum input frequency for the 4018B IC.

Diodes  $D_1 - D_4$  and resistor  $R_2$  make up the diode gate mentioned earlier. If only even divisions are desired then the diodes may be replaced with a wire jumper and  $R_2$  can be removed. If you desire only one fixed division then the DIP switch may also be omitted and an appropriate jumper installed in its place.

After the carrier frequency has been selected it is coupled thru  $C_4$  to the amplifier  $Q_2$ . An almost square wave signal is produced across  $R_4$  with a peak to peak value of about 30 volts. This raw carrier is fed to the linear chopper thru  $R_5$ .

#### Linear Chopper and Carrier Control

We'll begin this with an explanation of the dc bias levels of the LM 348 op-amp. The two resistors  $R_{18}$  and  $R_{19}$  split the power supply voltages. In this case +15 and -15 equals 0 volts. This voltage is applied as a bias at pin 3 (non-inverting input of one op-amp). This op-amp is connected as a voltage follower so its output is near 0 volts. This appears at point "A". This is used to bias the inverting input of another op-amp (pin 13). The offset voltages however produce about -.6 to -1 volt at the output of that op-amp (pin 14). This amp has a voltage gain of about 1. Its output is fed to the next op-amp (gain of 1 also) inverting input - it then has a +.6 to +1 volt at its output (pin 8).

Theory of Operation, Cont'd.

AM-100

We now see that the output pin of one op-amp is at about -1 volt (pin 14) and the next op-amp's output (pin 8) is at about + 1 volt.

The outputs of these amps are connected via R6 and R7 to chopper diodes D5 and D6. C5 and C6 assure good clean chopping action. R6 and R7 assure that the op-amps are not overloaded by the chopping action.

The carrier is connected thru R5 to the junction of the two chopper diodes. Since these diodes are biased at -1 volt and + 1 volt, any higher voltages will be shunted (shorted). These higher voltages are dropped across R5 leaving about a 2 volt peak to peak carrier at this junction. We won't look at the carrier as it goes thru C7 just yet, later....

An audio signal is fed into J1 or J2. If you are using a stereo source you'll want to mix the two channels together. This is done simply by plugging your left and right channels into J1 and J2 - the signals mix between R8 and R9. The audio then goes thru C9 and R10 to the first audio op-amp (pin 13). C10 is used to roll-off some of the higher audio frequencies, remove any left over stereo pilot (if audio comes from a radio) and by-pass any radio frequency interference.

The audio signal now appears at the output of the op-amp (pin 14) and a mirror image of it appears at the second op-amp's output (pin 8). Variations in the audio signal vary the bias voltages of the chopper diodes exactly the same. The peak to peak carrier voltages now present at the R5, D5, D6, junction are a result of the audio signal....we now have a modulated carrier and complete modulation "envelope".

Now back to the dc bias section. It takes about .6 to .7 volts before diode D7 will conduct. If we sample the output from pin 8, thru C12, R 17 and R16 and feed it to pin 6 of that op-amp we will have a feed-back signal. When modulation peaks at pin 8 are large enough to cause negative clipping (100% modulation) we just get a signal thru diode D7. This is a rectified signal and is + in polarity. This is smoothed out by capacitor C11. This small + voltage changes the bias condition at pin 3 and at pin 1 and therefore at pin 13 and pin 9. Instead of the initial + and - 1 volt dc bias on our chopper diodes we now have perhaps + and - 1.2 volts. In other words our carrier is now effectively 2.4 volts peak to peak instead of 2 volts P-P. The carrier power has increased to match the modulation so that over modulation does not occur.

Instantaneous peaks in audio will produce more than 100% modulation on occasion. The carrier will adjust to compensate for rapidly recurring peaks. It will readjust itself back down in power when modulation input drops. Control in this way allows up to 300 % modulation on peaks with minimum distortion. The circuit tries to keep an overall 100% modulation at all times. R16 is used to "trim" the attack of the feedback system. Unfortunately the only real way to adjust R16 is with the aid of an oscilloscope. You can adjust it pretty close however by monitoring the sound transmitted to a nearby radio. With audio fed to the transmitter adjust R16 for the loudest volume without appreciable distortion.



What we have up to this point is carrier with a complete modulation envelope. See Fig. 6 for various waveforms (as seen on an oscilloscope). Since the modulation was done with a chopper and no tuned circuits have been used up to this point we have a lot of extra frequencies. Our carrier was composed of a square wave and our chopping action simply clipped the carrier at various levels - still square waves. Square waves contain odd harmonics of the fundamental frequency and would cause much interference if we transmitted them.

Our signal is therefore "cleaned-up" by feeding it to a tuned circuit of C13 and L2. C7 is a very small capacitor value wise so our signal is loosely coupled to the tuned circuit. The junction of the bases of Q3 and Q4 has minimum loading on the tuned circuit. This is because of the inherent high input impedance of emitter follower type amplifiers. The tuned circuit responds to just the fundamental carrier frequency and eliminates the odd harmonics from it. The output is a pretty good sine wave at the fundamental frequency.

Transistors Q3 and Q4 are emitter followers. Q3 operates only when its input signal is going positive. Q4 operates only when its input signal is going negative. Therefore each transistor works only 1/2 of the time, sharing the output load. The input must be greater than about .6 volts however before the transistor will operate. If some form of bias is not used this would result in a distortion called "cross-over". The resistors R21 and R22 forward bias Q3 while R20 and R23 forward bias Q4. Each transistor is now "turned-on" slightly eliminating possible cross-over distortion.

Another characteristic of the tuned circuit is that it can transform a low level signal to a higher level signal. The peak to peak voltages appearing across L2 are greater than the peak to peak voltages appearing at the D5,D6 junction! This gives us a nice large peak to peak signal out of the final amplifiers.

Since the tuned circuit is somewhat isolated from the load (antenna) by the final amplifier, loading does not affect tuning to any great extent. In most cases it can be ignored. Loading on the final amplifier however reduces its output. This is necessary so the legal limit of 100 milliwatts output will not be exceeded. The following shows typical output peak to peak voltages for a sinewave audio input at various loads.

<u>Load impedance (ohms)</u>	<u>No Modulation</u>	<u>100% modulation</u>	<u>300% Modulation</u>
Inf. (no load)	6 volts	12 volts	30 volts
400 ohms	5 volts	10 volts	25 volts
200 ohms	4 volts	8 volts	20 volts
100 ohms	3 volts	6 volts	14 volts
50 ohms	2 volts	4 volts	10 volts
3 ohms (transformer)	.5 volts	1 volt	2.5 volts



PARTS LIST AM -100

<u>VALUE/DESCRIPTION</u>	<u>PART NUMBER</u>	<u>VALUE/DESCRIPTION</u>	<u>PART NUMBER</u>
--------------------------	--------------------	--------------------------	--------------------

Resistors: 1/4 watt.

47 K	R1
2.2 K	R2, R8, R9
100 K	R3, R24
680 ohms	R20, R21
1.0 K	R2, R5, R4
120 ohms	R6, R7
10 K	R10
22 K	R11, R12, R13, R14, R15
20 K Trimmer Pot	R16
20 K	R17
15 K	R18
15 K or 20 K (see text)	R19
39 ohms	R22, R23

Capacitors: 16 volt minimum.

.01 uF ceramic disc	C1, C5, C6
47 pF ceramic disc	C2, C3
10 pF - 50 pF trimmer	C7
220 pF ceramic disc	C4, C13a
.1 uF ceramic disc	C8
.005 uF ceramic disc	C10
10 uF electrolytic	C9, C12
4.7 uF electrolytic	C11
110-450 pFd Trimmer (ARCO # 4212)	C13

Semiconductors:

4018 B, BE or BF	IC-1
LM348 or TL074 or 84	IC-2
MPF 102	Q1
2N3904	Q2, Q3
2N3906	Q4
1N4148	D1-D7

Inductors:

100 uH molded choke	L1, L2
---------------------	--------

Misc.

Crystal (6 MHz) HC-18 type case

4 pole DIP pc mounting switch

1-Type "F" antenna connector, chassis type

2- RCA jacks, 1/4" chassis mount

1-Printed Circuit Board

6" each # 24 wire in red, blue, white

12" each # 24 wire in black, green

~~6-pvc standoffs 1/2" long (4x40 screw)~~4 ~~X~~ aluminum standoffs, 1/4" long, #4~~12-4x40, 1/4" self tapping screws~~

4 2-4x40, 3/4" machine screws

4 2-4x40 hex nuts

Cabinet 5 1/4" wide, 5 1/4" long, 3" high, (Mouser 40UB103) or larger

PARTS SOURCES

Send for catalogs:

MOUSER ELECTRONICS  
11433 WOODSIDE AVE  
SANTEE, CA 92071  
(619) 449-2222

JAMECO ELECTRONICS  
1355 SHOREWAY RD  
BELMONT, CA 94002  
(415) 592-8097

Complete kit available from: PANAXIS, PO BOX 130, PARADISE, CA 95969  
(916) 534-0417



ASSEMBLY INSTRUCTIONS

AM-100

Parts Identification (Fig. 2)

CAUTION: Use only a 25 to 40 watt pencil type soldering iron.

Diodes are shown with a black band on one end.

Resistors simply show parts number, no bands shown, small numbers shown.

Ceramic capacitors are shown as small rectangles with larger numbers.

Transistors are shown as half circles with small numbers.

Electrolytic capacitors have - and + polarity shown.

Capacitor C8 is shown as an oval shape.

Capacitor C13 is a large rectangle with screwdriver adjustment.

R16 is a square with a screwdriver adjustment.

The crystal is shown with an "X"

The DIP switch shows the numbers 1,2,3,4.

When installing your parts be careful that parts are mounted exactly as shown in the drawing (Fig. 2). Diodes must be mounted with their bands pointing in the direction shown. IC's have their indexing tabs or notch facing each other. Transistors have a flat side which must face in the direction shown. Electrolytic capacitors must have the correct polarity when mounting. Resistors, ceramic capacitors, and chokes, crystal, and trimmer capacitor may be mounted either direction.

Begin by installing all your resistors:

<u>PART</u>	<u>COLOR CODE</u>	<u>PART</u>	<u>COLOR CODE</u>
R1	Yel/Vio/Orn	R16	none 3/8" square
<del>R2</del> , 8, 9	Red/Red/Red	R17	Red/Blk/Orn
R3, R24	Brn/Blk/Yel	R18, R19	Brn/Grn/Orn
<del>R4</del> , 20, 21	Blu/Gry/Brn	*R19	Red/Blk/Orn
R5, <del>R4</del> , R2	Brn/Blk/Red	R22, 23	Orn/Whi/Blk
R6, 7	Brn/Red/Brn		
R10	Brn/Blk/Orn		Hold resistors flat against the pc board and solder leads to pc pads. Cut off excess lead length
R11, 12, 13, 14	Red/Red/Orn		

Now install the two wire jumpers. One is a bare wire located next to C12. The other is an insulated red wire running from near C11 to near the location of the red wire from the power supply. Solder and cut off excess lead length.

Now install all your diodes. Be sure the banded end faces the proper direction! Solder and cut off excess lead length.

Next install all your ceramic capacitors. Solder and cut off excess lead length.

Pick up the 4018B IC and start to install it. Note that two holes have not been drilled in the board. These pins must be bent up or cut off of the IC. These are pins 2 and 7. Match IC to the pc board before actually cutting off pins to avoid mistakes.



## Assembly Instructions, Cont'd.

AM-100

Now install the LM348 and the 4018B integrated circuits. Be sure their index notches face each other. Also install the 4 pole DIP switch at this time.

Solder leads carefully! Avoid too much heat.

Next come the electrolytic capacitors. Install with the polarity markings as shown. Solder and trim off excess.

Transistors go in next. The center lead of each will have to be tilted to one side to fit into the appropriate hole. The center lead goes in the center hole of the triangular pc layout (if there are four holes, the center holes are connected together). Each of the transistors should be held about 1/4 to 3/8" above the board while soldering its leads.

Now install the various wires. You may want to solder the ends of the Red, Blue, and nearby Black wire on the underside of the pc board. These will be going to the power supply and can be "hidden" under the boards when they're installed in the cabinet. See the construction plans for the PS-700 power supply for further details.

You may now install the molded chokes. L2 will sit on top of the red jumper wire. If desired you may move L2 closer to the edge of the board (there's a mounting hole there) to get it away from the jumper wire. One lead of L2 will still have to cross over the jumper however. Solder leads and cut off excess.

Install C13. If the holes in the pc board are not large enough make them a little larger or trim some of the metal from the edges of C13's tabs. Solder.

Last of all comes the crystal. It should be held 1/4 to 3/8" above the board when the leads are soldered. Be careful not to use too much heat!

Inspect all your solder joints. Check the pc traces to be sure you don't have any solder bridges (shorts). Be sure all parts are in the proper locations.

This completes the assembly of the AM-100 board, except...R24 should be soldered across C13 on the printed circuit side of the board, if L2 is a high Q choke. This should be done if you have one of our kits. For frequencies below 750 kHz you must solder C13a (220 pF) across C13 on the bottom side of the board.

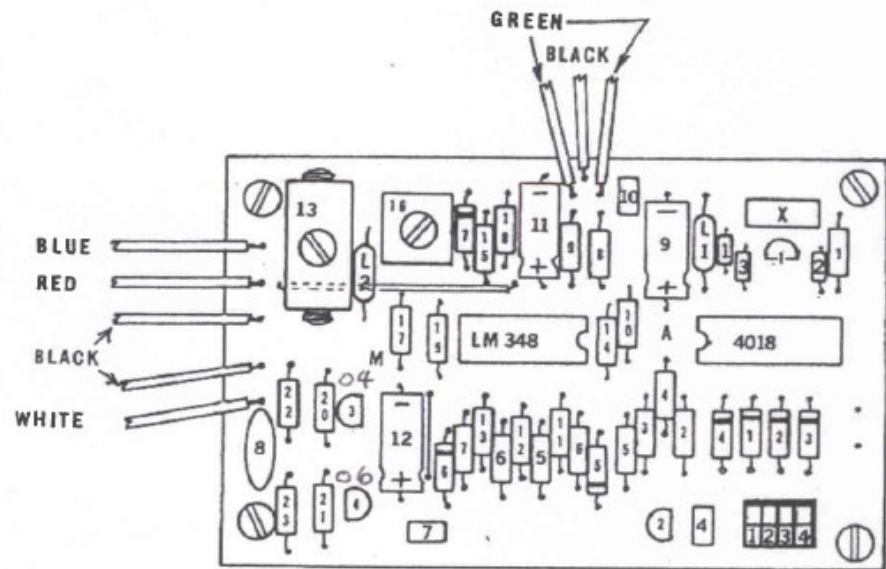

Fig. 2

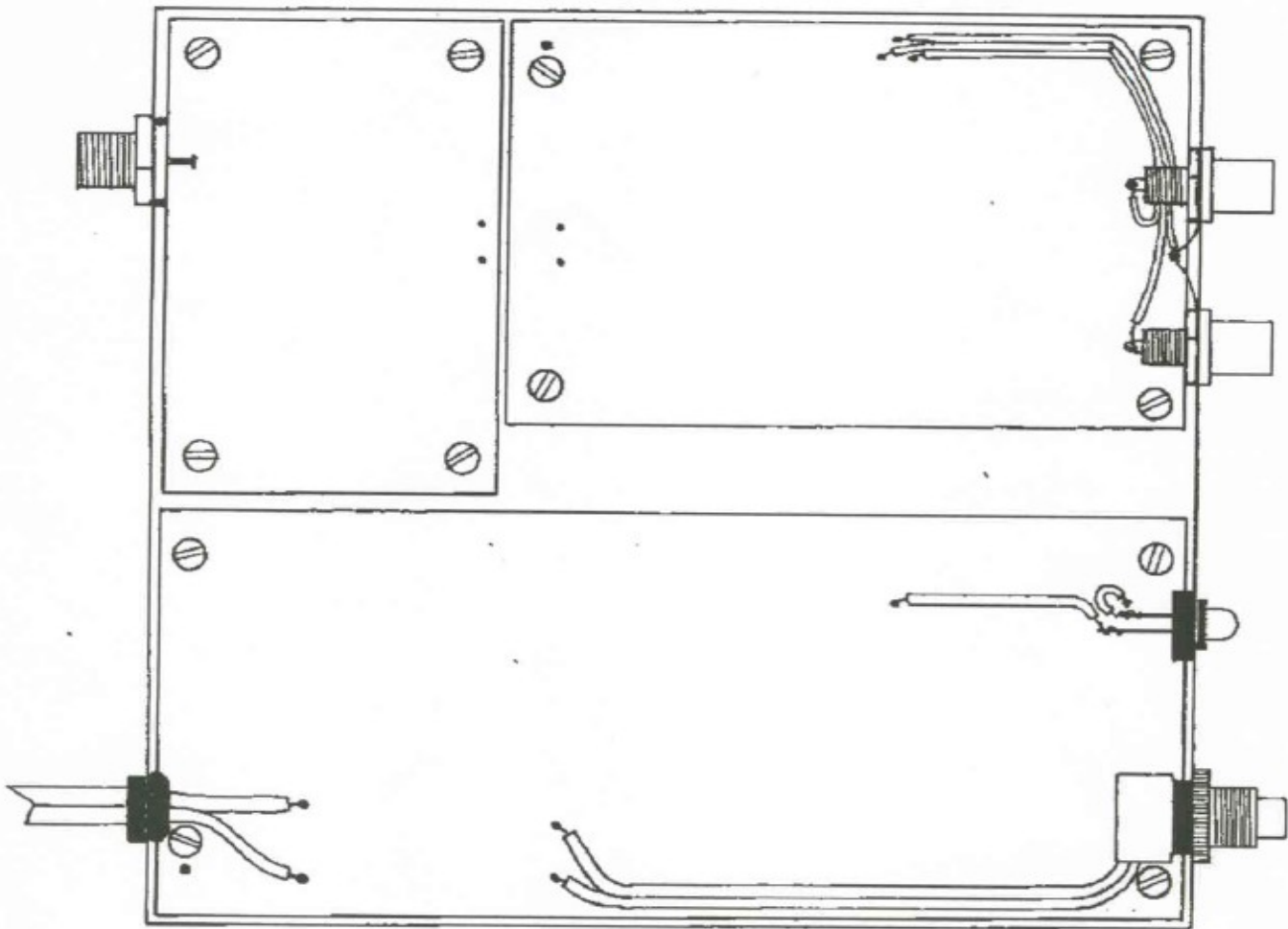

Fig. 3 Circuit Board Locations

Three different circuit boards may be mounted in the cabinet. The AM-100 transmitter board, the PS-700 power supply board, and the AMA 5000 amplifier board if used. All circuit boards to be mounted should be completed prior to this final assembly.

Using the above drawing as a template, center punch and drill the board mounting holes, in the bottom pan of the cabinet. This drawing, or a copy of it may be cut to size and laid into the bottom pan for marking of the holes. Holes should be 1/8" in diameter.

## Final Assembly Instructions, Cont'd.

AM-100

Using Fig. 4A and 4B as templates laid on the front and back panels, mark each hole location.

Switch and antenna connector holes are both 3/8" diameter.

The light (LED) and both RCA jack holes are 1/4" diameter.

The hole for the line cord strain relief is about 5/16" but may have to be trimmed with an Xacto knife a little for proper fit.

See the PS-700 power supply plans for installation of that pc board.

See the AMA-5000 amplifier plans for installation of that pc board.

Remove any rough edges from the holes with a deburring tool. If no tool is handy you can use a 1/2" drill bit. The point of the drill is gently pressed against the hole and drill rotated by hand.

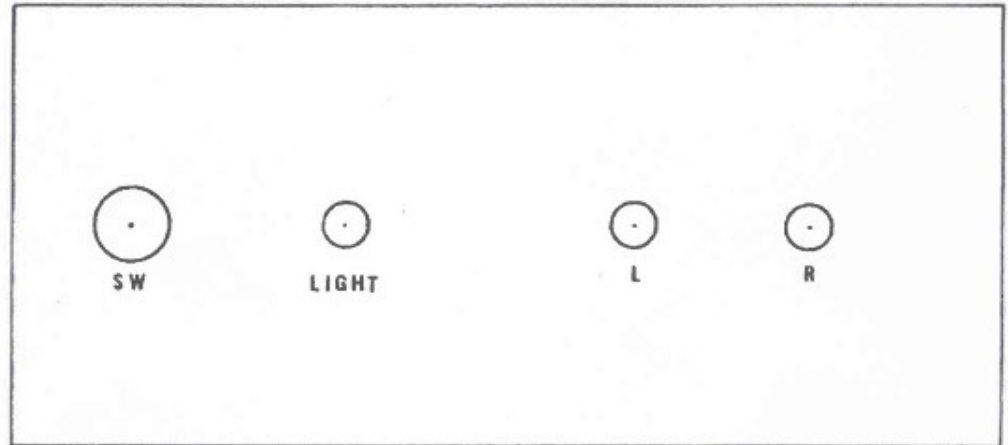

Fig. 4A Front Panel

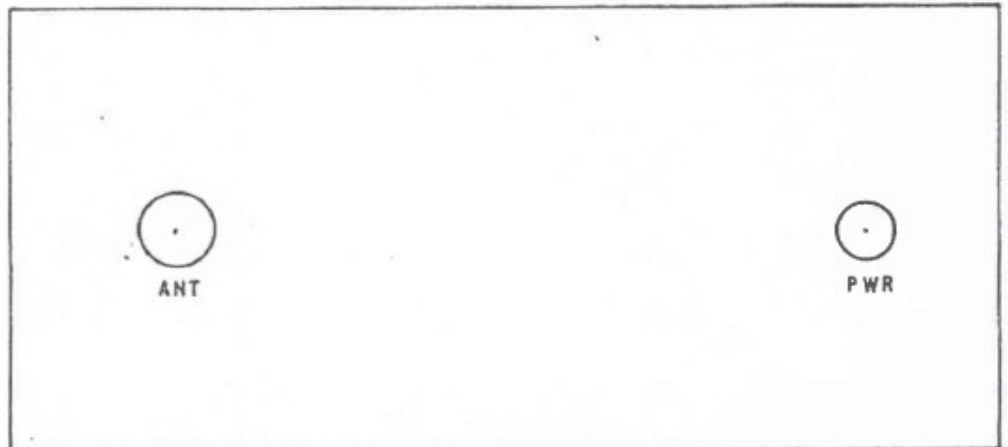

Fig. 4B Back Panel

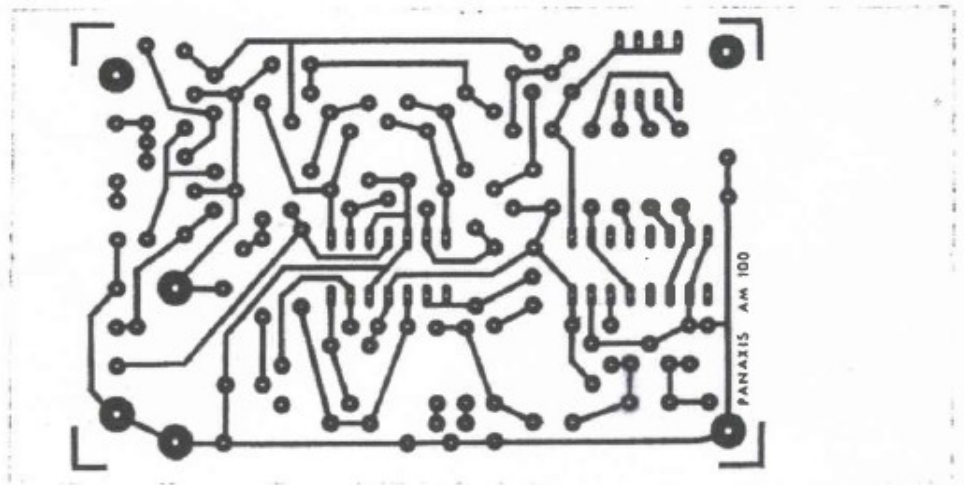

Fig. 5 AM-100 pc Artwork



Figure 3 shows a black dot next to one of the mounting screws on each of the boards. This is the location of the pc board common point where it will be connected to the cabinet bottom pan. This point is secured to the pan with a 4-40 x 3/4" machine screw with an aluminum tube spacer (1/2" long), and a 4-40 hex nut. The other 3 corners are secured with 4-40 self tapping screws and pvc spacers (1/2" long).

The boards may be left loose to begin with to facilitate soldering of the power supply leads. Keep leads short yet long enough that a board may be unfastened later and tilted up for servicing. When the red, blue, and black wires are connected you may secure the boards to the bottom pan.

Install the type "F" antenna connector and tighten its nut securely.

Install the two RCA jacks, with the ground lugs, and tighten nuts securely.

Install the power switch in the front panel and tighten its nut.

Solder the free end of each of the green wires to the two RCA jack center pins (one wire to each). Solder the free end of the associated black wire to the RCA ground lugs.

Solder the free end of the white wire to the center pin of the type "F" connector. Keep this lead as short as you can without pulling it. The associated black wire is not necessary if the AMA 5000 is not used.

If the rubber feet are not screwed onto your cabinet, screw them on at this time.

This completes the final assembly of the AM-100.

### TESTING AND OPERATION

You will need an AM radio receiver, and audio source such as a tape recorder or turntable, a 10 foot length of wire (for an antenna), and a voltmeter. The voltmeter should be of the high impedance type (30,000 ohms per volt) and be able to read ac.

Select a frequency that will not receive too much interference from other radio stations. Tune your radio to that frequency. Activate the appropriate switches on the DIP switch as discussed earlier. Connect the 10 foot length of wire to the antenna jack.

Switch on the power supply and quickly check the + and - 15 volts at the AM-100 board with your voltmeter (set on dc). You should have some wire tips showing thru the top of the pc board where the red and blue wire connect. These are your test points. If you can't get a 15 volt reading switch off the power supply and find what's wrong! If your voltages are ok, feel around to see if anything is getting hot. If anything is getting hot (warm is ok) switch off the power and find what's wrong.



Testing and Operation, Cont'd.

AM-100

If all looks ok and feels ok you can test out your signal.

Switch your voltmeter to read ac. Although not usually intended for this purpose most voltmeters will give some indication at frequencies up to 1000 KHz or so. If yours won't then you'll need to find one that does or make up a diode and capacitor rectifier to change your radio frequency output to dc - which you can read on your voltmeter.

Connect the voltmeter leads between chassis ground and the center of the antenna jack. You probably will get a higher reading if the 10 foot antenna is not connected yet.

Adjust C13 to get the maximum output voltage from the antenna jack. There should be a definite "peak" where movement either side of that point with the screw of C13 will reduce the voltage. Adjust the screw for maximum output.

Listen to your radio (put the 10 foot antenna back on). You should hear a very quiet spot (or a slight rushing or hissing sound) at the frequency you have selected. If not go back and recheck your frequency selection and tuning.

Now you may apply some audio. You may put in as much audio as you like up to the point where it sounds bad. Back off just a little from that. About .3 volts rms will give you 100% modulation. This is about -10 dB if coming from a 600 ohm source. You may increase this up to 1 volt rms (about 0 dB) which is equivalent to 300% modulation:

R16 may be adjusted by ear. With about .3 volts rms audio adjust R16 for maximum loudness without it sounding bad. This assures 100% modulation without negative peak clipping.

Recheck the tuning of C13. If all looks good, nothing hot or smoking, sounds good, then put on your cabinet cover.....you're done!

#### OPTIONAL MODIFICATIONS

- (a) If the carrier control feature is not desired it can be defeated by changing R19 from a 15 K resistor to a 20K resistor. This increases the bias level of the diode choppers thereby increasing the average carrier power. The carrier level will then be about what it would be when modulation is at 300 % normally, except you will not be able to exceed 100 % now. This gives you a fixed carrier level rather than one that varies with average modulation.
- (b) If you experience a little fuzziness in modulation, or a drop in modulation as you peak-up the output (above about 1000 kHz) then change R24 to a 47K resistor. You may also solder a tiny 47pF ceramic capacitor across Q2 (emitter-collector shunt).
- (c) Instead of (b) above adjust C7 to reduce the signal level to the resonant circuit of L2, C13. Readjust C13 for peak output again. Alternate between C7 and C13 adjustments while modulating fully. Object is to get as much output as possible with minimum of distortion. If testing with a "scope you're wanting to see Fig. 6D.

(b) A modulation meter can be added. A standard VU meter may be connected between point "M" and ground. There are two additional ground pads near the front edge of the pc board, use one of these for your ground wire. The VU meter may have to be calibrated to meet your exact needs. This is done simply by placing a resistor (variable if you wish) between point "M" and the meter.

(c) You can also monitor the average carrier level. The amount it changes is called "carrier-shift". Simply connect a VU meter between point "A" and ground. Use the other ground pad at the edge of the pc board for your ground wire. You can use 2 VU meters, one for modulation and one for carrier-shift, or you can use a switch and switch between the two points and use just one meter.



Fig. 6 A Quiescent carrier level



Fig. 6 B Effective Carrier at 300%



Fig. 6 C 100 % modulation (tone)

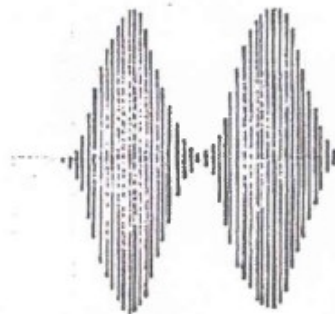

Fig. 6 D 300% modulation (tone)

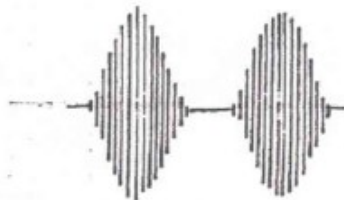

Fig. 6 E 150 % modulation (tone)  
(without carrier-control)

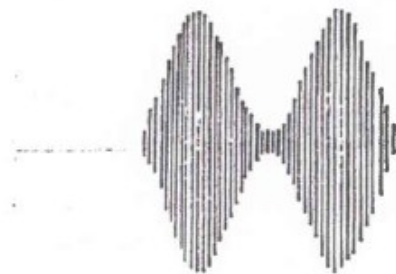

Fig. 6 F 150 % modulation (tone)  
(with carrier - control)

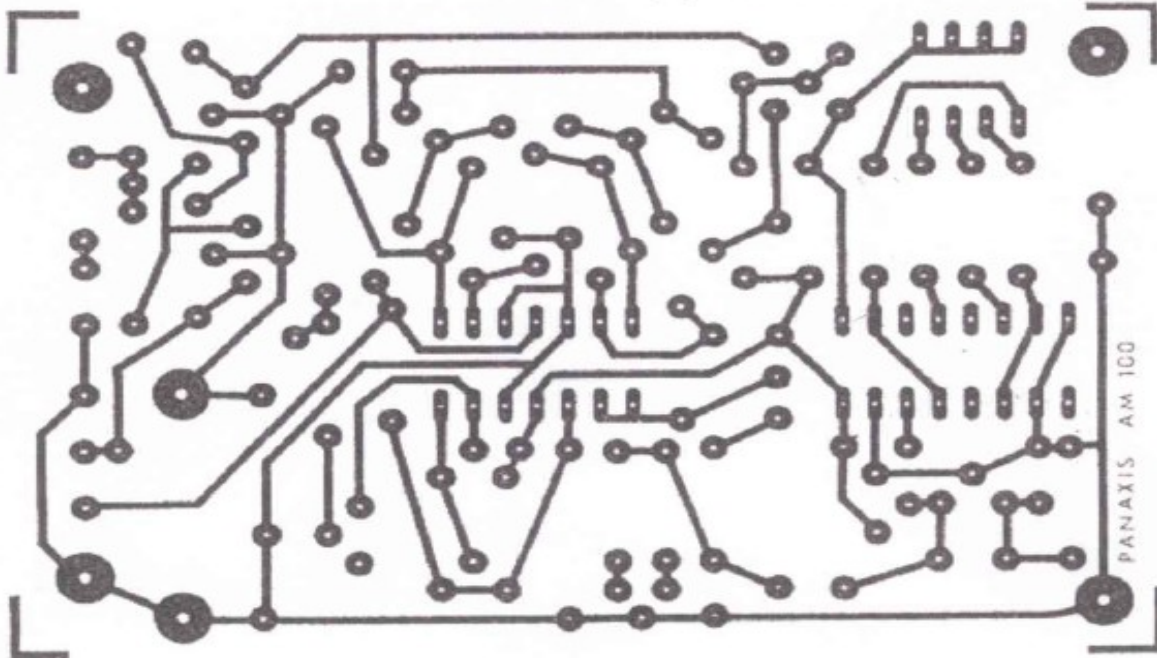

Fig. 5 AM-100 pc Artwork

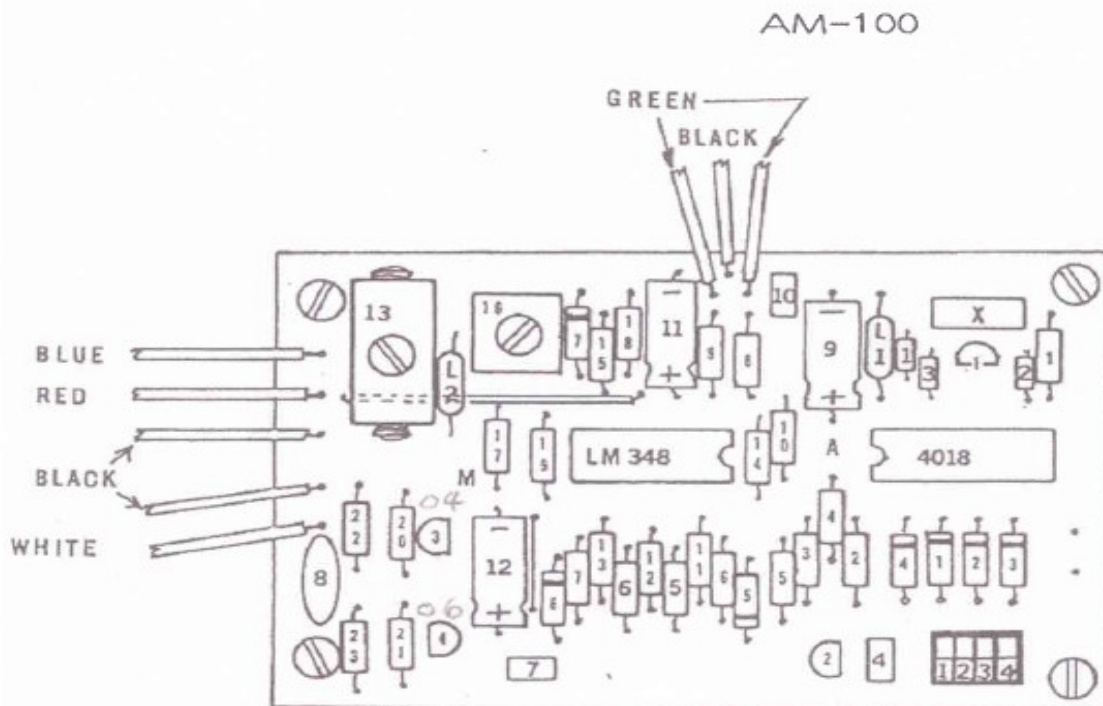

Fig. 2



PICTURE

