

Cat. No. 20-229

## **OWNER'S MANUAL**

Please read before using this equipment.

# **DX-399**

## **Shortwave Receiver**



**RadioShack®**

# FEATURES

---

---

Your RadioShack DX-399 Shortwave Receiver brings the voices of the world to you. You can hear news broadcasts and other programs from sources around the world, such as Radio Cairo, Israel Radio, British Broadcasting Company, and Radio Moscow. You can get emergency information firsthand by listening to amateur radio broadcasts. In the longwave (LW) band, you sometimes hear hurricane reports, ship-to-shore calls, and other marine and aeronautical services. You can tune to local broadcasts in the FM and medium-wave (MW) bands. (In the United States, we commonly call the MW band the AM band.)

Your receiver's other features include:

**Continuous SW Coverage** (from 1.711 MHz to 29.999 MHz) — allows you to scan the entire SW band.

**Digital Synthesized Receiver** — ensures accurate, drift-free tuning.

**Fast-Response Display** — lets you quickly and easily view the time, band and frequency, and other indicators.

**Dual Time Clock** — you can set a primary clock to your local time and a secondary clock to another time zone, so you can quickly check the time in another part of the world.

**Auto Tuning System (ATS)** — automatically tunes to the stations with the strongest signals and stores them in memory locations according to each station's signal strength.

**Scan Tuning** — lets you quickly find stations.

**Memory Tuning** — you can store up to 54 frequencies in memory so you can quickly select your favorite stations.

© 1999 Tandy Corporation.  
All Rights Reserved.

RadioShack is a registered trademark used by Tandy Corporation.

---

---

**Direct-Access Tuning** — you can use the keypad to manually enter a frequency.

**Control Lock** — prevents you from accidentally changing a setting.

**Timer Alarms** — let you set the buzzer to sound or the receiver to turn on to wake you up at a time you set.

**Sleep Timer** — lets you set the receiver to turn off after a preset length of time so you can fall asleep as you listen to it.

**MW 9 kHz/10 kHz Step Setting** — lets you choose the correct AM tuning increment for whichever part of the world you are in.

**AM External Antenna Jack** — lets you connect an external antenna (not supplied) to improve SW/MW/LW reception.

**Memo Pad** — lets you record helpful information such as the memory location numbers of your favorite stations.

**Stereo Headphones Jack** — you can listen to broadcasts with optional stereo headphones.

We recommend you record the DX-399's serial number here. The number is inside the DX-399's battery compartment.

Serial Number \_\_\_\_\_

# CONTENTS

---

---

<b>A Quick Look at the DX-399 .....</b>	<b>6</b>
<b>Preparation .....</b>	<b>9</b>
About this Manual .....	9
Connecting to Power .....	9
Using Standard AC Power .....	10
Using DC Power .....	11
Installing Batteries .....	12
Connecting Headphones .....	13
Using the FM Mono/Stereo Switch .....	14
Listening Safely .....	14
Traffic Safety .....	14
Using the Clock .....	15
Setting the Local Time .....	15
Setting the Dual Time .....	15
Setting Zero Seconds .....	16
Connecting an External Antenna .....	16
Setting the MW (AM) Tuning Increment .....	17
Using the Folding Stand .....	18
Using the Memo Label .....	18
<b>Operation .....</b>	<b>19</b>
Turning the Receiver On and Off .....	19
Adjusting the Antenna .....	19
Tuning .....	19
Selecting the Band .....	19
Automatic Tuning System (ATS) .....	20
Direct-Access Tuning .....	21
Manual Tuning .....	22
Scan Tuning the FM/MW/LW Bands .....	22
Listening to the SW Meter Band .....	22
Fine Tuning .....	23
Using the AM SENS DX/LOCAL Switch .....	23

---

---

Memory Tuning .....	23
Storing Frequencies in Memory .....	23
Storing/Arranging SW Frequencies in Memory .....	24
Recalling a Station in Memory .....	25
Scanning Stations in Memory .....	26
Deleting a Station from Memory .....	26
<b>Special Features .....</b>	<b>27</b>
Using the Alarm .....	27
Setting the Radio Alarm Time .....	27
Setting the HWS Alarm Time .....	28
Silencing the Alarm .....	29
Turning the Alarm On or Off .....	29
Using the Sleep Timer .....	30
Using the Countdown Timer .....	30
Cancelling the Countdown Timer .....	31
Using the Display Backlight .....	31
Locking the Controls .....	31
<b>Listening Hints .....</b>	<b>32</b>
Reference Sources .....	32
Frequency Conversion .....	32
Band Allocations .....	34
Time Standard Frequencies .....	35
Longwave Band .....	35
Listening Guide .....	36
Birdies .....	42
Amateur Shortwave Bands in the USA .....	43
Amateur Shortwave Bands (in MHz) .....	43
<b>Troubleshooting .....</b>	<b>44</b>
Resetting the Radio .....	45
<b>Care and Maintenance .....</b>	<b>46</b>
<b>The FCC Wants You to Know .....</b>	<b>47</b>
<b>Specifications .....</b>	<b>48</b>

# A QUICK LOOK AT THE DX-399

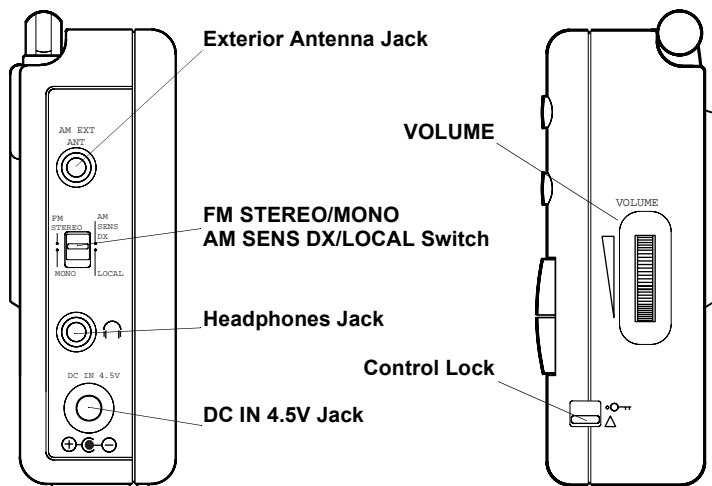
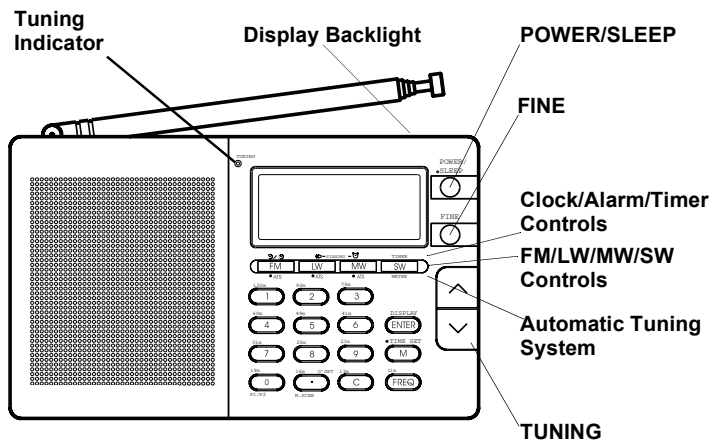



---

---

 — lights the display for about 20 seconds.

**POWER/SLEEP** — turns the DX-399 and the sleep timer on and off.

**FINE** — reduces the tuning step interval.

**FM/1**  **/2**  **/ATS** — selects the FM band; toggles between two clock settings; Automatic Tuning System tunes to the strongest frequencies in the FM band.

**LW/**  **ATS** — selects the LW band; displays the alarm time; Automatic Tuning System tunes to the strongest frequencies in the LW band.

**MW/**  **HWS** **ATS** — selects the MW band (AM broadcasts) ; displays the Humane Waking System time; Automatic Tuning System tunes to the strongest frequencies in the MW band.

**SW/METER** — selects the SW band; selects the countdown timer function; allows you to enter wavelength.

**TUNING**   **/MANUAL/AUTO** — tunes up or down.

**ENTER/DISPLAY** — stores and displays settings.

**TIME SET/M** (Memory) — sets the time and enters a frequency in memory.

**FREQ/11m** — displays the current frequency and selects 11m wavelength.

**C/13m** — clears an entry and selects 13m wavelength.

**.16m/0"SET/M.SCAN** — enters a decimal; selects 16m wavelength; sets zero second; scans through stations in the memory bank.

---

---

**0/19m/P1/P2** — enters 0; selects 19m wavelength; selects memory bank location.

• — locks the DX-399's controls so you do not accidentally change any settings.

**FM STEREO/MONO** — toggles between stereo and monaural reception.

**AM SENS DX/LOCAL** — reduces interference between stations.



# PREPARATION

---

---

## ABOUT THIS MANUAL

This Owner's Manual describes how to set up and use the DX-399, and also provides tips and information about listening to a receiver.

Some of the DX-399's controls perform multiple functions (such as **./16m/0" SET/M.SCAN**). The first time the Owner's Manual mentions controls with multiple functions, all functions will be included. Each time thereafter, the control will be named by the function being described.

For example, in the "Setting Zero Seconds" section, the Owner's Manual lists the control as **./16m/0" SET/M.SCAN**. In the "Using the FM Mono/Stereo Switch" section (later in the manual), the control is listed as **M.SCAN**.

## CONNECTING TO POWER

You can power the receiver from standard AC power, your vehicle's battery (with an optional DC adapter), or internal batteries (not supplied).

The supplied universal adapter uses the most popular European AC adapter plug and automatically converts voltage from the local current to 4.5V DC.

**Note:** Connecting an adapter automatically disconnects internal batteries.

---

---

## Using Standard AC Power

You can power the receiver from standard AC power using the supplied universal adapter.

### Cautions:



You must use a Class 2 power source that supplies 4.5 Volts DC and delivers at least 200 mA. Its center tip must be set to negative and its plug must fit the DX-399's **DC IN 4.5V** jack. The supplied adapter meets these specifications. Using an adapter that does not meet these specifications could damage the DX-399 or the adapter.

- Always unplug the adapter from the AC outlet first, then unplug it from the receiver.

Insert the adapter's barrel plug into the receiver's **DC IN 4.5V** jack, then plug the adapter into a standard AC outlet.

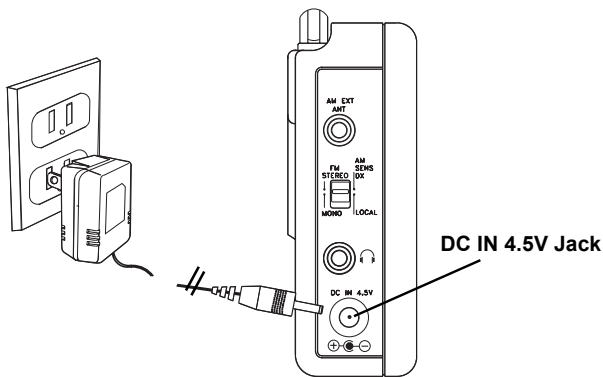

---

---

## Using DC Power

You can power the receiver from your vehicle's battery with an optional DC adapter.

### Cautions:



You must use a power source that supplies 4.5 Volts DC and delivers at least 200 mA. Its center tip must be set to negative and its plug must fit the DX-399's **DC IN 4.5V** jack. The recommended adapter meets these specifications. Using an adapter that does not meet these specifications could damage the DX-399 or the adapter.

- Always plug the adapter into the receiver before you plug it into your vehicle's cigarette-lighter socket, and unplug the adapter from the vehicle's cigarette-lighter socket before you unplug it from the receiver.

Follow these steps to use DC power.

1. Set the adapter's voltage switch to 4.5V.
2. Insert the adapter's barrel plug into the receiver's **DC IN 4.5V** jack.
3. Insert the adapter's large plug into the vehicle's cigarette-lighter socket.

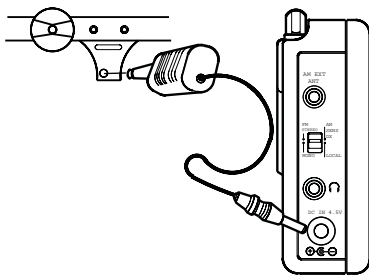

---

---

## Installing Batteries

You can power the receiver with three AA batteries (not supplied). For the best performance and longest life, we recommend RadioShack alkaline batteries.

### Cautions:

- Use only fresh batteries of the required size and recommended type.
- Do not mix old and new batteries, different types of batteries (standard, alkaline, or rechargeable), or rechargeable batteries of different capacities.

Follow these steps to install batteries.

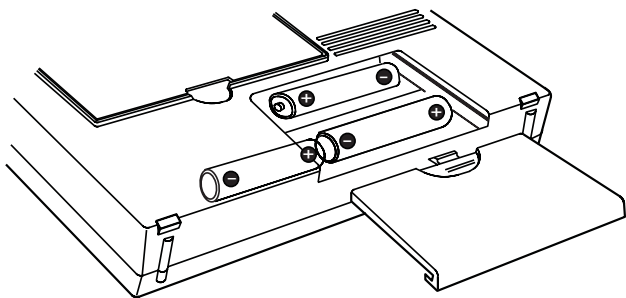



1. Slide the battery compartment cover in the direction of the arrow to remove it.
2. Place the batteries in the compartment as indicated by the polarity symbols (+ and -) marked on the back of the receiver.
3. Replace the cover.

---

---

## Notes:



- When you press **POWER/SLEEP** to turn off the receiver, the battery power indicator appears on the display for about 7 seconds. Fresh batteries show a power level of 9. If the indicator shows a power level of 3 or below, battery low  flashes. When **B** and battery low  flash, replace all three batteries.
- To avoid losing the current time and memory settings, be sure to replace the batteries within 3 minutes of removing the old batteries.

**Warning:** Dispose of old batteries promptly and properly. Do not burn or bury them.

**Caution:** If you do not plan to use the receiver with batteries for a month or longer, remove the batteries. Batteries can leak chemicals that can destroy electronic parts.

## CONNECTING HEADPHONES

For private listening and for stereo sound during FM stereo broadcasts, you can connect optional stereo headphones with a  $\frac{1}{8}$ -inch (3.5-mm) plug. Your local RadioShack store sells a wide selection of stereo headphones.

Insert the headphones' plug into the receiver's  jack. This disconnects the receiver's internal speaker. Set **FM STEREO/MONO** to **FM STEREO**. When you tune to a stereo broadcast, **ST** appears. For the best reception, press **FINE** and then **TUNING**   until **ST** remains steady.

---

---

## Using the FM Mono/Stereo Switch

To receive FM stations in stereo, connect stereo headphones (available at your local RadioShack store) to the  jack and slide **FM STEREO/MONO** to **STEREO**.

To improve reception for weak FM stereo stations, set **FM STEREO/MONO** to **MONO**. The signal becomes monaural, but the sound might improve.

## Listening Safely

To protect your hearing, follow these guidelines when you use headphones.

- Set the volume to the lowest setting before you begin listening. After you begin listening, adjust the volume to a comfortable level.
- Do not listen at extremely high volume levels. Extended high-volume listening can lead to permanent hearing loss.
- Once you set the volume, do not increase it. Over time, your ears adapt to the volume level, so a volume level that does not cause discomfort might still damage your hearing.

## Traffic Safety



- Do not use headphones with your receiver when operating a motor vehicle or riding a bicycle in or near traffic. Doing so can create a traffic hazard and could be illegal in some areas.
- If you use headphones with your receiver while riding a bicycle, be very careful. Do not listen to a continuous broadcast. Even though some earphones/headphones let you hear some outside sounds when listening at normal volume levels, they still can present a traffic hazard.

---



---

## USING THE CLOCK

Your receiver has two clocks. We recommend you set the primary clock for local time and the secondary clock for UTC (Coordinated Universal Time, formerly called Greenwich Mean time), because most shortwave stations announce broadcast times in UTC 24-hour format.

To switch back and forth between times, press **1** /2 , then **ENTER**.

### Setting the Local Time







1. Turn off the receiver so  appears.
2. Hold **•TIME SET/M** for about 3 seconds.  **SET** flashes for about 10 seconds.
3. While  **SET** is flashing, enter the correct time using the number keypad.

#### Notes:



- Do not precede single-digit hours with a 0. For example, enter 930 for 9:30AM.
  - If you make a mistake, press **C** to erase the last digit, then enter the correct digit.
4. Press **DISPLAY**. The time you set appears.

### Setting the Dual Time

You can program the receiver to store a second time as your home time (for example) if you are travelling, or as Coordinated Universal Time (UTC), or as the local time wherever you are.

- 
- 
1. Press **1** /2  so **2**  flashes for about 3 seconds.
  2. While  is flashing, press **ENTER**. **2**  stops flashing.
  3. Hold down **•TIME SET** for about 3 seconds.  **SET** flashes for about 10 seconds.
  4. While  **SET** is flashing, enter the correct time using the number keypad.
  5. Press **ENTER** to store the setting. The display shows the dual time you set.

## Setting Zero Seconds

To set the seconds to zero, hold down **•TIME SET** until  **SET** flashes, then press **0" SET./16m/M.SCAN** when  appears.  **SET-00** flashes for about 60 seconds. Press **ENTER** at the desired time for a more precise clock setting.

## CONNECTING AN EXTERNAL ANTENNA

To improve SW/MW/LW reception, you can connect an external antenna (available at your local RadioShack store) directly to the **AM EXT ANT** jack. Follow the antenna's supplied instructions to connect the receiver to the antenna.

**Note:** Connecting an external antenna disables the built-in ferrite core antenna.



---

---

## SETTING THE MW (AM) TUNING INCREMENT

In the United States, the Federal Communications Commission (FCC) assigns frequencies for stations in the MW band in 10-kilohertz increments. (In the United States, we commonly call the MW band the AM band.) In Europe and some other parts of the world, MW frequencies are assigned in 9-kilohertz increments.

The MW step 9k/10k switch is located inside the battery compartment. To set the tuning increment, follow these steps.

1. Slide the battery compartment cover in the direction of the arrow to remove it and remove the batteries, if necessary.
2. *If you are in the United States or anywhere else in the Western Hemisphere, slide the switch to 10k.*  
*If you are in any other part of the world, slide the switch to 9k.*
3. Replace the batteries and battery compartment cover.

---

---

## USING THE FOLDING STAND

You can position the receiver more securely, and possibly improve the reception, by resting the receiver on its stand. Lift the latch on the back of the receiver to open the stand and position the receiver on a flat surface, as shown. A list of frequency ranges for the FM/LW/MW/SW bands are printed on the stand for your reference.

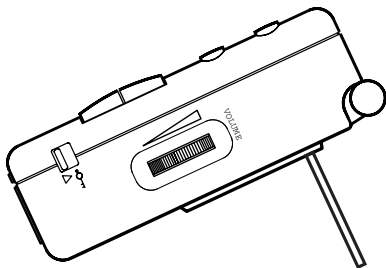

## USING THE MEMO LABEL

Use the memo label under the receiver's stand to record helpful information, such as the memory location numbers of your favorite stations.

# OPERATION

---

---

## TURNING THE RECEIVER ON AND OFF

To turn on the receiver, press **POWER**. The band and frequency appear.

To turn off the receiver, press **POWER** again. The battery indicator appears, showing the battery condition from 9 (fully charged batteries) to 1 (low batteries).

## ADJUSTING THE ANTENNA

For the best reception, adjust the telescoping antenna based on the band you are listening to.

**FM** — Pull up the antenna's base about halfway then fully extend the antenna and rotate it for the best reception.

**SW** — Pull up the antenna's base then fully extend the antenna and point it straight up.

**LW** and **MW** (AM) — Rotate the receiver. The receiver uses a built-in antenna for these bands.

## TUNING

### Selecting the Band

Press **FM/•ATS**, **LW/•ATS**, **MW/•ATS** (for AM), or **SW/METER** to select the desired band. To select a smaller band within the SW band, press **SW/METER** again so **m** flashes, then enter the desired meter band by pressing its labeled meter button on the keypad.

---

---

The following chart shows the tuning interval for each band.

<b>Band</b>	<b>Tuning Increment</b>
FM	0.1 MHz
LW	9 kHz
MW	9 or 10 kHz
SW	0.005 MHz

## Automatic Tuning System (ATS)

The DX-399 features an Automatic Tuning System which scans all the available stations and stores them in sequence according to their signal strength for quick tuning. The strongest signal station will be tuned and stored in the first available memory location, and the second strongest signal will be tuned and stored next, and so on until all nine memory location numbers are occupied.

To set your scanner to tune automatically, hold down **•ATS** for the desired band (**FM**, **LW**, or **MW**) for about 3 seconds. The DX-399 beeps once while **TUNING** and **ATS** flash. The numbers 1–9 appear one at a time indicating that the receiver is scanning. When automatic tuning and memory preset is complete, the DX-399 beeps.

### Notes:

- The DX-399 automatically tunes and stores up to 18 FM stations (nine in each of two memory banks — **P1** and **P2**), 9 MW, and 9 LW stations.
- ATS does not work in the SW band.
- Only , **POWER** and **•O-TR** controls can function during an ATS.

- 
- 
- ATS clears all of the stations previously set.
  - To stop ATS, press **POWER**.

To tune to a stored ATS station, just press the number key of the stored station.

## Direct-Access Tuning

To tune to a specific frequency, follow these steps.

1. Press **FREQ/11m**. The frequency display disappears.
2. Press the corresponding number buttons (and decimal button, as necessary) to enter the frequency.

You do not need to select a band. When you key in the correct frequency, the receiver automatically selects the appropriate band. For example, to enter FM 100.70 MHz, just key in **100.70**.

### Notes:

- If you wait more than 30 seconds to press a button, the previous frequency returns to the display and you must begin again from Step 1.
  - If you enter an invalid frequency, **E** appears.
  - If you make a mistake, repeatedly press **C** (cancel), then enter the correct digit(s).
3. Press **ENTER**. The selected frequency appears.

---

---

## Manual Tuning

You can select a station even if you do not know its frequency.

Select the desired band, then repeatedly press **TUNING**  $\wedge$  or  $\vee$  until you hear the broadcast from the desired station.

## Scan Tuning the FM/MW/LW Bands

To tune up or down to the next active frequency in the selected band, hold down **TUNING**  $\wedge$  or  $\vee$  for at least 1 second. The receiver scans up or down the selected band and tunes to the first frequency it finds with a strong signal.

**Note:** When scanning, the receiver only searches for frequencies with strong signals. To search for stations with weaker signals, repeatedly press **TUNING**  $\wedge$  or  $\vee$  to tune to the station manually.

## Listening to the SW Meter Band

1. To select a SW band, press **SW/METER** so a SW frequency appears.
2. Press **SW** again. SW frequency disappears and **m** flashes.
3. Press the desired SW band button (**11m–120m**). The selected band appears and remains as long as there is tuning activity within that band.
4. Press **FINE** then **TUNING**  $\wedge$  or  $\vee$  to fine tune to the desired frequency according to the SHORT WAVE METER BAND frequency ranges listed on the folding stand. **TUNING**  $\wedge$  or  $\vee$  tunes in 1 kHz increments.

---

---

## FINE TUNING

To fine tune for the best reception, press **FINE**. **FINE** appears.

Press **TUNING**  $\wedge$  or  $\vee$  to tune by 1 kHz/step for the MW/LW bands and 0.05 MHz/step for the FM band.

### Using the AM SENS DX/LOCAL Switch

To reduce interference from adjacent stations in the SW, MW, or LW bands, set **AM SENS DX/LOCAL** to **AM SENS LOCAL**. If there is no interference, set this switch to **DX**.

## MEMORY TUNING

For easy selection, you can store the frequencies of your favorite stations in memory. You can store up to 54 stations—up to 18 SW and 18 FM frequencies each (nine stations per band in two memory banks) and up to 9 frequencies each in LW and MW.

### Storing Frequencies in Memory

1. Select the desired band and use direct-access or manual tuning to tune to the frequency you want to store.
2. Press **M** (memory). **M** and the available memory location number flash.
3. While **M** and the available memory location number are flashing, repeatedly press **P1/P2** to select the desired memory bank (1 or 2) to store a station. The next available memory location number flashes.

**Note:** If you wait more than 15 seconds to press **P1/P2**, the receiver returns to the previous display and you must begin again from Step 2.

- 
- 
4. Press **ENTER** or the desired memory location number to store the frequency to the flashing memory location number.

**Note:** If memory is full, no memory location number flashes and **FULL** appears if you press any button. You cannot store a new frequency, but you can replace the existing frequency with the new one by holding down the desired memory location number button for two seconds while **FULL** appears (be sure you also set the correct memory bank location).

## Storing/Arranging SW Frequencies in Memory

1. Tune to the desired SW station you want to store.
2. Press **M. M** and the next available memory location number flash for 15 seconds.
3. While **M** and the available memory location number flash, press **P1/P2** to select the desired memory bank where you want to store SW frequencies.
4. While **M** and the available memory location number continue to flash, press **ENTER** or the desired memory location number.
5. Press **TUNING**  $\wedge$  or  $\vee$ . The receiver scans to the next strongest frequency. To store this frequency in memory, repeat Steps 2–4.

**Note:** If memory is full, no memory location number flashes and **FULL** appears if you press any button. You cannot store a new frequency, but you can replace the existing frequency with the new one by holding down the desired memory location number button for two seconds while **FULL** appears (be sure you also set the correct memory bank location).



---

---

You can also rearrange the memory order of the stations you have already stored.

1. Recall the station you want to move.
2. Press **M. M** and the memory location number flash.
3. Use the number keys to enter the desired memory location number. The receiver beeps signaling that the new memory sequence is stored.

## Recalling a Station in Memory

To recall an LW or MW frequency stored in memory, press **LW** or **MW**, then use the number keys to enter the desired memory location.

To recall an SW or FM frequency stored in memory, press **SW** or **FM**, and repeatedly press **P1/P2** until the desired memory bank number appears, then use the number keys to enter the desired memory location.

---

---

## Scanning Stations in Memory

You can set the DX-399 to scan through the stations stored in memory. Press **M.SCAN** when the display is set to show frequency information. The DX-399 tunes to the next memory station number, plays that station for a few seconds, and then moves on. To stop memory scan, press any key (except **POWER**).

## Deleting a Station from Memory

1. Select **P1/P2** (the memory bank where the memory selection is stored), then press the number of the desired station to select it.
2. Press **M. M** and the memory location number flash.
3. Press **C** (cancel) to delete the station from memory.

# SPECIAL FEATURES



---

---

## USING THE ALARM

The DX-399's **TIMER** alarm lets you set two alarm times, so you can wake to either the radio or a buzzer.

### Setting the Radio Alarm Time

1. Tune to the radio station you wish to wake up to.
2. Display the time by pressing **POWER** to turn off the receiver, or by pressing **DISPLAY/ENTER**.
3. Press  **STANDBY/LW**.  and **STANDBY** flash for about 12 seconds, and the last set alarm time (or **0 : 00**) appears.
4. Use the number keys to enter the desired alarm time (in 24-hour time format). For example, to enter 1:30 PM, press **1330**.

#### Notes:

- Do not precede single-digit hours with a 0. For example, enter **930** for 9:30AM.
  - If you enter the wrong number, repeatedly press **C** to correct it.
  - If the time you enter does not exist (such as 25:30), **E** appears for about 2 seconds, and the original time reappears.
5. Press **ENTER**. The set time appears, and  **STANDBY** stops flashing, indicating the radio alarm has been set. About 2 seconds later, the receiver returns to the current time.
  6. To check the alarm time, press **STANDBY**. The alarm time displays for about 12 seconds, then disappears. If you press **STANDBY** again or **ENTER**, the display returns to the time mode.

---

---



To cancel the alarm time, press **POWER** or **DISPLAY** so the current time appears. Then press **STANDBY**. While **STANDBY** flashes, press **C**.  and **STANDBY** disappear.

## Setting the HWS Alarm Time

The DX-399 features a Humane Waking System (HWS), so you are not startled awake. At the set alarm time when the alarm buzzer sounds, the volume increases every 15 seconds for 1 minute, then goes silent for 1 minute, repeating the cycle for 30 minutes.

**Note:** If the radio is on when the DX-399 reaches the alarm time, the radio turns off, and the DX-399 begins to buzz.

To set the DX-399's HWS alarm time, follow these steps.

1. Display the time by pressing **POWER** to turn off the receiver, or by pressing **DISPLAY/ENTER**.
2. Press  **MW. STANDBY** and  flash for about 12 seconds, and the last alarm time appears (0:00 appears, if this is the first time you set an alarm).
3. Use the number keys to enter the desired alarm time. For example, to enter 1:30 PM, press **1330**.



### Notes:



- Do not precede single-digit hours with a 0. For example, enter **930** for 9:30AM.
- If you enter the wrong number, repeatedly press **C** to correct it.
- If the time you enter does not exist (such as 25:30), **E** appears for about 2 seconds, and the original time reappears.

- 
- 
4. Press **ENTER**. The set time (13:30, for example) appears, and **STANDBY**  stops flashing, indicating the radio alarm has been set. About 2 seconds later, the receiver returns to the current time.
  5. To check the alarm time, press **STANDBY**. The alarm time displays for about 12 seconds, then disappears. If you press **STANDBY** again or **ENTER**, the display returns to time mode.



To cancel the alarm time, press **POWER** or **DISPLAY** so the current time appears, then press **STANDBY**. While **STANDBY** flashes, press **C**.  and **STANDBY** disappear.



## Silencing the Alarm

At the set alarm time, the radio turns on or the buzzer sounds and  or  flash on the display. The buzzer then stops after 30 minutes, or the receiver automatically turns off after 60 minutes.

To silence the alarm sooner, press **POWER**. The flashing  or  disappears and the alarm sounds again the next day at the set time.

## Turning the Alarm On or Off

To turn off the alarm so it does not sound, press  **STANDBY** or **STANDBY HWS**  (according to which alarm you set — the radio or the buzzer). While  **STANDBY** or **STANDBY HWS** flashes, press **C**.



To set the alarm to sound again, press  **STANDBY** or **STANDBY HWS**  and then **ENTER**.

---

---

## USING THE SLEEP TIMER

You can set the sleep timer to have the receiver turn off in one hour, 45, 30, or 15 minutes, so you can fall asleep to music.

1. Tune to the desired station.
2. Hold down **POWER/SLEEP** until  flashes.
3. While you hold down **SLEEP**, the sleep timer flashes **60**, **45**, **30**, then **15** (minutes), and repeats. Release **SLEEP** when the desired time appears.
4. The receiver turns on and  remains on the display.

At the preset auto power-off time, the receiver turns off. To turn off the receiver sooner, press **POWER**.

## USING THE COUNTDOWN TIMER

1. Press **POWER** to turn off the receiver, then press **TIMER/SW**. **TIMER** flashes for 12 seconds.

**Note:** The display shows **-:-** the first time you set the countdown timer. If you press **ENTER** by mistake while the display shows **-:-**, **E** appears. Turn on the receiver and repeat Step 1.

2. Use the number keys to enter the desired countdown time (up to 23 hours and 59 minutes) and press **ENTER**. **TIMER** stops flashing, then the receiver returns to the current time within about 2 seconds.

To check the time remaining in the countdown at any time, press **TIMER**. To continue the countdown, press **TIMER** again.

To reset the countdown, press **ENTER**. The timer begins the countdown again from the set time.

---



---

When the countdown reaches the end, the receiver's alarm sounds for about one minute. If the radio is on at the time the countdown ends, the radio turns off, and the alarm sounds. To turn the alarm off sooner, press **POWER**.





## Cancelling the Countdown Timer

To cancel the countdown timer, press **POWER** or **DISPLAY** so the current time appears, then press **TIMER**. The display shows the remaining countdown time and **TIMER** flashes. Press **C**. **TIMER** disappears, and the current time appears.

## USING THE DISPLAY BACKLIGHT

To turn on the backlight for about 12 seconds, press . To turn it off sooner, press  again.

## LOCKING THE CONTROLS

You can lock the controls to prevent accidentally turning the receiver on or off, changing the band or frequency, or selecting other front-panel buttons. Slide  up to  to lock all the front-panel buttons.  appears. Slide  down to unlock the buttons.

# LISTENING HINTS

---

---

Shortwave listening is a hobby with thousands of participants worldwide. It requires no special knowledge or skills, but your enjoyment increases as you gain experience and develop special listening techniques. The information in this section can help you make the most of your DX-399.

## REFERENCE SOURCES

Many books and magazines about shortwave listening are available through your local library or newsstand. Consult sources such as the *World Radio Handbook*, *Radio Amateur's Handbook*, *Passport to World Band Radio*, *Monitoring Times*, and *Popular Communications*. These publications can help you learn about the conditions that make long-distance reception possible and provide up-to-date listings for shortwave broadcasts in English and in other languages.

## FREQUENCY CONVERSION

A band is a group of frequencies. Bands are grouped according to their wavelengths and measured in meters. A station's tuning location can be expressed as a frequency (kHz or MHz) or in wavelength (meters).

Amateur radio operators generally refer to the frequencies they operate on using the frequency's wavelength. For example, the 19-meter band refers to the range of frequencies with waves about 19 meters long.



---

---

Use the following equations to convert kHz, MHz, and meters.

$$1 \text{ MHz (million)} = 1,000 \text{ kHz (thousand)}$$

To convert MHz to kHz, multiply the number of MHz by 1,000

$$9.62 \text{ MHz} \times 1000 = 9,620 \text{ kHz}$$

To convert kHz to MHz, divide the number of kHz by 1,000.

$$2780 \text{ kHz} \div 1000 = 2.780 \text{ MHz}$$

To convert MHz to meters, divide 300 by the number of MHz.

$$300 \div 7.1 \text{ MHz} = 42.25 \text{ meters}$$

To convert meters to MHz, divide 300 by the number of meters.

$$300 \div 42.25 \text{ meters} = 7.1 \text{ MHz}$$

---

---

## BAND ALLOCATIONS

Certain bands are set aside for specific purposes. Commercial broadcasts are found in the following shortwave bands. Programs (often in English) usually contain news, commentaries, music, and special features reflecting the culture of the broadcasting country. Reception for this range is best between 6:00 PM and midnight (your time).

<b>Band (in meters)</b>	<b>Frequency Range (in MHz)</b>
120*	2.300–2.495
90*	3.200–3.400
75*	3.900–4.000
60*	4.750–5.060
49	5.900–6.200
41**	7.100–7.350
31	9.400–9.900
25	11.600–12.100
21	13.570–13.870
19	15.100–15.800
16	17.480–17.900
13	21.450–21.750
11	25.600–26.100

\* These bands are reserved for stations in tropical areas.

---

---

\*\* Interference is heavy in the 41m band (7.100–7.300 MHz) because amateur radio operators and international stations share this range.

## Time Standard Frequencies

The following frequencies announce the exact time of day at specified intervals.

WWV in Fort Collins, Colorado	2,500 kHz 5,000 kHz 10,000 kHz 15,000 kHz 20,000 kHz
CHU in Canada	7,335 kHz
VNG in Australia	4,500 kHz 12,000 kHz

## Longwave Band

The 150–540 kHz range is known as the longwave band. Most stations in this range serve as beacons for aircraft and marine navigation by continuously transmitting their call letters. Reception for this range is best between 6:00 PM and midnight (your time). Some ships also use this range, with 500 kHz set aside as an international distress and emergency station. Most stations in this range use CW (Morse code), although some use AM voice transmission for weather broadcasts.

---

---

## LISTENING GUIDE

The following list contains some of the most popular stations. All stations broadcast in English unless otherwise specified. You can hear these stations throughout North America. However, reception varies based on the season, time of day, and a number of other conditions.

This information can change at any time. For sources of yearly, up-to-date listings, see "Reference Sources" on Page 32.

<b>kHz</b>	<b>Station</b>	<b>Location</b>	<b>Remarks</b>
3,223	Radio SR	Swaziland	
3,265	Radio Mozambique	Maputo, Mozambique	
3,300	Radio Cultural	Guatemala City, Guatemala	Religious Programs
3,380	Radio Iris	Esmeraldas, Ecuador	Programs in Spanish
3,385	FR3	Cayenne, French Guiana	Programs in French
3,396	Radio Kaduna	Kaduna, Nigeri	
4,750	Radio Bertoua	Bertoua, Cameroon	
4,755	Imo Regional Radio	Imo, Nigeria	
4,777	Radio/TV Gabon	Libreville, Gabon	Programs in French
4,795	Radio Nueva America	La Paz, Bolivia	Programs in Spanish

<b>kHz</b>	<b>Station</b>	<b>Location</b>	<b>Remarks</b>
4,820	Radio Paz y Bien	Ambala, Ecuador	Programs in Spanish
4,832	Radio Reloj	San Jose, Costa Rica	Programs in Spanish
4,855	Radio Clube do Para	Belem, Brazil	Programs in Portuguese
4,890	National Broadcasting Commission	Papua New Guinea	
4,915	Voice Kenya	Nairobi, Kenya	
4,920	Australian Broadcasting Commission	Brisbane, Australia	
4,945	Radio Colossal	Neiva, Colombia	Programs in Spanish
4,965	Radio Santa Fe	Bogota, Colombia	Programs in Spanish
4,980	Ecos del Torbes	San Cristobal, Venezuela	Programs in Spanish
5,020	Solomon Islands Broadcasting Service	Honiara, Solomon Islands	
5,057	Radio Gjirokaster	Gjirokaster, Albania	Programs in Albanian
5,950	Guyana Broadcasting Service	Georgetown, Guyana	
5,954	Radio Casino	Puerto Limon, Costa Rica	

<b>kHz</b>	<b>Station</b>	<b>Location</b>	<b>Remarks</b>
5,960	Radio Canada International	Montreal, Canada	
5,980	Radio RSA	Johannesburg, South Africa	
6,005	CFCX	Montreal, Canada	
6,025	Radio Malaysia	Kuala Lumpur, Malaysia	Programs in Chinese
6,045	Radio Australia	Lyndhurst, Australia	
6,055	Nihon Shortwave Broadcasting Company	Tokyo, Japan	Programs in Japanese
6,060	Radio Nacional	Buenos Aires, Argentina	Programs in Spanish
6,075	Radio Sutatenza	Bogota, Colombia	Programs in Spanish
6,090	Radio Luxembourg	Ville Louvigny, Luxembourg	
6,095	Polskie Radio	Warsaw, Poland	
6,105	Radio New Zealand	Wellington, New Zealand	
7,140	Trans World Radio	Monte Carlo, Monaco	
7,170	Radio Noumea	Noumea, New Caledonia	Programs in French
7,300	Radio Tirana	Tirana, Albania	

<b>kHz</b>	<b>Station</b>	<b>Location</b>	<b>Remarks</b>
9,475	Radio Cairo	Cairo, Egypt	
9,515	Voice of Greece	Athens, Greece	
9,525	Radio Korea	Seoul, South Korea	
9,530	Spanish Foreign Radio	Madrid, Spain	
9,535	Swiss Radio International	Berne, Switzerland	
9,540	Radio Prague	Prague, Czech Republic	
9,570	Radio Bucharest	Bucharest, Romania	
9,575	Italian Radio and Television Service	Rome, Italy	
9,610	Radio-TV Algeria	Algiers, Algeria	Programs in Arabic
9,620	Radio Berlin International	Berlin, Germany	
9,645	Radio Norway	Oslo, Norway	
9,720	Radio Iran	Tehran, Iran	Programs in Farsi
9,745	HCJB	Quito, Ecuador	
9,770	Austrian Radio	Vienna, Austria	
9,800	Radio Kiev	Kiev, Ukraine	
9,835	Radio Budapest	Budapest, Hungary	

<b>kHz</b>	<b>Station</b>	<b>Location</b>	<b>Remarks</b>
10,040	Voice of Vietnam	Hanoi, Vietnam	
11,655	Israel Radio	Jerusalem, Israel	
11,690	Radio Kuwait	Kuwait City, Kuwait	
11,705	Radio Sweden	Stockholm, Sweden	
11,720	Radio Moscow	Moscow, Russia	
11,735	Radio Sofia	Sofia, Bulgaria	
11,745	Voice of Free China	Taipei, Taiwan	
11,815	Radio Japan	Tokyo, Japan	
11,825	Radio Tahiti	Papeete, Tahiti	Programs in Tahitian
11,835	4VEH	Cap Haitian, Haiti	
11,845	Radio Canada International	Montreal, Canada	
11,850	Deutsche Welle	Cologne, Germany	
11,890	Voice of Chile	Santiago, Chile	
11,900	Radio RSA	Johannesburg, South Africa	
11,910	BBC	London, England	
11,930	Radio Havana Cuba	Havana, Cuba	
11,935	Radio Portugal	Lisbon, Portugal	
11,945	Radio Beijing	Beijing, China	



<b>kHz</b>	<b>Station</b>	<b>Location</b>	<b>Remarks</b>
11,955	Voice of Turkey	Ankara, Turkey	
11,980	Radio Moscow	Moscow, Russia	
15,038	Saudi Arabian Broadcasting Service	Riyadh, Saudi Arabia	Programs in Arabic
15,084	Voice of Iran	Tehran, Iran	Programs in Farsi
15,135	Radio Moscow	Moscow, Russia	
15,165	HCJB	Quito, Ecuador	
15,190	ORU	Brussels, Belgium	
15,205	All India Radio	New Delhi, India	
15,260	BBC	London, England	
15,265	Finnish Radio	Helsinki, Finland	
15,275	Radio Sweden	Stockholm, Sweden	
15,305	Swiss Radio International	Berne, Switzerland	
15,310	Radio Japan	Tokyo, Japan	
15,320	Radio Australia	Melbourne, Australia	
15,400	BBC	London, England	
15,430	Radio Mexico	Mexico City, Mexico	Programs in Spanish
15,465	Radio Pakistan	Islamabad, Pakistan	Programs in Urdu

<b>kHz</b>	<b>Station</b>	<b>Location</b>	<b>Remarks</b>
17,720	Radio France International	Paris, France	
17,825	Vatican Radio	Vatican City	
17,860	Austrian Radio	Vienna, Austria	
21,495	Israel Radio	Jerusalem, Israel	
21,525	Radio Australia	Melbourne, Australia	
21,625	Israel Radio	Jerusalem, Israel	
21,645	Radio France International	Paris, France	
21,735	Radio-TV Morocco	Rabat, Morocco	Programs in Arabic
25,790	Radio RSA	Johannesburg, South Africa	

## **BIRDIES**

Birdies are the products of internally generated signals that make some frequencies difficult or impossible to receive. If you program one of these frequencies, you hear only noise on that frequency. The most common birdies to watch for are listed below:

450 kHz	18,000 kHz	3,844 kHz	20,490 kHz
9,000 kHz	21,835 kHz	10,250 kHz	21,868 kHz

---

---

## AMATEUR SHORTWAVE BANDS IN THE USA

Amateur radio operators in the USA are found in the following bands. They operate mostly in LSB (Lower Side Band) mode. Morse code operators are generally found in the lower areas of each band. The ham operators with the most advanced classification are found in the upper areas of each band.

### Amateur Shortwave Bands (in MHz)



Frequency (in megahertz)	Wavelength (in meters)
3.500–4.000 MHz	80 m
10.100–10.150 MHz	30 m
18.068–18.168 MHz	17 m
24.890–24.990 MHz	12 m
7.000–7.300 MHz	40 m
14.0–14.350 MHz	20 m
21.000–21.450 MHz	15 m
28.000–29.700 MHz	10 m

# TROUBLESHOOTING

---

---

We do not expect you to have problems, but if you do, the chart below might help. If you still have problems after following the suggestions below, take the receiver to your local RadioShack store for assistance.

Problem	Cause
Weak or intermittent sound.	The primary-power batteries are weak.
	Antenna needs adjusting.
	Metal is blocking the signal. Move the receiver near a window when you use it inside a vehicle or metal frame building.
	Frequency needs fine tuning. See "Fine Tuning" on Page 23.
	Your receiver is too close to a computer or its peripheral equipment. Move the receiver.
Scan stops when there is no clear signal.	This is caused by birdies. See "Birdies" on Page 42. Using an outdoor antenna might reduce these signals.
<b>MANUAL TUNING</b> and other front panel buttons do not respond.	If  appears on the display, the lock switch is set to  . Slide the lock switch down.

---

---

## RESETTING THE RADIO

If the radio displays random characters or the display stops operating properly, you might need to reset it.

**Note:** This procedure clears time and frequency memory settings. Reset the receiver only when you are sure it is not working properly.

1. Remove the battery compartment cover and the batteries.
2. Insert a pointed object (such as a straightened paper clip) into the **RESET** hole inside the battery compartment, then press and release **RESET**.

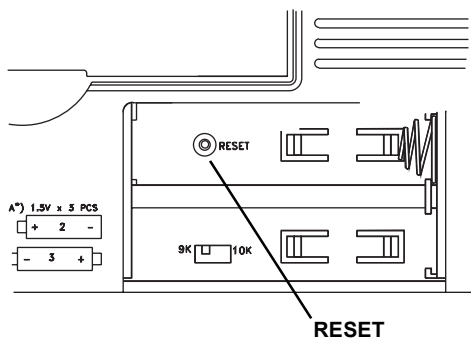

3. Replace the batteries and the cover.

# CARE AND MAINTENANCE

---

Your RadioShack DX-399 Shortwave Receiver is an example of superior design and craftsmanship. The following suggestions will help you care for your receiver so you can enjoy it for years.



Keep the receiver dry. If it gets wet, wipe it dry immediately. Liquids might contain minerals that can corrode the electronic circuits.



Use and store the receiver only in normal temperature environments. Temperature extremes can shorten the life of electronic devices, damage batteries, and distort or melt plastic parts.



Keep the receiver away from dust and dirt, which can cause premature wear of parts.



Handle the receiver gently and carefully. Dropping it can damage circuit boards and cases and can cause the receiver to work improperly.



Use only fresh batteries of the required size and recommended type. Batteries can leak chemicals that damage your receiver's electronic parts.



Wipe the receiver with a damp cloth occasionally to keep it looking new. Do not use harsh chemicals, cleaning solvents, or strong detergents to clean the receiver.

Modifying or tampering with the DX-399's internal components can cause a malfunction and might invalidate its warranty and void your FCC authorization to operate it. If your DX-399 is not performing as it should, take it to your local RadioShack store for assistance.

# THE FCC WANTS YOU TO KNOW

---

---

Your DX-399 might cause TV or radio interference even when it is operating properly. To determine whether your receiver is causing the interference, turn off your receiver. If the interference goes away, your receiver is causing it. Try to eliminate the interference by:

- moving your receiver away from the receiver
- connecting your receiver to an outlet that is on a different electrical circuit from the receiver
- contacting your local RadioShack store for help

If you cannot eliminate the interference, the FCC requires that you stop using your receiver.

This device complies with Part 15 of the FCC Rules. Operation is subject to the following two conditions: (1) This device may not cause harmful interference, and (2) this device must accept any interference received, including interference that may cause undesired operation.

# SPECIFICATIONS

---

---

## Circuit

FM ..... Heterodyne

LW/MW/SW ..... Dual-Conversion Heterodyne

## Frequency Range

FM ..... 87.5–108 MHz

LW ..... 153–513 kHz

MW ..... 520–1,710 kHz

SW ..... 1.711–29.999 MHz

SW Sub-Bands: ..... 2.300–2.495 MHz (120 meters)  
11.600–12.100 MHz (25 meters)  
3.200–3.400 MHz (90 meters)  
13.570–13.870 MHz (22 meters)  
3.900–4.000 MHz (75 meters)  
15.100–15.800 MHz (19 meters)  
4.750–5.060 MHz (60 meters)  
17.480–17.900 MHz (16 meters)  
5.900–6.200 MHz (49 meters)  
21.450–21.750 MHz (13 meters)  
7.100–7.350 MHz (41 meters)  
25.600–26.100 MHz (11 meters)  
9.400–9.900 MHz (31 meters)

## Antenna

LW/MW ..... Built-In Ferrite

SW ..... Telescoping or Optional External

FM ..... Telescoping

Output ..... 160 mW @ 10% THD



---

---

## Jacks

External Power .....	DC IN 4.5V
Stereo Headphones .....	1/8 Inch (3.5 mm)
AM External Antenna .....	1/8 Inch Mono (3.5 mm)

## Power Sources

Battery .....	3 AA Batteries
AC .....	4.5V/200mA, Center Tip Negative
DC (Requires Optional Adapter):	4.5V/200mA, Center Tip Negative
Battery Life (Alkaline):	12 Hours Continuous Operation @ 50 mW
Dimensions (HWD) .....	3 <sup>5</sup> / <sub>8</sub> × 5 <sup>3</sup> / <sub>4</sub> × 1 <sup>3</sup> / <sub>16</sub> Inches (9.2 × 14.7 × 3 cm)
Weight (with Batteries) .....	13.7 oz (390 g)
Accessories .....	Carrying Pouch AC Adapter European Plug Adapter

Specifications are typical; individual units might vary. Specifications are subject to change and improvement without notice.

# NOTES

---

---



## Limited Ninety-Day Warranty

This product is warranted by RadioShack against manufacturing defects in material and workmanship under normal use for ninety (90) days from the date of purchase from RadioShack company-owned stores and authorized RadioShack franchisees and dealers. EXCEPT AS PROVIDED HEREIN, RadioShack MAKES NO EXPRESS WARRANTIES AND ANY IMPLIED WARRANTIES, INCLUDING THOSE OF MERCHANTABILITY AND FITNESS FOR A PARTICULAR PURPOSE, ARE LIMITED IN DURATION TO THE DURATION OF THE WRITTEN LIMITED WARRANTIES CONTAINED HEREIN. EXCEPT AS PROVIDED HEREIN, RadioShack SHALL HAVE NO LIABILITY OR RESPONSIBILITY TO CUSTOMER OR ANY OTHER PERSON OR ENTITY WITH RESPECT TO ANY LIABILITY, LOSS OR DAMAGE CAUSED DIRECTLY OR INDIRECTLY BY USE OR PERFORMANCE OF THE PRODUCT OR ARISING OUT OF ANY BREACH OF THIS WARRANTY, INCLUDING, BUT NOT LIMITED TO, ANY DAMAGES RESULTING FROM INCONVENIENCE, LOSS OF TIME, DATA, PROPERTY, REVENUE, OR PROFIT OR ANY INDIRECT, SPECIAL, INCIDENTAL, OR CONSEQUENTIAL DAMAGES, EVEN IF RadioShack HAS BEEN ADVISED OF THE POSSIBILITY OF SUCH DAMAGES.

Some states do not allow the limitations on how long an implied warranty lasts or the exclusion of incidental or consequential damages, so the above limitations or exclusions may not apply to you.

In the event of a product defect during the warranty period, take the product and the RadioShack sales receipt as proof of purchase date to any RadioShack store. RadioShack will, at its option, unless otherwise provided by law: (a) correct the defect by product repair without charge for parts and labor; (b) replace the product with one of the same or similar design; or (c) refund the purchase price. All replaced parts and products, and products on which a refund is made, become the property of RadioShack. New or reconditioned parts and products may be used in the performance of warranty service. Repaired or replaced parts and products are warranted for the remainder of the original warranty period. You will be charged for repair or replacement of the product made after the expiration of the warranty period.

This warranty does not cover: (a) damage or failure caused by or attributable to acts of God, abuse, accident, misuse, improper or abnormal usage, failure to follow instructions, improper installation or maintenance, alteration, lightning or other incidence of excess voltage or current; (b) any repairs other than those provided by a RadioShack Authorized Service Facility; (c) consumables such as fuses or batteries; (d) cosmetic damage; (e) transportation, shipping or insurance costs; or (f) costs of product removal, installation, set-up service adjustment or reinstallation.

This warranty gives you specific legal rights, and you may also have other rights which vary from state to state.

RadioShack Customer Relations,  
200 Taylor Street, 6th Floor, Fort Worth, TX 76102

*We Service What We Sell*

04/99

**RadioShack**  
**A Division of Tandy Corporation**  
**Fort Worth, Texas 76102**