

6 METER AMATEUR PLL SYNTHESIZED FM TRANSCEIVER 50-55 MHz

IMPORTANT NOTICE!

This manual must be printed in separate booklets in the sections shown below.

NEVER print this manual as a single book!

1-12
?
13-24
25-36
37-48
49-60
61-72
73-84
85-96
97-108
109-120
121-132

A DEDICATION

The Ramsey FX-series FM Transceiver Kits are writing a truly NEW chapter in the annals of the ham radio story. Growing numbers of today's radio amateurs ARE willing to build, understand, adjust and maintain modern VHF gear capable of digital frequency programming and data communication as well as FM voice. How do we know? We know it because, during 1991, thousands of hams worldwide built and are using our pioneering FTR-146 for two meters. The FX Transceiver design was developed in immediate response to those builders' suggestions, wish lists and inquiries. This publication is dedicated with deep thanks to all those FTR-146 builders!

FX-50 VHF FM Transceiver Reference and Kit Assembly Manual

Ramsey Publication No. M50FX

First Printing: December, 1991

Copyright 1991,1994 by Ramsey Electronics, Inc. All Rights Reserved.

Revision number 2.0

Published by Ramsey Electronics, Inc. Printed in the United States of America

RAMSEY ELECTRONICS, INC.

Amateur Radio and Hobby Kits Dept.

793 Canning Parkway Victor, New York 14564

(716) 924-4560 Fax: 924-4555

? Improper output power measurement.

TABLE OF CONTENTS:

The Ramsey FX-50 Transceiver Manual is organized into three sections: General Reference Information, Kit Assembly Phase 1, and Kit Assembly Phase 2.

FX-50 GENERAL REFERENCE INFORMATION

Notice Regarding FX-50 Frequency Coverage	4
FX-50 Technical Specifications	5
Introduction to Transceiver Kit Assembly	6
A Message to Ham Radio Beginners	8
DC Power Supply Considerations	9
Enclosure and Hardware Considerations	10
Ramsey CFX Transceiver Enclosure Kit	12
Guide to PC-board I/O Connections	14
Microphone & Speaker Information	16
A Few Antenna Considerations	16
VHF Packet Data Operation	17
FX-series Transceiver Block Diagram	18
FX-50 Circuit Overview	19
Quick-Reference Programming Guide	28
FX-50 Programming Worksheet	30
Using Computer BASIC as a Programming Aid	31
How to Activate an Auxiliary (non-Standard) Offset	34
Programming "Minus" Offsets	35
Basics of Externally-Controlled Frequency Switching	37
FX-series GLOSSARY of Terms	39
Troubleshooting Guide	46
Note on Replacement Parts	48
RAMSEY ELECTRONICS FX Kit Warranty Terms	50
FX-50 Master Component Index	52
PC Board Assembly Information	56

KIT ASSEMBLY: PHASE 1

Assembly and Explanation of Circuit Stages A through F
(including Kit Parts List, kit-building tips and preliminary receiver & VCO
test).....60 - 86

KIT ASSEMBLY: PHASE 2

Assembly and Explanation of Circuit Stages G through TX (includes all
Frequency Programming directions plus alignment and transmitter tuneup.)
..... 87 - 124

Technicians Notes127

Some channels are off frequency by different amounts. (Refer to preliminary check # 5)

*Common faults:

- ? Improper diode programming.
- ? Solder shorts between traces. (There're a lot of traces between U6 and the diode matrix!)

IMPORTANT NOTICE

The Ramsey FX-50 VHF FM Transceiver is capable of TRANSMITTING as well as receiving on any frequency in the range of 50 to 60 MHz, making it suitable for a wide range of VHF communications requirements. Operation of the Transmit function of this equipment requires an appropriate license issued by the Federal Communications Commission (FCC) for the class of operation intended. The FCC issued TECHNICIAN CLASS license or higher is required for operation in the Amateur 6 Meter band (50 to 54 MHz). Proper licensing is required for MARS or CAP operations. Amateur licensees are required by the FCC to maintain strict control over their equipment to prevent unlicensed operation either in the amateur band or outside it. FCC regulations ENFORCE severe penalties for unlicensed operation of radio transmitting equipment and for interference with other communications services, whether malicious or accidental. Ramsey Electronics, Inc. sells the FX-50 transceiver solely for correctly-licensed operation. It is the sole responsibility of builders and operators of this RF electronics device, capable of emissions controlled by FCC Rules, to understand and comply with those rules.

Transmit Section Faults:

(manual pages 25 - 26, 118 - 123)

1. No power output.
 - a. Check for proper VCO frequency.
 - b. Check +8T and +12V to the transmit Buffer, Driver, and Final stages.
 - c. Ensure D7 is forward biased. (approx. 7.2 VDC at junction of L17 & R54)
 - d. Double check all components in transmit section for proper value and placement.
 - e. Check for heat on Q9 and Q8. (If they're warm, chances are they're working)

*Common faults:

- ? Coils touching the board.
 - ? Solder shorts between components.
 - ? Solder short on Q8 base to ground.
2. Low Output Power. (We see 4-6 watts normally. If your figures are within 20%, consider this ok.)
 - a. Ensure DC input to the transceiver is a full 13.8 VDC. (If your lead wires are too long, they could be dropping excess voltage.) Check for proper voltage on the board, not at the power supply.
 - b. Ensure +8T is a full 8VDC. (This is the supply voltage for the transmit Buffer.)
 - c. Try adjusting the coils slightly, and then retuning for maximum power output. (L2, L3, L12, L13 and L14 are purposely designed to have extra inductance so you can peak the power output by spreading the coils.)

*Common faults:

- ? Low supply voltage.
- ? Improper tuning.

VCO & PLL Faults:

(manual pages 21-24, 82 - 89, 90 - 97)

1. PLL not locking. (L7 will not set correct voltage @ TP1)
 - a. Check for proper programming inputs to U6 (pins 10-25). If incorrect, fault lies between diode matrix and inputs to U6.

VOLTAGES ON U6 @ 52.525 MHZ IN RECEIVE/TRANSMIT

pin ~ VDC	pin ~ VDC	pin ~ VDC	pin ~ VDC
20 ~ 0/0	16 ~ 5/5	12 ~ 0/0	24 ~ 0/5
19 ~ 0/0	15 ~ 0/0	11 ~ 5/0	22 ~ 0/0
18 ~ 0/5	14 ~ 0/0	10 ~ 0/0	21 ~ 0/0
17 ~ 5/0	13 ~ 0/5	25 ~ 5/0	23 ~ 5/5

- b. Check VCO for proper range of operation. Follow the test on page assm. 86-87 of your manual. (You will need to remove R47 for this test) The VCO should tune smoothly from approx. 30 Mhz to 60 Mhz as seen on TP2. If not, check area of Q7. TP3 should indicate approx. 1/64 of the frequency at TP2. If not, check area of U3.

*Common faults:

- ? Solder shorts between traces.
- ? Diodes installed in reverse.
- ? Excess lead length on VCO components
- ? Improper frequency readings. Try probing on other components, (Q7, Q16, R113) for a better reading.

2. VCO Frequency Incorrect.

- a. If frequency is incorrect on one channel only, recheck diode programming for that channel.
- c. A few channels are off by the same amount. Check for similar diode programming on these channels to find your faulty area. (ex. Let's say our faulty channels are all off by 10 Khz, and they all use the # 2 diode programming position. Hmm, if we refer back to the manual, isn't our "n" number for 10 Khz right about 2? Some coincidence! Now we can guess that our fault is between the # 2 position trace and the input to U6.)

SPECIFICATIONS FOR THE RAMSEY FX-50

General:

Frequency Range:	Any 10 MHz segment between 50 and 60 MHz
Tuning:	Diode-programmable PLL synthesis 12 front panel selected frequency pairs, easily expandable by switches, microprocessors, computers, etc.
Programming:	5 KHz steps with programmable offsets
Transmit Offset:	Programmable: Simplex, +1.0, -1.0, Aux
Mode:	NBFM
Packet (Data) Operation:	All rates incl. 9600 baud . 5-pin DIN jack (TXD, RXD, PTT, +12VDC, GND)
Packet RX Audio:	Speaker, discriminator or true FSK
Power Requirement:	13.6V DC +/-10% (Negative ground)
Power Consumption:	1.0 A Transmit (for 5 watts RF output) 200 ma. (Receive, no signal)
Antenna Impedance:	50 ohms
Microphone Impedance:	600 ohms or high impedance
T-R switching:	PIN diodes
PTT circuit:	Solid State (for standard ICOM-type speaker/mic connection)
Semiconductors:	10 IC's, 16 transistors, 24 diodes (plus programming diodes)
Transmitter:	
Final Power Output:	4-6 watts RF
Final Output Stage:	MRF237 or equivalent
Modulation:	True direct FM
Max frequency deviation:	+/- 25 KHz, +/- 5 KHz NBFM
Modulation distortion:	Less than 5%
Receiver:	
Circuitry:	Double-conversion superhet
	First IF: 21.4 MHz
	Second IF: 455 KHz
Sensitivity:	12 db. SINAD less than 0.35 uv
Selectivity:	7 KHz (-6db.), 15 KHz (-60db.)
Squelch sensitivity:	Less than 0.25 uv
Audio output:	More than 2.0 watts
Circuit access points:	COR, PL tone input, FSK demod. +12V, +8V, PLL programming.

INTRODUCTION

to FX-series VHF Transceiver Kit Assembly

For the 1990's, Ramsey Electronics has adopted a "Learn As You Build" philosophy for ALL our electronics kits. We feel that licensed ham operators should know about the equipment they use, and also should have the desire to understand how their gear works. Additionally, it has been our corporate response to all those urgings by public officials that both students and their parents need to become sharper in science and math. This "Learn as You Build" approach to electronics hobby kits is now evident in all Ramsey Electronics build-it-yourself kits from our under-\$5 student kits up to this synthesized VHF transceiver suitable for ham radio and public service applications alike.

We think that "learning (and UNDERSTANDING) as we build" is especially essential in a more sophisticated project such as the Ramsey FX-series VHF transceivers. In fact, we are so convinced of this basic need that this kit instruction manual departs from the traditional scheme of separating assembly directions from a "theory of operation."

The FX-series of Ramsey VHF/UHF Transceivers puts today's FM 2-way radio technology back in YOUR hands at a budget price. Our idea of "budget" looks far beyond the modest purchase price to our goal that you can maintain your FX- unit in good operating readiness with no need for expensive shop service. On the other hand, we also have made the transceiver design as abuse-proof and rugged as possible. "Alignment," traditionally an intimidating many steps process is very easy, quick and fool-proof in this circuit design.

Instead of separate stage-by-stage assembly directions plus separate theory information, these FX- instruction booklets highlight your transceiver's operational theory, often a single component at a time, with actual construction steps provided as follow-up after each explanation. The assembly sequences are easy to find in the following pages. You indeed have the freedom to solder first and read all about it later. We hope, though, that you'll take it easy, learning as you build, and then enjoy the reliability of your Ramsey FX Transceiver for a long time to come.

The "style" of our kit-building directions presumes that you are peeking at our multi-color parts layout sheet while seeing that the very same parts outlines are imprinted on the component side of your FX- PC-board. Our smaller kits do not justify any need for on-board imprinting (silk-screening). Therefore, such kits provide more detailed published explanations for identifying correct locations for inserting and soldering parts.

You'll install EVERY FX- part perfectly by using our simple step-by-step kit building process. And you'll know the WHY of most assembly steps, if not all of them. Before you start, THINK about what you'll create from those bags of

FX-50 TECHNICIAN'S NOTES

Throughout production of the "FX" series transceivers, the technicians here at Ramsey have been speaking with customers, making repairs, experimenting, and compiling notes on the FX-50. These notes, and the circuit overview and theory of operation sections of your FX-50 manual, provide extensive information on the inner workings of the FX-50. Should a nasty gremlin jump into your trusty new FX-50, this information will help lead your foray into troubleshooting.

Several voltages and testpoints are given throughout this guide. Keep in mind that, due to differences in test equipment, power supply voltage, etc., your readings may vary slightly. Any voltage within 20% or so should be considered ok. It may also be difficult to lead you to a specific component or fault right off.

Now clear off that workbench, lock the doors, put up the "do not disturb" sign, and let's get started!

Preliminary Checks: (Many times these first few checks will solve the problem.)

1. Proper DC voltages. (+13.8VDC, +8V, +5V, +8T, +8R)
2. Solder connections. All joints should be clean, shiny, and solid. (You won't need a magnifying glass. If a connection is suspect, reflow the solder.) Also, check for stray solder shorts or bridges.
3. Easy to confuse items. Now let's see, was that a 10K ohm resistor or 1K ohm? Some of those color bands look quite similar to tired eyes. Let another pair of eyes check your work.
4. Component lead length. **VERY IMPORTANT!** Make sure all component leads are as short as possible. In other words, pull the leads through the board until the component body rests on the board. The hand wound coils of buss wire should not touch the board! (One exception - obviously)
5. Make sure only one channel is activated at a time. A diode installed backwards in another channel can turn on two channels at once! Your voltmeter should indicate voltage on only one bus wire at a time. This is true for the offsets too.
6. Reread those sections of the manual where you feel the possible fault could be. A thorough understanding of each circuit just may help after all.

parts as a finished product! For a minimal investment of your time as well as your well-earned money, you will have a VHF FM voice-data transceiver that you will truly own. Real "owning" ultimately means knowing how to maintain and understand something that we have, in contrast to merely possessing a thing because you spent the bucks to do so. You'll have the flexibility of 12 channels chosen by YOU with the easy ability to change or expand. You'll have both FM voice and high-speed data capability. When you're ready, you can experiment with many different enhancements, concentrating on those truly useful to you. If there's ever a problem, you won't think twice about digging in and fixing it. Whenever you decide you could use still another VHF/UHF FM/data transceiver at a budget price, you'll know with confidence that an FX-series kit is the right way to go.

What's faster: turning your FX- Transceiver to any one of 12 possible channels programmed by you, or trying to remember again exactly how to use the memory pre-sets of your HT, or your HF rig, or the VCR, or the microwave?

Let's learn about and build up an FX- VHF FM Transceiver!

A MESSAGE TO HAM RADIO BEGINNERS:

If you have just earned your Novice or Technician license, or are studying for either of them right now, we'd like to say a special Thank You for choosing this Ramsey VHF/UHF transceiver as part of your ham radio beginnings. We have tried to make this instruction manual as clear as possible. However, there are some VHF radio "basics" covered by the FCC question pools for all ham license study guides that we must presume that you have studied and understood.

Here is a simple guide to selected Technician Class questions to help with any review you wish to make before building:

FCC Subelement 3AA (Selected Rules): 4.2 11-1.1 12.5 15.2

FCC Subelement 3AB (Operating Procedures): 2-1.1 2-1.2 2-1.3 2-1.4
2-1.5 2-2.1 2-2.2 2-3.1 3.2 6-3.1

FCC Subelement 3AC (Propagation): It's up to you to understand the characteristic differences among HF (shortwave), VHF and UHF communications.

FCC Subelement 3AD (Amateur Radio Practice): All of this is fundamental know-how for hams. In working on this project, be especially familiar with: 1-1.1 1-1.2 1-1.3 7.1 9.1 through 9.5 (dummy loads)

FCC Subelement 3AE (Electrical Principles) 3AF (Circuit Components)
Please know ALL of this.

FCC Subelement 3AG (Practical Circuits): 4.21

FCC Subelement 3AH (Signals and Emissions): 1.1 2-1.1 2-4.1 2-6.2
2-7.1 4.1 6-1.2 7-1.1 7-2.1 7-2.2

FCC Subelement 3AI (Antennas and Transmission Lines): You will want to know all of this, if you don't want to take all your savings from building your own transceiver and spend it on a commercially-built antenna. Very good VHF antennas are easy and inexpensive to build yourself!

Step 8, regarding FM Deviation.

Remember that indicated RF output also depends on the accuracy of the wattmeter and correct DC supply voltage. Our lab measurements consistently show 5 watts or better.

✍ TX52. Replace the dummy load with a well designed 6 Meter antenna and start enjoying the FM transceiver that you built yourself!

IMPORTANT:

It is your responsibility to know what band privileges are granted by your Amateur Radio License and how to program the frequency synthesizer correctly within the 50 to 54 MHz operating range of the 6 Meter Amateur Band. A proper license is required for transmitting in this band. Other FCC licensing is required for operation of this equipment on frequencies outside the Amateur Band. It is illegal for licensed amateurs or other persons to transmit on frequencies for which they are not properly licensed.

RAMSEY ELECTRONICS, INC.

- ✍ TX46. Line up the two ground wires and C27, the 82 uf coupling capacitor, on the low pass filter board with the mating holes on the main FX PC board. Allow the low pass board to stand about 1/8" above the main FX board and at a neat right angle. Solder the leads to the main FX board, be careful so as to not loosen the solder joints on the little board from too much heat when soldering - if you do, just retouch the solder joints again, it's no big deal!

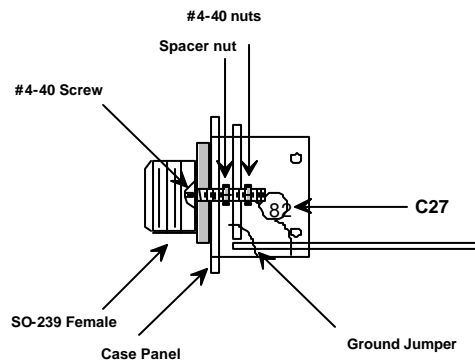

TRANSMITTER COMPLETION AND TUNEUP

Do not proceed with the following until all of the previous steps have been completed successfully. You now have a somewhat fragile assembly, the rear panel being held to the main PC board with only three wires so please be careful during the next few steps.

- ✍ TX47. Disconnect DC power and antenna.
- ✍ TX48. Connect the following to your transceiver:
 - ? 50-ohm dummy load
 - ? VHF RF wattmeter or voltmeter connected to R115, the stand up resistor test point on the low pass filter board.
 - ? DC 12 volts power
- ✍ TX49. Press (key) the transmit button and alternately adjust C75 and C74 with a non-metallic alignment tool for maximum RF output indicated on the meter. If you are using a voltmeter connected to the resistor test point, you will typically see about 12 to 15 volts when connected to a good 50 ohm load. Keep these key-down tests as brief as possible.
- ✍ TX50. If you are observing at least 4 watts of RF output, transmitter tuneup is completed. Spread coils L12, 13 and L14 on the main board and L2 and L3 on the low pass board for maximum RF output. These coils are purposefully wound with a little too much inductance, so that they can be easily "peaked" by some spreading. This is probably one of the most important steps to get the most RF out of your rig.
- ✍ TX51. Adjust Modulation control R46 by listening on another receiver or scanner and simply adjust for best sounding audio. See Test Procedure,

DC POWER SUPPLY CONSIDERATIONS :

Your Ramsey FM Transceiver is designed to operate from any stable DC voltage source in the 12 to 15 volt range, from typical car, boat or plane 12V systems to a wide variety of battery packs or AC-powered DC sources. In a pinch, you can get on the air for quite a while with 8 to 10 ordinary "D" cells! Our lab tests show only a .93 amp current draw for 5 watts of RF output. We have just a few points of advice and caution:

1. Your DC supply should be able to provide a minimum of 1.0 amperes in continuous service.
2. Any battery setup capable of supplying 12-15VDC will serve quite well.
3. Use of wall plug power supplies is NOT recommended. Obviously, 12VAC output is not suitable. Most DC output units do not have adequate voltage regulation.
4. Turn your transceiver OFF before re-starting the vehicle in which it has been installed.
5. Replace F1 only with a 1 amp fuse.
6. If you power your transceiver from the +12V accessory voltage available from other equipment, be sure that source is rated for the 1 amp required.
7. Your transceiver circuit includes noise suppression at the DC input and additional filtering at the VCO, primarily to prevent ignition/alternator noise from being introduced into the FM modulation. If you hear ignition noise in the receiver, the vehicle has a serious general problem. Check your transmitted signal on another receiver before mobile operation. Radio Shack sells a variety of noise-suppression capacitors and chokes. The ultimate solution, which has been tested, is to run the transceiver from a smaller accessory battery.

If you plan to build a power supply for fixed-station use, there are numerous construction articles in ham and electronics hobby publications. A convenient new book featuring easy-to-find components and clear explanations is Building Power Supplies (Radio Shack 276-5025.)

ENCLOSURE & HARDWARE CONSIDERATIONS:

The companion CFX case and knob kit is sold as a separate option ONLY as an accommodation to those radio hams who have their own ideas or resources for the "finishing touches."

However, a proper case for your FX-series is much more than a "finishing touch," since the controls and jacks are panel mounted and proper RF shielding is required.

The CFX case measures 9-3/4"L X 6"W X 1.5"H. 9" x 6" dimensions are minimum for accommodating the PC board. The height may vary if you wish to include an internal speaker, accessory PC boards, additional front panel controls or indicators, etc. If you are new at all this and do not already own a suitable enclosure plus that collection of hardware and knobs that every ham seems to accumulate, here is what you need to know if you are hesitant to purchase the CFX case kit:

- A. "Blank" electronics enclosures have become among the most expensive hardware in the industry, especially if you are buying just one unit. This is because they are sold mainly to engineers and designers for prototyping. A blank metal enclosure even slightly comparable to the CFX case kit will run \$30 to \$80 or more. Even a plain aluminum chassis box/cover will be around \$15.00.
- B. If you think there's any chance you someday may wish to sell or trade your transceiver, you should be aware that units mounted in odd boxes may have even less value than the bare circuit board with documentation alone.
- C. Many distributors have a minimum mail order of \$25.00.
- D. Your best chance for finding an inexpensive alternative case is to have access to a lot of ham friends who tend to "collect stuff," or to browse the catalogs or showrooms of electronic surplus dealers. You just might find a gorgeous new box originally intended for somebody's ingenious Ultra Modem, external disk drive or other dream gadget from two years ago.

Are we trying to discourage you? No, not really! We know you can see that there are good reasons to consider calling Ramsey Electronics and getting your CFX case on its way while you work on the PC-board and PLL Programming. However, we do not want you to feel "stuck" with our recommended CFX enclosure, so we have worked up a detailed shopping list for getting what you will need to make as attractive a finished unit as possible with a single trip to the neighborhood Radio Shack store.

- TX36. Install R41, 1K (brown-black-red).
- TX37. Install D4, 1N914/1N4148 diode, observe correct placement of the cathode band.
- TX38. Install C20, 82 pf.
- TX39. Install C28, 220 pf.
- TX40. Install C30, 100 pf.
- TX41. Install L3, the 7 1/2 turn coil prepared in stage TC. Insertion will require you to spread the windings slightly to fit the holes. When mounting these coils, do not allow the wire spirals to contact the PC board ground plane area under them. The coil must sit slightly above the board and not short against it.
- TX42. Fabricate R113. Locate a 1K resistor (brown-black-red). Cut one lead to a length of 1/4" and bend it into a small loop as shown. Carefully hold it straight while soldering it to the board. This loop will provide a handy point to attach a meter probe.
- TX43. Install C27. Locate an 82 pf capacitor, bend out its leads away from the body and insert one lead into the PC board and solder. Its other lead will connect to the main PC board later.
- TX44. Locate two scrap component leads at least 1/2" long. Solder each lead to the PC board as shown, these leads will also attach to the main PC board.

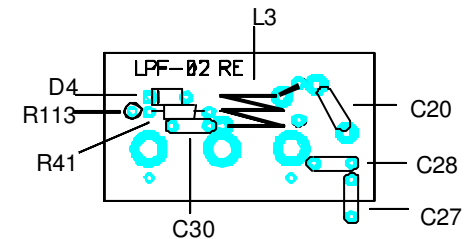

This completes the assembly of the low pass filter PC board, inspect the board to be sure all leads on the bare side of the board are trimmed neatly and that the coil does not short against the PC board ground plane.

- TX45. Exactly when to install the SO-239 antenna RF connector is left to your discretion. If you are using your own case, you must now "wing it" on your own, observing the way we are mounting the connector to our case. If you are using the Ramsey CFX case set, mount the SO-239 to the rear panel as part of this assembly operation. Use the two screws and four nuts supplied and consult the illustration as needed. The flange of the connector sits on the outside of the rear panel. Mount the connector with one set of nuts, then mount the low pass filter PC board using the other two nuts. Solder the connector center pin to the board.

9. Disconnect power and proceed with completing the transmitter section (Steps TX15, etc.)

IMPORTANT: If you do not achieve the test results discussed above, there is no point in doing more work on the transmitter section until the problem is solved. If you are not able to transmit at least within the same room and receive on any desired frequency, finishing the transmitter is not going to fix the problem.

CONTINUE TRANSMITTER ASSEMBLY:

- ✍ TX33. Install RF choke L10, one of the pre-wound 8 turn enameled wire coils.
- ✍ TX34. Install L9, the other 8 turn pre-wound coil.
- ✍ TX35. Install L2, one of the 7 1/2 turn coils you hand-wound in step TC2. Sit it above the PC board about 1/16".

Stage TX: FINAL PROGRESS CHECK:

1. Double check component selection for Steps TX.
2. Use bright light and magnifier to go over entire board to check for missed connections or solder bridges. If you suspect a solder bridge, simple review the X-ray illustrations to see whether the points in question are indeed to be tied together.
3. Carefully check entire board for:
4. Loose bits of wire lodged among connections or components on either side of board.
5. Excess wire lengths which may not have been nipped and are now bent flat, probably against another connection.

BUILDING THE LOW PASS FILTER PC BOARD:

The assembly of the low pass filter PC board is quite different from the way in which you have assembled the main FX transceiver board. Component parts are mounted on the circuit trace/solder side of the board! The reason for this is that the board mounts against the output connector - and it would be very difficult to solder the connector center pin after the board is mounted to it. You'll see why as you finish building your rig.

When installing parts, insert the component on to the PC board from the solder side, the leads will extend out through the bare side of the board with no traces. The part is then soldered on the solder side and the leads trimmed away flush on the other side. When soldering the disc caps, be sure that their leads are properly soldered. Sometimes the body insulating material will coat the lead preventing a good solder connection and you may wish to slightly scrape away this coating on some parts.

Quantity	RS Part No.	Description	1992 Price (\$)
1	270-272/74	Deluxe Project Enclosure	8.79 or 10.79
1 set	274-section	Pkg. of 3 or 4 knobs	2.00-3.00
1 set	270-201	Rub-on project labels	2.99
2 sets	276-195	PC-board standoffs/	2.38

This \$16 to \$18 (plus tax) in basic hardware also presumes availability of all needed drill bits and/or a reamer or punches of sufficient size to make the needed access holes for the rear panel jacks. You'll also want to figure on spray paint as well as a clear finish to protect the panel labels. Tools and supplies, if not on hand, could cost much more than the CFX enclosure kit itself.

In addition, this style of case will have to be utilized upside-down and also length wise rather than as designed. This means that the top (black) becomes the foundation for mounting the PC board with the standoffs as well as securing the SO-239 antenna connector assembly. You may wish to repaint the white bottom which now becomes the top. And, to use the project labels (black lettering), you'll probably wish to repaint both pieces.

This adaptation of standard Radio Shack hardware is adequate for indoor or occasional use but not recommended for mobile operation. We are happy to provide this suggested alternative to the rugged case, knob and hardware kit custom designed for the FX-series transceivers. The choice is yours!

THE RAMSEY CFX TRANSCEIVER ENCLOSURE KIT:

The CFX Kit is very obviously a fair value and solid investment for the long term performance and worth of your transceiver. As we have mentioned, we make it "optional" ONLY because some of our ham customers have specialized applications requiring only the basic PC board kit. We try whenever we can to accommodate that important do-it-yourself spirit of ham radio.

ENCLOSURE KIT PARTS LIST

Please check the boxes after the components have been identified, and it is also handy at this time to "sort" the like components into groups or bins (an egg carton does nicely) to avoid using the wrong component during assembly.

- ✂ 1 Steel bottom shell with 5 threaded PC board standoff posts
- ✂ 1 Steel top shell
- ✂ 1 Front control panel
- ✂ 1 Rear panel with access holes to PC mounted jacks
- ✂ 2 Steel side rails
- ✂ 5 PC board standoff spacers
- ✂ 5 #4 nuts to secure PC board on standoffs
- ✂ 8 #4 screws to mount front and rear panels
- ✂ 8 #6 screws for securing top and bottom to side rails
- ✂ 1 large knob for Channel Selection Switch
- ✂ 2 smaller knobs for Volume and Squelch controls
- ✂ 4 self-adhesive rubber feet

CFX CASE ASSEMBLY PROCEDURE:

The purpose of these hardware parts is largely self-evident. We offer the following suggestions for your convenience and to minimize wear and tear on your factory-fresh CFX enclosure.

- ✂ 1. Since the bottom shell might be used for several "test fittings" during transceiver assembly, install the rubber feet right away to protect its finish.
- ✂ 2. Obviously, the PC board cannot be secured permanently to the bottom section until after installation of L9, R32 and L10 AFTER Alignment and before Transmitter tuneup.
- ✂ 3. Install the strain-relief grommet supplied with the transceiver kit in its rear panel hole. Pass the black ground wire through this grommet. The red, fused wire will have to be unsoldered from S1 and then carefully

TRANSCEIVER PLL ALIGNMENT

Our goal in this test is to verify speech amplifier operation (U4), actual FM modulation of a low-level RF signal (Q10), and correct operation of the PLL Frequency Synthesizer in Transmit mode. If an antenna is connected for this test, it will affect receiver operation only. The "antenna" for the 10 milliwatt output consists of the lead lengths and circuit-board traces associated with C76 and C82.

TEST PROCEDURE:

1. Make sure work area is cleaned up and that the PC board is checked for wire scraps lodged between connections, etc.
2. Set transceiver frequency to 52.525 MHz Simplex.
3. Obtain or make a non-metallic alignment blade capable of turning the slug in L7 and also turning trimmer C81.
4. Connect speaker, microphone, antenna and 12-15 volts DC. (Antenna will serve receive function only.)
5. Connect a digital voltmeter (DVM) of known accuracy to TP1 (red + lead to the test point, and black lead to ground). Set the meter to the lowest DC range that will handle up to 7 or 8 volts. A digital voltmeter is used for this procedure because it has the required high input impedance.
6. With the transceiver power turned on, press the microphone button and adjust L7 for a reading of 1.6 VDC at TP1.
7. A precision adjustment of C81 requires either a frequency counter connected to TP2 or a digitally accurate VHF receiver tuned to 52.525 MHz. With the microphone keyed (button pressed), C81 is adjusted for exactly 52.525 MHz on your Ramsey frequency counter or a zero-beat 52.525 MHz signal on a digitally accurate monitoring receiver. If you cannot tune C81 high enough, clip out C80, 15 pf. An adequate initial adjustment of C81 can be made by listening to your signal on any VHF FM receiver and carefully adjusting C81 for the clearest-sounding signal. Or: adjust C81 for the best reception of a transmitted signal of known accuracy. This might be all that you'll ever need to do, but it is recommended that you make the precise adjustment when possible.
8. While speaking in the microphone, adjust modulation level (R46) for the best sounding speech. "Best" is not necessarily the maximum: see the following note. NOTE: R46 adjusts the FM deviation of the transmitted frequency. Deviation is carrier frequency swing in step with voice modulation. If you "over-deviate," your signal will not be stronger. Instead, the speech will become distorted and "splash" over to adjacent channels. Deviation is a very important adjustment: "best sounding speech" will usually result in the proper 5KHz deviation used on VHF FM.

- ✍ TX31. L8, 2.2 uh choke (green body with red and gold bands).
- ✍ TX32. D7, BA482 PIN diode (small glass body marked BA482). Observe correct orientation of cathode band.

At this point, all transceiving functions except final transmitter output power may be tested and aligned. Q10 has plenty of RF output (10 milliwatts) for a signal that can be heard in a nearby receiver or scanner. You may test and align the transceiver now or do so after installing the remaining transmitter parts. **However, DO NOT INSTALL L9 or L10 UNTIL AFTER ALIGNMENT HAS BEEN COMPLETED. Whether you test now or later depends on how anxious you are to see (and hear) the results of all your hard work. If you are still awaiting your ham license, you can test the FM modulation of buffer stage Q10 and also enjoy your receiver fully. Be aware, however, that the buffer stage, even with no antenna connected to it, has a transmitting range of about 100 feet, even through walls and obstacles.**

resoldered after passing through the grommet. Snap in the locking section of the relief grommet only AFTER both the red and black wires are in place.

- ✍ 4. Remove the two screws from the SO-239 antenna connector, gently bend the lugs as needed to match the rear panel holes, then secure the jack and lugs to the rear panel.
- ✍ 5. Since the top shell will not be needed until you're ready to go on the air, keep it wrapped in protective material until you're really ready to use it.
- ✍ 6. The side rails may be installed to the bottom section at any time. To prevent loss of the screws for the top, keep them loosely threaded in the side rails.
- ✍ 7. There is no point in securing the front panel controls and jacks to the panel permanently until AFTER wiring the Channel Selection switch. Note the locking hole for the switch in the front panel which mates the tab on the front of the switch.
- ✍ 8. Use care and a well chosen pair of pliers to secure the microphone and speaker jacks to the front panel, so as not to scratch the panel.
- ✍ 9. Bend the leads of the TX LED so that their tension presses the front of the bulb against its front panel hole.
- ✍ 10. Whenever you find it necessary to remove the top shell, "store" the screws back into their holes in the side rails.
- ✍ 11. If you decide to install a ribbon cable in the diode matrix for external programming control, route the cable (folded at a right angle) on the synthesizer and receiver side of the board so that it exits the case between the rear panel and top cover, right above the DC power cord. Do NOT route any such cable across the VCO and transmitter side.
- ✍ 12. After the PC board is secured to the case bottom and front/rear panels, it is a good idea to neaten up the wires to the controls and jacks, bundling them at two or three points with tie wraps or cord.

GUIDE TO PC BOARD I/O CONNECTIONS:

In addition to primary interconnections required for jacks and controls, etc., your FX-series Transceiver PC board provides additional access to operating voltages and circuit features to make later customizing as neat and easy as possible. All these points are plainly marked on the board itself and highlighted on the facing page, with a few other components for

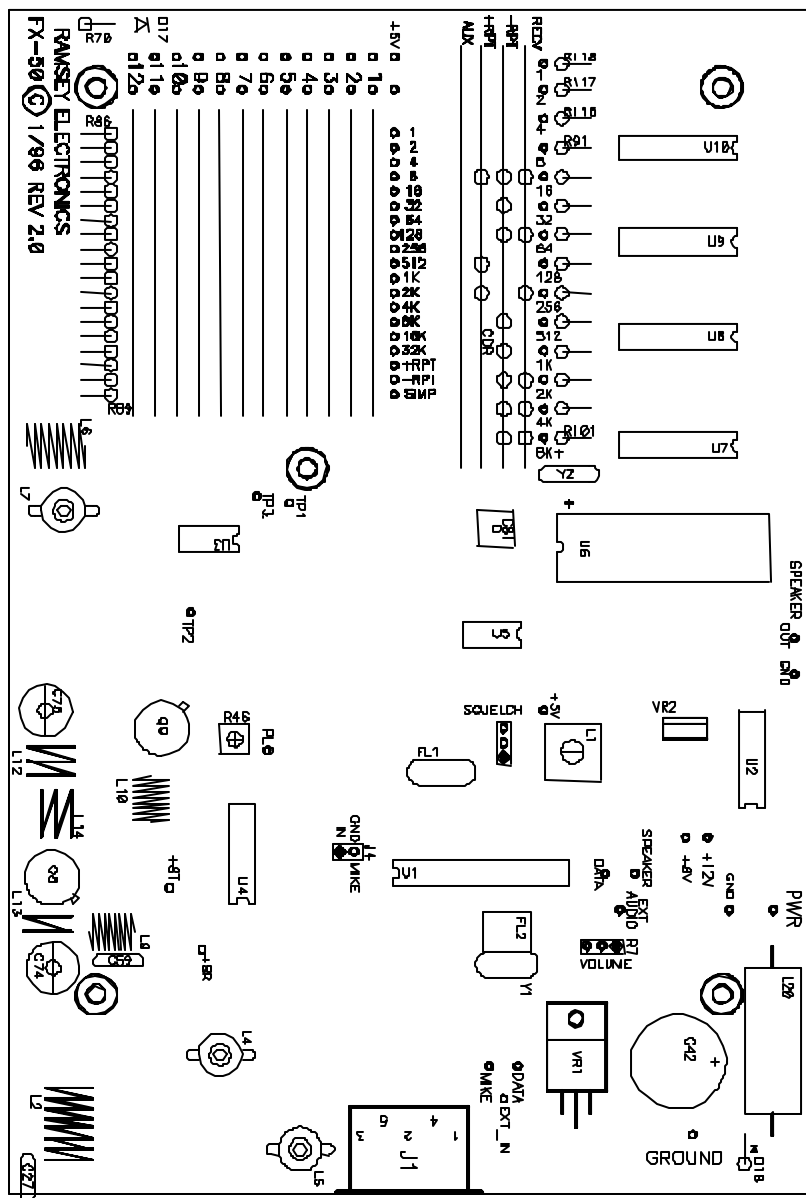

- ✂ TX16. C82, 27 pf (marked 27 or 27K).
- ✂ TX17. C61, .01 uf.
- ✂ TX18. Locate and install L12, the 2 1/2 turn coil wound previously in step TC1. Install it so it sits about 1/16" above the PC board.
- ✂ TX19. Locate and install L14, the other 2 1/2 turn coil wound in step TC1. Install it so it sits about 1/16" above the PC board.
- ✂ TX20. C103, 150 pf (marked 150 or 151).
- ✂ TX21. a. Prepare the following tools for installing SMT chip capacitor C72:
 - ? Tweezers
 - ? Magnifier (if needed)
 - ? Low wattage, clean soldering tip
 b. Unpack and study the design of the chip, noting both ends are metallic.
 - c. With an exacto knife or other blade, carefully scrape off the green solder mask from the back of the PC board where C72 will be soldered. Lightly pre-tin both PC board points.
- d. Holding C72 in place across the two tinned points with tweezers, gently touch one junction with the soldering tip. The connection should solder easily.
- e. Solder the other end and touch up the first one if necessary.
- ✂ TX22. R29, 51 ohms (green-brown-black).
- ✂ TX23. C60, 220 uf electrolytic capacitor, observe correct polarity.
- ✂ TX24. C58, .1 uf (marked .1 or 104).
- ✂ TX25. C59, .01 uf
- ✂ TX26. Locate and install L13, the 1 1/2 turn coil previously wound in step TC3.
- ✂ TX27. C55, .01 uf (marked .01, 103, or 10 nf).
- ✂ TX28. C63, 27 pf (marked 27 or 27K).
- ✂ TX29. Trimmer capacitor C74.
- ✂ TX30. C64, 100 pf.

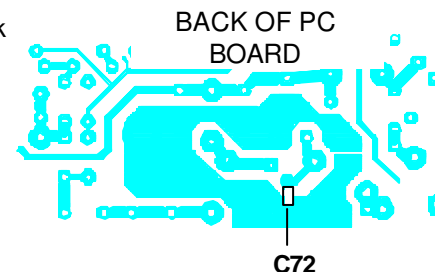

- ✍ TX1. Install Q9, RF NPN type 2N3866. Let it rest flush on the round bare area of the board. The holes match the pins, so the tab will point exactly as illustrated.
- ✍ TX2a. RF Final transistor Q8 (MRF237 or SD1127) is also installed completely flush on the board, with the tab oriented toward L9. The case of Q8 is common to the emitter. Be sure the case stays completely flat against the top ground plane when soldering the 3 points.

READ CAREFULLY: The following procedure lets the top groundplane serve as the heatsink for the RF final output transistor. Do not be hesitant in making a smooth solder bond between Q8's case and the board. An ordinary soldering pencil tip applied to both the case and the groundplane at the same time will NOT damage Q8. On the other hand, the lack of a good heatsink bond WILL destroy Q8 when transmitting. This procedure is INTENDED by the manufacturer.

- ✍ TX2b. Now, using only your regular soldering pen and NOT a soldering "gun," solder the rim of Q8 directly to the top ground plane, starting at the square tab. Use enough solder for thorough bonding.

Identify and install the following components:

- ✍ TX3. R34, 100 ohms (brown-black-brown).
- ✍ TX4. C56, .001 uf (marked .001 or 102).
- ✍ TX5. R36, 15 ohms (brown-green-black).
- ✍ TX6. C84, .01 uf (marked .01 or 103).
- ✍ TX7. Q10, NE021 (small black disc stuck to paper, marked 021). The longest of the three leads is the collector, which points towards C76. Remove Q10 from its paper backing, bend the leads down and install it as shown. It should sit snug against the PC board.
- ✍ TX8. R110, 10K (brown-black-orange).
- ✍ TX9. C97, .01 uf (marked .01 or 103).
- ✍ TX10. C44, .01 uf.
- ✍ TX11. L11, 2.2 uh choke (green body with red and gold color bands).
- ✍ TX12. C76, 100 pf (marked 100 or 101).
- ✍ TX13. R28, 51 ohms (green-brown-black).
- ✍ TX14. Trimmer capacitor C75.
- ✍ TX15. C66, .001 uf.

1. PRIMARY CONNECTIONS:

PWR (near L20): +12-15 volts DC from S1.

GROUND: - DC from battery or power supply.

SPEAKER: both connections near U6 and U2.

MIKE: both connections (IN & GND) near notched end of U1.

SQUELCH: three connections near L1.

VOLUME: three connections near VR1 and C42.

ANTENNA: Center of SO-239 connected at "RF OUT" near C27.

CHANNEL SWITCH: Row of holes numbered 1 through 12. The switch wiper (moving contact) is wired to +5V near "1."

EXT AUDIO: must be jumpered per options to enable pin 4 of J1.

2. TEST POINTS:

+12V, +8V, +8R, +8T permit checking for presence of those voltages. +8R = Receive mode. +8T = Transmit.

TP1: For checking of VCO control voltage during alignment.

TP2: For checking VCO frequency with counter.

TP3: For checking U3 prescaler output with counter.

3. OPTIONS:

+12V, GND, +8V, +5V, +8T, +8R: provide supply voltage for accessories or modifications designed by you. +8T and, +8R are near L9 and U4.

Jumper Options for Packet Operation: SPKR to EXT AUDIO: Speaker level audio for packet (J1). DISC to EXT AUDIO: FM discriminator output for packet.

COR: "Carrier Operated Relay" output from U1.

Binary Programming Holes: The row of holes alongside the Binary Programming labels permits installation of ribbon cable for external programming devices designed by the innovative amateur radio community, switches or interfaces, or a row of internal DIP switches.

MICROPHONE & SPEAKER INFORMATION

The FX transceivers with the hardware supplied are designed to accept standard ICOM or ICOM-compatible speaker-mikes such as MFJ-284. Ramsey sells the SM-7 speaker mike, the perfect companion to your FX kit. Another conveniently available such unit is Radio Shack No.19-310.

Be aware that the receiver audio amplifier is capable of supplying a husky 2 watts or more of audio power and will drive full-size communications speakers to excellent volume levels.

The PTT switching circuit can be activated simply by introducing a resistance (e.g. 10K) from the microphone input to ground. This resistance is enough to trigger the PTT circuit without interfering with the microphone audio input.

Consider these factors in selecting microphone, speaker and/or speaker-mike for FM voice operation. If your microphone and speaker preferences differ radically from the use of a speaker/mike, and you do not wish to alter the front panel, remember that you also have very easy access to mike and speaker lines via J1, the packet connector.

A FEW ANTENNA CONSIDERATIONS

The idea of building your own transceiver is to save money and enjoy your hobby. Effective VHF and UHF antennas are easy and inexpensive to build, whether for fixed or mobile use. There are plenty of off-the-shelf antennas to buy, but don't hesitate to "roll your own."

If you are a newcomer to ham radio, you'll discover many strong opinions about the "best" antenna to use. A home-built ground plane vertical or even a dipole can provide very satisfying results. Whether you need a gain factor or directivity in your antenna depends on your operating goals. Regardless of the style of antenna, it really pays to give serious attention to electrically-solid, weatherproof connections of the coaxial cable to the antenna elements. A simple antenna in good condition will outperform a fancy one that's been neglected.

Popular ham magazines and ARRL publications provide plenty of antenna building ideas. MFJ Enterprises offers good value in simple ready-to-use antennas for 6 Meters.

Stage TX: Transmitter Buffer, Driver and Final

The transmitter section, Q10, Q9 and Q8, is conventional VHF RF circuitry that has proven quite reliable in Ramsey transceivers. Just a few circuit notes are in order.

Transistor Q10, the transmit Buffer, amplifies the VCO output from C56 to about 10 milliwatts, quite sufficient for checking modulation and PLL alignment in transmit mode as soon as this stage is built. Operating bias is supplied by the PLL lock detect voltage from U5B through R110. If the PLL unlocks, Q10 does not operate, preventing the radiation of out-of-band signals.

The 2N3866 Driver, Q9, amplifies the output of Q10 to drive Q8 to its full rated output. Q8, the popular MRF237 or its equivalent, has physical characteristics that the builder should understand. Many RF transistors of this style have the Collector lead common to the case. Through sophisticated insulating technology, the Emitter lead is common to the case. There is significantly better gain because there is no emitter lead length to speak of. *This relatively small transistor package can handle large power dissipation IF the case is properly soldered to the groundplane of the PC board as detailed in the assembly instructions.* The transistor is fully intended by the manufacturer to be heat-sunk in this manner: don't worry about soldering heat damaging the device.

DO NOT install any transmitter parts without at least reading over the assembly details first and the reasons for the sequence that we have recommended. The PIN T-R diodes D7, D6 and D2 are discussed in section DR. In brief review, D7 passes RF to J3 during transmit while D2 and D6 protect the receiver RF input. The antenna input is designed for a 50 ohm resonant antenna. C75 and C74 are tuned for maximum RF output (4 to 6 watts). These adjustments are part of final transmitter alignment.

Maximum RF output depends critically on following the coil winding instructions EXACTLY in Stage "TC".

Stage TX: TRANSMITTER SECTION ASSEMBLY:

Install the components in the order recommended and DO NOT under any circumstances connect DC power to the unit unless instructed to do so at a particular point. The following assembly steps presume that Stage "TC" (RF coil and choke preparation) was done. Refer to "TC" if you have any question on these parts, which also may be built up as you proceed.

IMPORTANT:

DO NOT install any parts near Q8 until after Q8 has been installed in accord with the explicit directions in Step TX2. If you fail to observe this caution, it will be virtually impossible to perform the installation of Q8 correctly.

DO NOT INSTALL L9, R32 or L10 UNTIL AFTER ALIGNMENT HAS BEEN COMPLETED.

Stage TX: Transmitter, Buffer and Final Amplifier

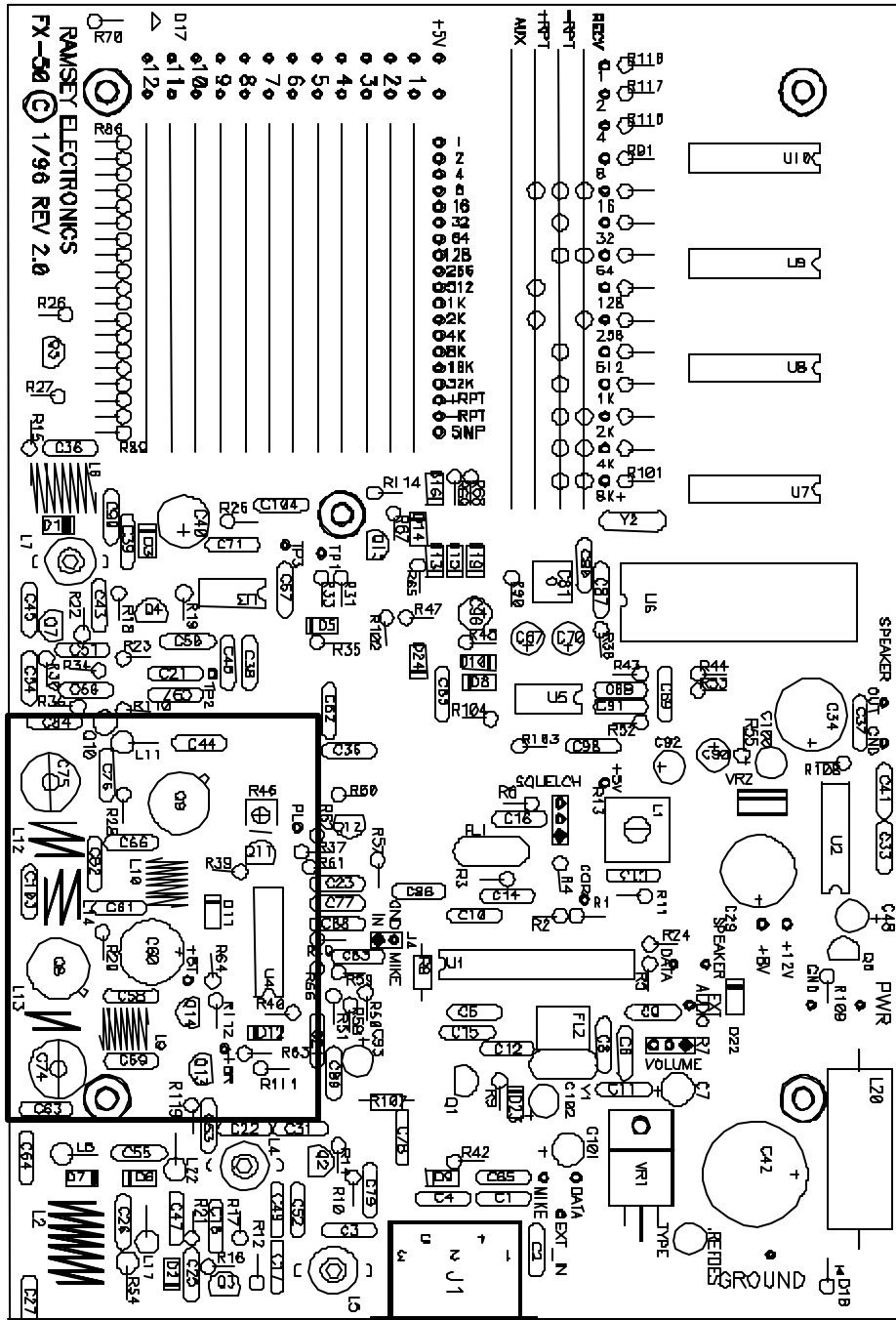

VHF PACKET DATA OPERATION

Your FM transceiver was planned and designed to accommodate easy and reliable VHF packet radio operation.

The J1 Packet I/O port can be quickly connected to many modern TNC's and the Ramsey P-IBM or P64 Packet Modems with Radio Shack's shielded DIN cable (42-2151). Otherwise, your first step is to prepare a reliable 5-conductor cable with a 5-pin DIN plug (RS 274-003) at one end, and the correct connector needed by your packet TNC at the other end. If you salvage a "ready made" 5-pin DIN cable from something like a discarded computer joystick, be sure that there are indeed 5 wires, or at least the ones that are required by your TNC!

Consult your Packet TNC or Packet Modem documentation for ALL details on hookup and operation. Pin 4 of J1 offers a choice of amplified and squelched (speaker level) audio output or low-level (discriminator) output. This choice is set up by the jumper wire positions clearly visible on the PC board.

Packet RX Audio Jumper: Some TNC's require low-level audio from the discriminator output of the FM detector, while others will accept speaker output. Either is available in the FX transceivers. Simply install a jumper in the appropriate location near VR1, to connect "EXT AUDIO" to either "SPKR" for speaker audio or "DATA" for discriminator audio. Use scrap resistor wire to make the jumper. You also can choose to wire these three points to a miniature SPDT switch which you can mount on the rear panel near the packet connector. OR, use a PC mount switch in the jumper area itself.

Use this space to diagram your TNC cable connection:

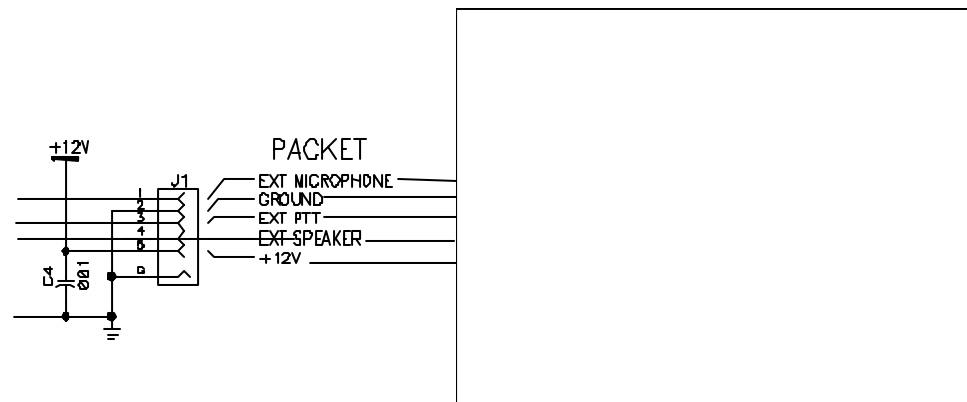

DRAW YOUR TNC

RAMSEY FX-SERIES FM TRANSCEIVER
(With emphasis on the PLL and VCO)

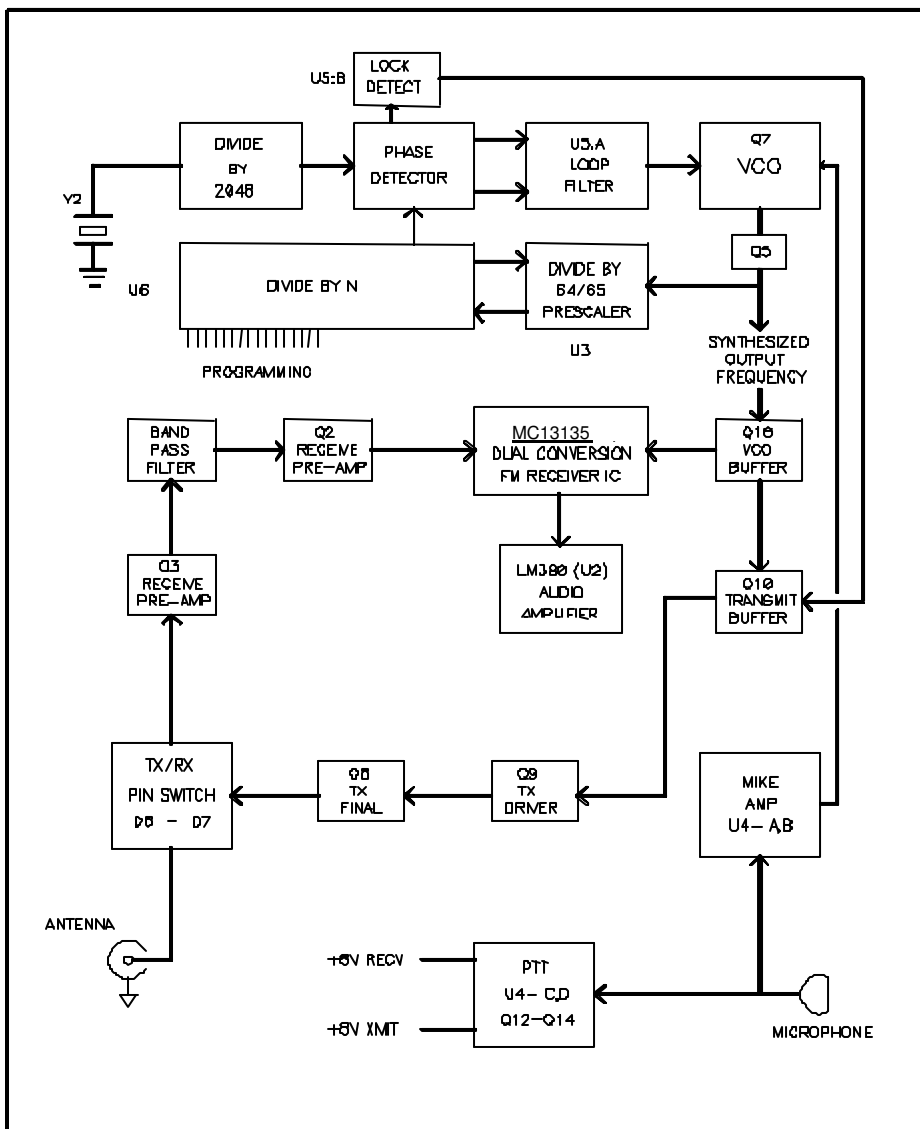

Assembly Stage "TO": Programming Standard Repeater Offsets (-1.0 and +1.0 KHz)

If you did not go ahead and do so when setting up the PLL Synthesizer for receiver testing in Stage "H", now would be a good time to install the diode programming for the standard transmit offsets. We discuss Auxiliary or Non-Standard offsets in the Reference section of this book (page 34-36). The following programming will set up your transceiver for normal 6 Meter band operation, still leaving the AUX line for programming one non-standard split. If you have an unusual application requiring more than one non-standard split, you will have to give up one or more standard + or - 1.0 MHz splits.

- ✍ TO1. Referring back to Stage "H" as needed, prepare three 3" long diode bridges for the offset matrix.
- ✍ TO2. Install these 3 bus wire bridges in the -RPT, +RPT, and AUX lines.
- ✍ TO3. For - 1.0 MHz TX offset, install 9 diodes in the positions clearly marked for the -RPT line:

8 16 32 256 512 1K 2K 4K 8K

REMEMBER: position cathode (banded) ends down!

- ✍ TO4. For + 1.0 MHz TX offset, install 3 diodes in the +RPT line:

8 64 128

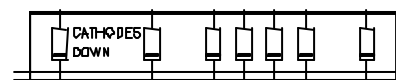

Assembly Stage "TC": Transmitter Coil & RF Choke Preparation

A few parts need handmade preparation before installation in the transmitter RF stages of your transceiver. We recommend that you get them ready for installation before wiring the Driver and Final stages. If you prefer to proceed with those stages, winding coils as you go, that's fine, too, as long as you realize that all coil making details are provided in this section.

The wire used for this is the tinned "bus" wire supplied with your kit. If you mess up, you can get a whole 50' spool of it from Radio Shack (278-1341).

- ✂ TC1. WINDING L12 and L14: Use the heavier gauge wire in your kit for these coils, the same wire that was used to make the diode programming bridges. Wind these two coils on the threads of the 5/16" X 18 bolt to assure perfect forming of the coils. (You wondered what that big bolt was for, didn't you?) Each coil is 2 1/2 turns and will appear to have 3 turns if viewed from the top. Study the PC board silkscreen to help you visualize them.
- ✂ TC2. Winding L2 and L3: Using the same wire and 5/16 bolt, wind two 7 1/2 turn coils for L2 and L3. They appear to be 8 turns if viewed from the top.
- ✂ TC3. WINDING L13: Using the same wire and process as above, wind a 1 1/2 turn coil for L13. It will appear to be 2 turns if viewed from the top.

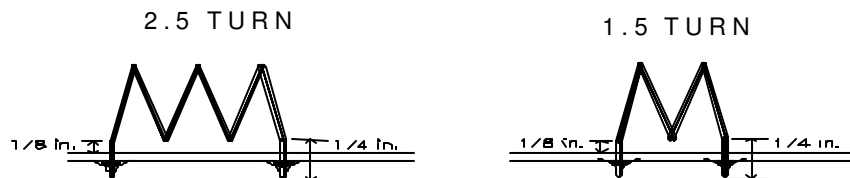

The legs or leads for inserting these coils should be 1/4" long. The coil should sit 1/16" maximum above the PC board groundplane. Keep these coils handy for later installation.

FX-50 CIRCUIT OVERVIEW

The FX-50 VHF FM Transceiver circuit theory is explained in progressive stages and in some detail as part of our "Learn As You Build" approach to electronic kits. Builders are encouraged to study and learn about a stage or section, build it and then test it before going to the next stage. The circuit explanations are necessarily written for people with all levels of experience, starting with and FAVORING beginners.

Following is a straight and "minimally chatty" synopsis or overview of FX-series technical information provided in the building stages. However, we'll still follow the same stage-by-stage designations of the building process.

A: DC Power Input

Much of the circuitry operates on the regulated 8 volts supplied by voltage regulator VR1. "+8R" or "+8T" are points where the regulated 8V output is switched for Receive or Transmit by the PTT circuitry (Q12, U4c, U4d, Q13, Q14).

The Receiver IC (U1) and the digital frequency synthesis circuit are powered by +5 volts regulated by VR2. The op amps used in the circuit (U4 and U5) operate from this single supply through the use of voltage divider networks at the respective IC's. The full 12-15 volt input is supplied to the transmitter RF output section and to the audio amplifier (U2).

Components L20 and C42 provide ignition noise filtering. The 5-pin DIN Packet I/O Jack (J1) has pinouts corresponding to current conventions for TNC's. Receiver audio to pin 4 may be taken from the amplified speaker output, or from the FM discriminator output or from the true FSK data output of U1. Selection is by a jumper wire on the PC-board.

B: Receiver Audio Amplifier

The LM380 is a self-contained general purpose audio amplifier capable of over 2 watts audio output with a voltage gain of 50. Audio from the FM discriminator (U1) is fed through C7 through the 10K volume control (R7) to pin 2, the amplifier input. The amplified output at pin 8 is available through C34 to both the speaker jack and pin 4 of the Packet I/O Jack. C41 in series with R108 across this amplified output are good practice recommended to prevent self-oscillation of the IC. Pin 1 is bypassed to ground through C48 in normal operation.

If pin 1 is grounded directly, the internal bias of the LM380 is upset, and the amplifier is silenced. Q6 is a simple switch. When 8 volts is applied through R107 and D22 to the base of Q6, the transistor collector grounds pin 1 of U2, thus silencing the receiver during transmit. The COR output of U1 (pin 16) also mutes the amplifier.

- ✂ M37: R70, near front of PC board by the diode matrix, 1K (brown-black-red).
- ✂ M38: Install the LED transmit indicator, D17. Correctly identify the anode side lead which is the longer of the two. Install the LED with full lead length extending above the board so that the LED can be positioned in the front panel hole.
- ✂ M39: Prepare two 11" wires (or 11" of 2 conductor wire) by stripping back each end 1/8" and tinning with solder and solder one end of each to IN and GND (MIC) between C86 and U1.

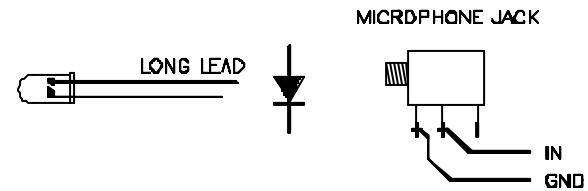

- ✂ M40: Study microphone jack J4 and the above drawing. Solder the other two wire ends to the jack lugs as shown.

STAGE M PROGRESS TEST

1. Remove the jumper wire between "+8R" and "+8V".
2. Check the PC board for wire scraps, untrimmed leads, etc.
3. Connect an ICOM compatible speaker-microphone to the Mic jack.
4. Connect DC power, antenna and speaker.
5. Turn the power switch 'ON' and verify that receiver still works properly.
6. Select a steady signal or turn the squelch control so that the background noise is audible.
7. Press the microphone button: the TX LED should light, and the receiver should be silenced.
8. Touch a wire from ground to pin 3 of the Packet I/O jack. Do the same with any resistor that is 47K or lower. Either way, you should get the same results as in Step 6.
9. Disconnect the DC Power.

OPTIONAL:

Interested builders might wish to verify microphone amplifier operation at PC board point "PL" before proceeding, but such a test is not essential at this point. Simply connect a utility test amp to "PL", press the mike button and talk!

- ✂ M18. Install Q11, NPN transistor type 2N3904. Be sure to orient flat side as shown.
- ✂ M19. Identify and install R46, the yellow color modulation control trimmer potentiometer. It differs from trimmer capacitors by having three terminals. Simply place it in position and solder all three points.

NOTE: The remaining three transistors used in this section are PNP types, 2N3906 or similar, marked 228256. It is essential to use the correct transistor type for Q12, Q13, Q14.

- ✂ M20. Install Q12, PNP transistor type 228256. Orient flat side as shown.
- ✂ M21. Similarly, install Q13, PNP type 228256.
- ✂ M22. Install Q14, PNP type 228256. Install the following additional parts:
- ✂ M23: R60, near Q12, 10K (brown-black-orange).
- ✂ M24: R62, also 10K (brown-black-orange).
- ✂ M25: R111, near Q13, 4.7K (yellow-violet-red).
- ✂ M26: R40, 100K (brown-black-yellow).
- ✂ M27: R63, 470 ohms (yellow-violet-brown).
- ✂ M28: R64, also 470 ohms (yellow-violet-brown).
- ✂ M29: R112, 4.7K (yellow-violet-red).
- ✂ M30: R39, near Q11, 47K (yellow-violet-orange).
- ✂ M31: Install diode D11, 1N914/1N4148. Orient the banded end as shown.
- ✂ M32: Similarly, install diode D12, another 1N914/1N4148.

IMPORTANT: The following parts are located in areas of the PC board that have already been assembled. If the ham in you pursued an assembly sequence different from these step-by-step directions, you may already have soldered in these parts. If so, no harm is done. Be certain now, though, that the following are installed:

- ✂ M33: R107, 10K ohms (brown-black-orange).
- ✂ M34: Diode D22, type 1N914 or 1N4148, near VR1. Orient the banded end correctly. (+8T through R107 and D22 turns on Q6 to mute the audio amp IC during transmit).
- ✂ M35: C62, near Modulation pot, R46, .001 uf.
- ✂ M36: R35, 100K (brown-black-yellow).

Stage CR: Integrated FM Receiver

The MC13135 is a complete FM narrowband receiver from antenna input (pin 22) to audio output (pin 17). The low voltage dual conversion design results in low power drain, excellent sensitivity and good image rejection in narrowband voice and data link applications. The FX-50 implementation of this IC yields increased image rejection by using a 21.4 MHz first IF rather than the traditional 10.7 MHz. A precision 2-pole crystal filter (FL1) is used for the 21.4 MHz first IF.

Our design injects the PLL controlled VCO output through C35 to pin 2 rather than using U1's internal local oscillator circuit. The VCO input to pin 2 is mixed with the RF input from the antenna circuitry.

The first mixer amplifies the signal and converts this RF input to 21.4 MHz. This IF signal is applied to the second internal mixer via pin 18, where the 2nd IF frequency of 455 KHz is achieved by mixing with the 21.855 MHz oscillator. The oscillator circuit is internal to U1; the crystal is Y1, 21.855 MHz.

The 455 KHz second IF output (pin 7) requires filtering. We used a precision ceramic 455 KHz filter with 6 poles for a 2nd IF filtering scheme designed to solve the adjacent- frequency swamping effect experienced with many handhels costing much more.

The receiver has good "hysteresis" characteristics, the ability to hold the squelch open once it has been broken by a marginal signal, even if the signal becomes weaker. The squelch is activated by signal strength, not by noise.

R13 permits squelch adjustment. Finally, the carrier detect circuitry affords the same COR ("Carrier Operated Relay") action as needed in any repeater, which is why the output of pin 16 is also available on the PC board, designated "COR."

Stage DR:

Antenna Input and RF Preamplifier: At Antenna jack J3, C20,26, 27, 28, 30, and L2, 3 form a low pass filter, The filtered signals are coupled through a pin diode T/R switch to Q3, a 2SC2498, favored for its high gain and low noise (18 db gain, .9 db noise figure).

Front-end components C17, L4, C27, L5, C49, C52, and C31 form a BANDPASS filter, which sets both upper and lower limits on the RF passing from Q3 to Q2 for further amplification and coupling via C78 to U1, pin 22.

The PIN diodes, D2, D6 and D7, perform all RF T-R functions. PIN diodes can pass RF energy either way when turned on by DC voltage and also block RF from the other direction when not powered by DC. During Receive, D6 is "on" and permits RF to flow from the antenna through C47 to the amplifier stage just discussed. Because any DC device needs a ground

connection as well as +DC, D6 is grounded through RF choke L17, which prevents the antenna RF from being shorted to ground.

During Transmit, D7 passes RF from the transmitter to the antenna, and L17 again prevents loss of RF to ground. During transmit, D6 is blocking transmitter RF from the receiver circuit. For maximum protection of the more delicate receiver circuit, D2 is turned on during transmit to ground any stray RF.

Stage E-F The FX Transceiver VCO

The VCO (Voltage Controlled Oscillator) provides basic frequency control for both transmit and receive modes. It is essential to understand its function in the transceiver circuit. Q7 is the oscillator transistor. L7, D3 and D1 are key VCO components.

After the VCO is assembled on the PC board, the interested builder is given the option of experimenting with it in receive mode before working on the PLL synthesizer. This is done by applying a variable DC control voltage through a pot to TP1. Otherwise, TP1 is available for checking VCO control voltage during initial alignment. TP2 permits checking VCO frequency output with a frequency counter. TP3 permits checking the output of the 12017 Å64/65 dual modulus prescaler (U3)

The control voltage for D3, the varactor diode is supplied through R47 and R25 by the output of U5:A in the PLL synthesizer circuit.

There must be a 21.4 MHz difference between the receive and transmit frequencies of the VCO. This swing cannot be accomplished by PLL programming alone. The VCO must be able to stay "in range" with the synthesizer. PIN diode D1 shunts the additional series inductor L6 when in transmit mode, by the action of transistor switch Q5. In receive mode, D1 is turned off, allowing L6's inductance to be added in series with the VCO tunable coil L7. This additional inductance allows the VCO to tune lower in frequency.

The VCO output is fed into U3, MC12017P, a dual modulus Å64/65 prescaler, the output of which is fed to the A and N counters in U6. The output is also routed through C35 for receive, and Q10 through C56 for transmit.

The VCO is is frequency modulated by microphone amplifier U4. D5 and R31 perform an interesting function. Remember that the VCO control voltage has a range of about 1.0 volts DC (low frequency) to 7.0 volts (high frequency). Therefore, more modulation voltage is needed at the higher frequencies. As the VCO control voltage increases, D5 turns on and places R31 in parallel with R33, reducing the resistance in the line to half and thereby increasing available modulation voltage.

R70 limits the current drawn by D17 to a safe level. This LED usefully assures that the otherwise-silent PTT circuitry is indeed functioning and obviously has nothing to do with the RF output of the transmitter.

The PTT circuit may also be activated at pin 3 of the Packet I/O jack. A direct short to ground is not necessary. The author noted very positive PTT action with resistance as high as 100K from pin 3 to ground. This is a highly reliable and efficient PTT system provided that careful attention is given to correct selection and installation of all parts: resistor values, PNP transistors, zener diode orientation, U4 installation, correct wiring of microphone jack.

Stage M: ASSEMBLY PROCEDURE:

Install the following parts:

- ✂ M1: C86, .001 uf.
- ✂ M2: C83, .001 uf.
- ✂ M3: C88: .001 uf.
- ✂ M4: C77, .001 uf.
- ✂ M5: C23, .001 uf.
- ✂ M6: R57, 2.2K (red-red-red).
- ✂ M7: R59, 100K (brown-black-yellow).
- ✂ M8: R58, 270 ohms (red-violet-brown).
- ✂ M9a: R50, 10K (brown-black-orange).
- ✂ M9b: R49, 10K (brown-black-orange).
- ✂ M10: R51, 47K (yellow-violet-orange).
- ✂ M11: R56: 47K (yellow-violet-orange).
- ✂ M12: R61: 2.2K (red-red-red).
- ✂ M13: R37: 100K (brown-black-yellow).
- ✂ M14: C93: 4.7 or 10 uf. (Watch polarity!)
- ✂ M15: C89: .001 uf.
- ✂ M16: C24: .001 uf.
- ✂ M17. Install U4, a 14 pin DIP IC, type LM324, which contains all 4 op amp sections of this circuit. Orient the notched end as shown on the board. If you elect to provide a DIP socket, use the same care as in soldering the IC itself.

Stage M: Microphone Amplifier and PTT Circuit

If you have studied all preceding circuit explanations, you have a good idea of what the Microphone and PTT circuitry is supposed to accomplish. Understanding our design clearly and assembling it correctly will save many headaches and will ensure reliable FX transceiver operation.

U4 is a "quad op amp" which means 4 operational amplifiers in one DIP package. Two are used as a conventional microphone gain amplifier, and the other two are used in the PTT (push to talk) circuit.

Capacitor C83 couples microphone audio to U4A and isolates the audio (AC) from the PTT circuitry (DC). Op amps are designed to run from both a positive and a negative voltage source. U4 is powered by a single +8V supply through the use of a voltage divider network (R59, R40). The gain of the amplifier is established by the ratio of R56 to R58. A passive low pass filter is formed by R51 and C89. The B section of U4 and its associated components form an active low pass audio filter. The output of U4B is fed through C62 to modulate the VCO control voltage as explained in Stage E-F. Trimmer R46 permits adjustment of modulation level.

The purpose of Q11 is to shunt the microphone circuit straight to ground during receive, so that it cannot possibly disturb the VCO. An accessory modulation input is provided at PC-board point "PL" for direct injection of DTMF or CTCSS tones, etc.

The PTT circuit is designed to accommodate the popular ICOM-compatible speaker-mikes. Notice that a single line at J4 serves both audio and PTT functions. The one shielded wire into the microphone takes care of not two but three functions which could involve three conductors and a more complex jack.

Three functions? First, we need to supply audio output from the microphone element to the amplifier. Next, we need some kind of PTT switching connection. Third, the electret microphone itself needs a small amount of voltage to operate its internal FET source follower transistor.

Here's how we do it with one mike line. Pushing the button simply connects the microphone element to the line. About 2 volts through R60 and R57 operate the microphone element which sends audio through C83 to U4A. PNP transistor Q12 senses the tiny current draw of the microphone element and switches the 8 volts at the emitter through to the collector. To state it very simply, the output of U4 turns off PNP Q13 which had been supplying 8 volts to all "+8R" points of the circuit. And the output of U4C switches on PNP Q14 to supply all "+8T" points.

Diodes D11 and D12 assure positive action, that Q13 and Q14 are fully on or fully off when the op amp outputs swing. Releasing the mike button instantly reverses the status of Q12, Q13 and Q14 to return to receive mode.

The VCO requires a very pure source of well-filtered DC, free of AC hum, alternator whine or other disturbance. R19 and the 47 uf C40 form a basic low pass filter. Transistor Q4 serves as an electronic capacitance multiplier. The actual effect of the filter is that the beta of Q4 multiplies the 47 uf for a virtual capacitance effect of a much larger device.

Stage G: The FX- Transceiver Synthesizer PLL

The MC145152 IC incorporates the equivalent of 8000 individual transistors and contains the following circuits:

- ? A crystal reference oscillator governed by Y2, 10.24 MHz.
- ? A counter or "frequency divider" circuit set externally to divide the crystal oscillator output by 2048, for a Reference Frequency output of 5 KHz.
- ? A second counter or frequency divider that divides the frequency from the Prescaler (U3) by the externally programmed number that we call "N".
- ? A third frequency divider ("A") also used for programming
- ? Control logic circuitry which permit the "N" and "A" counters to work together for channel programming.
- ? The Phase Detector (or "phase corrector") which compares the 5 KHz Reference Frequency with the "intended" 5 KHz output of the N-divider and sends correcting pulses to the VCO to keep the output of the N-divider right at 5 KHz.
- ? A "lock detect signal" circuit. The reference oscillator is internal to U6, governed by Y2.

The precision of the 10.240 MHz reference oscillator can be adjusted by trimmer C81. The R divider feeds 5 KHz to the phase detector section of U6 (10240 KHz divided by 2048).

The output of the MC12017, Æ64/65 prescaler U3 is AC coupled via C57 to pin 1. U3 is a dual modulus prescaler, controlled by pin 9 of U6. The prescaled output of the VCO is fed to the A and N counters. The "N" number programmed on the diode matrix is predetermined to divide this frequency down to 5 KHz for phase comparison with the 5 KHz output of the crystal controlled reference divider. Maximum "N" is 65,535, achieved by switching on all 16 parallel inputs.

Unlike simpler PLL IC's, U6's phase detector has TWO outputs at pins 7 and 8. These outputs go through very simple low pass filters (R44-C68, R53-C91) to cut back the 5 KHz whine sound of U6 at work. Op amp U5:A sums together the phase detector outputs and the output of U5:A is passed through a network of 2.2 uf electrolytic capacitors (C67,70,90,92) to smooth out the phase detector pulses to clean DC for controlling the VCO.

R48 and C85 form yet another low pass filter to ensure that any 5 KHz

FREQ.	N =	BINARY PROGRAMMING VALUES			
50.000	10,000	0010	0111	0001	0000
54.000	10,800	0010	1010	0011	0000

"whine" will not get into the VCO. Because the DC charge developed in C85 (.1 uf) would slow down the PLL during major frequency swings, such as just going from transmit to receive, D8 and D10 are set up back-to-back across voltage dropping R48. Whenever there is a major frequency shift (which means a significant VCO control voltage change), one way or the other, one diode or the other is switched on to short out R48 and discharge C85. This lets the PLL recharge and the diodes become no factor in the circuit.

$$\frac{52525 \text{ (KHz)}}{5 \text{ (KHz)}}$$

The lock detect output (pin 28) gives a strong series of pulses when the PLL is unlocked. When the PLL is locked, only a tiny sawtooth wave appears at pin 28. The "lock detect" voltage is watched by U5:B. If "unlock" pulses appear, they are integrated through R90 and C96 as a fairly clean DC voltage charge built up in C96. If this charge causes U5B to swing low, bias is removed from Transmit Buffer Q10, preventing transmitter damage and unwanted emissions.

Stage H: The Diode Matrix and PLL Synthesizer Programming

There are two diode-matrix programming areas on the PC board. The obviously larger area is for frequency channel programming. The second space is for offset programming added in by U7-U10.

The 19 100K resistors at the frequency programming matrix and the 14 100K resistors at the offset matrix are "pulldown resistors," to ensure positive logic switching action of U6.

Q15 and its associated switching diodes ensure that the desired offset is switched in during transmit, that offset programming does not interfere when simplex is desired and that the offsets do not interfere with receiver operation and that receiver programming (21.4 MHz lower) does not interfere with transmit operation.

A variety of techniques are possible for binary programming of U6's 16 parallel inputs. We focus on the diode programming approach with some brief suggestions on externally-controlled switching. It is very intentional on our part to leave innovative programming schemes up to FX transceiver users, because there's no single best way to do it for everybody.

There are several methods for quickly finding the required binary code for a

Stage M: Microphone Amplifier and Push-to-Talk Switching

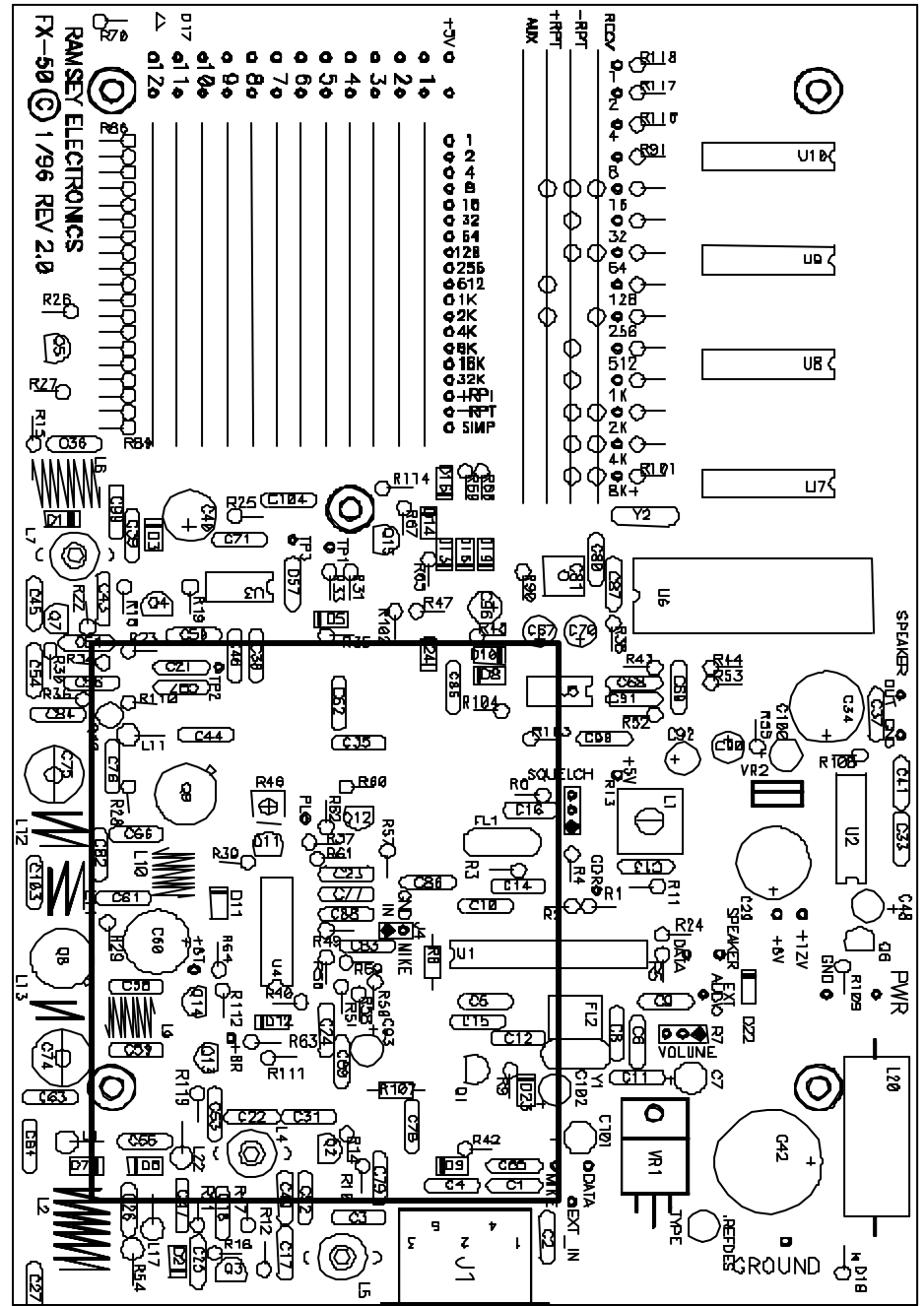

4. Set frequency to the channel you selected for 52.525 MHz Simplex.

particular frequency and its "N" number:

1. Descending Subtraction (see Programming Worksheet)
2. Printed reference lists (see Popular 6 Meter Frequency Pairs)
3. Computer programs (see our sample BASIC program)

We recommend strongly that you fully understand how to make the calculation yourself, because that is your ONLY means for checking the accuracy of printed information, computer programs or the operation of experimental programming circuits. Even though there are 16 matrix positions to program, there are some shortcuts to make the job easier for normal ham band operation. Consider the upper and lower band edges. Notice the values of the highest 4 and lowest 2 positions are the same throughout the band. We still must program in those six positions but we only need to calculate for the remaining 10 (512 through 1) to program any 6 meter frequency desired. The simplex calling frequency of 52.525 MHz is the demonstration and alignment standard for the FX-50 model.

"N" is quite easy to determine:

$$\text{"N" for 52.525 MHz} = \quad = 10505$$

The placement of diodes in the Programmable Offset Matrix follows the same binary number principles as used for frequency programming. This matrix is connected to the 16 programming inputs of U6 through the four 4 bit binary adders (U7-U10). Fewer programming positions are provided on the board simply because there is no practical use for extremely large or very tiny offsets. The 1 bit to 8K range provides plenty of flexibility for non-standard channel spacing.

U7 through U10 are called "4 bit" binary adders because they each can handle four binary addition operations. For each bit, there are A and B inputs and one S (sum) output. Examine the schematic diagram closely, and you will see that all the frequency programming lines are connected to "A" inputs and all offset lines go to "B" inputs. Notice further that the binary positions of both matrixes correspond to each other exactly: the 8K offset position goes to B1 of U7 and the 8K frequency programming position goes to A1. Their sum appears at S1 (pin 1) and goes to U6. And so forth for all the other binary programming positions.

The programming for receive mode and standard repeater offsets is silk-screened on the PC board itself. Assembly Stage H explains the theory behind these positions. The +RPT "N" numbers are calculated in the same way as for the Frequency Programming matrix. -RPT, RECV and other "minus" offsets are calculated by straightforward "2's Complement" binary addition. See Stage H for examples.

Stage M: Microphone Amplifier and PTT Circuit

U4 is a LM324 quad op amp: two are used as a conventional microphone gain amplifier, and the other two are used in the PTT (push to talk) circuit.

Chart:

'X' indicates the installation of a diode in that position. Each one of these channels also requires a diode installed at the 'Simplex' position. Before installing diodes, please be sure that you understand the principles of binary programming explained in detail in the first pages of this Section.

In lieu of constructing diode bridges and wiring the channel selector switch, you may elect to build your own switching system, using DIP, slide or toggle switches. Do such projects only after your transceiver is finished and working.

- ✍ Channel Switch S2 may be installed at whatever point in the procedure that is most convenient for you. Its purpose is to apply +5V to the desired diode bridge. Connect the desired channel positions on the switch to corresponding matrix channel rows using 2" lengths of hookup wire.

CHANNEL SWITCH

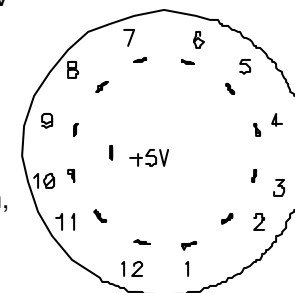

- ✍ For all channels installed at this point that you intend for actual 6 Meter band communication, remember to install a diode in the correct position for Simplex, +RPT or -RPT. Install in only one position for any given channel. Remember that the Receiver Frequency corresponds to a repeater's output and that you are using +RPT or -RPT to match the repeater's input frequency.

There is no need for diodes in the Simplex, +RPT or -RPT on any channel intended only for listening. Also, be aware that omitting these diodes does not completely disable transmitting capability. *Be VERY careful and use common sense when monitoring outside the ham band.*

RECEIVER ADJUSTMENT AND OPERATION

At this point, we assume that all preceding assembly steps have been completed for stages "A" through "H" and that Stages "M" and "TX" associated with the transmitter have NOT been done. A jumper wire is still in place between "+8R" and "+8V." All IC's are installed except U4.

Adjustment Procedure:

1. Check PC board carefully for missed connections, wire trimmings or untrimmed wires bent down, etc.
2. Connect speaker and DC supply voltage.
3. Obtain or make a non-metallic alignment blade capable of adjusting L7 and C81.

We have reached the mountain-top in building the RECEIVE section of your transceiver as well as many sections or stages needed for transmitting and receiving. Double-check your work as needed.

Frequency Programming and Channel Switch Preparation

Before completing the transmit functions of this VHF FM transceiver, we should now verify that the PLL Frequency Synthesizer gives performance as desired and as designed. Regardless of whether you pursued the VCO/receiving tests proposed as optional in the previous section, it is now time to put your completed receiver section through its paces.

In order to do this, one or more receiving frequencies must be programmed on the primary matrix. If you already have a firm plan for how you wish to program some or all of the channel positions, you can proceed with making the frequency programming lines that you are sure about. If you have little or no sure idea of how you want to set up the channel selector switch, you can build up a simple switching system that will let you try any frequency of your choice.

- ✍ H43. If you are unsure of what frequencies to program, we suggest the following to get started:
 - ? Channel 1: 52.525 MHz Simplex (national calling frequency)
 - ? Channel 2: One additional simplex frequency
 - ? Channel 3: Main repeater of your local radio club
 - ? Channel 4: One additional repeater in your area

Add more channels as you become more familiar with 6 Meter band operation in your area. You can change or delete any of these frequencies whenever you wish.

Note: Your PC board silkscreen may show diode placements that differ from your calculated placement. Place diodes where you have calculated their position to be, and ignore any silkscreen that does not agree with your diode placement.

Freq (MHz)	32K	16K	8K	4K	2K	1K	512	256	128	64	32	16	8	4	2	1
52.525			✍	✍	✍			✍		✍			✍			✍

- ✍ H44a. Construct at least two diode bridges for frequency programming as illustrated.
- ✍ H44b. Install 2 or more diode bridges in the channel rows of your choice.
- ✍ H45. Install programming diodes for two or more channels per the following guide or per your own calculations or our Quick-Reference

Using the FX-series FM Transceiver Quick Reference Programming Guide:

In addition to "pencil & paper math" calculation directions and also a handy computer BASIC program for programming the FX-series Transceiver for any frequency and transmit offset within its specified range, we provide this guide for binary programming of a variety of popular Repeater frequency pairs as well as some other frequencies of general interest. All binary programming data for 2048 through 4 presumes prior diode programming of both the higher level binary inputs and the lower order binary inputs which remain constant for the 6 meter amateur radio band:

32K	16K	8K	4K	(2K through 4 on chart)	2	1
0	0	1	0	see charts	1	0

You'll notice definite patterns in the standard repeater frequency assignments and their binary equivalents. Look at these patterns up and down the programming input rows as well as across for any given frequency. If your application could use more than the 12 channels easily programmed for front panel switching, perhaps these patterns will give you some good ideas for additional channel switching convenience.

FX-50 Quick Program Reference

Standard 6 Meter band repeater pairs and selected frequencies

Program as follows:

1. Install diodes at the 8K and 2 positions.
2. PLUS install diodes at 2K through 4 positions as needed per this Quick Reference Chart.
3. For repeater channels, add the ' - RPT ' diode (since 6 meter band repeaters are minus offset). Simplex channels: add the 'SIMP' diode.
4. A '1' means to install a diode, '0' means NO diode.

Frequency	N	2K	1K	512	256	128	64	32	16	8	4
53.01	10,602	1	0	0	1	0	1	1	0	1	0
53.03	10,606	1	0	0	1	0	1	1	0	1	1
53.05	10,610	1	0	0	1	0	1	1	1	0	0
53.07	10,614	1	0	0	1	0	1	1	1	0	1
53.09	10,618	1	0	0	1	0	1	1	1	1	0
53.11	10,622	1	0	0	1	0	1	1	1	1	1
53.13	10,626	1	0	0	1	1	0	0	0	0	0
53.15	10,630	1	0	0	1	1	0	0	0	0	1
53.17	10,634	1	0	0	1	1	0	0	0	1	0
53.19	10,638	1	0	0	1	1	0	0	0	1	1
53.21	10,642	1	0	0	1	1	0	0	1	0	0
53.23	10,646	1	0	0	1	1	0	0	1	0	1
53.25	10,650	1	0	0	1	1	0	0	1	1	0
53.27	10,654	1	0	0	1	1	0	0	1	1	1
53.29	10,658	1	0	0	1	1	0	1	0	0	0
53.31	10,662	1	0	0	1	1	0	1	0	0	1
53.33	10,666	1	0	0	1	1	0	1	0	1	0
53.35	10,670	1	0	0	1	1	0	1	0	1	1
53.37	10,674	1	0	0	1	1	0	1	1	0	0
53.39	10,678	1	0	0	1	1	0	1	1	0	1
53.41	10,682	1	0	0	1	1	0	1	1	1	0

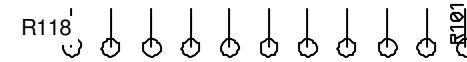

- H22-40(a). Install the 19 100K resistors (brown-black-yellow) required for R71-R89. Once again plan careful soldering procedure and install the parts.



- H41. Form one diode matrix "bridge" for the RECV row of holes. Using the heavier gauge bare wire in your kit, shape, insert and solder this wire bridge as illustrated.
- H42a. Select seven (7) diodes from the master supply of 1N914 or 1N4148 switching diodes provided with this transceiver kit.

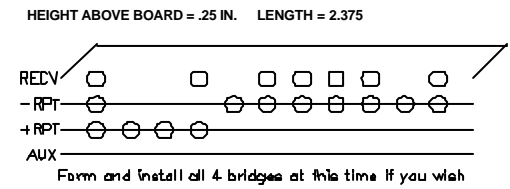

- H42b. Set the PC board across two small boxes, blocks, cups or any objects which provides a couple inches of clearance between the bottom (solder side) and your work surface.
- H42c. Stand the CATHODE (dark band) ends of the seven diodes down into these positions (only) on the RECV row of the smaller matrix:
 [] 8 [] 64 [] 256 [] 512 [] 1K [] 2K [] 8K
- H42d. Join, solder and trim the 7 RECV diodes so that all seven anode wires are neatly connected to the RECV bus wire "bridge" installed in Step H41.

- H42e. Solder all 7 RECV line diode cathodes on the solder-side of the PC board. Trim excess wires.

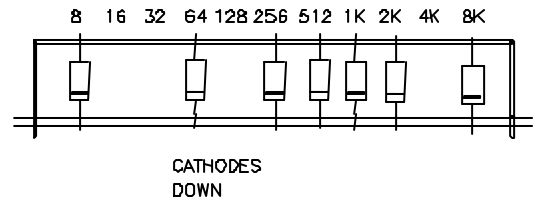

Stage H: PROGRAMMING MATRIX ASSEMBLY

There are two diode matrix programming areas on your PC board. The obviously larger area is for frequency channel programming. The second space is for offset programming added in by U7-U10.

Correct assembly of the following section permits Q15 to switch off all three transmit offset programming lines while receiving, allowing only the RECV programming to be in effect. Be certain to orient the diodes correctly.

Install the following resistors:

- ✍ H1: R68, 1K (brown-black-red).
- ✍ H2: R69, 1K (brown-black-red).
- ✍ H3: R114, 1K (brown-black-red).
- ✍ H4: R65, 1K (brown-black-red).
- ✍ H5: R67, 10K (brown-black-orange).

Install the following diodes, be sure to orient the cathode banded end correctly. (Diodes are type 1N914/1N4148):

- ✍ H6: D19
- ✍ H7: D15
- ✍ H8a: D13
- ✍ H8b: D14
- ✍ H9: D16
- ✍ H10. Install NPN transistor Q15, type 2N3904. Watch correct orientation of the flat side.

Notice that a total of 33 identical 100K resistors (brown-black-yellow) are to be installed in two rows for the two diode matrix areas of your transceiver. If the 100K resistors provided in your kit have pre-shaped and trimmed wire leads, simply press them into place and solder both ends. If the 100K resistors are supplied in the more usual style of a taped strip, all you need to do is work out your own mass-production procedure to get the resistors in place as illustrated. There is no right, better or best way other than the need for clean soldering practice.

- ✍ H11-21(a). Install the 14 100K resistors (brown-black-yellow) required for R91-R101 and R116-118. Plan careful soldering procedure and install the parts.

Frequency	N	2K	1K	512	256	128	64	32	16	8	4
53.43	10,686	1	0	0	1	1	0	1	1	1	1
53.45	10,690	1	0	0	1	1	1	0	0	0	0
53.47	10,694	1	0	0	1	1	1	0	0	0	1
53.55	10,710	1	0	0	1	1	1	0	1	0	1
53.57	10,714	1	0	0	1	1	1	0	1	1	0
53.59	10,718	1	0	0	1	1	1	0	1	1	1
53.61	10,722	1	0	0	1	1	1	1	0	0	0
53.63	10,726	1	0	0	1	1	1	1	0	0	1
53.65	10,730	1	0	0	1	1	1	1	0	1	0
53.67	10,734	1	0	0	1	1	1	1	0	1	1
53.69	10,738	1	0	0	1	1	1	1	1	0	0
53.71	10,742	1	0	0	1	1	1	1	1	0	1
53.73	10,746	1	0	0	1	1	1	1	1	1	0
53.75	10,750	1	0	0	1	1	1	1	1	1	1
53.77	10,754	1	0	1	0	0	0	0	0	0	0
53.79	10,758	1	0	1	0	0	0	0	0	0	1
53.81	10,762	1	0	1	0	0	0	0	0	1	0
53.83	10,766	1	0	1	0	0	0	0	0	1	1
53.85	10,770	1	0	1	0	0	0	0	1	0	0
53.87	10,774	1	0	1	0	0	0	0	1	0	1
53.89	10,778	1	0	1	0	0	0	0	1	1	0
53.91	10,782	1	0	1	0	0	0	0	1	1	1
53.93	10,786	1	0	1	0	0	0	1	0	0	0
53.95	10,790	1	0	1	0	0	0	1	0	0	1
53.97	10,794	1	0	1	0	0	0	1	0	1	0
53.99	10,798	1	0	1	0	0	0	1	0	1	1
<u>Other Simplex Frequencies:</u>											
52.490	10,498	1	0	0	1	0	0	0	0	0	0
52.510	10,502	1	0	0	1	0	0	0	0	0	1

RAMSEY FX-series Programming Worksheet

To convert N from decimal to binary, simply TRY to subtract EACH of the 16 binary values from N, always in descending order, always starting with 32768 and always ending with 1. This process will always yield 16 YES or NO answers, which will give you exact diode installation instructions.

$N = \text{Freq in KHz} \div 5 \text{ KHz}$ (or, $\text{Freq in MHz} \div .005$)

Let's try doing an example. We want to receive 52.525 MHz:

$N = 52525 \div 5 = 10,505$ Now, convert to binary...

Subtracting from N:	Remainders & Doodles	NO	YES	Position
Can you subtract 32768?				32768
Can you subtract 16384?				16384
Can you subtract 8192?				8192
Can you subtract 4096?				4096
Can you subtract 2048?				2048
Can you subtract 1024?				1024
Can you subtract 512?				512
Can you subtract 256?				256
Can you subtract 128?				128
Can you subtract 64?				64
Can you subtract 32?				32
Can you subtract 16?				16
Can you subtract 8?				8
Can you subtract 4?				4
Can you subtract 2?				2
Can you subtract 1?				1
Will this be a Simplex channel?				SIMP
Will Transmit be 1.0 MHz LOWER than Receive?				- RPT
Will Transmit be 1.0 MHz HIGHER than Receive?				+ RPT

Install diodes in YES positions only.

If an auxiliary split is needed or if you are not licensed to transmit in a band portion, do not install diodes in SIMP, +RPT or -RPT positions.

Easy enough! Whenever you want a transmit offset that is higher than the receiver or repeater output frequency, simply find the N number for the offset and program it on the offset matrix.

Here's one more example. Let's say we want a + 1.5 MHz offset.

$1.5 \text{ MHz} = 1500 \text{ KHz}$. $1500 \div 5 = 300 = N$

Converting to binary: (Obviously 300 is less than all values from 8K through 512, meaning that we need no diodes in those positions.)

Can we subtract 256 from 300? YES (Therefore diode at 256)

$$300 - 256 = 44$$

Can we subtract 128 from 44? NO (Therefore NO diode at 128)

Can we subtract 64 from 44? NO (Therefore NO diode at 64)

Can we subtract 32 from 44? YES (Therefore diode at 32)

$$44 - 32 = 12$$

Can we subtract 16 from 12? NO (Therefore NO diode at 16)

Can we subtract 8 from 12? YES (Therefore diode at 8)

$$12 - 8 = 4$$

Can we subtract 4 from 4? YES (Therefore diode at 4)

$$4 - 4 = 0$$

This +1.5 MHz TX offset is set up easily by diodes at 256, 32, 8 and 4!

Programming of Minus offsets is covered in the Reference section of your manual.

ADDITIONAL CIRCUIT NOTES:

The 19 100K resistors at the frequency programming matrix and the 14 100K resistors at the offset matrix are called "pull down resistors" and are required to ensure positive logic switching action of U6.

Transistor Q15 and its associated switching diodes ensure that the desired offset is switched in during transmit, that offset programming does not interfere when simplex is desired and that the offsets do not interfere with receiver operation . . . and that receiver programming (21.4 MHz lower) does not interfere with transmit operation. Obviously, these simple parts must be installed correctly, or major PLL problems would result.

Note: The silkscreen on your PC board may contain diode placement markings that differ from your calculated placement. Always follow your calculated placement and ignore the silkscreen (which could contain errors).

THE RX/TX OFFSET PROGRAMMING MATRIX

Diode placement in this matrix follows the same binary number principles as used for frequency programming. This matrix is connected to the 16 programming inputs of U6 through the four binary adders (U7-U10).

Fewer programming positions are provided on the board simply because there is no practical use for extremely large or very tiny frequency offsets. The 1 to 8K range provides plenty of flexibility for non-standard channel spacing.

U7 through U10 are called "4 bit" binary adders because they each can handle four binary addition operations. For each bit, there are A and B inputs and one S (sum) output. Examine the schematic diagram closely, and you will see that all the frequency programming lines are connected to "A" inputs and all offset lines go to "B" inputs. Notice further that the binary positions of both matrixes correspond to each other exactly: the 8K offset position goes to B1 of U7 and the 8K frequency programming position goes to A1. Their sum appears at S1 (pin 1) and goes to U6. And so forth for all the other binary positions of both matrix areas.

We made it very easy for you to set up the required receiver frequency and standard 1.0 MHz transmit offsets. Simply insert diodes correctly in the holes marked by circles, solder, and you're in business. Here's a reproduced image of the PC Board's matrix area. The silkscreen on the PC board may differ from the diagram below. If so, use the diagram and not the PC board silkscreen. See how the standard offset positions are outlined with circles.

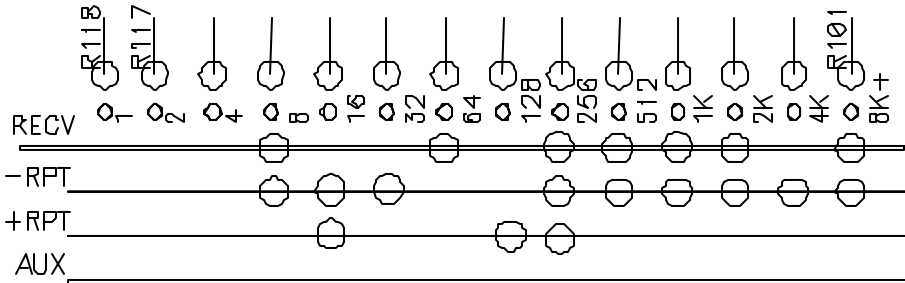

However, it's worthwhile to understand why the diodes are in those positions. Let's work backwards, starting with the actual diode positions and discover why they are put there.

Starting with the easiest, add up the values for the 3 diodes used in the +RPT line:

$$128 + 64 + 8 = 200$$

200 X 5 KHz = 1.0 MHz, which is added by U10 and U9 to the frequency programmed on the main matrix. To say it precisely: 200 is added in binary form to the binary form of the N number.

Using Computer BASIC as a Diode Matrix Programming Aid

The purpose of the following BASIC program is to be as CLEAR AND GENERIC as possible with no concern for programming efficiency or sophistication. Those who enjoy and understand programming in Basic can dress it up to suit themselves. Or, they can write a program that satisfies their own standards. A major purpose of the deliberate simplicity is that the routine should run on virtually any computer using any version of Basic. If you follow the program flow, you'll see that it carries out in order the very same steps you would follow by hand in converting decimal to binary using the FX Programming Worksheet. You can use this same program for calculating nonstandard Transmitter Offsets.

Program Notes:

1. Install diodes ONLY in rows where "1" is indicated.
2. If you prefer, "0's" can also be generated through the use of appropriate IF . . . THEN . . . ELSE lines.
3. The "!" after 32768 is generated automatically by the computer, whether you type it in or not.
4. Be VERY accurate in typing "<" and ">" or "=>" because they are critical to correct placement of 1's.
5. The CLEAR instruction after screen printing is important; if it is omitted, AA, BB, CC, etc., will not be reset for checking the next frequency.
6. Innovative computer programs to enhance enjoyment of the FX transceivers are encouraged; send them to your favorite ham or computer magazine, newsletter or BBS.
7. LPRINT or equivalent Basic statements can be used to produce hard-copy printouts of frequency information you need.
8. IMPORTANT: Before soldering ANY diodes in your FX-transceiver programming matrix per this program, CHECK AND VERIFY that your program is giving CORRECT results! COMPARE it to the samples in this book.

NOTICE:

Although this program has been tested on many Microsoft BASIC releases, including GW Basic, it is printed here solely as a convenience and is not integral to the Ramsey FX-50 operation. If you have trouble running the program, please get help from a local computer friend and not from the Ramsey factory - we're radio guys, not computer hackers!

Sample BASIC Program Listing

```
50 PRINT "Enter Receiver Frequency as 6 digits with NO decimal!"
52 INPUT "For example: 146520. Enter here: "; F
55 N = F/5
60 PRINT "The FX146 or FX220 N number for binary conversion is "; N
101 AA = 0
102 BB = 0
103 CC = 0
104 DD = 0
105 EE = 0
106 FF = 0
107 GG = 0
108 HH = 0
109 II = 0
110 JJ = 0
111 KK = 0
112 LL = 0
113 MM = 0
114 NN = 0
115 OO = 0
116 PP = 0
200 IF N => 32768! THEN AA = 1
205 IF N > 32768! THEN NA = N - 32768!
206 IF N < 32768! THEN NA = N
210 IF NA => 16384 THEN BB = 1
215 IF NA > 16384 THEN NB = NA - 16384
216 IF NA < 16384 THEN NB = NA
220 IF NB => 8192 THEN CC = 1
225 IF NB > 8192 THEN NC = NB - 8192
226 IF NB < 8192 THEN NC = NB
230 IF NC => 4096 THEN DD = 1
235 IF NC > 4096 THEN ND = NC - 4096
236 IF NC < 4096 THEN ND = NC
240 IF ND => 2048 THEN EE = 1
245 IF ND > 2048 THEN NE = ND - 2048
246 IF ND < 2048 THEN NE = ND
250 IF NE => 1024 THEN FF = 1
255 IF NE > 1024 THEN NF = NE - 1024
256 IF NE < 1024 THEN NF = NE
260 IF NF => 512 THEN GG = 1
265 IF NF > 512 THEN NG = NF - 512
266 IF NF < 512 THEN NG = NF
270 IF NG => 256 THEN HH = 1
275 IF NG > 256 THEN NH = NG - 256
276 IF NG < 256 THEN NH = NG
280 IF NH => 128 THEN II = 1
285 IF NH > 128 THEN NI = NH - 128
286 IF NH < 128 THEN NI = NH
290 IF NI => 64 THEN JJ = 1
295 IF NI > 64 THEN NJ = NI - 64
296 IF NI < 64 THEN NJ = NI
300 IF NJ => 32 THEN KK = 1
305 IF NJ > 32 THEN NK = NJ - 32
306 IF NJ < 32 THEN NK = NJ
310 IF NK => 16 THEN LL = 1
315 IF NK > 16 THEN NL = NK - 16
316 IF NK < 16 THEN NL = NK
```

```
Can we subtract 2048 from 2313? YES (Therefore diode at 2048)
      2313 - 2048 = 265
Can we subtract 1024 from 265? NO (Therefore NO diode at 1024)
Can we subtract 512 from 265? NO (Therefore NO diode at 512)
Can we subtract 256 from 265? YES (Therefore diode at 256)
      265 - 256 = 9
Can we subtract 128 from 9? NO (Therefore NO diode at 128)
Can we subtract 64 from 9? NO (Therefore NO diode at 64)
Can we subtract 32 from 9? NO (Therefore NO diode at 32)
Can we subtract 16 from 9? NO (Therefore NO diode at 16)
Can we subtract 8 from 9? YES (Therefore diode at 8)
      9 - 8 = 1
Can we subtract 4 from 1? NO (Therefore NO diode at 4)
Can we subtract 2 from 1? NO (Therefore NO diode at 2)
Can we subtract 1 from 1? YES (Therefore diode at 1)
      1 - 1 = 0
```

As soon as we get a result of 0, we are finished and the remaining positions are left empty (indicating a zero).

Let's check our results using this shortcut method:

On the previous page, we found the binary equal of $N = 10,505$ was:

```
0 0 1 0 1 0 0 1 0 0 0 0 1 0 0 1
```

And, just now, we find the binary value of N to be:

```
0 0 1 0 1 0 0 1 0 0 0 0 1 0 0 1
```

We see that this way leads us to a correct result also. We could go on and on with shortcuts and tips. For example, we can just know in our heads that the "1" position is used only for frequencies with 5 KHz spacing. *The most important thing is simply to become comfortable and accurate in converting N to its binary equivalent.*

Even though there are 16 matrix positions to program, there are some shortcuts to make your job easier for normal ham band operation. Let's look at the upper and lower band edges for the 6 Meter band:

Freq	N=	32 K	16 K	8K	4K	2K	1K	512	256	128	64	32	16	8	4	2	1
50.000	10,000	0	0	1	0	0	1	1	1	0	1	1	1	0	0	0	0
52.000	10,400	0	0	1	0	1	0	0	0	1	0	1	0	0	0	0	0
54.000	10,800	0	0	1	0	1	0	1	0	0	0	1	1	0	0	0	0

Notice that the values of the highest 6 positions are the same throughout the band. We still must program in those six positions but we only need to calculate for the remaining 10 (512 through 1).

Let's look again at the programming of 52.525 MHz Simplex, where $N = 10,505$. First, we see that the 8K position is always programmed with a diode and that the 32K, 16K and 4K positions never have a diode installed. Let's put that fact to practical use:

1. We will always install a diode in the 8K position. This gives us an 'initial' N value of: 8,192
2. This number can be used to START programming ANY frequency within the Amateur 6 Meter Band. We need only add additional diodes in the 2048 through 1 positions for the various channels within the band.
3. We determine these additional diodes by the same "Descending Attempted Subtraction," that we used above for studying the programming of 52.525 MHz Simplex, a process which you can do in your head, with scratchpaper, or on the FX-50 Programming Worksheet.

Let's do an example:

1. We're already familiar with the right answer for 52.525 simplex, let's use it again. $N = 52525 \div 5 = 10,505$
2. Since we have already installed a diode in the 8K position, our 'initial' N is 8,192. The N we need is 10,505.
3. We now figure the difference between the N needed and the 'initial' N: $10,505 - 8,192 = 2,313$
4. Now, using the "Attempted Subtraction" technique, find the remaining binary value to be programmed.

```

320 IF NL => 8 THEN MM = 1
325 IF NL > 8 THEN NM = NL - 8
326 IF NL < 8 THEN NM = NL
330 IF NM => 4 THEN NN = 1
335 IF NM > 4 THEN NX = NM - 4
336 IF NM < 4 THEN NX = NM
340 IF NX > 2 THEN OO = 1
345 IF NN = 2 THEN OO = 1
346 IF NX = 3 THEN PP = 1
347 IF NX = 1 THEN PP = 1
400 PRINT "32768 - "; AA
405 PRINT "16384 - "; BB
410 PRINT " 8192 - "; CC
415 PRINT " 4096 - "; DD
420 PRINT " 2048 - "; EE
425 PRINT " 1024 - "; FF
430 PRINT "  512 - "; GG
435 PRINT "  256 - "; HH
440 PRINT "  128 - "; II
445 PRINT "   64 - "; JJ
450 PRINT "   32 - "; KK
455 PRINT "   16 - "; LL
460 PRINT "    8 - "; MM
465 PRINT "    4 - "; NN
470 PRINT "    2 - "; OO
475 PRINT "    1 - "; PP

480 PRINT "The Binary Equivalent of N can also look like this: "
481 PRINT "
482 PRINT USING "###"; AA, BB, CC, DD, EE, FF, GG, HH, II, JJ, KK, LL, MM, NN, OO, PP
485 PRINT
505 CLEAR.
510 GOTO 50
520 END

```

Here's an example of the screen display for the program as written, showing the results for an entry of "146865" and ready for the next frequency to be entered as 6 digits:

```

For example: 146.52 MHz. = 146520. Enter here >>> ? 146865
The FX146 or FX220 N number for binary conversion is: 29373
32768 - 0
16384 - 1
8192 - 1
4096 - 1
2048 - 0
1024 - 0
512 - 1
256 - 0
128 - 1
64 - 0
32 - 1
16 - 1
8 - 1
4 - 1
2 - 0
1 - 1
>> The Binary Equivalent of N looks like this:
  0 1 1 1 0 0 1 0 1 0 1 1 1 1 0 1
>>> Enter Next Frequency for Programming:
Enter Receiver Frequency as 6 digits with NO decimal!
For example: 146.52 MHz. = 146520. Enter here >>> ?

```

HOW TO ACTIVATE AN AUXILIARY OFFSET:

1. Install NO diode in SIMP, -RPT or +RPT for the channel that gets a non-standard offset.
2. Program the AUX matrix row for the desired offset, following our published instructions.
3. Connect the channel row to the AUX matrix row by installing a diode as shown below. The cathode end is soldered to the diode programming bridge. In this example, Channel 3 uses the auxiliary offset:

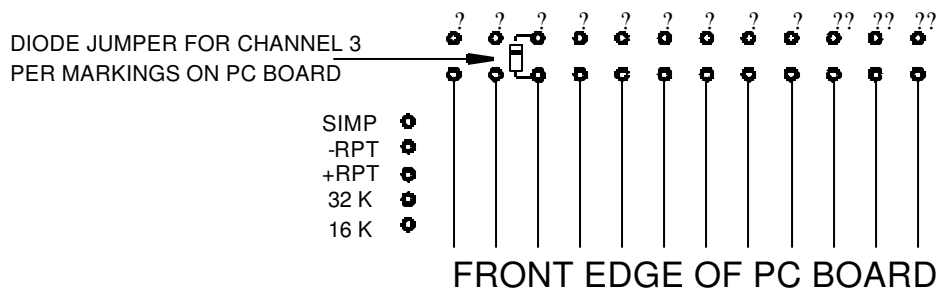

"N" for 52.525 MHz = $52525 \div 5 = 10,505$

Subtracting from N:	Remainders and doodles	NO	YES	Position
Can you subtract 32768?		⊘		32K
Can you subtract 16384?		⊘		16K
Can you subtract 8192?	2313		⊘	8K
Can you subtract 4096?		⊘		4K
Can you subtract 2048?	265		⊘	2K
Can you subtract 1024?		⊘		1K
Can you subtract 512?		⊘		512
Can you subtract 256?	9		⊘	256
Can you subtract 128?		⊘		128
Can you subtract 64?		⊘		64
Can you subtract 32?		⊘		32
Can you subtract 16?		⊘		16
Can you subtract 8?	1		⊘	8
Can you subtract 4?		⊘		4
Can you subtract 2?		⊘		2
Can you subtract 1?	0		⊘	1

Now, install Programming Diodes at all YES positions and we're done!

The practical result from the preceding exercise is that we install diodes only in the YES positions on the matrix. Compare these results with the diode programming illustrated for 52.525 MHz Simplex on the schematic diagram. If you do not yet understand EXACTLY what we did in this exercise and why, we suggest in the strongest possible terms that you work at getting it clear before doing any further work on your transceiver.

Stage H: FREQUENCY PROGRAMMING: Understanding and Building the Diode Matrix

The labeling of the 16 parallel programming inputs of U6 should have a familiar ring to anyone with at least some understanding of computer principles, which should include all of us by now. Even though our desired "N" number is a five-digit decimal number, it is programmed as a "16 bit" BINARY number.

Binary numbers can be as big as you like, but we get there by counting on a base of two, either 1 or 0, yes or no, on or off. This is, of course, the foundation for all digital circuitry.

The programming inputs of your FX transceiver synthesizer can be set for any frequency in its range, using the correct "N" number, by means of the diode programming provided with your kit, or with simple switches, or by digital switching circuitry, or by a dedicated microprocessor circuit, or by a control circuit controlled by the same computer you use for packet, etc.

We will cover only the diode programming approach with some brief suggestions on externally controlled switching. It is very intentional on our part to leave innovative programming schemes up to FX transceiver users, because there's no single best way to do it for everybody. Our job was to break the price barrier on a practical, state-of-the-art VHF transceiver and make it highly useful for most operating patterns.

You have easy front-panel selection of ANY 12 frequency pairs and never need to buy a crystal. Nor should you ever need factory service. THAT is what this transceiver is all about!

There are several methods for quickly finding the required binary code for a particular frequency and its "N" number:

1. Descending Subtraction (see Programming Worksheet)
2. Printed reference lists (see Popular 6 Meter Band Pairs)
3. Computer programs (see our sample BASIC program)

We recommend strongly that you fully understand how to make the "attempted descending subtraction" calculation yourself, because that is your ONLY means for checking the accuracy of printed information, computer programs or the operation of experimental programming circuits.

Let's walk through the programming of 52.525 MHz, which is the national Simplex Calling Frequency and is also the demonstration and alignment standard for the FX-50 model. You'll see exactly what we mean by "descending attempted subtraction." Also, this is how the model BASIC program for diode programming included in this book is structured.

4. You can connect as many of the channel rows as you wish in this manner, but remember that each would follow the same non-standard split you have programmed. Only one such split can be programmed in the AUX matrix row. It may be changed as needed. If more than one non-standard split is needed, you can either give up a standard split or devise your own way of switching in what you need.

+TX (+RPT) OFFSETS

+TX offsets are programmed exactly like the Frequency Programming matrix. For example, for a 1.0 MHz offset:

$$N = 1000 \text{ KHz} \div 5 \text{ KHz} = 200$$

Therefore install diodes at the 128, 64, and 8 positions.

See Stage H for instructions and detailed examples.

PROGRAMMING THE 'MINUS' OFFSETS

We showed the Plus offsets first to prepare you for the Minus offsets. The offsets are entered into the FX synthesizer through the binary adders, U7-10. Notice that we said adders and not subtractors; in binary there is 'no such animal' as a subtractor. We must use the technique known as 'two's complement addition' which actually performs a subtraction process! This may sound complicated, but it really isn't. We simply find 'N' as usual, take its 'two's complement' and program the result into the offset matrix. We'll show you three detailed examples.

Don't be alarmed. If all you need is the standard 6 Meter band offsets, just install the diodes in the offset matrix as clearly illustrated on your PC board. Understanding the following information is essential ONLY for those who need to program non-standard Minus or AUX offsets.

First we need to understand some rules for binary addition:

- 1) $0+0=0$
- 2) $1+0=1$
- 3) $1+1=0$ and CARRY 1

(Carrying is done from right to left)

EXAMPLE 1: -1.0 MHz TX Offset

As for the +1.0 MHz offset, $N = 1000 \div 5 \text{ KHz} = 200$. However, this is the last of Decimal numbers in this work. We'll have to work with Binary numbers now. In brief, we set up the complement, or exact inverse of N in binary, and then add 1. This will give us our two's complement that is needed for programming into our offset matrix.

Binary code for N=200

8192	4096	2048	1024	512	256	128	64	32	16	8
0	0	0	0	0	0	1	1	0	0	1

Now, just INVERT all of the 'bits':

1 1 1 1 1 1 0 0 1 1 0

Then, ADD 1:

1 1 1 1 1 1 0 0 1 1 1

This is our two's complement value which we program into our offset matrix. You'll see these diodes in the position for -1.0 MHz TX offset.

Even though it appears that we are adding a huge N number to the original transmitter frequency, the binary adders will follow the rules of binary addition and provide the proper programming information to the PLL synthesizer.

EXAMPLE 2: RECEIVER OSCILLATOR FREQUENCY

We know from previous circuit discussion that the PLL synthesizer must run 21.4 MHz lower when in receive mode. Two things must be done to do this; first, we switch out varactor diode D3 to allow the VCO L-C circuitry to tune 21.4 MHz lower, and secondly, program in a 'minus' 21.4 MHz offset to the synthesizer. This offset is permanently programmed into the matrix because the 21.4 MHz 1st IF is integral to the FX receiver design. Look closely at the Receive offset diode row and see why the diodes are installed the way they are.

$$N = 21400 \div 5 \text{ KHz} = 4,280$$

8192 4096 2048 1024 512 256 128 64 32 16 8
 0 1 0 0 0 0 1 0 1 1 1

Binary code for N=4,280

Now, invert all the bits:

1 0 1 1 1 1 0 1 0 0 0

Add 1:

1 0 1 1 1 1 0 1 0 0 1

You'll see this is the number programmed into the Receive offset matrix line for a minus 21.4 MHz offset.

EXAMPLE 3. TWO'S COMPLEMENT WITH CARRY

For illustration purposes, we'll pick an odd-ball offset such as 640 KHz. In this case, $N = 640 \div 5 \text{ KHz} = 128$.

8192 4096 2048 1024 512 256 128 64 32 16 8
 0 0 0 0 0 0 1 0 0 0 0

Stage H: Frequency Programming, Understanding and Building your Diode Matrix

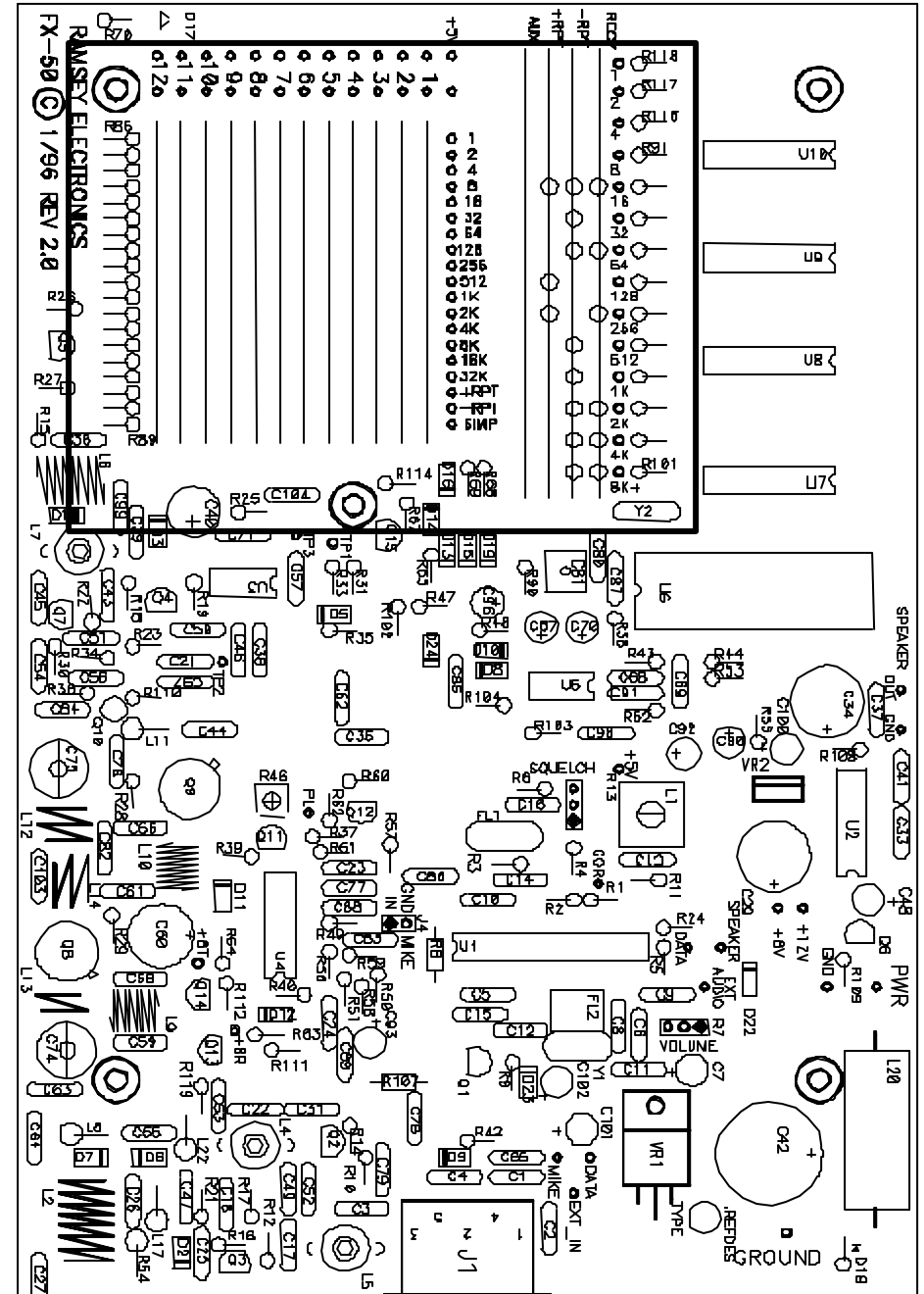

✍ G36. Similarly, install diode D10, same type as D8.

✍ G37. Similarly, install diode D24.

Invert all bits:	1	1	1	1	1	1	0	1	1	1	1
Add 1:										+	1
Sum at '8' bit position, carry 1										1	0
Sum at '16' bit position, carry 1									1	0	0
Sum at '32' bit position, carry 1								1	0	0	0
Sum at '64' bit position, carry 1						1	0	0	0	0	0
Sum at '128', no carry needed						1	0	0	0	0	0
Final result:	1	1	1	1	1	1	1	0	0	0	0

Binary code for N=128

BASICS OF EXTERNALLY CONTROLLED FX-TRANSCEIVER FREQUENCY SWITCHING

The 12 front panel switched channels, with never a need for a crystal will cover most applications generously. Yet many of us will want to figure out ways for easy frequency-programming of still more channels, especially if we do a lot of cross-country travel. Rather than endorse or illustrate any particular scheme, of which there are dozens if not hundreds, we provide here the most basic schematic information needed to set up any kind of auxiliary switching correctly. The principles and requirements remain the same whether you use DIP switches, toggle or slide switches, electronic latching or go all out to build the mother of all diode matrixes. Make sure whatever you build resembles electrically the diagram on page 38.

Some DO's and DON'Ts of FX-Transceiver Add-Ons:

1. DO study and understand the basic switching diagram.
2. DO let your ingenuity run wild to come up with the neatest, most cost-effective scheme.
3. Please DON'T ask our technicians to talk you through your own idea.
4. DON'T run switching cables across the VCO and Transmit RF side of the PC board.
5. Please DO submit successful frequency control ideas as articles for your favorite ham radio magazine. Your pay as author may cover the cost of your transceiver!
6. Please DO mail or fax us your good ideas.
7. Please DON'T try out ANY modifications of the basic FX-Transceiver

unless you already have it WORKING fine.

NOTES:

1. DIP switches with diodes can be installed on/above the diode matrix itself for E-Z internal programming changes.
2. Any auxiliary programming device can be wired to a switched position on the FX-transceiver matrix as well as to the auxiliary points illustrated.
3. "SPDT" switching may be devised to select offsets.
4. Programming Shortcuts are possible for ham-band operation. (See text).

FX
EXTERNAL

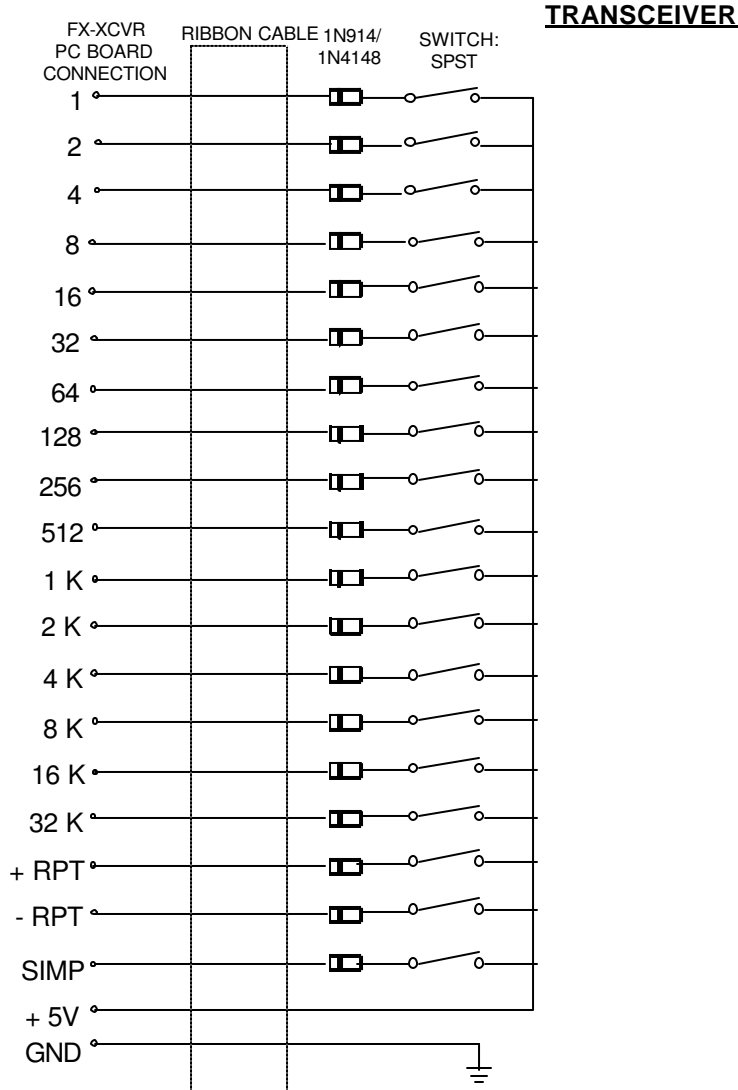

TRANSCEIVER

✍ G17a. Insert and solder U9 as in step G15a.

✍ G18a. Insert and solder U10 as in step G15a.

Soldering the remaining pins for U7, U8, U9 and U10 may be done either as a single operation or at any other pace preferred by you to ensure careful work (no missed pins, no solder bridges). As you complete the soldering of each IC, mark its respective assembly step.

✍ G15b. 14 pins soldered on U7.

✍ G16b. 14 pins soldered on U8.

✍ G17b. 14 pins soldered on U9.

✍ G18b. 14 pins soldered on U10.

Install the following resistors and capacitors:

✍ G19: R55, upright, 10K (brown-black-orange).

✍ G20: R44, upright, 22K (red-red-orange).

✍ G21: R53, upright, 22K (red-red-orange).

✍ G22: C69, .01 uf.

✍ G23: C68, .047 or .05 uf (marked .047 or 473 or .05 or 503).

✍ G24: C91, .047 or .05 uf.

✍ G25: C98, .01 uf.

✍ G26: R43, upright, 22K (red-red-orange).

✍ G27: R52, also 22K.

✍ G28: R103, upright, 47K (yellow-violet-orange).

✍ G29: R104, upright, 10K.

✍ G30: R90, upright, 10K.

✍ G31: R47, upright, 10K.

✍ G32: R102, upright 10K.

✍ G33: R48, upright, 10K.

✍ G34. Install C85, .1 uf (marked .1 or 104).

✍ G35. Install diode D8 type 1N914 or 1N4148. Orient the banded cathode end correctly.

make mistakes: skipping connections, causing solder bridges, etc. Some builders may prefer to push ahead and do all of the repetitive soldering as a single operation, while others do better work with frequent breaks in the phases that involve repetition of steps. The suggested order of assembly is for the benefit of the latter group. If you wish to proceed differently, feel free to do so. Just be sure to check off the respective assembly steps as you finish or review your work.

- ✍ G1a. Insert the 28-pin DIP socket for U6 into its PC board position and slightly bend the 4 outermost pins to hold it in place.
- ✍ G1b. Examine the solder side and verify that ALL 28 pins are extended into their respective holes. Press the socket squarely onto the board, solder the 4 corner pins, check for proper seating, then solder remaining pins.
- ✍ G2. Install U6, MC145152, check that all pins are fully seated.
- ✍ G3. Install oscillator crystal Y2, 10.240 MHz. Be sure it is firmly seated on the board, then solder.
- ✍ G4. Install C87, 39 pf.
- ✍ G5. Install C80, 15 pf.
- ✍ G6. Install R38, 10K (brown-black-orange).
- ✍ G7. Identify C81, a 35 pf. trimmer capacitor. (C81 has a black body and orange top.) Press it in place flat on the PC board.
- ✍ G8. Solder C81's two connections.
- ✍ G9. Identify and install U5, the LM358 dual op amp IC. Be certain to orient the notched end as pictured on the PC board.

OBSERVE CORRECT POLARITY FOR THESE CAPACITORS:

- ✍ G10. Install C70, 2.2 uf. electrolytic.
- ✍ G11. Install C67, 2.2 uf. electrolytic.
- ✍ G12. Install C96, 4.7 or 10 uf. electrolytic.
- ✍ G13. Install C90, 2.2 uf. electrolytic.
- ✍ G14. Install C92, 2.2 uf. electrolytic.
- ✍ G15a. Insert U7, type 74HC283 IC with its notched end correctly oriented. Solder the 4 outermost pins.
- ✍ G16a. Insert and solder U8 as in step G15a.

FX-SERIES TRANSCEIVER GLOSSARY

The following is a deliberately INFORMAL collection of:

- ? Technical terms useful to know in understanding your FX- transceiver design.
- ? Acronyms (phrases expressed by first letters of words: example: PLL = Phased Locked Loop)
- ? Selected Electronics Industry "jargon"

Any of these words or expressions might be used in this instruction manual or in conversation related to your FX- transceiver, either with other hams or with Ramsey technicians. These descriptions or notes for a very few terms certainly are not an "electronics dictionary," but the author/compiler hopes that they might enhance your grasp of the concepts and language that he has seen as useful in building and using this transceiver. For more detail, PLEASE study the introductory part of each Assembly Stage.

ADDER = Anybody who can add can be called an "adder." If we delegate such work to electronic devices, the most fundamental digital operation after being in a binary high or low (on or off) state is to be able to find the sum of such states from two or more sources. The BINARY ADDER performs this function. See also: BINARY.

AFSK = "Audio Frequency Shift Keying." [SEE: "FSK"] In short, this is a very popular form of data transmission.

AXIAL-LEAD = Wires stretch out from two opposite ends of a part instead of from one end, i.e. along the "axis" of the body. For example: L20.

BA- = Manufacturer's PREFIX for PIN-type diodes.

BASIC = "Basic." We're talking about the one computer programming procedure that should make sense to ALL computer owners. If any further explanation is needed, visit a library or computer dealer.

BB- = Manufacturer's PREFIX for VARACTOR diodes.

BINARY = the number system based on the two values of 0 and 1. Here are all the tables that we need to memorize:

$$0 + 0 = 0 \qquad 0 + 1 = 1 \qquad 1 + 1 = 0 \text{ and carry } 1 \text{ to next position.}$$

BOARD = Generally refers to "PC board" or "printed circuit board."

BUFFER = An electronic circuit stage, a sort of "referee" that tells its input and output not to mess with each other. Think about such a task! It may also provide amplified output of the incoming signal.

CASCADE, cascading = combining two or more identical circuit elements or components for improved effectiveness.

CARRIER = Transmitted RF signal that is NOT "modulated." It is heard as a steady tone on BFO-equipped receivers or as a powerful silence (i.e. overriding all background noise or hiss) on FM receivers.

CCW = see CW below.

COR = "Carrier Operated Relay," a switching circuit activated by the detection of a carrier signal in a receiving circuit.

"**CW**" = TWO common meanings in electronics: "Continuous Wave" for the communicating of Morse code signals, or "Clockwise" to designate a point on a variable control. "CCW" therefore means "counterclockwise."

DECIMAL = in computer or programming context, "decimal" refers to counting by tens, our traditional way, in contrast to your computer's binary (counting by 1's and 0's), or the hexadecimal system (counting by 16's.) See "N" and BINARY.

DIP = "Dual Inline Package," referring to IC's and their sockets or any other component ("DIP Switch," etc.). The "line" refers to rows of PC-board or perfboard holes that are 0.1" apart. "Dual" means two rows. Therefore "SIP" would mean a SINGLE row device.

DISCRIMINATOR = FM terminology for "detector." See: FM.

DUAL-MODULUS = as in dual-modulus prescaler or divider: a circuit which divides a frequency by two different ratios depending on pin selection, for example: 64 or 65. (See: PRE - SCALE)

FILTER-ACTIVE

FILTER-CERAMIC

FILTER-CRYSTAL

FILTER-HI-PASS

FILTER-LOW-PASS

FILTER-BANDPASS

FILTER-PASSIVE

Filters are used in DC, Audio and RF circuits. Understanding them is essential electronics know-how. The Radio Amateurs' Handbook covers the subject of filters very well.

FM ("Frequency Modulation") = Changing the transmitter frequency in exact pace with speech or sound variations.

FREQUENCY SYNTHESIS = To "synthesize" anything is to create an imitation or simulation from something else. The "basic" ways for generating useful RF frequencies are a crystal oscillator or the L-C oscillator where the frequency is determined by coil (L) and capacitor (C). However we can process the output of an L-C oscillator through digital circuitry to simulate many different, precise crystal-like frequencies, using only one crystal as a reference standard. See also PLL, PHASE DETECTOR, VCO.

FSK = "Frequency Shift Keying." TRUE FSK actually moves the RF frequency (transmitted and received) from one pre-determined point to another, in contrast to "AFSK" (Audio Frequency Shift Keying") where the transmitted signal remains steady and all shifting is done by audio tones.

GROUND-PLANE = ALL sections of a PC-board which are mechanically or electrically connected to DC and RF ground. In the Ramsey FX design, almost ALL of the top or upper side (component side) of the board is a groundplane. The term is also used in antenna design: if your 2M or 1.25M antenna has a vertical radiating element, plus four (or more) horizontal elements connected

Unlike simpler PLL IC's, U6's phase detector has TWO outputs at pins 7 and 8. These outputs go through very simple low pass filters (R44-C68, R53-C91) to cut back the 5 KHz whine sound of U6 at work. Op amp U5:A sums together the phase detector outputs and the output of U5:A is passed through a network of 2.2 uf electrolytic capacitors (C67,70,90,92) to smooth out the phase detector pulses to clean DC for controlling the VCO.

R47, R48 and C85 form yet another low pass filter to ensure that any 5 KHz "whine" will not get into the VCO. Because the DC charge developed in C85 (.1 uf) would slow down the PLL during major frequency swings, such as going from transmit to receive, D8 and D10 are set up back-to-back across voltage dropping R48.

Whenever there is a major frequency shift (which means a significant VCO control voltage change), one way or the other, one diode or the other is switched on to short out R48 and discharge C85. This lets the PLL re-lock instantly; C85 recharges and the diodes become no factor in the circuit. The "lock detect" output (pin 28) of this Motorola PLL IC is a fine feature that could be used many different ways in this circuit. We could have set it up to tell an LED to alert you that you are "UL" (unlucky, unlocked??) Instead, we decided to protect your investment in the transmitter RF section of your transceiver and keep our FCC smiling. The lock detector gives a strong series of pulses when the PLL is unlocked. When the PLL is locked, only a tiny sawtooth wave appears at pin 28. The "lock detect" voltage is watched by U5:B. If "unlock" pulses appear, they are integrated through R90 and C96 as a fairly clean DC voltage charge built up in C96. If this charge causes U5B to swing low, bias is removed from Transmit Buffer Q10. No damage is done, and no offending signals can be emitted. We've toured "The Loop." Now, let's build it and enjoy what it can do!

STAGE G: PLL SYNTHESIZER CIRCUIT ASSEMBLY

Since our most immediate goal is a functioning, programmable receiver, it is useful to know that the receiver portion could work fine WITHOUT the four binary adder IC's (U7-U10) or the secondary diode programming matrix. In practice, this proposition need NOT be pursued, because it would require 16 wire jumpers to connect the A inputs of the adders to the summing outputs. Also, the programming formula would involve addition of the receiver IF frequency. For example, to receive 52.525 MHz., we would have to determine N as $(52525 - 21400) \div 5$. Consequently, we can see that it will actually be EASIER to install the 4 IC's, install diodes in the RECEIVE line of the second matrix and proceed to find "N" simply by dividing our desired frequency by 5 KHz.

CONSTRUCTION PROCEDURE NOTE:

The suggested order of assembly for the PLL Frequency Synthesizer portion of your transceiver is exactly that: a suggestion. This stage involves some repetitive work that may seem extra easy, but it also can become easier to

- ? The Phase Detector (or "phase corrector") which compares the 5 KHz Reference Frequency with the "intended" 5 KHz output of the divide by N counter and sends correcting pulses to the VCO to keep the output of the N divider right at 5 KHz.
- ? A "lock detect signal" circuit.

An easy illustration of how simple assembly error causes an unlocked or mistuned PLL can be seen in the fact that the Reference Frequency "R" counter is externally programmable by grounding various combinations of pins 4,5,6, permitting 8 possible divider values.

Let's say that pin 6 of the IC or socket is bent and does not make contact. This would cause the "R" divider to divide by 1160 rather than 2048, for a Reference Frequency of 8.8276 KHz rather than 5 KHz! Thus, the VCO output would become a multiple of 8.8276 KHz. If "N" is programmed as 10,505 for 52.525 MHz Simplex, the single bent IC pin would cause the output frequency to be 10,505 X 8.8276 KHz, which is 92.734 MHz! Because the VCO cannot tune this high, the loop becomes unlocked.

In addition to looking over the following block diagram of the internal circuits of U6, it is worthwhile to study the block diagram and the schematic of the whole FX- transceiver circuit. The more you work to understand it, the more confident you'll become in using, maintaining, programming and customizing your FM transceiver.

FX- TRANSCEIVER PLL OVERVIEW:

The reference oscillator is internal to U6, governed by Y2. The precision of the 10.240 MHz reference oscillator can be adjusted by trimmer C81. The R divider feeds 5 KHz to the phase detector section of U6 (10.240 divided by 2048).

The output of the MC12017P, ÷64/65 prescaler U3 is AC coupled via C57 to pin 1. IC U3 is a "dual-modulus" prescaler, controlled by pin 9 of U6. The pre-scaled output of the VCO is fed to the A and N counters. The "N" number programmed on the diode matrix is pre-determined to divide this frequency down to 5 KHz for phase comparison with the 5 KHz output of the crystal controlled reference divider.

The minimum "N" number is 1. The maximum can be stated in a variety of ways, some more exact than others. We could just say "64K less 1" or 2 to an n-th power less one. We could say the maximum is what you get when you install diodes in all 16 positions of the parallel programming matrix. We could express it as "2 x 32768 - 1" or just say that it is 65,535!

The details of N divider programming will be covered in the next section. We'll even see that the roles of the offset matrix and the binary adders (U7-U10) are clear, brief and simple to explain.

to RF ground, the horizontal elements are called a "groundplane."

HIGH = In solid-state circuitry, to say a given device pin or circuit point is at a "logic high" is to say that it shows a + DC supply voltage at that point. Switching to the opposite state (LOW) or back again for some specific purpose is a fundamental capability of the circuit.

HOUSE-NUMBER = A manufacturer's part number different from the industry-standard description of a part. Example: LB53303HK (L1)

HYSTERESIS = the ability of an FM squelch circuit to remain open after being broken by a weak signal which fluctuates further.

INPUT, INVERTING = see "Op Amp"

INPUT, NON-INVERTING = see "Op Amp"

I/O = acronym meaning "Input and Output" port or connection.

JUMPER = Short, plain wire, soldered to interconnect points in a circuit not otherwise connected by board traces or other wiring.

KEY, "to key" = to turn on a transmitter's carrier signal momentarily, whether by a telegraphy code key (the root of this very common radio jargon) or by a push-to-talk switch.

L-C = A tuned circuit made of inductor (L) and capacitor (C).

LIMITER = The portion of an FM receiver circuit which chops off noise and AM (amplitude modulation). It processes the IF signal so that only FM will be detected.

LOCAL OSCILLATOR (LO) = An oscillator in a superhet receiver whose output is mixed with another signal such as antenna input. See SUPERHET.

LOCK = The condition in a phased-locked-loop (PLL) in which all sections are working together as intended and designed.

LOOP-FILTER = (See PLL). The output of a PLL phase detector is in the form of pulses. The frequency of those pulses depends on the reference frequency. The loop filter smoothes out these pulses into a clean DC control voltage for the VCO. (See: VCO)

LOW = A logic level at or near zero volts. (See HIGH).

MATRIX = A methodical criss-crossing of many connections.

MC- = Prefix for parts made by Motorola, Inc.

MIXER = A circuit section which gets two or more inputs and delivers a single output. The output is equal to the sum of the input frequencies and also to the difference between them.

MODULATION = See also: CW, FM. "Modulation" is simply the process of imposing variations on a steady RF signal from an audio source such as voice, music or data (see: AFSK).

MUTE = to turn off, to render silent. (See also SQUELCH)

N = can be any number to solve in a classroom problem, but "N" is THE magic number (decimal) to understand in FX binary frequency programming. N = the frequency in KHz divided by 5 KHz.

NBFM = "Narrow-Band FM." NE- = prefix to transistors or IC's made by Signetics, Inc.

OFFSET = The distance in KHz or MHz of the transmitted signal from the primary or received signal. The "TX Offset" may be higher or lower, depending on the repeater setup or other application.

OP-AMP = "Operational Amplifier," a high performance linear amplifier with an Inverting input, a Non-inverting Input and one Output.

ORIENT, orientation = Yes, the Orient is Marco Polo's Far East where they build many FM radios and where we buy many common parts. When we ask you to "orient" a kit part one way or the other, we're just asking you to get it RIGHT -- per all the "orientation" illustrations that we provide.

PACKET = Rapid transmission of intelligible computer generated data in groups or bursts of a fixed length called "packets."

PHASE DETECTOR = In a frequency synthesizer, the phase detector compares the signal from a reference oscillator to the signal from a programmable counter and sends a corrected control voltage to the L-C section of a VCO. Thus, it can be considered a phase "corrector." See also: VCO, PLL, VARACTOR.

PLATED-THROUGH = Refers to a style of PC board manufacturing in which traces on both sides of the board are interconnected by a coating of solder around the inside of each hole.

POLARITY = Refers to the "+" and "-" sides of batteries, power supplies, power cables, electrolytic capacitors, etc.

PLL = "Phase-Locked Loop," a frequency generator circuit in which an oscillator output is analyzed by counters and a phase detector which controls and corrects the voltage supplied to varactor diode(s) which determine oscillator frequency.

POT = jargon for "potentiometer", a variable resistor, either a panel control or a "mini" device on a PC-board.

PRESCALE, Prescaler = a circuit or device which divides an incoming frequency down to a lower frequency so that it can be handled more easily by later digital counting circuitry or devices.

PTT = "push to talk", referring to all switches and circuitry involved in turning a transmitter on and off from a switch usually built into a microphone. This switch may also be a relay or transistor in a packet TNC, etc.

PUFF = No, not the magic dragon. It's an easier way to say "picofarads" in the Ramsey warehouse and other high tech temples.

soon as both strings are exactly on the same frequency. By tuning the one string to the exact pitch of the other, you have corrected the phasing of the two independent frequency sources. Pilots of multi-engine planes (or boats) make slight RPM adjustments to get all engines in phase. If you have two audio oscillators handy, listen carefully as you adjust both to EXACTLY the same frequency. Another analogy is the process of tuning a BFO equipped receiver to a perfect null or "zero beat." If you are exactly on frequency, you hear nothing, even though the BFO and incoming signal are both fully present. In a PLL, we want the "beat note" to be a perfect zero or constant direct current (DC), and this DC controls the VCO.

What breaks the circle? What UN-locks the loop, the PLL? Let's think and make a list of possibilities:

- ? VCO will not tune in proper frequency range
- ? Bad Reference Oscillator (IC, crystal, component?)
- ? Invalid "N" number?
- ? A physical break in the loop?

Caused by (what else?):

- ? Bad solder connections
- ? Incorrect components
- ? Defective components (rare)
- ? Incorrect programming

The preceding is about as untechnical as we know how to get in giving a hint of how the PLL Frequency Synthesizer portion of your transceiver functions. The Glossary of Terms in this book might give some additional help, but there's really no substitute for just exploring the know-how of modern communications technology by whatever learning method works best for you.

Now, let's take another look at the whole circuit in a more formal way.

The PLL Frequency Synthesizer IC MC145152 incorporates the equivalent of 8000 individual transistors and contains the following circuits:

- ? A crystal reference oscillator governed by Y2, 10.24 MHz.
- ? A counter or "frequency divider" circuit set externally to divide the crystal oscillator output by 2048, for a Reference Frequency output of 5 KHz.
- ? A second counter or frequency divider that divides the frequency from the Prescaler (U3) by the externally programmed number that we call "N".
- ? A third frequency divider ("A") also used for programming
- ? Control logic circuitry which permit the "N" and "A" counters to work together for channel programming.

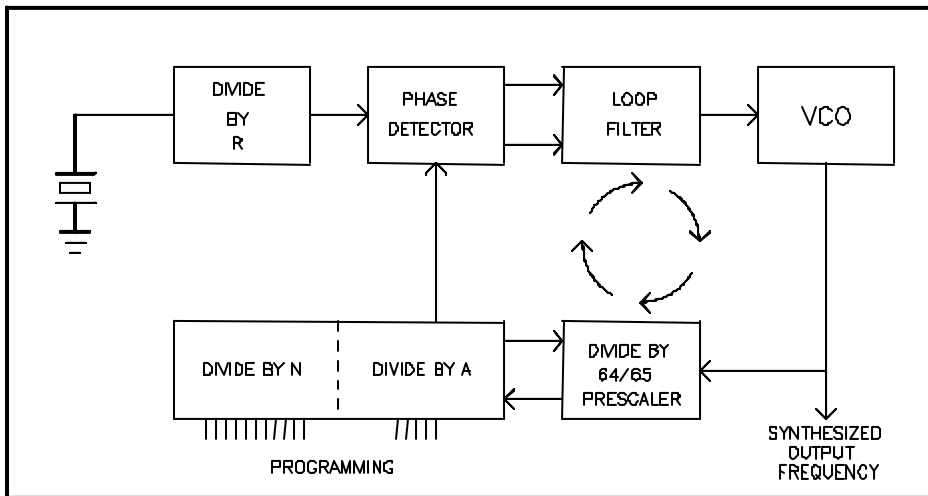

Inserted into this circle is the frequency synthesizer (U6 with U3), which compares the output of the VCO with the output of its own 10.24 MHz. Reference Oscillator (see Y2) and also with the frequency programming which you have set up. After making these comparisons, it gives an instruction to the VCO in the form of a precision voltage applied to the varactor diodes, and the cycle repeats itself at lightning speed.

Try dividing 10240 KHz by 2048 on your calculator. If you get an answer of 5 (KHz) you are correct and perhaps on your way to seeing how the FX transceiver can be programmed in 5 KHz steps! If you are curious about U3, its job is to divide the VCO's VHF output down so that U6 need only analyze ("count") 1/64 of it in order to send voltage adjustments back to the VCO. This prescaling keeps the input frequency to U6 within specifications.

"Will the circle stay unbroken?" asks an old folksong. If the PLL's circle of activity is broken by incorrect phasing, the loop is said to be "unlocked." If all is going well, the loop is locked. The loop is UN-locked only when the phase detector gets so unhappy that what is being fed into its two inputs is so far "out of whack" that it cannot make corrections. If the loop is unlocked, no useful control voltage reaches the VCO. If the VCO operates at all, it will be at a wrong or unknown frequency.

The phase "detector" can also be called a phase "corrector." It does more than just detect or look at the two incoming 5 KHz signals. It sends correcting pulses to the VCO to keep it in phase with the 5 KHz output of the crystal reference oscillator.

A good word for understanding "phase" is synchronization or "sync." The process of tuning a musical instrument is a good illustration of sync or phase. When two guitar strings are very close but not exactly on the same note, there is a discernible third sound, a sort of rumble that disappears as

QUADRATURE = Refers to the Phase Angle (90 degrees) considered by the FM discriminator or detector.

REFERENCE FREQUENCY = a precise, known frequency, usually crystal-controlled, compared with another frequency, as is done in a PLL circuit. See PHASE DETECTOR, PLL.

RSSI = "Received Signal Strength Indicator," a function of the MC13135 IC and comparable circuits which permits MEASURING of the relative strength of a received signal. A few microamps of variation can be interpreted as DB (decibels) of signal strength.

RX = Abbreviation for receive, receiver, receiving. [See: TX]

SPEAKER-MIKE = speaker and microphone functions contained in the same physical housing, as in the design of simple home intercoms. For ham operators, this means that both speaker and microphone are in a microphone casing with separate plugs from a common cord. Since such accessories can use ANY style of plug for either mic or speaker function, Ramsey Electronics has adopted the popular ICOM-compatible standard for the FX transceivers.

SHIELD = The outer braid of audio or RF coaxial cable, or the aluminum case enclosing a coil or transformer. The metal case of a transceiver also performs an important RF shielding function. The shield blocks or protects a coil from the effect of nearby objects that would change its inductance. The shielding on cable prevents the inner wire from radiating (RF) or from picking up stray radiation such as AC hum.

SQUELCH = means literally, to subdue utterly or crushingly! In radio communication, usually VHF and UHF, squelch is the circuitry needed to subdue (mute) the background noise until a detected signal "breaks" the squelch.

SUPERHET = A receiver design that converts the incoming desired frequency to a lower Intermediate Frequency (IF) where most of the gain and bandpass characteristics reside.

TOROID = A style of making coils or inductors where the insulated wire is threaded ("wound") around a metallic form shaped like a doughnut. This style of coil making generally eliminates any need for additional shielding which may be needed to make the coil's inductance immune to the presence of other nearby components or objects with metallic content.

TRIMMER = either a capacitor or resistor, miniature and variable, intended to permit exact, final adjustment of circuit values.

TX = Abbreviation for transmit, transmitter, transmitting.

T-R = Abbreviation for "Transmit-Receive Switching", which can be accomplished by manual switches, relays or solid-state devices such as the PIN diodes used in the FX transceivers.

UNLOCK, unlocked = refers to the condition in a PLL (phased locked loop) where one or more elements of the loop become defective or incorrect, preventing the phase detector from supplying the correct control voltage to the oscillator for the intended frequency of operation.

VARACTOR = a diode whose capacitance can be varied in step by the amount of DC voltage applied to it. The higher the voltage, the lower the capacitance. See also VCO.

VCO = "Voltage Controlled Oscillator," an oscillator whose frequency is varied by DC voltage applied to varactor diodes, which change capacitance in step with the voltage level.

ZENER DIODE = a diode designed to have a very specific reverse breakdown voltage. This property makes the Zener diode ideal for simple voltage regulators or precise voltage drop elements.

Stage G: The FX- Transceiver PLL Synthesizer

A reassuring feature of the FX Transceiver is that if you build it correctly and make just a few adjustments, it will work fine whether you understand how it works or not. For most amateurs and beginners, the functions of the PLL Frequency Synthesizer and VCO will present the greatest challenge to understanding. In fact, these stages, which are at the heart of the transceiver's design, are not easy to explain in everyday terms, because some level of engineering training or serious amateur curiosity is definitely required to catch on to the many concepts and principles involved. In short, don't feel bad if the functions of U5 through U10 seem somewhat mysterious to you at first.

The author's suggestion is that you study the FX transceiver's more complex sections simply for the fun and satisfaction of it, catching on to a little bit here or a new concept there as you go along. You'll get some insights from our published circuit descriptions, and you'll pick up more from studying other publications such as the ARRL HANDBOOK, discussing the circuit with friends with engineering backgrounds, or doing whatever helps you best catch on to new ideas and concepts.

The VCO, integral to the PLL, was discussed and tested in the preceding assembly stage.

What we have so far is a master oscillator for the transceiver that can be tuned by varying the voltage applied to the varactor diodes. All we really need now is a super reliable way of controlling the voltage applied to those varactor diodes so that we can put that oscillator on any VHF channel we want with 5 KHz precision. And this control obviously must be extremely stable, since a change of only a few picofarads can tune through many MHz of VHF spectrum. How can we get such precision performance from small tuning diodes, a very ordinary shielded coil, and a transistor with its supporting capacitors and resistors?

We assume already that the answer must lie in the functions of the Frequency Synthesizer IC. However, the key to grasping what this IC really does lies in grasping TWO concepts: frequency synthesis and the "Phased Locked Loop" or PLL. The more of a handle that you can get on these two interconnected ideas, the less mysterious will be your FX transceiver as well most other modern radio gear from ham transceivers to car stereos to cellular phones. To begin, let's over simplify as much as we can.

UNDERSTANDING THE PLL:

In the following block diagram, the notion of "Loop" is seen in the simple fact that the VCO output is routed right back into the VCO itself via the other circuit sections. Try to imagine the unending and rapid circle of activity in which the VCO output is repeatedly affecting its own oscillating frequency, self-adjusting many times per second. Hence, an un-ending circle or loop.

Stage G: The PLL Synthesizer: Understanding and Assembly

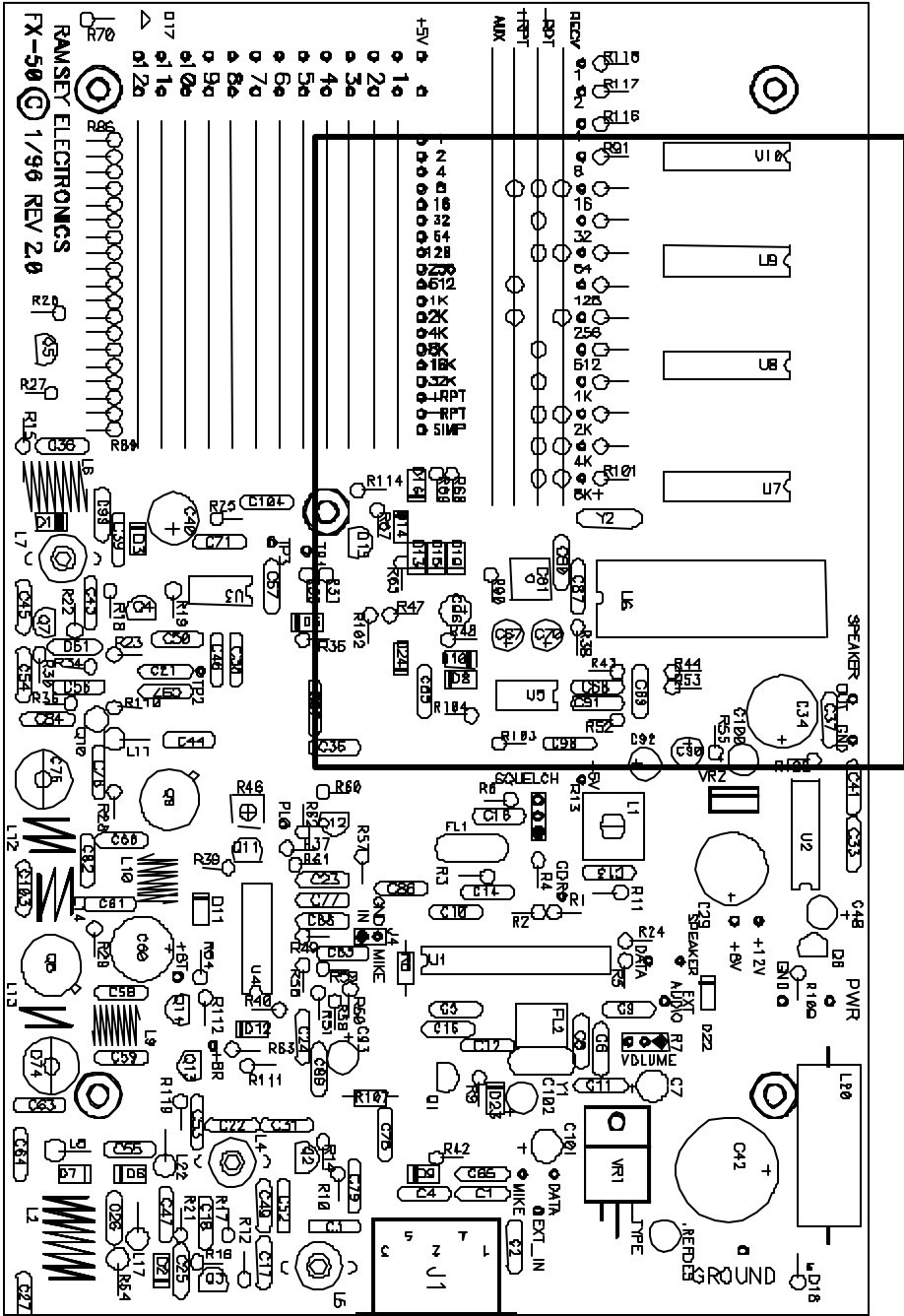

KIT ASSEMBLY PHASE 2:

- ? **Stage G: Understanding and Building the PLL Frequency Synthesizer**
- ? **Stage H: Building and Programming the Diode Matrixes**
- ? **Stage M: Microphone Amplifier and PTT Circuit**
- ? **Stage "TC": Preparing Transmitter Coils, RF Chokes**
- ? **Stage "TO": Other Transmitter Stage Preparation**
- ? **Stage TX: Transmitter Buffer, Driver and Final**

Each set of Assembly Instructions is introduced by an explanation of how that part of the circuit works and what it is for. LEARN as you build!

ALSO INCLUDED IN THIS SECTION:

- ? Detailed Explanation of PLL Frequency Synthesis
- ? How to Program the Synthesizer
- ? EASY PLL Alignment Directions

Study the REFERENCE SECTION for additional help and tips on Frequency Programming.

**Downloaded by
RadioAmateur.EU**

- ✍ 4. Connect 12V DC, speaker and antenna (2' of wire will do).
- ✍ 5. With power on and volume at a low level, s-l-o-w-l-y turn the temporary tuning potentiometer. See if you can hear a local repeater or a nearby transmitter. Because the control is sweeping through twenty MHz of spectrum, actually tuning in a station will be VERY touchy. Since the 6 meter band is sparsely populated, it may be difficult to chance upon a signal without first setting up a QSO.

The demonstration can be more interesting and useful if a digital voltmeter is added to monitor the voltage changes at TP1, and a Ramsey Frequency Counter is connected to TP2 or the top of R113. REMEMBER that the indicated VCO frequency is 21.400 MHz lower than any signal you happen to tune in. Observe how much frequency change there is per .1 volt or less of voltage change. Stay on a given frequency for a minute or so and notice how the indicated frequency drifts slightly either up or down. This observation helps us appreciate the precision control that will be offered by the PLL circuit. Finally, notice that the higher the voltage applied, the lower the varactor diode's capacitance which means the higher the VCO frequency.

If you do have a meter and counter connected, an initial setting of the slug in L7 can be made now. Adjust the voltage for 4.0 volts and tune L7 to approximately 52 MHz. (Note: final tuning of L7 will be even easier after the PLL circuitry is completed). When you are finished with this optional test, disconnect DC voltage. Then, cut the wire to TP1, leaving 1/4" soldered in place to serve as a permanent test point. If you do not wish to conduct this test, simply double-check the accuracy of your work in this stage and proceed to the Frequency Synthesizer section.

52.525 MHz Simplex before you pursue troubleshooting. It is very important to have a clear understanding of how to program the frequency synthesizer and offset matrixes of your transceiver.

NOTE ON REPLACEMENT PARTS:

If you lose or damage parts during assembly or testing, you may, of course, order any needed replacement parts by writing or faxing the Ramsey Electronics, Inc. factory. Some of the more common parts may also be picked up at Radio Shack or other local parts distributors. Use EXACT values when replacing parts. Following is a GENERAL guide to obtaining parts for your transceiver as quickly as possible:

Part ID	Type	Recommended source RE=Ramsey, RS=Radio Shack
Q1, etc.	2N3904	RS 276-1617
Q12,13,14	PNP 228256	RS276-1604 or 2N3906
Q2, etc.	2SC2498	ECG10, SK9139, 2N5179, or RE
Q10	NE02137	MRF901 or RE
Q9	2N3866	ECG311, SK3195 or RE
Q8	SD1127	MRF237, ECG341, SK9617 or RE
Signal diodes	1N4148	1N914, RS276-1620 (pack of 50)
D3	BB505	RE
D1,D2,D7	BA482	ECG553 or RE
D6	BA479	RE
D18	1N4002	RS276-1102, 1N4003
Part ID	Type	Recommended source RE=Ramsey, RS=Radio Shack
D23	6.2V Zener	RS276-561
VR1	7808	ECG964, SK3630 or RE
VR2	7805	RS276-1711
U1	MC13135	RE or Motorola
U2	LM380	ECG740A, SK3328 or RE
U3	MC12017	RE or Motorola
U4	LM324	RS276-1711
U5	LM358	ECG928, SK3691 or RE
U6	MC145152	RE or Motorola

✍ F13. TEMPORARY RECEIVER PTT/T-R CONNECTION

OMIT this step if you prefer to install ALL transceiver parts before any testing or use of the Receiver alone. If you wish to conduct further tests or put the receiver to work, it is necessary to solder a 5" length of hookup wire from the hole marked "+8R" (near Q13, R112) to the hole marked "+8V" near C29. In lieu of the switching done by the PTT circuit (Stage M), this temporary jumper applies +8V to all +8R points on the board. (You also have, of course, the option of wiring the microphone input and PTT circuitry before testing the receiver.)

OPTIONAL VCO RECEIVER TEST OR INSTRUCTIONAL DEMONSTRATION

At this point in building your transceiver, the VCO is functional but is lacking any control voltage to varactor diode D3 that would permit tuning. Supplying this precision controlled voltage is, of course, the function of the PLL Frequency Synthesizer that will be constructed next. However, for those who would benefit from such a test or demonstration, it IS fairly easy at this point to set up temporary manual or "analog" tuning with an ordinary potentiometer.

Notice on the schematic diagram that the control voltage to the tuning diodes comes from U5A through R47 and R25. Notice that a Test Point (TP1) is conveniently located at R25. The purpose of TP1 is to permit measurement of the precision voltage to the varactor diodes generated by the frequency synthesizer's phase detector. Since no such voltage is yet reaching TP1, we can put it there ourselves! If we connect a potentiometer as illustrated below, the wire soldered to TP1 can be trimmed down later to serve as the intended test point. The potentiometer will vary the voltage to D3, thereby varying the VCO frequency and tuning your receiver.

VCO AND RECEIVER TEST PROCEDURE:

- ✍ 1. Make sure work area is tidied up and that the PC board has been checked for stray scraps of wire, etc.
- ✍ 2. Use your own hookup wire and potentiometer to connect to TP1, +8V and GND as illustrated.
- ✍ 3. Turn power switch OFF and squelch fully counter clockwise.

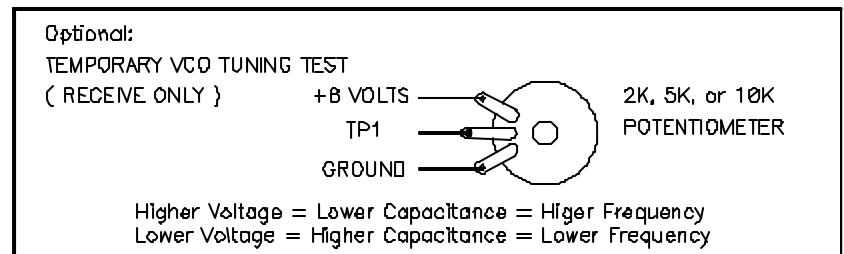

- ✍ E20. Install R19, 1K ohm (brown-black-red).
- ✍ E21. Install C38, .01 uf.
- ✍ E22. Install C46, .01 uf.
- ✍ E23. Install C50, .01 uf.
- ✍ E24. Solder a 1/2" length of bare wire (trimmed from a resistor or capacitor) into the test point hole marked TP2. This is another test point.
- ✍ E25. Install C21, 27 pf (marked 27).

The previous steps were presented as a group primarily as a help in visualizing the location of the VCO on the PC board. You have built up the VCO itself and the capacitance multiplier voltage filter provided by C40, Q4, etc. After double-checking the accuracy of your work, proceed with installing the VCO related components in Stage F.

Stage F: VCO Buffers, PLL Synthesizer, ÷65/64 Prescaler

- ✍ F1. Install Q4, 2N3904 transistor. Observe correct placement of the flat side.
- ✍ F2. Install R18, 270 ohms (red-violet-brown).
- ✍ F3. Install R23, 100 ohms, (brown-black-brown).
- ✍ F4. Install C43, 22 pf (marked 22).
- ✍ F5. Install R22, 47K (yellow-violet-orange)
- ✍ F6. Install C51, 56 pf (marked 56).
- ✍ F7. Install Q7, NPN type 2N3904. Be sure to select the correct transistor type and to orient the flat side as pictured.
- ✍ F8. Install C45, .01 uf disc capacitor.
- ✍ F9. Install R30, 51 ohms (green-brown-black).
- ✍ F10. Install C54, 100 pf (marked 100).
- ✍ F11. Install L7, another blue color, 5.5 turn plastic molded adjustable coil.
- ✍ F12. Install L6, the pre-wound 11 turn .228" diameter coil. It has more turns than the other two pre-wound coils in your kit.

A Radio Shack or local electronic parts distributor:

Resistors, electrolytic capacitors, disc capacitors, common NPN or PNP transistors, Zener diodes, switching diodes, voltage regulator (5V), hookup wire, LED, controls, antenna connector, replacement 1-amp fuses.

B Order from RAMSEY ELECTRONICS:

Most RF and VHF transistors, coils, crystals, PIN diodes, varactor diodes, trimmers, filters and most IC chips.

C U1 and U6 are Motorola devices

These parts might be in stock at service shops featuring Motorola equipment. There are acceptable "standard replacements" for some of the semiconductors used in the transceiver. "SK" and "ECG" standard replacements are stocked by local electronics parts distributors or may be ordered through a Radio Shack store. The following chart should help you make the most cost-effective choice if replacement semiconductors are needed:

The RAMSEY FX Transceiver Kit WARRANTY

Please read carefully BEFORE calling or writing in about your Kit. Most problems can be solved WITHOUT contacting the Factory!

Notice that this is not a "fine print" warranty. We want you to understand your rights and ours too! All Ramsey kits will work if assembled properly. The very fact that your kit includes this manual is your assurance that a team of knowledgeable people have field-tested several "copies" of this kit straight from the Ramsey inventory. If you need help, please read through the manual carefully: all information required to properly build and test your kit is contained within its pages! In particular, the FX Transceiver has been documented exhaustively.

1. DEFECTIVE PARTS: It's always easiest to blame a part for a problem in your kit. Before you conclude that a part may be bad, thoroughly check your work. Today's semiconductors and passive components have reached incredibly high reliability levels, and it's sad to say that our human construction skills have not. Very rarely, a sour component might slip through. All our kit parts carry the Ramsey Electronics Warranty that they are free from defects for a full (90) days from the date of purchase. Defective parts will be replaced at our expense. If you suspect a part to be defective, please mail it to our factory for testing and replacement. Please send only the defective part(s), NOT the entire kit. The part(s) MUST be returned to us in suitable condition for testing. Please be aware that testing can usually determine if the part was truly defective or damaged by assembly or usage. Don't be afraid to tell us that you "blew it". We're all human: in most cases, replacement parts are very reasonably priced.

2. MISSING PARTS: Ramsey Electronics project kits are packed with pride in the U.S.A. If you believe we packed an incorrect part or omitted a part clearly indicated in your assembly manual as supplied with the basic kit by Ramsey, please write us with information on the part you need and proof of the kit purchase. Before assuming a part value is incorrect, check the parts list carefully to see if it is a critical value such as a specific coil or IC, or whether a range of values is suitable (such as 100 to 500 ufd.). Often, common sense will solve a mysterious missing part problem. If you are missing five 10K ohm resistors and find five extra 1K resistors, a simple VOM check will likely confirm that the "1K" resistors are actually the "missing" 10K units. ("Hmmm, I guess the red band really does look orange!")

3. FACTORY REPAIR OF ASSEMBLED KITS: To qualify for Ramsey Electronics factory repair, kits MUST:

1. NOT be assembled with acid core solder or flux.
2. NOT be modified in any manner.
3. BE returned in fully assembled form, not partially assembled.
4. BE accompanied by payment of the proper repair fee. No repair will be begun until we have received the MINIMUM repair fee of \$49.00, or authorization to charge it to your credit card account.

INCLUDE a description of the problem and legible return address. Do not send a separate letter: include all correspondence with the unit. Please do not include your own hardware such as non-Ramsey cabinets, knobs, cables, external battery packs, and the like. Ramsey Electronics reserves the right to refuse to repair ANY item in which we find excessive problems or damage due to construction methods. To assist customers in such situations, Ramsey Electronics, Inc. reserves the right to solve their needs on a case-by-case basis without creating policy or precedent.

Please understand that our technicians are not volunteers and that set-up, testing, diagnosis, repair and paper work can easily take over two hours of paid employee time on even a simple problem. **Understand too, that alignment is part of the kit building process and is not covered by this Warranty.** Of course, if we find that a part was defective in original manufacture, there will be no charge to repair your kit (But please realize that our technicians know the difference between a defective part and parts burned out or damaged through improper use or assembly.)

4. REFUNDS: You are given ten (10) days to examine our products. If you are not satisfied, you may return your unassembled kit with all parts and instructions and proof of purchase to the factory for a full refund. The returned package should be packed securely. Insurance is recommended. Please do not cause needless delays, read all information carefully.

RAMSEY ELECTRONICS, INC. 793 Canning Parkway, Victor, New York 14564
Telephone 716-924-4560 Fax 716-924-4555

Stage E: BASIC VCO ASSEMBLY

In this Stage, we will assemble the basic VCO (Voltage Controlled Oscillator) circuit. Understanding the function of this stage is especially important for knowing how the FX transceiver works.

- E1. Install R26, 100K ohms (brown-black-yellow).
- E2. Install Q5, 2N3904 transistor, observe correct placement of the flat side.
- E3. Install R27, 10K (brown-black-orange).
- E4. Install R15, 1K (brown-black-red).
- E5. Install C36, .01 (marked .01 or 103 or 10 nf).
- E6. Install PIN diode D1, BA482 (small glass body marked BA482). Observe orientation of cathode band.
- E7. Install C99, .01 uf.
- E8. Install C39, 100 pf, (marked 100 or 101).
- E9. Install varactor diode D3, type FS4059. It has a small glass black body with a yellow band. Be certain of correct diode identification and orientation of the banded cathode end.
- E10. Install C40, 47 uf electrolytic. Watch correct polarity.
- E11. Install R25, 47K (yellow-violet-orange).
- E12. Install C104, .01 uf disc capacitor (marked .01 or 103).
- E13. Install C71, .001 uf (marked .001 or 102).
- E14. Install R31, 47K ohms (yellow-violet-orange).
- E15. Install R33, 47K (yellow-violet-orange).
- E16. Install D5, 1N4148 style signal diode. Observe correct orientation of the cathode band.
- E17. Solder 1/2 " lengths of bare wire (trimmed from resistors or capacitors) in the two test point holes marked TP1 and TP3. These wires stick up from the PC board and provide a convenient point to connect a test probe.
- E18. Install C57, .01 uf 7b.
- E19. Install U3, MC12017. If you've elected to use sockets, do not use a socket for this part. Be sure to observe correct orientation of this part.

The control voltage for D3, the varactor diode is supplied through R47 and R25 by the output of U5:A in the PLL synthesizer circuit.

We know already that there must be a 21.4 MHz difference between the receive and transmit frequencies of the VCO. This swing cannot be accomplished by PLL programming alone. The VCO must be able to stay "in range" with the synthesizer. Inductors L6 and L7 work in series during receive, which increases their total inductance to the VCO circuit and more inductance means a lower frequency. In transmit mode, PIN diode D1 is turned on, thus shunting VCO coil L7 to ground directly, bypassing L6's additional inductance. This causes the VCO to be able to tune higher in frequency, and is accomplished by transistor switch Q5.

The output from Q7 is fed into U3, MC12017P, a Ñ64/65 prescaler which divides down the VHF signal to a lower frequency which the PLL chip can process. The VCO U1 through C35 for receive, and Q10 through C56 for transmit.

Another important role of the VCO is that it is the stage that is modulated by microphone amplifier U4, which is discussed in Stage M. Notice that the microphone amplifier output is coupled through C62 directly to the voltage control line for the varactor diodes. Therefore, any voltage variation imposed on that line will vary the VCO frequency in step with that variation. If the frequency is varied in step with speech patterns or other audio signals such as tone shifts, we are generating 'frequency modulation', hence 'FM'.

D5 and R31 perform an interesting function. Remember that the VCO control voltage has a range of about 1.0 volts DC (low frequency) to 7.0 volts (high frequency). Therefore, more modulation voltage is needed at higher VCO frequencies. As the VCO control voltage increases, D5 turns on and places R31 in parallel with R33, reducing the resistance in the line to half and thereby increasing available modulation voltage.

Finally, it should make sense that the VCO should have a very pure source of well-filtered DC, completely free of AC hum, alternator whine or other disturbance. R19 and 47 uf. C40 form a basic low pass filter. Transistor Q4 serves as an electronic capacitance multiplier. The actual effect of the filter is that the beta of Q4 multiplies the 47 uf to the equivalent of installing a huge 4000-5000 uf capacitor in the VCO area.

KIT ASSEMBLY PHASE 1:

Stage A: DC Power Regulation & Distribution Packet Data I/O Connector	Plus
Stage B: Receiver Audio Amplifier	
Stage CR: Integrated Circuit FM Receiver	
Stage DR: Receiver, Tuned RF Input and Preamp	
Stage E-F: Transceiver VCO with Buffer Stages	

Each set of Assembly Instructions is introduced by an explanation of how that part of the circuit works and what it is for. LEARN as you build!

ALSO INCLUDED IN THIS SECTION:

- Master Kit Parts List
- Important Information About Kit Parts and the Printed Circuit Board.

TOOLS AND EQUIPMENT REQUIRED FOR CONSTRUCTION, PLL SYNTHESIZER ALIGNMENT, & TRANSMITTER ADJUSTMENT

- ✍ Medium-heat (25 to 50 watt) soldering pencil with clean, tinned tip
- ✍ Damp sponge to keep soldering tip clean
- ✍ Thin diameter ROSIN core solder
- ✍ Diagonal cutters or wire nippers
- ✍ Wire strippers
- ✍ Small pair of pliers
- ✍ Small screwdriver
- ✍ Ruler
- ✍ Tweezers (to install SMT C75)
- ✍ Non-metallic alignment tool
- ✍ Digital Voltmeter (DVM)
- ✍ 50-ohm Dummy Load (5-10 watt rating)
- ✍ VHF RF power output meter

ALIGNMENT: A feature of the FX design is that Synthesizer Alignment can be accomplished by listening carefully to a transmitted signal of known accuracy. To adjust trimmer capacitor C81 "by the numbers," use your Ramsey Frequency Counter or a digitally accurate VHF receiver with BFO.

FX-50 MASTER PARTS LIST

Before beginning assembly, take some time to check and organize these kit components in such a way that you can find them easily and not lose any or confuse them. Leave parts supplied on tape strips in the strips until you need them. The following headings also provide logical sorting categories. Popular methods for organizing parts include egg cartons, muffin tins, corrugated cardboard edges, or pressing the leads into a block of Styrofoam.

INTEGRATED CIRCUITS

- ✂ 1 MC13135 24-pin DIP FM Receiver IC (U1)
- ✂ 1 LM380 14-pin DIP Audio Amplifier IC (U2) [Do NOT use socket]
- ✂ 1 MC12017P 8-pin DIP divide-by 64/65 Prescaler (U3)
- ✂ 1 LM324 14-pin DIP Quad Op-amp IC (U4)
- ✂ 1 LM358 8-pin DIP Dual Op-amp IC (U5)
- ✂ 1 MC145152 28-pin DIP PLL Synthesizer IC (U6)
- ✂ 4 74HC283 16-pin high speed 4-bit Binary Adder (U7,U8,U9,U10)
- ✂ 1 7808 8V voltage regulator [VR1]
- ✂ 1 7805 5V voltage regulator [VR2]

TRANSISTORS:

- ✂ 7 NPN transistor, type 2N3904 or equivalent (Q1,4,5,6,7,11,15)
- ✂ 3 PNP transistor, 2N3906-type [marked 228256] (Q12,13,14)
- ✂ 2 NPN VHF type 2SC2498 or 2570 (Q2,3) (Sort these carefully from the 5 type 2N3904 for Q1, etc.)
- ✂ 1 RF NPN type 2N3866 (transmit driver, Q9)
- ✂ 1 RF NPN type MRF237 or SD1127 (transmit final, Q8)

DIODES (Note color code descriptions CARE FULLY!):

- ✂ 1 LED (D17, transmit indicator)
- ✂ 100+ 1N914 or 1N4148 switching diode (D4,5,8,9,10,11,12,13,14,15,16,19,22,24, plus PLL matrix)
- ✂ 1 Varactor diode, type FS4059 (D3) [black body with yellow band]
- ✂ 1 PIN diode, type BA479 (D6)
- ✂ 3 PIN diode, type BA482 (D1,D2, D7) [orange body, red band]
- ✂ 1 1N4002 rectifier diode (D18) [largest black body, gold band]
- ✂ 1 6.2 volt zener diode 1N5234 (D23) [gray body with black band]

Stage E-F: The FX Transceiver VCO

The VCO (Voltage Controlled Oscillator) provides basic frequency control for both transmit and receive modes. It is essential to understand its function in the transceiver circuit. Q7 is the oscillator transistor and the key VCO components are L7 and D3.

Think of the VCO for now as just a simple 'VFO' type RF oscillator whose output frequency can be changed by adjusting the slug in L7. Notice that there are no capacitors, either fixed or variable, to form a 'tuned-circuit' with L7. Instead, varactor diode D3 performs this function. (A varactor diode changes capacitance in step with the amount of voltage applied across it.) If the output of this simple oscillator reaches U1 through C35, you would certainly be able to receive any signals on a frequency determined by that oscillator frequency plus or minus 21.4 MHz, the Receiver 1st IF. Similarly, if the oscillator output could reach Q9 and Q8 in the transmit section, or even the transmit buffer, Q10, some sort of signal could be put on the air.

After the VCO is assembled on the PC board, the interested builder has the option of experimenting with it in receive mode before proceeding. The VCO must be capable of considerable frequency range. To receive a signal at 50 MHz, the VCO must tune to 50 MHz minus 21.4 MHz or 28.6 MHz. To transmit at 54 MHz, it must tune to 54 MHz. This indicates a tuning range of over 25 MHz!

What we have so far is a master oscillator for the transceiver that can be tuned by varying the voltage applied to the varactor diodes. All we really need now is some precision way of controlling the voltage applied to those varactor diodes so that we can put that oscillator on any VHF channel we want with 5 KHz precision. And this control obviously must be extremely stable, since a change of only a few picofarads can tune through many MHz of VHF spectrum. We know we can get stability by using a crystal oscillator, but that would not allow us to operate on a multitude of channels without changing crystals for each channel. How can we get such precision performance from small tuning diodes, a very ordinary shielded coil, and a transistor with its supporting capacitors and resistors?

We guess already that the answer must lie in the functions of the Frequency Synthesizer IC. However, the key to grasping what this IC really does lies in understanding TWO concepts: frequency synthesis and the "Phase Locked Loop" or PLL. The more of a handle that you can get on these two interconnected ideas, the less mysterious your FX transceiver as well most other modern radio gear will be - from ham transceivers to car stereos to cellular phones. The VCO is an integral part of the phase locked loop. You can read ahead about PLL and synthesis in the next section, or you can proceed with building and testing the VCO alone.

VCO CIRCUIT SUMMARY:

Stages E - F: Transceiver VCO (Voltage Controlled Oscillator) and Buffer Stages

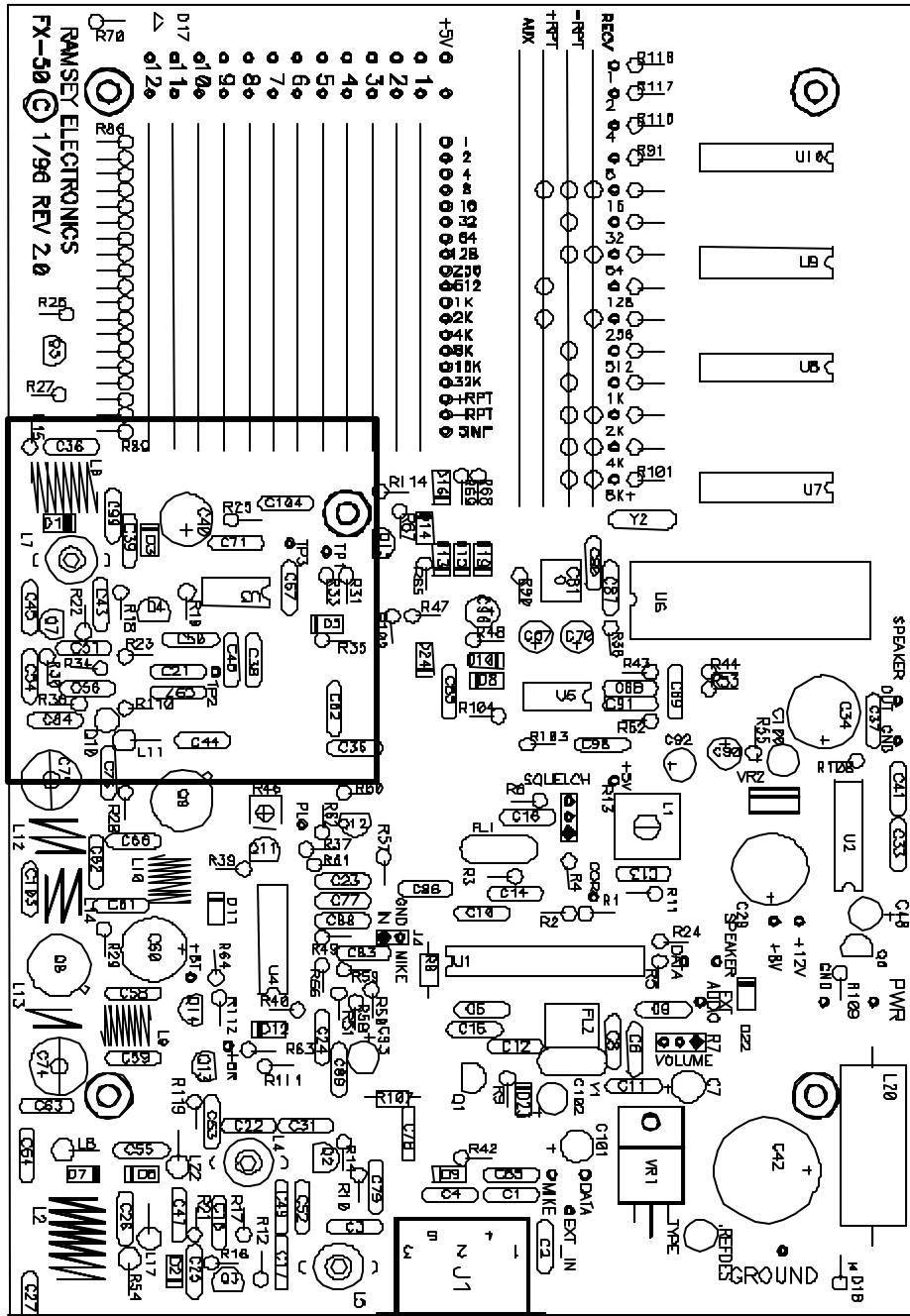

CRYSTALS:

- ✂ 1 10.240 MHz, has 2 leads (Y2, PLL reference frequency)
- ✂ 1 21.855 MHz, has 2 leads (Y1, receiver IF oscillator)
- ✂ 1 21.4 MHz crystal filter, has 3 leads (FL1, 1st IF filter)

INDUCTORS:

- ✂ 1 455 KHz shielded inductor, marked LB53303HK (L1)
- ✂ 2 7.5 turn, 5/16 diameter to be wound in assembly (L2,3,)
- ✂ 3 5.5 turn blue plastic adjustable coil (L4,5,7)
- ✂ 1 11 turn .228 diameter pre-wound coil (L6)
- ✂ 4 2.2 uH. molded RF choke, green with red and gold color bands (L8,11, 17, 22)
- ✂ 2 8 turn .228 diameter pre-wound coil (L9,10)
- ✂ 2 2.5 turn, 5/16 dia. to be wound in assembly (L12, 14)
- ✂ 1 1.5 turn, 5/16 dia. to be wound in assembly (L13)
- ✂ 1 500 uH noise suppression choke, large with black shrink tubing over the body (L20)

SPECIALIZED COMPONENTS:

- ✂ 1 Ramsey FX-series main and low pass filter printed circuit boards
- ✂ 1 455 KHz ceramic filter, molded cube, 3 pins. (FL2)

INTERNAL ALIGNMENT COMPONENTS:

- ✂ 1 10K trimmer potentiometers, marked 103 (R46)
- ✂ 2 60 pf trimmer capacitors (C74,C75)
- ✂ 1 35 pf trimmer capacitor (black body, orange top)(C81)

FIXED-VALUE CAPACITORS (RF-critical picofarad values):

- ✂ 1 8.2 pf (C49)
- ✂ 1 15 pf (C80)
- ✂ 4 22 pf (C15,17,31,43)
- ✂ 5 27 pf (C21,22,52,63,82)
- ✂ 1 39 pf (C87)
- ✂ 1 56 pf (C51)
- ✂ 2 82 pf (C20,27)
- ✂ 7 100 pf (may be marked 100 or 101)(C26,30,35,39,54,64,76)
- ✂ 1 100 pf chip capacitor (C72)
- ✂ 1 120 pf (C12)
- ✂ 1 150 pf (C103)
- ✂ 1 220 pf (C28)

ADDITIONAL DISC CAPACITORS:

- ✍ 16 .001 uf (may be marked .001, 102 or 1nf)
(C1,2,3,4,10,23,24,56,62,66,71,77,83,86,88,89)
- ✍ 26 .01uf (may be marked .01, 103 or 10 nf)
(C11,16,18,25,33,36,37,38,44,45,46,47,50,53,55,57,59,61,69,78,79,84,97, 98,99,104)
- ✍ 2 .047 uf (C68,91)
- ✍ 10 .1 uf (may be marked .1 or 104) (C5,6,8,9,13,14,41,58,65,85)

ELECTROLYTIC (Polarized) CAPACITORS:

- ✍ 4 2.2 uf electrolytic (C67,C70,C90,C92)
- ✍ 8 4.7 to 10 uf electrolytic (C7,48,93,95,96,100,101,102)
- ✍ 1 47 uf electrolytic (C40)
- ✍ 1 220 uf electrolytic (C60)
- ✍ 1 330 uf electrolytic (C29)
- ✍ 1 470 uf, electrolytic (C34)
- ✍ 1 1500 uf electrolytic (C42)

FIXED RESISTORS:

- ✍ 1 2 ohm [red-black-gold] (R108)
- ✍ 1 15 ohm [brown-green-black] (R36)
- ✍ 5 51 ohm [green-brown-black] (R8,12,28,29,30)
- ✍ 5 100 ohm [brown-black-brown] (R10,23,34,105,119)
- ✍ 3 220 ohm, 1/2 watt [red-red-brown] (R32,45,54){This resistor may range from 200 to 240 ohms.}
- ✍ 5 270 ohm [red-violet-brown] (R9,17,18,20,58)
- ✍ 3 470 ohm [yellow-violet-brown] (R21,63,64)
- ✍ 12 1K ohms [brown-black-red] (R2,3,15,19,65,68,69,70,113,114,115)
- ✍ 3 2.2K ohms [red-red-red] (R42,57,61)
- ✍ 2 4.7K ohms [yellow-violet-red] (R111,112)
- ✍ 1 3.3K ohms [orange-orange-red] (R6)
- ✍ 19 10K ohms [brown-black-orange] (R5,16,24,27,38,47,48,49,50,55,60,62,67,90,102,104,106,107,110)
- ✍ 4 22K ohms [red-red-orange] (R43,44,52,53)
- ✍ 12 47K ohms [yellow-violet-orange] (R11,14,22,25,31,33,39,51,56,66,103,109)
- ✍ 1 68K ohms [blue-gray-orange] (R4)
- ✍ 38 100K ohms [brown-black-yellow] (R26,35,37,40,59,71-89,91-101,116,117,118)
- ✍ 1 470K ohms [yellow-violet-yellow] (R1)

CONTROLS, HARDWARE AND MISC.

- ✍ 1 volume control potentiometer with switch (may be any value from 10K to 100K) (R7,S1)

- ✍ DR17. Install C22, 27 pf (marked 27).
 - ✍ DR18. Install C49, 8.2 pf.
 - ✍ DR19. Install C52, 27 pf (marked 27).
 - ✍ DR20. Install C31, 22 pf.
 - ✍ DR21. Install C18, .01 pf (marked .01 or 103).
 - ✍ DR22. Install R10, 100 ohm (brown-black-brown).
 - ✍ DR23. Install R14, 47K ohm (yellow-violet-orange).
 - ✍ DR24. Install Q2, 2SC2498 transistor. Observe correct placement of the flat side.
 - ✍ DR25. Install C79, .01 uf.
- INTERMISSION: Notice how our work is methodically creeping toward all the FM IC circuitry you did in Stage CR ?
- ✍ DR26. Install C78, .01 uf.
 - ✍ DR27. Locate one of the three blue colored molded plastic adjustable coils. Install one in the L4 location.
 - ✍ DR28. Install another blue plastic coil in the L5 location.
- Coils L2 and L3 will be installed later when we wind all the coils at one time.

Stage DR Progress Note:

No other testing is required at this point other than to double-check the accuracy of your parts installations. However, experienced builders will recognize that VHF signals could now be received very well by connecting an antenna and tuning a signal generator coupled to pin 2 of U1, provided that the T-R circuitry is operational. A more useful preliminary receiver test will be conducted after we complete the VCO stage.

STAGE DR ASSEMBLY:

In keeping with our “learn-as-you-build” kit building philosophy, we will install only the components needed for receiving.

Be very attentive to capacitor values (in picofarads) and to coil descriptions throughout this section.

- ✂ DR1. Install C26, 100 pf (marked 100 or 101).
- ✂ DR2. Install L17, 2.2 uH in upright position with the inductor's body in the designated hole. This is a molded inductor, resembling a resistor but is larger. Look for 2 red bands on its body.
- ✂ DR3. Because it must dissipate slightly more power, resistor R54 is larger than most of the resistors used in this circuit. Its value may be 200 or 220 ohms (red-black-brown, or red-red-brown). Install R54 in upright style.
- ✂ DR4. Install C47, .01 uf (marked .01 or 103).
- ✂ DR5. Correctly identify and install PIN diode D6. It is the only BA479 used in the circuit and its number is stamped on the diode body. Be sure to orient the cathode end correctly!
- ✂ DR6. Install L22, another 2.2 uH in upright position with the inductor's body in the designated hole. This is a molded inductor, resembling a resistor but larger with 2 red bands on its body.
- ✂ DR7. Install R21, 470 ohms (yellow-violet-brown).
- ✂ DR8. Install R119, 100 ohm (brown-black-brown).
- ✂ DR9. Install R16, 10K ohms (brown-black-yellow).
- ✂ DR10. Install D2, BA482 PIN diode (marked BA482). Be sure to orient the cathode band properly.
- ✂ DR11. Install C53, .01 uf disc capacitor (marked .01 or 103).
- ✂ DR12. Install C25, .01 uf (marked .01 or 103).
- ✂ DR13. Install Q3, 2SC2498 transistor, observe correct placement of the flat side.
- ✂ DR14. Install R17, 270 ohm (red-violet-brown).
- ✂ DR15. Install R12, 51 ohms (green-brown-black).
- ✂ DR16. Install C17, 22 pf. (marked 22).

- ✂ 1 10K squelch control potentiometer (R13)
- ✂ 1 12-position rotary switch (S2)
- ✂ 1 3.5 mm. jack, miniature (J2, speaker)
- ✂ 1 2.5 mm. jack, subminiature (J4, microphone)
- ✂ 1 5-pin female DIN PC-mount connector (J1, packet)
- ✂ 1 SO-239 coaxial RF connector (J3)
- ✂ 1 28 pin DIP IC socket (for U6)
- ✂ 1 DC power cord with inline fuseholder and 1A fuse
- ✂ 1 1/2" panel-mount strain relief for DC power cord
- ✂ 1 length of No. 20 bus wire (to make diode matrix bridges)
- ✂ 1 length of No. 24 bus wire (to make L9 and L19)
- ✂ 1 hookup wire, as needed (may include 1,2, or 3 conductors)
- ✂ 3 wire cable ties
- ✂ 1 5/16"x 18 bolt (to wind coils on for perfect spacing)
- ✂ 1 document packet, including this manual

REQUIRED, NOT SUPPLIED WITH KIT:

- ✂ Thin-diameter rosin-core solder
- ✂ Correct tools for all phases of assembly (see text)
- ✂ Microphone and speaker per specifications in text (J2,J4 and PTT circuit are designed for ICOM-type mike)
- ✂ Fused, 13.5 VDC power supply or battery
- ✂ 50-ohm dummy load
- ✂ 50-ohm 2-meter antenna with PL259 or adapter

OPTIONAL, RECOMMENDED:

- ✂ Ramsey CFX Transceiver Case and Knob Kit

IMPORTANT:

For proper RF shielding and secure mounting of controls, connectors, and the PC board, immediate consideration must be given to the transceiver enclosure as an integral part of the assembly process. The CFX matching case set is the quality, custom designed finishing touch for your transceiver.

VERY IMPORTANT PC BOARD ASSEMBLY INFORMATION FOR A-L-L OUR BUILDERS!

1. Your FX-transceiver PC board is double-clad with plated-through holes. What this means in practice is that it is VERY important to select and install correct part values the FIRST time around. This type of board makes "desoldering" much more difficult and risky because the solder adheres inside the hole and flows to the component side of the board as well. It is VERY tricky to remove a part without damaging it. If too much de-soldering heat or component "pulling" is used, there is also the serious risk of damaging small PC board traces. Be careful and methodical in assembly!!!
2. Do not, under any circumstances, install L9, R32 or L10 until instructed to do so in Assembly Stage "TX." This applies even if you are following your own assembly sequence. This procedure will prevent damage to Q9 and Q8 during the initial test and alignment procedure.
3. Do not attempt to "re-engineer" our transistor orientation illustrations. Simply point flat sides or tabs as illustrated.
4. After installing all parts, you will see a few empty holes in the circuit traces on the top or component side of the board. These plated-through holes are placed intentionally to connect with traces on the solder side. The hole IS the connection! However, if these holes nag at you, simply fill them in with a touch of solder -- AFTER verifying that all parts have been placed and installed correctly.
5. Additional "empty" holes are marked on the PC board to allow for easy connection of accessories or modifications as you begin to customize your transceiver. See "GUIDE TO FX CIRCUIT ACCESS POINTS."
6. The purpose of check boxes "☒" in the assembly steps is to make it easy to check the accuracy of your work at the end of each step.
7. Almost all resistors are mounted in a vertical (upright) position. You can see that the wire leads for resistors come in several styles. If a resistor's pre-trimmed lead is ever too short for upright installation, simply solder a scrap wire nipped from another resistor to extend its length.
8. Some of the resistors and miniature inductors used in this project require upright or vertical installation. It is important to follow the orientation illustrated for vertically installed parts. Always put the body of the part in the hole with the circle!
9. Whenever you have a choice, install parts with stamped markings so that you can still see the markings later. This will help greatly with any possible troubleshooting needed.
10. PARTS SORTING: In a kit of this size and complexity, there is no single best way to sort and organize the 300+ individual components used. We

Stage DR: Antenna Input and RF Preamplifier

The operation of the FM receiver IC was discussed in Stage CR. The purpose of the following circuitry is to minimize the strength of unwanted signals and to boost signals in the 50 - 54 MHz range before they reach the 1st mixer input of U1 (pin 22). In addition, the circuit includes PIN diodes for proper T-R (transmit-receive) switching.

Let's follow the signal path briefly from the antenna jack, remembering that the antenna is "picking up" thousands of signals from all over the radio spectrum. Capacitors C20, 26, 27, 28, 30, and L2, L3 form a low pass filter, suppressing unwanted signals that are higher than the desired receiving range. The filtered signals are coupled through C47 to Q3, a low noise preamp stage and then on to a band pass filter network consisting of C17, 22, 49, 31, 52, and L4 and 5. For use in very high RF environments, an optional helical filter may be installed in place of this band pass filter.

Helical filters provide excellent filtering characteristics, although at a cost - typically \$20 to \$25. We leave this option open to you!

The RF present now strongly favors signals that are in the desired frequency range of interest. This RF is amplified again by Q2 and then applied to U1, the main receiver IC chip. The RF from the antenna input to U1 now can be said to be restricted to the desired tuning range of the transceiver. Unwanted signals have been doubly rejected, and the desirable signals have been doubly amplified.

Take a look at PIN diodes D2, D6 and D7. These tiny diodes are amazing devices which have made relays and so forth all but obsolete for T-R switching purposes. To put it simply, a PIN diode can pass RF energy either way when it is turned on by DC voltage and also block RF from the other direction when it is not powered by DC. Just picture RF passing with the anode "arrow" and picture the cathode band as a barrier.

The symbols "+8R" and "8T" mean that voltage is present at such a point during Receive or Transmit only, not both at the same time.

During Receive, D6 is "on" and permits RF to flow from the antenna through C47 to the filter and amplifier stages just discussed. Because any DC device needs a ground connection as well as +DC, D6 is grounded through RF choke L17, which prevents the antenna RF from being shorted to ground. During Transmit, D7 passes RF from the transmitter to the antenna, and L17 again prevents loss of RF to ground.

During transmit, D6 is blocking transmitter RF from the receiver circuit. For maximum protection of the more delicate receiver circuitry, D2 is turned on during transmit to short any stray RF directly to ground.

Stage DR: Receiver Tuned RF Input and Preamp

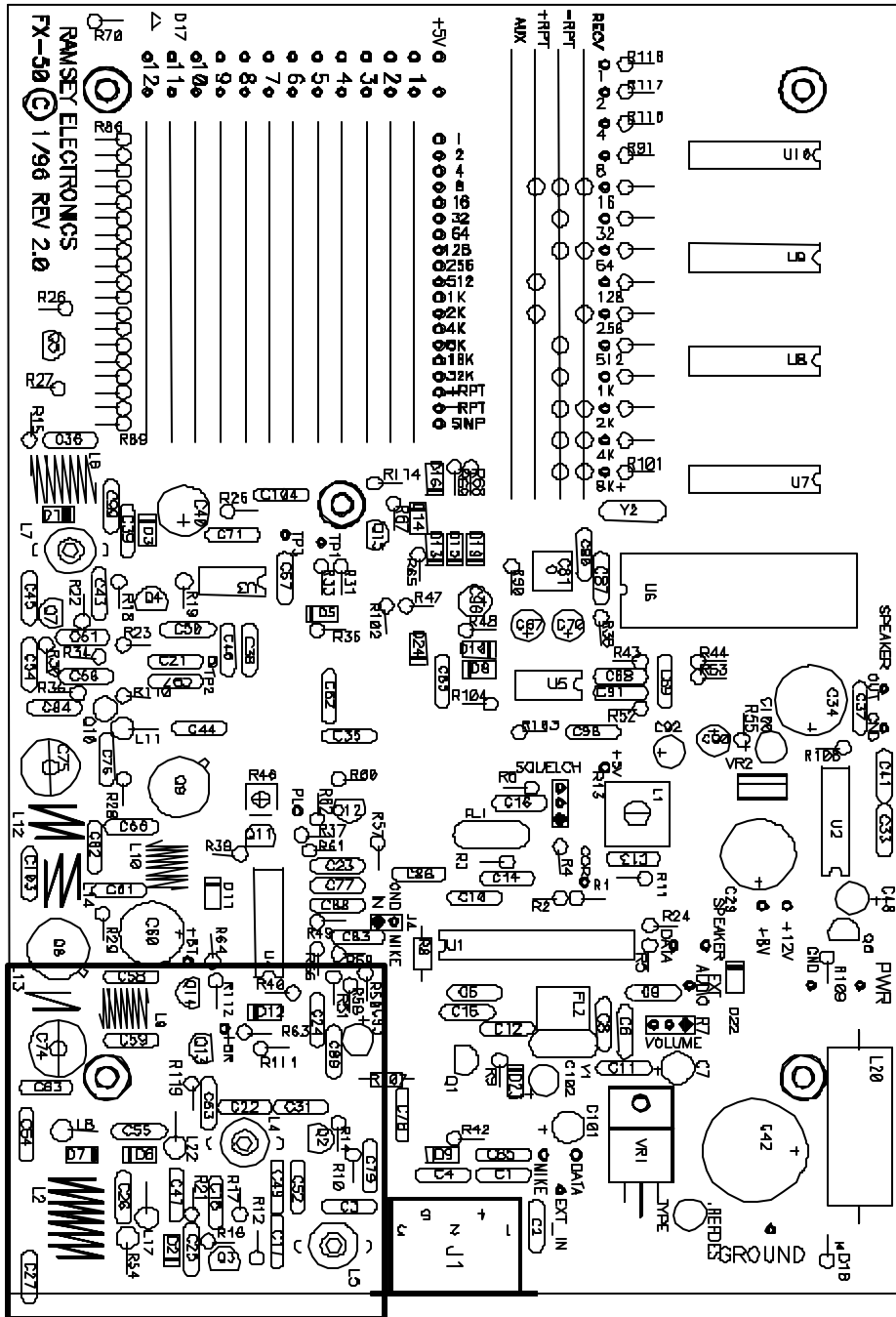

at the factory have tried to help by grouping similar or related parts in individual sealed bags. Sorting organizers popular among kit builders include empty egg cartons, muffin tins, small box tops, or the corrugated edges of box cartons. Since the assembly of this kit is presented in distinct stages, some builders may prefer to group their parts by stage before beginning assembly.

11. **HELPFUL HINT:** Many of the parts are supplied on tape strips cut from bulk reels. Leave them taped, which keeps them nicely sorted for you. It is NOT necessary to pull the entire lengths of both leads from the tape. Simply nip the leads right at the edge of the tape, and you'll have plenty of length to work with.
12. The .01 disc capacitors may be marked in any of the following ways: .01, 103 or 10n (nanofarads)
13. Similarly, .001 ufd. discs may be marked: .001, 102 or 1n(nanofarads)
14. The several .1 uf units required should be clearly recognizable and often will have a rectangular rather than disc shape. Their markings may be .1 or 104.
15. Small picofarad values are clearly stamped on capacitor bodies. 100 pf. units may be marked 100 or 101.
16. We tried to make it clear in both lists and assembly steps that some components can have a RANGE of acceptable values, even though a single value is indicated on the schematic, the control document for this project. A rule of thumb is that a value within 10% of the stated value will be fine: 2 or 2.2 pf, 4.7 or 5 pf, 200 or 220 ohm and so forth. 10 uf electrolytics may be 4.7 to 10 uf. Remember that there's a reason for the "tolerance" codes for all parts. Unless we scream in bold print that something must be exact down to the last micro-henry, ohm or partial picofarad, PLEASE assume the 10% rule in sorting through your kit parts!
17. Manufacturer stamping patterns can vary, and we sometimes need to use simple logic and deduction to identify parts, particularly the extremely common ones. For example: if your kit includes 3 identical transistors with no apparent body marking at all, you may presume them to be the 3 PNP transistors described as 2N3906, 228256 or equivalent.
18. Check your manual or kit package for any insert page advising that a part identification or physical description has changed. We cannot control how manufacturers may vary their product codes or colors of plastic.
19. Observe correct POLARITY when installing all diodes and electrolytic capacitors!
20. Install all parts as close to the circuit board as possible unless otherwise noted!
21. Please review No. 1 above!

22. Use the extra spaces provided throughout this manual to write down the details of any changes or revisions noted on additional sheets that may be supplied with your kit.
23. You will be installing various wires for switches, controls and jacks very early in the assembly procedure. This is contrary to normal building or manufacturing practice but will permit progressive testing of completed stages. Follow the suggestion at the end of Stage CR for tying down these wires for protection and your convenience during further assembly work.
24. Examine your FX circuit board. Notice that the side with silk-screened part outlines is covered almost completely with groundplane copper beneath the green solder mask. This side is the Top or COMPONENT SIDE of the board. All parts (except SMT C75) will be mounted on this side. The other side has most of the printed circuit traces and is called the Bottom or CIRCUIT SIDE.

ABOUT THE WIRE SUPPLIED WITH YOUR KIT:

Your kit parts include lengths of wire for making all needed connections from the PC board to the controls and jacks. Because there is nothing critical in the functions of these wires, the color and style of wire lengths actually packed in your kit may vary. You may receive lengths of 2 or 3 conductor wire (such as speaker cable or ribbon cable) or a supply of simple single conductor hookup wire. Use the heavier gauge wire for the power supply connections in the following steps, saving the lighter gauge wire for jacks and controls. The bare wire is used for constructing the diode matrix for frequency programming and for making a few coils and RF chokes.

TINNING" is the process of heating the stripped end of a wire and LIGHTLY flowing solder so that all strands are bonded together. This practice, while not essential, generally makes for easier soldering and physically stronger connections. BROKEN WIRES are the primary cause of malfunctions in ham equipment and computers! Please follow our instructions in Stage CR (PAGE 27) for securing completed cables to the PC board temporarily so the connections will not get damaged during further assembly.

IMPORTANT NOTE REGARDING FLEXING WIRES: In Stages A, B, CR, and M, you will install numerous wires from the PC board for panel controls and jacks. Repeated flipping of the board during assembly can damage these wires and also become very annoying during kit assembly. PLEASE tie the wires down as noted on page 27, using one of the cable ties provided.

Take your time, learn about what you're doing and ENJOY your FM Transceiver project!

FX SERIES TRANSCEIVER Simplified Receiver Block Diagram

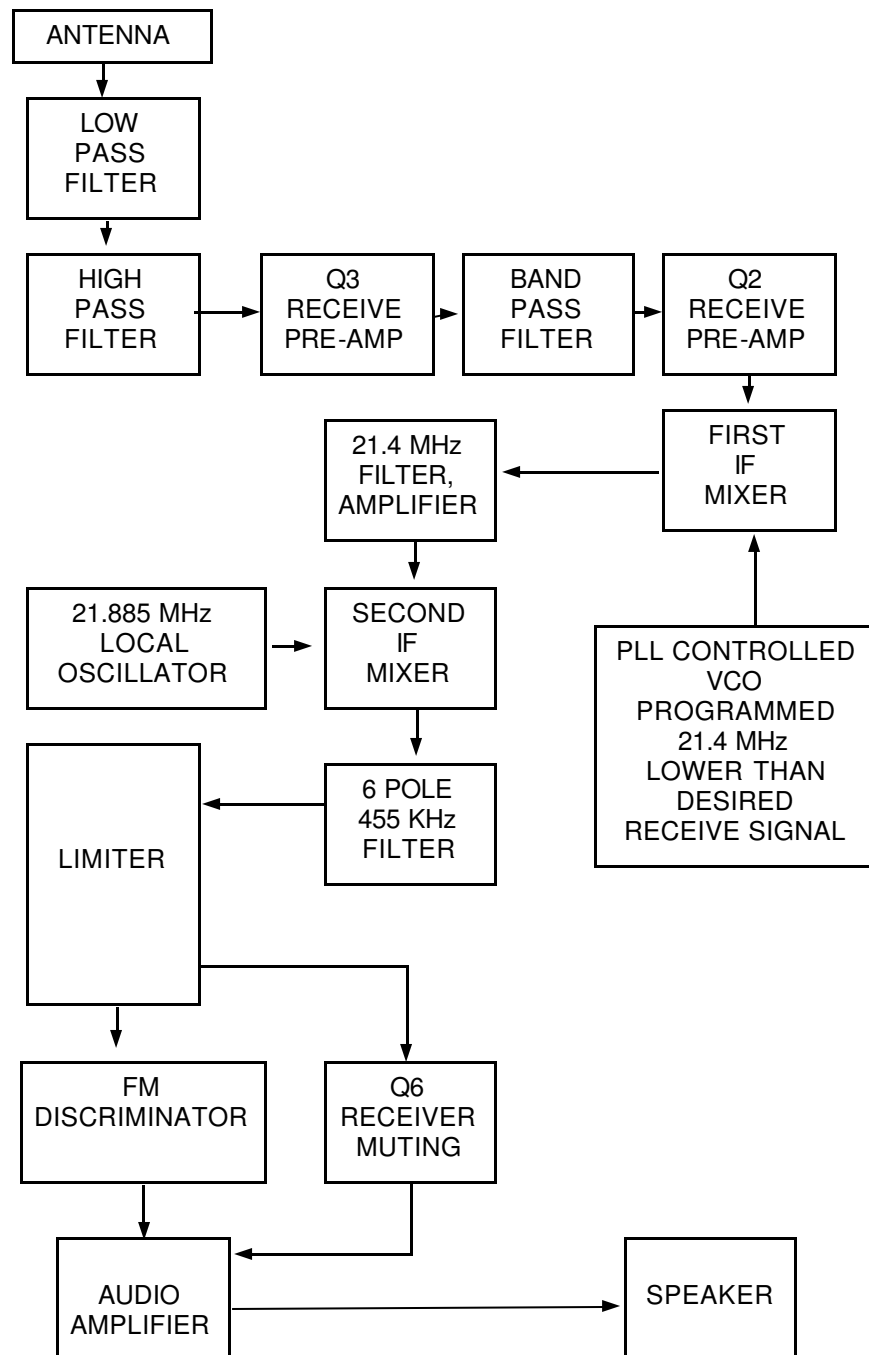

- ✍ CR30. Prepare three 8" lengths of hookup wire for connecting R13, the 10K Squelch Control. Strip back ¼" from one end of each wire. Tin all ends.
- ✍ CR31. Install C11, .01 uf disc capacitor (marked .01 or 103).
- ✍ CR32. Install D23, 6.2 volt zener diode (gray body, black band). Observe correct placement of the banded cathode end. Zener diodes are widely used as voltage regulators. They have the interesting property of keeping a constant voltage across their terminal leads.
- ✍ CR33. Install C35, 100 pf (marked 100, 101 or 101K).

The last 4 steps involved the building of a voltage regulator to supply a steady source of voltage to the receiver IC chip. At this point in your work, you could actually receive strong local signals by connecting an antenna wire at C78 and a high frequency signal source (e.g. a signal generator) to the input of U1. The signal you would receive would be on a frequency of the signal generator frequency plus 21.4 MHz. Because we have not yet constructed any of the input circuitry (Stage DR), you would also hear any signal on the signal generator frequency minus 21.4 MHz.

PRECAUTION ON WIRING FOR CONTROLS, JACKS, ETC:

The volume control, squelch control, speaker jack and power cord are installed quite early in the assembly sequence so that tests can be conducted periodically during assembly.

The disadvantage of this approach is that there is considerable wear or strain on the various wire connections as the PC board is repeatedly flipped back and forth during assembly. This is a serious consideration because more radios and computers malfunction because of broken wires than from electronic parts going bad. For this very reason, such wiring is ordinarily done as a final step in electronics assembly.

To minimize damage to the control and jack wiring, use one of the provided wire cable ties to hold down this group of wires temporarily. Loop the tie through the PC board mounting hole near U10's position, grouping the wires snugly to the board. After fully assembling and testing the kit, the tie may be clipped off, allowing you to once again use the PC board mounting hole.

Stage A
DC Power Input, Regulation, and Distribution. Plus, Packet Radio
I/O Connector (J1).

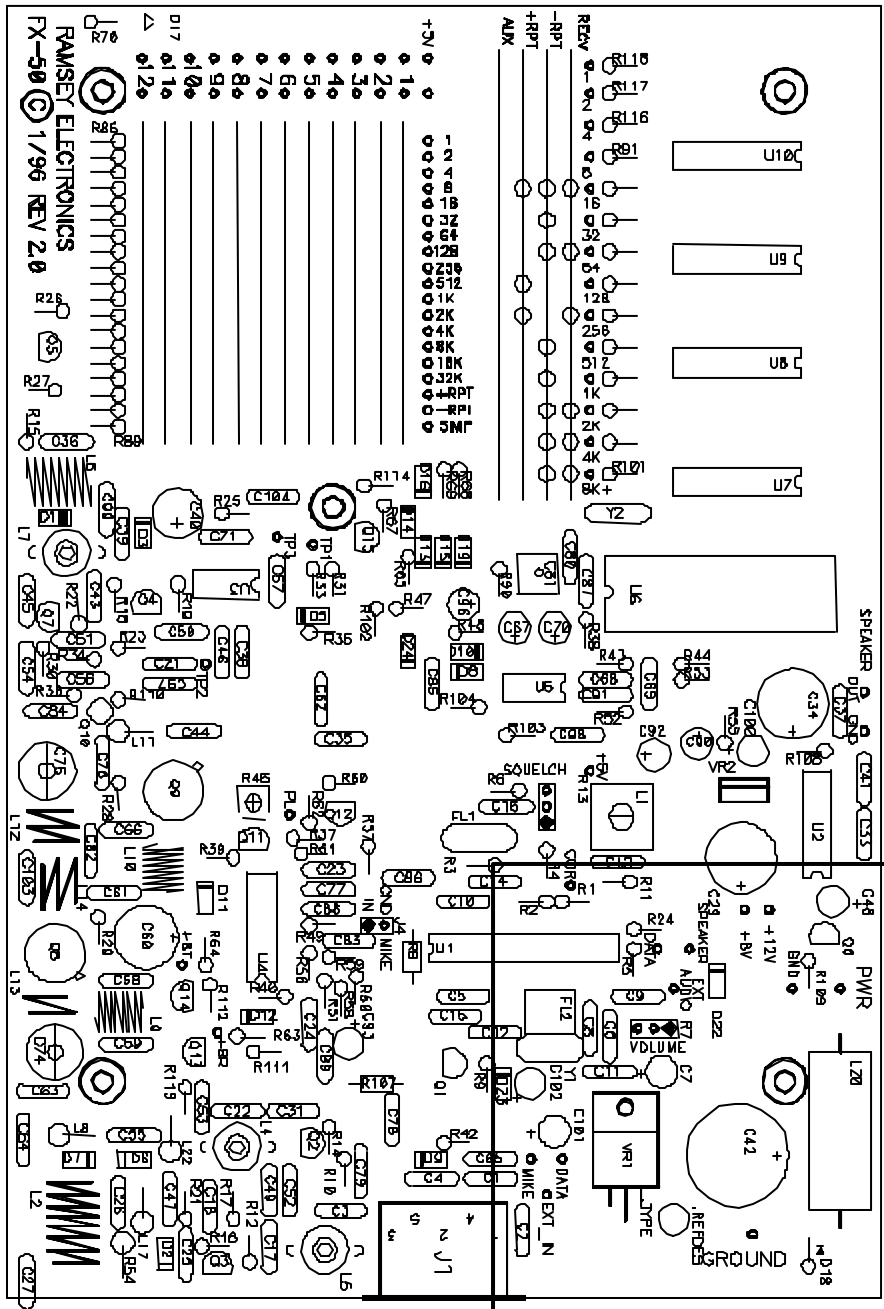

So far, most disc capacitors installed have been from your endless supply of .1, .01 and .001 capacitors. If you have not done so already, now would be a good time to sort and organize all your "picofarad" capacitors, ranging in value from 2 to 100 pf. Correct selection of these values will be essential throughout the RF stages of your transceiver.

- ✂ CR11. Install C9, .1 uf (marked .1 or 104).
- ✂ CR12. Install C8, .1 uf.
- ✂ CR13. Install C13, .1 uf (marked .1 or 104).
- ✂ CR14. Install C14, .1 uf.
- ✂ CR15. Install C102, 10 uf electrolytic. Check polarity!]
- ✂ CR16. Install C6, .1 uf.
- ✂ CR17. Install C7, 10 uf electrolytic. Watch polarity (or U1's audio won't reach U2!)
- ✂ CR18. Install C10, .001 uf (marked .001 or 102).
- ✂ CR19. Install C15, 22 pf (marked 22).
- ✂ CR20. Install C12, 120 pf (marked 121).
- ✂ CR21. Select and install Y1, the 21.855 MHz. crystal. It must be snug on the board before soldering. [Be sure not to confuse Y1 with Y2, the 10.240 MHz crystal which will set the Reference Frequency for the PLL Synthesizer, or with FL1, which has 3 leads.]
- ✂ CR22. Install L1, the 455 KHz shielded coil marked LB53303HK. Make sure it is seated squarely on the board before soldering. Solder all pins.
- ✂ CR23. Install C101, 10 uf electrolytic capacitor.
- ✂ CR24. Install R6, 3.3K ohm (orange-orange-red).
- ✂ CR25. Install R8, 51 ohm (green-brown-black).
- ✂ CR26. Install R2, 1K ohm (brown-black-red).
- ✂ CR27. Install R1, 470K ohm (yellow-violet-yellow).
- ✂ CR28. Install Q1, NPN type 2N3904. Before soldering, press the transistor as far into its holes as possible, with the flat side oriented as illustrated.
- ✂ CR29. Install FL1, the 21.4 MHz IF filter. Its 3 wires may be inserted either way; make sure its body is snug against the top of the board before soldering.

ADDITIONAL RECEIVER IC FUNCTIONS AND FEATURES

In addition to audio output at pin 17, a separate high speed data output (up to 35000 baud) is available and may be linked directly to a packet TNC or other data controller using the jumper wire pad provided on the PC board. The MC13135 is capable of detecting true FSK (frequency shift keying) in addition to AFSK.

The receiver has good "hysteresis" characteristics, the ability to hold the squelch open once it has been broken by a marginal signal, even if the signal becomes weaker. The IC also has carrier detect circuitry which is put to good use in the transceiver design by providing very effective squelch action. The squelch is activated by signal strength, not by noise. When no carrier is detected, the voltage at pin 16 is high, which causes Q6 to mute the audio amplifier U2 as explained in Stage B.

When a carrier is detected, the voltage at pin 16 drops low, turning off Q6. Resistor R13 permits squelch adjustment.

Finally, the carrier detect circuitry affords the same COR ("Carrier Operated Relay") action as needed in any repeater, which is why the output is also available on the PC board, designated "COR." It is up to creative users to determine their own practical implementations for this feature.

Stage CR ASSEMBLY PROCEDURE:

✂ CR1. Install U1, the MC13135 24-pin DIP FM Receiver IC. Make sure all 24 pins are visible through the holes before soldering. Be very sure that the notched end is oriented as illustrated.

Install the following resistors:

- ✂ CR2. Install R11, 47K ohm (yellow-violet-orange).
- ✂ CR3. Install R5, 10K ohm (brown-black-orange).
- ✂ CR4. Install R4, 68K ohm (blue-gray-orange).
- ✂ CR5. Install R24, 10K ohm (brown-black-orange).
- ✂ CR6. Install R9, 270 ohm (red-violet-brown).
- ✂ CR7. Install R3, 1K ohm (brown-black-red).
- ✂ CR8. Install C16, .01 uf disc capacitor (marked .01, 103 or 10nf).
- ✂ CR9. Install C5, .1 uf (marked .1 or 104).
- ✂ CR10. Select and install FL2, the rectangular plastic block with 3 thin pins. It fits only one way. This is the 6 pole, ceramic 455 KHz IF filter network. Verify that filter FL2 is properly seated and soldered.

STAGE A: DC POWER INPUT REGULATION & DISTRIBUTION and PACKET RADIO I/O CONNECTOR (J1)

The "power supply" for your FX- transceiver is, basically, any "12-volt" battery or well designed power supply operating from 120VAC or other source. In theory, all "12V" sources should provide pure DC voltage to your FX-transceiver DC input. In fact, there are many variations and imperfections in common "12VDC" sources, ranging from weak batteries, poorly filtered AC powered supplies, vehicle ignition noise, or just badly made power supplies. Stage "A" of your FX- Transceiver is designed to help your radio survive quite a wide variety of imperfections. It's not a "power supply" in itself, but it comes close, because it performs all the essential functions expected from a good solid-state DC source. Just add 12-15VDC from a battery, vehicle or bench supply.

Much of the circuitry operates on the regulated 8 volts supplied by voltage regulator VR1. If you have already looked around the schematic diagram and also seen "+8R" or "+8T", these are points where the regulated 8V output is switched for Receive or Transmit by the PTT (push to talk) circuitry (Q12, U4c, U4d, Q13, Q14) which we'll discuss in more detail when it's time to build it in Stage M.

The Receiver IC (U1) and the digital frequency synthesis circuit is powered by +5 volts regulated by VR2. The op amps used in the circuit (U4 and U5) operate from this single supply through the use of voltage divider networks at the respective IC's. The full 12-15 volt input is supplied to the transmitter RF output section and to the receiver audio amplifier (U2).

The large 1500 uf capacitor (C42) and inductor L20 are installed at the DC input to filter out ignition noise, etc. Fuse F1 is contained in the power cord and the DC power switch is integral to the volume control. The DC negative (black) wire is soldered directly to the PC board ground plane.

The Packet Connector

The Packet I/O Jack (J1) is not a "stage" or section of your transceiver in itself. It is simply a convenient "port," to use computer terminology, which gives a packet TNC (terminal node controller) convenient access to the microphone and receiver audio circuits. We'll install J1 and its associated bypass capacitors at the beginning -- because now is as good a time as any, and it gets some parts on your PC board quickly and easily! Also, having J1 in place will give a little extra protection to other parts when you are working on the solder-side of the board.

Stage A: ASSEMBLY STEPS

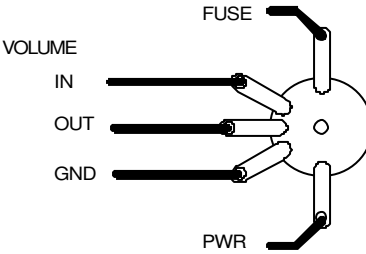
- ✂ A1. Strip 1/8" of insulation from the heavier-gauge black wire, insert and solder in the GROUND hole. This connection may be soldered on the TOP side of the board as well as the solder side.
- ✂ A2. Cut 8" of wire off one end of the inline fuse holder. Save this wire for use in the next step. Strip 1/8" of insulation from the in-line fuse wire and solder it to one of the S1 switch lugs of the volume control (R7). The switch lugs are the two outermost of the 5 lugs.
- ✂ A3. Strip 1/8" of insulation from each end of the 8" wire from the fuse holder saved in the last step. Solder one end to the other switch lug on R7 and the other end to the PWR point on the PC board. MAKE SURE that ALL strands of this wire are neatly inserted and soldered in the hole. Any stray strand will cause a direct short when it touches the ground plane.
- ✂ A4. Install L20, the 500 uH noise filter inductor. It is the large cylinder shaped component with wires coming from each end.
- ✂ A5. Install C42, 1500 uf, the first (and largest!) of the electrolytic capacitors. The (+) side must be oriented as imprinted on your board, toward L20.
- ✂ A6. Install C95, a 4.7 to 10 uf electrolytic. Observe correct polarity for all electrolytic capacitors. NOTE: The silkscreen for C95 is marked ref des on your PC board. C95 is between VR1 and C42.
- ✂ A7. Select D18, the 1N4002, the largest of the diodes used in your kit. It has a black body with a gold band on one end. Notice the band towards one end designating the cathode. This diode MUST be installed with its ANODE in the ground hole nearest the back of the PC board. Solder the anode end now, letting the diode body stand vertically on the board.
- ✂ A8. Gently bend the cathode wire into its hole, pull it through so that it is as short as possible with the diode standing vertically. Solder and trim excess wire. NOTE: this is the basic method for installing all upright parts.
- ✂ A9a. Voltage Regulator VR1 (type 7808 for 8 volts) is mounted with its metallic back flat against the ground plane, secured by the small machine screw and nut supplied. Identify VR1 correctly without mixing it up with its 5-volt counterpart (VR2).
- ✂ A9b. Insert the 3 VR1 leads into the triangular set of holes while gently bending the body back towards the board so that the mounting holes line

2. The First IF converts the incoming 52.525 MHz signal down to 21.4 MHz. In order to do this job, the IC's 1st IF Mixer needs ANOTHER frequency source to mix with the signal presented by the antenna through the filters and preamps of Stage DR. This other signal must be VERY precise since the mixer output is fed into a very sharp crystal filter at 21.40 MHz. Specifically, the 1st IF mixer seeks a second signal that is $52.525 - 21.40 = 31.125$ MHz.

3. Supplying the needed 31.125 MHz "local-oscillator" input signal is the job of the tunable or programmable oscillator section of any receiver, whether AM-FM-SSB, HF or VHF, etc. In this case, take it on faith that the VCO (Stage F), controlled by the PLL Frequency Synthesizer (Stage H) will deliver the precise 31.125 MHz local oscillator signal needed by U1's 1st IF Mixer. The VCO signal is applied to pin 2.

4. No matter what we tuned in, the 1st IF Mixer section of U1 delivers the incoming signal at 21.4 MHz to the next section of U1. This next section wants to do yet ANOTHER frequency conversion! This is where we get the ideas of "dual-conversion" and "2nd IF." This time, though, no more "variable" input is expected beyond the FM IC's basic functions. Crystal Y1, 21.855 MHz, completes another internal oscillator. Its output is mixed with the steady 21.4 MHz signal from the 1st IF Mixer, and we can start to see the whole picture:

$$52.525 - 31.125 = 21.400 \text{ MHz}$$
$$21.855 - 21.400 = 455 \text{ KHz}$$

5. The 52.525 MHz signal at the antenna has gone through quite a sorting and converting process. It now appears to additional sections of U1 as a 455 KHz signal that needs "demodulating," a way of saying: detecting, analyzing, decoding, or just making something intelligent out of it all. The MC13135 employs a conventional quadrature detector. Inductor L1 is the quadrature coil, requiring a simple one-time adjustment.

The exact process of "detecting" intelligible FM voice or data from the 455 KHz 2nd IF is the job of the remaining sections of the MC13135 IC. Because there's much more of this transceiver circuit to discuss and understand, please study other sources if you are not clear on concepts such as Limiter, FM Discriminator, Quadrature, phase shift, and so forth. As long as you just see the general flow of how a 52.525 MHz VHF FM signal can become intelligible audio input to the U2 speaker amplifier (Stage "B"), we're doing fine for now.

Stage CR: Integrated FM RECEIVER (with Squelch Control)

This step is named "CR" so that the assembly step numbers do not resemble designator numbers for capacitors.

To fully appreciate the marvel of U1, the MC13135 FM Receiver IC, one would need to study the schematic diagram of any FM receiver more than 15-20 years old, including fully "solid-state" models. The MC13135 IC is truly a "Receiver-on-a-Chip." The cluster of parts to assemble and understand around U1 is minimal in comparison to what was previously required for a quality FM receiver circuit

For years, Ramsey Electronics has employed a similar IC, the MC3359 as the heart of our popular FM receivers for the 10, 6, 2 and 1.25 Meter bands. We adopted the MC13135 IC for the FX-series because of its features especially suited for state-of-the-art FM voice and digital communications requirements.

The MC13135 is a complete FM narrowband receiver from antenna input (pin 22) to audio preamp output (pin 17). The low voltage dual conversion design results in low power drain, excellent sensitivity and good image rejection in narrowband voice and data link applications. The FX-50 implementation of this IC yields increased image rejection by using a 21.4 MHz first IF rather than the traditional 10.7 MHz. A precision 2-pole crystal filter (FL1) is used for the 21.4 MHz first IF.

The receiver IC is so complete that it includes an internal local oscillator requiring only a crystal across pins 5 and 6 to establish the basic operating frequency. Our design injects the output of the transceiver's PLL-controlled VCO through C35.

As an option, a helical resonator module can be installed in the front end RF amplifier area for excellent receiver performance in high RF environments.

The first mixer amplifies the signal and converts this RF input to 21.4 MHz. This IF signal is sent to the second internal mixer via pin 18, where the 2nd IF frequency of 455 KHz is achieved by mixing with the 21.855 MHz oscillator. The oscillator circuit is internal to U1; the crystal is Y1, 21.855 MHz.

The 455 KHz second IF output (pin 7) requires filtering to provide good adjacent channel rejection. A high performance 6 pole ceramic filter is used. Filters such as this are used in virtually all FM radio transceivers. Let's summarize the basic "double-conversion" principle for receivers, using the national 6 Meter band simplex channel, 52.525 MHz as our working example:

1. An antenna could be connected directly to pin 22 of U1, and our receiver-on-a-chip would indeed work. The antenna would bring in our theoretical test signal of 52.525 MHz as well as every other signal in the radio spectrum. Since that's a bit much to expect the receiver to handle, we will build up that network of filters, tuned circuits and RF preamplifiers that constitutes Stage "DR" of this project. The purpose of the "DR" circuitry is to filter out or at least diminish other signals while boosting signals in the 6 Meter region.

up. Secure VR1 to the board with the screw and nut. After VR1 is mounted flat, solder and nip the 3 leads.

- ✂ A10. Study the PC board and locate the triangular set of 3 holes for VR2 (type 7805), and insert VR2 so that the flat metal tab side is toward the center of the board. Press VR2 in as far as it will go, solder and trim.
- ✂ A11. Near VR2, install C100, a 4.7 or 10 uf electrolytic, oriented for correct polarity.

Stage A PROGRESS TEST:

The power input circuitry is completed and can be tested before proceeding. Perform the test as follows:

- ✂ 1. Make sure a 1 amp fuse is installed in the fuse holder.
- ✂ 2. Connect the fused (+) and black (-) wires to a 12-volt battery or power supply (12-15 volts DC).
- ✂ Connect the black (-) lead of a DC voltmeter or VOM to the ground plane of the PC board.
- ✂ Study the PC board and locate the points marked +12V, +8V and +5V. NOTE: The +5V test point is located at the front of the board near the diode matrix. (These connections are provided for convenience in later modifying or experimenting.)
- ✂ With the power switch turned on, you should get meter readings of +12V, +8V and +5V. (If your meter probe does not have a fine enough point to make solid contact inside the holes at these 3 points, simply study the multi-color PC board illustration and look for +12, +8 and +5 volts DC on PC board traces that lead to the 2 voltage points.)

After you are satisfied that the power input circuitry is working correctly, disconnect the 12 volt source.

WIRING THE PACKET I/O CONNECTION:

- ✂ A12. Press J1, the Packet I/O DIN connector into position. Before soldering, make sure that the bottom of the jack is perfectly flat against the board. It is best to solder only the middle pin first, check for straightness, and then solder the other 4 or 6 points. (DIN jack styles may vary; your jack may have simply the 5 connector pins, or 2 extra pins for mechanical stability. Either style fits your PC board.) Directions for installing hardware or unusual parts often require extra written detail. You've just been through a lot of that in this stage.
- ✂ The following steps are more typical of how many upcoming installation

directions will be given:

- ✂ A13. Install C2, .001 uf disc capacitor. It may be marked .001 or 1 nf or 102. (102 means a one, a zero and two zeros which equals: 1000 pf. 1000 pf is the same as .001 uf. This notation (102) is similar to the resistor color code to indicate resistance values.
- ✂ A14. Install C3, .001 uf.
- ✂ A15. Install C4, .001 uf.
- ✂ A16. Install C1, .001 uf.
- ✂ A17. Install C65, .1 uf. It may be marked .1 or 104. (As above, 104 means a one, a zero and four zeros = 100,000 pf which is the same as .1 uf) (On the schematic, C65 is located near J4 and U4 and couples packet audio to the microphone input line.)
- ✂ A18. Select D9, one of the many 1N914 or 1N4148 switching diodes used in the circuit. Don't confuse these diodes with the smaller PIN and varactor diodes used in later stages. Notice the dark band at one end designating the cathode and notice how the cathode end is imprinted right on the PC board.
- ✂ A19. Install D9.
- ✂ A20. Install R42, 2.2K (red-red-red). This is an "upright" installation like D18, previously installed.

Almost all resistors will be installed this way. Like C65, R42 and D9 are shown near J4 on the schematic and complete the External PTT connection between U4 and J1.

No testing of the Packet components is required, but make sure all parts values are correct and that D9 is oriented correctly.

STAGE CR: FM RECEIVER CIRCUIT DUAL CONVERSION SUPERHET WITH IF FILTERS

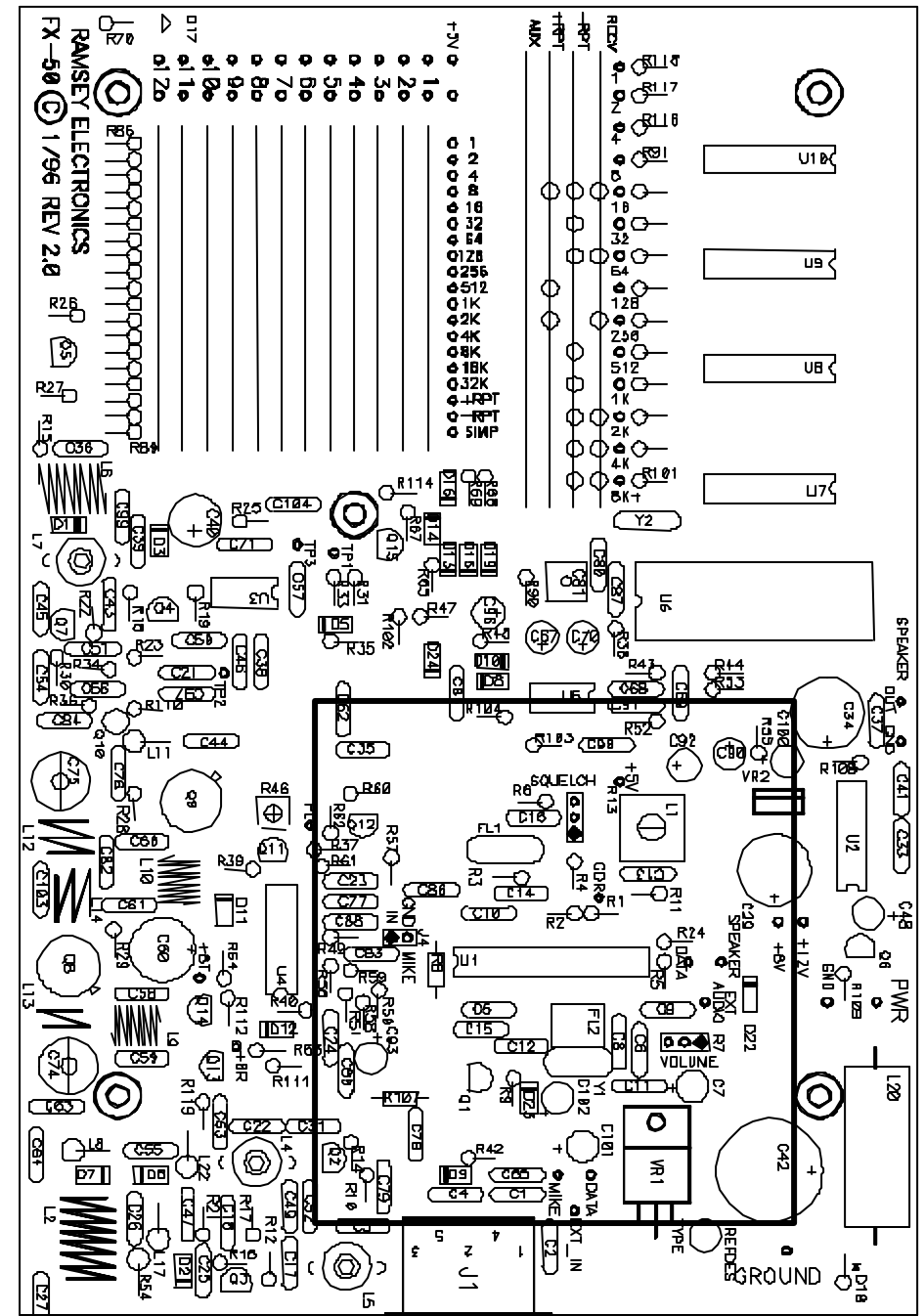

points on the PC board.

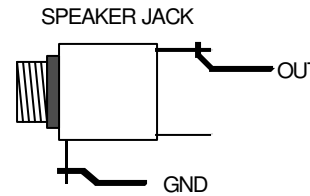

Stage B: Receiver Audio Amplifier

The secret to the fine performance of the LM380 audio amplifier lies in careful selection and physical positioning of the several external components required to complete its circuit. The LM380 is a self contained general purpose audio amplifier capable of over 2 watts audio output with a voltage gain of 50. Audio from the FM discriminator (U1) is fed through C7 through the 10K volume control (R7) to pin 2, the amplifier input. The amplified output at pin 8 is available through C34 to both the speaker jack and pin 4 of the Packet I/O Jack. Capacitor C41 in series with R108 across this amplified output are recommended good practice to prevent self-oscillation of the amplifier IC.

Pin 1 is bypassed to ground through C48 in normal operation. If pin 1 is grounded directly, the internal bias of the LM380 is upset, and the amplifier is silenced. We are able to put this characteristic to practical use, using Q6 as a simple switch. When 8 volts is applied through R107 and D22 to the base of Q6, the transistor collector grounds pin 1 of U2, thus silencing the receiver during transmit. The COR output of U1 (pin 16) also mutes the amplifier, a feature which we'll discuss in the context of Stage CR.

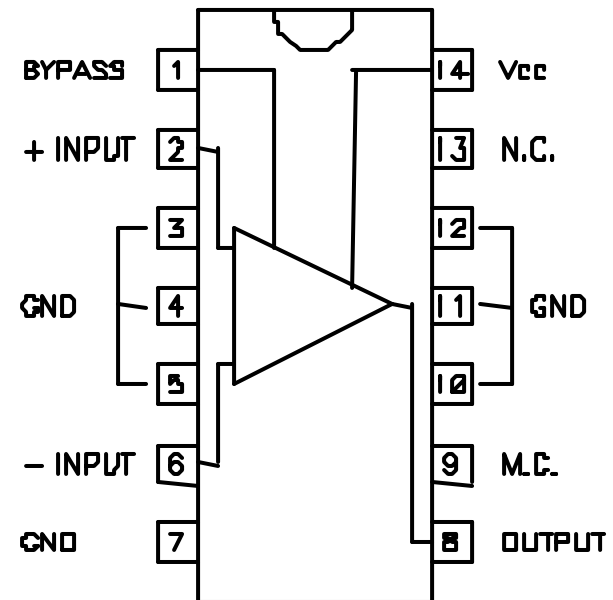

Stage B: Receiver Audio Amplifier and Speaker Connection

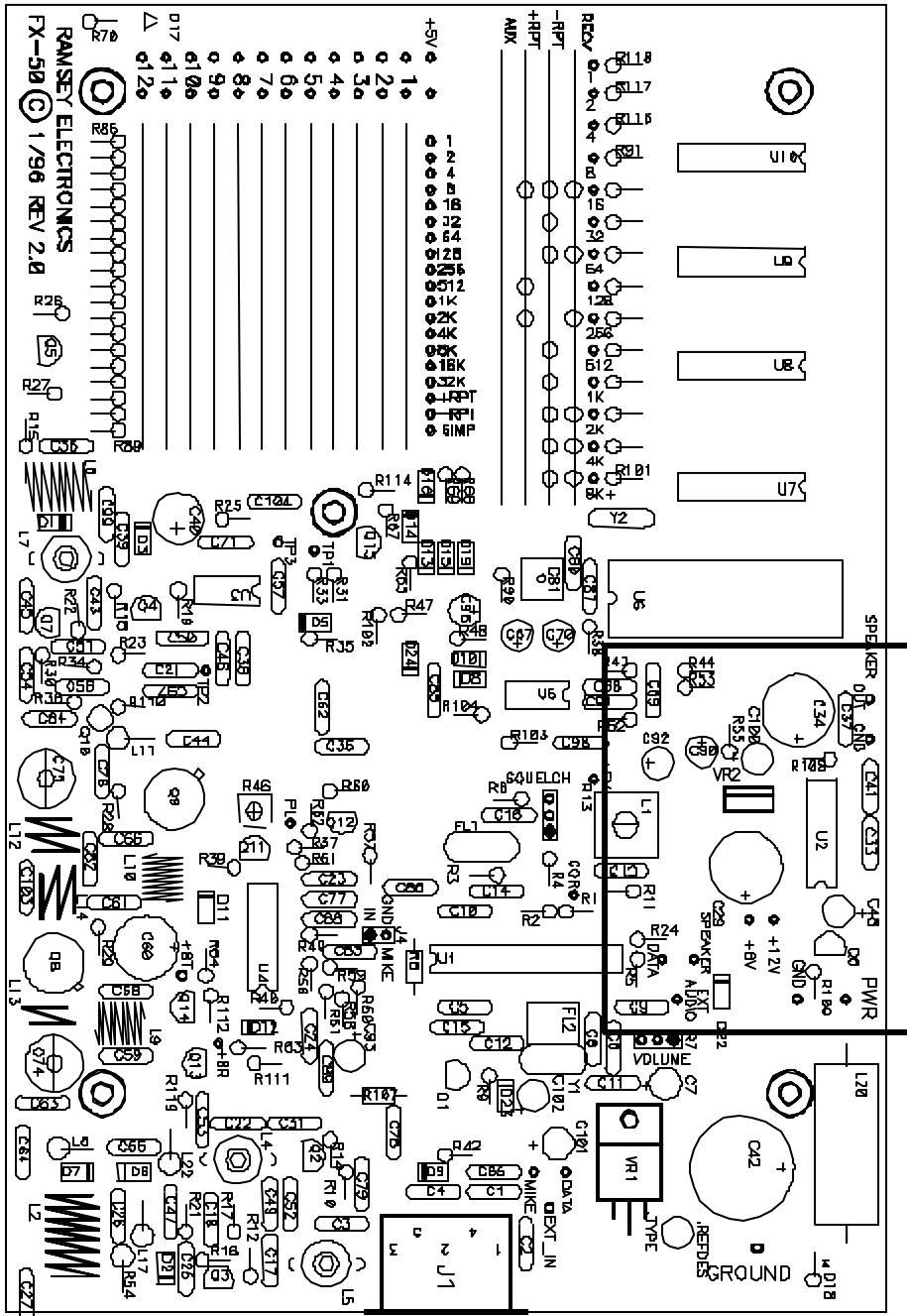

Stage B: AUDIO AMPLIFIER CIRCUIT ASSEMBLY:

Some of the Stage "A" steps required more detailed explanation than simply inserting and soldering parts. As we move along, there will be more and more short "one liners"! The following steps will complete a working audio amplifier ready to power up and test.

- B1. Install U2, the LM380 IC. Be sure to orient the dotted or banded end as illustrated. (The use of a DIP socket for U2 is NOT recommended, even if you use sockets for the other IC's. Notice that most of U2's pins are soldered to the PC board ground plane. This provides heat sinking to the IC chip for proper heat dissipation.)
- B2. Install C48, 4.7 or 10 uf electrolytic, observe correct polarity.
- B3. Install C33, .01 uf disc capacitor (marked .01 or 103).
- B4. Install C41, .1 uf disc capacitor (marked .1 or 104).
- B5. Install R108, 2 ohm (red-black-gold).
- B6. Install C34, 470 uf electrolytic. Watch out for correct polarity.
- B7. Similarly, install C29, 330 uf electrolytic.
- B8. Install C37, .01 uf disc capacitor (marked .01 or 103).
- B9. Install NPN transistor Q6. Be sure to have identified it correctly as one of the five 2N3904 transistors used in your kit, (Not one of the 2SC2498 RF transistors) and be sure to orient the flat side as illustrated. Before soldering, press the transistor as far into its 3 holes as reasonably possible.
- B10. Install R109, 47K (yellow-violet-orange). Note that this is another of numerous vertical installations of resistors. The body of such resistors should be snug against the board at the designated hole, with the other wire neatly looped into the other hole without needless excess.
- B11. Cut three 8" lengths of hookup wire (or 8" of 3 conductor wire) to connect the Volume Control to the three points designated on the PC board. Strip and tin all six ends, referring back to Stage A instructions if necessary or helpful.
- B12. Refer to the drawing and correctly interconnect the Volume Control's three lugs to the 3 connecting

