

HF ALL MODE TRANSCEIVER

SS-105

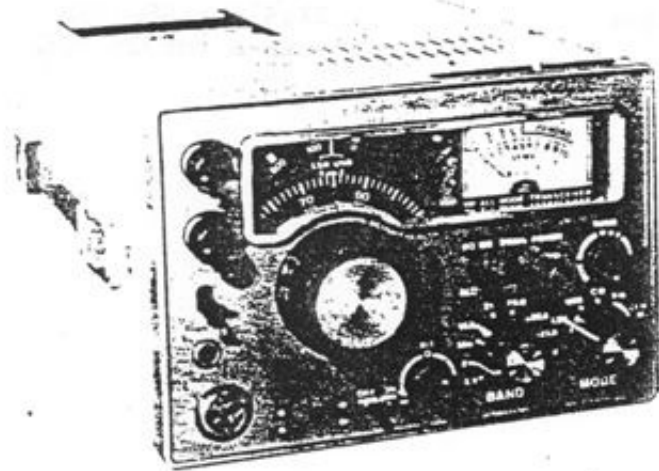

SPECIFICATIONS

Frequency Range: 80m band 3.5MHz - 4.0MHz
40m band 7.0MHz - 7.5MHz
20m band 14.0MHz - 15.0MHz
15m band 21.0MHz - 21.5MHz
10m band 28.0MHz - 30.0MHz

Emmision: LSB, USB, CW, FM

Maximum output power: SS-105S/10W, SS-105D/100W

Supurious ratio: less than -40dB

Image ratio: better than 50dB

Antenna impedance: 50-ohms

Receive sensitivity: SSB 0.25 V input S/N 10dB or more
FM 0.5 V input S/N 20dB QS

Maximum deviation/FM: \pm 5KHz or \pm 10dB, adjustable by variable resistor.

Modulation: SSB Balanced modulation
FM Variable reactance modulation

Frequency Stability: Within \pm 1KHz from after 1 minuit to 60 minuits
power on. after that within 100Hz per 30 minuits.

Microphone Impedance: 500-ohms to 50K-ohms

Audio output: 1.5W at 8-ohm maximum

Power source: DC13.5V 3A for SS-105S
DC13.5V 16A for SS-105D

Demensions: 178(W) X 124(H) X 272(D) for SS-105S
178(W) X 124(H) X 359(D) for SS-105D

Weight: 5Kgs for SS-105S
6.2Kgs for SS-105D

2. CONTROLS

FRONT VIEW

- 1 AF GAIN
- 2 RF GAIN
- 3 STAND-BY SWITCH
- 4 HEADPHONE JACK
- 5 MICROPHONE CONNECTOR
- 6 MAIN TUNING
- 7 RIT SWITCH

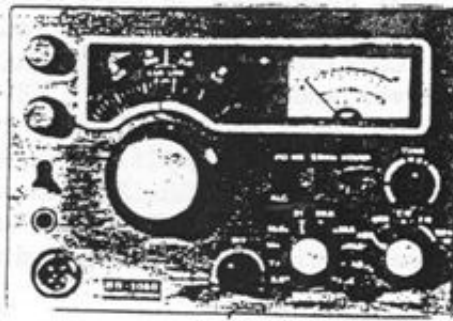

8. DIAL SCALE
- 9 LED LIGHT
- 10 S/RF/ALC METER
- 11 PO/NB/ALC SWITCH
- 12 MARKER SWITCH
- 13 POWER ON/OFF SWITCH
- 14 TUNE
- 15 MODE SELECTOR SWITCH
- 16 BAND SELECTOR SWITCH
- 17 RIT TUNING

1 AF GAIN CONTROL

Audio gain control at receiving, sound is increase by turning to clockwise.

2 RF GAIN CONTROL

Threethold level control of RF stage and IF stage.

3 STAND-BY SWITCH

Transmitte at "SEND" position.
Receive at "RECV" position.

4 HEAPHONE JACK

Audio output jack for Headphone(monoural).

5 MICROPHONE CONNECTOR

You can use either high impedance or low impedance microphone. Please use supplied four prong microphone plug as shown following diagram.

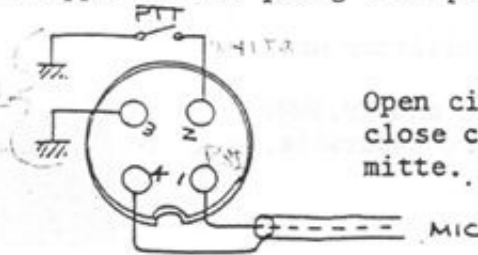

Open circuit of PTT switch for receive, close circuit of PTT switch for trans- mitte.

6 MAIN TUNING

Main tuning of frequency, frequency is increase by turning to clock- wise.

7 RIT SWITCH

Transceiving at off position (same frequency of transmit and receive)
You can tuning within plus or minus 2KHz on receiving frequency.

1. FEATURES

This unit employed "Pre-mixed" type conversion system by balanced mixer. In RF circuit, double tuned by variable capacitor diodes which makes sharpness tuning. By using "RF AGC" circuit as optional, you can receive the signal in best condition in case close to the station.

This set is designed unit by unit, so you can check each unit for adjustment or repair. Consists of following units in this set, SE-AF(Microphone amplifier, Receiver audio amplifier), SE-IR(Transmitter I.F. amplifier, balanced modulator, carrier oscillator, receiver I.F. amplifier, receiver detector), SE-PA(10W linear amplifier), SE-VP(VFO), SE-LO(local oscillator), SE-SW(switching circuit), SE-LPR(low pass filter, relay), and also SE-NB(noise Blanker, RF-AGC), SE-FMT(FM modulator), SE-FMR(FM demodulator) SE-MK(25KHz marker oscillator) as optional units.

ACCESSORIES

*Following accessories are including.

- DC Power lead with 5A Fuse ---- 1
- 4-P Microphone connector ----- 1
- 3.5mm ϕ Miniature Plug ----- 2
- 6.3mm ϕ Phone Plug ----- 1
- 9-P Connector ----- 1
- RCA type Pin Plug ----- 2

*Following optional accessories are available.

- CW-F ²²¹
0.5KHz CW Crystal Filter
- SE-NB
Noise Blanker/RF-AFC unit
- SE-FMT
FM Modulator unit
- SE-FMR
FM Demodulator unit
- SE-MK
25KHz Marker Oscillator unit
- CRYSTALS
14.5, 28.5, 29.0 and 29.5MHz
band crystals are available.

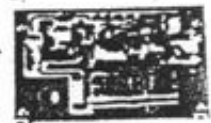
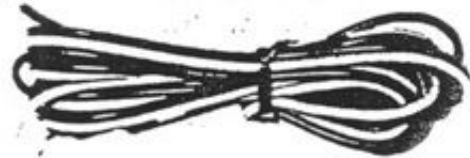

8 DIAL SCALE

You can read the frequency directly from dial scale, read the frequency as follows.

Band switch position MHz + Inner sub dial Frequency KHz
+ Main Dial Number KHz = Receive/Transmit Frequency

P.S. Please read the main Dial Number USB or LSB at same position of mode switch when you operate SSB.

Example. Read the frequency of photo.

$$21\text{MHz} + 200\text{KHz} + 50\text{KHz} = 21.250\text{MHz}$$

Carribration

Main Dial Scale is slippable, switch on the marker unit or connect the maker oscillator to antenna connector, fix the dial scale by hand at 0, 25, 50 or 75KHz position and then adjust the main dial to zero beat position.

9 LED INDICATOR

Red color on transmitting and Green color on receiving.

10 METER

Reveiving: Signal strength meter when you operate on LSB/USB/CW or FM position of mode selector switch.

Center meter when you operate on CEN M position of mode selector switch.

Transmitting: This meter works RF volt-meter of ALC level meter by selecting PO NB/ALC switch when you operate on LSB/USB/CW or FM position; red-zone is right hand only for FM mode. Please adjust the microphone gain control at the meter working only be peak of sound when you speak on SSB to keep your sound in clean.

11 PO NB/ALC SWITCH

On/off of noise blanker on receiving.

RF output volt meter - ALC level meter selector on transmitting.

12 MARKER SWITCH

On/off of 25KHz marker oscillator if you installed SE-MK marker unit as optional.

13 POWER ON/OFF SWITCH

Power on at upper position and power off at lower position.

Please do not power on or off at transmitting, otherwise it will make damage to stand-by relay or some parts.

14 TUNE

Tuning for RF amplifier and IF amplifier circuit at receiving and transmitting. Tuning to maximum sensitivity at receiving and maximum output at transmitting.

15- MODE SWITCH

Mode selector switch for LSB/USB/CW/FM and FM center meter.

On lower than 10MHz as 3.5MHz, 7MHz band to be use LSB and higher than 10MHz as 14MHz, 21MHz and 28MHz to be use USB in normaly.

When you turn on the power switch transmit in short period because this set provided semi-break-in system for CW operation.

Callibration to the radio station on CW, please set the mode switch to LSB position on 7MHz, 14MHz, 21MHz and 28MHz band and then key down, so you can listen the 800Hz tone, make a double beat between these two signals. Only on 3.5MHz, please set the mode switch to USB position. Then change the mode switch to CW position, you can enjoy transceiving.

To be care heat sink on FM operation, heat radiation of FM is about three times compaired with SSB operation.

16 BAND SELECTOR SWITCH

You can chose the operation band by turning this switch.

17 RIT TUNING

You can adjust the receiving frequency within 2KHz plus or minus.

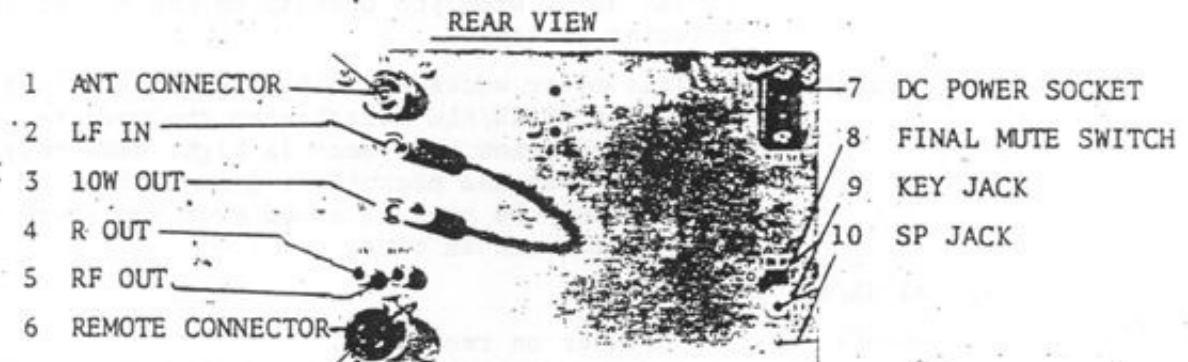

1 ANT CONNECTOR/SO-239 COAXIAL RECEPTACLE

Please connect a suitable antenna fed by 50-52 ohms coaxial cable with PL-259 coaxial plug.

2 LF IN/RCA type pin jack

Input connector to low pass filter, the low pass filter can be handle less than 100watt.

3 10W OUT/RCA type pin jack

This is a output jack of 10W RF signal.
Please connect between "LF IN" and "10W OUT" when you operate without linear amplifier in separate.

4 RECV ANT/RCA type pin jack

Please connect a antenna when you will use this set as receiver only.

5. RF OUT/RCA type pin jack

100mW output from driver circuit connecting for upverter or so.

Please turn off 8 Final mute switch when you will use this output jack.

- 6 REMOTE CONNECTOR / 9-pin Receptacle
Connector for remote control of linear amplifier or uperter.
- 7 DC POWER SOCKET / 2P. Receptacle
Please connect supplied DC Power lead with plug.
Dissamption is approximatly 3A at 10W output.
- 8 FINAL MUTE SWITCH / Slide Switch
You can cut off the DC power to 10W/100W linear amplifier circuit
when you will use this set as basement of upverter.
- 9 KEY JACK / 3.5mm \emptyset miniature jack
Key jack for CW operation.
- 10 SP JACK / 3.5mm \emptyset miniature jack
External speaker jack.

BLOCK DIAGRAM

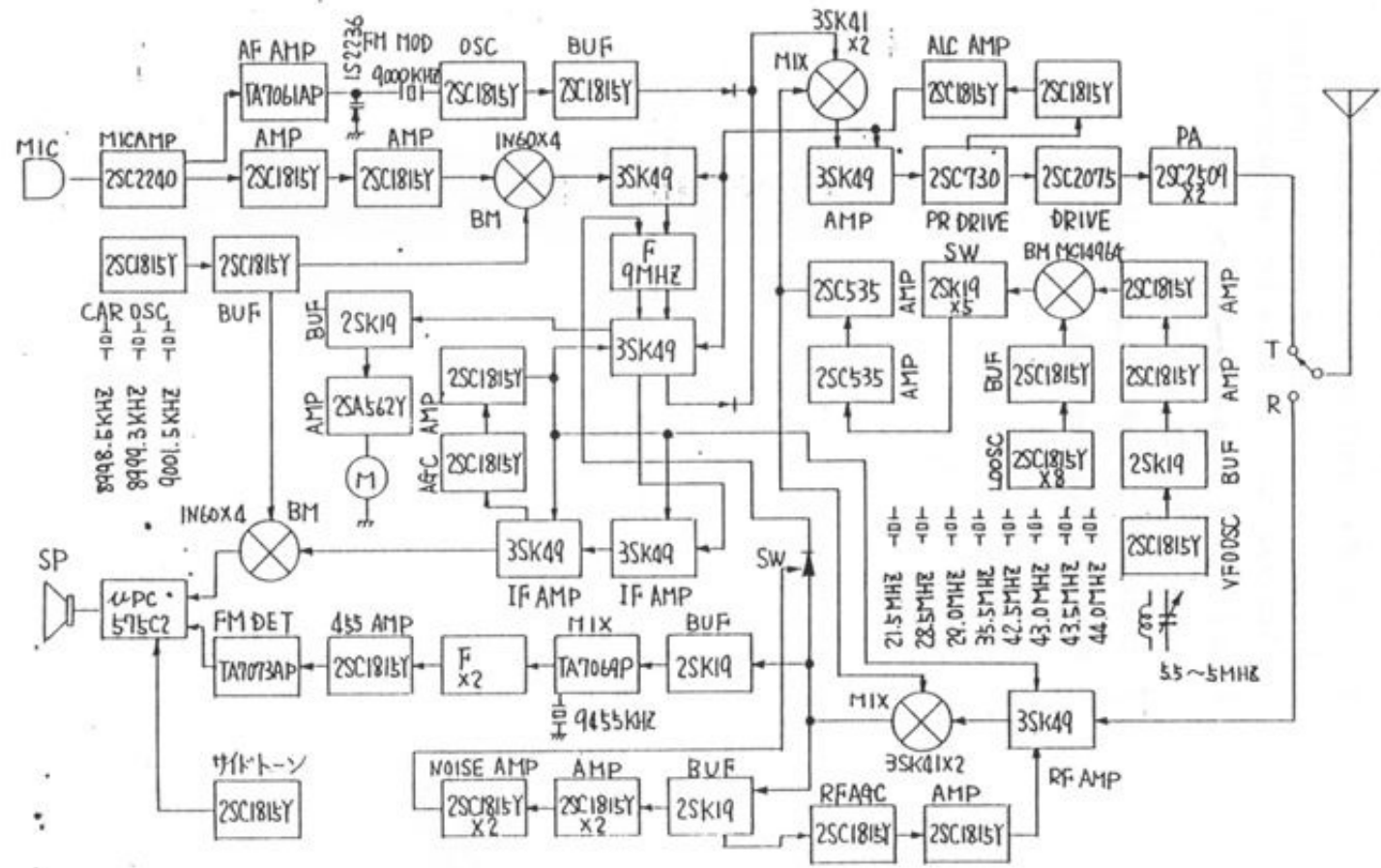

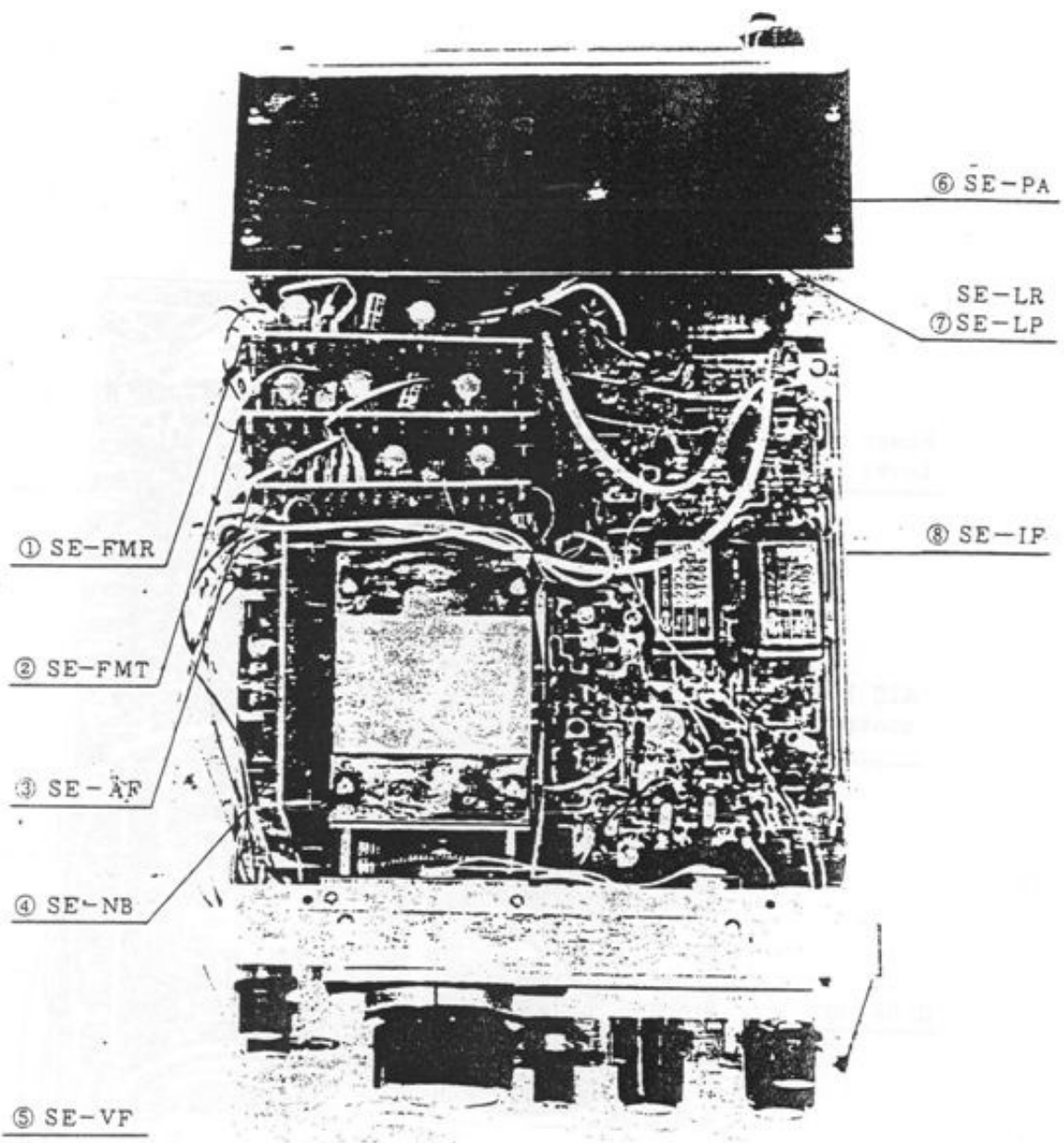

TOP VIEW

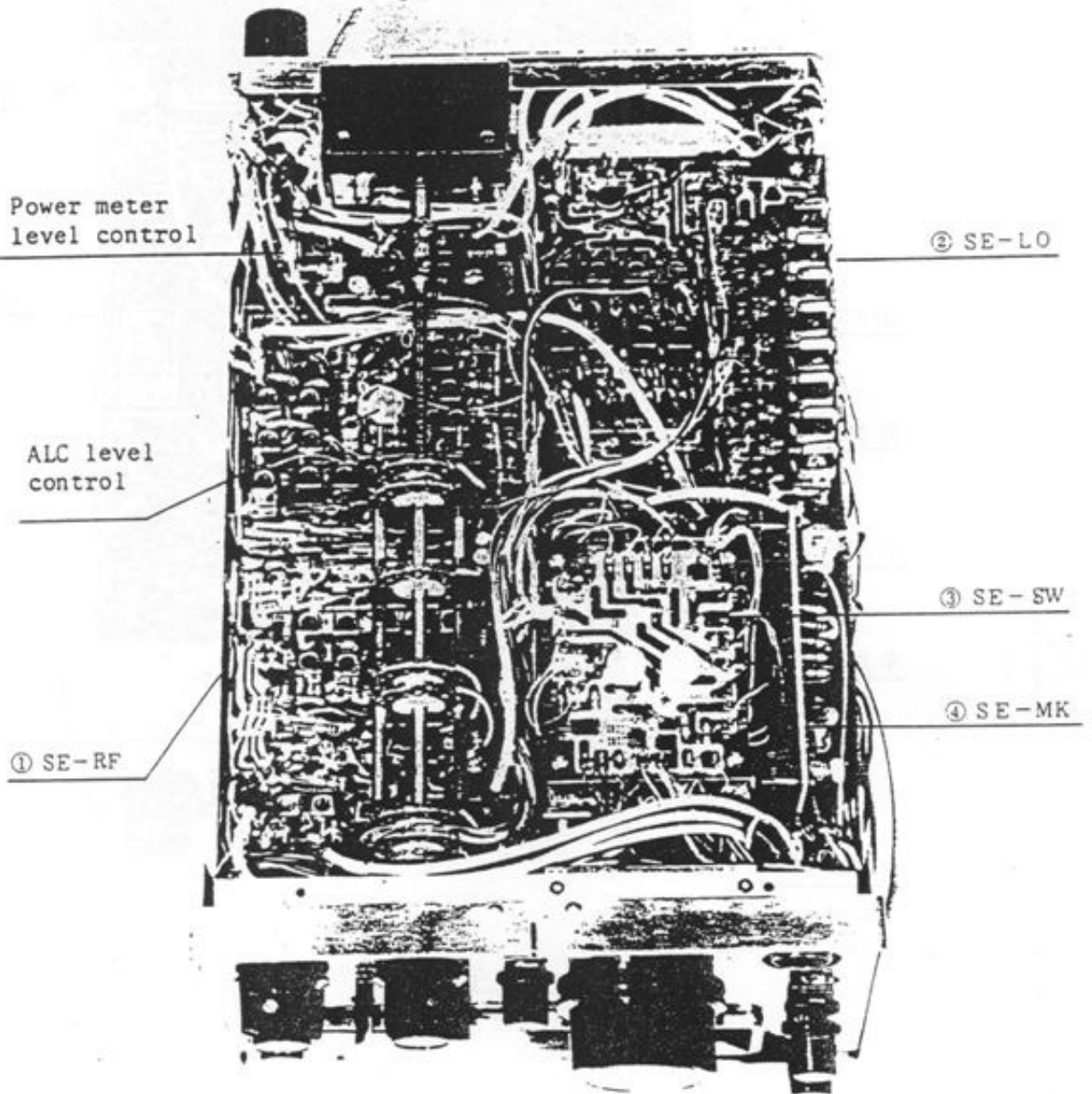

BOTTOM VIEW

4. OPERATION

*Before operation, please make jumper cable between "LF-IN" and "10W OUT" by supplied two pieces of metal shielded RCA type pin plug and coaxial cable as follows.

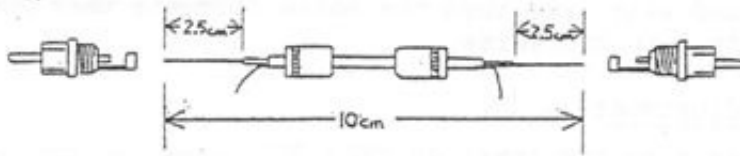

Please cut the coaxial cable 10cm length and then strip the both ends. Soldering inner conductor to center pin of RCA type pin plug.

1. Connect the above jumper cable between "LF-IN" and "10W OUT" which located on rear panel.
2. Connect the antenna feeded by coaxial cable to "ANT" jack by using PL-259 coaxial plug. The antenna must be matched one.
3. Set the "AF GAIN" control to 10-12 o'clock position.
"RF GAIN" control to counter clockwise.
"STAND-BY" switch to REC position.
"RIT" switch to off position.
"BAND SELECTOR" switch to desire band.
"MODE SELECTOR" switch to desire mode.
"PO-NB/ALC" switch to ALC position.
"MARKER" switch to off position.
"TUNE" control to 12 o'clock position.
4. USB/LSB/FM operation:
Connect the microphone plug to "MIC" connector on front panel.
Power switch on, you are ready to operate.
CW operation:
Connect the keyer to "KEY" jack on rear panel.
Power switch on, you are ready to operate.

5. ADJUSTMENT

*Please make simple RF Probe for RF voltage measuring as follows.

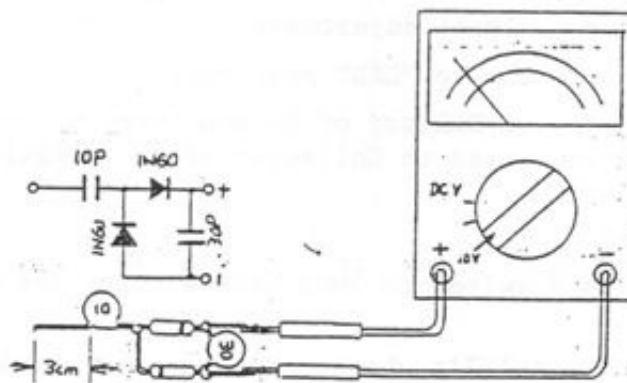

4. OPERATION

*Before operation, please make jumper cable between "LF-IN" and "10W OUT" by supplied two pieces of metal shielded RCA type pin plug and coaxial cable as follows.

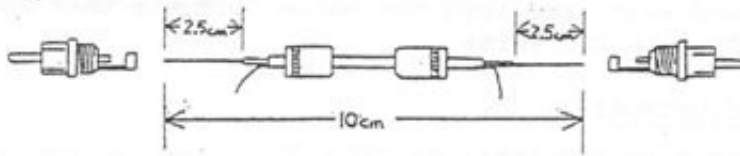

Please cut the coaxial cable 10cm length and then strip the both ends. Soldering inner conductor to center pin of RCA type pin plug.

1. Connect the above jumper cable between "LF-IN" and "10W OUT" which located on rear panel.
2. Connect the antenna feeded by coaxial cable to "ANT" jack by using PL-259 coaxial plug. The antenna must be matched one.
3. Set the "AF GAIN" control to 10-12 o'clock position.
"RF GAIN" control to counter clockwise.
"STAND-BY" switch to REC position.
"RIT" switch to off position.
"BAND SELECTOR" switch to desire band.
"MODE SELECTOR" switch to desire mode.
"PO-NB/ALC" switch to ALC position.
"MARKER" switch to off position.
"TUNE" control to 12 o'clock position.
4. USB/LSB/FM operation:
Connect the microphone plug to "MIC" connector on front panel.
Power switch on, you are ready to operate.
CW operation:
Connect the keyer to "KEY" jack on rear panel.
Power switch on, you are ready to operate.

5. ADJUSTMENT

*Please make simple RF Probe for RF voltage measuring as follows.

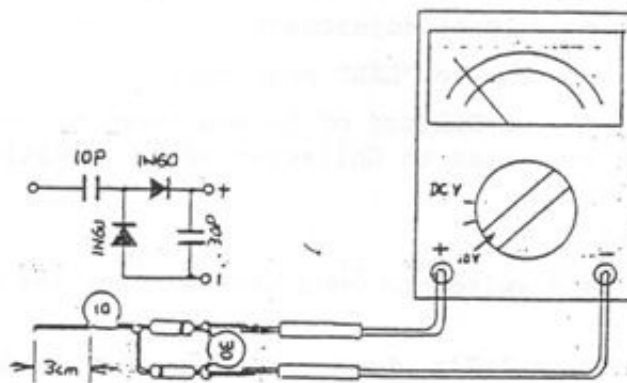

*above probe does not need grounding, please set the multi-meter to 10V range.

*following measuring values are using above RF volts.

*please check the every connection before connecting power leads

*Please make sure the sound when you key down (connect the key to KEY jack, and also make sure the noise increase when you turn the volume control to clockwise.

SE-LO unit adjustment

1. Please make sure the level of "VFO IN" ----- approx. 0.1V
2. Please check the oscillation of local oscillator on 7,14,21&28MHz band touch the probe to cross point of R36 and C35. ----- approx. 3V
3. Set the band switch to 7MHz position. Touch the probe to "LO OUT". Turn the core of TL700 and TL701. ----- 0.5-0.8V
Sweep the main tuning dial between 0 to 500KHz. and make the adjustment for stable output voltage by turning TL700 and TL701. ----- approx. 0.6V
4. Set the band switch to 14MHz position and turn the core of TL140 and TL141 as same as above. ----- approx. 0.6V
5. Set the band switch to 21MHz position and turn the core of TL210 and TL211 as same as above. ----- approx. 0.6V
6. Set the band switch to 28MHz position and turn the core of TL280 and TL281 as same as above. ----- approx. 0.6V

SE-IF unit adjustment

1. Connect the antenna to "ANT" jack.
2. Make sure the voltage of "13.5V" terminal. ----- 13.5V DC
Make sure the voltage of "RB" terminal. ----- 13.5V DC
3. Please make sure the noise generation when you touch to "AF OUT" terminal by finger.
4. Please make sure the moving S-Meter when you turn the "RF GAIN" control.

(Sub-carrier output level adjustment)

1. Set the mode switch to "LSB" position.....
2. Touch the probe to Emitter of Q4 and turn the core of IFT (Red color core) which connected to Collector of Q3 to maximum output voltage. ----- approx: 0.4V

(IF adjustment)

1. Change the band switch to 7MHz band and set the mode switch to LSB position.
2. Turn the core of IFT's which connected with Drain of Q5, Q6, Q7 & Q8 to maximum S-meter position.

(Sub-carrier Frequency Adjustment)

1. In case you have frequency counter. Touch the probe of frequency counter to Emitter of Q4. Adjust the frequency to 8.9985MHz by turning TC2 Trimmer capacitor. Change the mode switch to USB position and adjust the frequency to 9.0015MHz by turning TC4 Trimmer capacitor. Change the mode switch to CW position and adjust the frequency to 8.9993MHz by turning TC3 Trimmer capacitor. (for 8.9993MHz, please check the frequency on transmitting.)
2. In case you do not have frequency counter.
Turning TC2 Trimmer capacitor when you receive the strong signal to natural sound. Change the mode switch to USB position and turning TC4 Trimmer capacitor to natural sound. (the signal must be AM as broadcast station). Change the mode switch to CW position and then receive the CW signal and adjust TC4 Trimmer capacitor to your favorite tone.

(S-meter adjustment)

1. VR3 is sensitivity control and VR2 is zero adjust.
Set the RF gain control to center position and then adjust VR3 for S-9 position, set the RF gain control C.C.W. and then adjust VR2 for S-0.

(Transmitter circuit adjustment)

1. Off the final mute switch which located on rear panel, "PO NB / ALC" switch to ALC position.
2. Please make sure the voltage of "RB" and "TB" terminal for 0V / RB and 13.5V / TB when you transmit.
3. Connect the microphone and turn VR3 semi-fixed resistor on SE-AF board to clockwise 1/3. Adjust the core of IFT which connected to Gate of Q5 to maximum level of "PO NB / ALC" Meter.

(Carrier balance adjustment)

Please prepare the receiver. Disconnect the microphone and then transmit. Receive the carrier by receiver and then adjust VR1/200-ohm semi-fixed resistor and TC1/30PF Trimmer capacitor to lowest signal level.
(Please connect the short wire to "RF OUT" terminal on SE-RF board when the signal is too weak.)

(CW adjustment)

Using 8.9985MHz carrier oscillator for receiving on each band and 8.9993MHz carrier oscillator for transmitting on each band. This set have 800Hz side tone oscillator, so you have to adjust CW tone for same frequency as per followings.

1. Set the band switch to 7MHz and change the mode switch to "LSB" position, then transmit. Receive the signal and make zero beat by separate receiver.
Change the mode switch to "CW" position and then key down (transmit). Make same sound of monitor and separate receiver by turning TC3 Trimmer capacitor.
2. In case you do not use CW Crystal Filter, connect the orange color pin to brown color pin (SSB Crystal Filter).
CW Crystal Filter is very sharpness, if the frequency of 8.9993MHz is loose, the ALC meter do not move.

(RIT adjustment)

1. Please set the RIT tuning knob to zero position.
2. Adjust the VR2 on SE-SW unit for same frequency by turning on-off the "RIT" switch on front panel.
3. Adjust the VR1 on SE-SW unit for same frequency on transmitting by turning on-off the "RIT" switch on front panel.

(Operation test)

Connect the power meter to "ANT" jack on rear panel. Turn on the mute x switch on rear panel. Connect the jumper cable between "LF-IN" and "10W OUT" jack. Plug in the 9-pin "REMOTE" plug to 9-pin jack on rear panel. (the 9-Pin "REMOTE" plug must be make jumper between pin number 8 and 9.)

Approximatly 10W output when you transmittte.

OPERATION (CAUTION)

1. Please use matched antenna for this set. The V.S.W.R. must be less than 1.3.
2. In case the cratch mechanism of 100KHz sub-dial is loosing, please take out tuning knob and then tighten the nut.
3. This set built-in ALC (automatic level control) cicuit, you can get much power when you disconnect the circuit, but the linearity of the amplifier circuit will be worth.
4. The transmittte and receive frequency is just same for this set when... you operate by tuning off "RIT" switch, but transmittte frequency will be sift when the adjustment of VR1 and VR2 is loosing.

CIRCUIT DIAGRAM OF UNITS

