

CONTENTS

Equipment supplied	2
Features	3
Controls and Connections	4
Getting Ready	8
Operation	10
Operating Controls	
(1) Setting an Operating Frequency.....	11
(2) Programming frequencies in Memory.....	12
(3) Recalling a Memory Frequency.....	14
(4) Shifting a Memory Frequency.....	15
(5) Changing a Memory Frequency.....	15
(6) Deleting a Memory Frequency.....	16
(7) Recalling a Call Frequency.....	17
(8) Shifting a Call Frequency.....	18
(9) Changing a Call Frequency.....	18
(10) Scanning.....	19
(11) Switching the Transmit Power.....	27
(12) Dual Watch Operation.....	28
(13) Duplex Operation.....	30
(14) Changing a Channel Step.....	31
(15) Battery Save Function.....	32
(16) Frequency Lock.....	32
(17) PTT Lock.....	33
(18) Switching Pause Scan And Busy Scan.....	33
(19) Tone Squelch Control.....	34
(20) Special Functions With the O/SET Button.....	36
(21) Pager and Code Squelch.....	47
(22) Repeater Operation.....	48
(23) Exchange the Transmit and Receive Frequency during Repeater Operation.....	49
(24) Setting a Shift Frequency.....	49
(25) Lithium Battery.....	50
Troubleshooting	51
Specifications	52

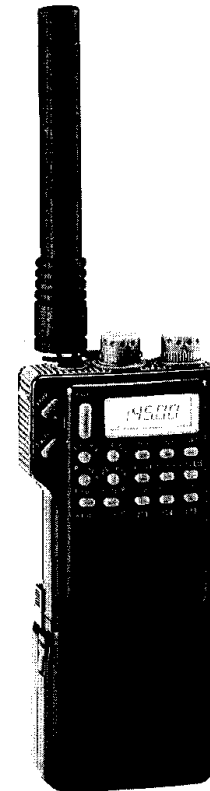

PRIOR TO USAGE

EQUIPMENT SUPPLIED

1. Make sure that batteries are inserted with correct polarity.

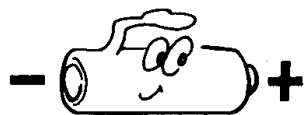

2. Do not disassemble and tamper with cores and trimmers SENDER-450 is produced under strict control and fully adjusted.

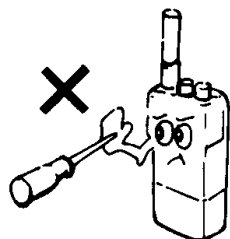

3. Keep out of high temperature, humidity and dust.

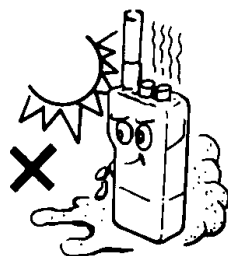

4. Apply 5.0 to 16.0V DC power supply only

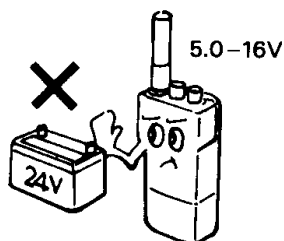

5. Do not use a new and used batteries together.

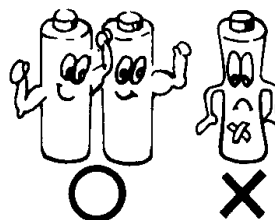

6. Do not dispose a battery in fire.

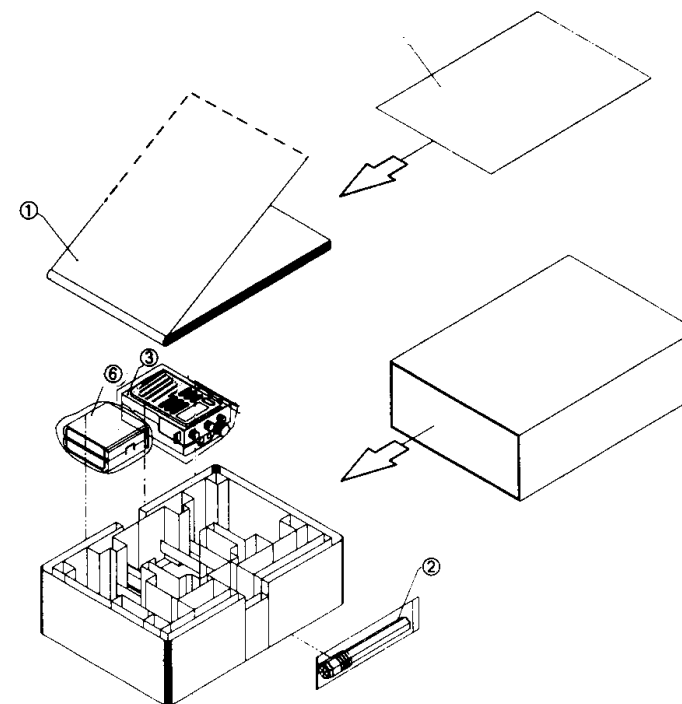

This unit is normally supplied with the items listed below. When unpacking the unit carton check the all items are included. If items are missing, please notify your dealer immediately.

- | | |
|---------------------------|---|
| 1. Owner's Manual | 4. Belt Clip |
| 2. Antenna | 5. Hand Strap |
| 3. Jack Cover (Installed) | 6. Battery case (For 6 size AA batteries) |

FEATURES

This Transceiver is a highly versatile, yet compact VHF hand-held transceiver that is built and tested to stringent specifications. The following features are built into your Transceiver.

- Paging function is available with an optional DTMF unit. This feature allows you to page one specific station or all group stations via 3-figured DTMF signals. When a paging signal is received, a beep sound and the display will inform you that someone has you paged. The paging station can be identified by means of its individual code.
- DTMF Code Squelch operation is available when an optional DTMF unit is installed. The Transceiver will hear certain stations using the identical code only.
- Sub-audible Tone Squelch operation is available when an optional tone squelch unit is installed. The Transceiver will hear certain stations using the specific tone frequency only. Tone frequencies can be selected via the rotary channel selector.
- The Tone Squelch can be used together with the DTMF function allowing you the simultaneous operation of DTMF Code Squelch and sub-audible Tone Squelch.
- An optional High Power Rechargeable Battery Pack or an external power supply of 13.8V enable powerful transmission (over 5W).
- A wide range of acceptable external power supply voltages (5 to 16V DC) allows you to power it from an automobile battery (specified for 12V only).
- Up to 20 memory channels are available. 10 in each M and M memory group.
- Four independent sub-audible tone frequencies can be programmed in M1 (or M1) and M2 (or M2) with optional Tone Squelch unit.
- Internal Dual-Watch allows this Transceiver to watch;
 - the selected dial-frequency and the stored frequency in memory address M1.
 - the selected dial-frequency and any other memory frequency.
 - The selected dial-frequency and each memory frequency under scanning in sequence. (Up to 20 channels).
- Duplex feature permits a semi-duplex operation using two memory frequencies allows 4 unique repeater offsets.
- Either Pause or Busy scan functions can be selected. Scanning of the dial-frequency provides a 1MHz scan, all band scan and programmed scan. Scanning of a memory frequency provides M memory group scan. M memory group scan, all memory scan and MS.M scan.
- A Squelch/Monitor button opens the squelch so you can easily check the volume setting or monitor for traffic.
- A Battery-Save function allows you to reduce the current drain during receiver standby.
- An Auto-Power Off function reduces the current drain if you forget to turn the Transceiver off.
- Frequencies can be entered directly from the keyboard or via a rotary channel selector.
- Selected frequencies and operating mode may be locked to prevent inadvertent key operation.
- PTT button may be locked to prevent inadvertent transmission.

CONTROLS AND CONNECTIONS

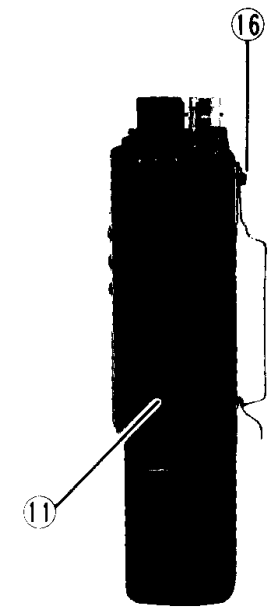
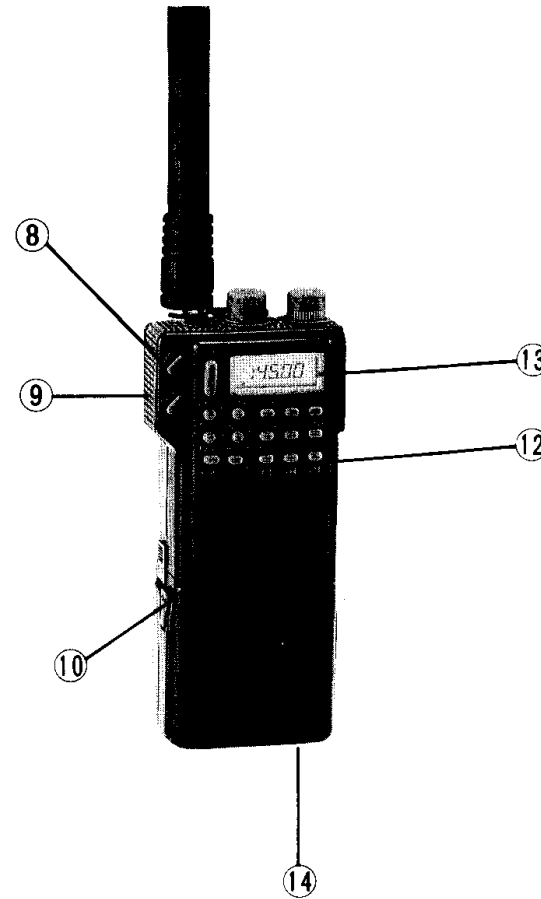
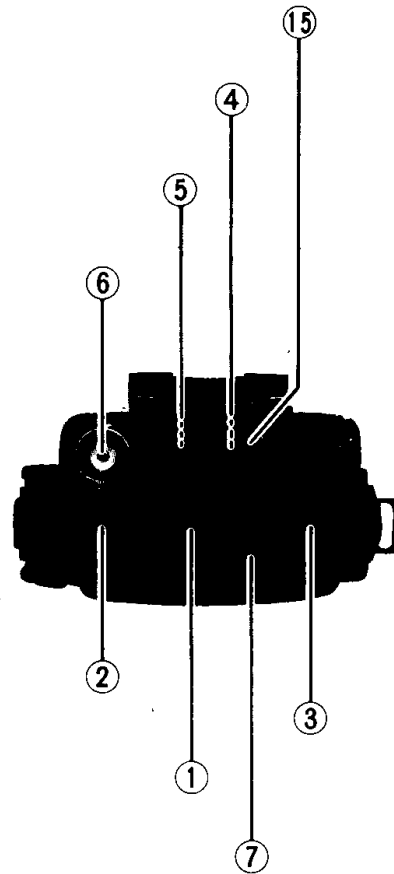

① Power On-OFF Switch/Volume C

This is to turn the power on and off and to control the volume. Rotate the control clockwise to turn the power on, and rotate it clockwise further to increase the volume. The Squelch Off button should be held depressed or the Squelch Control rotated fully counterclockwise while controlling the volume. Turning the power on with the Function button held depressed initializes a microprocessor and deletes all data programmed in the memory.

② Squelch Control

This is to control the white noise. Rotate the control counter clockwise and the white noise will be turned up. Rotate it then clockwise slowly and set the control where the noise just stops.

NOTE:

- (1) Do not rotate the control clockwise too far.
- (2) the control should be placed where the white noise is not heard during following operations; Scanning, Dual-Watch, Battery-Save, Paging and Code Squelch.
- (3) Adjust the control with the channel which is not receiving the signal.

③ Rotary Channel Selector

This is to select the transmit/receive frequency. It is also used to change the tone frequency, channel step and memory address number. Rotate the selector clockwise to increase the frequency and counterclockwise to lower it. The interval by which the frequency changes is referred to as "Channel Step". The Channel Step which is initially set to 10kHz can be changed to 5, 12.5, 20, 25 or 50kHz. (Refer to Changing the Channel Step, contents 12).

4 External Speaker Jack: S

This is to connect Microphone/Speaker or Head Set with PTT. Any other external speaker with 8Ω load or an earphone can be connected. A built-in speaker is disabled when an external speaker is connected to this jack.

⑤ External Microphone Jack: M

This is to connect Microphone Speaker Head Set with PTT.

⑥ Antenna Jack: ANT

This is a BNC connector to connect the attached helical antenna

⑦ Transmission/Battery Indicator

This red indicator lights up when the transmitter is keyed. With weakened batteries, it becomes darker recommending battery replacement.

⑧ Function Button

Special functions are available by pressing each button on the front panel with the function button held depressed.

⑨ PTT Button

For transmission, press this button and speak into the microphone. Release the PTT button to receive. When operated with Head Set with PTT, press the PTT button on HEAD SET to transmit.

⑩ Lock Button

This is to lock the battery case. Push up this button to remove the battery case.

⑪ External Power Connector:

This allows you to connect an optional power cord to power your transceiver from a 12V vehicle battery. When connected, power is not supplied from the internal battery.

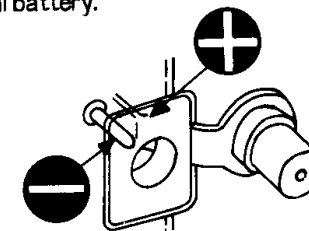

A pin at the center is negative

CAUTION:
 Turn the power switch off before connecting the cables. Nominal input voltage for this transceiver from 5V to 16V DC. Do not apply voltage beyond the range.

12 Front Panel

- A Squelch Off Button: SQL OFF**
 This button functions as the squelch control rotated fully counterclockwise. While this button is held depressed, the squelch operation is turned off and the sound is heard from the speaker regardless of the position of the squelch control.
- B Lamp Button: LAMP**
 While this button is held depressed, the light at the display is turned on. Press this button with the Function button held depressed to leave the light on and press it again to turn it off.
- C Call Button: CALL**
 Press this button to switch the operating frequency and call frequency.

- D Speaker**
 This is a built-in speaker, which is disabled when the external speaker is connected.
- E Microphone**
 This is a built-in condenser microphone
- F Key buttons for various operations**

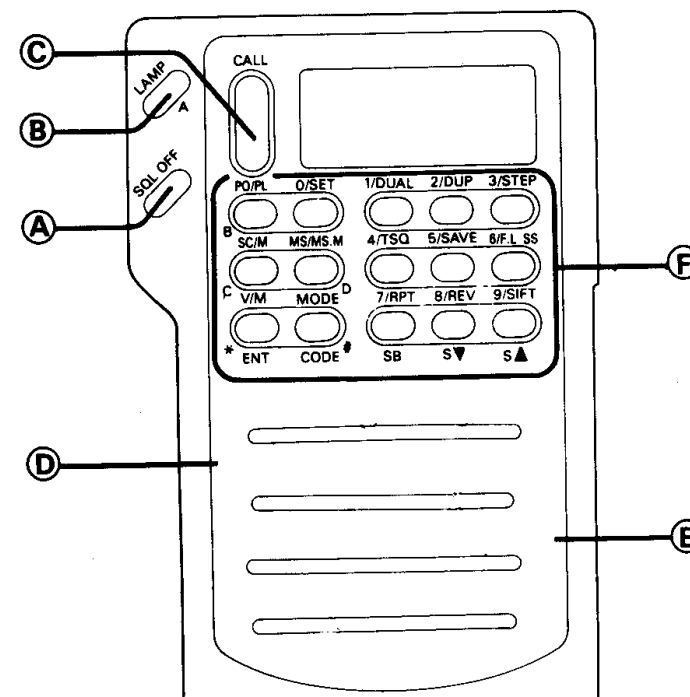

GETTING READY

1. Install the included antenna.

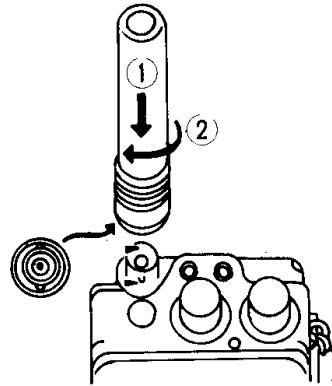

2. Detach the battery case.
a) Hold the Transceiver and place your thumb on the Lock button.
b) Push up the Lock Button and pull the battery case as illustrated to clear the lock.
c) Pull the battery case further and remove it from the Transceiver.

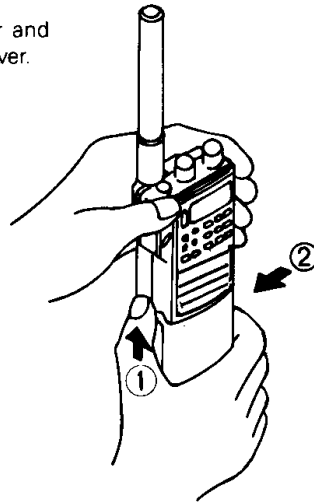

3. Insert size AA batteries into the battery case. Be sure that the batteries are inserted with correct polarity.

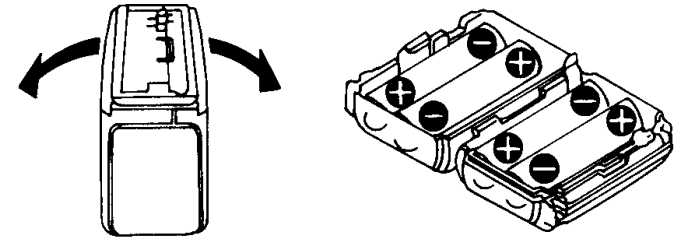

4. Replace the filled battery case to the Transceiver. Engage the battery case and the slot on the bottom of the Transceiver and push the battery case until it latches in the proper position.

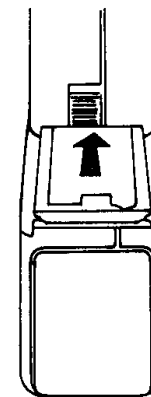

5. Turn the power switch on and set the volume control to a comfortable listening level.

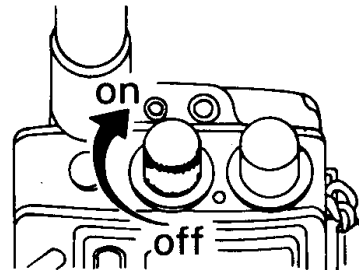

7. Press the PTT button to transmit and release it to receive

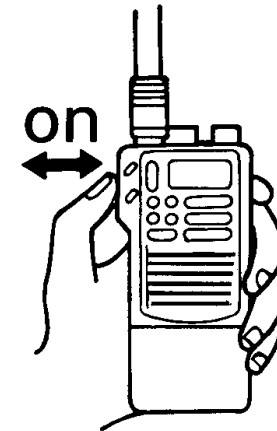

6. Rotate the squelch control clockwise slowly until the noise from the speaker just stops.

NOTE:

Do not rotate the control clockwise too far. Excessive squelch reduces the radio sensitivity and may prevent reception.

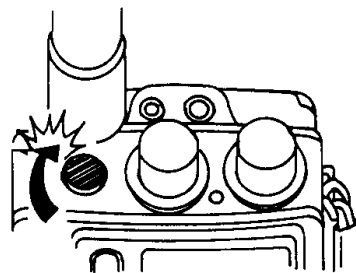

OPERATION

Operating Controls

Key buttons on the front panel function as described below. When operated correctly a high short beep tone will be generated. A low beep tone will warn you the wrong operation.

Button	Independent Function	Function with Function button
CALL	Switches the operating frequency and call frequency	
A/LAMP	Light at the display is turned on while held depressed	Turns on/off the light at the display
B/PO/PL	Switches the transmit power level	Disables the PTT button
C/SC/M	Scanning operation	Switches the memory channel group M and \bar{M}
D/MS MS.M	Turns on/off the memory scan	Sets the MS.M scan frequency and turns on/off the MS.M scan
*/V/M/ENT	Switches the operating frequency and the memory frequency, and accesses the operating frequency	Stores and deletes the frequency in memory
#/MODE/ CODE	Turns on/off and switches the paging and code squelch operation	Recalls the stored code in memory for paging and code squelch operation

Button	Independent Function	Function with Function button
0/SET	Inputs "0"	Selects the set mode
1/DUAL	Inputs "1"	Turns on the dual watch
2/DUP	Inputs "2"	Turns on/off the duplex features
3/STEP	Inputs "3"	Recalls the channel step
4/T.SQ	Inputs "4"	Turns on/off the tone squelch operation
5/SAVE	Inputs "5"	Turns on/off the save function
6/F/L/SS	Inputs "6" <ul style="list-style-type: none"> • During dial-frequency scanning, switches 1 MHz scan, all band scan and programmed scan • During memory frequency scanning, switches M or \bar{M} memory group scan and all memory scan 	Turns on/off the frequency lock function
7/RPT/SB	Inputs "7" <ul style="list-style-type: none"> • While scanning, switches the pause scan and busy scan 	Turns on/off the repeater operation.
8/REVS ▼	Input "8" <ul style="list-style-type: none"> • Scans downwards 	Exchanging the transmit and receive frequency during repeater operation
9/SIFT/S ▲	Inputs "9" <ul style="list-style-type: none"> • Scans upwards 	Setting a shift frequency

1 Setting an Operating Frequency

① With a rotary channel selector

You can change the operating (transmit and/or receive) frequency by rotating the rotary channel selector. As the selector rotated, the displayed frequency changes in 10kHz steps. It changes in 100kHz steps when rotated with the function button held depressed.

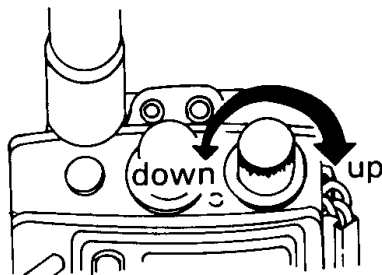

Procedure

Rotate the rotary channel selector clockwise to increase the displayed frequency and counterclockwise to decrease it.

Information

- The frequency step rate as the selector rotated is referred to as a channel step.
- Although the channel step is initially set to 10kHz at the factory, you may use any one of six options, 5, 10, 12.5, 20, 25 and 50kHz. How to select the channel step is outlined under "Changing the Channel Step", contents.

② With buttons on the front panel

You can change the operating frequency with numeral buttons of "0" to "9".

Procedure

Example: To set 145.80 MHz

- a) a MHz figure press "3".
[145.] will be displayed.
- b) a 100kHz figure press "8".
[145.8] will be displayed.
- c) a 10kHz figure press "0".
[145.80] will be displayed.

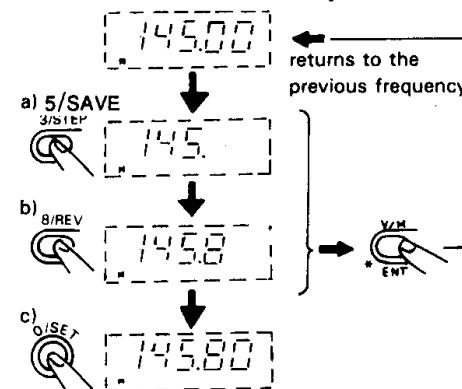

When three numeral buttons are pressed correctly, a long beep tone will be generated informing you that the frequency setting is complete.

Information

If you want to cancel the setting in the middle of the operation, press the * V/M/ENT button. The display will be returned to the previous frequency.

This is called the dial-frequency mode.

2 Programming Frequency in Memory [* / V / M / ENT Button]

Up to 20 frequencies can be stored in memory. They are memorized under the memory address number M0 through M9 and $\overline{M}0$ through $\overline{M}9$.

Procedure

(When the memory is vacant)

Example 1: To program 145.20MHz under M1.

- Set the dial-frequency to 145.20MHz
- Press the * / V / M / ENT button.
- "0" will be indicated on the display with a flashing "M".
- Set the memory address number to 1 by either pressing a "1" button or rotating the channel selector.
- Press the * / V / M / ENT button while pressing the Function button. The long beep tone will be generated to notify the operation is complete. "M" stops flashing and remain turned on. This is the memory mode and the stored frequency is **referred to as memory frequency**.
- Press the * / V / M / ENT button to return to the dial-frequency mode.
- Memorize the followings,
145.22MHz for M2, 145.24MHz for M3
145.26MHz for M4, 145.28MHz for M5

Further description is made upon the assumption that the above frequencies are stored in the memory.

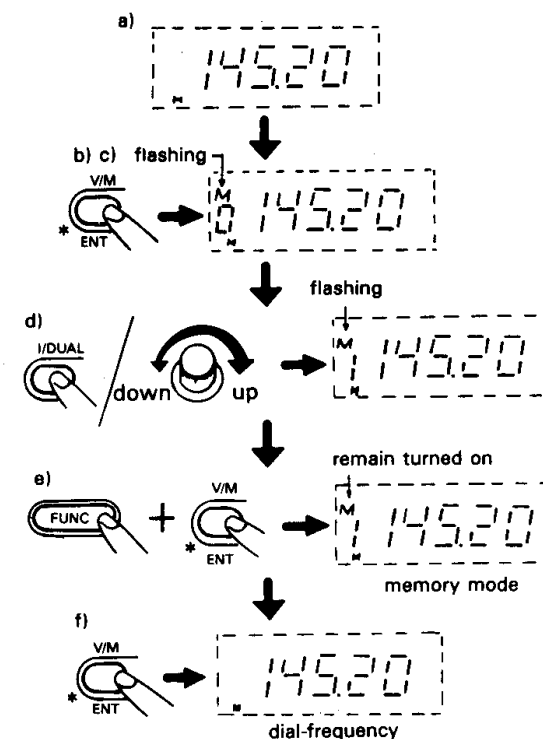

V/M/ENT

Example 2: To program 145.60MHz under M1.

Press the C/SC/M button first while pressing the Function button and select an address number to store the frequency under M address number group.

a) Set the dial-frequency to 145.60MHz.

b) Press the *V/M/ENT button

c) "M5" will be indicated on the display

NOTE:

The displayed address number when the Transceiver is set to the memory mode is the one used lastly. The initial setting at the factory is "M0".

d) Press the C/SC/M button while pressing the Function button and select the address number M1 by either pressing the "1" button or rotating the channel selector.

e) Press the *V/M/ENT button while pressing the Function button. The long beep tone will be generated to notify the operation is complete "M" stops flashing and remain turned on.

f) Press the *V/M/ENT button to return to the dial-frequency mode.

g) Memorize the followings;

145.62MHz for M2, 145.64MHz for M3

145.66MHz for M4, 145.68MHz for M5

Further description is made upon the assumption that the above frequencies are stored in the memory.

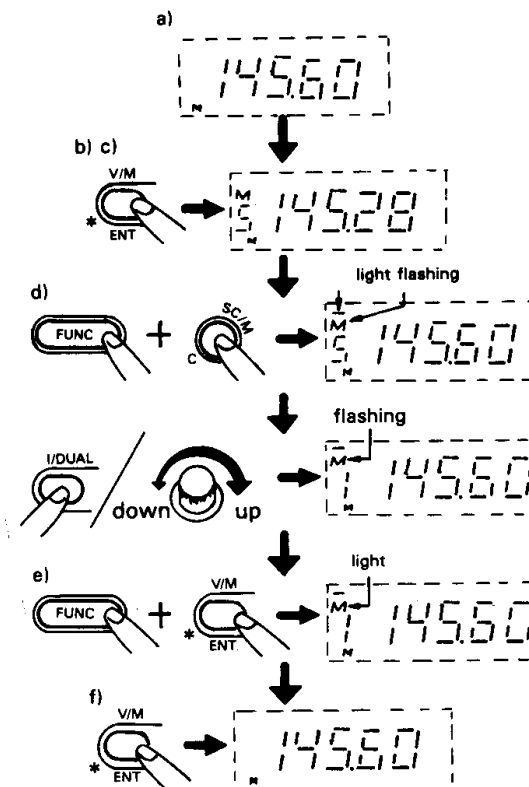

NOTE:

Programmed scan starts and ends at the frequencies stored under memory address M8 and M9.

3 Recalling a Memory Frequency [* / V / M / ENT Button]

Procedure

① **Example: To recall "M1"**

- a) Press the * / V / M / ENT button for the memory mode. The address number used lastly and the concerned frequency will be displayed. ("M" flashes when the indicated address number is vacant.)
- b) Press the number 1 button or rotate the channel selector for the address number "M1". The stored frequency under "M1" will be displayed.

② **Example: To recall the memory frequency successively**

Keep the Transceiver in the memory mode. Press the numeral button or rotate the channel selector for the desired address number. The stored frequency under the address number will be displayed.

Information

- The numeral button can only recall the address number within either M or \bar{M} memory group currently selected, while the rotary channel selector can recall every address number in both M and \bar{M} memory groups. When the recalled address number is vacant (i.e. no frequency is stored), "M" on the display will flash and the dial-frequency will be indicated. The * / V / M / ENT button switches the dial-frequency mode and memory mode.

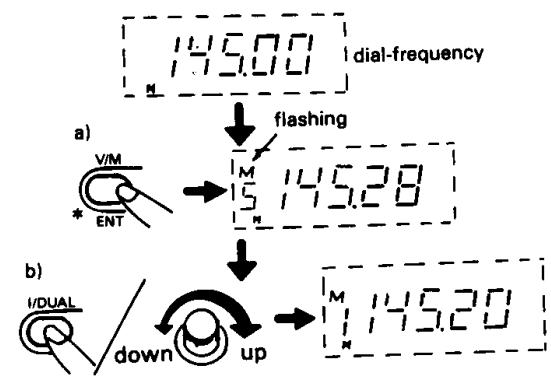

4 Shifting a Memory Frequency [C/SC/M Button]

Press the C/SC/M button in the memory mode. The Transceiver will be set to the dial frequency mode with the displayed memory frequency remain unchanged. That is, the displayed memory frequency becomes the operating frequency. This is called the memory-shift operation.

Information

Press the *V/M/ENT button if you do not want memory-shift operation. The dial-frequency displayed before the Transceiver is set to the memory mode will be returned.

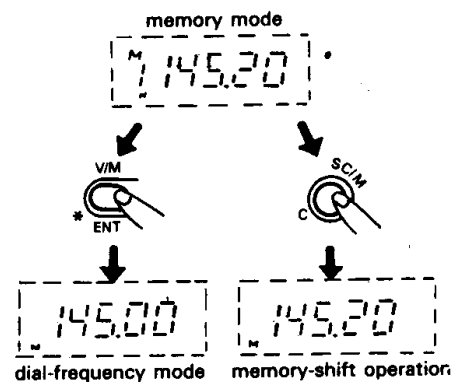

5 Changing a Memory Frequency

The stored frequency in memory can be changed by overwriting the new figure.

Example: To change the memory frequency of 145.20MHz under M1 to 145.16MHz.

Procedure

- Set the displayed dial-frequency to 145.16 MHz with the numeral buttons or the rotary channel selector.
- Press the *V/M/ENT button while pressing the Function button. "M" will appear on the display.
- Press the "1" button for the address number "M1". The long beep tone will be generated informing you that the memory frequency is altered.
- Press the *V/M/ENT button to return to the dial-frequency mode when the operation is complete.
- Change the memory frequency of M1" again to 145.20MHz

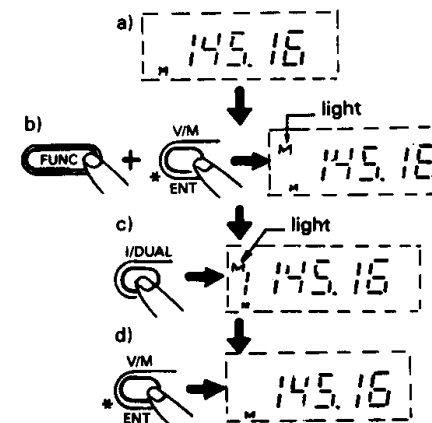

6 Deleting a Memory Frequency [* / V / M / ENT Button]

Follow the procedure below to delete the programmed frequency in memory.

Procedure

Example: To delete the frequency programmed under "M1".

- Press the * / V / M / ENT button. The memory address number used lastly and concerned frequency will be displayed.
- Press the C / SC / M button while pressing the "1" button. A string of tone will be generated and "M" on the display will start flashing. The programmed frequency under "M1" is now deleted.
- The dial-frequency will be displayed while the memory mode is sustained.
- Press the * / V / M / ENT button or C / SC / M button to release the memory mode.
- The Transceiver should be set to the dial-frequency mode as the operation is completed.

NOTE:

You can delete all user programmed functions and memories as follows: Turn unit off. Press and hold the function button while turning the unit back on. This will revert the unit back to the original factory settings.

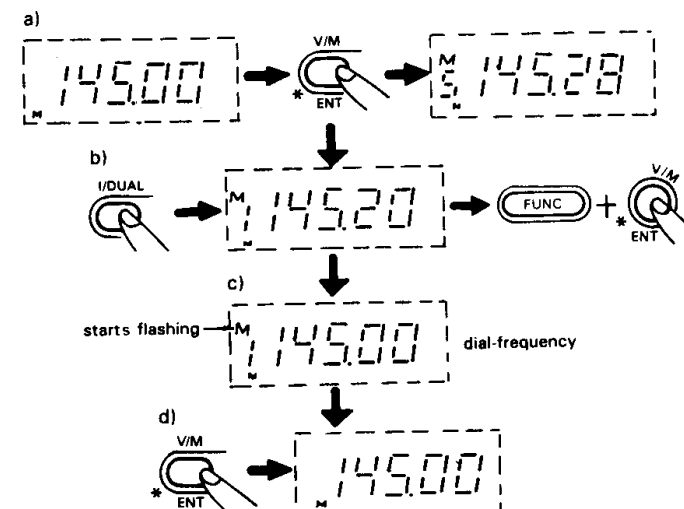

7 Recalling a Call Frequency [Call Button]

Procedure

- Press the call button for the call frequency mode "C" and the call frequency will be displayed.
- Press the call button in call frequency mode "C" and call frequency will disappear, and the dial-frequency will be displayed.

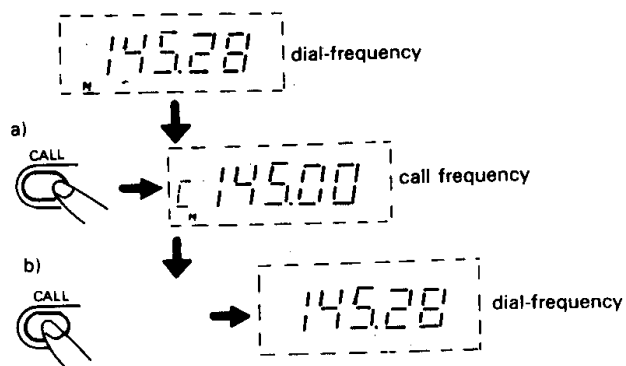

Information

- In call frequency mode, the rotary channel selector is disabled.
- Call frequency essentially is a special kind of memory frequency.

8 Shifting a Call Frequency (C/SC/M Button)

Press the C/SC/M button in the call frequency mode. The Transceiver will be set to the dial frequency mode with the displayed call frequency remain unchanged. That is, the displayed call frequency becomes the operating frequency. This is called the call-shift operation.

Information

Press the */V/M/ENT button if you do not want call-shift operation. The dial-frequency displayed before the Transceiver is set to the call frequency mode will be returned.

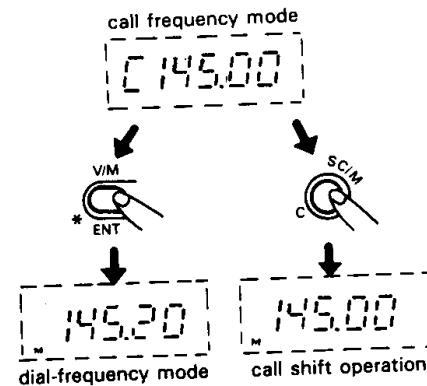

9 Changing a Call Frequency

The stored frequency in call memory can be changed by overwriting the new figure.

Example: To change the call frequency to 145.16MHz.

Procedure

- Set the displayed dial-frequency to 145.16 MHz with the numer buttons or the rotary channel selector.
- Press the */V/M/ENT button while pressing the Function button. "M" will appear on the display.
- Press the call button. The long beep tone will be generated informing you that the call frequency is altered.
- Press the */V/M/ENT button to return to the dial-frequency mode where the operation is complete.

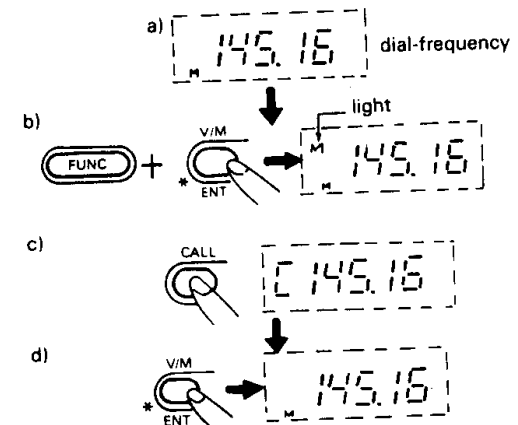

10 Scanning (C/SC/M Button and D/MS/MS.M Button)

The following buttons have special functions during scanning.

Buttons	During dial scanning	During memory scanning
6/F.L/SS	Switches 1MHz scan and all scan (switches 1MHz scan and programmed M scan when M8 and M9 are programmed.)	Switches M memory Scan (or M memory scan) and all memory scan.
7/SB/RPT	Switches pause scan and busy scan (Ⓚ is indicated on the display during busy scan)	Switches pause scan and busy scan (Ⓚ is indicated on the display during busy scan)
8/S ▼/REV	Lowers the frequency by one step and scans downwards. Scanning is quickened when kept depressed for over 0.5 second.	Lowers the memory address number by one step and scans downwards.
9/S ▲/SIFT	Increases the frequency by one step and scans upwards. Scanning is quickened when kept depressed for over 0.5 second.	Increases the memory address number by one step and scans upwards.

① Scanning Method

Either pause scan or busy scan can be selected.

- **Pause scan**

Pause scan ceases scanning when a signal is received. Scanning will then resume five seconds later or when the signal disappears, whichever occurs first.

- **Busy scan**

Busy scan stops scanning when a signal is received, but scanning resumes 4.5 seconds after the signal disappears.
(The Transceiver is initially set to pause scan)

② Various Scanning

This UNIT is capable of following scans.

- **Dial-frequency scan**

- (1) 1MHz scan
To scan any 1 MHz segment.
- (2) All band scan
To scan the band from one end to the other.
- (3) Programmed scan
To scan within or outside the programmed limits (M8-M9).

- **Memory frequency scan**

- (1) M group memory scan
- (2) M̄ group memory scan
- (3) All memory scan
- (4) MS.M memory scan

NOTE:

Memory frequency scan can be operated with battery save function as save memory scan.

③ Operation

• Dial-frequency scan

(1) 1MHz scan

- Set the Transceiver to the dial-frequency mode.
- Press the C/SC/M button. A short beep tone will be generated and the scanning will start at the displayed frequency for a 1 MHz segment. The decimal point keeps flashing during scanning operation.
- Press the C/SC/M button again to cancel the scanning.

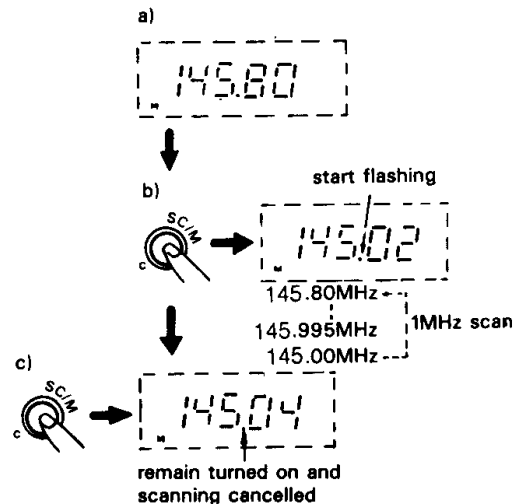

(2) All band scan

- Press the C/SC/M button. 1 MHz scan will start.
- Press the 6/F.L/SS button during 1 MHz scanning. A short beep tone will be generated and scanning of the entire band will start. The decimal point keeps flashing during scanning operation.
- Press the 6/F.L/SS button again to cancel the all band scanning. 1MHz scan will return.
- Press the C/SC/M button to cancel the scanning. The decimal point stops flashing.

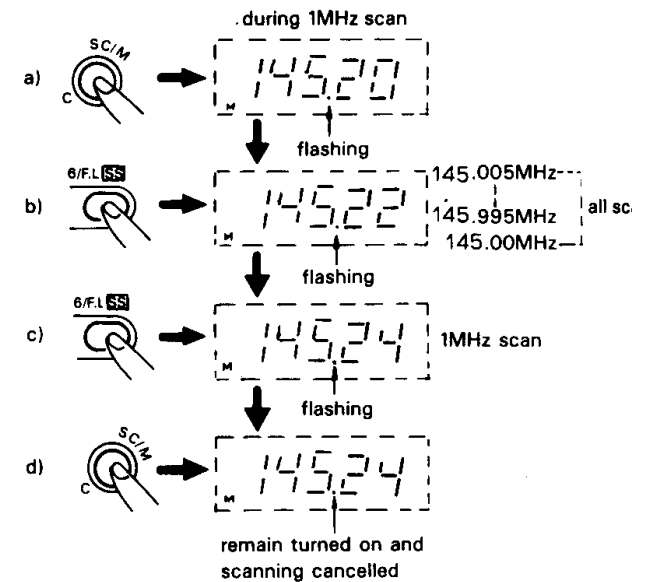

NOTE:

When frequencies are programmed for both $\overline{M8}$ and $\overline{M9}$, pressing 6/F.L/SS button during 1MHz scanning will start programmed sc

Information

- The display has no indicators for 1MHz scan and all band scan press the 5/SAVE button for rapid scanning and distinguish them if necessary.
- Once the scanning is cancelled, 1MHz scan always resumes as pressing to C/SC/M button for scanning operation. (Scanning is cancelled by turning the power switch off).
- Press either the 8/REV/S▼ button or 9/SIFT/S▲ button during scanning to change the scanning direction.
- Turn on/off the fast scanning while the 5/SAVE button is pressed.
- Press either the */V/M/ENT button or C/SC/M button to cancel scanning. The frequency displayed as the button is depressed becomes the operating frequency.
- Be sure that the Transceiver is in the dial-frequency mode before starting the scan, especially right after the memory mode is used.

(3) Programmed scan

This function allows you to scan the programmed range of frequencies. The programmed scan starts at the frequency programmed under the memory address number $\overline{M8}$ and returns to that frequency and continue scanning when the scanning reaches the frequency programmed for $\overline{M9}$.

① **To scan within the programmed limits**

Example: To scan between 145.30 MHz and 145.80 MHz

- Program 145.30MHz for the memory address number $\overline{M8}$ as a starting frequency.
- Program 145.80MHz for the memory address number $\overline{M9}$ as an ending frequency.
- Press the */V/M/ENT button for the dial frequency mode.
- Press the C/SC/M button for 1 MHz scan.
- Press the 6/FL/SS button during 1 MHz scanning. A short beep tone will be generated and scanning of the range between 145.30MHz and 145.80MHz will start.
- Press either the */V/M/ENT button or C/SC/M button to cancel the programmed scan.

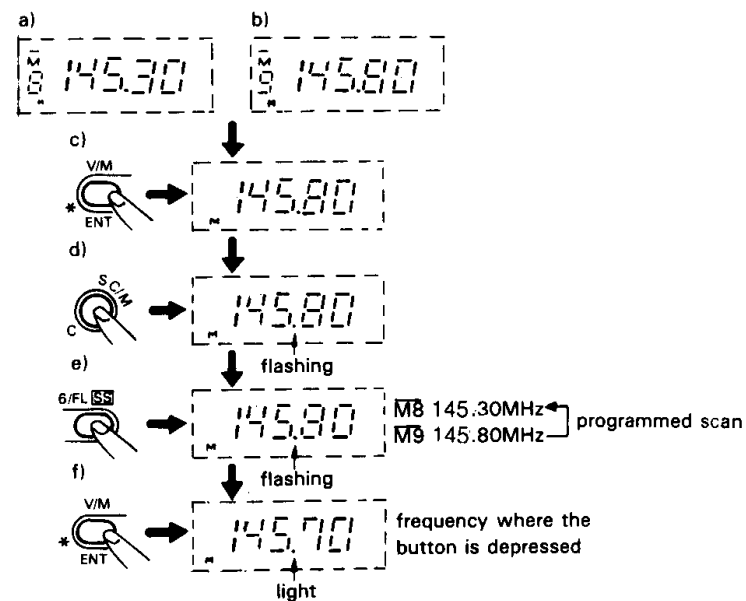
**Information**

- 1MHz scanning will return when the 6/FL/SS button is pressed during programmed scanning.
- When frequencies are programmed for both $\overline{M8}$ and $\overline{M9}$, the 6/FL/SS button switches the 1MHz scan and programmed scan. All band scan is only available when either or both of $\overline{M8}$ and $\overline{M9}$ are vacant.

② To scan outside the programmed limits

Example: To scan the entire band except the range between 145.30MHz and 145.80MHz

- Program 145.80MHz for the memory address number $\overline{M8}$ as a starting frequency
- Program 145.30MHz for the memory address number $\overline{M9}$ as an ending frequency.
- Press the */V/M/ENT button for the dial-frequency mode.
- Press the C/SC/M button for the 1 MHz scan.
- Press the 6/F.L/SS button during 1MHz scanning. A short beep tone will be generated and scanning of the entire band except the range between 145.30MHz and 145.80MHz will start.

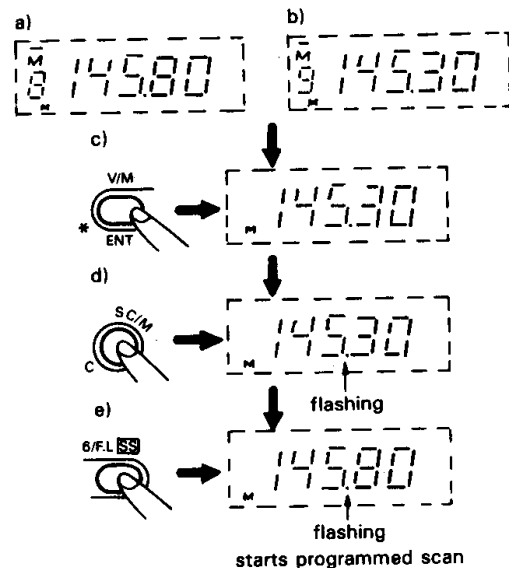
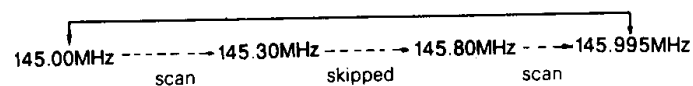

• Memory frequency scan

This function allows you to scan frequencies programmed in the memory. Two types of memory scans are available;

- Regular memory scan:** to scan every memory frequency programmed in either or both of memory address group M and \overline{M} .
- MS.M scan:** To scan signified memory frequencies.

Information

Memory frequency scan can be operated with battery save function as save memory scan, scanning with intervals of 600ms.

(1) M group memory scan

This function allows you to scan the memory frequencies of M0 through M9. A vacant address number is automatically skipped.

- Press the D/MS/MS.M button.
- The memory scanning will start at the following memory address number used lastly. The decimal point starts flashing and keeps flashing during scanning operation.
- Press the D/MS/MS.M button again to cancel the memory scan. The Transceiver will enter the memory mode.
- The memory scan resumes by pressing the D/MS/MS.M button again.

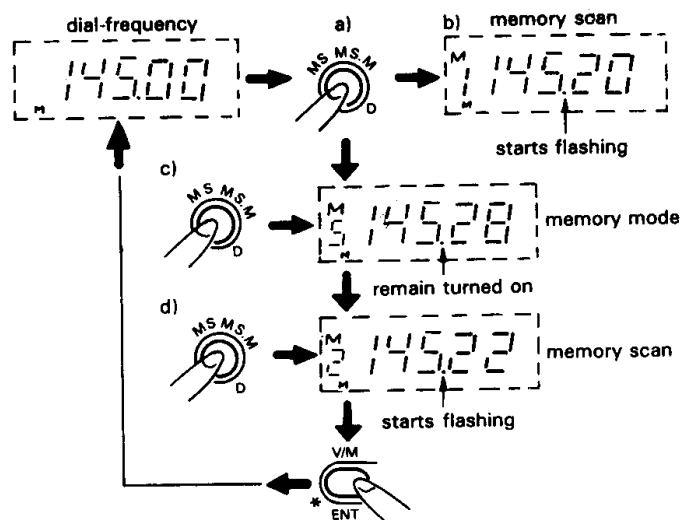

(2) \bar{M} group memory scan

This function allows you to scan the memory frequencies of $\bar{M}0$ through $\bar{M}9$. A vacant address number is automatically skipped.

- a) Press the */V/M/ENT button for memory mode.
- b) Press the C/SC/M button while pressing the Function button to recall the \bar{M} memory group.
- c) Press the D/MS/MS.M button.
- d) The memory scanning will start at the following memory address number used lastly. The decimal point starts flashing and keeps flashing during scanning operation.
- e) Press the D/MS/MS.M button again to cancel the memory scan. The Transceiver will enter the memory mode.
- f) The memory scan resumes by pressing the D/MS/MS.M button again.
- g) Press the */V/M/ENT button to return to the dial-frequency mode.

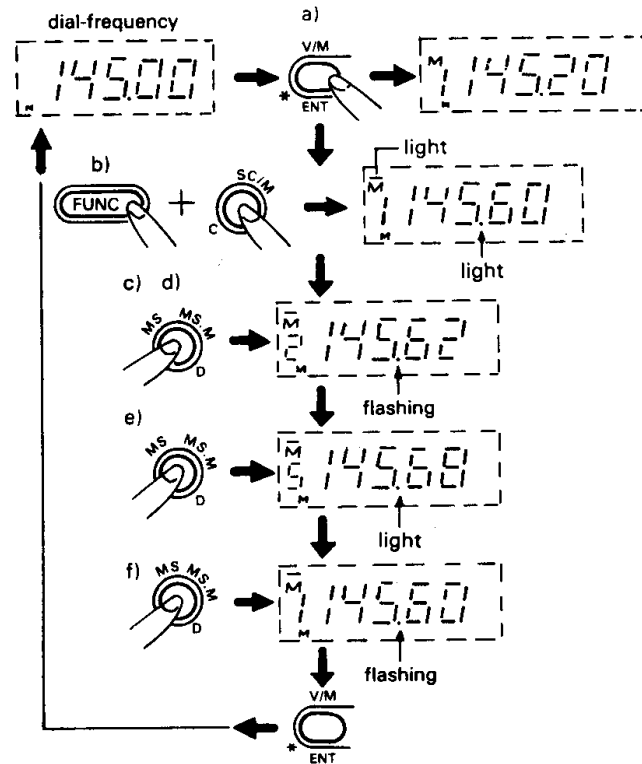

NOTE:
 The procedure described above is made upon the assumption that the M group address number was used lastly. When an address number in M group is used lastly, the procedure is identical to the one for \bar{M} group memory scan.

(3) All memory scan

this is to scan all memory frequencies, M0 to M9 and $\bar{M}0$ to $\bar{M}9$.

- a) Press the 6/F.L/SS button during memory scanning.
- b) The all memory scan will start. The decimal point starts flashing and keeps flashing during scanning operation.

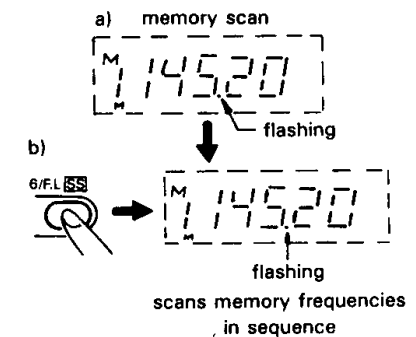

Information

Either the M group memory scan or the \bar{M} group memory scan resumes once the memory scan is cancelled and re-started. The memory scan will be cancelled by turning the power switch off.

(4) MS.M scan

This function allows you to scan the specified memory frequencies only.

① Setting the memory address number for MS.M scan.

- a) Press the */V/M/ENT button for the memory mode.
- b) Display the desired address number either with the numeral button or the rotary channel selector.
- c) Press the D/MS/MS.M button while pressing the Function button "▼" will be indicated above "M" on the display and the displayed frequency is programmed for the MS.M scan.
- d) Repeat the above procedure and program the desired frequencies for the MS.M scan.

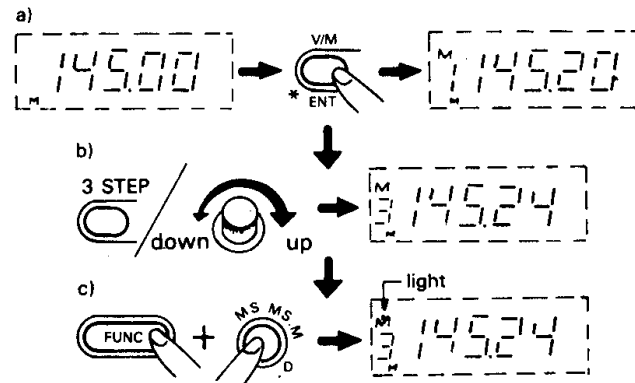

NOTE:

Repeat the above procedure to delete the programmed frequency for the MS.M scan. "▼" above "M" will disappear.

② Operation I.

- a) Set the Transceiver to the dial-frequency mode. Press the D/MS/MS.M button while pressing the Function button "▼" will be indicated above "M" on the display and the Transceiver is now ready for MS.M scan.
- b) Press the D/MS/MS.M button. The MS.M scan will start.

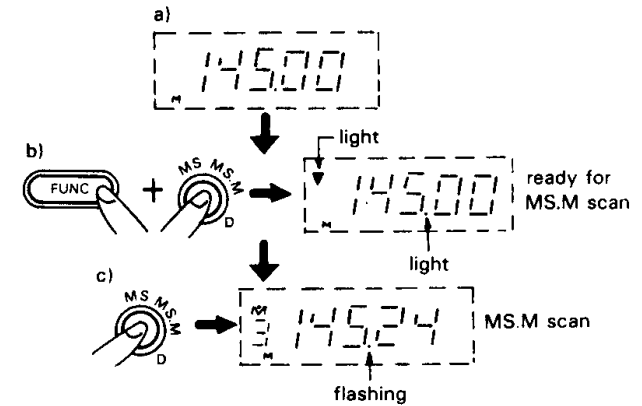

NOTE:

The MS.M scan is only available when the MS.M scan frequencies have been programmed.

③ Operation II.

- a) Press the D/MS/MS.M button for memory scan.
- b) Press the D/MS/MS.M button while pressing the Function button during memory scanning. The MS.M scan will start.

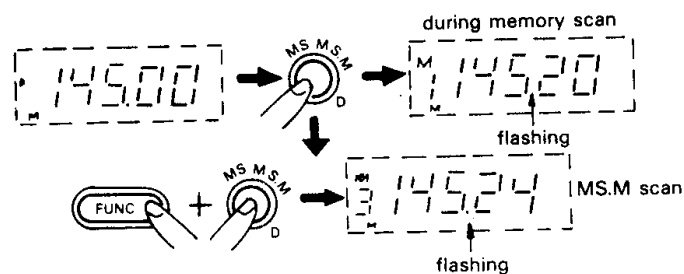

NOTE:
The MS.M scan is only available when the MS.M scan frequencies have been programmed.

④ Operation III.

- a) Start the MS.M scan either by operation I or II aforementioned. Press the 6/FL/SS button during MS.M scanning. The all MS.M scan, scans all MS.M frequencies in both M and \bar{M} memory group, will start. Press the 6/FL/SS button again. The MS.M scan of either memory group, the one where the button is depressed, will start.

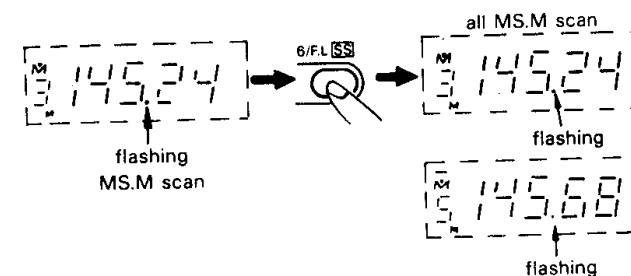

Information

The MS.M scan and all MS.M scan can be cancelled by depressing the D/MS/MS.M button while pressing the Function button. The memory scan will start.

NOTE:

- (1) "▼" above "M" on the display is an indicator for MS.M scan.
- (2) The MS.M scan is only available when the MS.M scan frequencies have been programmed.

11 Switching the Transmit Power (B/PO/PL Button)

This is to switch the transmit power. Three power levels are available for this transceiver. Select high, middle or low power depending on your purpose.

High power (H is displayed).....5.0W*/2.0W

Middle power (M is displayed).....2.5W*/2.0W

Low power (L is displayed).....0.35W*/0.35W

*With 13.8V Battery/7.2V Battery

Procedure

- Press the B/PO/PL button to switch the transmit power. The "M" on the display will be replaced by "L" indicating that the transmit power is switched to low.
- Press the B/PO/PL button again for high power. "H" will be displayed.
- Press the B/PO/PL button again. The middle power will be returned.

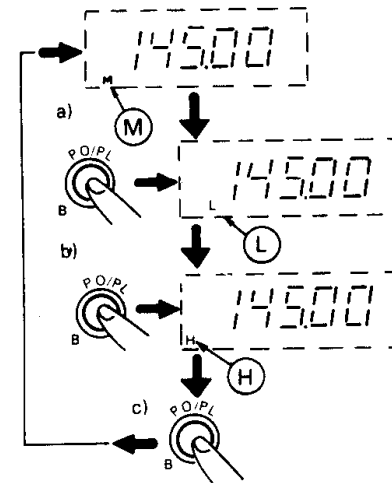

Information

The Transceiver is initially set to the middle at the factory.

12 Dual-Watch Operation [1/DUAL Button]

This function allows you to watch two different frequencies. This unit is capable of following types of dual-watch operation.

- (1) Listen on the dial-frequency and the memory frequency under M1.
- (2) Listen on the dial-frequency and one of the memory frequencies.
- (3) Listen on the dial-frequency and a memory frequency under scanning.

Information

- The word "DUAL" is indicated on the display during dual-watch operation.
- the dial-frequency can be changed during dual-watch operation.
- During dual-watch operation, the Transceiver listens on a memory frequency once every three seconds and instantaneously displays its frequency.
- Dual-watch operation pauses while the memory frequency is being received.
- When a signal is received on the dial-frequency during dual-watch operation, the signal will be heard interruptedly as the Transceiver leaves the dial-frequency once every three seconds.
- Rotate the squelch control fully counterclockwise to pause the dual-watch operation with the memory frequency to listen.

NOTE:

- (1) During dual-watch operation, transmission is only available at the dial-frequency.
- (2) Press the PTT button to transmit. The dial-frequency is displayed and you can transmit at the dial-frequency. Release the PTT button to return to dual-watch.
- (3) When a signal is received at the memory frequency, release the dual-watch operation and recall the memory frequency for communication.

① Dual-watch on the dial-frequency and the memory frequency under M1.

Procedure

- a) Set the Transceiver to the dial-frequency mode.
- b) Press the 1/DUAL button while pressing the Function button. A word "DUAL" will appear on the display to indicate the dual-watch operation.
- c) Press the *I/M button "DUAL" will disappear and the dual-watch will be cancelled.

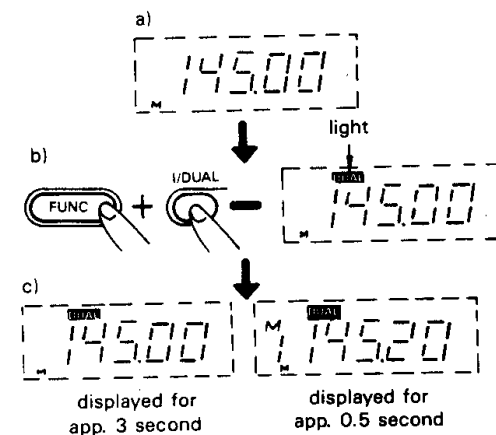

NOTE:

If no frequency has been stored in memory address number M1, the dual-watch operation is unavailable. You will hear a low-toned short beep when you press the 1/DUAL button informing you an incorrect entry.

② Dual-watch on the dial-frequency and a memory frequency (or call frequency).

Procedure

- a) Recall a memory frequency you wish to use in the dual-watch.
- b) Press the 1/DUAL button while pressing the function button. A word "DUAL" will appear on the display to indicate the dual-watch operation.
- c) The display will alternately indicate the dial frequency and a select memory frequency.

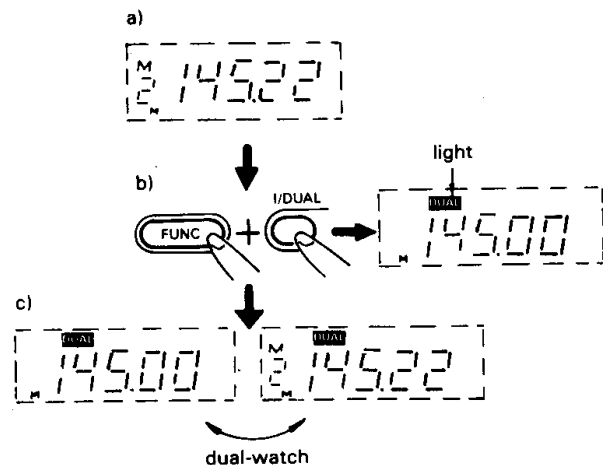

NOTE:

- (1) If no frequency has been stored in memory, the dual-watch operation is unavailable. You will hear a low-toned short beep when you press the 1/DUAL button informing you an incorrect entry.
- (2) In dual-watch operation call frequency is considered as one of memory frequencies. You can have dual-watch operation to listen on the dial-frequency and call frequency.

③ Dual-watch on the dial-frequency and a memory frequency under scanning in sequence.

Procedure

- a) Set the Transceiver to the memory scan mode
- b) Press the 1/DUAL button while pressing the Function button. A word "DUAL" will appear on the display to indicate the dual-watch operation. The display will sequentially indicate the dial-frequency and the memory frequencies under scanning one by one.
- c) Press either the C/SC/M button or *V/M/ENT button to cancel the dual-watch operation and to set the dial-frequency mode. The Transceiver will be set to either the dial-frequency mode or the memory mode depending on the condition at which the button is depressed.

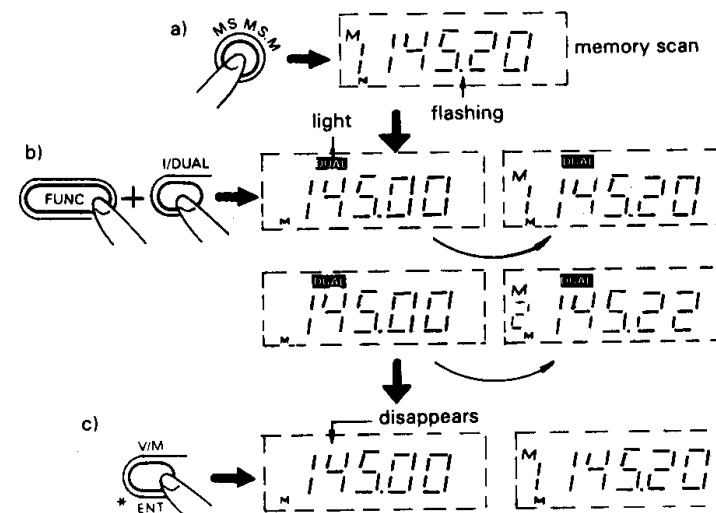

13 Duplex Operation (2/DUP Button)

Semi-duplex operation is available by using two different frequencies.

Procedure

- a) Program two frequencies you wish to use for duplex operation in M1 and M2.
- Example: Program a receive frequency under memory address M1 and a transmit frequency for M1. (or vice versa)**
- b) Set the Transceiver to the memory mode.
- c) Press the 2/DUP button while pressing the Function button. A word "DUP" will appear on the display to indicate duplex operation.
- d) Depress the PTT button to transmit. The display will indicate the transmit frequency. The Transceiver will receive at the frequency displayed when the PTT button is not pressed.

Information

Press the C/SC/M button while pressing the Function button to exchange the transmit and receive frequencies.

Example

	receive	transmit	→	receive	transmit
Station A	145.20MHz (M1)	145.60MHz (M1)		145.60MHz (M1)	145.20MHz (M1)
Station B	145.60MHz (M1)	145.20MHz (M2)		145.20MHz (M2)	145.60MHz (M2)

NOTE:

Duplex operation is not available in the dial-frequency mode.

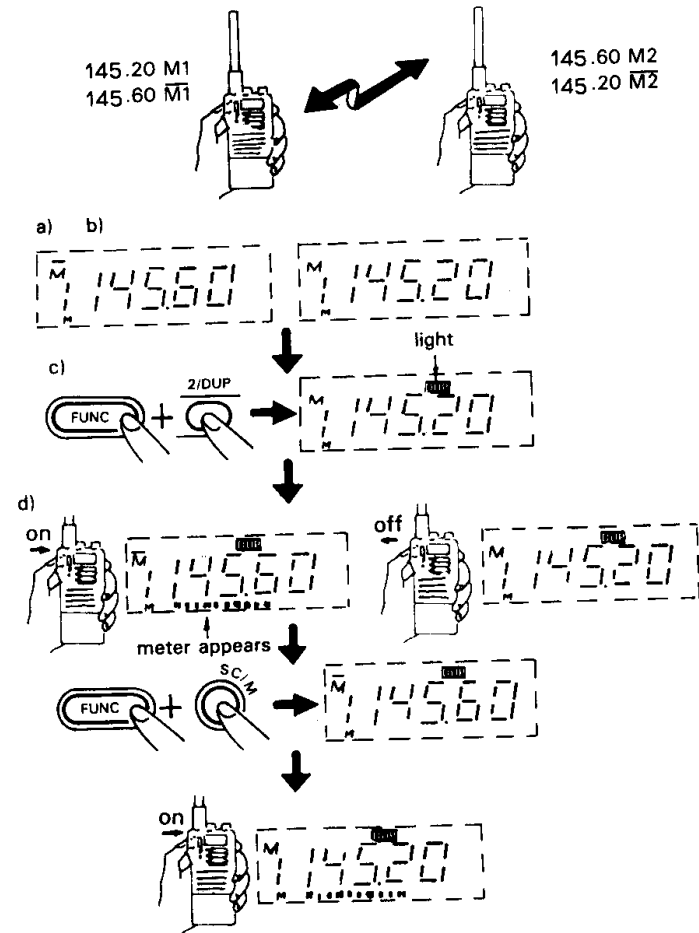

14 Changing the Channel Step [3/STEP Button]

You can set the Transceiver's step rate to 5kHz, 10kHz, 12.5kHz, 20kHz, 25kHz or 50kHz.

Procedure

- Press the 3/STEP button while pressing the Function button. The frequency display will disappear and replaced by the current step rate.
- Rotate the rotary channel selector. The six step rates will be sequentially indicated.
- Select the desired step rate. Then press the *V/M/ENT button to return to the previous dial-frequency.

Information

- When the step rate is set to 25kHz, 12.5kHz and 5kHz, the kHz digit of the dial-frequency will be shown in a small black box on the right side of the display.
- The step rate is initially set to 10kHz at the factory.

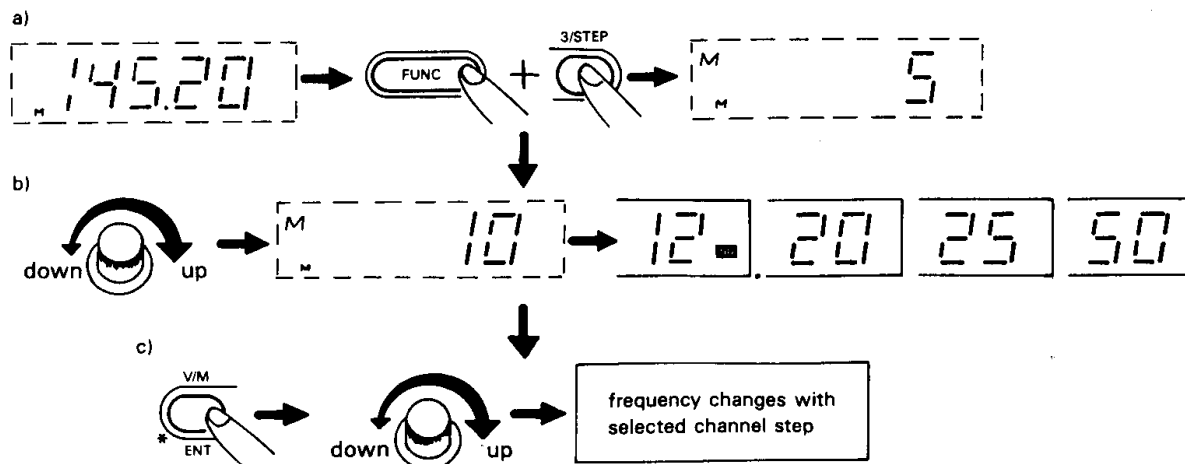

15 Battery-Save Function (5/SAVE Button)

This function allows you to reduce the current drain to 1/3 during receiver standby. The receiver will be activated once every single second.

Procedure

- Press the 5/SAVE button while pressing the Function button. A "S" will appear on the display to indicate that the battery-save function is enabled.
- Press the 5/SAVE button again while pressing the Function button to release the battery saver.

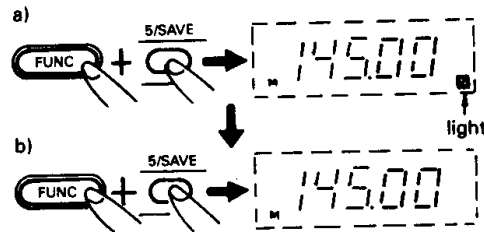

NOTE:
The battery saver is disabled during dual-watch operation and dial-frequency scanning.

16 Frequency Lock (6/F.L./SS Button)

This feature allows you to lock the frequency and operating mode to prevent improper operation. You can also use this feature during scanning and dual-watch operation.

Procedure

- Press the 6/F.L./SS button while pressing the Function button. A "FL" will appear on the display to indicate that the frequency and operating mode is locked.
- Press the 6/F.L./SS button again while pressing the Function button to unlock them.

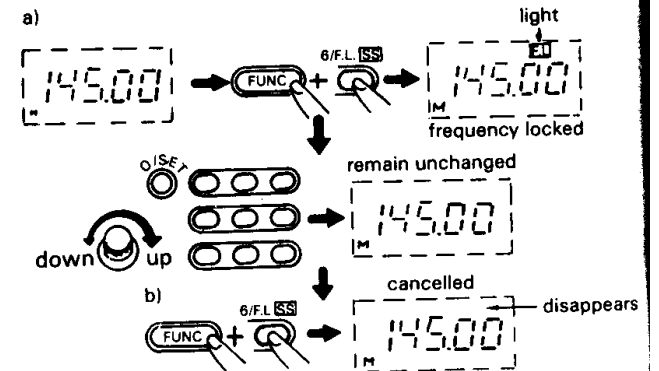

17 PTT Lock
(B/PO/PL Button)

This function allows you to disable the PTT button to reduce the chance of accidental transmission.

Procedure

- a) Press the B/PO/PL button while pressing the Function button. A "PL" will appear on the display and the P.T.T button is disabled.
- b) Press the B/PO/PL button again while pressing the Function button to enable the PTT button.

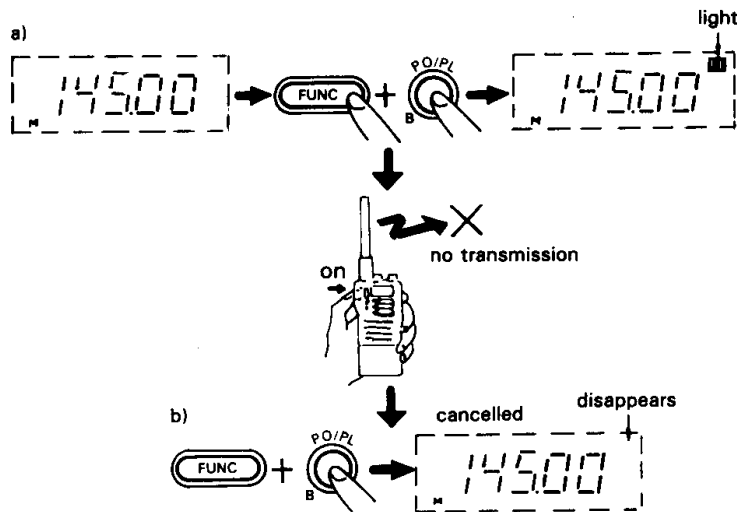

18 Switching Pause Scan and Busy Scan
(7/RPT/SB Button)

This function allows you to select either pause scan or busy scan. The Transceiver is initially set to pause scan at the factory. (see 10 Scanning in page 20)

Procedure

- a) Set the Transceiver to the scanning mode.
- b) Press the 7/SB button during scanning, a "B" will appear on the display to indicate the busy scan.
- c) Press the 7/SB button again to return to the pause scan, the "B" will disappear.

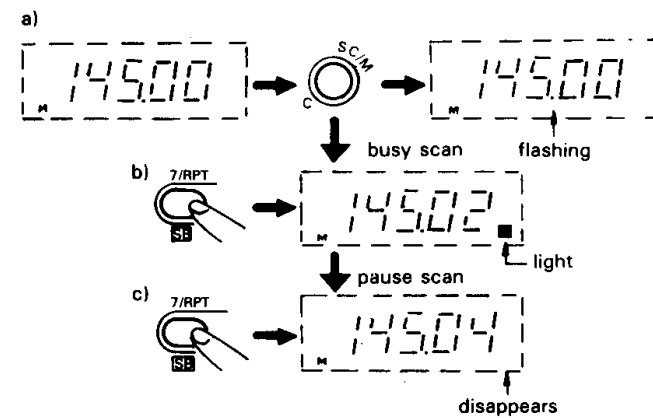

19 Tone Squelch Control
[4/T.SQ. Button]

Tone squelch operation is available when an optional tone squelch unit is installed.

NOTE:

- (1) Communication between stations incapable of tone squelch operation or having different tone frequencies is unavailable.
- (2) Select and program the required tone frequency before attempting tone squelch operation.

Procedure

- a) Press the 4/T.SQ button while pressing the Function button. "T" and "SQ" will appear on the display to indicate that the tone squelch is turned on.
- b) Press the 4/T.SQ button again while pressing the Function button to disable the tone squelch. "T" and "SQ" will disappear.

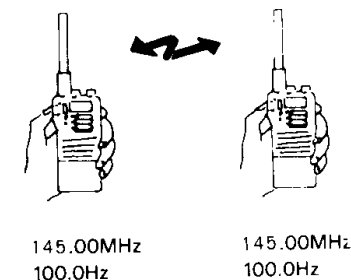
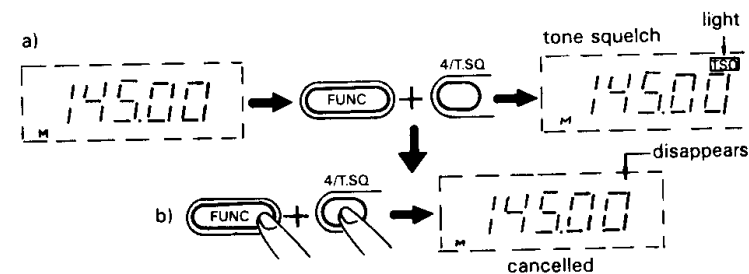

Advice

To store the tone squelch ON/OFF condition in M1, M1 and M2, or M2, first recall the memory address No. to store the tone squelch ON/OFF condition, then set the condition according to the procedure described above.

This allows the tone squelch operation condition to be written directly in M1, M1 and M2, or in M2.

NOTE:

- (1) "T" and "SQ" will be displayed even though the tone squelch unit is not installed.
- (2) The tone frequency is initially set to 88.5Hz for this unit at the factory. However, you can select any frequency indicated in the table "Recalling the tone frequency" page 40 to change the tone frequency.

20 Special Functions With SET Button {O/SET Button}

Press the O/SET button while pressing the Function button to enter the set mode. In the set mode, special functions listed in the table below are available.

NOTE:

- (1) A "M" will be indicated on the display when the Transceiver is in the set mode. However, there are no indicators on the display for special functions.
- (2) Press the */V/M/ENT button to return to the dial-frequency mode. Repeat the each procedure to release special functions.

Button	Special functions in set mode
O/SET	Muting the buzzer
1/DUAL	Setting for the kHz digits (with numeral buttons)
2/DUP	
3/STEP	
4/T.SQ	Recalling the tone frequency
5/SAVE	Turning on/off the Auto-Power OFF (APO)
6/F.L/SS	
7/RPT/SB	Disabled (low beep tone)
8/REV/S ▼	Disabled (low beep tone)
9/SIFT/S ▲	Disabled (low beep tone)

Muting the buzzer

This unit produces the following sounds:

- (1) Long beep indicates proper operation
- (2) Beeping alarm generated during Auto-Power Off operation and when receiving signals during pager operation
- (3) Low-toned beep indicates improper key entry
- (4) High-toned short beep .. indicates proper key entry.

Procedure

- a) Press the O/SET button while pressing the Function button A "M" will appear on the display to indicate the set mode.
- b) Press the O/SET button.
- c) The buzzer is muted and pressing a button will not generate any sounds.
- d) Press the O/SET button while pressing the Function button and then press the O/SET button again by itself to enable the buzzer.

NOTE:

- (1) The display does not indicate whether the buzzer is muted or not.

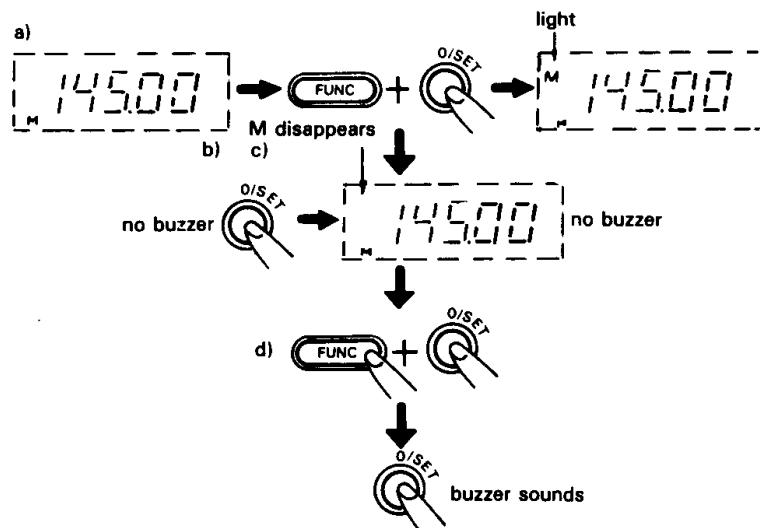

② Setting for the kHz digits

This feature allows you to enter the kHz digits, either 0 or 5.

Example: Normal entry 145.45MHz
With this special function 145.455MHz

Procedure

- Press the O/SET button while pressing the function button. A "M" will appear on the display to indicate the set mode.
- Press the 1/DUAL button.
- Set the desired frequency with a kHz digit by the numeral buttons. (i.e. enter four digits)
- Press the O/SET button while pressing the Function entry and then press the 1/DUAL button to return to the normal entry.

NOTE:

The display does not indicate whether the kHz digit can be entered or not. Simply press numeral buttons and enter the frequency to check it.

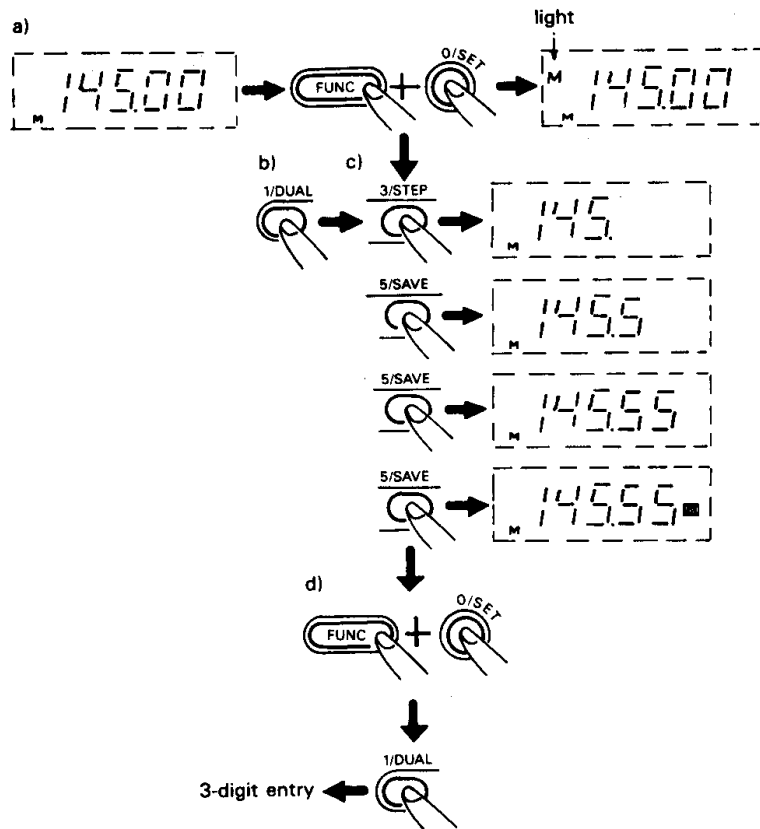

③ Recalling the tone frequency

You can select any one of thirty-eight tones which have been programmed in the microprocessor. The selected tone frequency can be stored in memory.

Available Tone Frequencies (in Hz)

67.0	71.9	74.4	77.0	79.7	82.5	85.4	88.5
91.5	94.8	97.4	100.0	103.5	107.2	110.9	114.8
118.8	123.0	127.3	131.8	136.5	141.3	146.2	151.4
156.7	162.2	167.9	173.8	179.9	186.2	192.8	203.5
210.7	218.1	225.7	233.6	241.8	250.3		

NOTE:

- (1) This feature is only available when an optional tone squelch unit is installed.
- (2) Memory address M1 ($\overline{M1}$) and M2 ($\overline{M2}$) are capable of storing two independent tone frequencies.

Procedure

- a) Press the O/SET button while pressing the Function button. A "M" will appear on the display to indicate the set mode.
- b) Press the 4/T.SQ button. The dial-frequency on the display will disappear and be replaced by a tone frequency. (88.5Hz is initially set at the factory)
- c) rotate the channel selector for a desired tone frequency.
- d) Press the */V/M/ENT button to complete the setting. The previous mode will be returned.

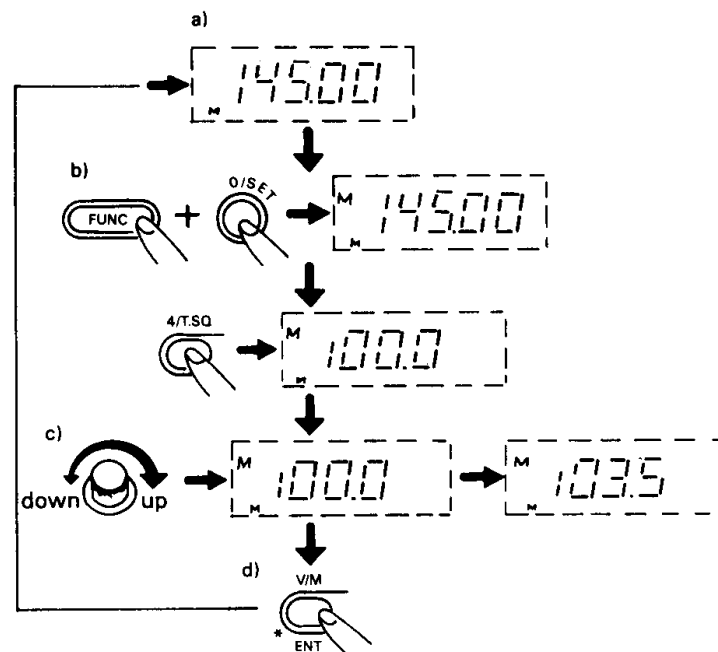

Information

To program an independent tone frequency for M1 ($\overline{M1}$) or M2 ($\overline{M2}$), recall the desired memory address number first and then follow the above procedure.

④ Auto-Power Off

An Auto-Power Off feature is built in to conserve power. When the Transceiver is left unused with the power switch turned on for 30 minutes, the Transceiver will generate beeping alarm. After the alarm, the Transceiver will automatically extinguish the most of the display and reduce the power consumption to approximately 5mA.

Procedure

- a) Press the O/SET button while pressing the Function button. A "M" will appear on the display to indicate the set mode.
- b) Press the 5/SAVE button and the word "APO" will appear on the display to indicate Auto-Power Off.
- c) When the operating buttons have not been operated or a signal has not been received for 30 minutes, the beeping alarm is generated.
- d) This unit will extinguish the most of the display to reduce the power consumption. The frequency will disappear and be replaced by a word "APO" (i.e. the Transceiver is in the sleep standbymode.)
- e) Press the C/SC/M button to release sleep standby. The power will be turned on and the Auto-Power Off timer will be extended for another 30 minutes. i.e. the Transceiver returns to the condition of (b).

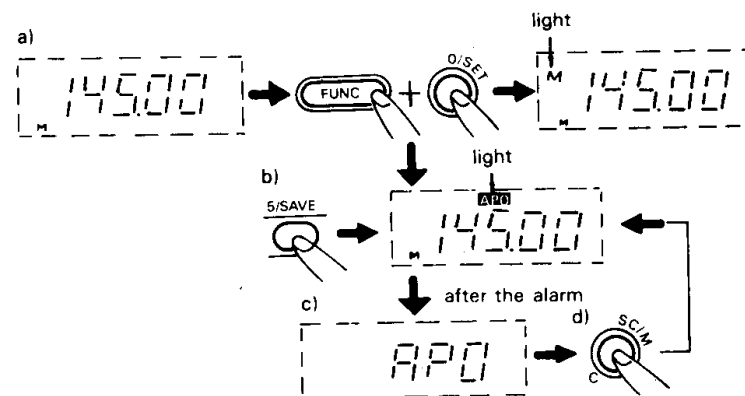

NOTE:

- (1) When the "APO" replaces the frequency on the display, both the receiver and transmitter are disabled.
- (2) Although the Auto-Power Off function enables to reduce the power consumption to a minimum, make sure that the power switch is turned off when you finish operation.
- (3) Every operating button is disabled in the sleep standby mode except the C/SC/M button.

21 Pager and Code Squelch [#/MODE/CODE Button]

This feature enables you to page one specified station (individual paging) or all group stations (group paging) over the Transceiver.

NOTE:

Install an optional Touch Tone unit for pager and code squelch operation.

Individual code and group code, each with 3 figures, must be programmed before the operation. Pager and code squelch operation is only available when they are programmed.

Example:

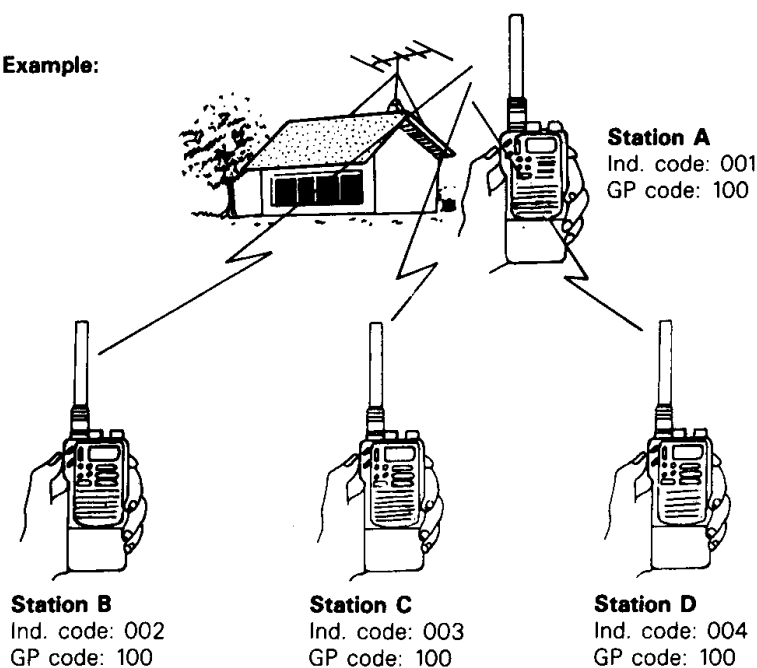

An individual code and group code have been respectively programmed for Station A through D.

- **To call stations from Station A.**

Recall a group code and press the PTT button. At the Station B through D, a beep sound will be generated and "M2 C100" will appear on the display to indicate that they have been paged.

- **To call Station B from Station A**

Program an individual code of Station B for address number M1 and press the PTT button. At Station B, a beep sound will be generated and "M0 C001" will appear on the display to indicate that Station A

Preparation for paging

- 1) Install an optional Touch Tone Unit to this unit
- 2) Program an individual code
- 3) Program a group code.

NOTE:

A group code must be common for all members of the group. Both individual and group codes must be a number of 3 figures.

Procedure

Example: To program an individual code 001 for the code memory address M3 and a group code 100 for M2.

- a) Press the #/MODE/CODE button while pressing the Function button.
- b) The frequency on the display will disappear and be replaced by "M0 C000".
- c) Code memory address M0 through M3 are used for paging operation. They are indicated on the display successively by rotating the channel selector. (the initial display is M0 C000).
- d) Rotate the channel selector for M3 and press numeral buttons 0, 0 and 1. A long beep tone will be generated to inform you that programming of the individual code is complete.
- e) Rotate the channel selector for M2 and press numeral buttons 1, 0 and 0. A long beep tone will be generated to inform you that programming of the group code is complete.

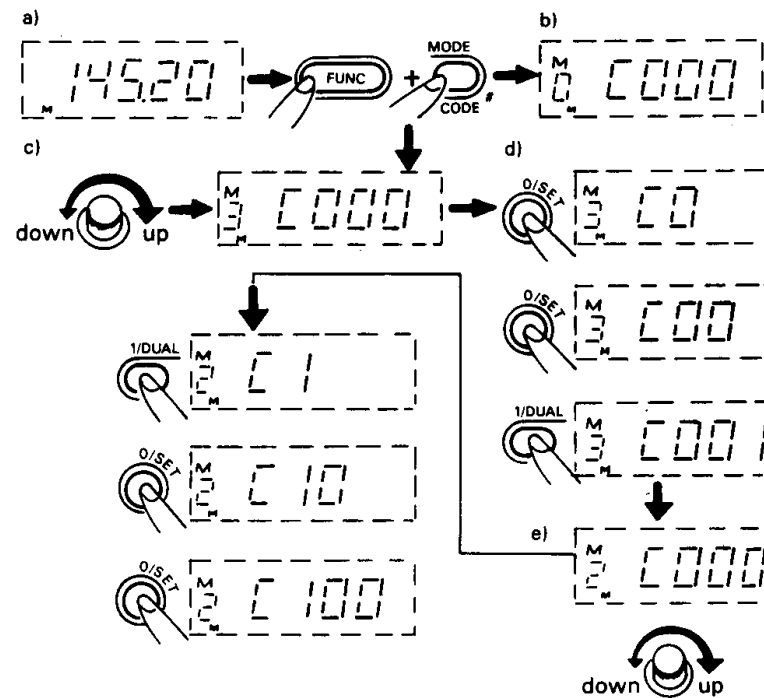

Information

A 3-figured individual and group code are composed of three DTMF signals.

Code Memory Address Number	USE
M0	Memory for individual code of the paging station. The paging station can be called back in return with the stored code in this memory. (paging operation)
M1	Memory for individual code of the station to be paged. This memory is for transmission only. (paging operation)
M2	Memory for group code. This memory is for both transmission and reception. (paging and code squelch operation)
M3	Memory for individual code of its own. This memory is for reception only. (paging operation)

② Operating

[Paging Station]

• **Individual paging**

The operating frequency should have been selected prior to usage.

- a) Program you individual code and a group code.
- b) Program an individual code of the station to be paged. Press the #/MODE/CODE button while pressing the Function button. Rotate the channel selector for the code memory address M1 and set the desired individual code with numeral buttons.
- c) Press the */V/M/ENT button for the dial-frequency mode. A word "PAG" will appear on the display.
- d) Press the PTT button. DTMF signals, the destination code followed by your own code, will be automatically transmitted. (DTMF signal tone can be heard.)

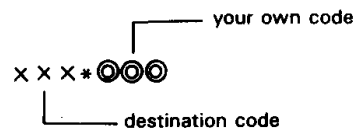

* **Group paging**

The operating frequency should have been selected prior to usage. Program a group code to call member stations. Press the #/MODE/CODE button while pressing the Function button. Rotate the channel selector for the code memory address M2 and set the group code with numeral buttons.

- b) Press the */V/M/ENT button for the dial-frequency mode.
- c) Press the #/MODE/CODE button for the paging mode. A word "PAG" will appear on the display.
- d) Press the PTT button. DTMF signals, the group code followed by your own code, will be automatically transmitted. (DTMF signal tone can be heard.)

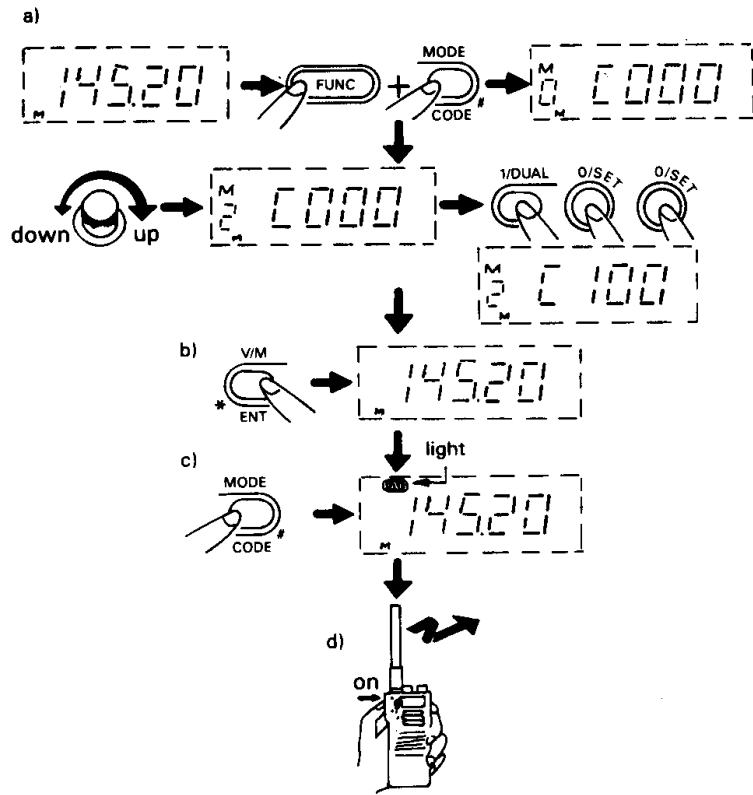

[Receiving Station]

• **Individual paging**

The operating frequency should have been selected prior to usage.

- a) Program your own individual code and a group code.
- b) Press the #/MODE/CODE button for the paging mode. A word "PAG" will appear on the display.
- c) When the received individual code is identical to the stored your own code, beep sounds will be generated and a "PAG" will start flashing to indicate that you have been paged. A frequency on the display will disappear and be replaced by an individual code of the paging station, MO CXXX.
- d) Press the PTT button to respond. DTMF signals will be transmitted in turn.
- e) Press the #/MODE/CODE button and release the paging mode to communicate.

• **Group paging**

The operating frequency should have been selected prior to usage.

- a) Program a group code.
- b) Press the #/MODE/CODE button for the paging mode. A word "PAG" will appear on the display.
- c) When the received group code is identical to the stored group code, beep sounds will be generated and a "PAG" will start flashing to indicate that you have been paged. A frequency on the display will disappear and be replaced by the group code. M2 CXXX.
- d) Press the PTT button to respond. DTMF signals will be transmitted in turn.
- e) Press the #/MODE/CODE button and release the paging mode to communicate.

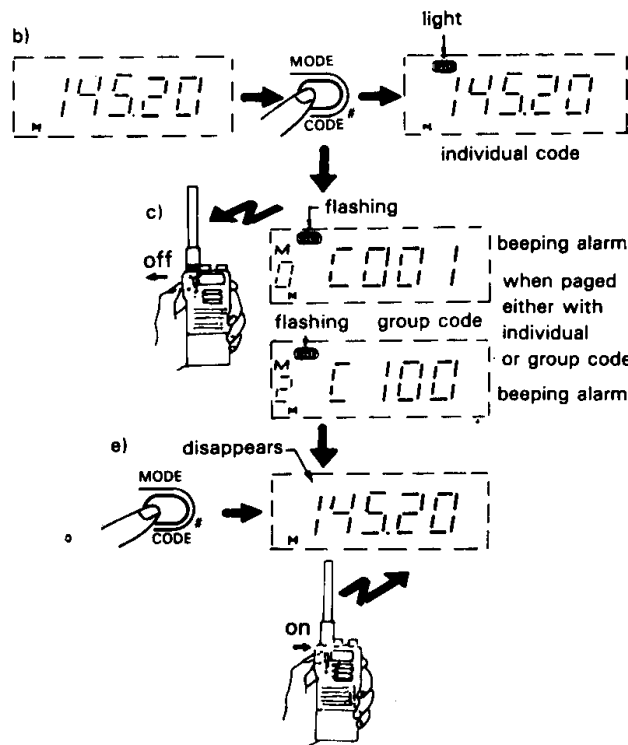

Information

- A "PAG" on the display stops flashing and remains turned on when any operating button is pressed.
- Press the Function button to stop the beep sound halfway.
- A group code will be transmitted when the PTT button is pressed with M3 (your own individual code) selected. (This is an improper operation.)
- An unidentified code received will appear on the display when the reception is incomplete and the individual code of the paging station is not clear. Therefore, the paging station cannot be identified.

Examples of paging operation

- Individual paging

Station A

Individual Code M3 001
Group Code M2 100

Station B

Individual Code M3 002
Group Code M2 100

- | | | |
|---|-------------------|---|
| <ul style="list-style-type: none"> a) Press the #/MODE/CODE button for the paging mode. b) Press the #/MODE/CODE button while pressing the Function button. Program the individual code of Station B 002 for memory address M1. c) Press the PTT button. Individual code of Station B and of its own will be transmitted. d) A pager beep sound will be generated and a "PAG" will start flashing "M0 C002" will appear on the display to indicate that Station B is calling transmitted. back. e) Press the #/MODE/CODE button to release the paging mode and start communication as usual. | <p>→</p> <p>←</p> | <ul style="list-style-type: none"> a) Press the #/MODE/CODE button for the paging mode. b) A pager beep sound will be generated and a "PAG" will start flashing "M0 C001" will appear on the display to indicate that Station A is paging. c) Press the PTT button to call back Station A in return. Individual codes of Station A and of its own will be transmitted. d) Press the #/MODE/CODE button to release the paging mode and start communication as usual. |
|---|-------------------|---|

• **Group paging**

Station A

Individual Code M3 001
Group Code M2 100

Recall the stored group code in code memory address M2 and press the PTT button. Stations having the identical group code will be paged.

Station B

Individual Code M3 002
Group Code M2 100

M2 C100'' will appear on the display to indicate that the Station is paged with the group code.

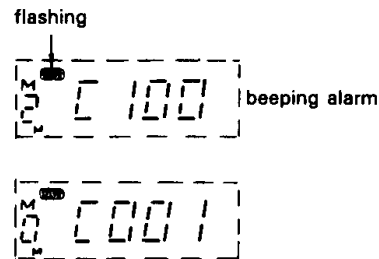

Rotate the channel selector for memory address M0 to display the individual code of paging station.

Station C

Individual Code M3 003
Group Code M2 100

M2C100'' will appear on the display to indicate that the Station is paged with the group code if the individual code of the paging station cannot be identified.



The unidentified code will be stored in M0.

③ Code squelch operation

- Press the #/MODE/CODE button for code squelch mode. A "C.SQ" will be indicated on the display.
- A group code will be transmitted enabling the code squelch operation. A noise can only be heard from the speaker when a signal from the station having the identical group code is received.
- A group code programmed in the code memory address M2 is used for the code squelch operation.
- Combined with an optional Tone Squelch Unit your radio will remain quiet unless certain stations using the same group code and the tone frequency call you.
- In the code squelch mode, the M2 code is always used regardless of the selected code memory channel.

NOTE:

The group code will be transmitted for approximately 0.3 second. Start communications after the code has been transmitted.

22 Repeater Operation

[7/RPT/SB Button]

1. Repeater Operation

This function allows you to use your Transceiver with a repeater.

Procedure

- a) Set your Transceiver to the output frequency of the repeater you wish to use.
- b) Press the 7/RPT/SB button while pressing the Function button "--" will appear on the display to indicate that repeater operation is enabled.
- c) Press the 7/RPT/SB button again while pressing the Function button "--" on the display will be replaced by "+".
- d) Press the 7/RPT/SB button again while pressing the Function button to release the repeater operation. "+" will disappear and the simplex operation will be returned.

Information

"--" and "+" on the display indicates that the shift direction of the transmit frequency is negative or positive respectively. The amount by which the transmit frequency is shifted is referred to as the shift frequency and is initially set to 0.6MHz.

NOTE:

Adding or subtracting the shift frequency from the receive frequency makes the transmit frequency. Be sure that the transmit frequency is within the operating frequency range. A "OFF" will appear on the display and transmission is disabled if the transmit frequency happens to be out of the range.

23 Exchange the Transmit and Receive Frequency during Repeater Operation [8/REV/S ▼ Button]

This feature allows you to exchange the transmit and receive frequencies during repeater operation. You can check if the other station is accessible.

Procedure

- a) Set the Transceiver to the repeater mode.
- b) Press the 8/REV/S ▼ button while pressing the Function button. "--" or "+ +" on the display will start flashing and the transmit and receive frequencies will be reversed.
- c) Press the 8/REV/S ▼ button again while pressing the Function button. "--" or "+ +" on the display will stop flashing and remain turned on. The transmit and receive frequencies will be reversed again and the regular repeater-mode will be returned.

NOTE:

This feature is only available during repeater operation and when the transmit frequency is within the operating frequency range.

24 Setting a Shift Frequency [9/SIFT/S ▲ Button]

A shift frequency for repeater operation can be changed within the limits of 0.00MHz to 39.995MHz. An independent shift frequency can be programmed for each three groups.

Group 1: dial-frequency, M0, M3 through M9, $\overline{M0}$, $\overline{M3}$ through $\overline{M9}$, call frequency

Group 2: M1 and $\overline{M1}$

Group 3: M2 and $\overline{M2}$

Procedure

- a) Select a group you wish to program a shift frequency
- b) Press the 9/SIFT/S ▲ button while pressing the Function button. The current shift frequency in memory will be displayed. (The shift frequency is initially set to 5.00MHz)
- c) Select the desired shift frequency with the rotary channel selector or numeral buttons.
- d) Press the C/SC/M button to return to the previous mode.

Information

When setting the shift frequency with numeral buttons three digits starting the MHz figure can only be entered.

NOTE:

When memory address M1, $\overline{M1}$, M2 and $\overline{M2}$ are vacant, a shift frequency cannot be programmed for group 2 and 3. Moreover, attempting to program it will change the one of group 1.

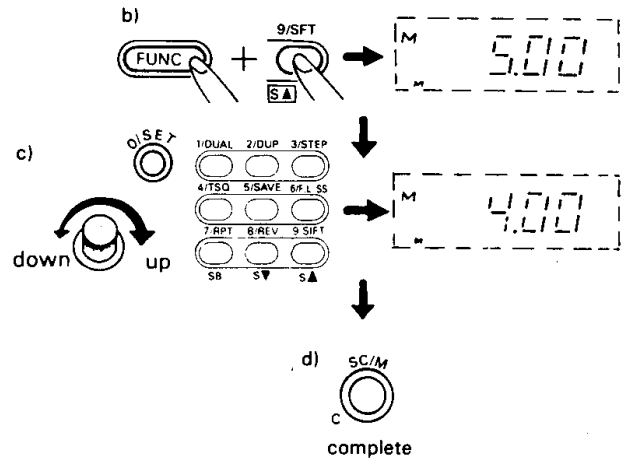

25 Lithium Battery

The information stored in your Transceiver's memory is retained even after you turn its power off. A lithium type battery is used to provide back-up power for its microprocessor. Under normal use, this battery should last for approximately 5 years.

Information

- When the battery voltage drops below a certain level the displayed frequency may no longer be correct. At that time, replace the lithium battery promptly.
- When the lithium battery is replaced, turn the power switch on while pressing the Function button.

NOTE:

Use a special lithium battery for this unit only. Do not attempt to replace this battery yourself. Consult your dealer or our authorized agency when replacement and checking are required. Do not dispose a battery in fire.

TROUBLESHOOTING

Q: The frequency display is weak.

A: The battery voltages are low. Replace the batteries.

Q: The Transceiver returns to the initial condition every time the power switch is turned on and off.

A: Memory addresses are no longer able to retain their information due to a weakened lithium battery. Replace the lithium battery.

Q: The unit does not receive.

A: Press the squelch button and see if any sound comes out of the speaker.

A: Isn't the squelch control rotated fully clockwise?
Rotate back the squelch control counterclockwise for the threshold setting.

A: Isn't your Transceiver set for tone squelch operation? (when CTS145 is installed.)
Release the tone squelch operation.

A: Isn't the volume control rotated fully counterclockwise?
Rotate back the volume control for comfortable listening level.

A: Isn't your Transceiver set for paging or code squelch operation? (when DTF145 is installed.)
Release the paging or code squelch operation.

Q: The Transceiver appears to receive only the strong signals.

A: Is your antenna installed properly?
Check it and install it properly

A: Isn't the squelch control rotated fully clockwise?
Rotate back the squelch control for the threshold setting.

Q: The Transceiver does not transmit.

A: Doesn't the RF output indicator light dark when pressing the PTT button?
Replace batteries.

A: Isn't "P.L." indicated on the display?
Press the B/PO/PL button while pressing the function button to release the PTT. Lock function.

Q: The Transceiver does not transmit at the displayed frequency.

A: Isn't "DUP" indicated on the display?
Press the 2/DUP button while pressing the Function button in the memory mode to release duplex function.

Q: The displayed frequency cannot be changed.

A: Isn't "F.L." indicated on the display?
Press the 6/F.L/SS button while pressing the Function button to release the Frequency Lock function.

Q: No beep sound is generated.

A: Isn't the buzzer disabled?
Press the 0/SET button while pressing the Function button and then press the 0/SET button to enable the buzzer.

SPECIFICATION

GENERAL

Frequency range..... VHF:144.000-145.995MHz (K-150)
 UHF:430.000-439.995MHz (K-450)

Mode.....F3

Microphone Impedance.....600 Ω

Speaker Impedance.....8 Ω

Operation Voltage Range.....5.0-16.0V

Rated Voltage.....7.2V

Current drain.....TX
 13.8V HI APPROX. 950mA (VHF);1300mA UHF):5.0W
 MID APPROX. 650mA (VHF); 950mA (UHF):2.5W
 7.2V HI APPROX. 6540mA (VHF); 900mA (UHF):2.0W
 MID APPROX. 650mA (VHF); 900mA (UHF):2.0W
 13.8V/7.2V LOW APPROX. 350mA (VHF); 480mA (UHF):0.35W
 Standby APPROX. 35mA (VHF); 38mA (UHF)
 Save APPROX. 13mA (VHF); 14mA (UHF)
 A.P.O. APPROX. 5mA (VHF); 5mA (UHF)

Dimensions.....124(H) X 55(W) X 31(D)mm
 (Include Battery case)

Weight.....300g (Include Battery, ANT)

TRANSMITTER

Output power.....13.8V HI APPROX. 5.0W
 MID APPROX. 2.5W
 LOW APPROX. 0.35W
 7.2V HI APPROX. 2.0W
 MID APPROX. 2.0W
 LOW APPROX. 0.35W

Modulation.....Reactance modulation

Maximum frequency deviation.....± 5KHz

Spurious.....Less than -60dB

RECEIVER

Circuitry.....Double conversion superheterodyne

Intermediate frequency.....1st IF 21.80MHz(VHF) 2nd 455KHz
 1st IF 23.05MHz(UHF) 2nd 455KHz

Sensitivity (12dB SINAD).....Less than -117dBm

S/N (at 1.0uV).....More than 30dB

Squelch Sensitivity.....-14dB

Output (10% distortion).....250mW across 8 Ω loads

Notes:

1.Circuit and ratings are subject to change without notice due to advancements in technology.