

SR

**STANDARD.**

---

**C558**

**TWIN-BAND HANDY FM TRANSCEIVER**

---

**INSTRUCTION MANUAL**

**STANDARD COMMUNICATIONS  
A DIVISION OF MARANTZ JAPAN, INC.**

Copyright © 1992  
All Rights Reserved  
Printed in Japan

# Introduction

---

Thank you for purchasing the Standard C558 144/430 MHz twin-band handy FM transceiver. This product was manufactured and shipped under the strictest component control and inspection procedures to ensure top quality. If, however, any malfunction should occur, please contact your dealer immediately.

- Please read this instruction manual through completely before using the unit to allow you to make the most of its many features. Store it in a safe place for future reference.
- The instructions in this manual mainly describe operations using the UHF band.

# Contents

<b>Packing Diagram</b> .....	5	Top View .....	19
<b>Accessories</b> .....	6	Side View, Front View [Keyboard] .....	20
<b>Before Using the Unit</b> .....	7	Display .....	24
<b>Preparations for Use (Setup)</b> .....	8	<b>Repeater Operation</b> .....	<b>25</b>
1 Attaching the Antenna .....	8	1 About Repeater Operation .....	25
2 Battery Insertion .....	8	1 Repeater Operation .....	26
3 About Rechargeable Batteries .....	8	2 Reversing the Repeater Mode Send/Receive Frequencies .....	26
4 Switching Power On .....	9	3 Tone Frequency (CTCSS) Setting (Set Mode Status) .....	27
5 Adjusting the Volume .....	9	4 Offset Frequency Setting (Set Mode Status) .....	28
6 Squelch (SQL) Adjustment .....	9	5 Using the LAMP Key for REV Operation (Set Mode Status) .....	28
7 Using the Supplied DC Adaptor .....	10	6 Transmitting a Tone Burst (1750 Hz) .....	29
8 Selecting the Operating Band (Mono-band Operation) .....	11	<b>Paging Operation</b> .....	<b>29</b>
9 Setting the Frequency .....	12	1 Preparations for Paging Operation .....	30
10 Transmitting .....	13	1 Setting Your Personal Code .....	31
11 Beep Indications .....	14	2 Setting Personal Codes for Stations C1 – C8 .....	32
<b>Overview of Terminology and Basic Key Functions</b> .....	<b>15</b>	3 Designating Group Codes for Receiving .....	33
1 Getting to Know the Functions of the C558 .....	15	2 Paging Mode Operation .....	34
Description of Operating Modes .....	15	3 Communication when Codes Match .....	36
1 VFO Mode		<b>Code Squelch Operation</b> .....	<b>37</b>
2 Call Mode		<b>Tone Squelch Operation</b> .....	<b>38</b>
3 Memory Mode		<b>Memory Operation</b> .....	<b>39</b>
4 Paging Mode		1 About the Memory Function .....	39
5 Dual Watch Mode		2 About the CMU160 Memory Unit .....	40
6 Set Mode		1 Memory Unit Protection Function .....	40
2 Basic Key Functions .....	16	2 Memory Unit Compatibility .....	40
1 Functions Accessed by Pushing Keys Directly .....	16	3 Storing Frequencies in Memory .....	41
2 Functions Accessed by Holding Down the FUNC Key and Pressing Another Key .....	16	4 Storing Tone Frequencies, Etc. in Memory .....	42
3 Functions Accessed from the Set Mode .....	17	5 Recalling Frequencies from Memory .....	42
<b>Names and Functions of Parts</b> .....	<b>19</b>		

5.1 Using the Numeric Keys .....	43	1 Types of Dual Watch Operation .....	56
5.2 Using the Rotary Channel Selector .....	44	2 Dual Watch Operation Instructions .....	57
5.3 Using the ▲ and ▼ Keys .....	44	1 Using the Address Number M00 Frequency and the VFO Frequency .....	57
6 Changing Frequencies Stored in Memory .....	44	2 Using an Address Number Frequency of Your Choice and the VFO Frequency .....	58
7 Deleting Frequencies from Memory .....	45	3 Using the Call Frequency and the VFO Frequency ...	58
8 Memory Unit All Reset Function .....	45	4 Using the Memory Scan Frequency and the VFO Frequency .....	58
9 Changing Frequencies from the Memory Mode (Memory Shift Mode) .....	46	3 Communicating with Other Stations when in the Dual Watch Mode .....	59
10 Protection Function for Data Assigned to Memory Address Numbers (Protect Mode) .....	46	4 Cancelling Dual Watch Mode .....	59
11 Instant Initialization Function .....	47	<b>DTMF Operation .....</b>	<b>60</b>
<b>Scan Operation .....</b>	<b>48</b>	1 DTMF Memory Function .....	60
1 About Scan Operation .....	48	2 Storing DTMF Codes in Memory .....	60
2 Types of Scan Functions .....	49	3 Deleting DTMF Codes from Memory .....	61
1 VFO Scan .....	49	4 DTMF Memory Transmission (Set Mode Status) .....	62
2 Memory Scan .....	49	<b>Other Functions (1) (Functions Accessed by Holding Down the FUNC Key and Pressing Another Key) .....</b>	<b>63</b>
3 Tone Frequency Scan .....	49	1 Output Level Switching .....	63
3 Scan Operation Instructions .....	49	2 Frequency Lock Operation .....	63
1 VFO Scan .....	49	3 Continuous Illumination Function .....	64
2 Cancelling Scan Operation .....	51	4 Disabling Transmission when the PTT Switch is Pressed .....	64
3 Other VFO Scan Operations .....	51	<b>Other Functions (2) (Functions Accessed from the Set Mode) .....</b>	<b>65</b>
4 Memory Scan .....	51	1 Changing the Tuning Steps .....	66
4.1 Block Memory Scan .....	51	2 Switching Between Internal and External Speakers .....	66
4.2 Memory Scan Memory .....	52	3 Battery Save Function .....	67
5 Cancelling Memory Scan .....	52	4 Reception Attenuator (Sensitivity) On/Off Function .....	68
6 Tone Frequency Scan (Set Mode Status) .....	53	5 Dual Watch Speed Selection Function .....	69
<b>Call Function .....</b>	<b>54</b>		
1 Using the CALL Key .....	54		
2 Changing the Call Frequency .....	54		
1 Changing the Frequency from the Call Mode .....	55		
<b>Dual Watch Function .....</b>	<b>56</b>		



6	Setting the ▲ and ▼ Keys to 10 MHz Tuning Steps .....	69
7	1 kHz Column Input Function .....	70
8	Auto Power Off Function .....	70
9	Memory Unit All Reset On/Off Function .....	71
10	DTMF Transmission Speed Selection .....	71
11	Repeater and Paging Transmission Delay Time Selection .....	72
12	Suppressing Audio Output when Paging Codes Match .....	72
13	Selecting the Number of Beeps During Paging Operation .....	73
14	Turning the Beep On and Off .....	73
15	Turning Off Sub Band Audio Output During Reception .....	74
16	Reducing Squelch Pop Noise .....	74
17	Enabling the Rotary Channel Selector in the Frequency Lock Mode .....	75
18	Setting Tuning Steps for the Rotary Channel Selector when the FUNC Key is Held Down .....	75
19	Clone Mode .....	76
20	Remote Mode .....	76
21	Decode Mode .....	77
22	Setting the Delay Time for Cross-band Repeater Transmission .....	77
23	Cross-band Repeater .....	78
24	AM Mode Function .....	78
	<b>Troubleshooting .....</b>	<b>79</b>
	<b>Specifications .....</b>	<b>81</b>
	<b>Mounting the Optional CTN160 .....</b>	<b>82</b>
	<b>Mounting the Optional CMU160/CMU161 .....</b>	<b>86</b>

# Packing Diagram

■ List of items included in package  
Please check to make sure that all items listed are included.

- Transceiver body ..... 1
- ① Included helical antenna ..... 1
- ② DC adapter ..... 1
- ③ Instruction manual ..... 1
- ④ Block diagram ..... 1

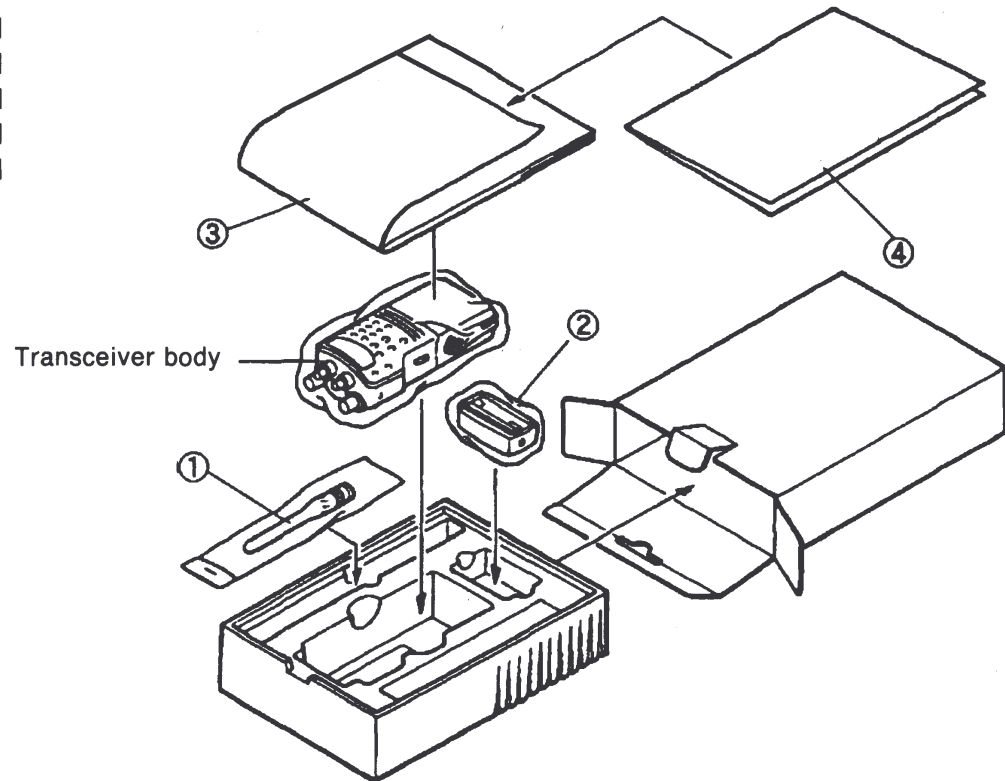

# Accessories (Optional)

- A wide range of accessories is available to enable you to make the most of the C558.

Before using any of the accessories listed, please read the instruction manual that came with it carefully.

- Microphones

- CMP111 ..... Microphone-speaker combination
- CMP113 ..... Tiepin microphone
- CMP115 ..... Compact microphone-speaker combination

- Headsets

- CHP111 ..... Headset with PTT switch
- CHP150 ..... Headset with VOX function

- AC Chargers

- CSA181E ..... Desktop charger (quick charger)  
(compatible with all CNB150 series models)
- CWC150K ..... Wall charger (for the CNB150/151GY/153)
- CWC151K ..... Wall charger (for the CNB152)

- DC charger

- CMC150 ..... Mobile charger (for the CNB150/151GY/153)

- Battery tray

- CBT151GY ..... Holds 6 size AA batteries

- Soft cases

- CLC550 ..... For transceiver with CNB151GY/CBT151GY mounted
- CLC551 ..... For transceiver with CNB152/CNB153 mounted
- CLC555GN ..... For transceiver with CNB151GY/CBT151GY mounted
- CLC555OR ..... For transceiver with CNB151GY/CBT151GY mounted

- Rechargeable battery packs

- CNB150 ..... (7.2 V, 400 mAh)
- CNB151GY ..... Standard (7.2 V, 700 mAh)
- CNB152 ..... High-power (12.0 V, 600 mAh)
- CNB153 ..... Long-life (7.2 V, 1,000 mAh)

- Tone squelch/memory units

- CTN160 ..... CTCSS (tone squelch) unit
- CMU160 ..... Memory unit (20 VHF, 20 UHF channel memory)
- CMU161 .. Memory unit (100 VHF, 100 UHF channel memory)

- Bracket

- CMB111 ..... Mobile bracket

- Power cable

- CAW150 ..... For mobile use
- CAW151 ..... For base station use

※ To operate the transceiver as a base station using a stabilized power supply, the CAW151 base station power cable is required.

# Before Using the Unit (Observe the Following Precautions)

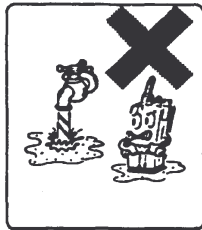

Avoid wet or humid places.

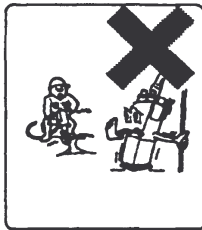

Avoid exposing the unit to excessive vibrations.

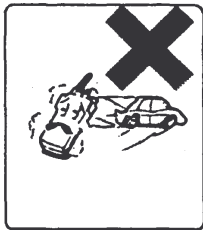

Avoid very dusty places.

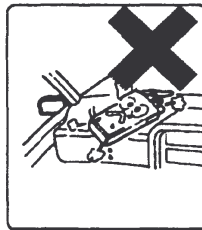

Avoid hot places and locations exposed to direct sunlight.

## ★ Do not disassemble the unit.

- Never attempt to take the unit apart.
- Never touch the unit's cores or trimmers. They are already adjusted for optimum performance.

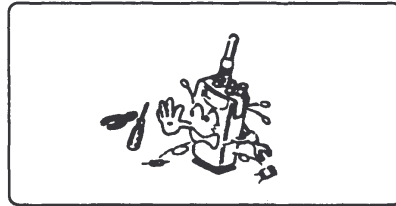

## ★ The unit will not operate on a 24 V power supply.

- The unit's operating voltage range is 6.0 – 16.0 V. Never connect the unit to an external power supply outside of this range. Doing so could cause permanent damage to the unit.

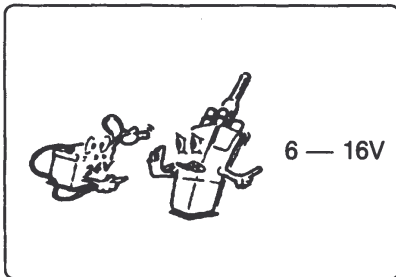

## ★ Do not operate the transceiver without the antenna attached.

- Doing so could cause permanent damage to the unit.
- Be sure the included antenna is attached before operating the unit.

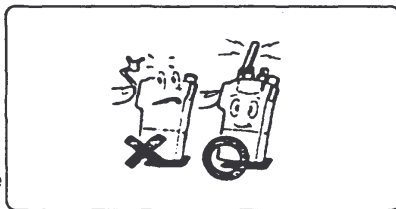

## ★ Batteries

- Make sure the (+) and (–) ends of the batteries are oriented correctly.

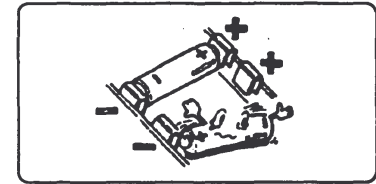

- Never use new and old batteries together.

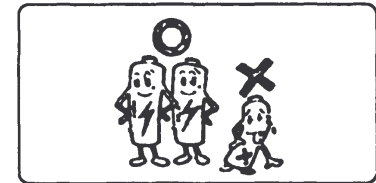

- Never expose old batteries to an open flame.



## ★ Suitable batteries

- Size AA manganese batteries
- Alkaline batteries
- Do not use size AA nickel-cadmium batteries.

## ★ Fully charge rechargeable batteries before using them.

- Be sure to fully charge rechargeable batteries before using them.
- Use a battery charger designed for the type of rechargeable batteries you are using.

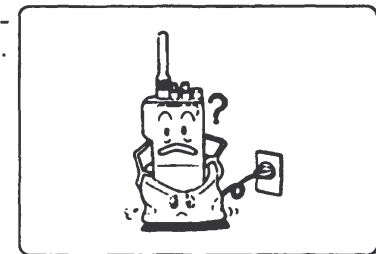



# Preparations for Use (Setup)

### 1 Attaching the Antenna

- Attach the included antenna to the antenna terminal.

Included (helical) antenna  
Antenna connecting terminal (BNC)

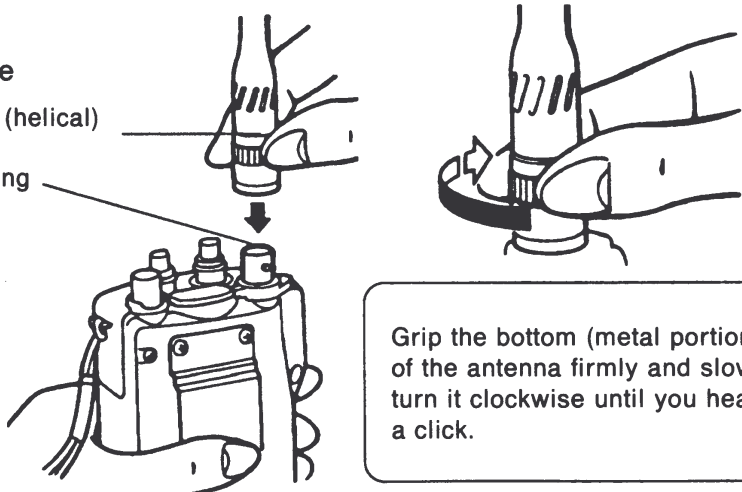

Align the groove in the bottom of the antenna (the part that attaches to the body) with the pin protruding from the antenna terminal (the place where the antenna attaches to the body).

Grip the bottom (metal portion) of the antenna firmly and slowly turn it clockwise until you hear a click.

### 2 Battery Insertion

- Turn power off.
- Open battery case.
- Insert batteries in case.
- Mount battery case on transceiver. Push until it clicks in place.

Release button  
Battery case  
Body

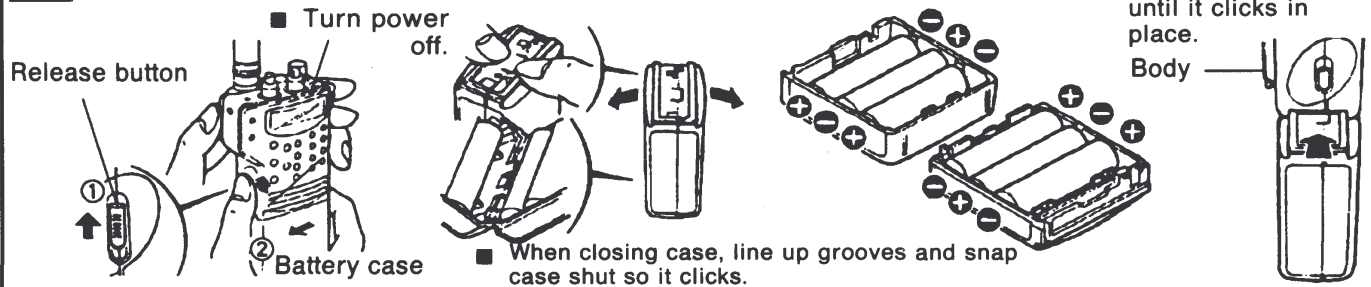

When closing case, line up grooves and snap case shut so it clicks.

Insert six size AA batteries into the battery case you have just removed from the body. Make sure they are oriented correctly.

**NOTE** Make sure the unit's power is turned off.

### 3 About Rechargeable Batteries

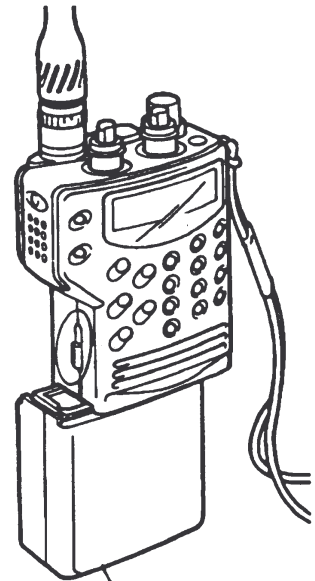

To use a rechargeable battery pack, first charge it using a charger designed for it and then attach it to the body of the unit.

#### 4 Switching Power On

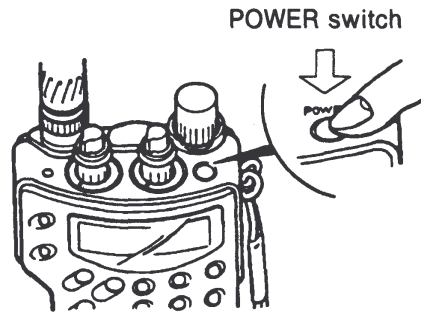

Push the POWER switch lightly to turn power on. Press the switch a second time to turn power off.

#### NOTE

In order to protect the contents of the memory, the power will not turn on when the power switch is pressed if battery power level has dropped to approximately 3.8 V or below.

#### 5 Adjusting the Volume

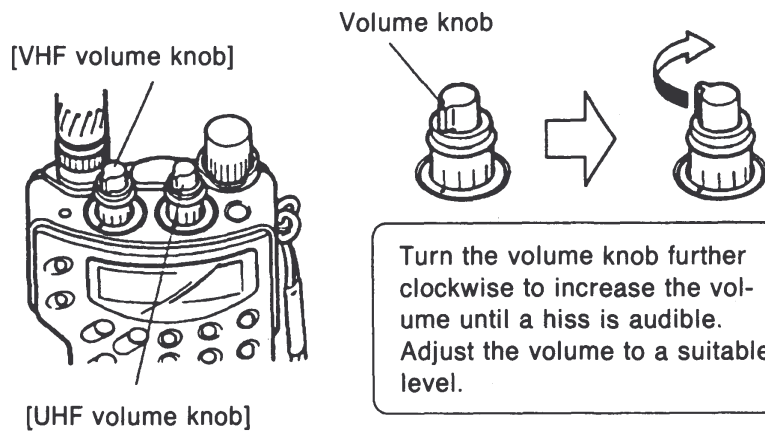

Turn the volume knob further clockwise to increase the volume until a hiss is audible. Adjust the volume to a suitable level.

#### 6 Squelch (SQL) Adjustment

■ How to eliminate background hiss

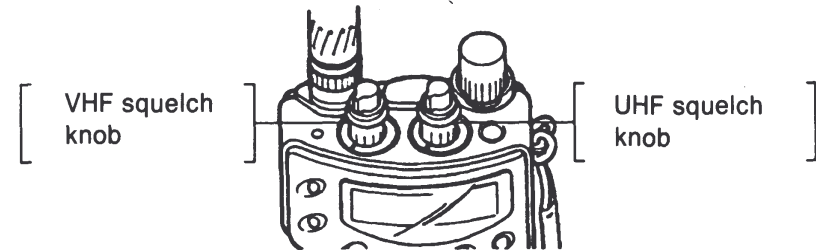

Turn the squelch knob clockwise until the background hiss is no longer audible and stop at that point.

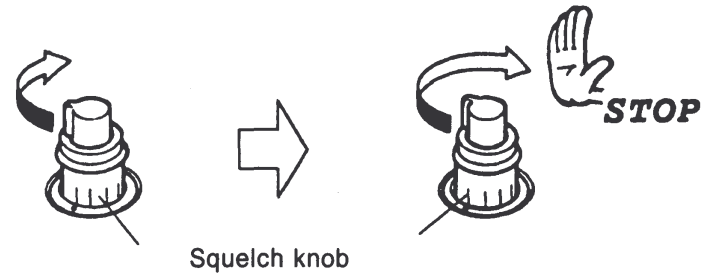

Stop turning the knob as soon as the background hiss is inaudible.

#### NOTE

It may be difficult to receive weak signals if the squelch knob is turned too far clockwise.

## 7 Using the Supplied DC Adaptor

- The C558 comes with a DC adaptor.  
To run the unit off of an external power supply, mount the supplied DC adaptor in place of the battery case.

① Remove the battery case from the unit and mount the supplied DC adaptor in its place.

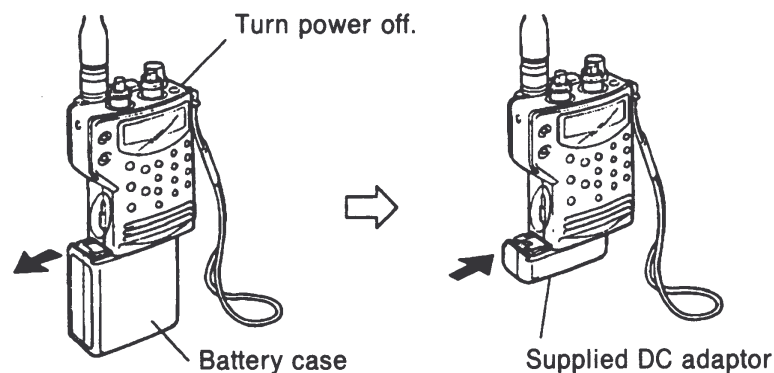

② Plug the supplied DC adaptor into the jack in the optional CAW150 or CAW151.

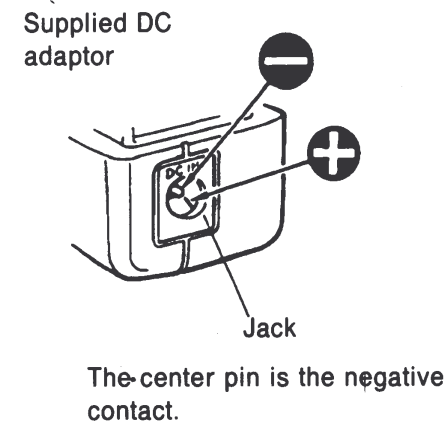
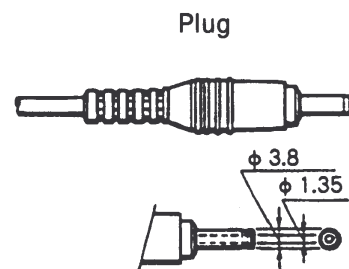
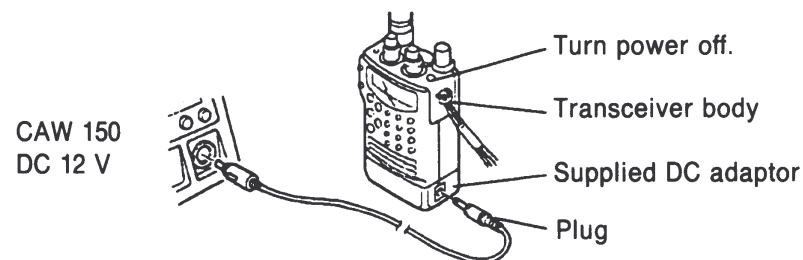

### NOTE

- (1) Make sure the power is switched off before plugging in or unplugging the connecting cord.
- (2) The unit's operating voltage range is DC 6.0 – DC 16 V. Never connect it to an external power supply outside of this range.
- (3) Make sure the power is switched off before attaching or removing the DC adaptor.

### NOTE

The supplied DC adaptor is equipped with a special jack. Do not attempt to plug it into a power supply other than the CAW150 or CAW151.

## 8 Selecting the Operating Band (Mono-band Operation)

- The C558 is equipped with independent VHF and UHF bands, so transmissions can be received on both bands simultaneously. Most of the transceiver's functions operate independently for the VHF and UHF bands.
- When the PTT switch is pressed (transmit status), transmission takes place on the band designated by the MAIN indication on the display.
- Some of the keys are valid for the band designated by the MAIN indication on the display (the main band), and the operation of some keys is unrelated to the MAIN indication.

### 1 Switching bands (switching between the VHF and UHF bands)

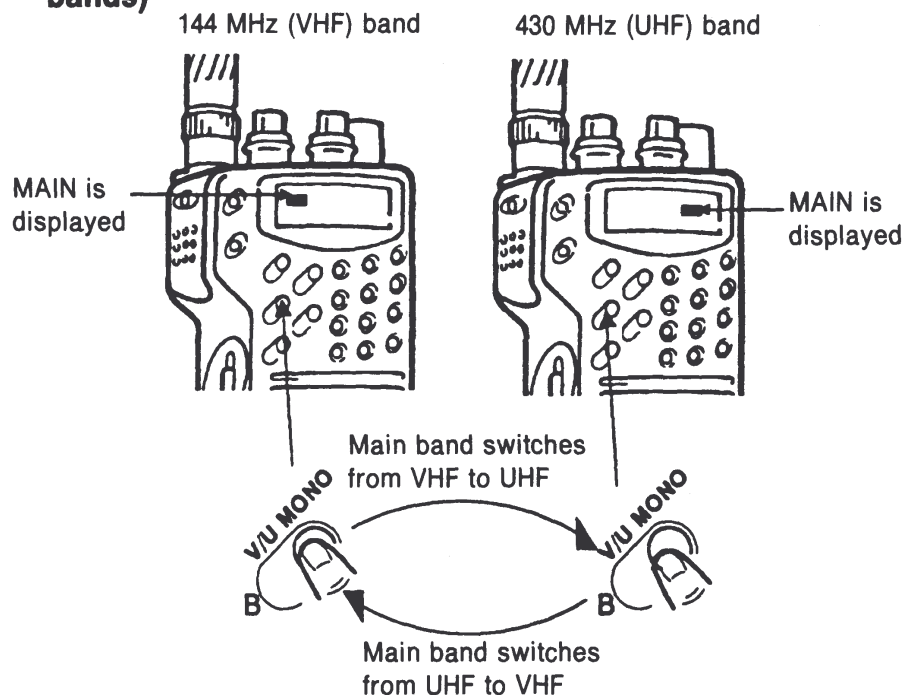

### Terminology

- VHF stands for Very High Frequency. This band is sometimes also referred to as the 144 MHz band or the 2-meter band.
- UHF stands for Ultra High Frequency. This band is sometimes also referred to as the 430 MHz band or the 70-centimeter band.

### 2 Mono-band operation (using only one band)

- The UHF band display disappears when VHF is the main band.

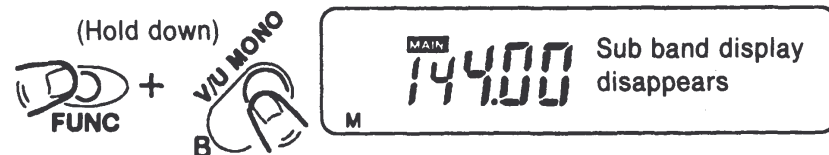

- The VHF band display disappears when UHF is the main band.

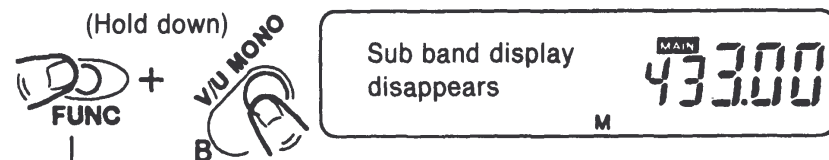

- To display indications for both bands, press the B V/U MONO key.

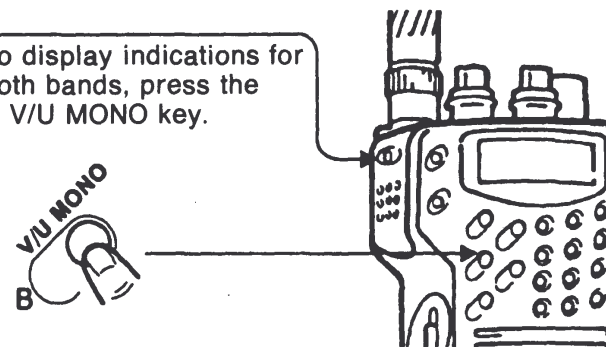

# 9

## Setting the Frequency

- There are three ways to set the frequency.

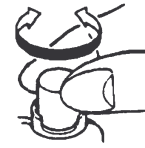
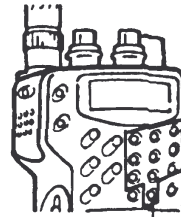

1

Setting the frequency using the numeric keys

**Example** Setting the frequency to 145.68 MHz

**Procedure**

(1) Press the 5 key to input the 1 MHz column.



(2) Press the 6 key to input the 100 kHz column.



(3) Press the 8 key to input the 10 kHz column.



When setting is complete, a long high pitched beep (peep) sounds.

**ADVICE**

The transceiver continues to operate at the old frequency setting while the new one is being input.

2

Setting the frequency using the rotary channel selector

Turning the rotary channel selector causes the frequency to rise or fall in tuning steps of the pre-set size. See page 66 for an explanation of tuning steps.

Frequency rises

Frequency falls



**ADVICE**

Turning the rotary channel selector with the FUNC key held down causes the frequency to rise or fall in 100 kHz tuning steps.

3

Setting the frequency using the ▲ and ▼ keys

Press the ▲ key to raise the frequency setting and the ▼ key to lower it. The amount the frequency setting changes with each press depends on the tuning step setting.

Frequency rises

Frequency falls



**ADVICE**

Holding down the ▲ or ▼ key for more than 0.5 seconds causes the frequency setting to change rapidly in the direction indicated.

## 10 Transmitting

- After setting the frequency and making sure that no other stations are broadcasting on it, press the PTT switch to transmit.

A red indicator lights during transmission

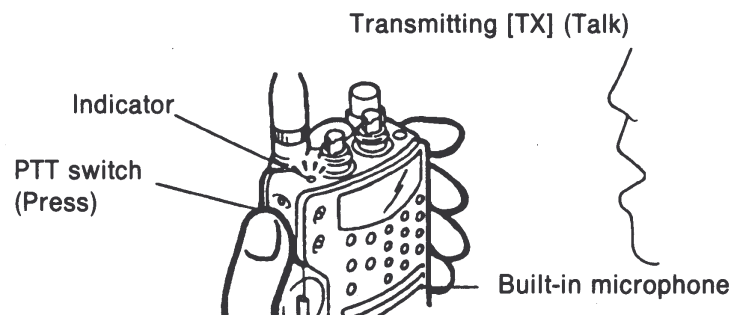

Hold down the PTT switch and speak into the microphone.

Green indicator lights during receive status

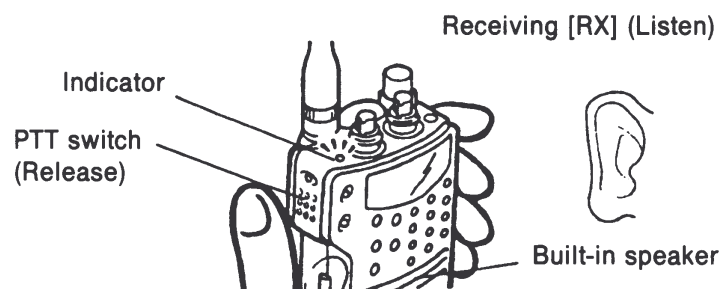

The transceiver automatically switches to the receive mode when the PTT switch is released.

- A wide range of accessories is available to enable you to enjoy the C558 in many different ways.

[Station A]



[Station B]



[Station C]



[Station D]



## 11 Beep Indications

- When you press the control keys on the unit, beep indications let you know if the key input has registered correctly.
- Depending on the operation, the pitch and duration of the beeps differ as described below.

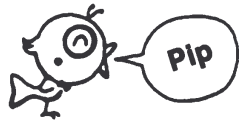

(Short high pitched beep)

- Operation button pressed registered correctly.



(Long high pitched beep)

- Operation successfully completed.  
(Example: Frequency successfully entered in memory.)



(Short low pitched beep)

- Operation button pressed not registered correctly or invalid button pressed.

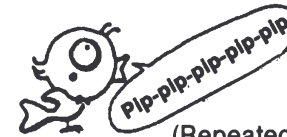

(Repeated high pitched beeps)

- Indicates auto power off operation or a transmission received in the paging mode.

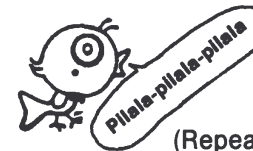

(Repeated high pitched warbles)

- Indicates paging mode transmission.



(Short medium pitched beep)

- Function canceled or initial settings restored.

# Overview of Terminology and Basic Key Functions

## 1 Getting to Know the Functions of the C558

### Description of Operating Modes

#### 1 VFO Mode

In the VFO mode the frequency setting is displayed and the M, C and **D** indications are not displayed. The VFO mode is active when the unit is first turned on (the factory setting).

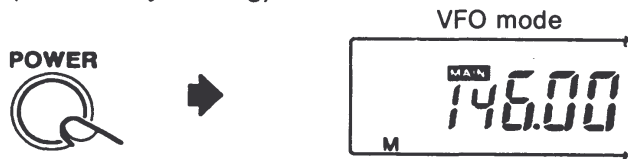

#### 2 Call Mode

In the call mode the C indication is displayed. (See page 54.)



#### 3 Memory Mode

In the memory mode the frequency setting and the memory address number are displayed. In the VFO mode, press the D V/M ENT key to switch to the memory mode. (See page 39.)

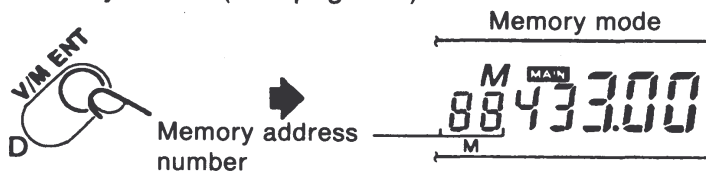

#### 4 Paging Mode

In the paging mode the **P** PAG indication is displayed. (See page 30.)



#### 5 Dual Watch Mode

In the dual watch mode the **D** indication is displayed. (See page 56.)



#### 6 Set Mode

In the set mode the number of one of the 28 (22 for C558S) possible commands is displayed. (See page 17.)





## 2 Basic Key Functions

### 1 Functions Accessed by Pushing Keys Directly

- The following functions are accessed by pushing keys (once) directly.

#### Example

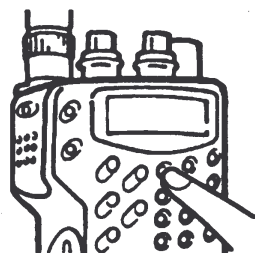

Key	Function	See page
0 — 9	Numeric input	21
CALL	Selects call frequency	54
V/U	Switch main band	11
SQL OFF	Squelch on/off	9, 20
MS	Memory scan on	51
V/M	VFO/memory mode toggle	23
LAMP	Display illumination on/off	20
POWER	Power on/off	19
CL	Cancel mode	22
▼	Frequency or memory address number down	23
	In set mode, menu select	23
▲	Frequency or memory address number up	23
	In set mode, menu select	23

### 2 Functions Accessed by Holding Down the FUNC Key and Pressing Another Key

#### Example



(See pages 21 and 57 for details.)

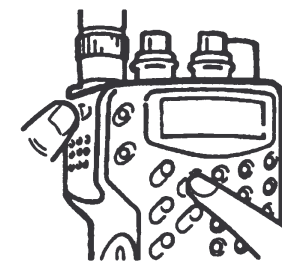

Key	Function	See page
F + SET	Call up set mode	17
F + PO	Switch transmission output level	63
F + DUAL	Dual watch mode on/off	57
F + SFT	Memory shift mode on/off	46
F + DTMF.M	DTMF memory mode on/off	60
F + PRO	Protect mode on/off	46
F + FL	Frequency lock on/off	63
F + TSQ	Tone squelch mode on/off	38
F + RPT	Repeater mode on/off	26
F + REV	Invert transmit and receive frequencies in repeater mode	26
F + PS	Scan operation on/off	49
F + MONO	Mono band on/off	11
F + MS.M	Memory scan memory on/off	52
	Decode mark on/off in code mode	33
F + ENT	Store in memory	41
F + CODE	Code setting mode for paging and code squelch	31
F + PAG	Paging (code squelch) mode on/off	34
F + LAMP	Display illumination lock	64
F + SQL OFF	Sub band squelch off	20
F + P.L	PTT switch lock	64
F + POWER	All reset function in "rES on" status	71

### 3 Functions Accessed from the Set Mode

- The set mode is used to make settings and select values for 29 different commands, including tuning step setting.

#### Procedure To activate set mode status

- 1) Press the B V/U MONO key to make the band you wish to make (change) settings for the main band.
- 2) Hold down the FUNC key and press the 0 SET key.

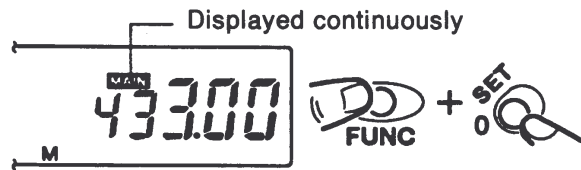

- 3) Use the ▲ and ▼ keys to select the menu for the setting you wish to make (change).  
Holding down the ▲ or ▼ key for more than 0.5 seconds causes the menu display to change rapidly.

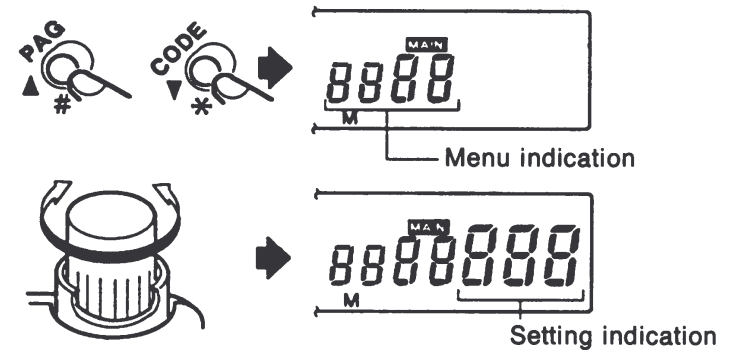

	Indication		Function	See page
	Menu indication	Initial setting		
St	St	5	Tuning step selection	66
SP	SP	11	Internal/external speaker switching	66
OF	OF	500	Offset frequency setting	28
CF	CF	1000	Tone frequency (CTCSS) setting	27
It	It	1000	The menu indication appears but this setting function does not operate on this unit.	
SA	SA	OFF	Battery save function on/off and intermittent reception selection	67
Att	Att	OFF	Reception attenuator (sensitivity) on/off	68
dUSP	dUSP	nor	Dual watch speed selection	69
Ud10	Ud10	nor	▲ key and ▼ key switching (Tuning step switching)	69
inP1	inP1	OFF	1 kHz column input enable/disable	70
APO	APO	OFF	Auto power off function on/off	70
rES	rES	OFF	Memory unit all reset enable/disable	71
dtMF	dtMF	nb	DTMF memory transmission on/off	62
dtSP	dtSP	nor	DTMF transmission speed switching	71
PA-	PA-	OFF	Audio output disable/enable when paging code matches	72
PAt	PAt	450	Repeater and paging transmission delay time (450/750 msec)	72
PAbZ	PAbZ	5	Switch number of beeps between 5 and 1 during paging operation	73
bZ	bZ	on	Audible beep on/off	73
MUTE	MUTE	OFF	Sub band audio output enable/disable during transmission	74

Moni	Moni	OFF	Squelch pop noise reduction function on/off	74
LMPr	LMPr	OFF	Switch LAMP key function to REV on/off	28
FLCH	FLCH	OFF	Enable rotary channel selector in frequency lock status on/off	75
CHI	CHI	OFF	Select tuning steps for FUNC key + rotary channel selector	75
CLN	CLN	OFF	Clone mode on/off	76
rMt	rMt	OFF	Remote mode on/off	76
dEC	dEC	OFF	Decode mode on/off	77
rPtt	rPtt	OFF	Cross-band repeater selection	77
rPt	rPt	OFF	Cross-band repeater on/off	78
AM	AM	OFF	AM reception mode on/off	78

# Names and Functions of Parts

## Top View

- 
- **MIC (external microphone jack)**  
 Jack for connecting an optional microphone-speaker combination (CMP111 or CMP115), headset with PTT switch (CHP111) or headset with VOX capability (CHP150).
  - **Waterproof cap**  
 Protects the MIC and SPK jacks from moisture.  
**NOTE**  
 If the MIC and SPK jacks are not being used, attach this cap to protect them.
  - **TX/BUSY Indicator**  
 This indicator lights red when the PTT switch is depressed.  
 It lights green when the SQL OFF button is pressed, when the SQL knob is turned all the way counterclockwise or when a signal is being received.
  - **SQL (squelch knob)**  
**NOTE**  
 (1) Adjust this knob to eliminate audible hiss during scan, dual watch, battery save, paging or code squelch operation.  
 (2) Tune to an unused channel before adjusting the squelch setting.
  - **VOLUME (volume knob)**  
 Turn this knob to adjust the speaker volume. Always turn squelch off by holding down the SQL OFF key or turning the SQL knob all the way counterclockwise before adjusting the volume.
  - **SPK (external speaker jack)**  
 Jack for connecting an optional microphone-speaker combination (CMP111 or CMP115), headset with PTT switch (CHP111) or headset with VOX function (CHP150).  
 This jack allows connection of an external speaker or earphone with a load impedance of 8 ohms. You can switch the band which uses the external speaker for audio output. (See page 66.)
  - **CHANNEL (rotary channel selector knob)**  
 This knob is used to change the transmit/receive frequency. It is also used to change the tone frequency, tuning step size and memory address number.  
 Turn clockwise to increase, and counterclockwise to reduce, the frequency setting.  
 The initial tuning step setting is 5 kHz.  
 The tuning step setting can be changed if desired to 10, 12.5, 20, 25, 50 or 100 kHz, for a total of seven settings.
  - **POWER (power switch)**  
 Press once to turn power on. Press again to turn power off.  
**NOTE**  
 In order to protect the contents of the memory, the power will not turn on when the power switch is pressed if battery power level has dropped to approximately 3.8 V or below.

## Side View

### ■ FUNC (function)

A variety of special functions can be accessed by holding down this key and pressing another key.

### ■ PTT (push to talk) switch

Switches between transmitting and receiving.

### ■ Belt clip

### ■ RELEASE button

Press to release the battery pack.

### ■ LAMP

This key controls display illumination.

(1) If keys are pressed while the lamp is lit, it remains lit until after the last key press.

(2) If this button is pressed while the FUNC key is held down, the lamp is locked in on status. Press LAMP a second time to turn the lamp off.

### ■ SQL OFF (squench off)

Squelch is disabled for as long as this button is held down, regardless of the setting of the squelch knob. It has the same effect as turning the squelch knob all the way counterclockwise.

Pressing this key during transmission or while the FUNC key is being held down cancels squelch operation for the sub band (the band with no MAIN indication on the display).

## Front View

[Keyboard]

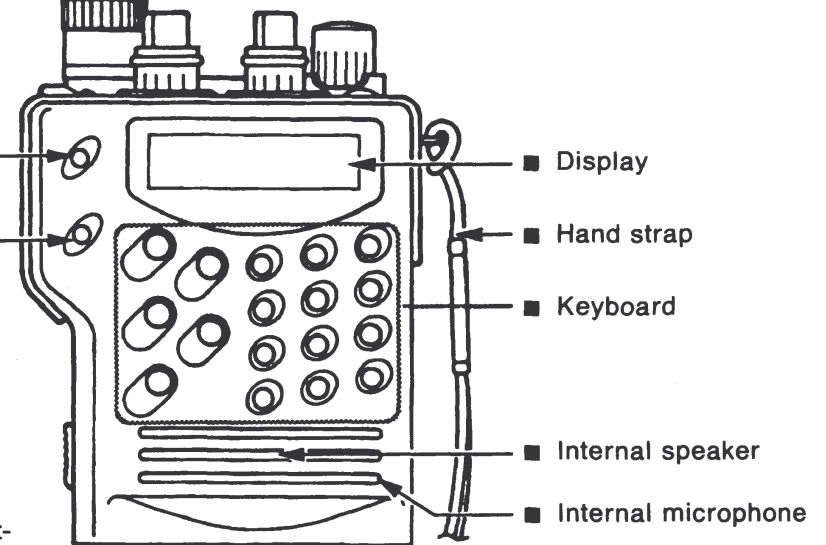
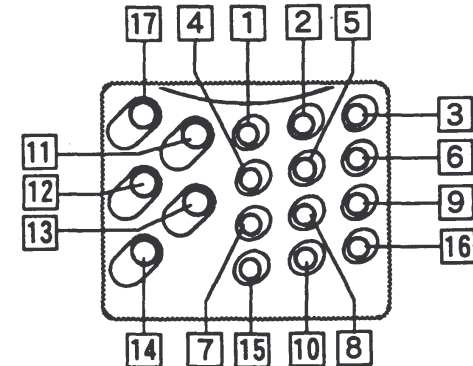

## Notational conventions

■ The functions of each of the keys when operations (1), (2) and (3) are performed are listed below.

- ※ FUNC + means press the key indicated while holding down the FUNC key.
- ※ PTT + means press the key indicated while holding down the PTT switch.

(1) Function when key is pressed directly.



(2) Function when key is pressed with the FUNC key held down.

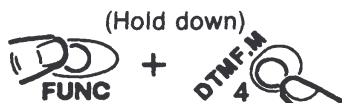

(3) Function when key is pressed with the PTT switch held down.

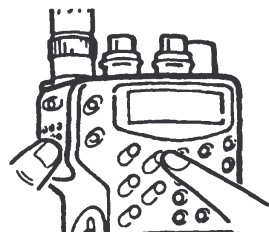
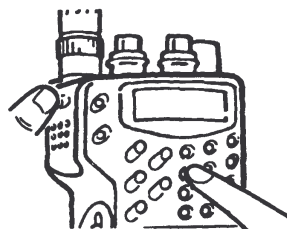
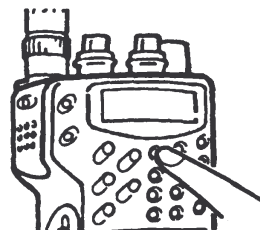
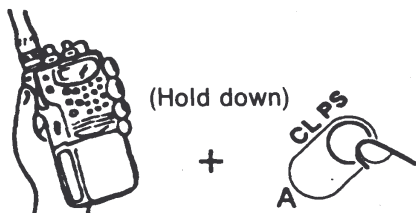

※ In the list which follows, the operations indicated by (1), (2) and (3) are omitted.

※ The numbers printed inside squares correspond to the numbers in the diagram on the previous page showing the names of the keys.

### 1 1 PO

- (1) Inputs the numeral 1.
- (2) Switches the transmission output level.
- (3) Transmits DTMF signal 1/transmits DTMF memory address 1.

### 2 2 DUAL

- (1) Inputs the numeral 2.
- (2) Toggles dual watch mode on/off.
- (3) Transmits DTMF signal 2/transmits DTMF memory address 2.

### 3 3 SFT

- (1) Inputs the numeral 3.
- (2) Toggles memory shift mode on/off.
- (3) Transmits DTMF signal 3/transmits DTMF memory address 3.

### 4 4 DTMF.M

- (1) Inputs the numeral 4.
- (2) Toggles DTMF memory mode on/off.
- (3) Transmits DTMF signal 4/transmits DTMF memory address 4.

---

**5 5 PRO**

- (1) Inputs the numeral 5.
- (2) Toggles memory protect on/off.
- (3) Transmits DTMF signal 5/transmits DTMF memory address 5.

**6 6 FL**

- (1) Inputs the numeral 6.
- (2) Toggles the frequency lock function on/off.
- (3) Transmits DTMF signal 6/transmits DTMF memory address 6.

**7 7 TSQ**

- (1) Inputs the numeral 7.
- (2) Toggles tone squelch mode on/off.
- (3) Transmits DTMF signal 7/transmits DTMF memory address 7.

**8 8 RPT**

- (1) Inputs the numeral 8.
- (2) Toggles repeater mode on/off.
- (3) Transmits DTMF signal 8/transmits DTMF memory address 8.

**9 9 REV**

- (1) Inputs the numeral 9.
- (2) Inverts the transmit and receive frequencies in repeater mode.
- (3) Transmits DTMF signal 9/transmits DTMF memory address 9.

**10 0 SET**

- (1) Inputs the numeral 0.
- (2) Calls up the set mode.
- (3) Transmits DTMF signal 0/transmits DTMF memory address 0.

**11 A CL PS**

- (1) Cancels the various modes.
- (2) Starts and stops scan operation.
- (3) Transmits DTMF signal A.

**12 B V/U MONO**

- (1) Switches the main band.
- (2) Initiates mono-band operation.
- (3) Transmits DTMF signal B.

---

**13 C MS MS.M**

- (1) Starts memory scan operation.
- (2) ● Toggles memory scan memory on/off.
  - Toggles the decode mark on/off in code mode.
- (3) Transmits DTMF signal C.

**14 D V/M ENT**

- (1) Switches between VFO mode and memory mode.
- (2) Inputs data into memory.
- (3) Transmits DTMF signal D.

**15 \* ↓ CODE**

- (1) Decreases the frequency setting.
  - In the memory call mode, it decrements the memory address number.
  - In the code setting mode, it decrements the code address number.
  - During scan operation, it causes scan to pause and to proceed in the downward direction.
  - In the set mode, it is used to select a menu.
- (2) Sets codes for paging and code squelch.
  - Performs settings for the paging and code squelch modes.
  - Calls up codes used by paging and code squelch.
- (3) Transmits DTMF signal \* .

**16 # ▲ PAG**

- (1) Increases the frequency setting.
  - In the memory call mode, it increments the memory address number.
  - In the code setting mode, it increments the code address number.
  - During scan operation, it causes scan to pause and to proceed in the upward direction.
  - In the set mode, it is used to select a menu.
- (2) Toggles paging mode and code squelch mode on/off.
- (3) Transmits DTMF signal #.

**17 CALL P.L**

- (1) Calls up the call frequency.
- (2) Locks the PTT switch.
- (3) Transmits a tone (1,750 Hz).



# Display

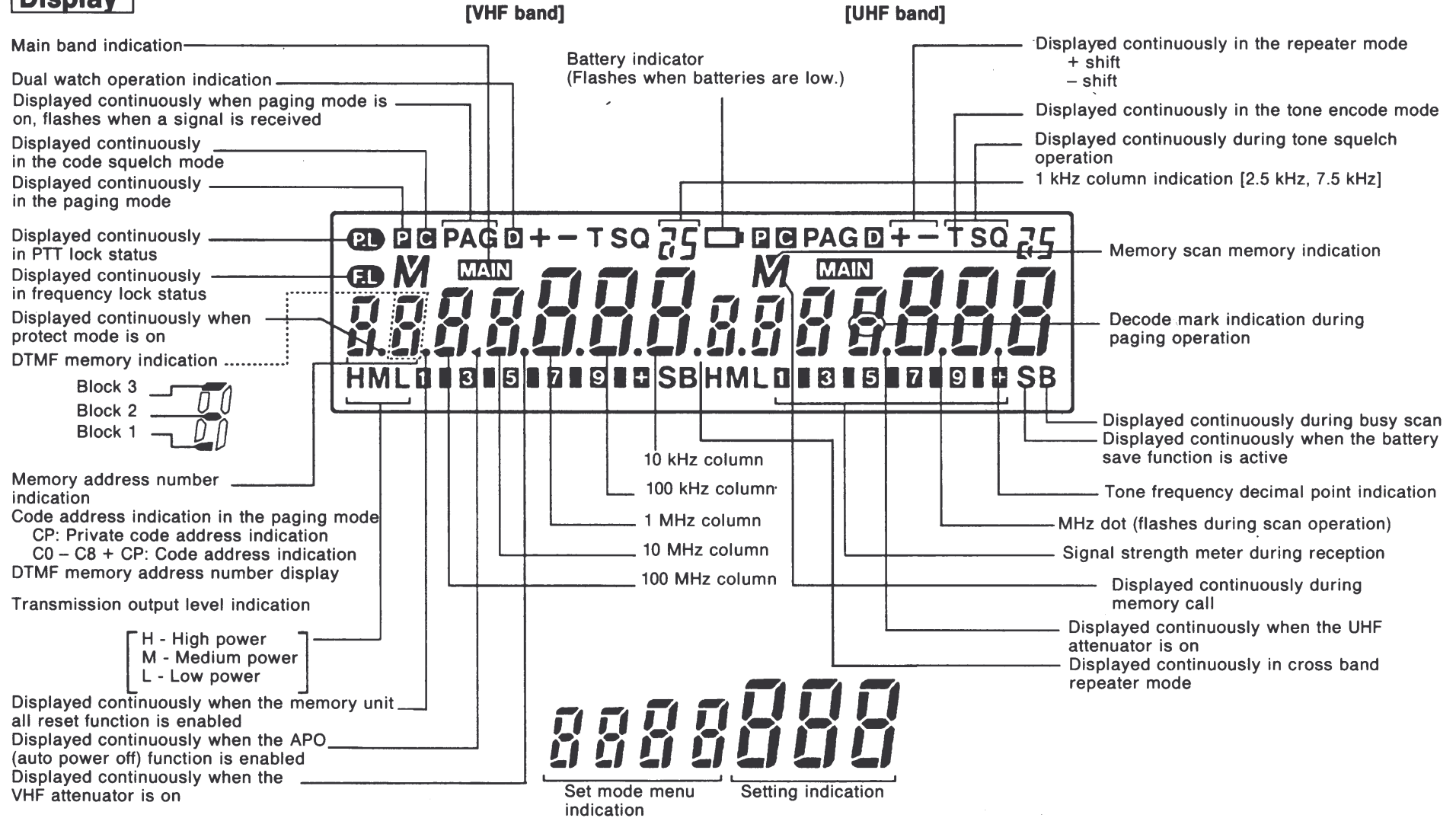

# Repeater Operation

## 1 About Repeater Operation

- This term refers to radio communication via a repeater station (a relay station).
- The repeater function uses a repeater station to make possible communication with locations too far away to contact directly.
- Transmitting and receiving via the repeater station take place on different frequencies.  
(The sending frequency is 5 MHz lower than the receiving frequency.)
- Repeater operation is possible only in regions where a repeater station is in operation. Check the local hobby magazines for listings of the transmitting and receiving frequencies for the repeater stations in your area.
- The C558 automatically sets the sending frequency 5 MHz lower than the receiving frequency when the repeater function is turned on.
- Pressing the CALL button during transmission activates the repeater station.

### Terminology

#### Repeater: Relay station

- Using a repeater station, even a transceiver broadcasting a weak signal can communicate with distant stations.

### Conventional (simplex) operation

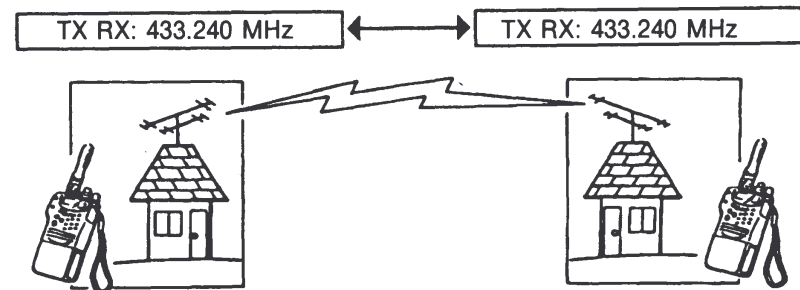

### Repeater operation

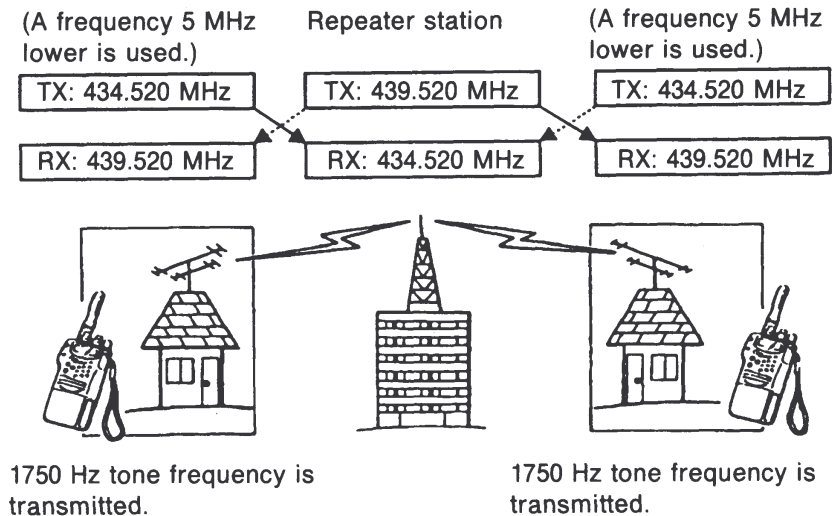

## 1 Repeater Operation

### Procedure

- 1) Hold down the FUNC key and press the 8 RPT key. The – indication appears on the display. Pressing the PTT switch causes the signal to be transmitted with a –5 MHz frequency offset.

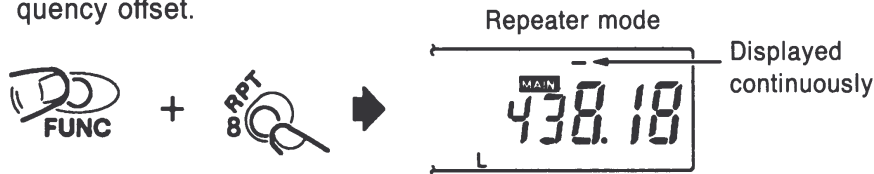

- 2) Once again hold down the FUNC key and press the 8 RPT key. The + indication appears on the display. Now when you press the PTT switch the signal is transmitted with a +5 MHz frequency offset.

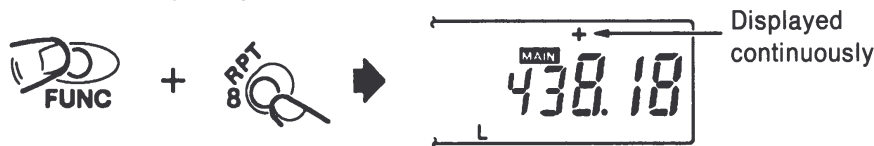

- 3) Press the CALL button while holding down the PTT switch to send a 1,750 Hz tone signal.
- 4) To cancel the repeater function, hold down the FUNC key and press the 8 RPT key again. The – and + indications disappear from the display.

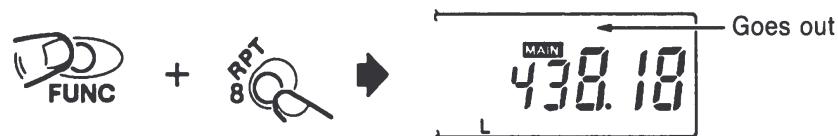

## 2 Reversing the Repeater Mode Send/Receive Frequencies

- This function allows you to communicate directly with another station (without using the repeater station). It is called reverse (REV) operation. Note, however, that if the signals broadcast by the other station are weak, direct communication may not be possible.

### Procedure

- 1) Hold down the FUNC key and press the 9 REV key. The – indication on the display flashes on and off to indicate that the sending and receiving frequencies have been reversed.

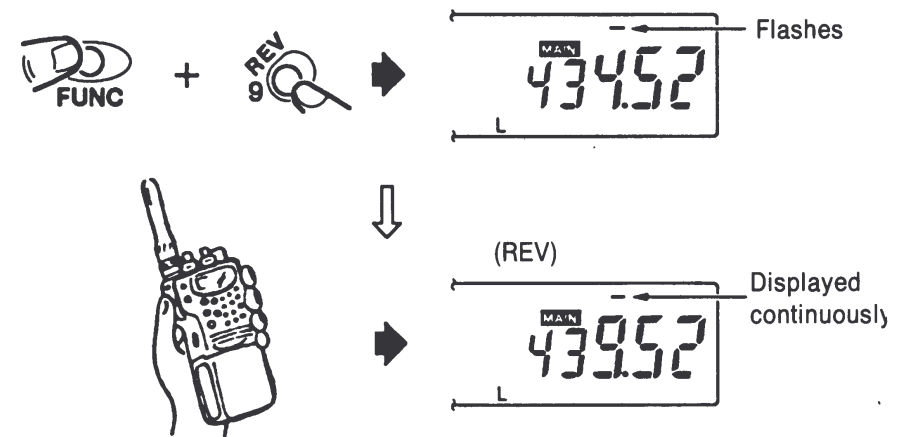

- 2) To cancel this function, hold down the FUNC key and press the 9 REV key again.

**NOTE**

- If the frequency setting is such that the offset frequency (whether for sending or receiving) would be pushed outside of the amateur radio band (off band), the display remains unchanged but nothing is transmitted. If performing step 1) above would result in an off band frequency, a "boo" (long low pitched beep) sounds and the new setting is not made.

### 3 Tone Frequency (CTCSS) Setting (Set Mode Status)

- The optional CTN160 CTCSS unit must be installed in order to use this function.

There are 38 tone frequencies to choose from.

Tone Frequency Chart (Unit: Hz)

67.0	71.9	74.4	77.0	79.7	82.5	85.4
88.5	91.5	94.8	97.4	100.0	103.5	107.2
110.9	114.8	118.8	123.0	127.3	131.8	136.5
141.3	146.2	151.4	156.7	162.2	167.9	173.8
179.9	186.2	192.8	203.5	210.7	218.1	225.7
233.6	241.8	250.3				

**Procedure**

- 1) Hold down the FUNC key and press the 0 SET key to activate the set mode.



- 2) Use the ▲ and ▼ keys to display the menu indication "CF 100.0". The current tone frequency setting appears on the display.

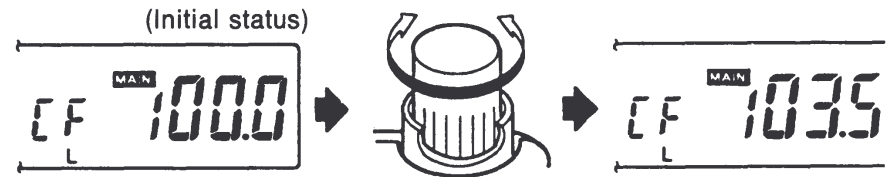

- 3) Select the tone frequency of your choice using the rotary channel selector.  
If "OFF" is selected, no internal tone frequency will be sent.
- 4) After setting the desired frequency, press the A CL PS key to return to the previous display.

※ CF stands for CTCSS frequency.

#### 4 Offset Frequency Setting (Set Mode Status)

- The offset frequency is set to 5 MHz when the unit is shipped from the factory.

##### Procedure

- 1) Switch to the set mode.  
(OF stands for offset frequency.)



- 2) Use the ▲ and ▼ keys to display the menu indication "OF 5.00". The current offset frequency setting appears on the display.



- 3) Select the new offset frequency using the rotary channel selector.



- 4) After setting the desired frequency, press the A CL PS key to return to the previous display.

#### 5 Using the LAMP Key for REV Operation (Set Mode Status)

##### Procedure

- 1) Hold down the FUNC key and press the 8 RPT key to display the - indication.  
[Repeater mode]



- 2) Switch to the set mode.  
Use the ▲ and ▼ keys to display the menu indication "LMPr OFF".

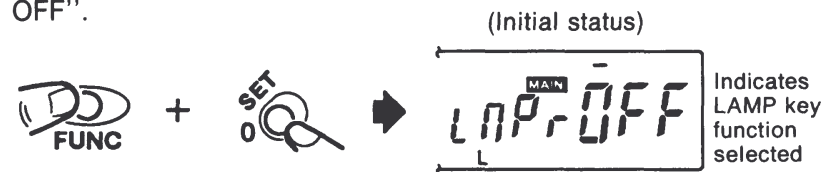

- 3) Select the ON or OFF setting using the rotary channel selector. Selecting ON causes the LAMP key to function as a REV key. Pressing it then has the same effect as FUNC + 9.

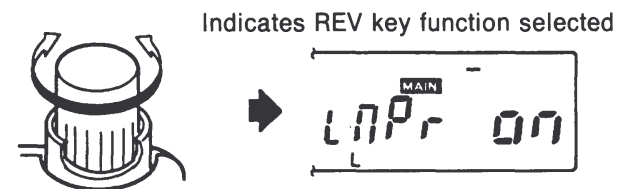

Continues on next page →

- 
- 4) After setting the desired frequency, press the A CL PS key to return to the previous display.
  - 5) To restore the original function of the LAMP key, repeat steps 2) through 4) above to change the setting to OFF.

[Example] Offset frequency is  
5.50 MHz



Flashes when REV operation has been selected

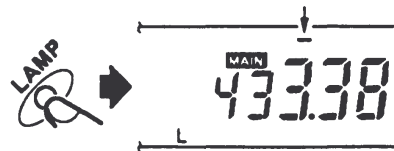

## 6 Transmitting a Tone Burst (1,750 Hz)

- Pressing the CALL P.L key during transmission (i.e., while the PTT switch is pressed) causes a 1,750 Hz tone burst signal to be transmitted. The tone burst signal is sent for only as long as the CALL P.L key is held down.

# Paging Operation

- This function can be used to page individual stations (personal paging) or a specific group of stations (group paging).

## NOTE

- The paging function requires that the sending and receiving ends use matching personal or group paging codes. The same group code must be used by every member of the group.

## 1 Preparations for Paging Operation

- Before using the paging function, you need to perform the following preparations.

### Procedure

- 1) Decide on your own private code and assign it to code address number C0 in the memory.
- 2) Decide on the other codes you will be using (personal codes of other stations and group codes) and assign them to code address numbers C1 – C8 in the memory.
- 3) Add the = symbol (decode mark) to any of the code address numbers (C1 – C8) you will be using as group codes for receiving.  
(Refer to page 32 for information on receiving using group codes.)

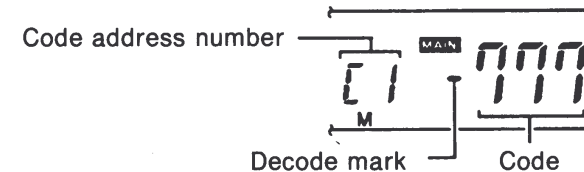

## ■ Code address numbers and their functions

Code address number	Paging function (The code setting and your personal code setting are broadcast.)
CP	The personal code of the station called is automatically recorded at this address. The personal code of the other station is automatically recorded in memory and appears on the display. If you press the PTT button at this point, the code being displayed is transmitted.
C0 =	This is the memory address number for your personal code. The decode mark is always displayed next to it. When you are called with your personal code, the personal code of the other station (memory address C0) appears on the display. If you press the PTT button at this point, the code being displayed is transmitted.
C1 C2 C3 C4 C5 C6 C7 C8	These memory addresses are for the personal codes of other stations and group codes. Group codes designated with the = mark can be used for receiving. The = mark is called the decode mark. The = mark can be assigned to more than one memory address.

## 1 Setting Your Personal Code

- Codes consist of three numerals.

Perform the steps below to set your personal code.

**Example** Setting the personal code to C0 - 111.

### Procedure

- Hold down the FUNC key and press the  $\nabla$  CODE key.  
The code address number which was used last is displayed.  
(This is set to C0 -000 when the unit is shipped from the factory.)



- Select code address number C0 - using the  $\nabla$  and  $\blacktriangle$  keys or the rotary channel selector.  
A "puff" (short low pitched beep) sounds at code address number C0 - .

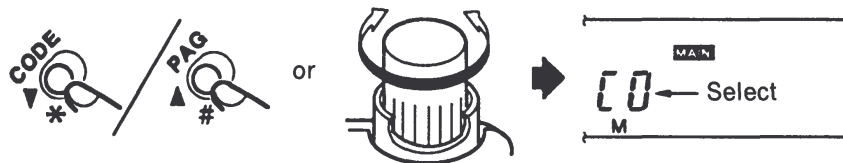

- Input your personal code. Using the numeric keys to input 1,1,1 causes 111 to appear on the display one digit at a time. When the last 1 is entered, a "peep" (long high pitched beep) sounds to indicate that the code has been set.

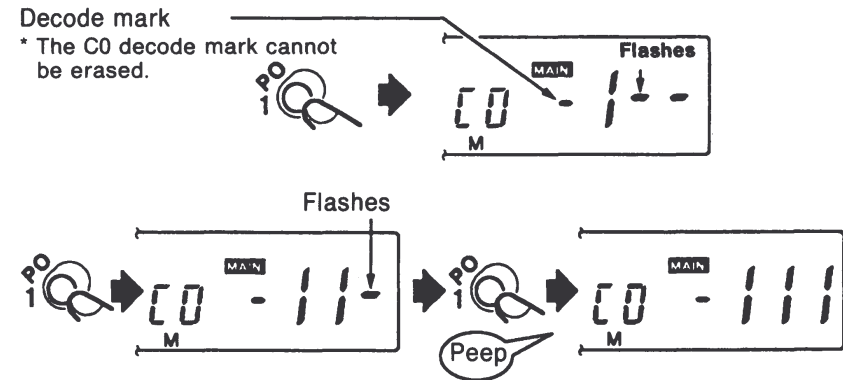



**ADVICE**

- (1) The personal code transmitted to you from the other station is stored at memory code address number CP.  
Code address number CP can be used in the same manner as code address numbers C1 – C8, but it is automatically overwritten with the personal code of the other station when a paging transmission is received.
- (2) Once you have set your own station code you can use it for both group and personal paging.

※ Adding the decode mark **-** to an address number makes it usable for receiving.

■ **Setting example**

Code address number	Decode mark	Station A	Station B	Station C
Your personal code C0	-	111	222	333
C1	—	222	111	111
C2	-	050	050	050
C3	—	333	333	222

**2 Setting Personal Codes for Stations C1 – C8**

**Procedure**

- 1) Hold down the FUNC key and press the **✳** **▼** CODE key.
- 2) Select the code address number of your choice using the **▲** and **▼** keys or the rotary channel selector.
- 3) Input the other station's code using the numeric keys.  
To store additional codes in memory, repeat steps 2) and 3) above as many times as necessary.

**ADVICE**

- This procedure can also be used to set group codes to be used for receiving.

### 3 Designating Group Codes for Receiving

- After the codes have been recorded in memory, designate which group codes you wish to use for receiving.

#### Procedure

- 1) Hold down the FUNC key and press the \* ▼ CODE key to call up the code address of the code (C1 – C8) you wish to designate as a group code for receiving.
- 2) Hold down the FUNC key and press the C MS MS.M key. A - appears above the display, indicating that the currently displayed code address has been designated as a group code for receiving.

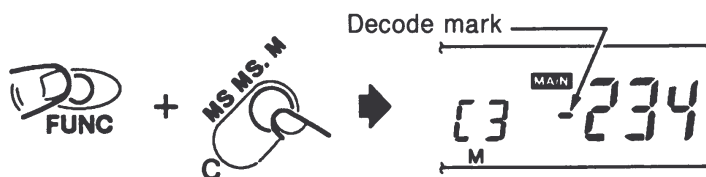

#### ADVICE

- (1) More than one code address can be designated with the decode mark. To designate more than one group code, repeat steps 1) and 2) above as many times as necessary.

#### ■ Canceling group codes

- The group code status of a code address is canceled by removing the decode mark.

#### Procedure

- 1) Hold down the FUNC key and press the \* ▼ CODE key.
- 2) Call up the code address number of the group code you wish to cancel.
- 3) Hold down the FUNC key and press the C MS MS.M key. A "puff" (short low pitched beep) sounds and the - indication disappears.

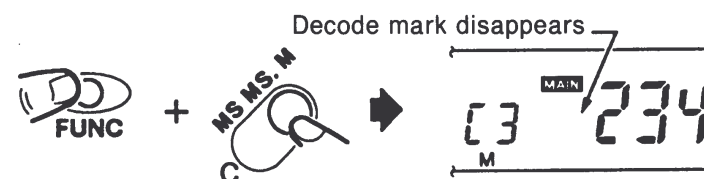

#### NOTE

- (1) The - mark cannot be erased from code address number C0.

## 2 Paging Mode Operation

- Paging operation is described separately below for the transmitting (you) and receiving (other) sides.
- Both the transmitting and receiving sides must use the same frequency.

### ◆ Transmitting side (you)

#### Procedure

- 1) Select the code address number corresponding to the personal code of the station you wish to page. If the desired code is not in the unit's memory, enter it.
- 2) Press the A CL PS key.
- 3) Hold down the FUNC key and press the # ▲ PAG key. The indication P PAG appears on the display.
- 4) Press the PTT switch. The code (DTMF signal) is transmitted and "pilala-pilala-pilala" (repeated high pitched warbles) are heard. The code transmitted is  $\times \times \times * \triangle \triangle \triangle$ .
- 5) When a signal is received from the other station, the paging mode is canceled and normal communication is possible.

[Code appearing on display]

The CP indication means that you have been paged by your personal code. (The code of the station calling is 111.)



[Code address number C0 code]

An indication other than CP means that you have been paged using a group code. (The station calling is some- one in group 050.)

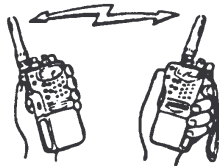
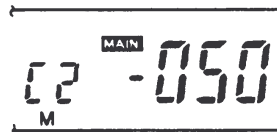

### ◆ Receiving (other) side

#### Procedure

- 1) Hold down the FUNC key and press the # ▲ PAG key. The indication P PAG appears on the display.
- 2) If the received code and the code recorded at code address C0 match:
  - a. Five "pips" (high pitched beeps) sound.
  - b. PAG flashes on and off on the display.
  - c. The personal code of the calling station appears on the display. (The code address number setting becomes CP.)
- 3) If the received code and one of the codes with a = mark match:
  - a. Five "pips" (high pitched beeps) sound.
  - b. PAG flashes on and off on the display.
  - c. The matching group code appears on the display.
- 4) When the PTT switch is pressed, the displayed code and the personal code (of the calling side) are transmitted. This means that you can send your code to the other (receiving) station.
- 5) The paging mode is canceled and normal communication is possible.

#### NOTE

- $\times \times \times$  : Code selected from the available code addresses  
 $\triangle \triangle \triangle$  : Your personal code

## Operation example

- Assigning codes to code address numbers.

### ADVICE

- During paging operation, the code shown on the display is transmitted.

- ◆ Station A code address assignments  
 C0 = : 111 - personal code for station A  
 C1 = : 222 - personal code for station B  
 C2 = : 050 - group code  
 (Append the decode mark.)

- ◆ Station B code address assignments  
 C0 = : 222 - personal code for station B  
 C1 = : 111 - personal code for station A  
 C2 = : 050 - group code  
 (Append the decode mark.)

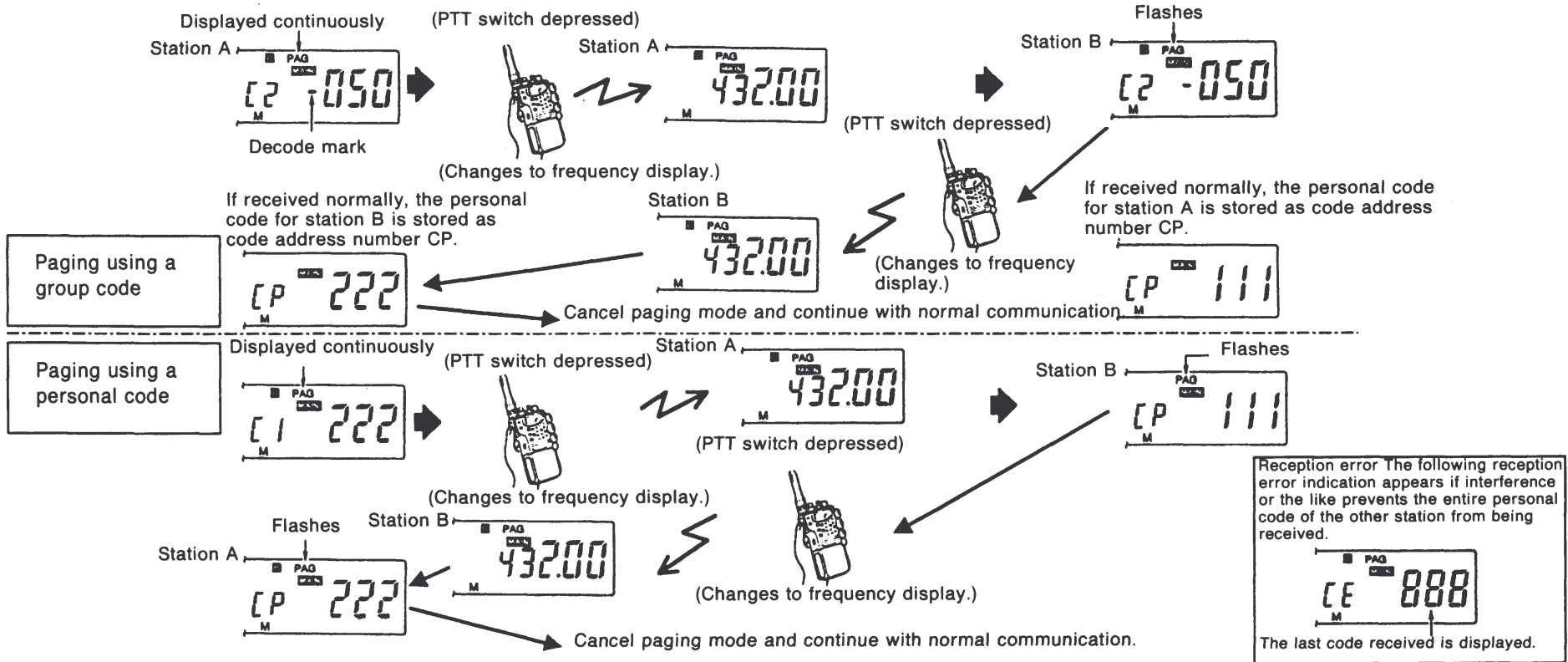

#### ADVICE

- (1) If the codes match and the unit displays the contents of code address CP, you have been paged using your personal code. If something other than code address CP appears, you have been paged using a group code.
- (2) The personal code of the calling station is recorded at code address CP even if you are paged using a group code. By checking code address CP you can determine which member of the group is calling.

#### NOTE

- (1) If both the paging and tone squelch functions are active, no sound will issue from the speaker unless the tone frequencies match, even if the paging codes match.
- (2) It is possible to activate the tone squelch and paging (code squelch) functions at the same time. However, due to timing problems the paging function may not operate properly if the tone squelch function is turned on for both the VHF and UHF bands.

### 3 Communication when Codes Match

- Once codes match, turn off the paging function and communicate normally.

#### Procedure

- 1) Hold down the FUNC key and press the # ▲ PAG key twice. The display indication changes from **P** PAG to **C** to no indication. Paging mode is now cancelled. Continue with normal communication.

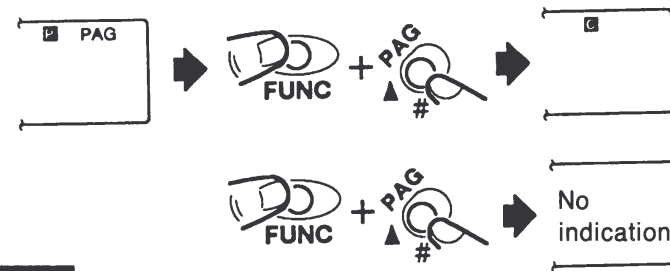

#### ADVICE

- (1) Holding down the FUNC key and pressing the # ▲ PAG key once while the PAG indication is flashing on the display causes PAG to disappear and only the **P** mark to remain. This indicates that paging operation is stopped temporarily.
- (2) When only the **P** mark is displayed, normal communication is possible just as if step 1) above had been performed.

Note, however, that the unit's microprocessor considers paging to be on, so turning power off and then on again or changing the frequency setting will cause the PAG indication to reappear on the display.

# Code Squelch Operation

- As with the paging function, code squelch permits communication only after matching a 3-digit code. It operates similarly to the tone squelch function.

## Procedure

- Hold down the FUNC key and press the \* CODE key.



- Select the code you wish to use.
- Press the A CL PS key.



- Hold down the FUNC key and press the # PAG key twice. The [C] indication appears on the display.

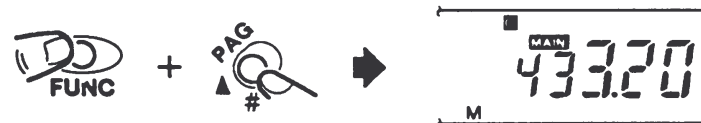
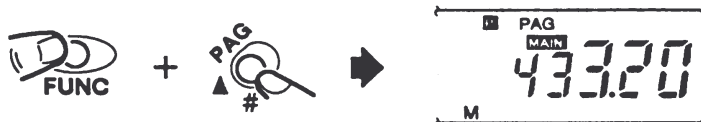

- Begin code squelch operation using the code you have selected.
- Press the PTT switch. The code is transmitted and "pilala" (a high pitched warble) is heard.

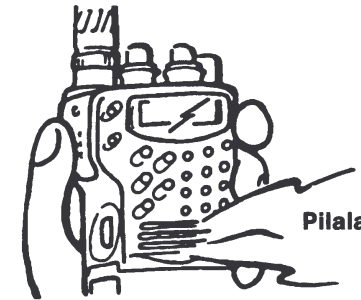

## NOTE

- Communication is not possible if the code selected does not match that of the other station. Therefore, make sure the codes match.
- Any code address number can be used for this function.

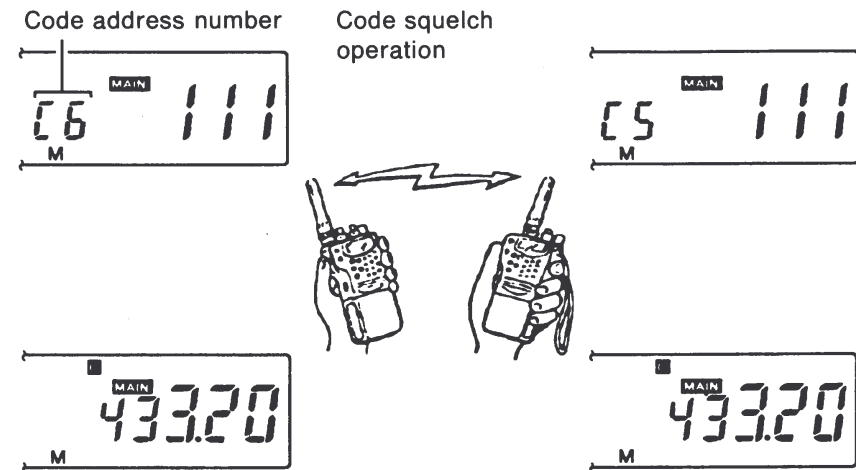

# Tone Squelch Operation

- See information on the related CTCSS tone frequency setting function (page 27).
- The tone squelch function is used for tone squelch operation and tone encoding with the optional CTN160 CTCSS unit installed.

## Procedure

- 1) Hold down the FUNC key and press the 7 TSQ key once. A T indication appears on the display to indicate that the tone encode mode is active.



- 2) Hold down the FUNC key and press the 7 TSQ key once again. TSQ appears on the display to indicate that tone squelch operation is possible.



- 3) To cancel the tone squelch mode, hold down the FUNC key and press the 7 TSQ key. The TSQ indication disappears from the display, and tone squelch is deactivated.

## NOTE

- (1) If the CTN160 is not installed, a “boo” (short low pitched beep) sounds when the above operation is attempted and no setting takes place.
- (2) It is necessary that the tone frequency match that of the other station.  
See page 27 for instructions for setting the frequency.
- (3) Transmissions on the main band take precedence if the tone squelch function is turned on for both the VHF and UHF bands. (Squelch disengages on the sub-band during transmission.)

# Memory Operation

## 1 About the Memory Function

- The transceiver requires a memory unit in order to use the memory function. Memory operation is not possible if no memory unit has been installed. It is highly recommended that the transceiver be operated with a memory unit installed.
- The transceiver can be operated without a memory unit installed, but only in the VFO mode.  
The transceiver is shipped from the factory with the CMU160 memory unit with a capacity of 20 VHF and 20 UHF channels already installed.
- The memory function allows you to store frequently used frequencies for use when needed.
- Up to 40 separate frequencies can be stored in memory, 20 VHF and 20 UHF.
- The locations where frequencies are stored are called “memory address numbers.”
- The memory address numbers range from M00 through M19.
- The optional CMU161 memory unit increases the number of memory channels to 100 channels each for VHF and UHF with memory address numbers ranging from M00 through M99.

- The relationship between block numbers and memory address numbers is shown in the following table

Block number	Memory address numbers
0	M00 — M09
1	M10 — M19
2	M20 — M29
3	M30 — M39
4	M40 — M49
5	M50 — M59
6	M60 — M69
7	M70 — M79
8	M80 — M89
9	M90 — M99



## 2 About the CMU160 Memory Unit

- Up to 40 separate frequencies can be stored in memory, 20 VHF and 20 UHF. The optional CMU161 memory unit increases the number of memory channels to 100 each for VHF and UHF for a total of 200.

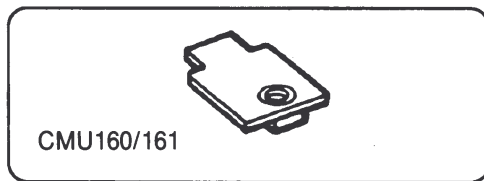

### 1 Memory Unit Protection Function

- The transceiver is equipped with a protection function to prevent the contents of the memory from being erased should the power supply voltage drop. The protection function is triggered if the voltage drops to approximately 3.8 V or below. You can tell when the protection function has been triggered because pressing any key causes a “boo” (short low pitched beep) to sound. No operations can be performed in this state. When the protection function has been triggered the  mark flashes on and off on the display.

### ADVICE

- If the power supply voltage drops during use due to battery discharge, the protection function is triggered and the  mark appears on the display.

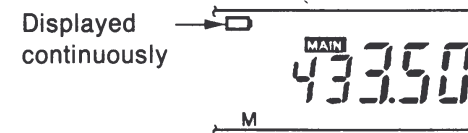

### 2 Memory Unit Compatibility

- The CMU160 and CMU161 can also be used with the C168 and C468. The contents of memory are not compatible, however. In other words, a CMU160 or CMU161 that was being used connected to a C168 or C468 cannot simply be installed on the C558 and used. Attempting to do this will cause repeated warning beeps (puff-puff-puff-puff) to sound.
- To erase the CMU160 or CMU161 memory contents and use the memory unit with the C558, first use the all reset function on the CMU160 or CMU161 to clear the memory unit and then install it on the C558 (see page 45).

### NOTE

- If a memory unit that was being used with the C558 is mounted on a C168 or C468, the memory contents may become corrupted and the C168 or C468 may malfunction.

### 3 Storing Frequencies in Memory

#### Example Entering 433.10 MHz in memory as M10

##### Procedure

- 1) In the VFO mode, select the frequency 433.10 MHz so that it appears on the display.



- 2) Hold down the FUNC key and press the D V/M ENT key. An M- - indication appears on the display.



- 3) Press the 1 PO key. A 1 appears on the display below the M.

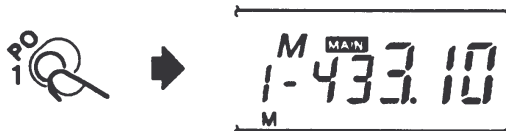

- 4) Press the 0 SET key. A "peep" (long high pitched beep) sounds to indicate that the frequency has been stored in memory. This status is referred to as the memory mode.



- 5) Pressing the D V/M ENT key at this point returns the transceiver to the VFO mode.

##### NOTE

- To store a frequency as M01, you would press the 0 key followed by the 1 key.

---

#### 4 Storing Tone Frequencies, Etc. in Memory

- In addition to transmitting and receiving frequencies, the following settings can also be stored in memory.
  - CTCSS tone frequency (Page 27)
  - Tone encode mode (Page 38)
  - Tone squelch mode (Page 38)
  - Paging mode (Page 34)
  - Code squelch mode (Page 37)
  - Paging and tone squelch send code addresses (Pages 31 and 37)
  - Repeater mode (Page 26)
  - Offset frequency (Page 28)
- These settings can be stored in the unit's memory by performing the appropriate operations while in the memory call mode.  
See the pages indicated in parentheses ( ) for instructions.

#### 5 Recalling Frequencies from Memory

- Memory frequencies (memory address numbers) can be called up using any of the following three methods.
  - (1) Inputting the memory address directly using the numeric keys
  - (2) Calling up a memory address using the rotary channel selector
  - (3) Calling up a memory address using the ▲ and ▼ keys.)

## 5.1 Using the Numeric Keys

### Example Calling up M07 memory frequency of 433.10 MHz

#### Procedure

- In the VFO mode, press the D V/M ENT key.  
The memory mode is activated and the memory address which was used last appears on the display along with the M indication.  
(When the memory mode is activated for the first time or if all address numbers are unassigned, M00 is displayed.)

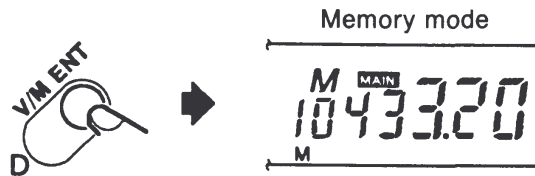

- Press the 0 SET key.  
M0 - is displayed as shown below.

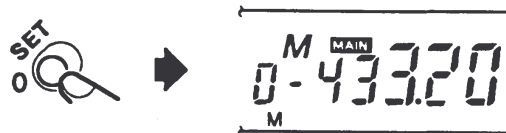

- Press the 7 TSQ key.  
A "peep" (long high pitched beep) sounds to indicate that memory address M07 has been called up.



#### ADVICE

- There are cases when the M indication on the display is flashing when a memory address number is called up.

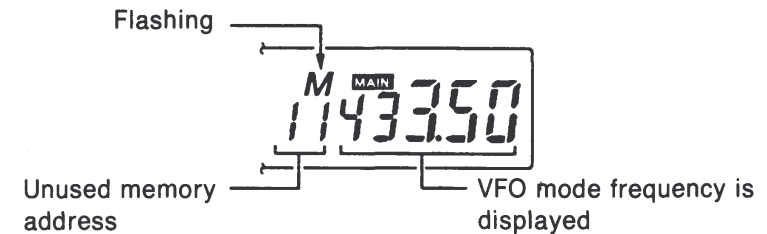

This indicates that no frequency is stored at the memory address number.

(Henceforth, memory address numbers for which the M indication flashes will be referred to as unused memory addresses.)

- If an unused memory address is called up, the VFO frequency is displayed.

## 5.2 Using the Rotary Channel Selector

- Activate the memory mode and select a memory address number by turning the rotary channel selector.

### ADVICE

- (1) Turning the rotary channel selector with the FUNC key held down causes the 10's column of the memory address number to change.

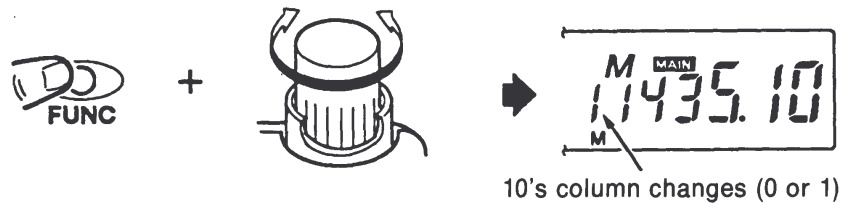

## 5.3 Using the ▲ and ▼ Keys

- Activate the memory mode and use the ▲ and ▼ keys to select a memory address number.

### ADVICE

- (1) If the ▲ and ▼ key is held down for 0.5 seconds or more, the memory address setting changes slowly and continuously in the direction indicated until the key is released.

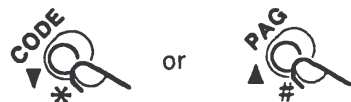

Hold down for 0.5 seconds or more.

## 6 Changing Frequencies Stored in Memory

- Display the new frequency and input the address number to be reassigned using the numeric keys.

### Example Changing M07 from 433.10 MHz to 433.12 MHz

#### Procedure

- 1) In the VFO mode, select the frequency 443.12 MHz so that it appears on the display.



- 2) Hold down the FUNC key and press the D V/M ENT key.



- 3) Press the 0 SET key.

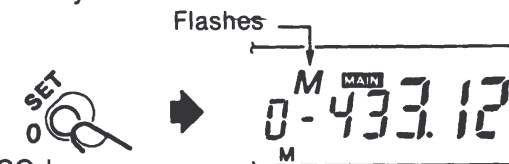

- 4) Press the 7 TSQ key.  
A "peep" (long high pitched beep) sounds to indicate that the new frequency has been stored in memory in place of the old one.

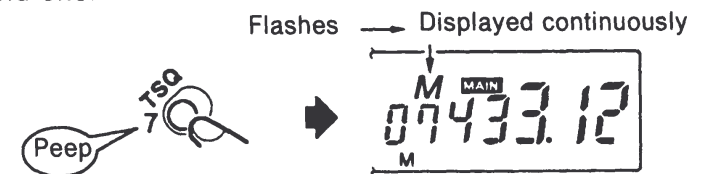

## 7 Deleting Frequencies from Memory

### Example Deleting the frequency 433.12 MHz from M07

#### Procedure

- 1) Switch to the memory mode and call up the address number whose contents you wish to delete M 07 so that it appears on the display.

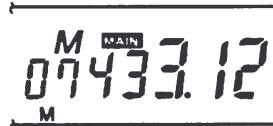

- 2) Hold down the FUNC key and press the D V/M ENT key.

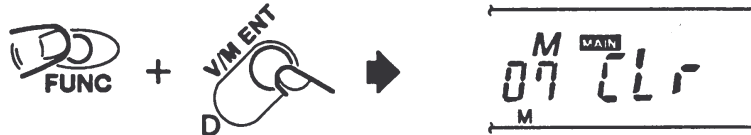

- 3) Once again, hold down the FUNC key and press the D V/M ENT key.  
A "peep" (long high pitched beep) sounds to indicate that the memory frequency has been deleted.  
(M07 becomes an unused memory address number and the indication M flashes on and off on the display.)

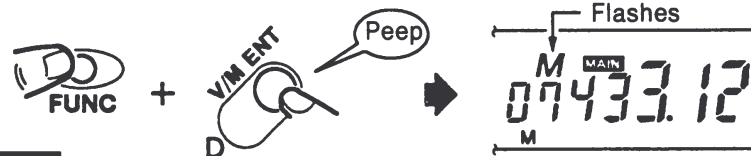

#### ADVICE

- Cancelling a memory frequency will cause any mode assigned to the memory address number you have deleted to return to its factory settings.

## 8 Memory Unit All Reset Function

- When shipped from the factory, the optional CMU160 and CMU161 memory units are configured for use with the Standard C168 handy transceiver. Before they can be used with the C558, the all reset procedure described below must be performed.

#### Procedure

- 1) Hold down the CALL PL key and press the POWER switch.  
The unit beeps (pip-puff) and the power comes on.

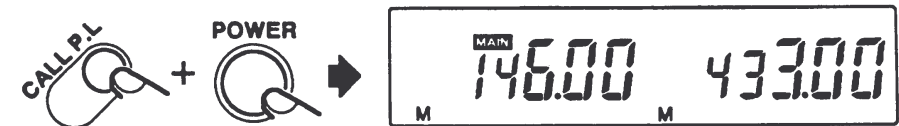

- 2) Hold down the FUNC key and press the 0 SET key. The display appears as shown below.

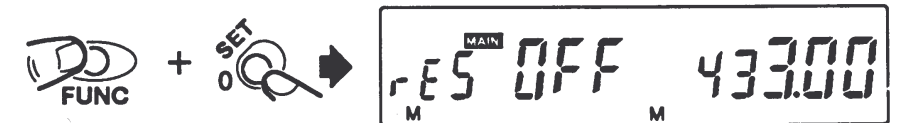

- 3) Turn the rotary channel selector until the display appears as shown below.

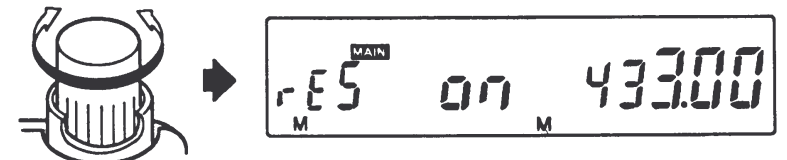

- 4) Hold down the FUNC key and press the POWER switch.  
When the unit beeps (pip-puff) and the display appears as shown below, the all reset procedure is finished. The memory unit is now ready for use. (It has been restored to its factory settings.)

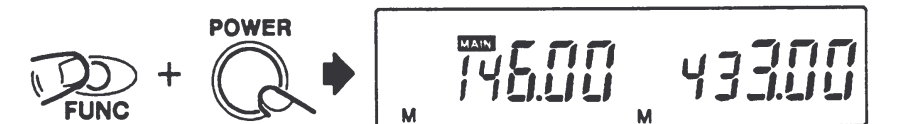

## 9 Changing Frequencies from the Memory Mode (Memory Shift Mode)

- The operations of the VFO mode are also accessible from the memory call mode.

The status in which such operations are possible is referred to as the memory shift mode.

### Procedure

- 1) Switch to the memory mode.
- 2) Hold down the FUNC key and press the 3 SFT key.  
The memory address number flashes on and off on the display.



- 3) Select the desired frequency.  
As in the VFO mode, you can select the frequency using the ▲ and ▼ keys, the rotary channel selector or the numeric keys.
- 4) To cancel the memory shift mode, either hold down the FUNC key and press the 3 SFT key or press the A CL PS key.  
The previous memory frequency is redisplayed.

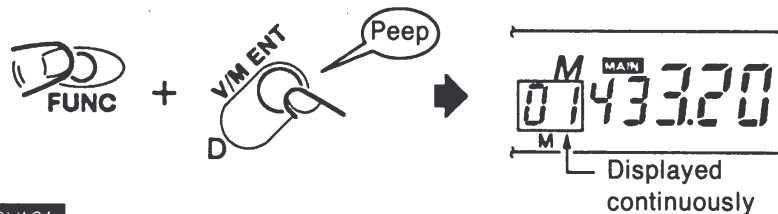

### ADVICE

- Holding hold down the FUNC key and pressing the D V/M ENT key causes a new memory frequency to be registered. The memory address number on the display stops flashing and is displayed continuously.

## 10 Protection Function for Data Assigned to Memory Address Numbers (Protect Mode)

- This function protects memory or call data from being accidentally changed or erased.
- It can be set individually for each memory address number.

### Procedure

- 1) Hold down the FUNC key and press the 5 PRO key. A dot appears on the display, indicating that the contents of the current memory address are protected.



- 2) To cancel the protect mode, once again hold down the FUNC key and press the 5 PRO key. The dot disappears and protect mode is cancelled.



### ADVICE

- The protect mode cannot be turned on for memory address numbers at which no frequency is stored.

### NOTE

- The contents of all memory address numbers, including those for which the protect mode is turned on, are erased if the all reset function is activated.

## 11 Instant Initialization Function

- This function allows you to temporarily suspend all functions of the transceiver in order to reset just the VFO mode.

It is useful for cases when another function is active but you want to communicate immediately in the VFO mode. This function returns the transceiver temporarily to its initial settings for quick communications, without erasing existing function or memory settings. (It is not equivalent to the all reset function.)

### Procedure

- 1) Turn power off.
- 2) Hold down the CALL key and press the POWER switch to turn the unit back on.

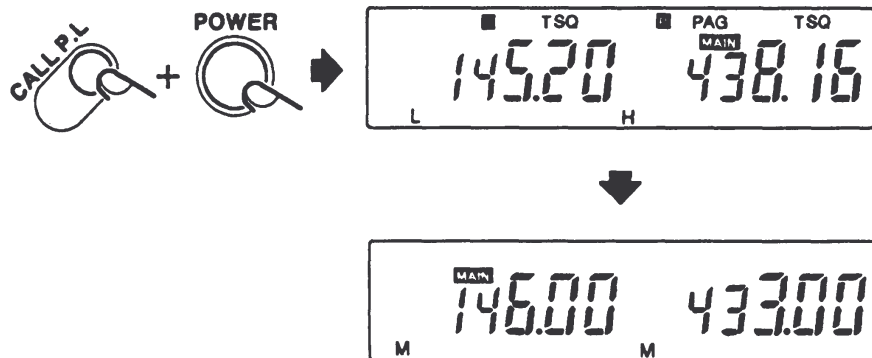

- 3) Select the band and frequency of your choice and communicate normally.
- 4) To cancel the instant initialization mode, press the POWER switch once to turn power off and then a second time to turn it back on. The unit returns to the status it was in before the instant initialization mode was activated.

### ADVICE

- It is not possible to recall or record memory frequencies, or to change call frequencies, in the instant initialization mode.



# Scan Operation

## 1 About Scan Operation

- The transceiver supports three types of scan: pause scan, busy scan and hold scan.  
(During scan operation, the microprocessor determines the settings for functions separate from the above three scan modes, such as whether frequency change volume T SQ is on or off, and control the scan speed automatically (intelligent scan function)).  
Note that the VFO scan and memory scan functions are independent of one another.

### 1 Busy scan

- Scan is paused for as long as a signal is being received. Scan operation recommences 2 seconds after the signal is lost.

### 2 Pause scan

- Scan pauses when a signal is received. Five seconds later, scan operation recommences even if a signal is still being received.  
(Scan operation recommences immediately if the signal is lost.)  
The B indication on the display is not displayed (continuously or flashing) during pause scan.

### 3 Hold scan

- Scan is temporarily suspended when a signal is received. Pressing the ▲ or ▼ key causes scan operation to recommence.

#### ADVICE

- (1) It is possible to change the scan type while a scan is in progress.
- (2) Settings for busy scan, pause scan and hold scan must be made separately for the VFO and memory scan modes.
- (3) Hold scan is not possible during tone frequency scan operation.

#### ■ Changing the scan type

- While the scan is in progress, hold down the FUNC key and press the 0 SET key.  
The scan type changes in the order shown below.

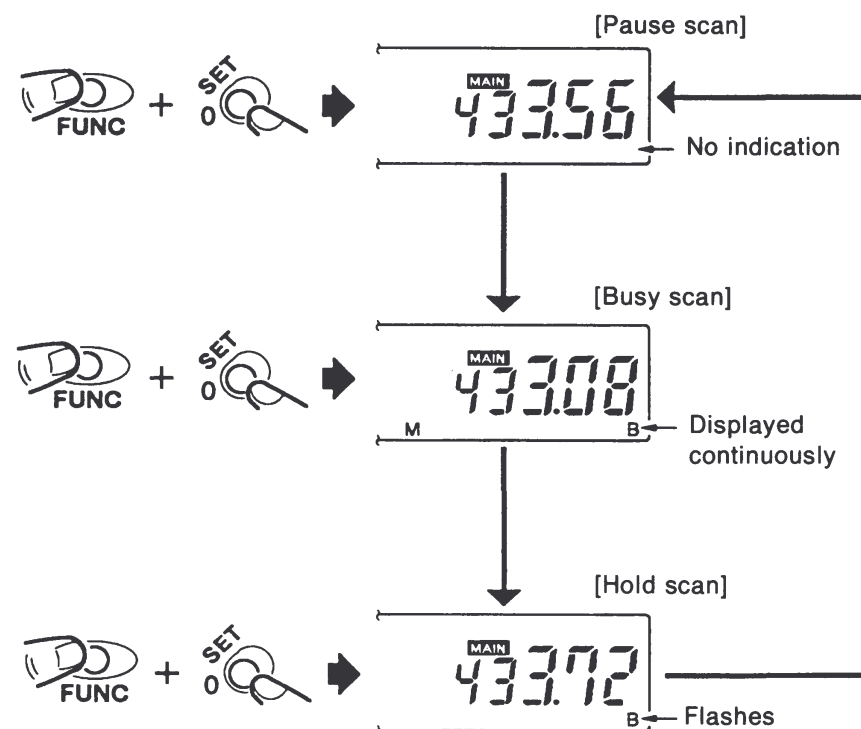

---

## 2 Types of Scan Functions

### 1 VFO Scan

- 1) Scanning the 1 MHz range of your choice [1 MHz scan]
- 2) Scanning an entire band [Full band scan]
- 3) Scanning a range of frequencies specified by you [Program scan]

### 2 Memory Scan

- 1) Scanning the frequencies stored at all memory address numbers [Memory scan]
- 2) Scanning the frequencies assigned to a block of memory address numbers specified by you [Block memory scan]
- 3) Scanning the frequencies assigned to specific memory address numbers specified by you [Memory scan memory]

#### NOTE

- (1) If the save function is active during the scan, save memory scan takes place.
- (2) The save function is temporarily disabled during scan operation in other than the memory scan mode.

### 3 Tone Frequency Scan

- 1) Scans the tone frequencies.  
The optional CTN160 CTCSS unit is required.  
(See page 82 for details.)

## 3 Scan Operation Instructions

### 1 VFO Scan

#### Procedure Scanning Within a 1 MHz Range

- In the VFO mode, hold down the FUNC key and press the A CL PS key. The decimal point on the display flashes on and off and scan operation commences.

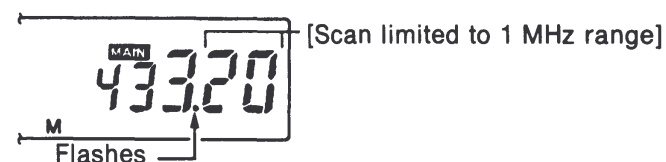

#### Procedure Full band scan

- 1) Press the CALL key. (The call mode is activated.)
- 2) Hold down the FUNC key and press the A CL PS key. The decimal point on the display flashes on and off and full band scan operation commences.

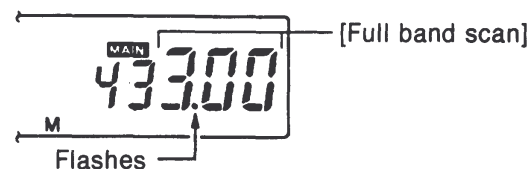

Continues on next page →

**Procedure**      **Program scan**

- This function scans a range of frequencies specified by you.  
Before starting the scan, you must store the scan start and end frequencies in memory.

**Example**      **Scanning the range from M01 432.00 – M02 433.80**

- 1) Store the scan start frequency in memory.  
(Any memory address number may be used.)

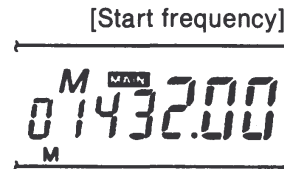

- 2) Store the scan end frequency in memory.  
(Any memory address number other than that of the start frequency may be used.)

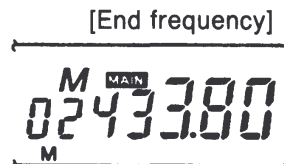

- 3) Switch to the memory mode and call up the memory address number of the start frequency.

- 4) Hold down the FUNC key and press the A CL PS key.  
The address number on the display changes to a flashing [-].

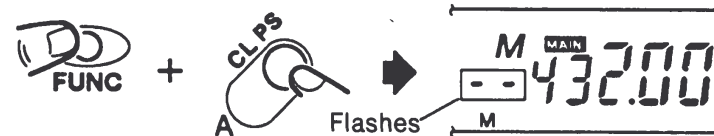

- 5) Press the numeric keys corresponding to the memory address number of the end frequency.  
After inputting the address number (two digits), program scan operation commences immediately. (The decimal point flashes on and off.)

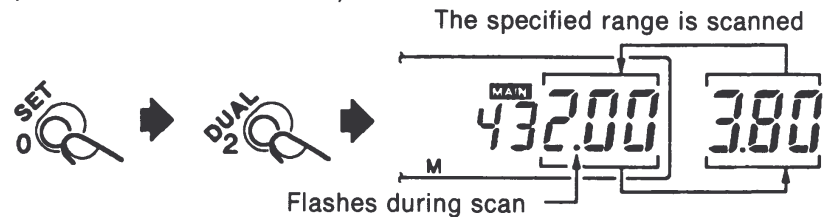

**ADVICE**

- If the start frequency is higher than the end frequency, the range of frequencies between the two is omitted from the scan.

---

## 2 Cancelling Scan Operation

### Procedure

- Press the A CL PS key.

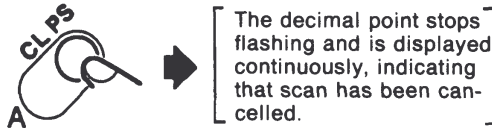

## 3 Other VFO Scan Operations

- (1) The display appears the same during 1 MHz, full band and program scan operation.
- (2) Pressing the ▲ or ▼ key during scan operation causes the scan to pause. To recommence the scan, press the ▲ or ▼ key once again.
- (3) It is possible to control the scan direction by pressing either the ▲ or ▼ key to resume scan operation.
  - If the ▲ key is pressed twice, scan resumes, moving sequentially higher in frequency.
  - If the ▼ key is pressed twice, scan resumes, moving sequentially lower in frequency.

## 4 Memory Scan

- This function scans only the frequencies assigned to memory address numbers.

### Procedure **Memory scan**

- Press the C MS MS.M key. (Memory scan is activated.) If all memory address numbers are free, a "boo" (short low pitched beep) sounds and no scan is initiated.

### 4.1 Block Memory Scan

- The memory address numbers from M00 to M19 are divided into two blocks. This function scans only the block specified by you.
- The memory address numbers are assigned to the two blocks as follows.
  - Block 0 contains M00 – M09.
  - Block 1 contains M10 – M19.

### Procedure **Block memory scan**

- 1) Press the C MS MS.M key to activate memory scan.
- 2) Press the numeric key corresponding to number of the block (0 or 1) you wish to scan.  
Block memory scan commences.  
If all memory address numbers in the specified block are unused, a "boo" (short low pitched beep) sounds and no scan is initiated.
- 3) To return to memory scan, press the C MS MS.M key.

### ADVICE

- If the optional CMU161 memory unit is installed, the available block numbers are expanded to 0 – 9. (See page 39 for details.)

## 4.2 Memory Scan Memory

- Only the memory address numbers specified are scanned.

### Procedure

- 1) Call up one of the memory address numbers you wish to scan.
- 2) Hold down the FUNC key and press the C MS MS.M key. The ▼ mark appears above the M indication on the display.

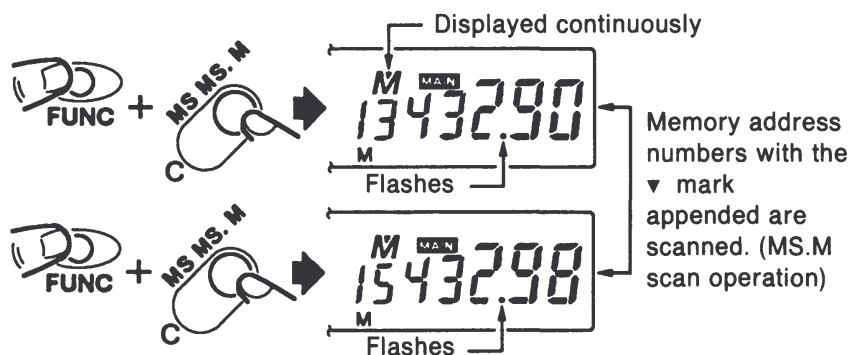

- 3) In like manner, mark all the memory addresses you wish to scan with the ▼ indication.
- 4) Next, press the C MS MS.M key to activate memory scan.
- 5) Hold down the FUNC key and press the C MS MS.M key. Only the memory address numbers with the ▼ mark appended are scanned.
- 6) To return to normal memory scan, hold down the FUNC key and press the C MS MS.M key. The ▼ indication disappears.

### ADVICE

- In the VFO mode, holding down the FUNC key and pressing the C MS MS.M key causes a ▼ to appear on the display. Pressing the C MS MS.M key at this point initiates memory scan memory.

## 5 Cancelling Memory Scan

- Press the A CL PS key (the memory mode resumes) or press the D V/M ENT key (this switches to the VFO mode).

## 6 Tone Frequency Scan (Set Mode Status)

- The optional CTN160 CTCSS unit is required.  
If the CTN160 is not installed, performing the steps causes a “boo” (short low pitched beep) to sound and no scan is initiated.  
Tone frequency scan scans the tone frequency of the current reception frequency.

### Procedure

- 1) Hold down the FUNC key and press the 7 TSQ key twice.  
The TSQ indication disappears on the display.

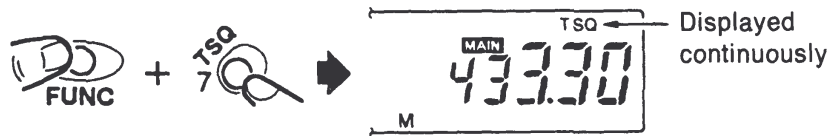
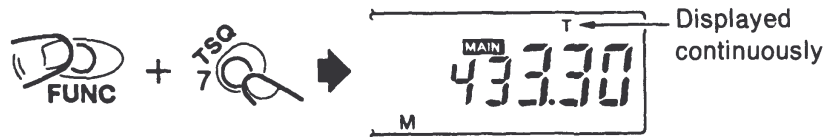

- 2) Hold down the FUNC key and press the 0 SET key.

[Set mode status]



- 3) Use the ▲ and ▼ keys to select the display “CF 88.5”.

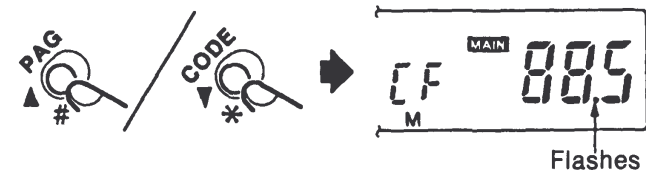

- 4) Hold down the FUNC key and press the A CL PS key.  
Tone frequency scan commences.

- 5) To cancel tone frequency scan, press the A CL PS key.

# Call Function

- The call memory is entirely independent of memory address numbers M00 – M19.
- The call frequency (referred to as the main channel) is set to 433.00 MHz for the UHF band (146.00 MHz for the VHF band) when the unit is shipped from the factory.
- The call memory frequency can be changed if desired.

## 1 Using the CALL Key

### Procedure

- 1) Press the CALL key.  
A “pip” (short high pitched beep) sounds and the call frequency appears on the display.

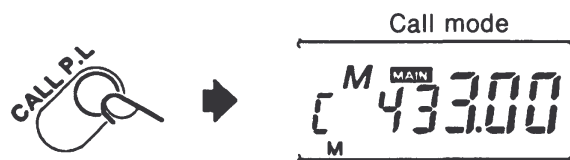

- 2) Press the CALL key a second time.  
A “puff” (short low pitched beep) sounds and the display returns to the status it was in before the CALL button was first pressed.

### ADVICE

- If the A CL PS key is pressed, the rotary channel selector is turned or the ▲ or ▼ key is pressed while the call frequency is being displayed, the VFO frequency replaces the call frequency.
- Pressing this key during transmission causes a 1,750 Hz tone burst signal to be transmitted.

## 2 Changing the Call Frequency

### Example Changing the call frequency to 433.20 MHz

#### Procedure

- 1) In the VFO mode, select the frequency you wish to store in call memory.

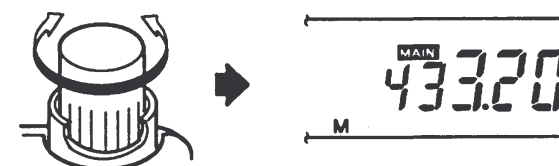

- 2) Hold down the FUNC key and press the D V/M ENT key.  
M- - appears on the display.

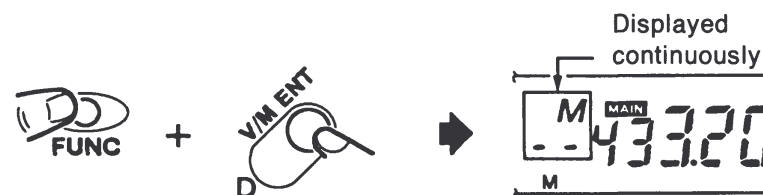

- 3) Press the CALL key.  
A “peep” (long high pitched beep) sounds and the new frequency is assigned to the call memory.



---

## 1 Changing the Frequency from the Call Mode

### Procedure Changing the frequency from the call mode

- 1) Hold down the FUNC key and press the 3 SFT key.  
C flashes on and off on the display.

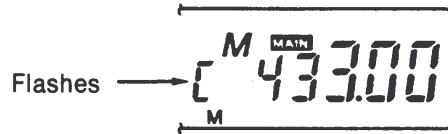

- 2) Change the frequency in the usual manner. (See page 12.)
- 3) Press the A CL PS key. The C indication stops flashing and the previous call frequency display returns.  
(Pressing the 3 SFT key while holding down the FUNC key also causes the C indication to stop flashing and the previous call frequency display to return.)

### ADVICE

- If the D V/M ENT key is pressed with the FUNC key held down, the changed frequency is recorded as the new call frequency.



# Dual Watch Function

- The dual watch function allows you to receive signals on two frequencies alternately.  
The dual watch function lets you monitor one of the memory frequencies (M00 – M19) or the call frequency and the VFO frequency alternately.
- During dual watch operation, the VFO frequency appears on the display, but once every three seconds the memory frequency is received (and appears on the display).  
This status is referred to as the dual watch mode.

## 1 Types of Dual Watch Operation

- The following four types of dual watch operation are possible.
  - (1) Dual watch using the address number M00 frequency and the VFO frequency



- (2) Dual watch using an address number frequency of your choice and the VFO frequency

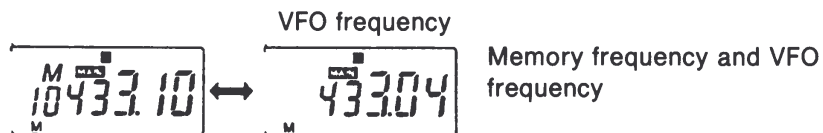

- (3) Dual watch using the call frequency and the VFO frequency

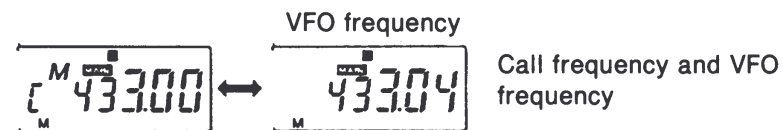

- (4) Dual watch using the memory scan frequency and the VFO frequency  
(See page 51 for details of the memory scan function.)

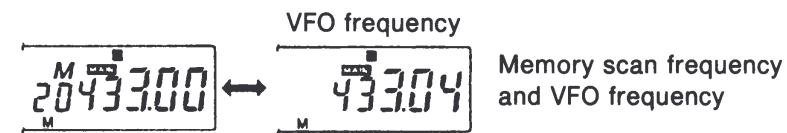

## 2 Dual Watch Operation Instructions

### 1 Using the Address Number M00 Frequency and the VFO Frequency

#### Procedure

- 1) Store one of the frequencies you wish to use for dual watch operation in memory at address number M00.

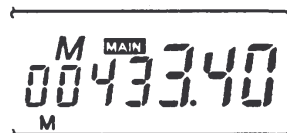

- 2) In the VFO mode, select the other frequency.

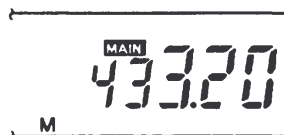

- 3) While still in the VFO mode, hold down the FUNC key and press the 2 DUAL key. The **D** indication appears on the display and dual watch operation commences using the M00 frequency and the VFO frequency.

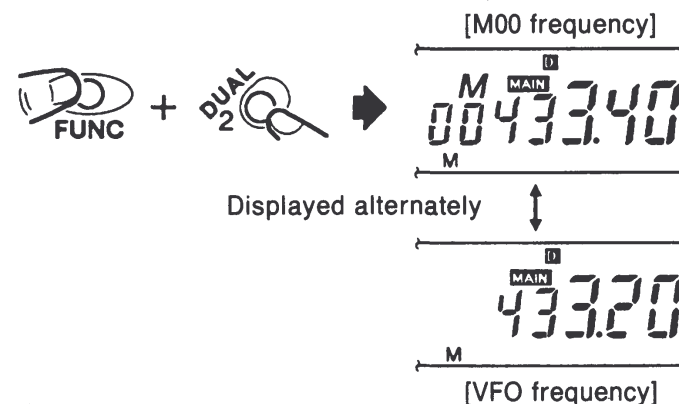

#### NOTE

- If you attempt to activate the dual watch mode with no frequency assigned to memory address number M00, a "boo" (short low pitched beep) sounds and dual watch mode is cancelled.

---

## 2 Using an Address Number Frequency of Your Choice and the VFO Frequency

### Procedure

- 1) In the VFO mode, select the first dual watch frequency.
- 2) In the memory mode, call up a memory address number with a frequency assigned as the second dual watch frequency (or store a frequency in memory).
- 3) While still in the memory mode, hold down the FUNC key and press the 2 DUAL key.  
The **D** indication appears on the display and dual watch operation commences using the memory address number frequency of your choice and the VFO frequency.

### NOTE

- If you attempt to activate the dual watch mode with no frequency assigned to memory address you select, a “boo” (short low pitched beep) sounds and dual watch mode is cancelled.

## 3 Using the Call Frequency and the VFO Frequency

### Procedure

- 1) In the VFO mode, select the first dual watch frequency.
- 2) Press the CALL key.
- 3) Hold down the FUNC key and press the 2 DUAL key.  
The **D** indication appears on the display and dual watch operation commences using the call frequency and the VFO frequency.

## 4 Using the Memory Scan Frequency and the VFO Frequency

### Procedure

- 1) In the VFO mode, select the first dual watch frequency.
- 2) Press the C MS MS.M key to activate the memory scan mode.
- 3) Hold down the FUNC key and press the 2 DUAL key.  
The **D** indication appears on the display and memory scan takes place along with dual watch operation with the VFO frequency.

### ADVICE

- (1) If you attempt to activate the dual watch mode with no frequency assigned to the memory address you select, a “boo” (short low pitched beep) sounds and dual watch mode is cancelled.
- (2) If a signal is being received on the memory frequency, dual watch operation is temporarily suspended. (Dual watch operation resumes when the signal is lost.)
- (3) Dual watch operation does not pause while the VFO frequency is being received. This means that transmissions may be interrupted midway and is not a malfunction.

---

### 3 Communicating with Other Stations when in the Dual Watch Mode

**Procedure**      **Communicating with other stations when in the dual watch mode**

- 1) To communicate on the VFO frequency, press the A CL PS key to cancel dual watch operation.
- 2) To communicate on the memory frequency, press the D V/M ENT key twice to switch to the memory mode.

### 4 Cancelling Dual Watch Mode

**Procedure**      **Cancelling dual watch**

- Press the A CL PS key or hold down the FUNC key and press the 2 DUAL key.

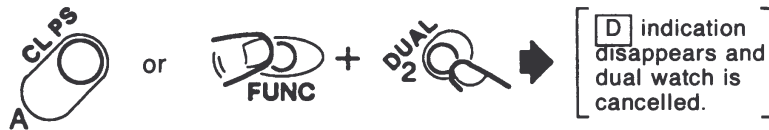

# DTMF Operation

## 1 DTMF Memory Function

- You can store strings of up to 15 characters including 0 – 9, A – D, \* and # in memory for later transmission as DTMF codes.
- There are 10 DTMF memory address numbers numbered 0 – 9.
- DTMF memory display

[Input example] (Up to 15 characters)

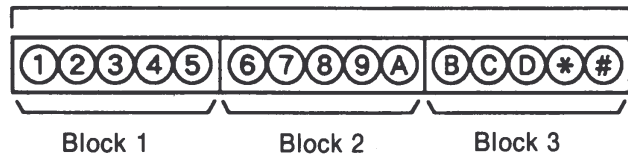

- The 15 DTMF characters are divided into three blocks, each containing five characters.
- One block can be displayed at a time. You can confirm which block is being displayed by referring to the block number indication on the display.

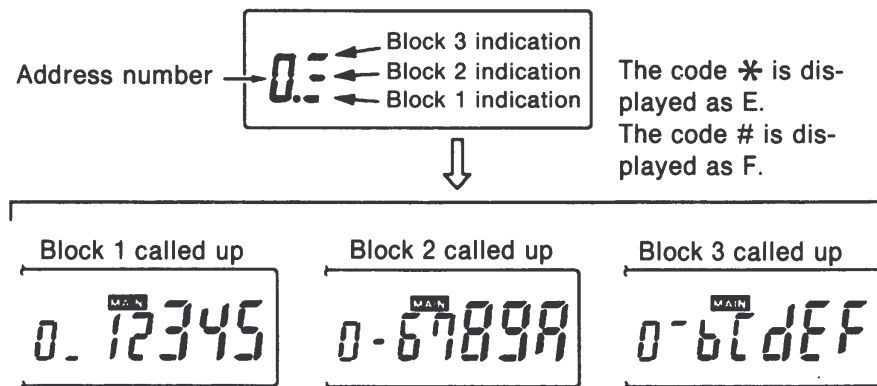

## 2 Storing DTMF Codes in Memory

### Procedure: Storing codes in memory

- 1) Hold down the FUNC key and press the DTMF.M key. The last DTMF memory address number used is displayed. (The DTMF memory address number is set to 0 when the unit is shipped from the factory.) Block 1 is displayed.

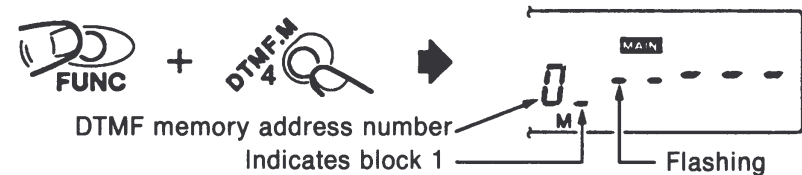

- 2) Select the desired DTMF memory address number using the rotary channel selector. A “puff” (short low pitched beep) sounds if you select DTMF memory address number 0. The ▲ and ▼ keys cannot be used to select DTMF memory address numbers because they are used as the E and F keys for this function.
- 3) Input the code to be stored in memory using the numeric keys. The \* character is displayed as an E, and the # as an F.
- 4) When input is finished, hold down the FUNC key and press the D V/M ENT key. A “peep” (long high pitched beep) sounds and the code is stored in memory. If you input a code a full 15 characters long, a “peep” (long high pitched beep) sounds when the 15th character is entered and the code is stored in memory automatically, so there is no need in this case to perform step 4).

Continues on next page →

- 5) To return to the frequency display, hold down the FUNC key and press the DTMF.M key.

**NOTE**

- If you input a code a full 15 characters long, do not perform step 4). Doing so would result in the following.



This display appears and the DTMF memory is erased.

**ADVICE**

- (1) Hold down the FUNC key and press the ▲ or ▼ key to switch the display between the different blocks.

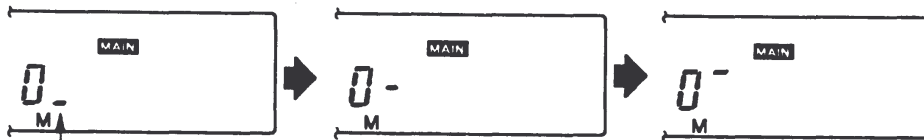
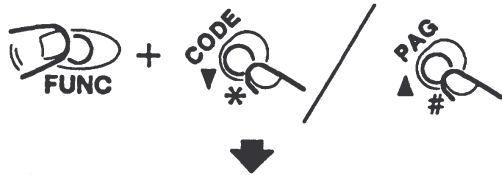

Block display changes, allowing you to check the contents of DTMF memory.

### 3 Deleting DTMF Codes from Memory

**Procedure**     **Deleting codes**

- 1) Select the DTMF memory address number you wish to delete using the rotary channel selector.

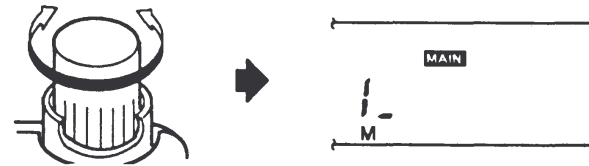

- 2) Hold down the FUNC key and press the D V/M ENT key.



- 3) CLR appears on the display. To delete the code, once again hold down the FUNC key and press the D V/M ENT key. A "peep" (long high pitched beep) sounds and the code is erased from memory.

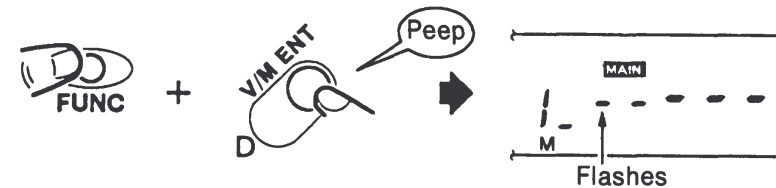

**ADVICE**

- Press the A CL PS key to return to the VFO display without erasing the contents of DTMF memory.

## 4 DTMF Memory Transmission (Set Mode Status)

**Example** Transmitting the code assigned to DTMF memory address number 5.

**Procedure**

- 1) Activate the set mode. Set DTMF memory send nb/dtm to dtm.

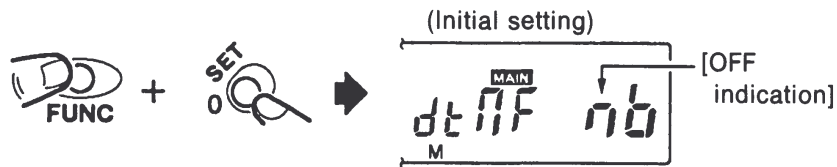

nb: When in the transmit mode, pressing one of the 0 – 9, A, B, C, D, # or \* keys causes the DTMF code corresponding to the key to be transmitted for as long as the key is held down.

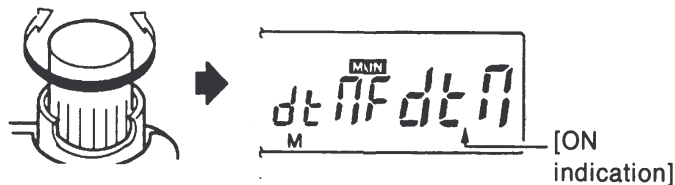

dtn: When in the transmit mode, pressing one of the 0 – 9 keys causes the contents of DTMF memory to be transmitted. If a key corresponding to a DTMF memory address with nothing assigned to it is pressed, no DTMF signal is transmitted.

- 2) Press the PTT switch to return to the frequency display. Press the numeric key corresponding to the address number of the DTMF code you wish to transmit.



The DTMF code stored at address number you entered is transmitted.

- 3) Release the PTT switch.

**NOTE**

- Once transmission of the DTMF memory code begins, the PTT switch can be released with no ill effects. (The full DTMF memory code will be sent regardless.)

# Other Functions (1) (Functions Accessed by Holding Down the FUNC Key and Pressing Another Key)

- The C558 is equipped with many functions in addition to those already described. These other functions are accessed by pressing combinations of keys.
- The functions described on the following pages can be accessed by holding down the FUNC key and pressing another key. (See page 15 for a description of basic functions.)

## 1 Output Level Switching

- The transmission output power level can be switched between (H) high, (M) medium and (L) low power, in that order. Choose the output power level most suited to the application.
  - High: High power output
  - Medium: Medium power output
  - Low: Low power output

### Procedure

- Hold down the FUNC key and press the 1 PO key. The M indication on the display changes to an L, and next to an H.

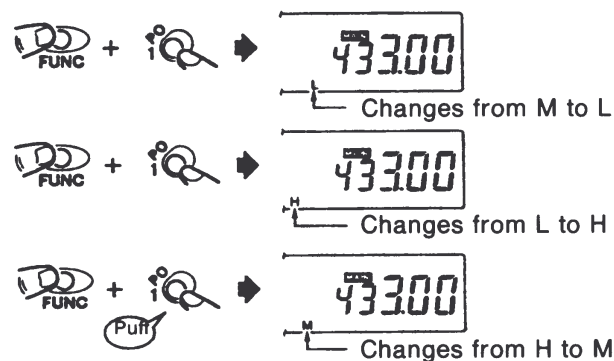

### ADVICE

- The factory setting is M (medium power).

## 2 Frequency Lock Operation (Keyboard lock)

- This function disables key input to prevent errors caused by inadvertently pressing the wrong key while communicating with another station. Note that it is possible to set up the unit so that the rotary channel selector still works even when frequency lock is on. (See page 75 for details.)

### Procedure

#### Activating frequency lock

- 1) Hold down the FUNC key and press the 6 FL key. An FL appears on the display, indicating that frequency lock is active.



- 2) To cancel frequency lock, hold down the FUNC key and press the 6 FL key a second time. The FL indication disappears from the display and frequency lock is deactivated.



### 3 Continuous Illumination Function

#### Procedure Switching on continuous display illumination

- 1) Hold down the FUNC key and press the LAMP key.  
The display is illuminated continuously.
- 2) To cancel continuous display illumination, once again hold down the FUNC key and press the LAMP key.

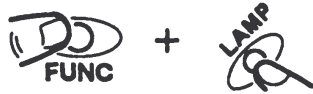

### 4 Disabling Transmission when the PTT Switch is Pressed

#### Procedure Preventing accidental transmissions

- 1) Hold down the FUNC key and press the CALL P.L key.  
The P.L indication appears on the display and the PTT switch is disabled.

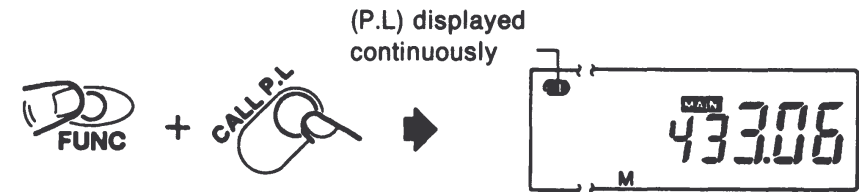

- 2) To cancel, once again hold down the FUNC key and press the CALL P.L key.

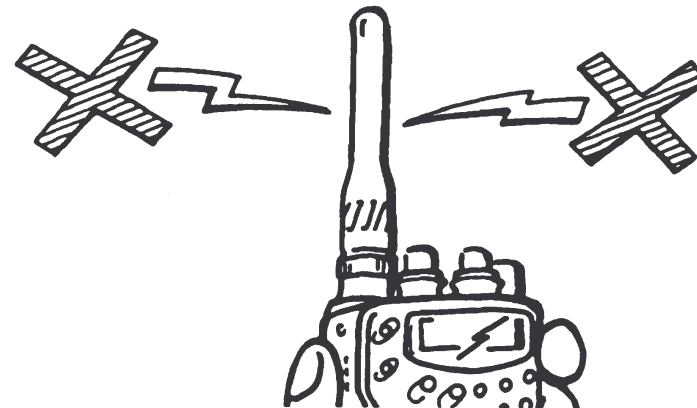

## Other Functions (2) (Functions Accessed from the Set Mode)

### ■ Set mode status

The set mode is used to make settings and select values for 28 (22 for C558S) different commands, including tuning step setting.

#### Procedure

- 1) Press the B V/U MONO key to make the band you wish to make (change) settings for the main band.

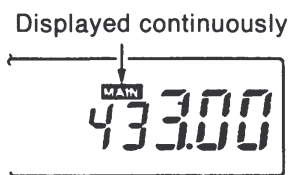

- 2) Hold down the FUNC key and press the 0 SET key.

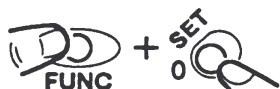

- 3) Use the ▲ and ▼ keys to select the menu for the setting you wish to make (change).  
(See page 18 for a list of available menus.)

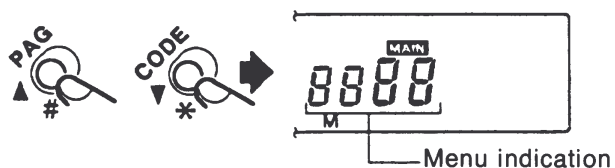

- 4) After making a setting, press the A CL PS key to return to the previous display, or again use the ▲ and ▼ keys to select another menu. When all settings are finished, press the A CL PS key.



## 1 Changing the Tuning Steps

### Procedure Changing the tuning steps

- 1) Switch to the set mode.
- 2) Use the ▲ and ▼ keys to select St 10.

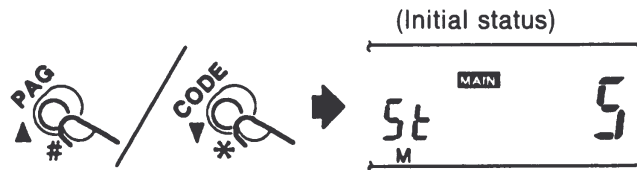

- 3) Use the rotary channel selector to select the tuning step setting of your choice.

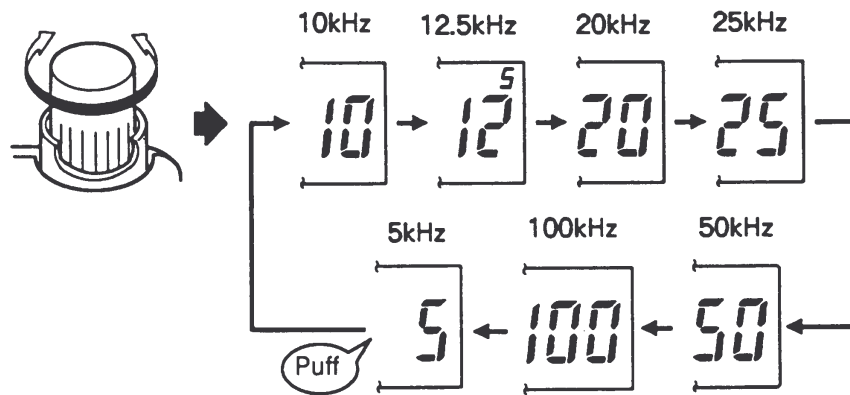

- 4) After making a setting, press the A CL PS key to return to the previous frequency display.

## 2 Switching Between Internal and External Speakers

- If an optional external speaker is connected to the unit, this function can be used to switch between it and the transceiver's built-in internal speaker.

### Procedure Switching speakers

- 1) Switch to the set mode.
- 2) Use the ▲ and ▼ keys to select SP 11.



Continues on next page →

- 3) Use the rotary channel selector to select the speaker setting of your choice.

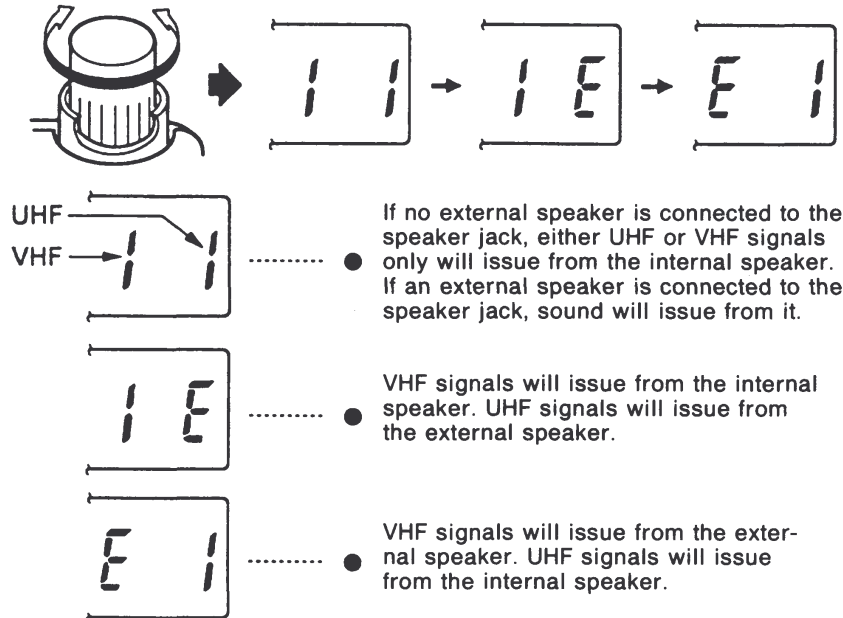

- 4) After making a setting, press the A CL PS key to return to the previous frequency display.

### 3 Battery Save Function

- This function reduces the amount of current consumed when waiting for calls in receiving status. Leaving the transceiver in receiving status for an extended period of time will run down the batteries. When save operation is activated, the transceiver receives only at specified intervals a few seconds long.
- The interval can be set to any of the following 10 settings: OFF, 0.25, 0.5, 0.75, 1, 1.5, 2, 3, 5, 7 and 10 seconds. Selecting OFF disables the battery save function.

#### Procedure **Selecting the interval**

- 1) Switch to the set mode.
- 2) Use the ▲ and ▼ keys to select SA OFF.

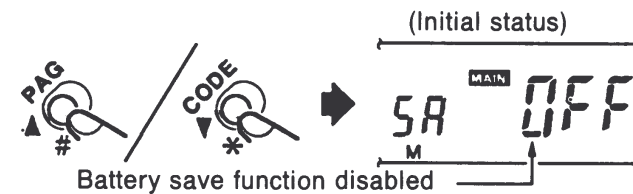

Continues on next page →

- 3) Use the rotary channel selector to select the setting of your choice.

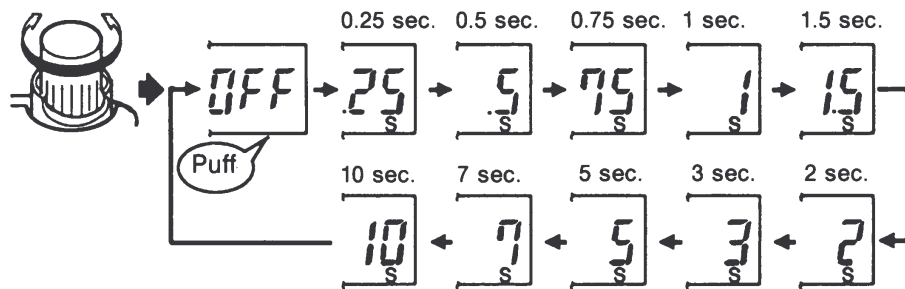

- 4) After making a setting, press the A CL PS key to return to the previous frequency display.

## 4 Reception Attenuator (Sensitivity) On/Off Function

- Turning this function on reduces the reception sensitivity by approximately 15 dB.

### Procedure Using the attenuator

- Switch to the set mode.
- Use the ▲ and ▼ keys to select Att OFF.

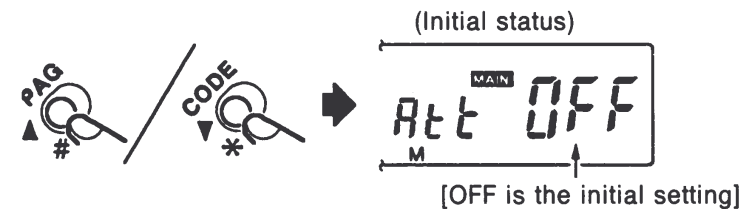

- Use the rotary channel selector to select the setting of your choice.

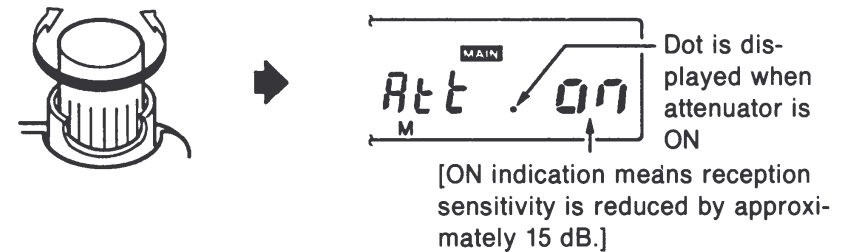

- After making a setting, press the A CL PS key to return to the previous frequency display.

## 5 Dual Watch Speed Selection Function

### Procedure

- 1) Switch to the set mode.
- 2) Use the ▲ and ▼ keys to select duSP nor.

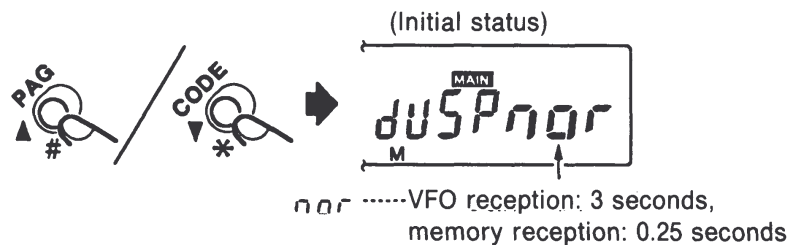

- 3) Use the rotary channel selector to select the setting of your choice.



- 4) After making a setting, press the A CL PS key to return to the previous frequency display.

## 6 Setting the ▲ and ▼ Keys to 10 MHz Tuning Steps

(Function not available on the C558S.)

- Setting this function to 10 changes the tuning step size for the ▲ and ▼ keys to 10 MHz.

### Procedure

- 1) Switch to the set mode.
- 2) Use the ▲ and ▼ keys to select Ud10 nor.



- 3) Use the rotary channel selector to select the setting of your choice.

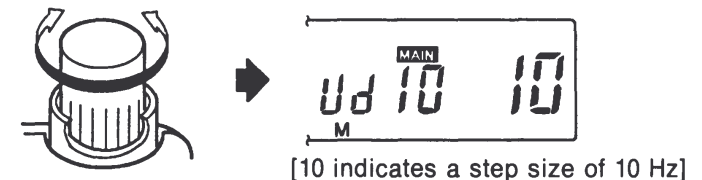

- 4) After making a setting, press the A CL PS key to return to the previous frequency display.
- 5) Pressing the ▲ or ▼ key now causes the frequency setting to change in 10 MHz steps.

## 7 1 kHz Column Input Function

- Turning this function on enables 1 kHz column input.

### Procedure Enabling or disabling 1 kHz column input

- Switch to the set mode.
- Use the ▲ and ▼ keys to select inP1 OFF.

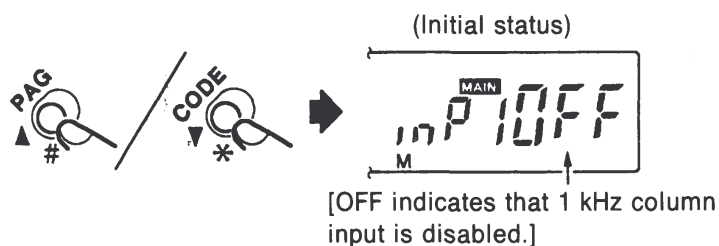

- Use the rotary channel selector to select the setting of your choice.

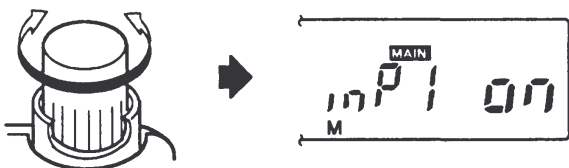

- After making a setting, press the A CL PS key to return to the previous frequency display.

### NOTE

- Based on the 10 kHz or 1 kHz column input selected using this setting, the transceiver automatically displays a frequency compensated as required.

## 8 Auto Power Off Function

- When this function is active, the power switches off automatically if the unit is left unattended and nothing is received for approximately 30 minutes. It has the same effect as manually switching the power off. The contents of the memory unit are unaffected when the auto power off function is triggered.

### Procedure To use the auto power off function

- Switch to the set mode.
- Use the ▲ and ▼ keys to select APO OFF.

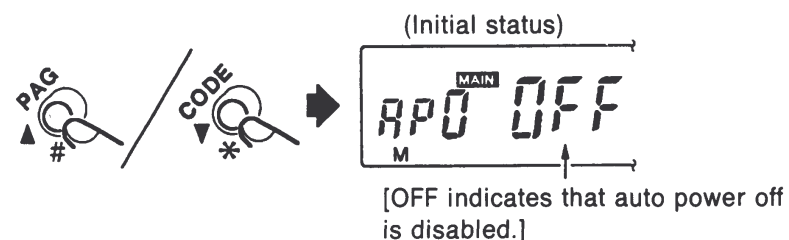

- Use the rotary channel selector to select the setting of your choice.

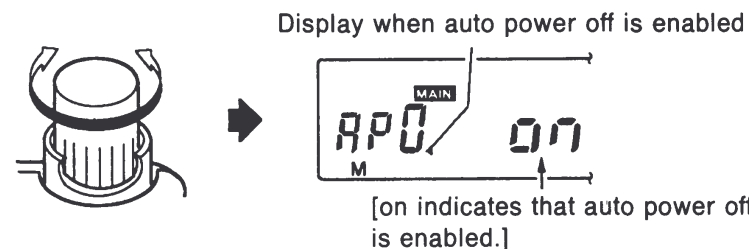

- After making a setting, press the A CL PS key to return to the previous frequency display.

## 9 Memory Unit All Reset On/Off Function

- This function erases the memory contents completely. Once this has been done, there is no way to restore the memory data. Therefore, you should make sure you know what data the memory contains before performing all reset.

### Procedure Performing all reset

- 1) Switch to the set mode.
- 2) Use the ▲ and ▼ keys to select rES OFF.

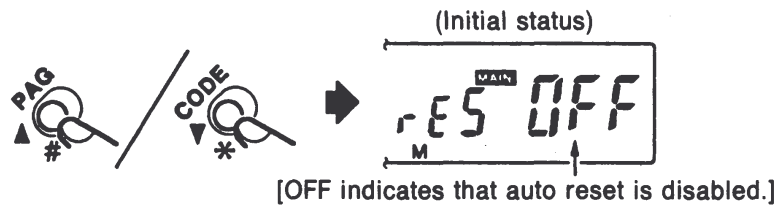

- 3) Use the rotary channel selector to select the tuning step setting of your choice.

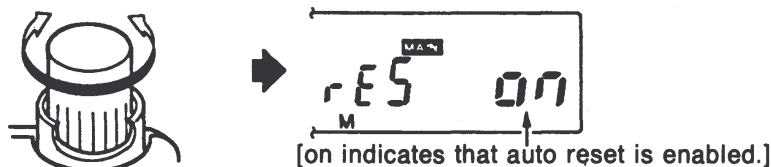

- 4) Hold down the FUNC key and press the POWER switch.



- 5) The factory settings are restored.

## 10 DTMF Transmission Speed Selection

- DTMF signals are normally transmitted with an interval of 50 msec. between digits. This function allows you to change this interval to 100 msec.

### Procedure To set the transmission speed to 50 or 100 msec.

- 1) Switch to the set mode.
- 2) Use the ▲ and ▼ keys to select dtSP nor.

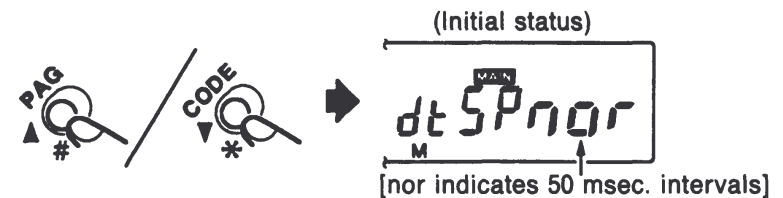

- 3) Use the rotary channel selector to select the setting of your choice.

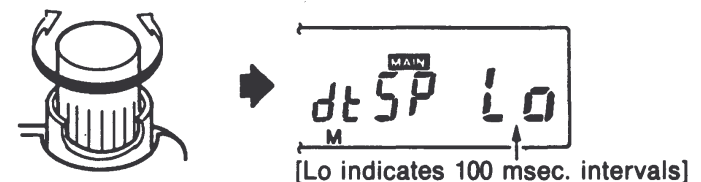

- 4) After making a setting, press the A CL PS key to return to the previous frequency display.



## 11 Repeater and Paging Transmission Delay Time Selection

- This function is useful for using the paging function via repeater stations with slow access times. It allows you to change the interval from when the PTT switch is pressed to when a paging code is transmitted from 450 msec. to 750 msec.

### Procedure Changing the delay from 450 msec. to 750 msec.

- 1) Switch to the set mode.
- 2) Use the ▲ and ▼ keys to select PAt 450.

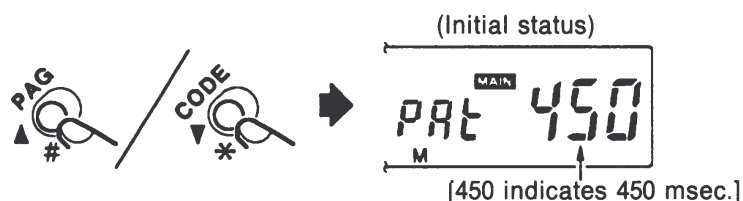

- 3) Use the rotary channel selector to select the setting of your choice.

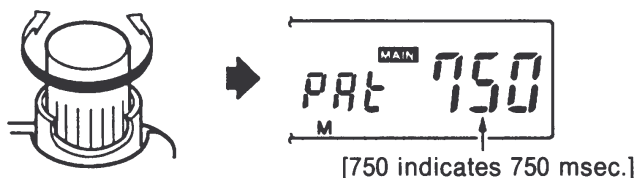

- 4) After making a setting, press the A CL PS key to return to the previous frequency display.

## 12 Suppressing Audio Output when Paging Codes Match

- When this function is set to ON, repeated high pitched beeps (pip-pip-pip-pip-pip) sound when paging codes match and no audio output is produced.

### Procedure Suppressing audio output

- 1) Switch to the set mode.
- 2) Use the ▲ and ▼ keys to select PA- OFF.

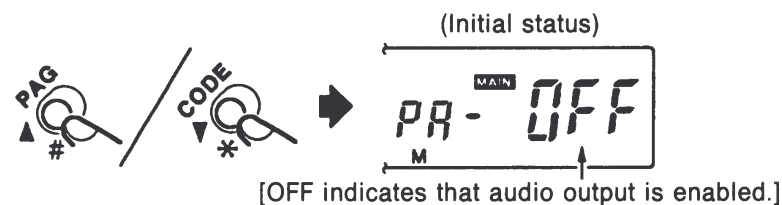

- 3) Use the rotary channel selector to select the setting of your choice.

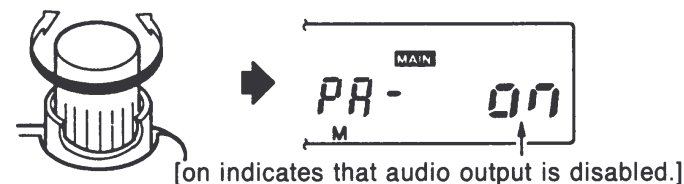

- 4) After making a setting, press the A CL PS key to return to the previous frequency display.

## 13 Selecting the Number of Beeps During Paging Operation

- Setting this function to 1 causes only one set of beeps (pip-pip-pip-pip) to sound when the transceiver is called in the paging mode.

### Procedure Switching from five to one set of beeps

- Switch to the set mode.
- Use the ▲ and ▼ keys to select PAbZ 5.

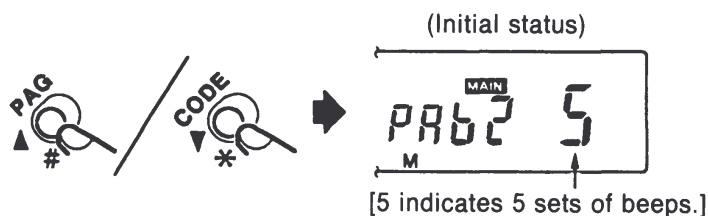

- Use the rotary channel selector to select the setting of your choice.

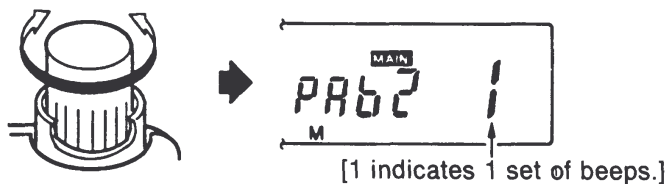

- After making a setting, press the A CL PS key to return to the previous frequency display.

## 14 Turning the Beep On and Off

- Setting this function to OFF disables the beep.

### Procedure Disabling the beep

- Switch to the set mode.
- Use the ▲ and ▼ keys to select bZ on.

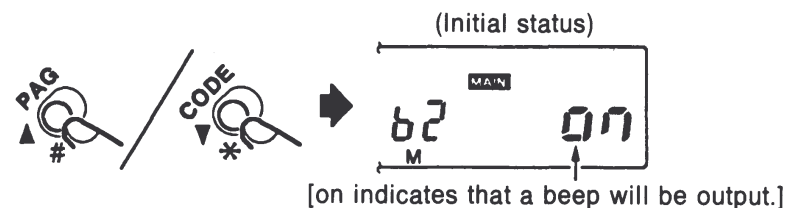

- Use the rotary channel selector to select the setting of your choice.

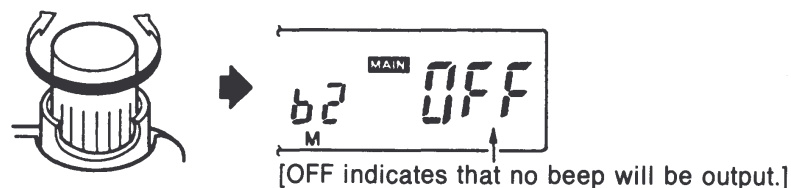

- After making a setting, press the A CL PS key to return to the previous frequency display.

## 15 Turning Off Sub Band Audio Output During Reception

- Setting this function to ON disables sub band audio output.

### Procedure Disabling sub band audio output

- 1) Switch to the set mode.
- 2) Use the ▲ and ▼ keys to select MUT E OFF.

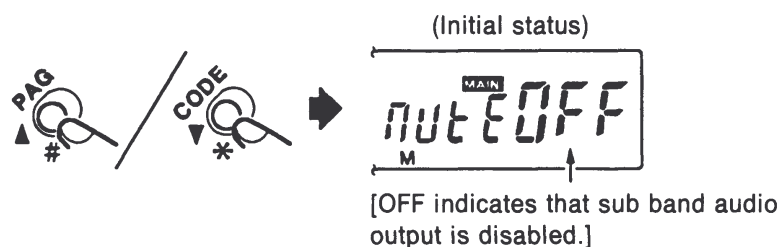

- 3) Use the rotary channel selector to select the setting of your choice.

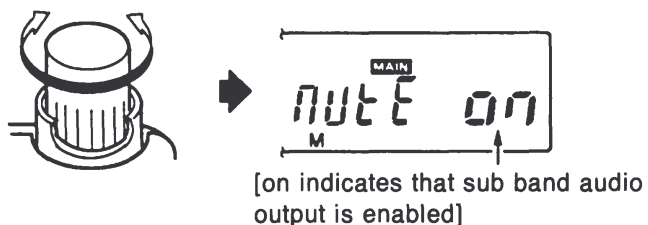

- 4) After making a setting, press the A CL PS key to return to the previous frequency display.

## 16 Reducing Squelch Pop Noise

- Setting this function to ON reduces the volume of the pop heard when squelch disengages.

### Procedure Reducing pop noise

- 1) Switch to the set mode.
- 2) Use the ▲ and ▼ keys to select Moni OFF.



- 3) Use the rotary channel selector to select the setting of your choice.

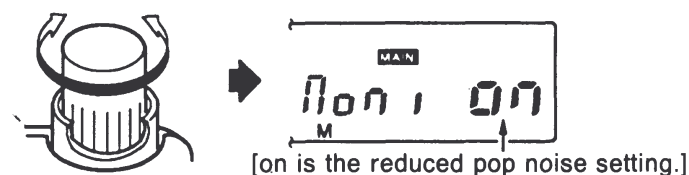

- 4) After making a setting, press the A CL PS key to return to the previous frequency display.

## 17 Enabling the Rotary Channel Selector in the Frequency Lock Mode

- Many of the operation keys are disabled when the unit is in key lock status. This function allows use of the rotary channel selector even when key lock is on.

### Procedure Enabling or disabling the rotary channel selector

- Switch to the set mode.
- Use the ▲ and ▼ keys to select FLCH OFF.

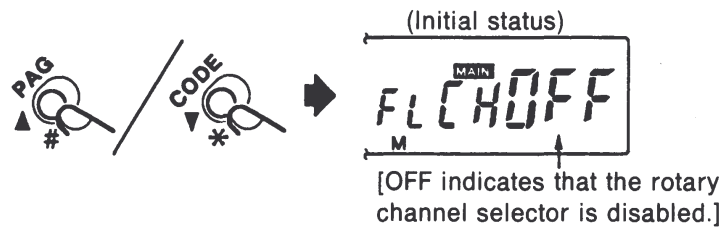

- Use the rotary channel selector to select the setting of your choice.

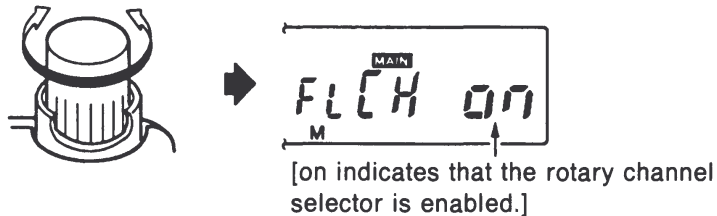

- After making a setting, press the A CL PS key to return to the previous frequency display.

## 18 Setting Tuning Steps for the Rotary Channel Selector when the FUNC Key is Held Down

- By turning this function on, the tuning step size when the FUNC key is held down and the rotary channel selector turned can be changed to 1 MHz.

### Procedure Enabling or disabling 1 MHz tuning steps

- Switch to the set mode.
- Use the ▲ and ▼ keys to select CH1 OFF.

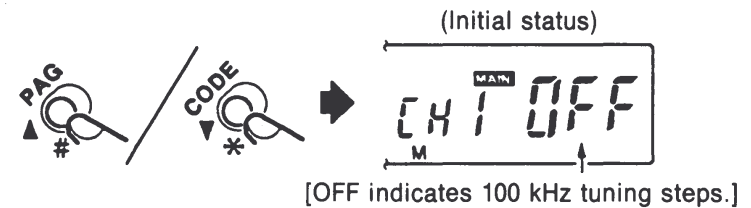

- Use the rotary channel selector to select the setting of your choice.

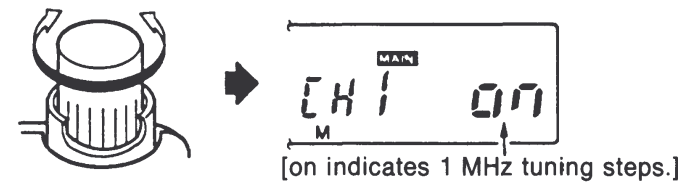

- After making a setting, press the A CL PS key to return to the previous frequency display.

## 19 Clone Mode

(Function not available on the C558S.)

- This function uses DTMF signals to copy the contents of one C558 transceiver to another.

### Procedure

- 1) Switch to the set mode.
- 2) Use the ▲ and ▼ keys to select CLn OFF.

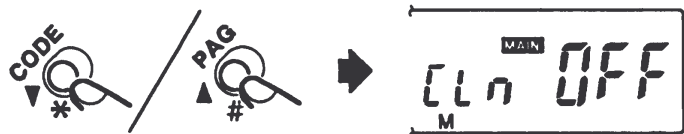

- 3) Use the rotary channel selector to select ON. The previous VFO frequency then reappears on the display.
- 4) Perform steps 1) through 3) above on the transceiver to which the memory data is to be copied.
- 5) Hold down the FUNC key at the reception side and press the # ▲ PAG key to switch to the paging mode.
- 6) Press the PTT switch on the transceiver from which the memory data is to be copied to start the transmission of DTMF signals. These signals are received by the target transceiver, and after about four minutes the copying process is complete.

### NOTE

If due to unfavorable environmental conditions the copying process is not completely successful, the target transceiver may not function properly.

## 20 Remote Mode

(Function not available on the C558S.)

- If the remote mode is turned on, the unit can be switched to any memory mode by sending the appropriate DTMF signal to it from another station. Fixed duration transmission status can also be activated in this way.

### Procedure

- 1) Switch to the set mode.
- 2) Use the ▲ and ▼ keys to select rMt OFF.
- 3) Use the rotary channel selector to select the ON setting.
- 4) Press the A.CL.PS key to return to the previous frequency display.
- 5) Switch to the paging mode and wait to receive a transmission.
- 6) The display of the unit changes to one of the memory modes when a DTMF signal such as the following is received.

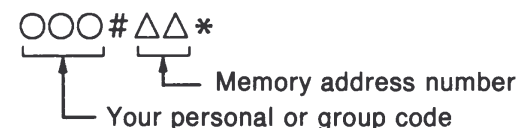

- 7) Fixed duration transmission status is activated when a DTMF signal such as the following is received. The maximum duration is approximately 200 seconds.

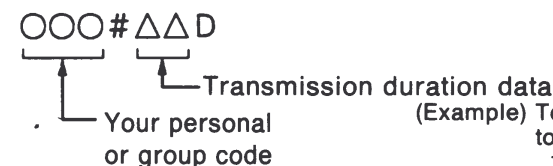

(Example) To set the duration to approximately:

- 10 seconds, send C3
- 20 seconds, send B7
- 30 seconds, send AD
- 60 seconds, send \*5
- 90 seconds, send 8C
- 120 seconds, send 6D
- 180 seconds, send 1C
- 200 seconds, send 00

## 21 Decode Mode

(Function not available on the C558S.)

- If the decode mode is on in the paging mode, it will be possible to read in data even if the codes of the sending and receiving transceivers do not match.

### Procedure

- 1) Switch to the set mode.
- 2) Use the ▲ and ▼ keys to select dEC OFF.
- 3) Use the rotary channel selector to select the ON setting.
- 4) After making a setting, press the A CL PS key to return to the previous frequency display.
- 5) Switch to the paging mode and wait to receive a transmission.
- 6) If the received code does not match the code set on your transceiver, the received code is read into memory as follows.

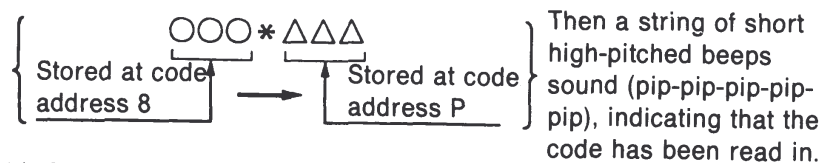

- 7) Examine the contents of code addresses 8 and P to analyze the code which was received.

### NOTE

If the codes do match, normal paging operation takes place.

## 22 Setting the Delay Time for Cross-band Repeater Transmissions

(Function not available on the C558S.)

- When this function is set to ON during cross-band repeater communication, the repeater function stays off for two seconds after the received signal ceases.

### Procedure

- 1) Switch to the set mode.
- 2) Use the ▲ and ▼ keys to select rPtt OFF.
- 3) Use the rotary channel selector to select the ON setting.
- 4) After making a setting, press the A CL PS key to return to the previous frequency display.

## 23 Cross-band Repeater

(Function not available on the C558S.)

- When this function is set to ON, the transceiver can be used to communicate with one transceiver in the 144 MHz band and another transceiver in the 430 MHz band at the same time.

### Procedure

- 1) Switch to the set mode.
- 2) Use the ▲ and ▼ keys to select rPt OFF.
- 3) Use the rotary channel selector to select the ON setting.
- 4) After making a setting, press the A CL PS key to return to the previous frequency display.  
When the cross-band repeater mode is turned on, a dot is displayed at the lower right-hand corner of the 10 kHz column of the 144 MHz band display.

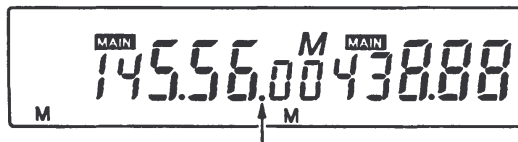

Cross-band repeater mode indication

- 5) When a signal is being received on either the 144 MHz or 430 MHz band, you can transmit on the other band.
- 6) To cancel the cross-band repeater mode, press the V/U key or switch to the set mode.

## 24 AM Mode Function

(Function not available on the C558S.)

- In the AM mode the transceiver can be used to receive AM signals. Normally the FM mode is used, but the setting can be changed if desired. This function can only be used with the 144 MHz band.

### Procedure

- 1) Switch to the set mode.
- 2) Use the ▲ and ▼ keys to select AM OFF.



- 3) Use the rotary channel selector to select the setting of your choice.



- 4) After making a setting, press the A CL PS key to return to the previous frequency display.
- 5) An A is displayed in the 100 MHz column, indicating that AM reception has been enabled.

### NOTE

Transmission is always FM, even if the AM mode has been enabled.

# Troubleshooting

---

## ★Power won't turn on.

☆Are the batteries dead?

## ★The mark is displayed continuously.

☆The batteries are low.  
(Replace them as soon as possible.)

## ★The factory settings are restored every time the power is turned off and then on again.

☆Confirm that the CMU160 or CMU161 is properly installed.

## ★Can't receive signals.

☆Press the SQL OFF key and check whether sound issues from the speaker.

☆Is the squelch knob turned all the way clockwise?  
(Turn it counterclockwise.)

☆Is tone squelch turned on?  
(Turn it off.)

☆Is the volume knob turned all the way counterclockwise?  
(Turn the volume knob clockwise until the desired volume setting is reached.)

☆Is the paging or code squelch function turned on?  
(Turn paging or code squelch off.)

☆Is speaker output set to external?  
(Change the setting from E to I.)

## ★Can only receive strong signals.

☆Is the antenna mounted properly?  
(Mount it properly.)

☆Is the squelch knob turned too far clockwise?  
(Turn it counterclockwise.)

☆Is the attenuator function turned on?  
(Turn it off.)

## ★Can't transmit.

☆Is the P.L indication visible on the display?  
(Hold down the FUNC key and press the CALL PL key to cancel PTT lock.)

☆Is the band you wish to transmit on specified as the main band?  
(Press the D U/V MONO key to make the band you wish to transmit on the main band.)

☆Is the repeater mode frequency setting off band?  
(Reset the frequency to one that is not off band.)

## ★Can only transmit on the call frequency.

☆Is the C indication visible on the display?  
(Press the CALL key again to return to the dial frequency.)

## ★The unit transmits on a frequency other than the one displayed.

☆Is a + or – indication displayed continuously?  
(The send and receive frequencies are different during repeater operation.)



---

★**Can't change the frequency.**

- ☆ Is the FL indication displayed continuously?  
(Hold down the FUNC key and press the 6 FL key to cancel frequency lock.)

★**Beep doesn't sound.**

- ☆ Is the beep turned off?  
(Switch to the set mode and turn the beep back on. See page 73 for instructions.)
- ☆ Is the volume knob turned all the way counterclockwise?  
(Turn the volume knob clockwise until the desired volume setting is reached.)

★**Can only change frequencies using the rotary channel selector.**

- ☆ Is the FL indication visible on the display?  
(Hold down the FUNC key and press the 6 FL key to cancel frequency lock.)

★**Can't store data in memory.**

- ☆ Is the CMU160 or CMU161 properly installed?
- ☆ Perform all reset to make the memory unit usable by the C558.  
(See page 71 for instructions on performing all reset.)
- ☆ Is the memory protect function turned on?  
(See page 46 for instructions on turning it off.)

# Specifications

## ● General Specifications

Frequency range	VHF : 144.0 — 147.995MHz UHF : 430.0 — 439.995 MHz
Radio wave type	F3
Microphone input impedance	600 Ω
Speaker impedance	8 Ω
Operating voltage range	6 — 16 V
Rated voltage	7.2 V
Current consumption:	
Transmitting (at 13.8 V)	
High (5 W)	Approx. 1,300 mA (UHF) Approx. 1,200 mA (VHF)
Medium (2.5 W)	Approx. 1,000 mA (UHF) Approx. 900 mA (VHF)
Transmitting (at 7.2 V)	
High (2 W)	Approx. 1,000 mA (UHF) Approx. 850 mA (VHF)
Medium (2 W)	Approx. 1,000 mA (UHF) Approx. 850 mA (VHF)
Transmitting at 13.8/7.2 V: Low (350 mW)	Approx. 480 mA (UHF) Approx. 400 mA (VHF)
Receiving (twin mode)	Approx. 70 mA
(mono mode)	Approx. 45 mA (UHF) Approx. 36 mA (VHF)
Battery save operation (twin mode)	Approx. 25 mA
(mono mode)	Approx. 18 mA (UHF) Approx. 17 mA (VHF)
Auto power off operation	Approx. 0.2 mA
Body dimensions (including batteries, excluding protrusions)	55 W x 130 H x 31 D mm
Weight (including antenna and batteries)	355 g

## ● Reception

Reception type	Double super heterodyne
Intermediate frequencies	1st IF: 21.80 MHz (VHF), 2nd IF: 450 kHz 1st IF: 23.05 MHz (UHF), 2nd IF: 450 kHz
Reception sensitivity	0.158 μV
S/N ratio at 0.5 V input	30 dB or better
Squelch open sensitivity	0.1 μV
Audio frequency output	200 mW (8 Ω, 10 % distortion)

## ● Transmission

Output	
High:	
With CBT151	1.5 W (UHF) 2.0 W (VHF)
With CNB151/153	2.0 W (UHF) 2.5 W (VHF)
With CNB152	5.0 W (UHF) 5.0 W (VHF)
Medium:	
With CBT151	1.5 W (UHF) 2.0 W (VHF)
With CNB151/153	2.0 W (UHF) 2.5 W (VHF)
With CNB152	2.5 W (UHF) 2.5 W (VHF)
Low	0.35 W (VHF/UHF)
Modulation method	Reactance modulation
Maximum frequency deviation	±5 kHz
Spurious ratio	-60 dB or better
Built-in microphone	Electret condenser type

- The specifications and external appearance of the unit are subject to change without notice due to product improvements.

# Mounting the Optional CTN160

## Procedure

- 1) Remove the supplied antenna and battery case from the unit.

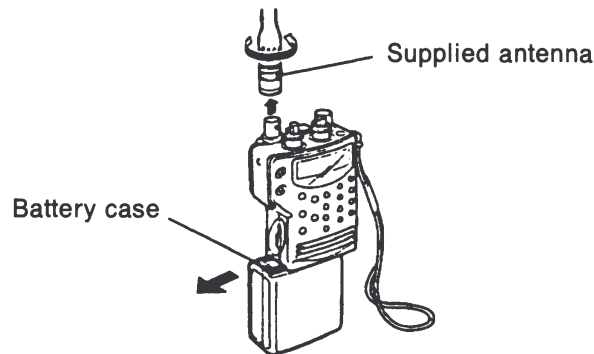

- 2) Remove the two screws (2 mm x 3) from the bottom of the transceiver as shown in the diagram.
- 3) Remove the two screws (2 mm x 18) holding the cover in place. (Be careful not to misplace the release lever.)

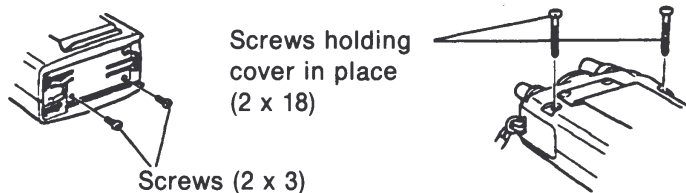

- 4) With the control panel (the side with the display on it) facing upward, grasp the portion of the case that includes the control panel and gently open it to the right.

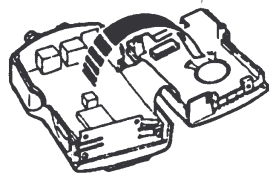

## NOTE

- (1) Do not try to open the case to the left and do not force it open, as this could damage the flexible circuit board inside.
- (2) There is a flexible circuit board inside the unit, facing the keyboard on the right side. Do not pull hard on the case or you might damage it.
- 5) As shown in the diagram, position the CTN160 so that the microprocessor board is facing upward and slide it into the connector.

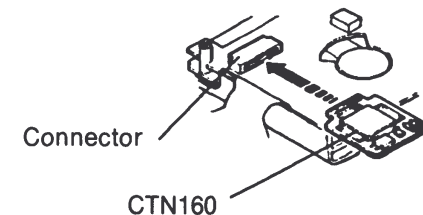

## NOTE

- (1) Plug the CTN160 into the connector straight, not crooked, and all the way. If it is only partially seated the CTN160 may not operate properly or could even be damaged.
- (2) Do not pull upward on the CTN160 after it has been plugged into the connector. Doing so could permanently damage it.

Continues on next page →

- 6) Join the side of the case with the control panel on it and the rear of the case as they were originally. Then screw in the two screws that hold the back cover in place.

- 7) Attach the electrical contacts using the screws removed in step 2) above.

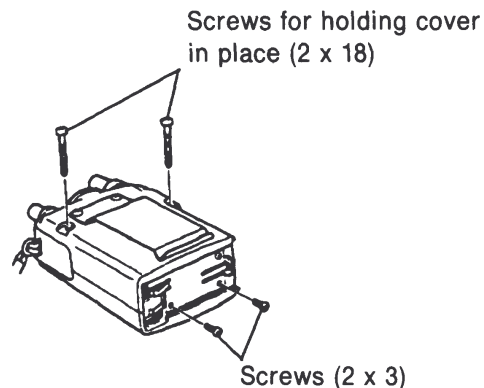

**NOTE**

- First insert the back of the electrical contacts into the release button groove and then secure it in place using the two screws.
- 8) This completes the installation procedure for the CTN160. The transceiver is now equipped for tone squelch operation.

**NOTE**

- There is no need to reset the microprocessor before using the unit.

## Tone Deviation Adjustment

**NOTE**

- (1) The deviation adjustment is performed on the CTN160.
- (2) The CTN160's tone deviation setting is pre-adjusted at the factory. It is therefore not usually necessary to change it. ( $\pm 0.5$  —  $\pm 0.9$  kHz)  
If tone deviation adjustment is necessary, perform the following steps after the CTN160 has been installed in the transceiver.

**Procedure**

- 1) After installing the CTN160 in the transceiver, connect the antenna to a deviation meter.
- 2) Set the transceiver so that the frequency indication reads 145.99 MHz.
- 3) Switch the transceiver to the tone encode mode.
  - Hold down the FUNC key and press the 7 TSQ key. A T appears on the display.
- 4) Switch the transceiver to the tone frequency setting mode.
  - Hold down the FUNC key and press the 0 SET key to activate the set mode. The unit is now in the CTCSS tone frequency setting mode.  
The current tone frequency appears on the display.
- 5) Use the rotary channel selector to set the tone frequency to 250.3 Hz.

Continues on next page →

- 6) Insert a dummy plug into the MIC jack of the unit, as shown in the diagram. This cuts off all microphone input.
- 7) Put the transceiver into the transmit mode and adjust semi-fixed resistor R805 on the CTN160 so that the deviation meter indication is  $\pm 0.7$  kHz.

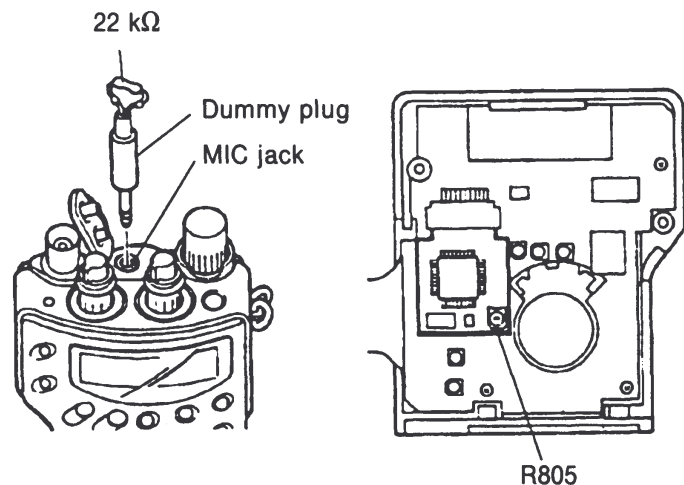

### Specifications

Reference oscillation frequency .....	1.00 MHz
Output frequencies .....	38 (67.0 – 250.3 Hz)
Output level (179.9 Hz) .....	530 $\pm$ 20 mV
Tone distortion .....	10% or less

# Mounting the Optional CMU160/CMU161

## NOTE

- (1) Make sure the transceiver's power switch is turned off before mounting the CMU160 or CMU161.
- (2) When inserting tweezers into the round hole in the CMU160 or CMU161, make sure not to push them in too far. Doing so could damage the memory unit.

## Procedure

- 1) Remove the battery case from the transceiver.

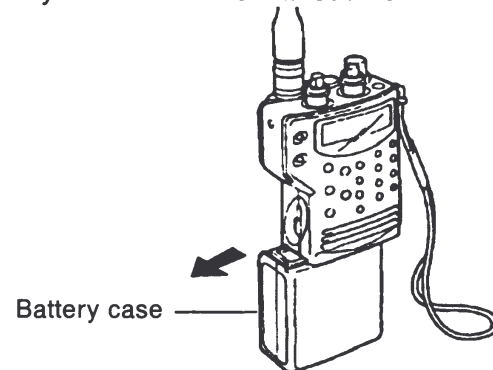

- 2) Remove the CMU160 or CMU161 already mounted in the transceiver. As shown in the illustration, insert the tip of a pair of tweezers lightly into the round hole in the CMU160 or CMU161 and pull it out.

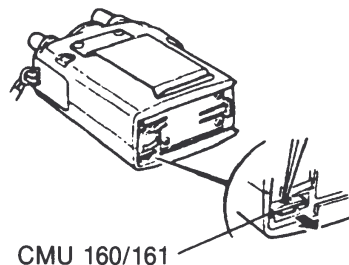

- 3) Insert the CMU160 or CMU161 into the transceiver. As shown in the illustration, slide it straight in with the side with no parts mounted on it facing upward.

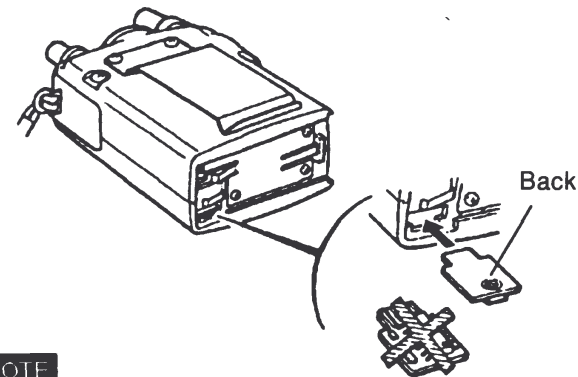

## NOTE

- (1) Push in the CMU160 or CMU161 all the way so that the connector is fully seated. If it is loose, the unit may malfunction or sustain permanent damage.
- (2) Inserting the memory unit upside down will damage the connector in the transceiver. Make sure to insert it correctly.

## ■ All reset method

Mounting a newly purchased memory unit in the C558 and turning the power on will result in a series of low pitched beeps (puff-puff-puff-puff). Perform the all reset procedure described on page 45 before using the memory unit.

Printed in Japan

168X851012