



**STANDARD<sup>®</sup>**

# VHF & UHF COMMUNICATION RECEIVER

## CCR708A

### Owner's Manual



Copyright © 1992  
Standard Amateur Radio Products, Inc.  
*All Rights Reserved*  
Printed in Japan

STANDARD AMATEUR RADIO PRODUCTS, INC.  
MANUFACTURED BY MARANTZ JAPAN, INC.

# VHF & UHF COMMUNICATION RECEIVER

## CCR708A

Thank you for purchasing the VHF/UHF communication receiver.

The CCR708A is produced and shipped only after passing our strict quality control procedures. However, in case you have any trouble or question concerning the unit, please contact your dealer or our service department as soon as possible.

For operating this unit at its full performance for a long period of time, please read this manual carefully before use.

### CONTENTS

Precautions .....	2	Storing frequencies in memory .....	16
Packing Diagram .....	2	Recalling all memory frequencies in sequence .....	17
Controls, Connectors and Indicators .....	3	Changing memory frequency .....	18
Power Supply Connection, Antenna Connection .....	7	Clearing a memory frequency .....	19
Operating Procedures .....	8	Using a memory frequency as the VFO frequency .....	19
Initial Condition .....	8	Memory Scan of specific memory frequencies .....	20
Functions of Control Keys .....	8	How to Select the Desired Frequency by Automatically Searching a Specific Frequency Range .....	22
Reception of Major Bands .....	9	Search operation .....	22
1. Receiving FM broadcasts .....	9	Examples of search address numbers settings .....	22
2. Receiving amateur bands .....	10	Types of search operations .....	22
3. Receiving marine band .....	11	Example of search operation (Searching the amateur bands) .....	23
4. Receiving air craft band .....	12	Other Features .....	28
5. Receiving TV broadcasts (Audio only) .....	12	Automatic frequency correction .....	28
Convenient Operation Features .....	13	Note on Lithium Battery .....	28
How to Set Frequency Using the Band Scope .....	13	Troubleshooting .....	29
Receiving amateur bands .....	13	Specifications .....	29
Note on Band Scope .....	14		
Changing receiving bandwidth of Band Scope .....	14		
How to Quickly Recall Frequently-Used Frequencies .....	16		

# PRECAUTIONS

• Please observe the following precautions to protect the life and performance of your unit.

**1** Power should only be supplied from the AC adapter supplied for exclusive use with the CCR708A. If any other AC adapter is used, damage may result.

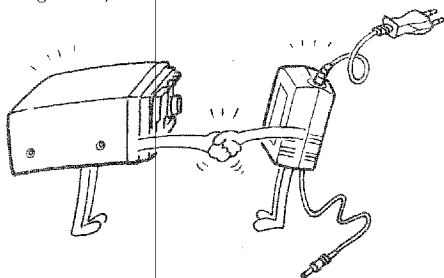

**3** Do not attempt to open the unit or touch the internal parts. Damage may result.

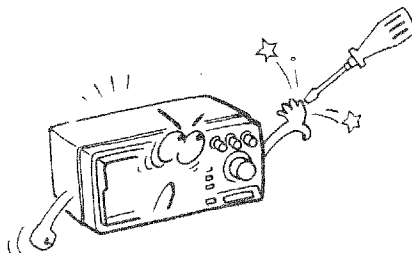

**2** Do not use or leave the unit in a place subject to high temperature, high humidity, excessive dirt or excessive vibrations.

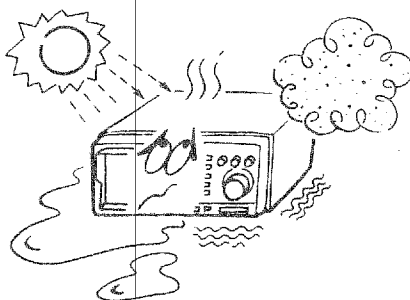

**4** If the unit interferes with other equipment such as a tuner or TV set, or if the unit is subject to external interference from such equipment, operate the unit in a place apart from the equipment. (A word processor or personal computer may also interfere with the unit, so take care to place it apart from such machines.)

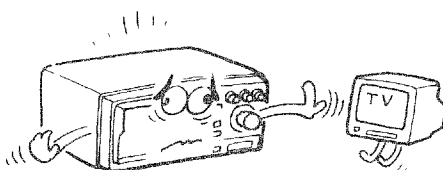

# PACKING DIAGRAM

After unpacking the unit, check that the following items are supplied in the package.

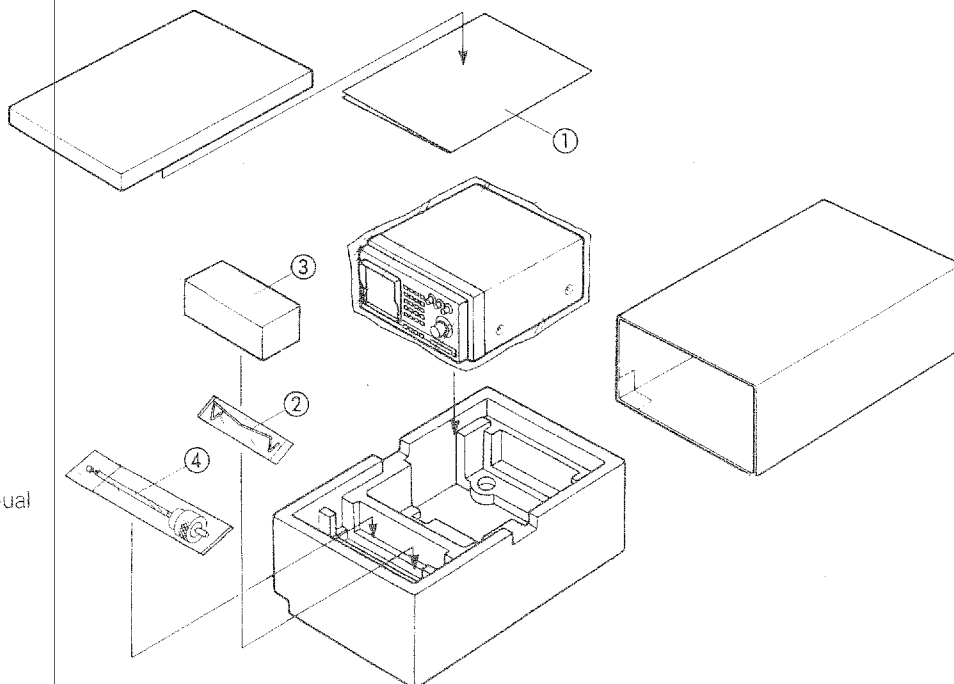

- ① Owner's Manual
- ② Stand
- ③ AC Adapter
- ④ Antenna

# CONTROLS, CONNECTORS AND INDICATORS

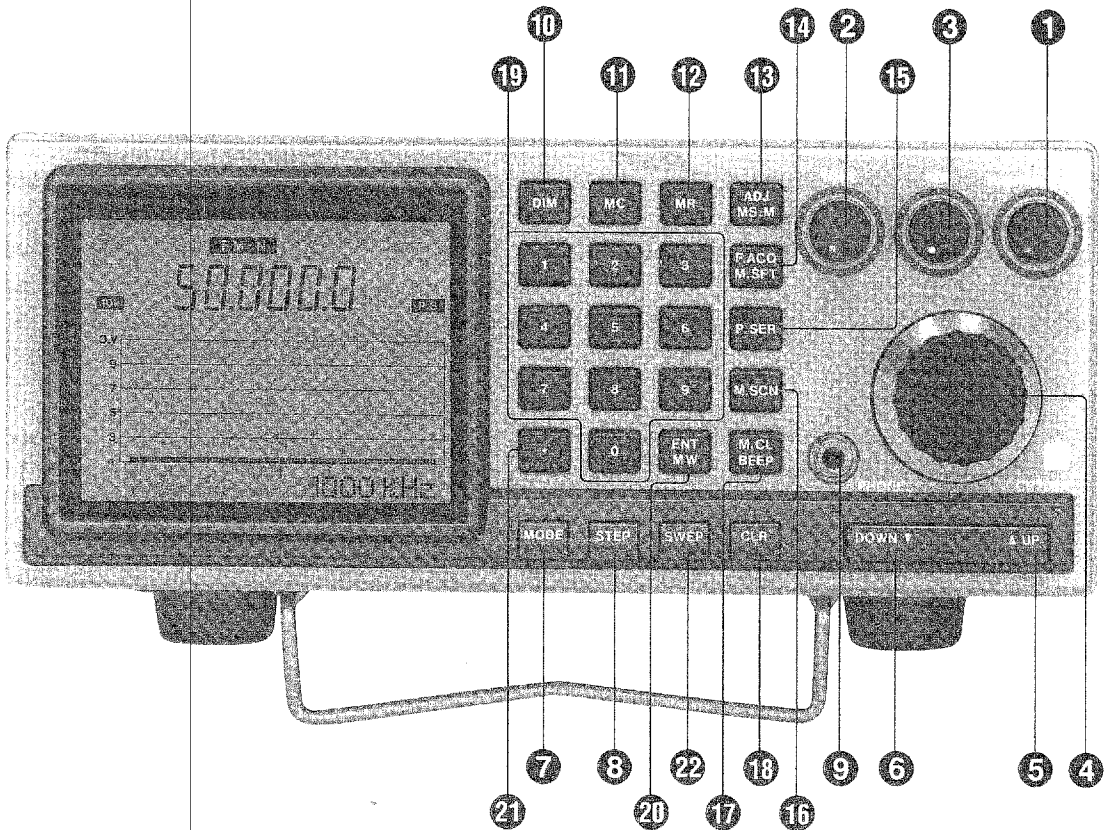

## 1 PUSH PWR/VOL (Power switch/Volume control)

Switches the power ON/OFF and adjusts the speaker volume. Pressing the control knob switches the power ON, and pressing again switches it OFF. Turning the control knob clockwise increases the volume, and turning it counterclockwise decreases the volume.

Increases volume.

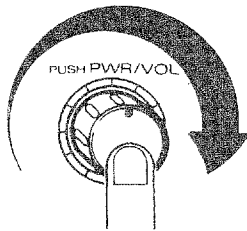

Switches power ON.

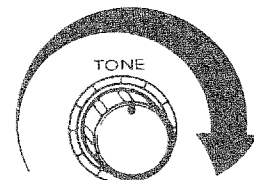

Enhances high frequencies.

## 2 TONE control

Adjusts the tone of the sound emitted from the speaker. Turning the control knob clockwise enhances high frequencies, and turning it counterclockwise enhances the low frequencies. Normally, set the control to the center position.

## 3 SQL (Squelch) control

Silences the noise characteristic of FM signals. The SQL feature is effective in the FM-N (Narrow) and AM modes. To reduce noise in the FM-W (Wide) mode, adjust the W-MUTE control on the rear panel.

Silences the noise.

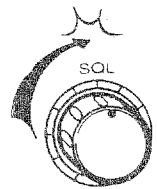

When the signal strength is weak, take care to set the squelch control to the fully counterclockwise position.

In normal operation, turn the control until the rain-like noise becomes inaudible. Do not turn the control too far clockwise, for this hinders the reception of weak signals.

#### 4 Rotary channel selector

Selects the frequency to be received. Turning the control knob clockwise increases the frequency, and turning it counterclockwise decreases the frequency. When the control is turned while "M" is displayed, the memory address numbers are recalled in sequence.

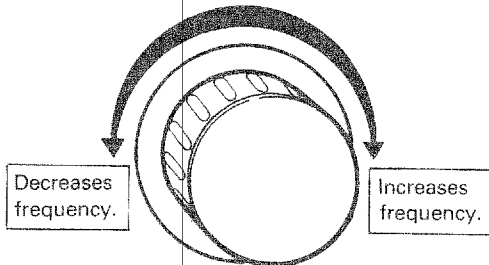

#### 5 UP key

Pressing this key varies the frequency upward, and holding the key depressed varies it continuously upward. When the key is pressed while "M" is displayed, the memory address numbers are recalled in upward sequence.

#### 6 DOWN key

Pressing the key varies the frequency downward, and holding the key depressed varies it continuously downward. When the key is pressed while "M" is displayed, the memory address numbers are recalled in downward sequence.

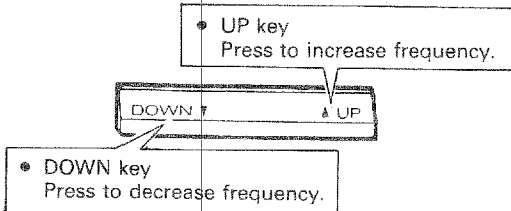

#### 7 MODE key

Selects the mode of the frequency to be received. Pressing the key switches between the following three reception modes.

- FM-W ..... For receiving FM broadcasts and TV broadcasts (audio only).
- FM-N ..... For receiving amateur bands and marine band.
- AM ..... For receiving air craft band, etc.

#### 8 STEP key

Selects the channel step. The channel step refers to the amount of variation in frequency which occurs when the rotary channel selector is turned by one click or when the UP or DOWN key is pressed once. Six channel steps are available with this unit: four normal channel steps of 10 kHz, 12.5 kHz, 20 kHz and 25 kHz; and two channel steps which can be used only in ADJ operation – 5 kHz (rotary channel selector) and 1 kHz (UP/DOWN keys).

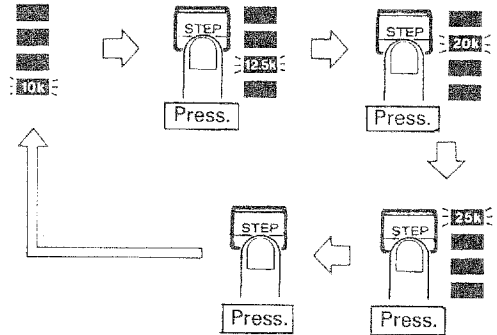

#### 9 PHONES (Headphones) jack

Connect an optional monaural headphone or earphone to this 3.5 mm jack.

#### 10 DIM (Dimmer) key

Selects the brightness of the display in two steps. Pressing the key once makes the display dim, and pressing it again makes the display bright. (The unit has been set for bright display at the factory.)

#### 11 MIC (Memory Change) key

Sets the Memory Change mode for changing the frequency stored in memory. When this key is pressed in the Memory Recall mode, the unit enters the Memory Change mode and the display shows "Memory Change," "Start Change" or "End Change," indicating the current status in the Memory Change mode. In the Memory Change mode, the frequency can be varied with the numeric keys, the rotary channel selector, or the UP/DOWN keys.

#### 12 MR (Memory Recall) key

Sets the Memory Recall mode. When this key is pressed, the unit enters the Memory Recall mode, and the display shows the memory address number and "M". The memory address numbers refer to the memory locations in which frequencies are stored. The CCR708A can store 100 frequencies in memory address numbers 0 ~ 99.

### 13 ADJ/MS.M (Frequency Fine Tuning/ Memory-Scan Memory) key

When this key is pressed in the VFO mode, the display shows "AJ" and the frequency can be varied in 5 kHz channel steps with the rotary channel selector or in 1 kHz channel steps with the UP/DOWN keys. During the AJ operation, the channel step indicator on the left of the display is not displayed.

When the key is pressed in the Memory Recall mode, the MS.M (Memory-Scan Memory) frequency can be set or canceled. (The MS.M operation can only be entered from the Memory Recall mode.)

The Memory-Scan Memory frequencies refer to those memory frequencies that are to be scanned prior to other memory frequencies.

### 14 F.ACQ/M.SFT (Band Scope/Memory Shift) key

When this key is pressed in the VFO mode, the unit enters the Band Scope mode. Pressing the key again returns the unit to the VFO mode.

The Band Scope mode allows the receiving frequency to be set using the Band Scope.

When the key is pressed in the Memory Recall mode, the contents recalled from memory is shifted for use in the VFO mode. (The M.SFT operation can be activated only from the Memory Recall mode or during a Search/Scan operation.)

### 15 P.SER (Program Search) key

Starts Search operation.

When this key is pressed in the VFO mode, the display shows "Normal Search" and "PO", and all frequencies are searched beginning with the frequency shown on the display (factory setting).

When the key is pressed after pressing the MR key, the search frequencies can be set, changed or cleared.

### 16 M.SCN (Memory Scan) key

When the key is pressed, the display shows "Memory Scan" and the memory address numbers are scanned sequentially.

The memory address numbers in which no memory frequencies have been stored are skipped and not scanned.

If no frequency has been stored in any memory address number, the key is invalid (a low, short beep is generated when it is pressed).

### 17 M.CL/BEEP (Memory Clear/ Beep) key

When this key is pressed in the VFO mode, the beep sound is switched ON/OFF (the factory setting is ON activated).

If the beep sound is generated when the key is pressed, the beep is switched ON. If it is not generated, the beep is switched OFF.

When the key is pressed in the Memory Recall mode, the memory contents are cleared. (The M.CL operation can be activated only from the Memory Recall mode.)

### 18 CLR (Command Cancel) key

Cancels the Memory Recall mode, Band Scope mode, P.SER mode and M.SCN mode.

Pressing the key also cancels the frequency setting entered using the numeric keys.

### 19 0-9 numeric keys

Used to enter frequencies or memory address numbers to be recalled.

Each time a numeric key is pressed, the display shows the corresponding number.

In the Memory Recall mode, these keys are also used to recall memory address numbers or to set memory frequencies.

### 20 ENT/MW (Enter/Memory Write) key

When this key is pressed while setting a frequency with numeric keys, the remaining digit locations are filled with "0" and the frequency setting is completed.

Example:

**1** **4** **4** **.** **ENT** ..... "144.000.0" will be displayed.

When the key is pressed in the Memory Recall mode, the memory frequency, mode, channel step, or Band Scope frequency range can be written to memory.

### 21 . (MHz Dot) key

Sets the decimal point for the digit of MHz when setting a frequency with the numeric keys.

Example: To set 84.700 MHz with the numeric keys, press the keys in the following order.

**8** **4** **.** **7** **0** **0** **0**

### 22 SWEP (Width) key

Selects the Band Scope frequency range from one of the following three bandwidths; approx. 1000 kHz, approx. 250/260 kHz, and approx. 100 kHz.

## Rear Panel

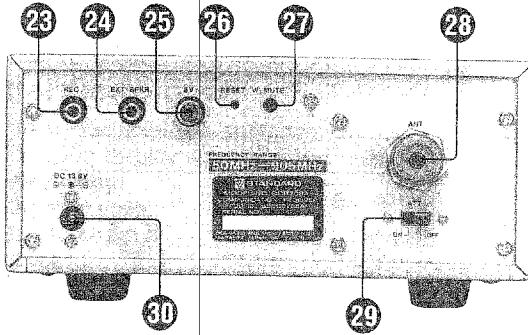

### 23 REC (Recording Output) jack

To record the received sound on a tape recorder, connect the recorder's MIC jack to this jack. For details, refer to the instruction manual provided with your tape recorder.

The output level is approx. 30 mV/100k $\Omega$ .  
Use a plug with a diameter of 3.5 mm.

### 24 EXT. SPK (External Speaker Output) jack

To use an external speaker (8 $\Omega$ ), connect it to this jack.

Use a plug with a diameter of 3.5 mm.

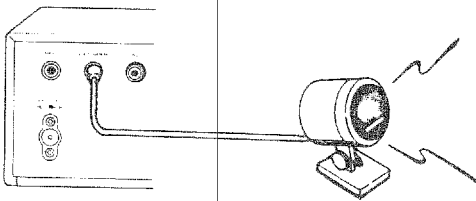

### 25 8 V (8 V DC Output) jack

Provides a voltage output of 8 V DC.  
Never apply any voltage to this jack, otherwise the unit will be damaged.

### 26 RESET button

Press this button when the display content is abnormal (in case of microcomputer malfunction) or after replacement of the lithium backup battery.

RESET

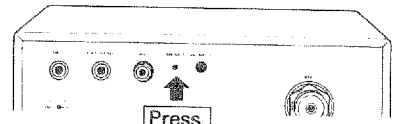

**Caution:** When the RESET button is pressed, all memory contents are cleared.

### 27 W-MUTE (Wide Mute) control

Mutes noise in FM-W mode.

During FM reception, rain-like noise is heard in frequencies where no signal is being received. This control allows such noise to be muted.

To adjust muting level, insert a thin flat-blade screwdriver gently and straight into the hole and turn the control. The noise is heard when the control is turned fully counterclockwise. Turn the control clockwise gently until the noise is muted.

#### Caution

1. This adjustment should be performed while receiving a frequency without signal.
2. Do not turn the control too far clockwise, for this could hinder the reception of weak signals.
3. Scan or Search operations cannot be performed while noise is present. Be sure to mute the noise before these operations.

### 28 ANT (Antenna) terminal

The supplied external antenna should be connected to this terminal.

The terminal has an impedance of 50 ohms.

### 29 ATT (Attenuator) switch

This switch is normally set to OFF.

In case the received signal is too strong and causes the speaker sound to be distorted, set the switch to ON (this attenuates the signal level by approx. 20 dB).

### 30 13.8 V DC jack

The supplied AC adapter should be connected to this jack.

If any AC adapter other than the one supplied with the unit is connected to this jack, damage may result.

## Bottom Panel

### 31 Stand retaining holes

Holds the supplied stand.  
Attach the stand as shown in the illustration.

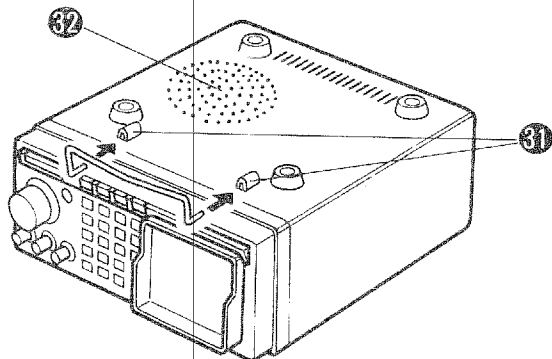

### 32 Speaker

This is the speaker mounted inside the CCR708A main unit.

## POWER SUPPLY CONNECTION, ANTENNA CONNECTION

- 1 Connect the supplied AC adapter to the 13.8 V DC jack on the CCR708A rear panel.

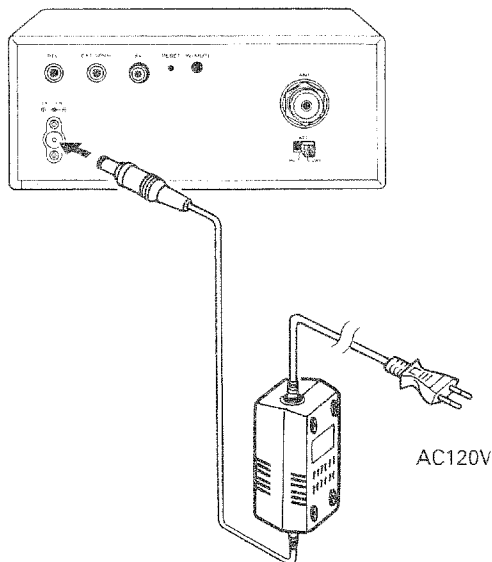

- 2 Connect the supplied rod antenna to the ANT terminal. Extend the supplied antenna according to the frequency band to be received.

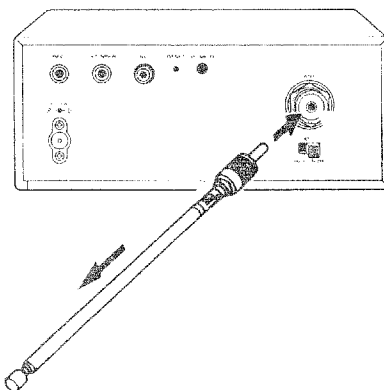

If it is necessary to use an external antenna other than the one supplied, use a wide-band antenna of 50 ohms or a special antenna designed for the specific frequency band to be received.



# OPERATING PROCEDURES

After unpacking the CCR708A, attach the supplied antenna, AC adapter and stand to the body.

## Initial Condition

- When the power is switched ON for the first time, the display will show the following:
 

<b>Frequency:</b>	50.000.0	}	This condition is referred to as the initial condition.
<b>Channel step:</b>	10 kHz		
<b>Band Scope:</b>	1000 kHz		
<b>Mode:</b>	FM-N		
<b>Scanning method:</b>	P.S		

### Advice

If the RESET button on the rear panel is pressed, a high beep sound is generated and the display is reset to the initial condition. However, be careful in pressing the RESET button, for this will clear all of the memory contents.

- Initial conditions of the various controls are as follows:

**PUSH PWR/VOL:** Fully counterclockwise position.  
**SQL control:** Fully counterclockwise position.  
**TONE control:** Fully counterclockwise position.

- Set the controls in the following manner:
  - Press the PWR/VOL control to switch the power ON.
  - Turn the PWR/VOL control clockwise so that the volume of the noise being received is not too loud.
  - Turn the SQL control slowly clockwise until the noise is silenced (SQL adjustment).

**The unit is now ready for reception. Continue operations following the procedures described from the next page.**

## Functions of control keys

Key Name	When pressed in VFO mode	When pressed in Memory Recall mode
ADJ/MS.M	Sets channel step to 1 kHz and 5 kHz.	Sets/cancel Memory Scan Memory.
F.ACQ/M.SFT	Sets/cancels Band Scope mode.	Shifts memory frequency for use as VFO frequency.
P.SER	Sets/cancels/pauses Search operation.	Sets Search start and end frequencies.
M.SCN	Sets/pauses Memory Scan.	Invalid.
M.CL/BEEP	Switches beep tones ON/OFF.	Clears memory frequency.
MC	Invalid.	Changes memory frequency.
Numeric keys 0-9	Sets frequency.	*Recalls memory address no. *In Memory Change mode, sets frequency.
.	Inputs MHz dot when setting frequency.	Invalid. (In Memory Change mode, inputs MHz dot.)
ENT/MW	Enters frequency.	Writes memory frequency.
MR	Sets Memory Recall mode.	Cancels Memory Recall mode.
UP/DOWN	Sets frequency.	*Recalls memory address no. *In Memory Change mode, sets frequency.
MODE	Sets mode.	In Search operation, changes scanning method.
STEP	Changes channel step.	Invalid.
SWEP	Changes Band Scope receiving bandwidth.	Invalid.
CLR	Invalid.	Cancels command (Returns Memory Recall mode to VFO mode.) In Memory Change mode, returns it to Previous mode.
DIM	Selects the brightness of the display.	Selects the brightness of the display.

## Reception of Major Bands

### 1. Receiving FM broadcasts

#### Procedure

- 1 Press the MODE key to display "FM-W".  
Each time the MODE key is pressed, the receiving mode is changed in a continuous cycle of FM-W, FM-N, and AM.
- 2 Set the frequency of the desired FM station with the numeric keys.

#### For example, to receive FM Los Angeles:

Press the numeric keys in the following order:

9 8 . 6 0 0 0

When the last "0" is pressed a short, high beep is generated to indicate the completion of the setting.

- 3 As soon as the frequency setting is completed, the FM broadcast is heard from the speaker.

#### Caution

**The first key pressed for setting a frequency must be other than "0". If numeric key "0" is pressed, a low beep is generated and the key input is not performed.**

#### Advice

1. The frequency can be set either by turning the rotary channel selector or by pressing the UP and DOWN keys. Select the method that is convenient for your purpose.  
(The frequency can also be set using the Band Scope feature.)
2. To set a frequency precisely to the transmitting frequency of the station, press the ADJ/MS.M key and adjust with the rotary channel selector. In this case, "10 kHz" disappears from the display and "AJ" appears in the place, and the channel step becomes 5 kHz.

When the frequency has been set, press the ADJ/MS.M key again to return to the previous channel step.

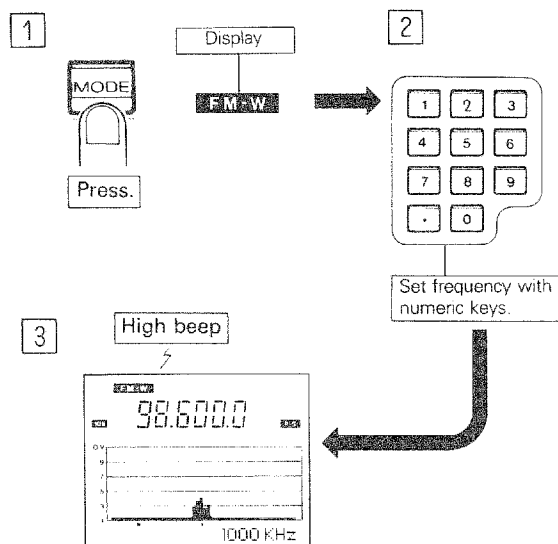

When the UP or DOWN key is pressed while "AJ" is displayed, the frequency is varied in 1 kHz steps.

- 4 To cancel frequency setting in the middle, press the CLR key.  
The frequency setting will return to the previously set frequency.

#### Caution

**To allow the reception of FM broadcast stations, the display must show "FM-W".**

## 2. Receiving amateur bands

To receive the 144 MHz band:

### Procedure

- 1 Press the MODE key to display "FM-N".
- 2 Press the STEP key to display "20 kHz".  
This sets the channel step to 20 kHz.  
Each time the STEP key is pressed, the channel step is changed in a continuous cycle of 10 kHz, 12.5 kHz, 20 kHz, and 25 kHz. Select the channel step according to the band to be received.
- 3 Set the frequency with the numeric keys.

To receive 145.000 MHz:

Press the numeric keys in the order:

1 4 5 . 0 0 0 0

To receive 444.520 MHz:

Press the numeric keys in the order:

4 4 4 . 5 2 0 0

When the last "0" is pressed, a high beep is generated indicating the completion of setting.

### Caution

To allow the reception of FM signals other than FM broadcast stations and TV broadcast stations (audio only), the display must show "FM-N".

To receive AM signals in the 50 MHz band:

### Procedure

- 1 Press the MODE key to display "AM".
- 2 Press the STEP key to display "20 kHz".  
This sets the channel step to 20 kHz.
- 3 Set the frequency with the numeric keys.  
Press keys in the order: 5 0 . 1 0 0 0  
When the last "0" is pressed, a high beep is generated indicating the completion of the setting.

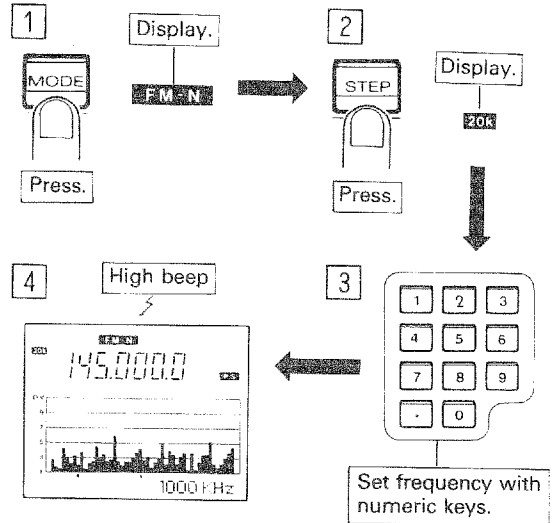

### Advice

1. When receiving amateur bands, use the 20 kHz channel step.

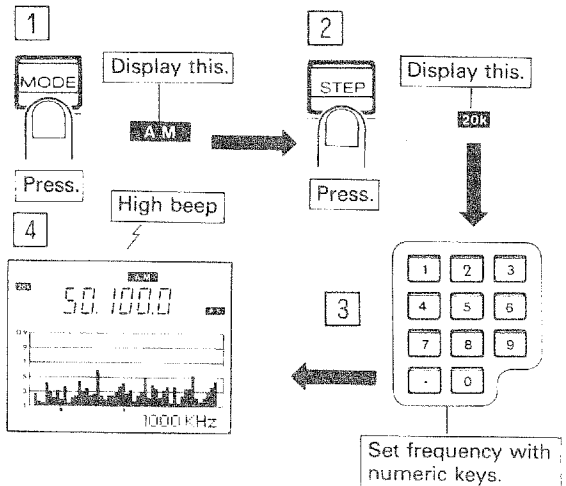

### 3. Receiving marine band

The marine band consists of frequencies ranging from 156.025 MHz to 163.275 MHz. This frequency band is common to all countries in the world.

#### Procedure

- 1 Press the MODE key to display "FM-N".
- 2 Press the STEP key to display "25 kHz".  
This sets the channel step to 25 kHz.
- 3 Set the frequency with the numeric keys.  
Press keys in the order:  
1 5 6 . 0 0 0 0  
When the last "0" is pressed, a high beep is generated indicating the completion of setting.

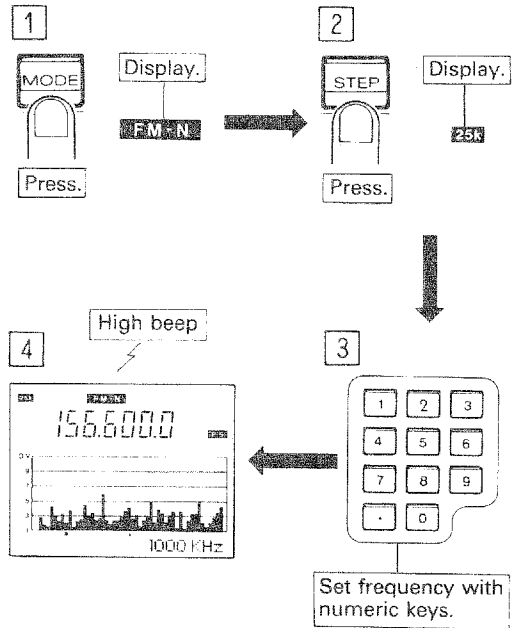

## 4. Receiving air craft band

The air craft band consists of frequencies ranging from 118.000 MHz to 135.990 MHz.

### Procedure

- 1 Press the MODE key to display "AM".
- 2 Press the STEP key to display "25 kHz".  
This sets the channel step to 25 kHz.
- 3 Set the frequency with the numeric keys.  
Press keys in the order:  
1 1 8 . 0 0 0 0  
When the last "0" is pressed, a high beep is generated indicating the completion of setting.

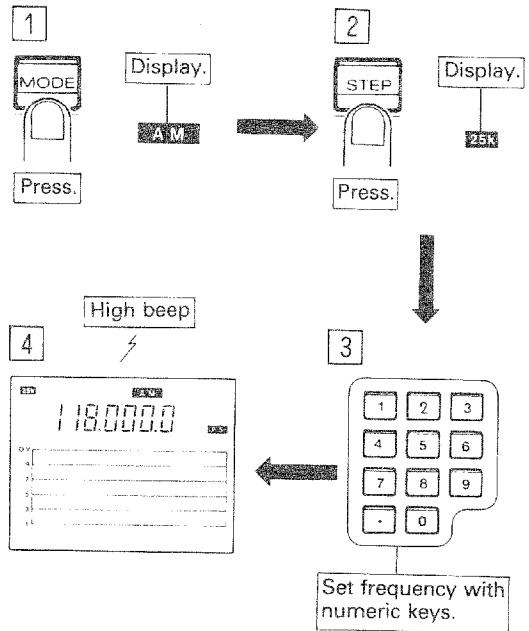

## 5. Receiving TV broadcasts (audio only)

Set the frequencies used by the local TV stations used in the country where this unit is used.

### Procedure

- 1 Press the MODE key to display "FM-W".
- 2 Press the STEP key to display "25 kHz".  
This sets the channel step to 25 kHz.
- 3 Set the frequency with the numeric keys.

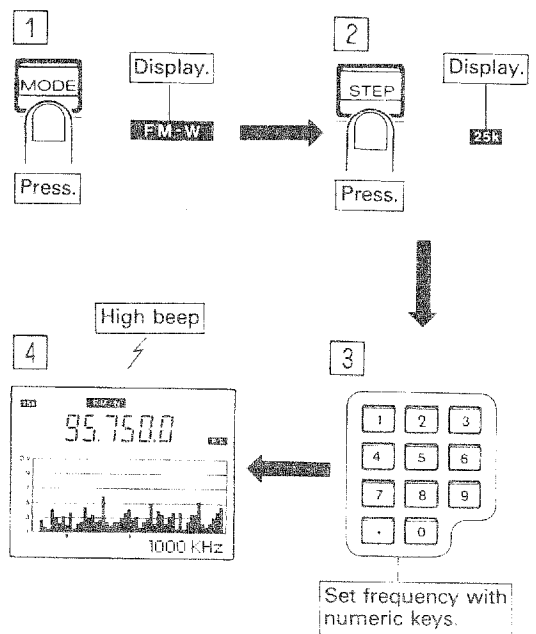

# CONVENIENT OPERATION FEATURES

## How to Set Frequency Using the Band Scope

In addition to the methods using numeric keys or the rotary channel selector, the frequency can be set using the Band Scope feature.

The Band Scope is the display feature that allows visual identification of the signals present in a given frequency range.

### Receiving amateur bands

#### Procedure

- 1 To receive the 144 MHz band, set the 145.000.0 MHz so that it appears on the display.
- 2 Press the F.ACQ/M.SFT key. A cursor will be displayed at the top center of the Band Scope.
- 3 By turning the rotary channel selector, move the cursor toward a position above one of the black bars moving up and down on the Band Scope. When the top cursor is moved, the cursor at the bottom of the display panel is also moved. (The displayed frequency is varied, but the frequency being received is not varied.)  
While the cursor and the center marking are not aligned, the dots for MHz and kHz blink.  
When the cursor and the center marking are aligned, the dots for MHz and kHz light steadily.
- 4 When the ENT/MW key is pressed, the frequency corresponding to the position of the cursor is set, the frequency of the center marking is changed to that frequency, and the display also shows that frequency as the set frequency.  
In each band, the frequency can be set with the procedure above.

#### Advice

1. When returning from the Band Scope mode to the VFO mode using the F.ACQ/M.SFT key:

The previous frequency selected in VFO mode can be received again using the following procedure.

- 1) In the Band Scope mode,
- 2) vary the frequency, and
- 3) press the CLR key.
- 4) The previous frequency is received again.

The frequency being received in the Band Scope mode can be received continuously using the following procedure.

- 1) In the Band Scope mode,
  - 2) vary the frequency, and
  - 3) press the F.ACQ/M.SFT key.
  - 4) The frequency being received is received in the VFO mode.
2. The newly-set frequency can be used as follows.
    - 1) In the Band Scope mode,
    - 2) vary the frequency, and
    - 3) press the ENT/MW key.
    - 4) The newly-set frequency is set.

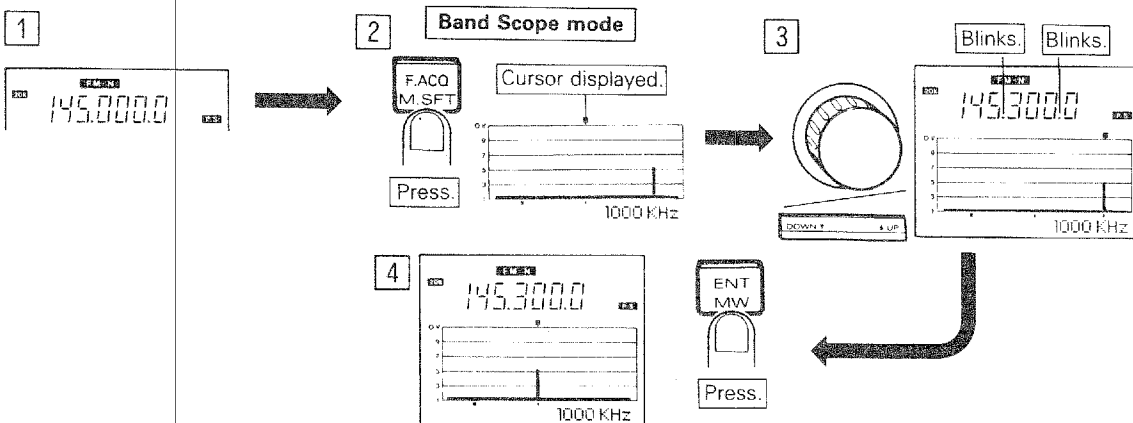

## Note on Band Scope

The Band Scope is the display feature that allows visual identification of the signals present in a given frequency range.

With the CCR708A, the signals present in the receiving frequency band of approx. 1000 kHz, approx. 250 kHz (260 kHz) or approx. 100 kHz can be checked visually.

When a signal is present within the designated frequency band, a black bar moves up and down between scale "1" and scale "O.V" of the Band Scope, enabling the presence of the signal to be identified at a glance.

The distance each black bar moves is proportional to the strength of the signal. If it rises up to nearly "O.V", the signal is very strong.

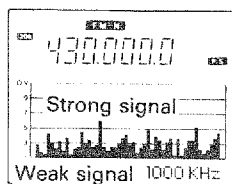

If the display shows "1000 kHz" bandwidth and "10 kHz" channel step, the frequencies in the range of -490 kHz to 500 kHz centered around 430,000.0 kHz are displayed on the Band Scope.

## Changing receiving bandwidth of Band Scope

### Procedure

- 1 To change the receiving bandwidth, press the SWEP key.



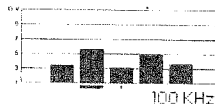
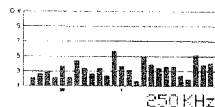
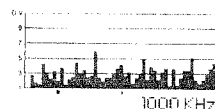

Each time the SWEP key is pressed, the bandwidth shown at the bottom right of the display is changed in a continuous cycle of "1000 kHz", "250 kHz", "100 kHz", "250 kHz", and "1000 kHz". When receiving a band containing relatively few signals, select the 1000 kHz bandwidth.

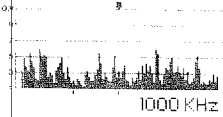
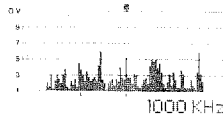
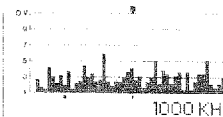
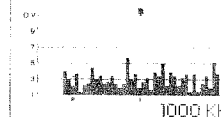
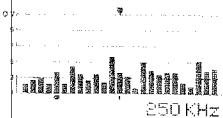
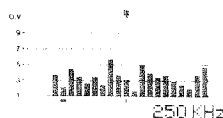
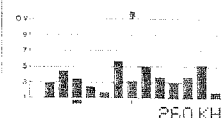

### Caution

When the 20 kHz channel step is selected, the receiving bandwidth is set to 260 kHz.

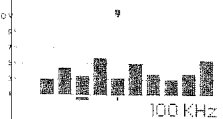
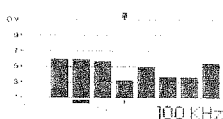
## Band Scope bandwidths and display styles

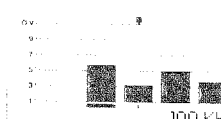
		Receiving Frequency Channel Step			
		10kHz	12.5kHz	20kHz	25kHz
Band Scope Receiving Bandwidth	1000kHz	X-490.0 kHz~ X+500.0 kHz  100 bars (100 dots) 1 dots Space 0 dots  	X-487.5 kHz~ X+500.0 kHz  100 bars (100 dots) 1 dots Space 0 dots  	X-480.0 kHz~ X+500.0 kHz  100 bars (100 dots) 2 dots Space 0 dots  	X-475.0 kHz~ X+500.0 kHz  100 bars (100 dots) 2 dots Space 0 dots  
	250kHz 260kHz	X-120.0 kHz~ X+120.0 kHz  25 bars (100 dots) 3 dots Space 1 dots  	X-112.5 kHz~ X+125.0 kHz  20 bars (80 dots) 3 dots Space 1 dots  	X-120.0 kHz~ X+120.0 kHz  13 bars (91 dots) 5 dots Space 2 dots  	X-100.0 kHz~ X+125.0 kHz  10 bars (90 dots) 7 dots Space 2 dots  
	100kHz	X-40.0 kHz~ X+50.0 kHz  10 bars (90 dots) 7 dots Space 2 dots  	X-37.5 kHz~ X+50.0 kHz  8 bars (88 dots) 9 dots Space 2 dots  	X-40.0 kHz~ X+40.0 kHz  5 bars (80 dots) 13 dots Space 3 dots  	X-25.0 kHz~ X+50.0 kHz  4 bars (76 dots) 15 dots Space 4 dots  

Note: "X" is the receiving frequency.



## How to Quickly Recall Frequently-Used Frequencies

**This operation is possible using the Scan feature.** By storing frequencies that are most often received in the memory any of them can be recalled quickly when required.

The CCR708A is provided with a memory feature that can store up to 100 frequencies in memory address numbers 00 to 99. The desired frequency can be recalled by designating the memory address number in which it has been stored.

### Storing frequencies in memory

This operation is performed using the MR key, ENT/MW key, numeric keys, rotary channel selector, and UP/DOWN keys.

#### Procedure

For example, let us store an amateur-band frequency of 145.000 MHz in memory address number 00.

- 1 Press the numeric keys to display the receiving frequency of "145.000" MHz.  
Press keys in the order:  
1 4 5 . 0 0 0 0  
When the last "0" is pressed, a high beep is generated.
- 2 Select the receiving mode (by setting the MODE key to FM-W, FM-N, or AM).  
For the amateur band, press the MODE key to display "FM-N".
- 3 Set the channel step (with the STEP key).  
For the amateur band, press the STEP key to display "20 kHz" (20 kHz step).

- 4 Set the Band Scope receiving bandwidth (with the SWEP key).  
Press the SWEP key to display "1000 kHz".

#### Advice

The initial values can also be used in place of the settings in steps 3 and 4.

The items set up to this point are now stored in the memory.

- 5 Press the MR key.  
The display shows "Mxx".  
The unit is now in the Memory Recall mode. Character "M" blinks if no frequency has been stored in memory address number "XX". Character "M" lights steadily when a frequency has been stored in memory address number "XX".
- 6 Select a memory address number.  
For example, if the frequency is to be stored in memory address number 09 (empty address), operate the numeric keys, the rotary channel selector, or the UP/DOWN keys to display "09".  
The memory address number can be varied freely using the numeric keys, the rotary channel selector, or the UP/DOWN keys.
- 7 Press the ENT/MW key. A high beep sound is generated indicating the completion of the memory write operation.
- 8 Press the F.ACQ/M.SFT key. The unit enters the VFO mode with the frequency that has been stored in memory.

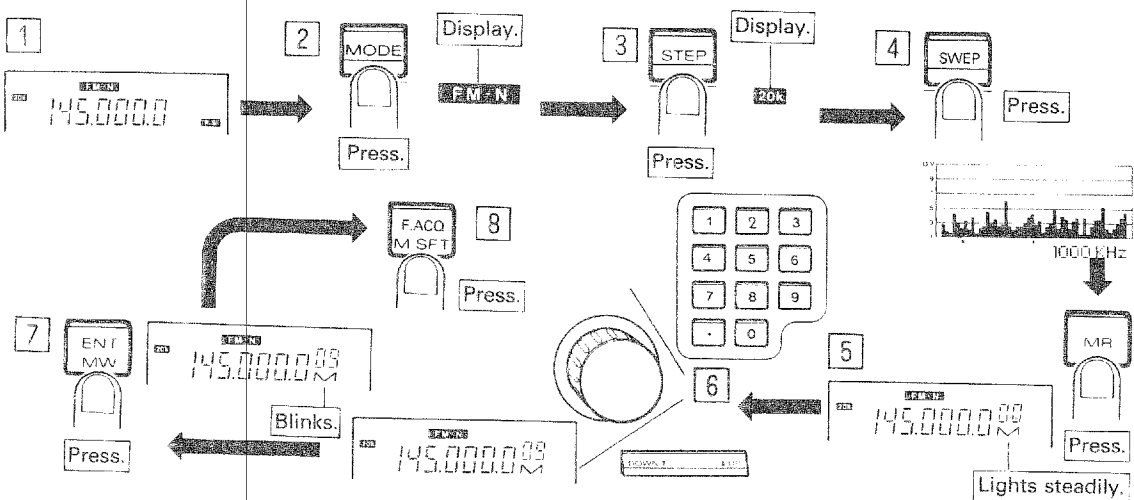

## Recalling all memory frequencies in sequence

This operation is possible using the Memory Scan feature.

The Memory Scan feature allows frequencies to be recalled in sequence from the memory.

To pause the Memory Scan operation temporarily, press the M.SCN key again.

During pause, the dot blinks at a faster speed than usual.

For the scanning methods offered by the CCR708A, please read the Advice section below.

### Procedure

- 1 Press the M.SCN key in the VFO mode to start Memory Scan.

The display shows the memory address numbers in sequence together with "M", and the Band Scope shows "Memory Scan".

During Memory Scan, the MHz and kHz dots blink to indicate that the unit is in the Memory Scan mode.

- 2 To cancel Memory Scan, press the CLR key, the F.ACQ/M.SFT key, or the ENT/MW key.

When Memory Scan is canceled by the CLR key, the unit returns to its previous condition.

When Memory Scan is canceled by the F.ACQ/M.SFT or ENT/MW key, the unit returns to the VFO mode with the last frequency set during Memory Scan.

1

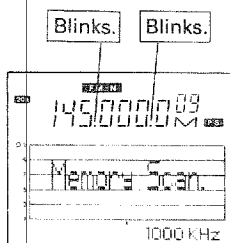

2

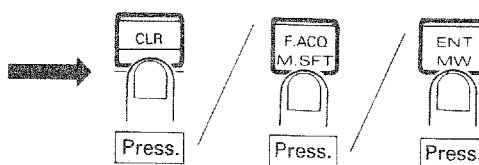

### Advice

1. The memory address numbers in which no frequency has been stored are skipped.
2. The CCR708A provides the following four types of Scan/Search stop methods.

**1) P.S:** Scanning stops every time a signal is received. Scanning resumes after approx. 5 seconds or as soon as the signal disappears.

**2) A.D:** Scanning stops every time a signal is received. Scanning resumes approx. 2 seconds after the sound from the speaker disappears or as soon as the signal disappears.

**3) HOLD:** Scanning stops approx. 2 seconds after a signal is received.

**4) DLY:** Scanning resumes approx. 2 seconds after a signal being received disappears.

To change the scanning stop method, first press the P.SER or M.SCN key to start Search or Scan, then press the MODE key to select the method ("P.S", "A.D", "HOLD", and "DLY" are displayed in a continuous cycle), and finally press the ENT/MW key.

If the ENT/MW key is not pressed, the change will only be temporary.

## Changing memory frequency

To change a frequency stored in memory, use the following procedure.

### Procedure

- 1 Press the MR key to recall the memory address number in which the contents are to be changed with the rotary channel selector or the UP/DOWN keys.
- 2 Press the MC key. "M" on the display starts blinking and the Band Scope shows "Memory Change".
- 3 Change the frequency with the numeric keys, the rotary channel selector, or the UP/DOWN keys.
- 4 Press the ENT/MW key. A high beep sound is generated indicating the completion of frequency change.
- 5 Press the CLR key to return to the VFO mode.

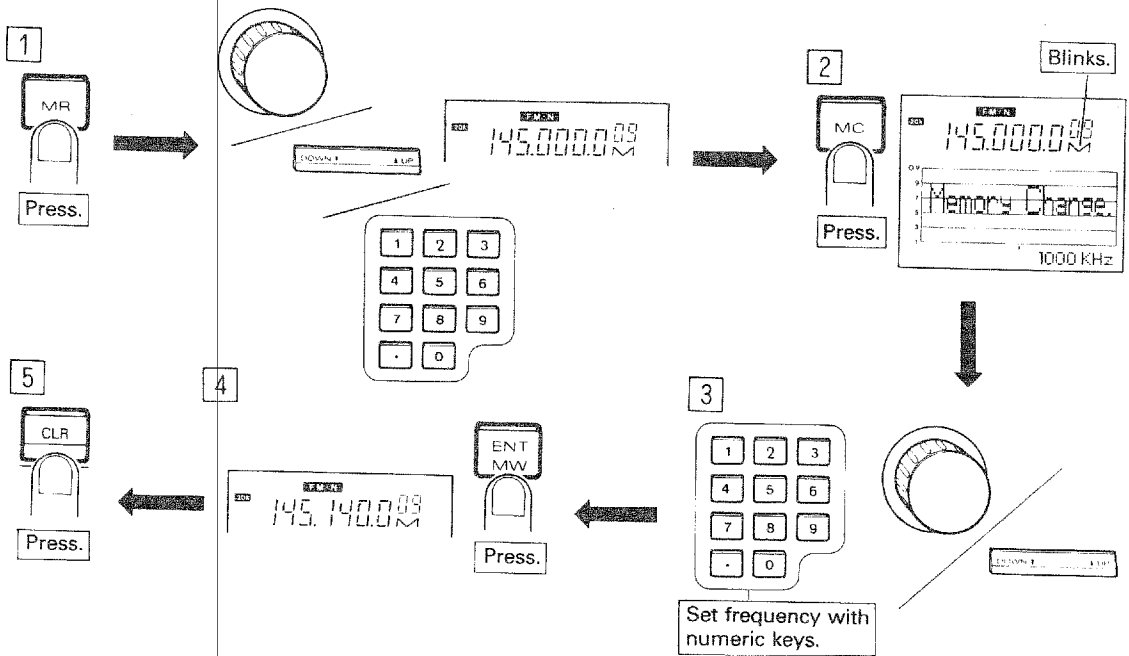

## Clearing a memory frequency

To clear a frequency stored in memory, use the following procedure.

### Procedure

- 1 Press the MR key, and recall the memory address number in which the contents are to be cleared with the rotary channel selector or the UP/DOWN keys.
- 2 Press the M.CL key. "M" on the display starts blinking, and the frequency set before the memory frequency was recalled is displayed again.
- 3 Press the CLR key to return to the VFO mode.

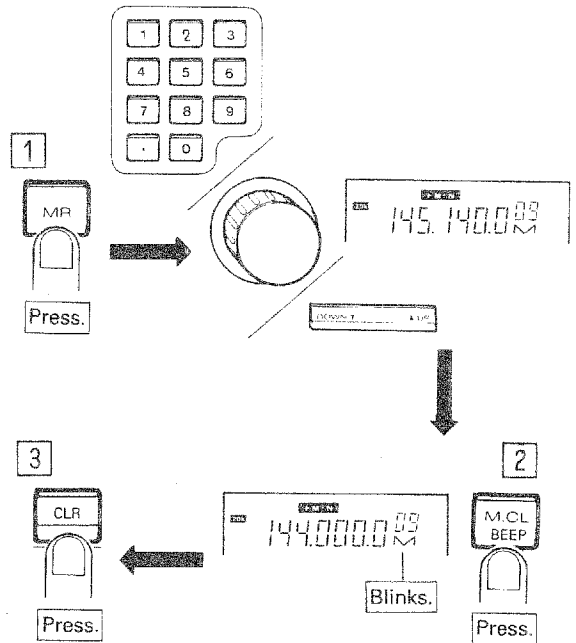

## Using a memory frequency as the VFO frequency

### Procedure

- 1 Press the MR key and recall a memory frequency.
- 2 Press the F.ACQ/M.SFT key. The memory frequency shown on the display can now be used as the VFO frequency.

### Advice

1. When the CLR key is pressed in the Memory Recall mode, the frequency set before the memory frequency was recalled is displayed again.
2. When the F.ACQ/M.SFT key is pressed in the Memory Recall mode, the unit returns to the VFO mode and the frequency being displayed can be used in the VFO mode.

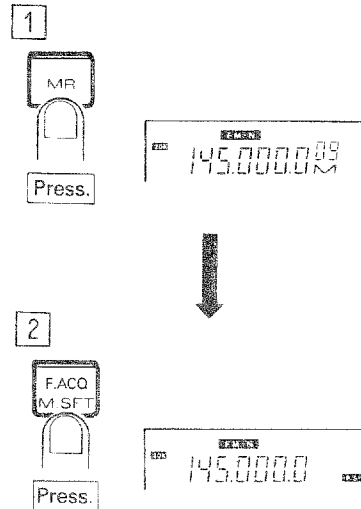

## Memory Scan of specific memory frequencies

This operation is possible using the MS.M (Memory-Scan Memory) feature.

Before starting the MS.M operation, the memory address numbers subject to the MS.M operation must be specified.

The following controls are used in this operation.

**MR key:** Activates the Memory Recall mode.

**ADJ/MS.M key:** Sets or cancels the frequencies (memory address numbers) subject to Memory Scan.

**Numeric key:** Recall memory address numbers.

**Rotary channel selector:** Recall memory address numbers.

1. First, select the frequencies (memory address numbers) subject to Memory Scan using the following procedure.

### Procedure

- 1 Press the MR key to enter the Memory Recall mode.
- 2 Recall the memory address number which should be recalled in future Memory-Scan Memory operations.
- 3 Press the ADJ/MS.M key; "▼" appears above the "M" on the display.
- 4 The setting is now completed.
- 5 Press the CLR key to return to the VFO mode.

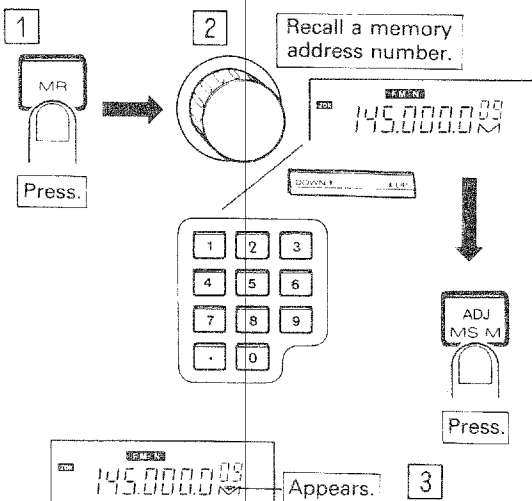

2. To perform the Memory-Scan Memory operation, use the following procedure.

### Procedure

- 1 Press the M.SCN key to start the Memory Scan operation.
- 2 When the ADJ/MS.M key is pressed during Memory Scan, the Memory-Scan Memory operation starts. The display shows "MS.M Scan".
- 3 When the ADJ/MS.M key is pressed during the Memory-Scan Memory operation, the Memory-Scan Memory operation is canceled, ordinary Memory Scan operation begins, and "Memory Scan" is displayed.
- 4 To cancel the Memory Scan or Memory-Scan Memory operation, press the CLR key. The display which was shown prior to starting the Memory-Scan Memory operation is shown again.

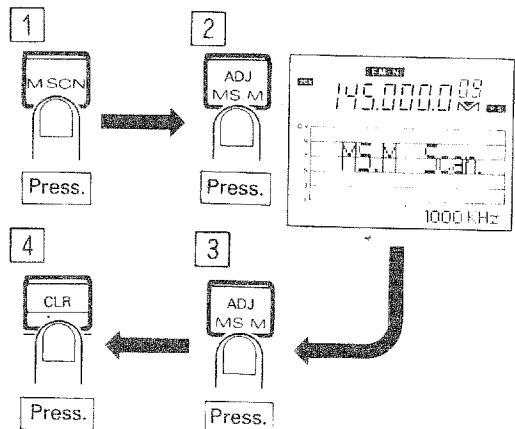

**3. To remove a frequency from the list of frequencies used by the Memory-Scan Memory operation, use the following procedure.**

**Procedure**

- 1 Press the MR key.  
A memory address number is displayed together with "M".
- 2 Recall the memory address number to be eliminated from the list of numbers used by the Memory-Scan Memory operation, and press the ADJ/MS.M key. "▼" disappears from the display, and the frequency will not be scanned in future Memory-Scan Memory operations.

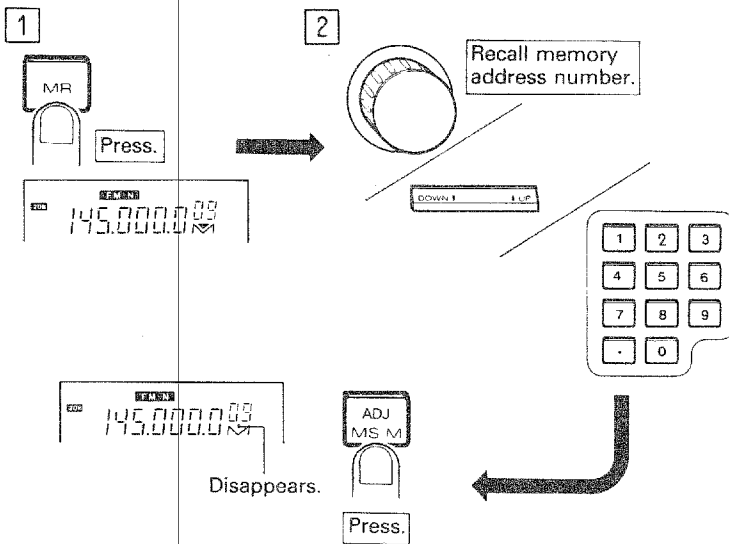

## How to Select the Desired Frequency by Automatically Searching a Specific Frequency Range

### Search operation

1. The Search feature allows the user to check for the presence of signals in a specified frequency range, and is different from the Memory Scan feature which allows the user to check only specific memory frequencies.

Before starting the Search operation, it is necessary to select the frequency range.

The first frequency in the range is called the start frequency, and the last frequency is called the end frequency. These two frequencies should be set and placed together in one of the search address numbers.

The start and end frequencies can be changed as desired.

2. In order to distinguish search address numbers from memory address numbers, the former are displayed as "Px" ("x" is a number).

Ten search address numbers (P0 to P9) can be used, allowing the selection of ten frequency ranges.

3. For example, it is convenient to set the search address numbers as follows.

Set the start and end frequencies of an amateur band in search address number P0, those of the personal band in P1, those of the marine band in P2, those of the air band in P3, and so on.

### Examples of search address number settings

Address No.	Band	Set Frequencies		Search Range
		Start Freq.	End Freq.	
P0	Amateur	144.000.0	148.000.0	From 144.000 to 148.000.
P1	Amateur	438.000.0	450.000.0	From 438.000 to 450.000.
P2	Marine	156.000.0	164.000.0	From 156.000 to 164.000.
P3	Air	118.000.0	136.000.0	From 118.000 to 136.000.
P4		Not set	Cannot be set	All frequencies are searched beginning from the frequency being displayed.

### Types of Search operations

Type	Set Frequencies		Content of Search Operation
	Start Freq.	End Freq.	
1	144.000.0	146.000.0	Range from 144.000 to 146.000 is searched.
2	80.000.0	70.000.0	Range from 80.000 to 70.000 is searched, and the range from 70.000 to 80.000 is skipped.
3	100.000.0	Not set	Search is started from 100.000 and all bands are searched.
4	Not set	Not set	Search is started from frequency being displayed and all bands are searched.

When a Type 2 search is performed, the UP/DOWN keys function as follows.

The UP key is effective during Search in the range

from 50.000.0 to 69.000.0.

The DOWN key is effective during Search in the range from 81.000.0 to 904.995.0.

## Example of Search operation (Searching the amateur bands)

Use the following procedure when performing the first Search operation after purchasing the unit or after the unit has been reset.

**First, make preparations for searching the amateur band.**

**The display should show the following.**

- **Start frequency:** 144,000.0  
Operate the numeric keys, rotary channel selector, or UP/DOWN keys to display the start frequency of 144,000.0.
- **Channel step:** 20 kHz  
Press the STEP key to display the channel step of 20 kHz.
- **Reception mode:** FM-N (initial setting)
- **Band Scope receiving bandwidth:** 1000 kHz (initial setting)

### Setting the search range

**To set the start frequency, use the following procedure.**

#### Procedure

- 1 Press the MR key to enter the Memory Recall mode.
- 2 Press the P.SER key to recall a search address number.  
The Band Scope shows "Start Freq." and memory address number "Px" together with "M".  
  
1) "M" appears only when the frequencies have been set.  
2) If the unit has ever been put in the Memory Recall mode, the memory address number recalled at that time is displayed. To change the memory address number, use the numeric keys, the rotary channel selector, or the UP/DOWN keys.
- 3 If the start frequency has not been set, press the ENT/MW key.  
(144,000.0 MHz will be set as the start frequency.)  
If the start frequency has been set previously, press the MC key to change its content.

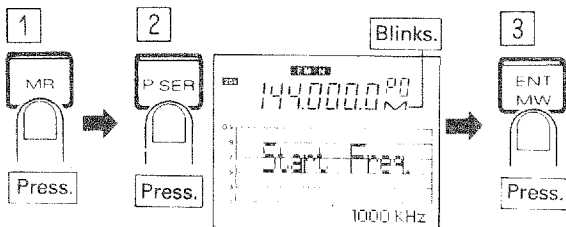

**Then, set the end frequency as follows.**

- 1 After the above, press the UP key.  
The Band Scope shows "End Freq.".
- 2 Press the MC key.  
The Band Scope shows "End Change".
- 3 Enter the end frequency of "146,000.0" with the numeric keys, the rotary channel selector, or the UP/DOWN keys, and press the ENT/MW key.  
When the setting is completed, a high beep sound is generated and the Band Scope display is changed to "End Freq."
- 4 Press the CLR key to return to the VFO mode.  
The preparations for the Search operation are now complete.  
To start the Search operation, use the procedure on the next page.

#### Caution

**The end frequency cannot be set unless the start frequency has already been set.**

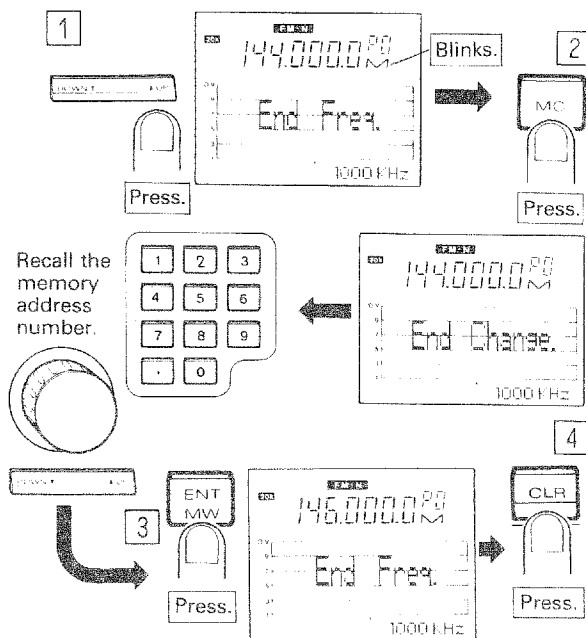



## Performing a Search operation

### Procedure

- 1 Press the P.SER key. The Search operation starts and the frequencies are varied in sequence. The display shows "Px" together with "M", and the Band Scope shows "Program Sear.". The MHz and kHz dots on the display blink.
- 2 To pause Search temporarily, press the P.SER key again.
- 3 If the same numeric key as the search address number being displayed is pressed, "Program Sear." on the Band Scope disappears while the Search operation continues, and the Band Scope function begins, allowing the signals to be checked visually.
- 4 If the F.ACQ/M.SFT or ENT/MW key is pressed, the Search operation is canceled, and reception begins on the frequency which was displayed when the F.ACQ/M.SFT or ENT/MW key was pressed.
- 5 If the CLR key is pressed, the Search operation is canceled and the unit returns to its status prior to the beginning of the Search operation.

### Advice

The MC key is used when changing a frequency in memory.

If it is pressed while "Start Freq." is displayed, "Start Change" will be displayed. If it is pressed while "End Freq." is displayed, "End Change" will be displayed. If the key is pressed after recalling a frequency from memory, "Memory Change" will be displayed.

If the P.SER key is pressed while "Program Sear." is displayed, the Search is paused temporarily.

During pause, the MHz and kHz dots blink at shorter intervals.

Pressing the P.SER key again cancels the pause.

When changing the band to be searched, press the numeric button for the required band.

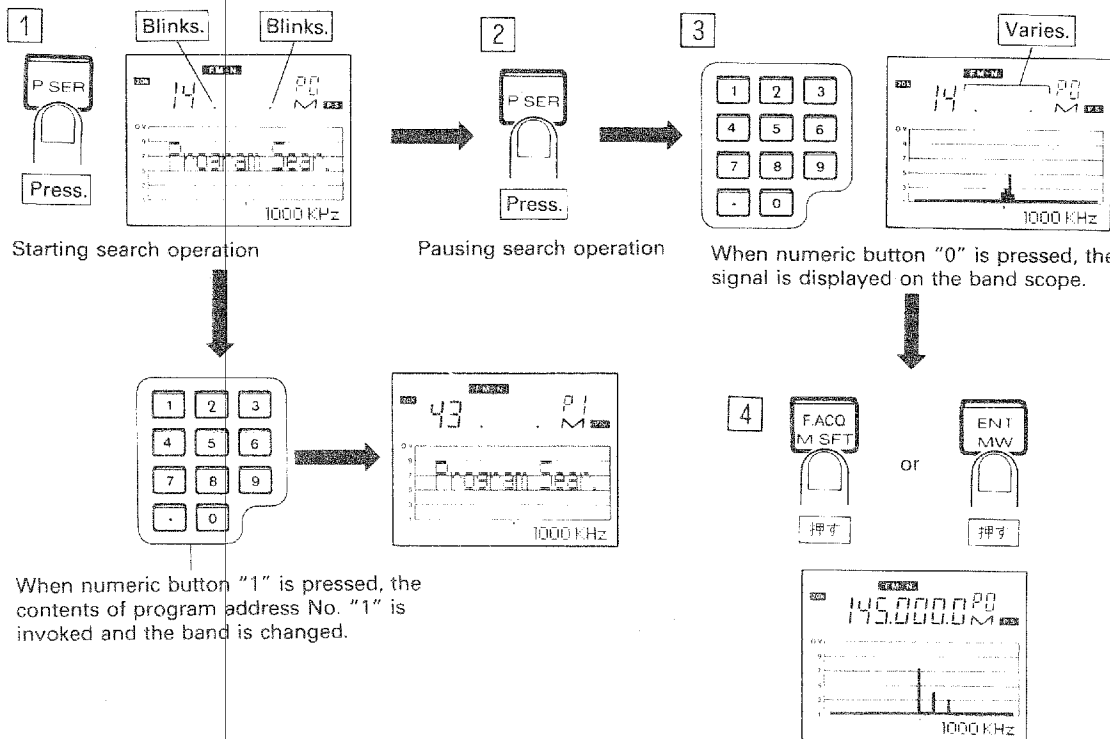

## Changing the search range

To change the start frequency, use the following procedure.

### Procedure

- 1 Press the MR key.  
A memory address number is displayed together with "M".
- 2 Press the P.SER key.
- 3 Recall the address number of the frequency to be changed with the numeric keys or the rotary channel selector.  
The Band Scope shows "Start Freq.".
- 4 Press the MC key.  
The Band Scope shows "Start Change", indicating that the start frequency is ready to be changed.
- 5 Set a new start frequency with the numeric keys or the rotary channel selector, and press the ENT/MW key. A high beep sound is generated indicating that the start frequency has been changed, and the Band Scope shows "Start Change".
- 6 Press the CLR key to return to the VFO mode.

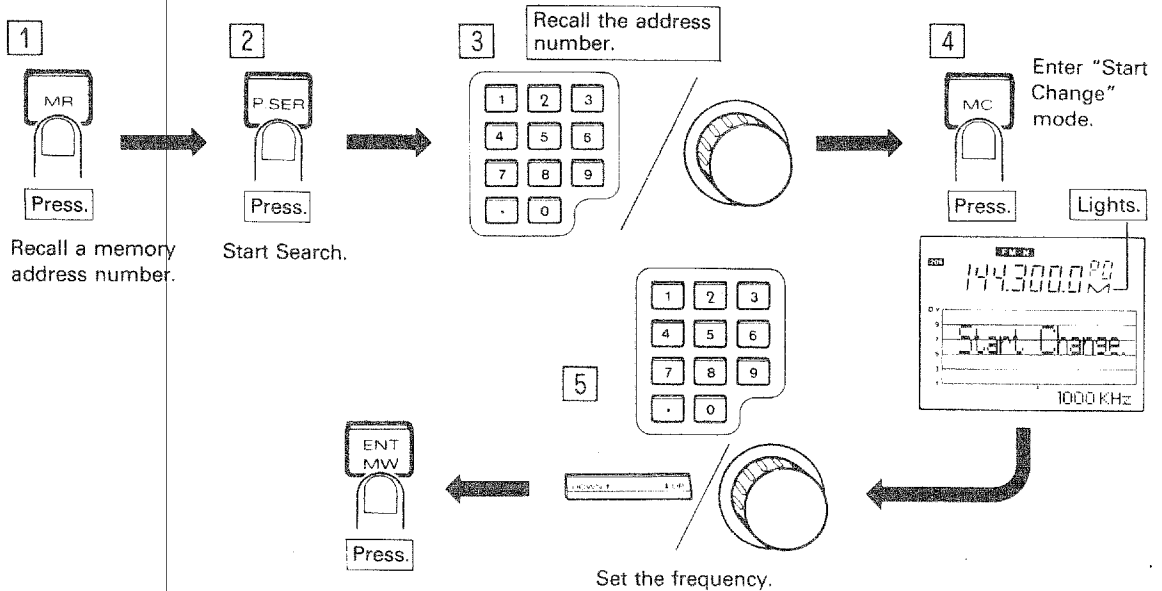

To change the end frequency, use the following procedure.

**Procedure**

- 1 Press the MR key.  
A memory address number is displayed together with "M".
- 2 Press the P.SER key.  
The Band Scope shows "Start Freq."
- 3 Recall the address number of the frequency to be changed with the numeric keys or the rotary channel selector.
- 4 Press the UP key. The Band Scope displays "End Freq." in place of "Start Freq."

- 5 Press the MC key.  
The Band Scope shows "End Change", indicating that the end frequency is ready to be changed.
- 6 Set a new end frequency with the numeric keys or the rotary channel selector, and press the ENT/MW key. A high beep sound is generated indicating that the end frequency has been changed, and the Band Scope shows "End Freq." in place of "End Change".
- 7 Press the CLR key to return to the VFO mode.

**Advice**

- 1 When the DOWN key is pressed, the Band Scope shows "Start Freq.", and the start frequency appears on the display.
- 2 In search-frequency change operations, the UP/DOWN keys are used to recall the start and end frequencies.

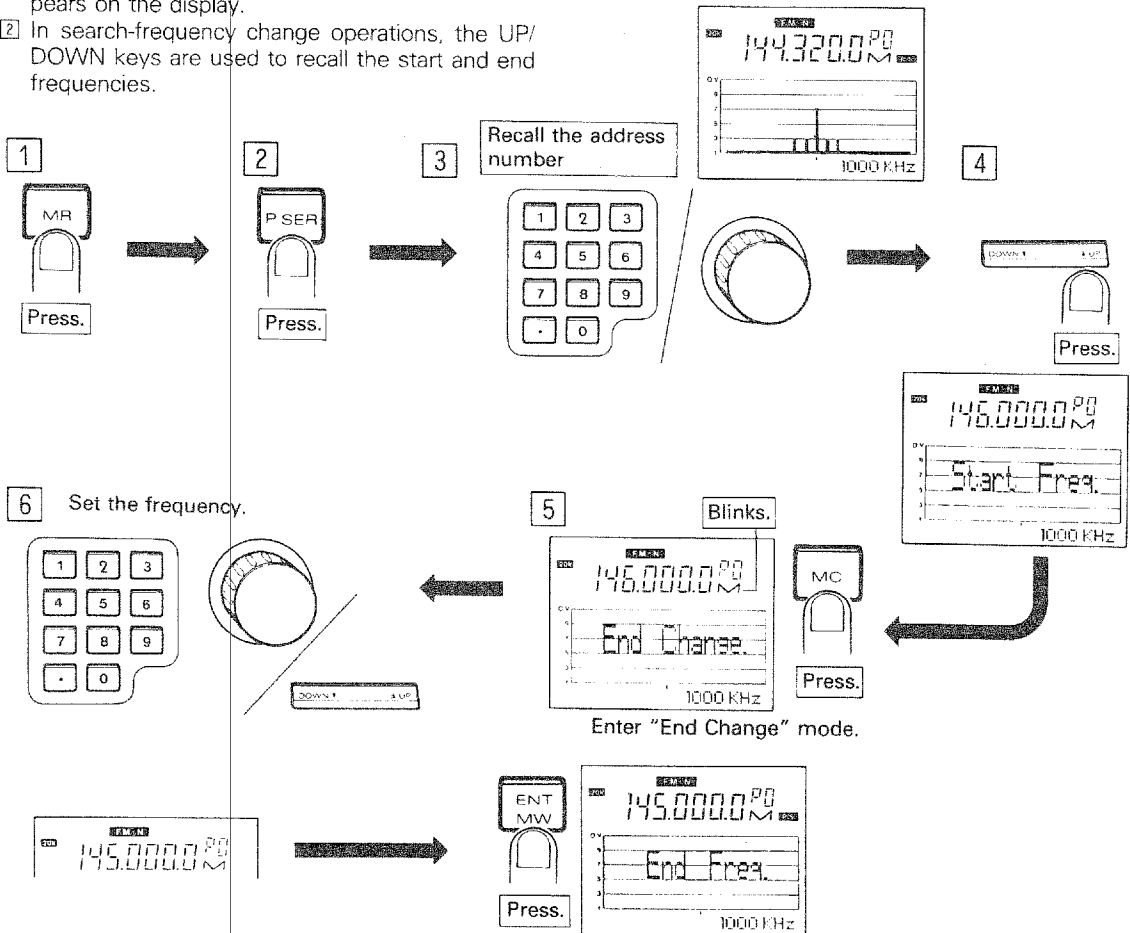

## Clearing the search range

### Procedure

- 1 Press the MR key.
- 2 Press the P.SER key.
- 3 Recall the address number of the frequency to be changed with the numeric keys or the rotary channel selector.  
The Band Scope shows "Start Freq."
- 4 Press the UP key. The Band Scope displays "End Freq." in place of "Start Freq."  
When changing the start frequency, it is not necessary to press the UP key.
- 5 Press the M.CL key.

A high beep sound is generated indicating that the frequency has been cleared, and "M", which has been blinking, lights steadily.

- 6 Press the CLR key to return to the VFO mode.

### Caution

When the contents of "Start Freq." are cleared, the contents of "End Freq." are also cleared. However, the contents of "End Freq." can be cleared without affecting the contents of "Start Freq."

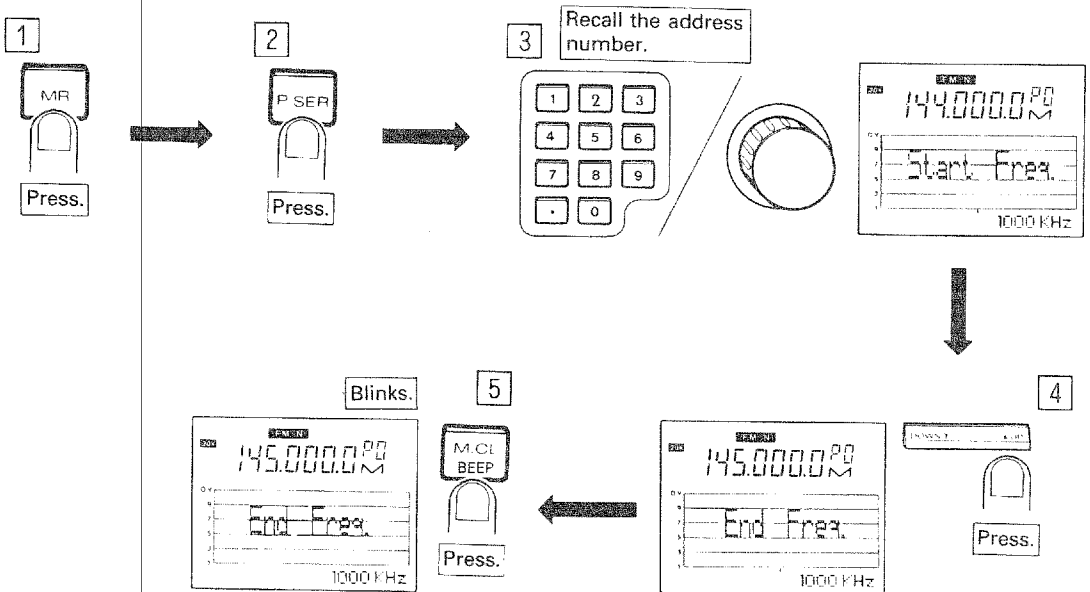

---

### Types of Search operations

The CCR708A provides the following four type of Search operations for finding a desired frequency.

**1. Searching in a range between two specified frequencies.**

(The display shows "Program Sear..")

Set the start frequency and the end frequency in a search address number.

**2. Searching outside the range between two specified frequencies.**

(The display shows "Program Sear..")

Set the start frequency, then set an end frequency which is lower than the start frequency.

**3. Searching all receivable frequencies starting from the frequency being displayed (VFO frequency).**

(The display shows "Normal Sear..")

Set no frequency in one of the search address numbers, recall that address number, and start Search operation.

**4. Searching all receivable frequencies starting from a specified frequency.**

(The display shows "Program Sear..")

Set only the start frequency, without an end frequency, in a search address number.

### Other Features

#### Automatic frequency correction

When a frequency is input using the numeric keys, the displayed frequency is corrected automatically according to the channel step being used. Also, when the rotary channel selector or UP/DOWN key is operated to vary the frequency by a certain channel

step from the frequency being displayed, the destination frequency is corrected automatically.

The following tables show the results of the correction with different channel steps.

---

## NOTE ON LITHIUM BATTERY

The CCR708A incorporates a lithium battery for use as a backup power supply for the microcomputer, allowing memory contents to be maintained even after the power is switched off.

If the lithium battery becomes exhausted, the frequency is not displayed properly when the POWER

switch is turned ON. In such a case, replace the lithium battery and, after replacing with a new one, be sure to press the RESET button on the rear panel. Note that all of the memory contents are cleared when the RESET button is pressed.

# TROUBLESHOOTING

**Q The frequency is not displayed properly.**

The frequency display may become improper when the lithium battery becomes exhausted, right after the lithium battery is replaced, or if the microcomputer malfunctions.

**A** Replace the lithium battery and, after replacing, press the RESET button on the CCR708A rear panel.

Be sure to switch the power ON before pressing the RESET button.

**Q The frequency display becomes erroneous every time the POWER switch is turned ON or OFF.**

**A** The lithium battery is exhausted. Replace it and press the RESET button.

**Q Signals cannot be received.**

Check to see if the SQL control is turned fully clockwise.

**A** Turn the SQL control fully counterclockwise, and then turn it slowly clockwise until the rain-like noise disappears (this completes the SQL adjustment).

**Q Several black bars are observed on the Band Scope, but no signal is received.**

If the unit is operated near a personal computer, word processor, or other OA (Office Automation) equipment, signal reception may be subject to radio interference from the equipment.

**A** Place the unit farther away from interfering equipment.

**Q Channel step cannot be changed (with STEP key).**

The STEP key is invalid while "AJ" is displayed.

**A** Press the ADJ/MS.M key so that "AJ" disappears from the display.

**Q FM broadcast sound is extremely distorted.**

FM stations should be received in the FM-W mode.

**A** Press the MODE key so that "FM-W" is displayed.

**Q The scanning method cannot be changed.**

The scanning method can be changed only during Memory-Scan operation.

**A** Press the M.SCN key to start the Memory-Scan, then press the MODE key to change the scanning method.

# SPECIFICATIONS

Reception frequency range .....	50 to 904.995 MHz
Radio wave formats .....	A3 (AM), F3 (FM-Wide, FM-Narrow)
Antenna impedance .....	50 ohms
Frequency steps .....	10 kHz, 12.5 kHz, 20 kHz, 25 kHz (ADJ mode; 5 khz, 1 kHz with UP/DOWN keys)
Number of memory channels .....	100 channels
Number of Program Search memory locations .....	10 locations
Reception sensitivity .....	AM (10 dB S/N): Less than 3 $\mu$ V FM-N (12 dB SINAD): Less than 1.5 $\mu$ V FM-W (12 dB SINAD): Less than 1 $\mu$ V (83 MHz)
Squelch sensitivity (FM-N mode) .....	Less than 0.2 $\mu$ V
Audio outputs .....	Ext. speaker jack: More than 1.8 W (8-ohm, distortion 10%, input FM 1 kHz 3.5 kHz DEV) REC jack: 30 mV (load 100 kilohms) 8 V power output: 8 V, 40 mA max.
Power supply .....	13.8 V DC 15%
Current consumption .....	1 A (audio output 2 W)
Grounding method .....	Negative grounding
Dimensions .....	180(W) $\times$ 75(H) $\times$ 180(D) mm (excluding projections)
Weight .....	2.1 kg (including antenna and stand)

## ONE YEAR LIMITED WARRANTY

Standard Amateur Radio warrants this product to be free from defects in workmanship and material under normal use and conditions for a period of one year from the date of original purchase.

Should service be required by reason of any defect or malfunction during the warranty period, Standard Amateur Radio will repair or in its discretion replace this product during the one year period provided that the defective unit is returned prepaid to Standard Amateur Radio with a copy of the original sales invoice as proof of purchase.

In-warranty repairs must be done by Standard Amateur Radio or by a service center specifically authorized to repair Standard Amateur Radio products.

Except as set forth above, Standard Amateur Radio disclaims all warranties of any nature whatsoever, including, without limitation, any implied warranty, of merchantability, fitness for a particular purpose, or otherwise and any express warranty. In no event shall Standard Amateur Radio be liable for any loss, inconvenience or damage whether direct, incidental, consequential or otherwise resulting from breach of any express or implied warranty, of merchantability, fitness for a particular purpose, or otherwise, with respect to the product, except as set forth herein. Some states do not allow limitations on how long an implied warranty lasts and some states do not allow the exclusion or limitation of incidental or consequential damages, so the above limitation or exclusions may not apply to you.

In the event the remedy set forth in the first paragraph fails of its essential purpose to remedy a breach of the express warranty set forth in the first paragraph, the sole remedy will be limited to return of the purchase price paid for the product.

This warranty does not cover damage which results from modification, accident, misuse, abuse, fire, flood, lightning or other acts of God or damage resulting from repairs or alterations performed other than by Standard Amateur Radio.

This warranty gives you specific legal rights, and you may also have other rights which vary from state to state.

Standard Amateur Radio Products, Inc.  
P. O. Box 48480  
Niles, Illinois 60648

“Check Attenuator Pad for proper setting”

Freq. 50 to 905 MHz

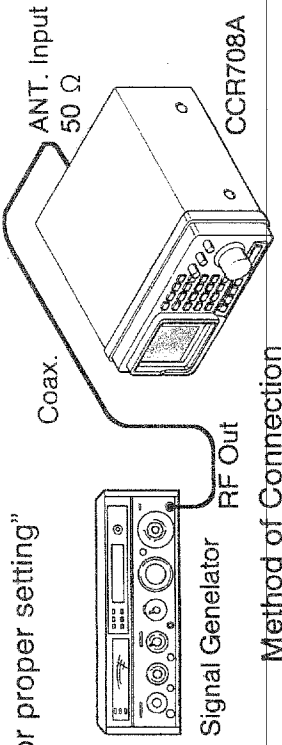

Method of Connection

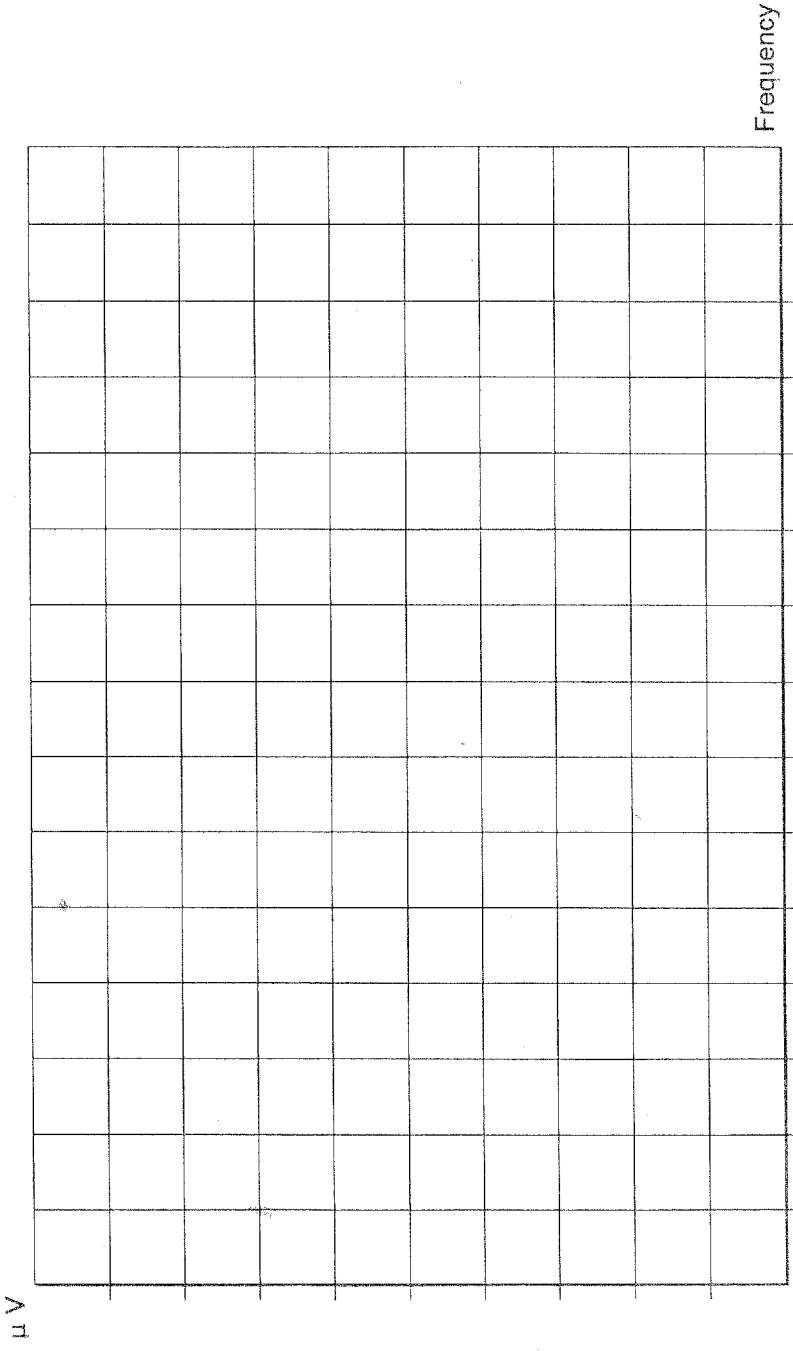

Bench TECH. Measurements