

ALINCO

UHF FM TRANSCEIVER

DJ-S446

Instruction Manual

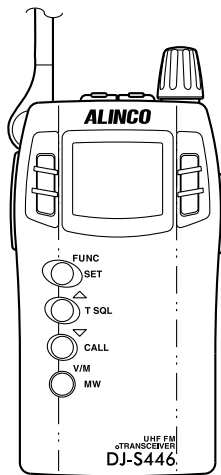

Thank you for purchasing this ALINCO FM transceiver.

This instruction manual contains important safety and operating instructions.

Please read it carefully before using the transceiver and be sure to keep it for future reference.

ALINCO, INC.

Contents

■Points to Note when Using an External Power Supply

1. Accessories	2
1-1 Standard Accessories	2
1-2 Attaching and Detaching Accessories	2
1-2-1 Hand Strap	2
1-2-2 Belt Clip	2
1-2-3 Battery Pack	3
1-3 Battery Level Indicator	4
1-4 Loading Batteries	4
2. Control Functions	5
2-1 Names and Operations of Transceiver Controls	5
2-2 Key Operations	7
2-3 Display	9
3. Basic Operations	10
3-1 Turning the Power ON	10
3-2 Adjusting the Audio Volume	10
3-3 VFO Mode	10
3-3-1 Frequency Number Setting	10
3-4 Memory Mode	11
3-4-1 Selecting a Memory Channel	11
3-4-2 Memory Channel Programming	12
3-4-3 Clearing a Memory Channel	13
3-4-4 Contents of Memory Programming	13
3-5 CALL Mode	14
3-5-1 Selecting the CALL Channel	14
3-5-2 Programming a CALL Channel	14
3-6 Receiving	15
3-6-1 Monitor Function	15
3-7 Transmitting	16
3-7-1 Selecting the Transmitter Output Level	16

4. Parameter Setting Mode	17
4-1 Mode Setting Items	17
4-2 Selecting the Setting Mode	18
5. Advanced Operations	22
5-1 Scanning	22
5-1-1 VFO Scan	23
5-1-2 Memory Scan	23
5-1-3 Skip Channel Setting	24
5-1-4 Tone Scan	24
5-2 Key Lock	25
5-3 Tone Call	25
5-4 Lamp	25
6. Selective Communicating	26
6-1 Tone Squelch	27
7. Special Functions	28
7-1 Theft Alarm	28
7-1-1 Connecting and Setting	29
7-1-2 Alarm	30
7-1-3 Alarm Delay	31
8. Cloning	32
8-1 Cloning	32
9. Maintenance and Reference	35
9-1 Resetting	35
9-2 Options	36
10. Specifications	37

1

2

3

4

5

6

7

8

9

10



Caution

The use of a transceiver in the following places may be prohibited.

- Aboard aircraft •In airports •In ports •Within or near the operating area of business wireless stations or their relay stations.

Before using the transceiver in any of the above places, obtain any necessary permission from the proper authorities, and be mindful of local laws that govern amateur radio operation.

■Points to Note when Using an External Power Supply

- Use a 4.5V-16.0 DC external power source.
- When connecting the power supply to the transceiver, use the optional DC cable for base stations (EDC-37). Connect the cable to the DC jack on the side of the transceiver.
- When power is supplied from the cigarette lighter socket of a car, use the cigarette lighter cable (EDC-43) or the cigarette lighter cable with filter (EDC-36).

Use the cigarette lighter cable with filter (EDC-36) during mobile operation to help prevent noise.

- Turn the transceiver's power off when connecting or disconnecting the DC cable.

1. Accessories

1-1 Standard Accessories

- Battery Case EDH-31
- Belt Clip
- Hand Strap
- Instruction Manual

(Note : Standard accessories may vary depending on versions.)

1-2 Attaching and Detaching Accessories

1-2-1 Hand Strap

1. Attach the hand strap in the upper slot (at the rear of the transceiver) as shown in the illustration.

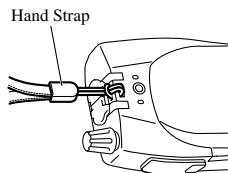

1-2-2 Belt Clip

1. Put the Belt Clip on the back of the transceiver as shown in the illustration.
2. Turn the screw clockwise until it stops.

Check to be sure the clip is securely connected.

3. Turn the screw counter-clockwise to detach the Belt Clip.

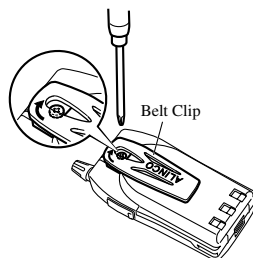

1-2-3 Battery Pack (Option)

1. Attaching the battery pack:

Align the grooves on the battery pack with the rib on the transceiver, and push in the direction of the arrow until it clicks.

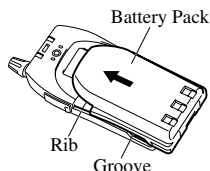

2. Detaching the battery pack:

Push down the catches at the bottom of the transceiver, and slide the battery pack off in the direction of the arrow.

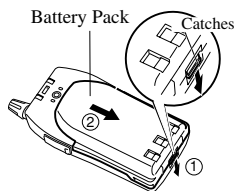

Caution

- The battery pack is not charged when shipped. It must be charged before using.
- It takes a maximum of 10 hours to charge the battery pack with the EDC-93 (120V) / EDC-94 (230V)(EBP-52N / EBP-53N) and about 30 hours with the EBP-54.
- Charging should be conducted within a temperature range of 0 to 40°C. (32-104°F)
- Do not convert or dismantle the battery pack and do not place it in fire or water. Such practices are dangerous. Never short-circuit the battery pack terminals, as this can cause damage to the equipment or lead to overheating the battery, which could cause burns. Unnecessary prolonged charging (overcharging) can deteriorate battery performance.
- The battery pack should be stored in a dry place where the temperature range is -20°C to -45°C (-4°F to +113°F).
Temperatures outside this range can cause battery liquid leakage. Exposure to prolonged high humidity can cause corrosion of metal components.
- Normally, the battery pack can be charged up to 500 times. However, the battery pack can be considered dead if usable time drops off markedly in spite of charging the pack for the recommended time. When this happens, a new pack should be used.
- To protect the environment, do not dispose of the used battery pack improperly. Check with your local solid waste officials for details on recycling the battery pack for proper disposal in your area.
- To charge the battery pack, mount it on the transceiver, connect 13.8VDC to the DC power supply jack and set the unit's battery charging function ON in the Setting mode.

1-3 Battery Level Indicator

- Battery charge level may change in relation to ambient air temperature or the amount of use.
- Even if the charge indicator appears to show the need for charging or replacing batteries, the transceiver may still be used for reception or low output transmission.
- Modify the battery type setting in the Setting mode when the battery pack type is changed.

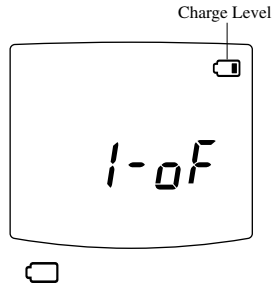

When the charge level becomes low, an empty battery mark appears. Charge (or replace) the battery.

1-4 Loading Batteries

1. Load three (3) commercially available AA alkaline batteries in the battery case (EDH-31). Set the batteries in the battery case in the +/- orientation marked at the bottom of the case.
2. Attach the battery case in the same method of the battery pack (page3).

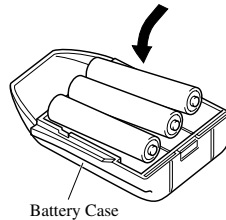

⚠ Caution

- Manganese batteries are not recommended as they may decrease the transmission output level.
- Be sure to observe proper orientation of the batteries polarity (+ -).
- Switch off the battery transceiver's charge function when dry cell batteries are used.

2. Control Functions

2-1 Names and Operations of Transceiver Controls

■ Top and Front Views

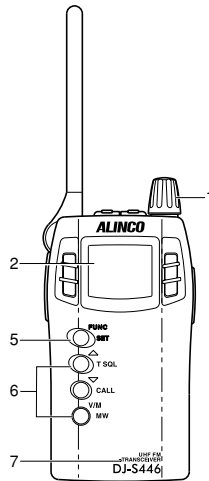
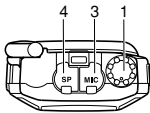

No.	Name	Functions
1	Power Switch Volume	Switches power ON/OFF. Also used to adjust the audio volume.
2	Display (LCD)	Refer to "Display" in this manual (Page9).
3	MIC Connector	For connection of the optional external microphone (2k Ω) with 2.5 ϕ stereo plug.
4	SP Connector	For connection of the optional external speaker (8 Ω) with 3.5 ϕ monophonic plug.
5	FUNC key	Use this key in combination with other keys to access various functions of the transceiver. Holding this key for 3 seconds activates the Setting mode where various settings are possible.
6	Key pad	Refer to "Key Operations" (Page7).
7	Microphone	Speak into microphone from a distance of approx. 5 cm.

■ Side View

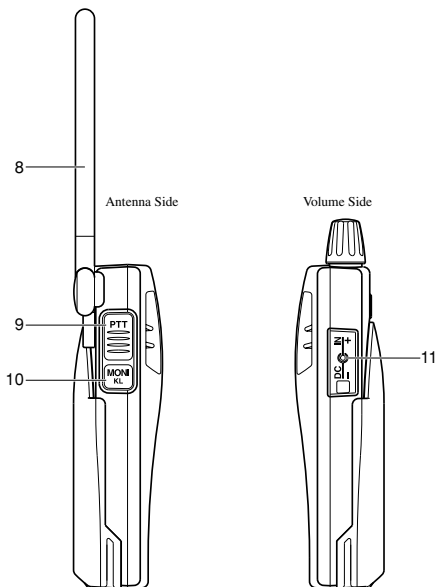

No.	Name	Functions
8	Antenna	Pivot the antenna up when using the transceiver.
9	PTT (press to talk) key	When this key is held down, the transceiver transmits. When the key is released, the transceiver receives.
10	MONI key	When this key is pressed, the squelch is unmuted and you can hear received signals. The squelch is also unmuted when the tone squelch is set. If this key is pressed while FUNC appears, the Key Lock function is activated. Pressing this key while the PTT key is pressed and held transmits the tone call signal.
11	DC-IN	Terminal for connecting an external power supply. Connect the optional cigarette lighter cable with filter (EDC-36), and you can use it in the car. The center of the pin is the + (positive) pole and the outside is the - (negative) pole. Use a stable power supply with DC4.5-DC16.0V, with a capacity of 1A or more.

2-2 Key Operations

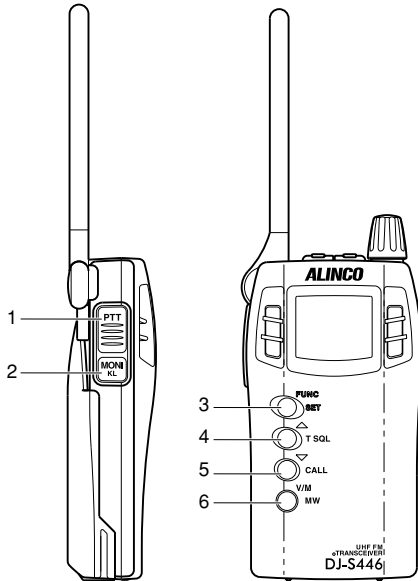

No.	Name	Independent operation	After pressing FUNC key
1	PTT	Completes the setting in the setting mode.	-
2	MONI	Activates the monitoring function.	Switches the key lock ON/OFF (page 25).
3	FUNC/SET	Accesses various functions.	-
4	▲/T SQ	Increases the frequency and memory channels.	Sets the tone squelch function (page 27).
5	▼/CALL	Decreases the frequency and memory channels.	Activates the Call mode (Page 14).
6	V/M/MW	Switches VFO/Memory modes.	Programs a memory channel (Page 12).

2. Control Functions

No.	Name	Pressed for a while	During transmission
1	PTT	Enables transmission while holding.	-
2	MONI	-	Transmits tone call signal (page 25).
3	FUNC/SET	Activates the Setting mode (page 17).	-
4	▲/T SQ	Starts upward scanning (page 22).	Sets the transmission output level HIGH (page 16).
5	▼/CALL	Starts downward scanning (page 22).	Sets the transmission output level LOW (page 16).
6	V/M /MW	-	-

2-3 Display

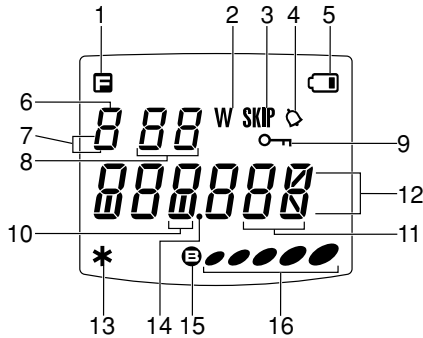

No.	Display	Indication
1		Appears when the FUNC key is pressed.
2	W	Blinks during memory writing mode.
3	SKIP	Appears on Memory scan skip channel(s).
4		Appears when the Bell Function is on.
5		Appears when the charge level is low.
6		Appears when the Mosquito Repellent Signal (MRS) is ON.
7	L	Appears when transmission output level is LOW.
8	BB	Indicates memory No. in the Memory mode and setting No. in the Setting mode.
9		Appears when keys are locked.
10		Indicates the frequency number.
11	BB	Indicates the tone number.
12	BBBBBB	Indicates the various setting status.
13	*	Appears when the Theft Alarm is ON.
14	•	Blinks during scanning operation.
15		Appears when the squelch is unmuted.
16	 (S Meter)	Indicates the receiving level and the transmission output.

3. Basic Operations

3-1 Turning the Power ON

Hold the POWER switch down for a second to turn the power ON. To turn the power OFF, hold the power switch down again for 2 seconds.

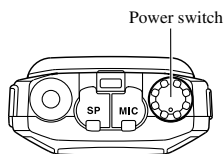

3-2 Adjusting the Audio Volume

To increase : Rotate the volume dial clockwise.

To decrease : Rotate the volume dial counter-clockwise.

When a voice cannot be heard due to the squelch setting, press and hold the MONI key and adjust the volume to the level you desire.

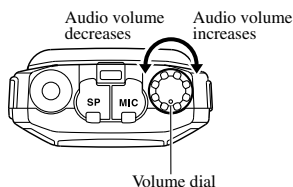

Reference: Squelch level can be adjusted in the Setting mode (page 17).

3-3 VFO Mode

The factory default setting for the transceiver is the VFO mode.

3-3-1 Frequency Number Setting

When ▲/▼ keys are pressed, frequency number increases and decreases.

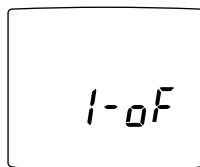

VFO mode

3-4 Memory Mode

The Memory mode is used to recall a previously programmed frequency. This transceiver has 99 memory channels (1-99CH), 1 call channel (C), and 1 alarm channel (SC).

3-4-1 Selecting a Memory Channel

Channel

1. Press the V/M key to activate the Memory mode.

Pressing the V/M key alternates the transceiver between VFO/Memory modes.

When in Memory mode, the memory channel No. appears on the display.

The Memory mode cannot be activated if there is no pre-set program recorded in the memory channels.

By pressing the ▲/▼ keys, the memory No. increases (or decreases) by one memory each time the key is pressed.

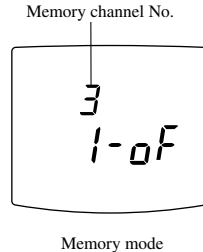

3-4-2 Memory Channel Programming

1. Return to the VFO mode by pressing the V/M key.
2. Select the desired frequency you wish to save to Memory.

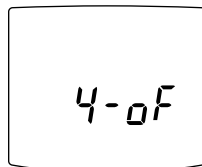

VFO mode

3. Press the FUNC key and then press the V/M key while the "F" icon appears. The memory channel No. and "W" blinks.

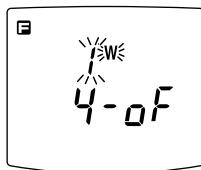

4. Select a memory channel to program by pressing the ▲/▼ keys. A blinking memory channel No. indicates that the channel is not programmed yet.
5. Press the MW key while "W" blinks. A beep is heard and the selected VFO frequency number is programmed to the memory channel.

Caution

- Please be sure to set the frequency number for alarms in CH-SC (the channel for alarms) (Page 29).
- Selecting and programming again overwrites a programmed memory channel.
- The CALL channel can also be overwritten but the CALL channel cannot be cleared.

3-4-3 Clearing a Memory Channel

1. Press the FUNC key and then press the V/M key while "F" icon appears. Memory channel No. lights and "W" blinks on the display.
2. Select a memory channel you wish to clear by pressing the ▲/▼ keys. On a programmed channel, the "memory channel No." is displayed steadily (without blinking).
3. Press the FUNC key again and then press the MW key while the "F" icon appears.
A beep is heard and the pre-set frequency is cleared.

3-4-4 Contents of Memory Programming

The following information can be stored in each memory channel 1 - 99, SC and the CALL channel.

- Frequency number
- Tone number
- Skip CH Setting
- Busy Channel Lock Out (BCLO)

3-5 CALL Mode

The Call mode is used when you are receiving or transmitting on the CALL channel. The transceiver has one CALL channel.

The default setting is "1-oF".

3-5-1 Selecting the CALL Channel

1. Press the FUNC key and then press the CALL key while the "F" icon appears. "C" appears on the display when the CALL channel is selected.

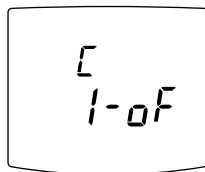

2. Press the V/M key to return to the VFO mode or the Memory mode.

- Caution**
- Scanning cannot be performed when the transceiver is in the CALL mode.
 - In the CALL mode, frequency number or memory No. cannot be changed by pressing the up/down keys.

3-5-2 Programming a CALL Channel

The CALL channel is one of the memory channels where the frequency number and other settings can be programmed by selecting the memory channel "C" in the VFO mode (page 12).

- Caution :** The CALL channel can be programmed but cannot be cleared.

3-6 Receiving

1. Turn the power ON.
2. Rotate the volume dial to set the audio volume.
3. Eliminate noise by setting the squelch in the setting mode (page 17).
4. Select the desired frequency number.

When a signal is received on the selected frequency, "B" appears on the display and the received signal is heard. The S meter indicates the relative signal strength.

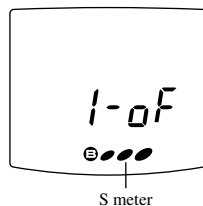

Reference : Be sure to use the transceiver in the state where the antenna is set straight up to the upper part of the transceiver.

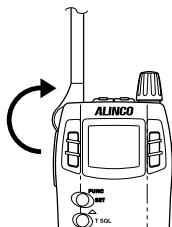

3-6-1 Monitor Function

- While the MONI key is pressed, the squelch is unmuted and sound is heard from the speaker regardless of the squelch setting. "B" appears on the display.
- By using this function, weak signals under the squelch threshold level can be heard.
- Monitoring the selected frequency can be done even when the tone squelch is set.

3-7 Transmitting

1. Select the desired frequency number.
2. Press and hold the PTT key, speak into microphone with normal loudness and tone.

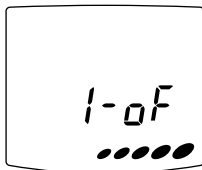

The S meter indicates the unit is in the transmitting mode.

Speak into the microphone from a distance of approx. 5cm.

3. Release the PTT key to stop transmitting and to return to the receiving mode.

Reference : A Tone call signal is transmitted by pressing and holding the PTT key and pressing the MONI key (There are five tone call signals that are selectable in the Setting mode).

3-7-1 Selecting the Transmitter Output Level

Transmission power can be changed to HI/LOW by pressing the ▲/▼ keys while transmitting.

"L" appears on the display when the transmitting power is LOW.

Initial setting is HI.

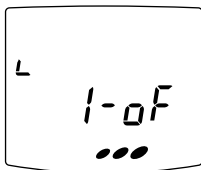

LOW

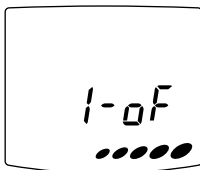

HIGH

4. Parameter Setting Mode

In setting mode, you can set various functions of the transceiver.

4-1 Mode Setting Items

The Setting ITEM No. increases when the FUNC key is pressed, and it decreases when the MONI key is pressed.

	ITEM NO.	Display	Functions (set with ▲/▼ keys)
↑ FUNC key	01	CHG-oF	Switches battery charging On and Off.
	02	Sql-07	Sets the squelch level.
	03	bEP-on	Switches the beeper On and Off.
	04	1750	Selects the call tone sound.
	05	to-oFF	Switches On/Off and sets the time of the Timeout Timer (TOT).
	06	AP-oFF	Switches On/Off and sets the time of the Auto Power Off (APO) feature.
	07	bS-on	Switches the battery save function On and Off.
	08	bEL-oF	Switches the bell function On and Off.
	09	Stb-on	Switches the stand-by-beep On and Off.
	10	bCL-oF	Switches the Busy Channel Lockout function (BCLO) On and Off.
MONI key ↓	11	StYP-t	Switches the scanning mode between timed/ busy channel.
	12	m**-oF	Sets the scan skip function of memory channels.
	13	bAt-2	Sets the battery type.
	14	SCR-oF	Switches On/Off and sets the sound of the theft alarm function.
	15	mrS-oF	Switches the mosquito repellent signal On and Off.
	16	EPo-oF	Switches external terminal controlling On and Off.

(Note) 12 Memory skip can be set only in the Memory mode.

4-2 Selecting the Setting Mode

1. Hold the FUNC key down for 3 seconds.

The display changes to indicate that the Setting mode is activated.

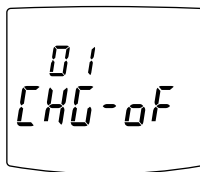

2. Select a menu you wish to set by pressing the MONI key or FUNC key.

3. Set the mode by pressing the ▲/▼.

4. Press the PTT key or V/M key.

The setting is completed and returns to the VFO mode.

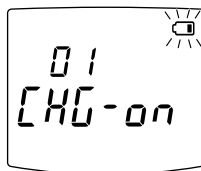

Switching battery charging
"01" On.

Reference

- The last menu operated appears the next time the Setting mode is activated.
- Monitoring cannot be performed in the Setting mode.

01 CHG-oF Battery charging ON/OFF

When ON is set, the battery pack can be charged by EDC-92/93.

The battery icon appears and blinks on the LC while charging.

Turn the power OFF while charging (Do not charge dry cell batteries!).

02 Sql-07 Squelch level setting

Mutes noise when no signals are being received.

This level is set (01/20).

03 bEP-on Beeper ON/OFF

Beeper is set ON/OFF.

04 1750 Call tone setting

The call tone output sound is selected (ALT/1000/1450/1750/2100Hz).

05 to-oFF TOT setting (seconds)

Limits the time of a single transmission (OFF/30/60/90/---/450sec).

When the TOT time value is reached, the transceiver automatically shifts to receive status.

Mode Settings Chart

No.	Display	Functions
01	CHG-oF	Battery charging ON/OFF
02	Sql-07	Squelch level setting
03	bEP-on	Beeper ON/OFF
04	1750	Call tone setting
05	to-oFF	TOT setting(seconds)
06	AP-oFF	AP0 setting(minutes)
07	bS-on	Battery saving ON/OFF
08	bEL-oF	Bell ON/OFF
09	Sib-on	Stand-by-beep ON/OFF
10	bCL-oF	BCLO ON/OFF
11	STYP-1	Scan(timed/ busy channel)switching
12	m*-oF	Scan skip setting
13	bAt-2	Battery type setting
14	SCR-oF	Theft alarm ON/OFF
15	mrS-oF	Mosquito repellent signal ON/OFF
16	EPo-oF	External terminal control ON/OFF

Please cut out or copy this Mode Settings Chart for your convenience.

06 AP-oFF APO setting (minutes)

This function prevents wasting battery power when you forget to turn the transceiver off (OFF/30/60/90/120min).

This function automatically turns off the power if there is no operation for the specified period of time.

07 bS-on Battery saving ON/OFF

The battery save function is set to extend battery life (ON/OFF).

08 bEL-oF Bell ON/OFF

The bell function can inform you a signal is being received by a tone sound and LCD indication (Bell icon).

09 Stb-oF Stand-by-beep ON/OFF

When you release the PTT key, a beep sound is transmitted informing your partner(s) your transmission has ended.

10 bCL-oF BCLO ON/OFF

When active, the ability to transmit is restricted if signals are being received.

When BCLO is on, transmitting is available only in the following cases:

- * When no signals are received ("busy" disappears).
- * When a tone matches in the TSQ setting.

11 StYP-t Scan (timed/busy channel) switching

Choose between Timed scan and Busy channel scan (TIMER/BUSY).

12 m-oF Scan skip setting**

Memory channel numbers that you want to skip while in Memory Scan are selected here.

You cannot designate channels to skip if no Memory channels have been saved.

13 bAt-2 Battery type setting

The battery type presently in use is selected and the battery charge level is indicated.

BAT-1: EBP-52N (3.6V) EBP-54N (3.6V) EDH-31 (the dry cell battery)

BAT-2: EBP-53N (6.0V)

14 SCr-oF Theft alarm ON/OFF

Theft alarm function is set (OFF/ON/DELAY).

15 mrS-oF Mosquito repellent signal ON/OFF

An ultrasonic tone, which is disliked by some mosquitoes, is output from the speaker.

Note

- There are thousands of kinds of mosquitoes. It may be ineffective against some of them.
- The battery save function is not active when MRS setting is on.

16 EPo-oF External terminal control ON/OFF

3.0V is output from the external MIC terminal when the squelch is on (5mA max).

Note : The optional VOX MIC (EME-12/13/15) cannot be used when EPO is on.

5. Advanced Operations

5-1 Scanning

The frequency number of a signal you wish to receive can be automatically sought by the scan function.

When a signal is received, scanning will stop, and resume after a while depending on the setting of the scanning mode.

■ Scanning Modes

Timed Scan :

After stopping on a busy frequency, scanning resumes when the signal ceases or five seconds later even if the channel remains busy.

Busy Channel Scan :

Scanning resumes only when the signal ceases. The receiver then moves to the next channel.

Scanning direction can be changed by pressing the ▲/▼ keys during scanning operations.

Reference : When the tone squelch is set (TSQ), if a received signal contains the tone squelch number programmed in your transceiver, scanning will stop, the squelch will unmute and the signal will be heard. If the received signal does not match the tone number you have set, the squelch is not unmuted and scanning continues.

5-1-1 VFO Scan

Scans the entire band in the VFO mode.

1. Press the V/M key to activate the VFO mode.

2. Press and hold the ▲/▼ keys for 1 to 2 seconds to start scanning.

The decimal point blinks during scanning.

Scanning direction goes upward by pressing the ▲ key, and downward by pressing the ▼ key.

3. To stop scanning, press the PTT key, the FUNC key or the V/M key.

When the MONI key is pressed, scanning stops temporarily and the monitor function is activated. When the key is released, scanning resumes.

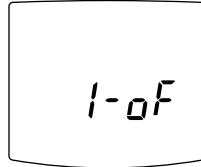

VFO Mode

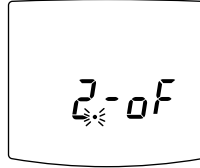

5-1-2 Memory Scan

Scans only the programmed memory channels.

1. Press the V/M key to activate the Memory mode.

2. Press and hold the ▲/▼ keys for 1 to 2 seconds to start scanning.

The decimal point blinks during the scan.

The operation is the same as with the VFO scan.

Memory No.

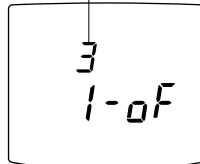

Memory Mode

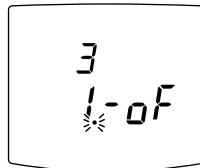

5-1-3 Skip Channel Setting

Memory channels that have "skip" programmed will not be scanned during memory scanning. Refer to page 17 for the setting method.

In the memory channel where a memory skip is programmed, "SKIP" appears on the display. The CALL channel is also a skip channel.



5-1-4 Tone Scan

This is a function to help you find the tone signal number of a received tone signal.

1. Press and hold the ▲/▼ keys for 1 to 2 seconds in the tone squelch setting mode.

Scanning starts and the decimal point blinks.

38 different Tone Number are scanned in order.

If a tone signal number is found, scanning stops and you can hear the received signal.

Scanning will not resume until the ▲/▼ keys are pressed again.

2. After scanning stops, the Scan mode is canceled by pressing the PTT key, the FUNC key or the V/M key.



5-2 Key Lock

This is a function that prevents unintentional operations when the keys are pressed accidentally.

1. Press FUNC key, and press MONI key while "F" icon appears.

"" appears to indicate the key lock function is activated.

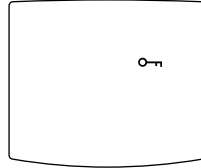

2. To cancel the key lock, press FUNC key again, and then press MONI key.

Reference : When the keys are locked, only the PTT and the MONI keys are active. All other keys are inoperative.

Transmitting and monitoring operations are possible even when the key lock function is activated.

5

5-3 Tone Call

Use this function to call a partner or activate certain types of repeaters by adding a tone signal to the transmitted radio wave.

The Tone signal is output when the MONI key is pressed down and the PTT key pressed and held.

A specific call tone sound can be selected in the Setting mode.

Caution : A tone call signal cannot be output with a tone ENC signal. During call tone output, the ENC signal cannot be transmitted.

5-4 Lamp

The transceiver has lamps to light its display, which is useful when operating in a dark place or at night.

When any keys (other than PTT and MONI) are pressed, the lamps illuminate for five seconds.

If you turn the power on while pressing the MONI key, the lamps remain lit all the time.

To return to five-second-lighting, turn the power off, and then turn the power on again with the MONI key pressed.

6. Selective Communicating

When communicating with a specific station, the tone squelch (CTCSS) function can be used. Tone squelch is a function that enables you to receive a partner's signal when the transmitted tone frequency matches your station's tone frequency.

There are 38 different selectable tone number (frequencies)

No.	Frequency	No.	Frequency	No.	Frequency	No.	Frequency
1	67.0	11	97.4	21	136.5	31	192.8
2	71.9	12	100.0	22	141.3	32	203.5
3	74.4	13	103.5	23	146.2	33	210.7
4	77.0	14	107.2	24	151.4	34	218.1
5	79.7	15	110.9	25	156.7	35	225.7
6	82.5	16	114.8	26	162.2	36	233.6
7	85.4	17	118.8	27	167.9	37	241.8
8	88.5	18	123.0	28	173.8	38	250.3
9	91.5	19	127.3	29	179.9		
10	94.8	20	131.8	30	186.2		

6-1 Tone Squelch

1. Press the FUNC key, then the ▲ key while "F" icon appears.

"oF" icon blinks.

Press FUNC key then the ▲ key again while "F" icon appears.

Blinking "oF" is replaced with a blinking number (tone number : default value is 08).

By repeating this process, the display rotates as shown in the figure to the right.

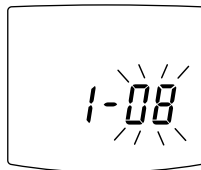
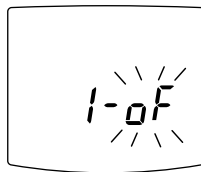

2. Change the Tone Number with ▲/▼ keys.

While the tone number is displayed, press the ▲ or ▼ key to select the tone number to use from among the tone list.

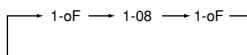

3. Press the PTT key or the V/M key to complete the setting and return to the normal mode.

Reference : During the setting operation, monitoring can be performed by pressing the MONI key.

Caution : A high tone frequency setting could cause the squelch to open in response to the characteristics of some voices. To decrease the chances of this occurring, be sure to use the regular squelch together with the tone squelch function.

7. Special Functions

7-1 Theft Alarm

The transceiver has a theft alarm function that generates an alarm sound from the speaker when a person not knowing the proper procedures removes the unit. This function is useful when installing the unit in a remote place or in a car.

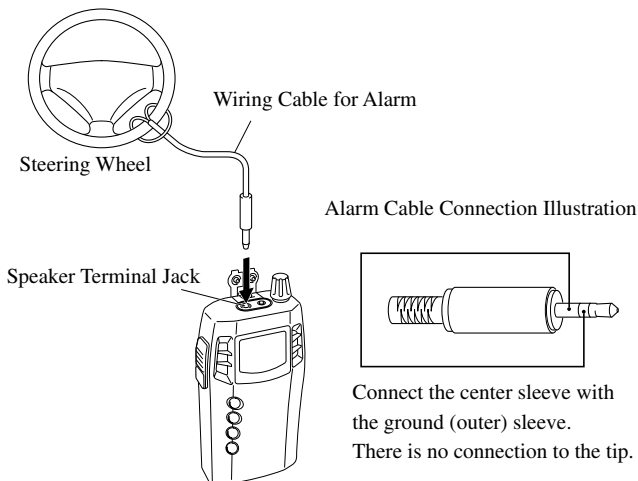

7

⚠ Caution

Cables A and B used with the alarm feature in our DR-135/235/435 products cannot be used with this unit (the wiring is different).

7-1-1 Connecting and Setting

1. Insert the plug of the alarm cable into the speaker terminal jack.

Caution

- Position the alarm cable and transceiver firmly so that it will not be easily detached.
- Program the CH-SC (for alarm) memory in advance to cancel the alarm (page 12).
- Set CH-SC (for alarm) in the state where the squelch is activated.

2. Select "SCr-on" in the Setting mode.

"*" appears on the display.

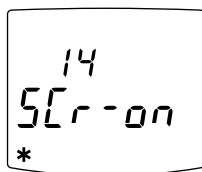

3. Turn OFF the power switch of the transceiver.

Alarm setting will then turn ON.

4. To cancel the alarm setting, turn the power ON, and select "SCr-oF" in the Setting mode.

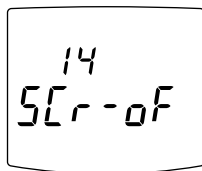

Caution

- When setting the theft alarm function, connect the alarm cable before turning the power OFF.
- The alarm may start sounding if the plug is inserted after turning the power OFF.

7-1-2 Alarm

When the cable is pulled out or cut, the alarm will start sounding.

While alarming, all of the key operations are disabled including the power switch.

However, receiving is activated on the frequency recorded in the CH-SC (alarm channel).

■ How to Stop the Alarm

When a signal is received and the squelch is unmuted during the alarm, the alarm is canceled and the unit returns to the "receive" mode (A TSQ setting is also a valid squelch setting).

It is possible to cancel the alarm using another transceiver from a remote place.

1. To cancel the alarm, detach the battery pack.
2. To set the alarm again, attach the battery pack and turn the power OFF.

Caution : Use the same battery pack that was in place when the alarm function was activated (if an external power supply is used, the alarm will continue sounding).

7-1-3 Alarm Delay

When this function is set, the alarm starts sounding after an interval.

1. Set the alarm function to "SCr-dL" in Setting mode "14".

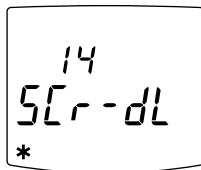

2. Insert the plug of the alarm cable, and turn the power of the transceiver OFF.

In this setting, the alarm will not sound until 10 seconds after the plug is detached.

If the cable is detached during the alarm setting procedure, the alarm will start sounding 10 seconds later.

- Caution**
- It is recommended that you use the tone squelch when setting the CH-SC (for alarm), since there is the considerable possibility that the alarm setting could be canceled by reception of any random signal.
 - Set the alarm function off (SCr-oF) during regular operation.
 - If the CH-SC (for alarm) memory is not programmed, you can stop the alarm by sending a signal on the same frequency appearing on the display, in the VFO mode.

8. Cloning

8-1 Cloning

When using the cloning function, all setting information (including memory data) of one transceiver (master unit) can be transferred and copied to another transceiver (slave unit) by connecting them with a cable.

■ Connecting the Transceivers

Connect the external speaker jacks on both the master and slave transceivers with a commercially available $\varnothing 3.5$ stereo mini plug cable.

After connecting them, switch the both units' power ON.

Caution : Connect the cable **ONLY** while the transceiver power is **OFF**.

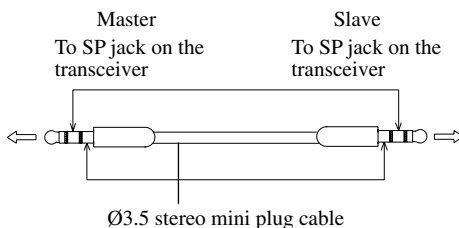

■ Transmitting the Master

Data

1. Press and hold the MONI key and press the PTT key three times.

"CLONE" appears on the display to indicate the Clone mode is activated.



2. Press the PTT key.

"Sd ***" is displayed and internal setting information is transferred into the "slave" transceiver.

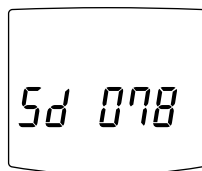

"PASS" appears when the cloning completes.

The same data is transmitted by pressing the PTT key while the "PASS" is displayed.

If the data is not transmitted correctly, "PASS" is not displayed. Repeat from procedure 1.



Cloning Complete

3. To cancel the Clone mode, switch the power off.

Caution : If the cable is not connected correctly, "CHECK" appears on the display.

Check the cable connection again.

■ Receiving the Master Data

1. "Ld ***" appears on the slave transceiver's display while the master data is transmitted.

"Ld 078" remains displayed when the cloning is completed.

The receiving side cannot recognize whether the data has been transmitted correctly. Check to see if "PASS" is displayed on the transmitting (master) side.



2. Switch the transceiver power OFF.

- Caution**
- Do not disconnect the cable while cloning.
 - All data in the slave transceiver will be updated to the master transceiver's data during the cloning operation. Be sure you want to change everything before cloning.

9. Maintenance and Reference

9-1 Resetting

When you reset the transceiver, all settings are returned to the initial factory (default) settings.

1. Turn the power ON while the FUNC key and V/M key are held down.
2. When all the display indications appear, release the FUNC key.

The transceiver enters the VFO mode.

The Initial Factory Settings

DJ-S446	
VFO Frequency Number	1
CALL Frequency Number	1
Memory Channel 0~99	Unset
Tone Squelch Setting	...
Tone Number	8
Stand-by-beep Setting	ON
Key Lock Setting	OFF
Battery Saving	ON
Squelch Level Setting	07

9-2 Options

EBP-52N	Ni-MH Battery Pack (3.6V 500mAh)
EBP-53N	Ni-MH Battery Pack (6.0V 500mAh)
EBP-54N	Ni-MH Battery Pack (3.6V 1500mAh)
EDC-36	Cigarette Lighter Cable with Filter (DC12V)
EDC-37	DC Cable for Base Station (DC12V)
EDC-43	Cigar Lighter Cable for Recharging (DC12V)
EDC-93	Battery Charger (Wall Charger) 110V
EDC-94	Battery Charger (Wall Charger) 230V
EDC-105	Battery Charger (Trickle Charger)
EMS-9	Speaker Microphone
EMS-51	Speaker Microphone
EME-6	Earphone
EME-12	Head Set with VOX (Headphone Type)
EME-13	Head Set with VOX (Inner Type)
EME-15	Tie Pin Microphone with VOX
EME-16	Earphone Microphone
EME-17	Earphone Microphone
EME-20	Earphone Microphone
ESC-37	Softcase

10. Specifications **DJ-S446**

General		
Frequency Range		446.00625~446.09375MHz (12.5kHz step 8CH)
Modulation		F3E (FM)
Tuning Steps		12.5kHz
Memory Channel		100 Channels + 1 Call Channel
Ant. Impedance		50 Ω
Frequency Stability		± 5ppm
Mic. Impedance		2k Ω
Supply Voltage		4.5 ~16.0VDC
Current	Transmit H	approx.370mA
	L	approx.220mA
Reception		approx.150mA (Max)
		approx.40mA (Squelched)
		Battery Save :15mA
Operating temperature		-10 ~ +60°C
Ground		Negative Grounding
Dimension		56 (W) × 102 (H) × 30 (D) mm (EBP-53N Inclusive) (2.20" × 4.01" × 1.18")
Weight		Approx. 95g (without Battery) Approx. 160g (EBP-53N Inclusive)

10. Specifications

Transmitter

Power Output	500mW Approx. 150mW LOW
Modulation	Variable Reactance
Spurious Emission	- 60dB or less
Max. Deviation	± 2.5 kHz
Mic. Impedance	2k Ω

Receiver

System	Double-Conversion Super Heterodyne
Sensitivity	- 14.0dBu (0.2uV) or less
Intermediate Frequencies	1st IF : 21.7MHz 2nd IF : 450kHz
Selectivity	-6dB : 6kHz or over -60dB : 14kHz or less
AF Output	280mW or over (MAX) 200mW or over (10% Distortion factor 8 Ω)

- Specifications may be changed without a preliminary announcement in connection with technical development.



ALINCO, INC.

Head Office: Shin-Dai building 9th Floor
2-6, 1-Chome, Dojimahama, Kita-ku, Osaka 530-0004, JAPAN
Phone: +81-6-4797-2136 Fax: +81-6-4797-2157
E-mail: export@alinco.co.jp