

Barrett 940 Portable HF SSB Transceiver Operating Manual

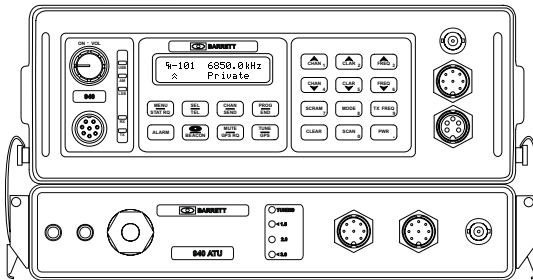

© Barrett Communications
BCM94000/2

Head office:

Barrett Communications Pty Ltd
10 Port Kembla Drive, Bibra Lake WA 6163
P O Box 1214, Bibra Lake WA 6965
AUSTRALIA
Toll Free Tel: 1800 999 570
Tel: (61-8) 9 434 1700
Fax: (61-8) 9 418 6757

European office:

Barrett Europe Limited
19 Lenten Street
Alton, Hampshire
GU34 1HG
UNITED KINGDOM
Tel: (44) 1420 542254
Fax: (44) 1420 543373

Introduction 5

Operation 6

- Front panel description 6
 - Power/volume control 6
 - Mic. Socket 6
 - Status LED's 6
 - Display 7
 - Key pad 8
- Channel change 9
 - Channel up/down 9
 - Direct channel entry 9
- Selective Calls - alerting other stations 11
 - Selcall 11
 - Sending a selcall 11
 - Receiving a selcall 13
 - All call 13
 - Group call 14
 - Sub group call 14
 - Beacon call 15
 - Sending a beacon call 15
 - Receiving a beacon call 16
 - Sending an emergency selcall 17
 - Transceivers receiving an emergency call 17
- Telcall's - direct dial telephone calls 18
 - Beacon call 18
 - Sending a Telcall 18
 - Preset dialling 18
 - Direct dialling 20
 - Last number redial 22
 - Hang-up call 23
- Scanning channels 24
 - Halting scan 24
 - Selcall Scan 25
 - Signal strength scan (SSL scan) 25
 - Voice (syllabic) scan 25
 - Enabling channels into scan tables 26
- Clarifier 28
- Mute types 28
 - Audio (syllabic) mute 28
 - Selcall mute 28
 - Signal strength mute 28
- Mode selection 29
 - LSB mode 29
 - USB mode 29
 - AM mode 29
 - CW mode 29
- Alarm operation 30
 - International marine radiotelephone two-tone alarm 30
 - RFDS alarm 30
 - Testing the alarm 30
 - Sending an Alarm 30
- Transmit frequency monitoring 31

Tune..... 31
 Scrambler 32
 RF output power 33
 Advanced selective call functions 34
 Requesting GPS data 34
 Pagecall 37
 Status selcall (Statcall)..... 38
 Selective call history 41
 Accessing selcall history 41
 Making a call from the history buffer 41
 Types of selcall history 41
 Tuning receiver 43
 Tuning 43
 Scanning the tunable receiver 44

Menu functions 46
 Menus 46
 Open menu 46
 Identification..... 46
 Noise blanker 47
 Display back-light levels 47
 Display back-light options 48
 Display options 49
 Battery level 50
 Protected menu 51
 RF pre-amplifier 51
 Set Scan Rate..... 52
 Set Scan Dwell 52
 Set Signal Strength threshold Level (SSL)..... 52
 External control options 53
 Transmit "over beep" 53
 Transmit timeout 54
 Clarifier Limit..... 54
 Set Selcall I.D's 55
 Set Selcall Pre-amble 55
 Scrambler - hardware option enable 56
 Silent mode 56
 Scan resume time 57
 Microphone Up/Down buttons 57
 Cloning and programming transceivers 58
 Cloning 58
 BITE menu 62
 Transceiver lock 64
 To lock out (disable) a transceiver..... 64
 To un-lock a transceiver 65

Programming functions 66
 Programming steps 66

Portable operation 71
 End fed single wire low power broadband..... 71
 Tactical rapid deploy, tuned, end fed, low power dipole..... 73

Man-pack operation with 940 automatic antenna tuner 74

Man-pack operation with manual tapped whip antenna76

Battery Charging77

Operation from a external 12V supply79

Multiple-Use Distribution Unit.....80

Connectors81

Overview of HF operation82

Introduction

The Barrett 940 is a lightweight, robust, portable HF transceiver package designed for use in severe field conditions with limited power supplies.

The development of the 940, utilising Barrett's 900 series transceiver technology and military packaging has resulted in a realistically priced, fully featured portable/manpack transceiver that fills the void between limited function portables and full military specified manpacks.

To provide the flexibility in deployment that is vital for successful field operations, the Barrett 940 can be used in a number of configurations. In a manpack configuration the 940 is self-contained with a clip on battery pack and is fitted into a comfortable padded canvas backpack. In this configuration it can be supplied with a rapid deployment single wire end fed broadband with an efficiency that far exceeds that of the traditional whip antenna. For temporary base station or mobile operation, an optional power lead which includes a cigarette lighter type plug and clip leads, plugs into the front panel allowing operation from a 12 volt DC source such a vehicle battery or AC mains power supplies. The BNC RF connector on the front of the transceiver can connect to tactical tuned dipole antenna, base station broadband antennas or manual tapped vehicle whips.

An optional antenna tuner that clips on to the 940 and provides fully automatic tuning of a long wire antenna or an optional collapsible whip.

The Barrett 940 can be field programmed by direct entry on the front panel of the transceiver or by using a personal computer connected to the RS-232 interface. A cloning facility is also available to enable programming information to be copied from a master transceiver to other 940 transceivers

An optional rugged lid with a carry handle that clips to the top of the transceiver provides extra protection from the elements whilst in transport and also provides storage for the microphone, power cable and antenna system.

Optional features include selective call, considered essential for the efficient use of HF networks, Pagecall providing for the reception of 32 character paging messages and Telcall, allowing the user to make direct dial telephone calls via base stations equipped with Barrett 660 or 960 telephone interconnect systems.

Other standard features included in the Barrett 940 are Built in Test Equipment (BITE), two scan tables, battery condition monitor, VSWR and power displays and variable intensity display back lighting.

Accessories include a transportable tactical tuned, end fed dipole antenna, an end fed, single wire, rapid deployment antenna, handset in place of the speaker microphone, morse key and headphones.

Operation

Front panel description

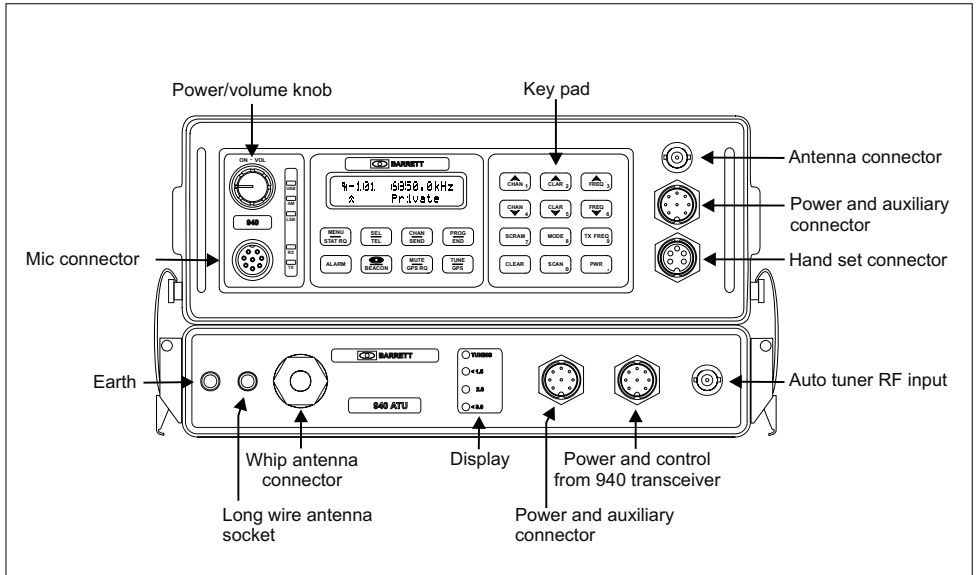

Power/volume control

The Barrett 940 transceiver is turned on by rotating this control clockwise. Turn the control clockwise until volume is set to correct level.

Mic. Socket

The microphone supplied with the Barrett 940 is inserted here.

Status LED's

This group of LED's indicates the mode currently in use. When receiving the green Rx LED is illuminated, when transmitting the red Tx LED is illuminated. The operating mode of the transceiver is indicated by the remaining LED's. (i.e. USB, LSB, AM).

Display

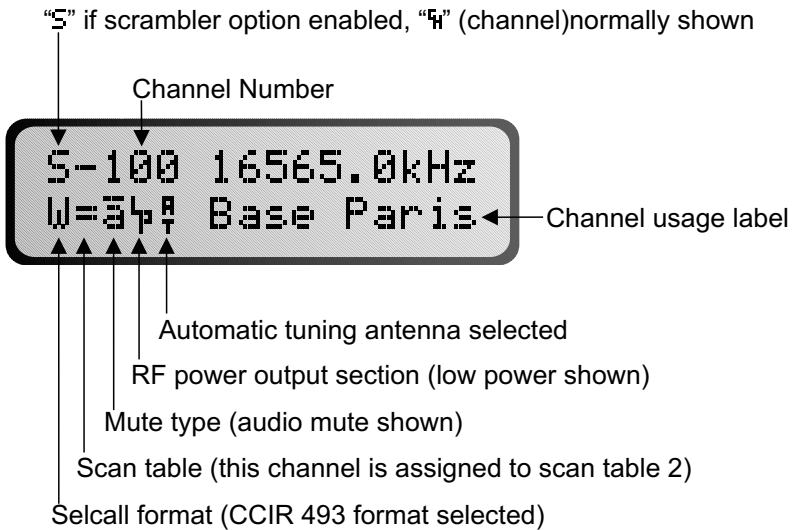















The Barrett 940 uses a supertwist 2 line by 16 character liquid crystal display (LCD).





The LCD provides the user with current status information of the transceiver including :-

- Channel number** **Channel frequency** **Mode of operation** **Channel usage**
- Local characteristics** (parameters unique to the channel in use.)
- Global characteristics** (parameters that affect all channels.)

Key pad

There are 20 keys on the keypad. Most keys have multiple functions assigned to them depending on when the key is pressed. Key functions are listed below followed by a detailed description of their functions.

Key	Key Primary function	Secondary function
	Selcall alarm reset	Menu access, send request status
	Selcall / telcall initiate	Selcall history
	Alarm Emergency Selcall Send	Alarm test
	Direct channel change	Send selcall / telcall
	Mute select	Send GPS position request
	Program channel	Hang-up telcall
	Tune mode	-
	Channel up	General scroll key Numeric key "1"
	Channel down	General scroll key Numeric key "4"
	Clarifier up	General scroll key Numeric key "2"
	Clarifier down	General scroll key Numeric key "5"
	Receiver tune up	General scroll key Numeric key "3"
	Receiver tune down	General scroll key Numeric key "6"
	Turn scrambler on / off	Numeric key "7"
	Mode select USB, LSB, AM, CW,	Numeric key "8"

Key	Key Primary function	Secondary function
	Display channel transmit frequency	Numeric key "9"
	Start scan, hold for 2 seconds select scan table	Enable / disable scan Numeric key "0"
	Delete character or abort function	-
	High or low power select	Decimal point
	Future and custom functions	Beacon call

Channel change

Channel up/down

Pressing the channel up or down key will select respectively the next higher or lower programmed channel. Holding down either of the keys will cause the rate of the channel change to increase. The channel up/down keys on the microphone have the same function as the channel up/down keys on the keypad.





Channel up



Channel down

Direct channel entry steps

- press the  key
- enter the channel number required, using the numeric keys, channel range is from 1 to 9999 inclusive. Note:- **Channel zero cannot be selected.**
- press the  key again

Using direct channel entry to select channel 101- example.



If the channel selected has not been previously programmed then the following is displayed:-





Note: Empty channels can only be accessed by direct channel selection and are not displayed when scrolling through channels.

Selective Calls - alerting other stations

Selcall

Selcall is a digital system of signalling between HF transceivers. Each transceiver is assigned an individual ID (identification) and can be called using this ID.

Sending a selcall

- select the channel on which to send the selcall.
- listen for traffic on that channel, if no traffic is heard then continue.
- press the  key.
- enter the desired destination ID using the numeric keys.
Note:- If you don't enter a new destination ID at this stage and proceed to the next step the default destination ID (the last received selcall callers ID or the last selcall sent ID) will be sent.
- press the  key.
- wait for the selective call to be sent.
- listen for revertive tone from the called station that indicates the call was successful.

Entering the desired destination ID

Destination ID range is from 0000 to 9999 inclusive (the destination ID **must** be 4 digits long)

All call*	will be decoded by stations X000 - X999 (up to 1000 stations)
Group call*	will be decoded by stations XX00 - XX99 (up to 100 stations)
Sub-group call*	will be decoded by stations XXX0 - XXX9 (up to 10 stations)

*Note: Only available if the destination unit has all call, group call or sub-group call enabled.

Sending a selcall to station 4321 - example

SEL
TEL

Destination ID
1234

Note:- Last selcall sent was to 1234

CHAN 4 ▲ ▲ ▲
▼ 4 3 2 1
FREQ CLAR CHAN

Destination ID
4321

CHAN
SEND

Sending 4321
Selcall

Note:- If no selcall has been programmed on the channel in use an error message will be generated as indicated below:-

4-100 5940.0kHz
Not a Selcall ch

Receiving a selcall

When the transceiver has a selcall enabled channel selected the transceiver monitors incoming selective calls (selcall's). (If more than one channel is to be monitored then the scan function should be used.)

Receiving a selcall directed to your transceiver

If an incoming selcall's destination ID matches the unit's selcall ID an audible alarm is sounded, mute is opened and the display shows the call as follows:

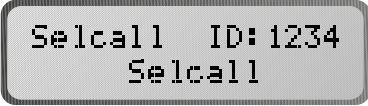

```
Selcall ID:1234
Selcall
```

The alarm will sound for thirty seconds and then time out. To stop the alarm before the time out and acknowledge the call press PTT or any key. If the alarm times out the message "Call received" will be displayed periodically on the bottom line of the display as follows:



```
4-100 16565.0kHz
Call received
```

To cancel the "Call received" message either press the clear key or send a selcall back to the calling transceiver.

All call

If the first digit of the incoming call's destination ID is the same as the unit's selcall ID and the last three digits of the destination ID are all zero (eg: 9000) then the mute is opened and the display shows the following:



```
Selcall ID:1234
All Call
```

The mute will stay open for 20 seconds then time out. Once timed out the "Call received" message will not be displayed.

Group call

If the first two digits of the incoming call's destination ID are the same as the first two digits of the unit's selcall ID and the last two digits of the destination ID are zero then an audible alarm is sounded, the mute is opened and the displays shows the call as follows:-



Selcall ID:1234
Group Call

The alarm will sound for three rings in two seconds, then leave the mute open for an additional 20 seconds then time out. To stop the alarm and/or the mute open press PTT or any key. Once timed out the "Call received" message will not be displayed.

Sub group call

If the first three digits of the incoming call's destination ID are the same as the first three digits of the unit's selcall ID and the last digit of the destination ID is zero then an audible alarm is sounded, the mute is opened and the displays shows the call as follows:-

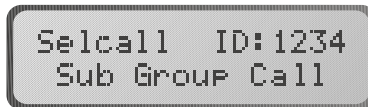



Selcall ID:1234
Sub Group Call

The alarm will sound for 5 seconds, then leave the mute open for an additional 20 seconds then time out. To stop the alarm and/or the mute open press PTT or any key. Once timed out the "Call received" message will not be displayed.

Beacon call

The "beacon call" function allows the user to determine the signal quality between two transceivers fitted with the selcall function.

Sending a beacon call

- select the channel on which to send the beacon call.
 - listen for traffic on that channel, if no traffic is heard then continue.
 - press the  key.
 - enter the desired selcall destination ID using the numeric keys. (xx99 for a 660/960 telephone interconnect, where xx is the 660/960 I.D.)
 - press the  key.
 - wait for the beacon call to be sent.
 - listen for the beacon revertive tones.
 - repeat steps until the channel with the best signal path is found.
- Note:- The beacon revertive tones are different to a normal selcall revertive and are a series of 4 tones.

Sending a beacon call to station 4321 - example



Note:- Last selcall sent was to 1234

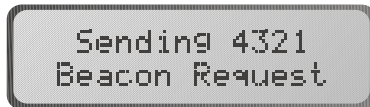

Receiving a beacon call

When a transceiver receives a beacon request call, it responds by transmitting the beacon call reververtive tones. The beacon request call is not saved in the selcall history buffer.

Sending an emergency selcall

An emergency selcall sequence can be sent from transceivers that have emergency call channels enabled using the Barrett PC based programming system.

When the emergency call is activated the 940 transceiver sends an selcall, with a specific emergency call format, twice on each channel programmed in the emergency call sequence and continues to then repeat this sequence until the transceiver is switched off. If no emergency channels have been programmed into the transceiver then the emergency call will be made on the current channel only, but will continue to send emergency calls until the transceiver is switched off. When a revertive from a receiving transceiver is heard pressing the PTT will exit the emergency call procedure and stay on the channel the revertive was heard on.

To activate the emergency call sequence:-

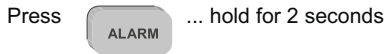

Transceivers receiving an emergency call

Barrett transceivers that receive the emergency selcall emit a distinctive audio alarm and display the following:-



If the transceiver sending the emergency selcall is fitted with a GPS receiver the position will also be displayed as illustrated below :-



And:-



Telcall's - direct dial telephone calls

Transceivers equipped with telcall can direct dial telephone numbers and receive calls from telephone users through a Barrett 660/960 telephone interconnect system. The 660/960 is a radiotelephone interface, designed specifically for HF use. The 660/960 allows any Barrett transceiver fitted with a telcall selective calling facility to access the telephone network without operator assistance.



Beacon call

Channel selection is a critical factor in using the 660/960 telcall system. To enable channels to be evaluated the 660/960 telephone interconnect has a beacon facility which allows a station in an HF network to send a special selcall code that causes the 660/960 to send a beacon signal. The quality of the beacon signal received by the HF out-station is indicative of the quality of communication that can be expected on the channel in use. (refer to Selcall (selective call) section - Beacon call).

Sending a Telcall

Preset dialling

To access preset telephone numbers on the Barrett 660/960 a standard selcall is transmitted from the Barrett 940. The first two digits of the destination ID must be the same as the first two digits of the 660/960 self ID being called. The second two digits correspond to one of the 98 preset numbers stored in the 660/960 telephone interconnect.

- select the channel to be used to make the call (refer to Selcall (selective call) section - "**Beacon call**")
- listen for traffic on that channel, if no traffic then continue
- press the  key
- enter the selcall number corresponding to the preset telephone number required using the numeric keys
- press the  key
- when the selcall has finished sending, listen for revertive tones that indicate the call was successful.
- if the call was successful then wait for a telephone connection to be made. When the call has been answered, the user can talk as normal.
- after the call is complete or the line is busy the user should hang up the line. (Refer to Selcall (selective call) section - "**Hang-up call**")

Making a call to preset telephone number 58, via a 660/960 telephone interconnect whose ID is 6099 - example

SEL
TEL

Destination ID
1234

Note:- Last selcall sent was to 1234



FREQ 6 SCAN 0 CLAR 5 MODE 8

Destination ID
6058

CHAN
SEND

Sending 6058
Selcall

Direct dialling

- select the channel to be used to make the call (refer to Selcall (selective call section - "**Beacon call**")
- listen for traffic on that channel, if no traffic then continue
- press the  key
- enter the 660/960 destination ID using the numeric keys
- press the  key
- enter the telephone number to dial using the numeric keys
- press the  key
- when the telcall has finished sending listen for revertive tones that indicates the call was successful.
- if the call was successful then wait for telephone connection to be made. When the call has been answered, the user can talk as normal.
- after the call is complete or if the line is busy the user should hang up the line. (refer to Selcall (selective call) section - "**Hang-up call**")

Making a direct dial call to telephone number 61894341700, via a 660/960 telephone interconnect whose ID is 6099 - example

SEL
TEL

Destination ID
1234

Note:-Last selcall sent was to 1234

FREQ 6 SCAN 0 TX FREQ 9 TX FREQ 9

Destination ID
6099

SEL
TEL

Enter Phone No.

FREQ 6 CHAN 1 MODE 8 TX FREQ 9 CHAN 4 FREQ 3 CHAN 4

CHAN 1 SCRAM 7 SCAN 0 SCAN 0

Enter Phone No.
61894341700_____

CHAN
SEND

Sending 6099
Telcall



Last number redial

To use the last number redial facility press the  key twice, the last telephone

number sent will now be displayed, now press the  key and the telcall sequence will be re-sent.

Hang-up call

When a call has been completed the caller must "**hang up**" by sending a "hang up" code to the Barrett 660/960.

- press the  key
- enter the selcall ID of the 660/960 being called, using the numeric keys
- press the  key
- when the hang-up selcall has completed transmitting, listen for hang-up revertive signal, confirming the "hang up" was successful, if not heard repeat the above procedure.

Hanging up call to a 660/960 with ID of 6099 - example

SEL
TEL

Destination ID
6099

PROG
END

Sending 6099
Hang Up Call

Scanning channels

The Barrett 940 can be programmed to scan up to 450 channels. Pressing the scan key initiates scanning. Only channels that have been enabled will be scanned. Holding the scan key down for 2 seconds or more will allow the user to select which scan table is to be scanned. Use the scroll keys to select the scan table required then press the scan key again to select it.

Selecting scan table one and initiating scanning - example

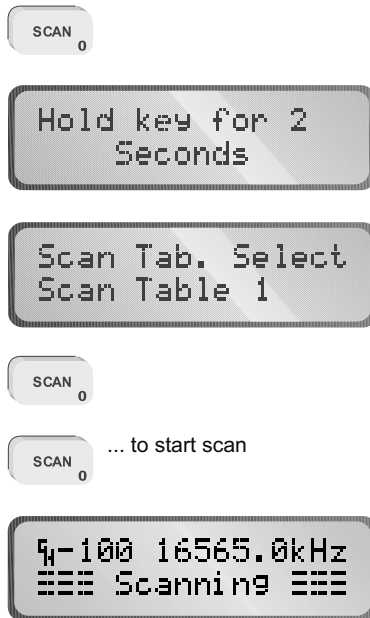

To abort scanning press PTT or any other key other than the scan key.

Halting scan

The Barrett 940 will halt scanning for the following reasons:-

- The channel has selcall enabled and a selcall signal is received.
- Signal strength level mute is selected and a signal with a level greater than the pre-set threshold level is received.
- Audio (syllabic) mute is selected and a voice signal is detected.

Selcall Scan

When a selcall signal is detected, and the channel has selcall enabled, no matter which mute type is selected the transceiver will stop scanning and decode the selcall signal. If the selcall was decoded for this transceiver the audio alarm will sound and the following will be displayed:-



If no other action is taken, i.e. the transceiver is unattended then the transceiver will revert to scan and display the following:-



Beeping and alternating with :-



If PTT is operated or any other key, apart from the scan key, is pressed then the transceiver will select the channel on which the selcall was received as the current working channel and allow the operator to talk to the station calling.

Signal strength scan (SSL scan)

If the signal strength mute is active and a signal with a level greater than the pre-set threshold is received the scan will halt. Scan will remain halted while the signal level stays above the preset threshold. Once the signal decreases below the pre-set threshold level, for a period greater than the scan dwell period, scanning will resume.

Voice (syllabic) scan

If the audio mute is active and the mute is opened scanning will halt. Scanning will remain halted while the audio mute is open. Once the mute closes, for a period greater than the scan dwell period, scanning will resume.

Enabling channels into scan tables in transceivers with channel programming locked out.

- Select the channel you wish to enable into the scan table.

- press the  key

- press the  key

- use the  key to select the scan table required by selecting the

symbol corresponding to that scan table. This symbol is displayed on the bottom line of the display in the 2nd character position.

 Scan table 1 enabled for this channel

 Scan table 2 enabled for this channel

 Scan table 1 & 2 enabled for this channel

No symbol in this position on the display indicates this channel will not be programmed for scan.

- press the  key to save this change

Clarifier

The clarifier is used to compensate for received signals that are off frequency.

The receiver can be clarified in steps of 1Hz to frequencies from -1KHz and +1KHz of the assigned channel frequency, depending on programming. To shift the clarifier use one of the following keys

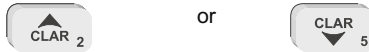

Pressing either of the above keys once will display the clarifier as follows



Release the key pressed then press it again to begin adjusting the clarifier. Holding the key down will accelerate the clarifier rate of change until maximum rate of change is achieved or the clarifier limit is reached. To clear the clarifier value, first bring up the clarifier then press the **clear** key to zero the value.

Mute types

Pressing the mute key will select the mute function required. A character indicating the mute function selected is positioned on the second line of the display at the third column from the left.

Audio (syllabic) mute



When the audio mute is enabled the mute opens only when speech is detected.



Selcall mute



When the selcall mute is enabled the mute opens after a selcall sent to the unit has been received and decoded successfully.



Signal strength mute



When the SSL mute is enabled the mute only opens when the received signal strength exceeds the nominated threshold level (see menu functions - "set SSL level").



Mode selection

Mode select

The mode key selects the mode of operation eg LSB, USB, AM, CW or AFSK. The mode key will temporarily set the mode for a selected channel, until the channel is changed, or the transceiver is turned off.

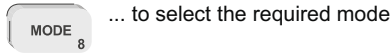

LSB mode



USB mode



AM mode



CW mode

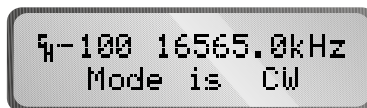

Alarm operation

Any channel can be assigned with either one of the following alarm signalling formats

International marine radiotelephone two-tone alarm - alternating 2200Hz/1300Hz, 500mS cycle, 50% duty cycle.

RFDS alarm two-tone alarm 880Hz + 1320Hz continuous. (Australian use only)

Testing the alarm (marine alarm illustrated)

To test the alarm encoder, select an channel programmed for alarm operation, press and release the alarm key within two seconds and the programmed alarm will be audible from the speaker.

Press  ... for less than 2 seconds



Test alarm
Marine alarm

Sending an Alarm

To transmit the alarm, select an channel programmed for alarm operation, hold in the alarm key for a period greater than two seconds.

Press  ... for longer than 2 seconds

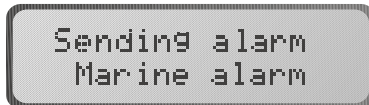

Sending alarm
Marine alarm

When an alarm transmit or test is attempted on a channel that has not been programmed for an alarm operation, no alarm is generated and the display is:-



4-100 16565.0kHz
Not an alarm chn

To cancel alarm - press any other button or key.

Transmit frequency monitoring

When the  is pressed the transceiver will receive on the transmit frequency of a split transmit / receive frequency channel and the following will be displayed:-



```
4---1 3776.0kHz
Tx Frequency
```

When the key is released the transceiver reverts to normal operation.

Tune

When the  is pressed the transceiver will transmit full power carrier on the channel selected, at the **Suppressed Carrier Frequency (SCF)** of that channel.



```
TUNE
Carrier On
```

When the tune key is released the display will indicate the forward and reverse power being delivered to the load (antenna) connected to the transceiver. This giving an indication of the antenna VSWR. The example below shows a load (antenna) with a poor VSWR, indicated by a low forward power and the high reverse power:-



```
FWP |
REVERSE
```

Scrambler

The  key toggles the scrambler on or off if the physical scrambler option

PCB is fitted and enabled in the programming section. (refer to protected programming menu - "Scrambler", and also to the Barrett PC based programming software)

To turn the scrambler on - example



To turn the scrambler off - example

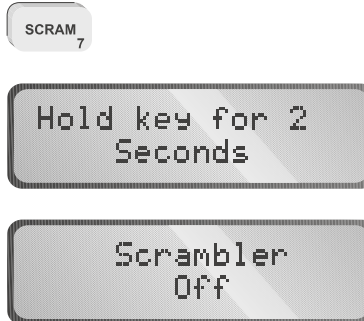

RF output power

The  key toggles the RF output power setting. The high power setting is 25 watt

PEP (voice) and the low power setting is 10 watt PEP (voice). Note:- the transceiver low power setting is sometimes set to a different value dependant on customer requirements.

Note:- If a channel was programmed for low power during channel programming the selection of high power using the method above is disabled

To select high power if low power was previously selected - example



To select low power if high power was previously selected - example

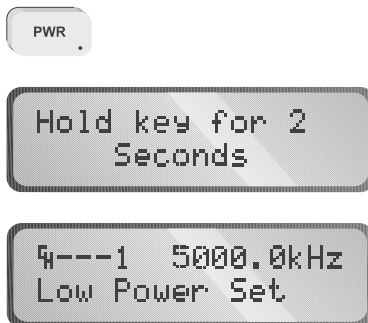



The lower power symbol,  , will appear on the display.

Advanced selective call functions

Requesting GPS data from another transceiver

The steps involved in sending a GPS data request call are as follows:-

- select the channel on which to send the call.
- listen for traffic on that channel, if no traffic is heard then continue.
- press the  key.
- enter the desired destination ID using the numeric keys
- press the  key.
- wait for the selective call to be sent.
- wait for the remote transceiver unit to send back its position data or error message. If the unit times out before the position is received an error message will also be displayed.

Making a GPS request call to station with ID 4321 - example



Once the GPS request selcall has been sent the following will be displayed:-



When GPS data is received from the transceiver being requested for GPS data the display will be similar to that shown below:-



If the transceiver being requested for a GPS position is fitted with a GPS receiver, but cannot retrieve GPS data from it (due to lack of satellite data etc), a timeout occurs in the remote transceiver and the following message will be displayed on the requesting transceiver display on receipt of the reply from the remote transceiver:-



If the transceiver being requested for GPS data is not fitted with a GPS receiver the following message will be displayed, on the requesting transceiver display, upon receipt of the reply from the remote transceiver:-



GPS Not Fitted
in Remote Unit

If no response to a GPS request is forthcoming from the remote transceiver, after a fixed time period, the following message is displayed:-



No Response From
Remote Unit

Special note:-

The transceiver being requested for GPS data will automatically respond to the request but will have no visual or audio indications noticeable to the operator or persons in the vicinity of the transceiver.

Pagecall

Pagecall is a system that allows messages of up to 32 characters to be sent to a Barrett 940 transceiver from a Barrett 950 transceiver connected to a PC fitted with pagecall software.

Receiving a pagecall

Upon successfully decoding an incoming pagecall an audible alarm is sounded, the mute is opened and the display shows the call as follows:-



```
Sel call ID:1234
Page Call
```

This display is held for 3 seconds then the message received is displayed:-



```
Call head office
urgent...
```

The alarm will sound for thirty seconds and then time out. To stop the alarm before the time out and acknowledge the call, activate the PTT or press any other key. If the alarm times out the display will periodically flash the "**call received**" message on the bottom line of the display.

To clear the "**Call received**" message press the clear key.

Sending a pagecall

Pagecalls are initiated through the computer control interface refer to the pagecall software instructions manual.

Status selcall (Statcall)

Statcall is a system that allows the status of any Barrett transceiver fitted with selcall to be accessed by another Barrett 950 or Barrett 940 transceiver. The status is sent from the remote transceiver as a selcall with the extra status information stored within the selcall structure. Information retrieved, that can be used for remote diagnosis of transceiver performance, is as follows:-

- Selcall ID
- Software version
- Option level fitted and radio type (950 / 940 / 930 etc.)
- Receive state battery voltage
- Last transmit state battery voltage
- Signal strength indication of received status request selcall.
- Forward power output level
- VSWR of antenna

There are two types of statcall that a Barrett 940 transceiver can receive, these are as follows:-



Status request:- when a calling transceiver has requested the status of the receiving unit.

Status revert:- where a Barrett 950 has sent out a status request and the unit called has responded by sending back the status bytes.

Receiving a status request

When the Barrett 940 receives a status request the call is not acknowledged to the user but a status revert call is automatically sent back to the calling unit.

Sending a status request

- select the channel on which to send the status request
- listen for traffic on that channel, if no traffic is heard then continue
- press the  key
- enter the desired destination ID between 0000 and 9999 using the numeric keys
- press the  key
- wait for return call containing status to be received and decoded by the 950.

Note:- All call, group call and sub-group call numbers will not return a status.

When a status selcall is received, the data is not only displayed on the transceiver display but output as a series of bytes from the RS-232 interface. (refer **Computer Control Section**)

Making a status request call to station 4321 - example



After the status request selcall has been sent the following will be displayed:-



When the transceiver requested for status has completed it's return status selcall and it is received successfully the status information will be displayed as follows (to step through the status display frames faster press any key):-

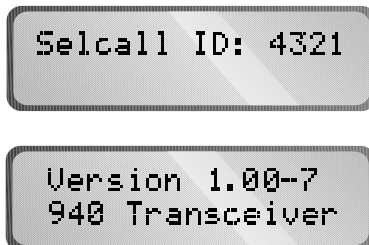

Displays version of software fitted in remote transceiver



Displays supply voltage to remote transceiver during receive and transmit modes.

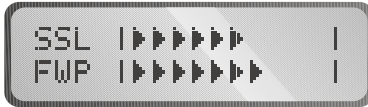

Displays signal strength of status call received by the remote transceiver and the forward power transmitted by the remote transceiver when sending the status revert selcall.



Displays the reverse power of the antenna connected to the remote transceiver.

If the transceiver being requested for a status does not respond the display will show the following message after a timeout period:-



Selective call history

Whenever a selcall, telcall, all call, group call, sub group call, pagecall, statcall or GPS call is received the callers' selcall ID and the channel the call was received on are stored in the selcall history buffer. Up to twenty calls can be stored on a first in first out basis.

Accessing selcall history

Select a selcall channel

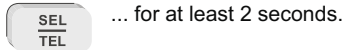

Now release the selcall key and the transceiver will be in selcall history mode. Use the general scroll keys to scroll through the available selcall history. If there is no selcall history then the following message will appear on the display:-

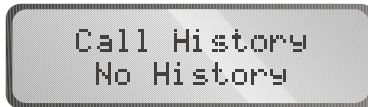

To abort selcall history mode activate PTT or press the clear key. If there is selcall history the top line of the display shows the channel the call was received on, the selcall ID of the calling unit and the history buffer count.

Making a call from the history buffer

To make a call when scrolling through the selcall history buffer perform the following steps:-

- select the call to be answered with the scroll keys
- press the send key

The Barrett 940 transceiver will change to the channel the logged call was received on and initiate a call sequence.

Types of selcall history

Normal selcalls, all calls, group calls and sub group calls are all displayed in the following format in selcall history :-



Telcalls are displayed as follows :-



Pagecalls are displayed as follows :-

4---2 ID:1234 01
Pagecall

SEL
TEL ... to display pagecall message:-

Call head office
urgent...

Statcalls are displayed as follows:-

4---2 ID:1234 01
Statcall

SEL
TEL ... to display statcall information:-

Version 1.00-7
940 Transceiver

RX 13.9 Volts
TX 13.9 Volts

Etc.

Tuning receiver

The 940 transceiver can be used as a tunable receiver. The receiver can be tuned in steps ranging from 1 Hz up to 10 MHz.

Entering tuning receiver mode



Tuning

To tune the receiver use the clarifier keys to position the cursor under the digit representing the frequency increment required then use the frequency up or down key to tune the receiver at the increment selected.

Tune receiver from 10000.000 kHz to 10500.000 kHz - example

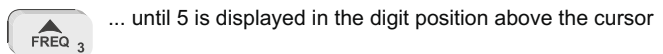
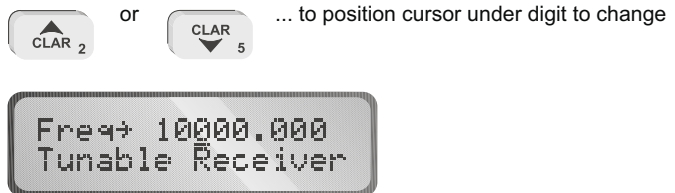

When you have finished using the tuning receiver

press the

CLEAR

key to return to the previous operating channel.

Scanning the tunable receiver

The Barrett 940 can scan any range of frequencies from 500 KHz to 30 MHz with a frequency step down to 1 Hz.

Setting up scan frequencies

To set up the frequency scan parameters on the Barrett 940, enter the tuning receiver mode, then:-

 ... hold down until the following is displayed:-



Enter a new frequency, using the numeric keys, to set the first scan limit boundary - example below shows Scan Limit 1 set to 12 MHz:-



 ... until display below appears



Note:- The frequency of 12000.000 may not appear as shown above, this indicates the last scan limit boundary programmed was 12000 kHz which will not always be the case.

Enter a new frequency, using the numeric keys, to set the second scan limit boundary - the example below shows Scan Limit 2 set to 30 MHz:-

```

Freq→ 30000.000
Set Scan Limit 2
    
```

PROG ... until display below appears
END

```

Freq→ 00001.000
Set Scan Step
    
```

Enter the step increment required in Hz i.e. entering 100 will select scan increments of 100 Hz.

PROG ... the display will revert to the tuning receiver display :-
END

```

Freq→ 10000.000
Tunable Receiver
    
```

SCAN ... will commence scanning using the parameters set above:-
0

```

Freq→ 10500.000
=== Scanning ===
    
```

The transceiver will halt scanning for the following reasons:

- Signal Strength Level (SSL) mute is selected and a signal with a level greater than the pre-set threshold is received.
- Audio (syllabic) mute is selected and a voice signal is detected

Menu functions

Menus

The menu is divided into two sections, the “open menu section” and the “protected menu section”. Both sections are used to set or display transceiver parameters. The “open menu section” is available directly to operators as no critical operation parameters can be changed in this section. The “protected menu section” has some critical parameters and you need a password to enter this area. The password is fixed and very simple but is used as a barrier to stop inadvertent changing of the critical transceiver parameters. It can be totally barred, if operationally required, by PC programming.



... to enter the “open menu” section



... for more than 2 seconds to enter the “protected menu” section

Use the following sequences to display or change parameters of items in the menu section.



or



to select the menu item required to view or edit



... enters the menu item for editing.



or



to select the parameter required.



... to save the parameter



... to exit out of the menu system

If the transceiver is left in menu mode the transceiver will, after a preset time, sound an audible alarm, flash the message “use scroll keys” and eventually time-out back to normal operating mode.

Open menu

Identification



This displays the transceiver model, software version number, the option pack fitted and the transceiver selcall ID, (if selcall is fitted) as follows :-



Noise blanker

This menu item allows the user to enable or disable the noise blanker on the transceiver. The noise blanker is used to reduce repetitive impulse noise.(eg vehicle ignition noise)

```
Select Item  
Noise Blanker
```

```
Noise Blanker  
Noise Blker On
```

... selects noise blanker on

```
Noise Blanker  
Noise Blker Off
```

... selects noise blanker off

Display back-light levels

```
Select Item  
Backlight Level
```

```
Backlight Light  
Level 1 (low)
```

... selects display back-light intensity level 1

```
Backlight Light  
Level 2 (Medium)
```

... selects display back-light intensity level 2

```
Backlight Light  
Level 3 (Full)
```

... selects display back-light intensity level 3

Display back-light options

Select Item
Backlight Optns



Backlight
Short timeout

... selects a display back-light time out time of 5 seconds from last key press



Backlight
Long timeout

... selects a display back-light time out time of 30 seconds from last key press



Backlight
Always On

... selects display back-light always on.



Backlight
Always Off

... selects display back-light always off.

Display options

Select Item
Display Optns

Display
RX use TX use

... selects the display the channel usage information in both receive and transmit.

Display
RX SSL TX use

... selects the display of signal strength level in receive and the channel usage information in transmit.

Display
RX use TX FWP

... selects the display of channel usage information in receive and the forward power level in transmit.

Display
RX SSL TX FWP

... selects the display of signal strength level in receive and forward power level in transmit.

Battery level

Select Item
Battery Level



RX 13.9 Volts
TX 13.9 Volts

... the transmit voltage is the voltage recorded during the last transmit cycle, this giving a indication of the batteries capacity under load.

Protected menu

Refer to page 47 for the method of entry and the method to display or change parameters of items in this protected menu section.



Enter the password using the numeric keys, then press the



key.

The password is 1234. Note:- the password is published as it is only used to provide protection from making inadvertent changes to more critical parameters during normal operation of the transceiver. If no access to protected menus is to be allowed to operators, the protected menus can be barred using the Barrett communications PC based programming system.

RF pre-amplifier



Selects the RF pre-amplifier on or off.



... selects RF Pre-amplifier on



... selects RF Pre-amplifier off

Note:- In later versions of 900 series transceivers this function has been removed and the RF Pre-amplifier is always switched on.

Set Scan Rate

Protected Menu
Set Scan Rate

... selects the scan rate applicable to non-selcall scan channels, selectable between 100mS and 5 seconds per channel - the example below selects 500mS.

Scan Rate
500ms

Set Scan Dwell

Protected Menu
Set Scan Dwell

Scan Dwell
5 Seconds

... selects the length of time the transceiver dwells on a channel after scan has been stopped by signal strength level (if signal strength level mute is set) or voice activity (if audio mute is set). The dwell time can be set from 1 to 10 seconds - example selects 5 seconds.

Set Signal Strength threshold Level (SSL)

Protected Menu
Set SSL Level

Set SSL Level
SIG |▶▶▶▶▶ |

... select the level at which scan stop is activated during SSL scan. The level is set by adjusting the number of signal strength arrows on the display - example selects 5 signal strength arrows. Note:- setting this to high will prevent the mute from opening unless a very high level signal is received.

External control options

```
Ext control opts
Tuner Not Fitted
```



```
Ext control opts
Tuner Fitted
```

... enables the use of a Barrett 940 Automatic antenna tuner.

Transmit "over beep"

```
Protected Menu
Tx over "beep"
```

When this feature is selected the 940 transceiver transmits a short tone when the PTT is released. It provides an audible indication to the operator at the remote station that the local station has stopped transmitting.



```
Tx over "beep"
On
```

... selects transmit over "beep" on.



```
Tx over "beep"
Off
```

... selects transmit over "beep" off.

Transmit timeout

Protected Menu
Transmit timeout

When this feature is enabled the 940 transceiver will disable the transmitter if the PTT (push to talk button on the microphone) is held on for more than 1.5 minutes i.e. if the microphone is inadvertently jammed under a seat. Releasing the PTT will reset the transmitter.



Transmit timeout
On

... selects transmit timeout on.



Transmit timeout
Off

... selects transmit timeout off.

Clarifier Limit

Protected Menu
Clarifier Limit



Clarifier
Limit: 150 Hz

This menu item allows the user to set the clarifier limits on land mobile channels with selective call disabled. , the limits can be set from 50Hz to 1KHz - example shows the clarifier limit set to 150Hz.

Set Selcall I.D's.

Two selective call self ID's can be programmed, one is the normal ID used as the self ID on channels with Barrett standard or CCIR 493 (WA2 in Australia) format programmed. The second is used as the self ID on channels programmed for use with RDD (Radphone Direct Dial, an Australian telephone interconnected HF service)

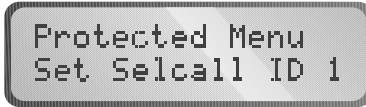

... enter the selcall self ID1, using the numeric keys, for use on channels programmed for Barrett standard and CCIR 493 (WA2 in Australia) format selcall.

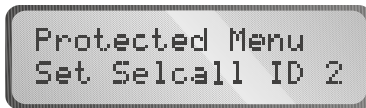

... enter the selcall self ID2, using the numeric keys, for use on channels programmed for Australian RDD format selcall.

Note:- the self ID must not be set to X000, XX00 or XXX0 as these are reserved selcall numbers for all call, group-call or sub-group-call.

Set Selcall Pre-amble



Sets the length of the selcall preamble. The length of preamble is set dependant on the number of channels being scanned. The preamble can be set from 1 to 10 seconds. Allow 500mS for each selcall channel to be scanned plus one second, E.g. to scan 8 selcall channels :- 500mS x 8 + 1 sec. = 5 seconds - the example below illustrates a pre-ample time set to 5 seconds.



Scrambler - hardware option enable



...enables software control of the scrambler hardware when fitted.

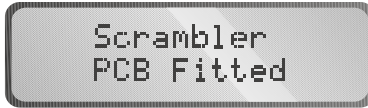

... selects scrambler hardware PCB option fitted

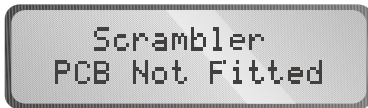

... selects scrambler hardware PCB option not fitted

Silent mode



This option enables or disables any audible annunciation tones associated with front panel key operation.



... tones enabled



... tones disabled

Scan resume time

Protected Menu
Scan Resume Time

Enabling this feature, by specifying a scan resume time, the Barrett 940 transceiver will resume scanning the scan table previously selected at a time after the last key press specified by the scan resume time selected. The example below will cause the 940 transceiver to resume scanning 1 minute after the last key press :-

Scan Resume Time
1 min

Microphone Up/Down buttons

Protected Menu
Mic up/down keys

The channel up/down buttons on the microphone can be enabled or disabled using this function.

Mic up/down keys
enabled

... microphone up/down buttons enabled

Mic up/down keys
disabled

... microphone up/down buttons disabled

Cloning and programming transceivers



This feature in the 940 transceiver is used to copy the configuration of one 940 transceiver to another using the serial interface on the front 8 pin connector or to receive programming information from the Barrett PC based 900 series transceiver programming system.

Cloning

The following steps are necessary to copy the configuration of one 940 transceiver to another :-

- Fit the 8pin to 8pin cloning cable, Barrett P/N BCA94013 to the auxiliary connector on each transceiver.
- Switch on both transceivers.

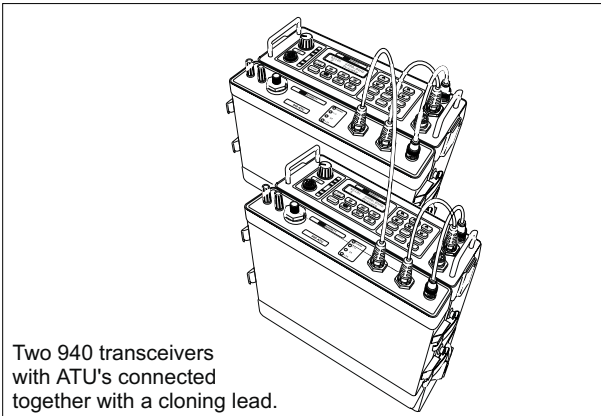
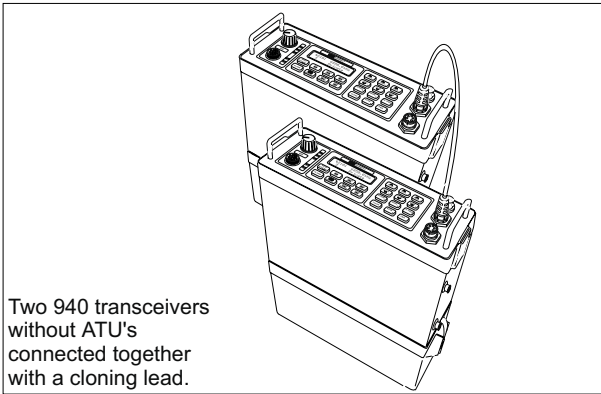

On the master transceiver (transceiver containing the information to be cloned) select the cloning menu:-

Protected Menu
Clone - Program

Clone - Program
Transmit Data

Select "Receive"
on Slave tcvr

Alternating With:-

Then
Press any key

Sending Data
|▶▶▶▶▶▶▶▶ |

Transfer Done
Press any key

On the slave transceiver (transceiver to receive information) select the cloning menu:-

Protected Menu
Clone - Program

Clone - Program
Receive Data

Waiting for Data
from Master tovr

Receiving Data
|>>>>>> |

Transfer Done
Checking Data

Now the two selcall self ID's of the slave transceiver must be entered:-

Set Selcall ID1
2543

Enter selcall self ID1, using the numeric keys, for use on channels programmed for Barrett standard and CCIR 493 (WA2 in Australia) format selcall.

Set Selcall ID2
4953

Enter selcall self ID2, using the numeric keys, for use on channels programmed for Australian RDD format selcall.

Note:- the self ID must not be set to X000, XX00 or XXX0 as these are reserved selcall numbers for all call, group-call or sub-group-call.

If the transfer of cloning information is unsuccessful both the master and slave transceiver will display the following:-



If this is the case the cable connection should be checked and the cloning procedure repeated.

**Programming a 940 transceiver using the Barrett PC based programming software
P/N BCA90035**

Refer to the operating manual supplied with the Barrett PC based programming software.

BITE menu

Protected Menu
B.I.T.E Menu

The BITE menu allows the user to self test different functions of the 940 transceiver. There are four BITE functions that can be tested as illustrated below :-



B.I.T.E Menu
Receiver test

... receiver basic function test, this sets the transceiver so a known internal signal source is present in the receiver, a signal strength is recorded, the level of which is used to confirm the receiver is functioning.



B.I.T.E Menu
Selcall test

... selcall decoder test, an internally generated signal is generated in the receiver on the mark and space frequencies of the selcall decoder. The test checks that the selcall decoder output is correct with respect to the mark and space frequencies.



B.I.T.E Menu
Audio mute test

... audio mute test, an internally generated signal is generated, the test checks that the audio mute opens in response to this signal.



B.I.T.E Menu
SSL mute test

... receiver SSL mute test, an internally generated signal is generated in the receiver . The test checks that the SSL mute opens in response to this signal.



```
B.I.T.E Menu
RS-232 loop test
```

... RS-232 test, a plug must be fitted to the auxiliary connector with pins 2 and 3 connected together. This test checks that the RS-232 port is operational.



```
B.I.T.E Menu
VCO lock test
```

... VCO lock test checks that the VCO remains in lock to a channel frequency of 30.5MHz

If the above tests pass the following is displayed :-



```
B.I.T.E Menu
Test passed
```

If the tests fail the following is displayed :-



```
B.I.T.E Menu
Test failed
```

Transceiver lock

This function enables a network operator to lock out (disable) a transceiver on the network, that for instance is being operated illegally, by sending it a special selcall (selective call) with a disable code embedded in it. The transceiver, upon receiving this selcall (selective call) is locked out (disabled). It cannot be operated again until a PIN number is entered correctly within 10 attempts. If the correct PIN number is not entered within 10 attempts, the transceiver can only be re-enabled, for normal operation, by using the Barrett PC based programming software.

To lock out (disable) a transceiver

Select the channel you suspect the transceiver to be operating on, then select the protected menu item below:-



... enter the selcall self ID or the transceiver to be locked out (disabled)



... enter the confidential pin number of the transceiver to be locked out (disabled)



... the transceiver will now be sending the "lock out" selcall.

To un-lock a transceiver

On the transceiver receiving the lock out (disable) selcall the following will be displayed :-



```
Trnsvr Locked
Pin:
```

You can now enter the pin number to unlock the transceiver.

If you input the wrong PIN number more than 10 times, the following is displayed :-







```
Trnsvr Locked
Contact Dealer
```

If this is displayed the transceiver can only be unlocked using the Barrett PC based programming software.

Programming functions

940 transceivers will be delivered in a locked or unlocked state depending on local legislative requirements. If your transceiver is unlocked proceed as described below using the internal programmer, if locked you must use the 900 series dealer PC based software system. 940 transceivers may however be cloned, even when locked, from each other using the cloning cable. (see cloning section)

Programming steps

- select the channel to be programmed (Operation section - direct channel change)
- press the programming key 
- enter the receive frequency, using the numeric keys.
- press the programming key 
- enter the transmit frequency, using the numeric keys.
- press the programming key 
- select first page of channel parameters, see setting first page channel parameters below.
- press the programming key 
- select second page of channel parameters, see setting second page channel parameters below.
- press the program key to store the new information 

Note :- The microphone PTT or clear key will abort the change.

Setting the first page of channel parameters :-

Selcall enable and format select

The  key selects the selcall format required for the channel being

programmed. Select the letter or symbol corresponding to the selcall format required. This letter or symbol is displayed on the bottom line of the display in the 1st character position.



Barrett Australia format selcall is selected.



CCIR 493 (WA2 Australia) format selcall is selected.



Australian RDD format selcall is selected.

When no letter or symbol is displayed in this position, no selcall is selected on the channel being programmed.

Scan enable

Use the scan key to select the scan table required. Select the symbol corresponding to the scan table required. This symbol is displayed on the bottom line of the display in the 2nd character position.



Scan table 1 enabled for this channel



Scan table 2 enabled for this channel



Scan table 1 & 2 enabled for this channel

No symbol displayed in this position indicates this channel will not be programmed for scan.

Low power

The  key selects the RF power setting required.

The low power symbol  will be displayed on the bottom line in the 4th character position.

when low power is selected for this channel. No symbol in this position indicates that normal high power is selected.

Channel label

Use the general scroll keys to select the required channel usage label.

Note:- the selection of available labels depends on what labels were programmed using the Barrett PC based programming software.

Alarm setting

The  key selects the alarm type required.

Select the letter corresponding to the alarm required. The letter is displayed on the bottom line in the 3rd character position.

N

No alarm selected

M

Marine alarm selected

R

RFDS alarm selected **(Australian use only)**

U

User defined alarm selected

Note:- User alarm is an option and can be programmed in the factory to customer requirements to any two tone alarm combination, if the option is not programmed this alarm defaults to the RFDS alarm.

Setting second page of channel parameters :-

Antenna Socket Select

The tune key toggles between Antenna socket 1(ANT 1) and Antenna socket 2 (ANT2). This will only be available if the optional second antenna socket is physically fitted and enabled using Barrett PC based programming software.

Operating mode

Use the mode key to toggle through to mode required (LSB, USB, AM, CW,) as indicated in the mode section of the screen.

Programming example

Programming channel 101 to 6850.0 KHz, lower sideband, selcall enabled, entry of the channel into scan table one, low power on transmit, RFDS alarm and label 'BARRETT'. The example assumes that channel 101 was already selected by direct channel selection (see Operation section - direct channel change) and was not previously programmed.

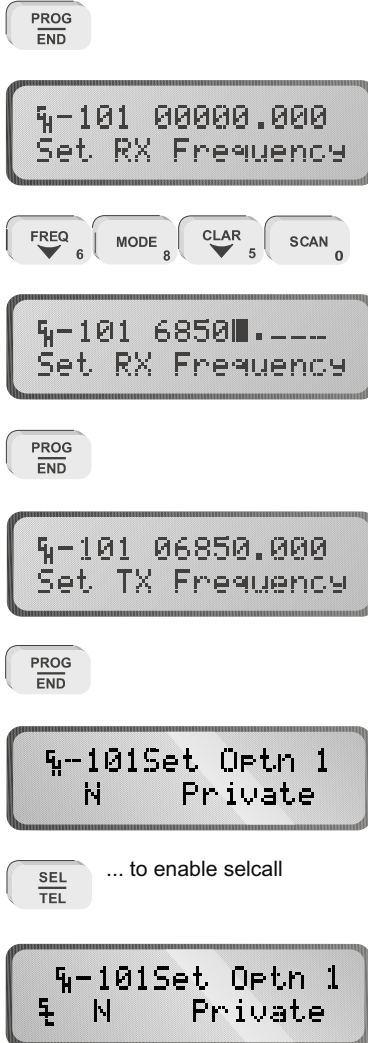

SCAN 0 ... to enable scan table one

H-101Set Optn 1
 I -N Private

ALARM ... until 'R' is shown, to select RFDS alarm

H-101Set Optn 1
 I -R Private

PWR ... to select low power

H-101Set Optn 1
 I -R4 Private

CHAN 1 or CHAN 4 to select channel label

H-101Set Optn 1
 I -R4 Barrett

PROG
 END

H-101Set Optn 2
 Ant 1 Mode USB

MODE 8 ... until LSB is displayed

H-101Set Optn 2
 Ant 1 Mode LSB

PROG
 END

Portable operation

For portable and temporary base station operation, without the optional 940 automatic tuner, the Barrett 940 can be operated using either a single wire, end fed, portable broadband antenna Barrett P/N BC91205 or a tactical rapid deploy end fed low power dipole, Barrett P/N BC91503 as illustrated below:-

End fed single wire low power broadband - Barrett P/N BC91205

Deployment

- Unfurl the broadband antenna from the winding bobbin supplied.
- Push the earth stake into the ground. Clip the short wire from the balun box, with the coaxial connector on it, to the earth stake using the crocodile clip supplied.
- Hang the wire section of the antenna in any configuration convenient as indicated in the diagrams below. Note the higher from the the ground the more efficient the antenna will be.
- Connect the coaxial cable from the coaxial socket on the blue balun box on the antenna to the 940 transceiver antenna socket.
- The antenna is now ready for operation, no turning or adjustments are required.

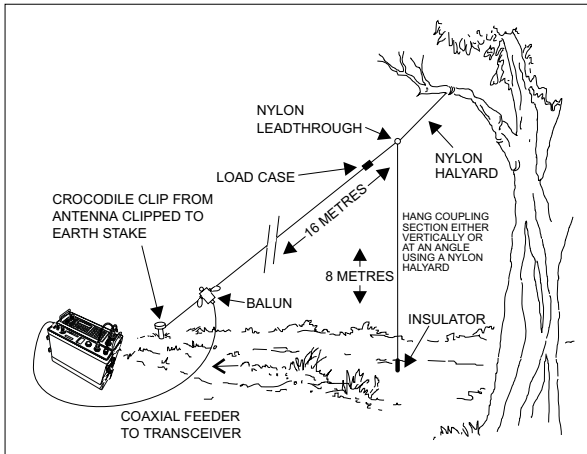

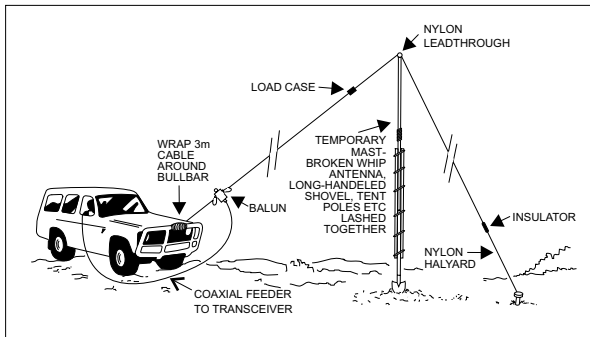
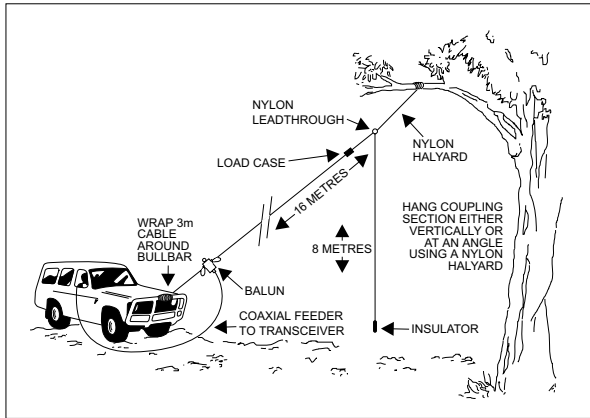
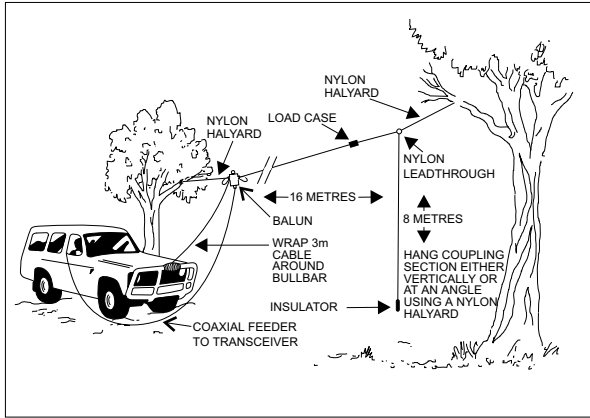

Tactical rapid deploy, tuned, end fed, low power dipole - Barrett P/N BC91503

Deployment

- Remove all components from the kit bag and check for damage/wear, ensure all components are present.
- Choose a spot on the ground near to a tree or elevated anchor point. Fit the coaxial cable to the balun as indicated in the diagrams below. Unwind the cable and lay the assembly on the ground.
- From the bobbin unwind the insulated cable until the desired frequency marker is reached, secure the cable into the slots provided on the bobbin. The nylon halyard should then be unwound and laid out (if required).
- Push the earth peg into the ground.
- The radiating end of the end fed dipole is now ready to be elevated into a working position either on a tree or some elevated natural object using the lead weight and nylon halyard.

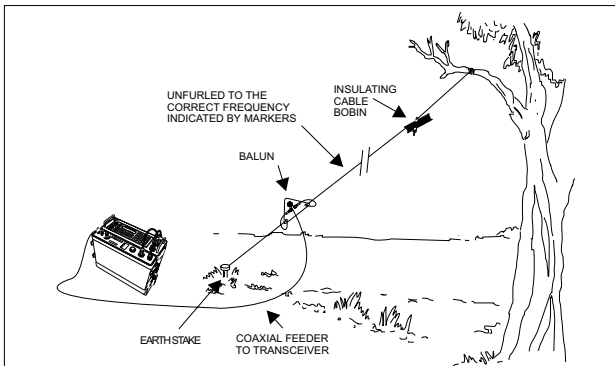
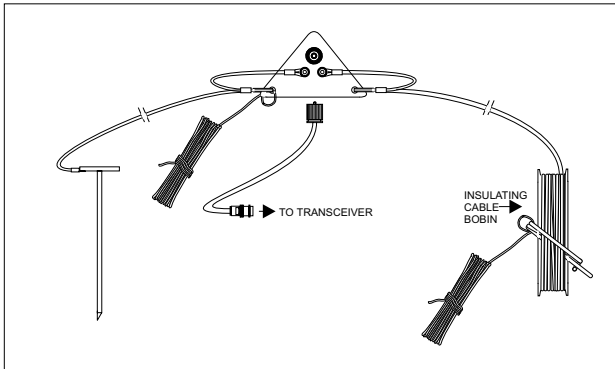

Man-pack operation with 940 automatic antenna tuner

When the optional 940 automatic tuner is attached to the Barrett 940 transceiver the unit becomes a flexible man-pack that can be used with the 10 meter throw over long wire provided or the optional 3 metre collapsible whip. The Barrett 940 tuner automatically tunes the whip or long wire when ever the unit transmits after a channel change.

Note:- Either the whip or the long wire can be used but not both together.

Using the whip

The gooseneck should be fitted to the whip antenna stud and the whip unfolded to it maximum height. When ever a channel is changed, and the next time the 940 is switched to transmit the antenna tuner will tune automatically. If using the 940 while walking in the backpack configuration it is suggested that while in receive standby mode the collapsible antenna be only extended to half height and secured using the velcro tab. When a call is received extend the antenna to full height before transmission.

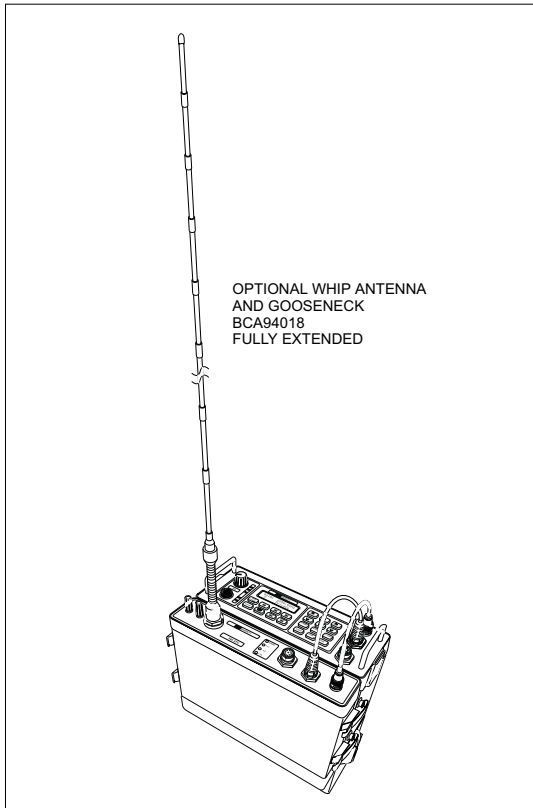

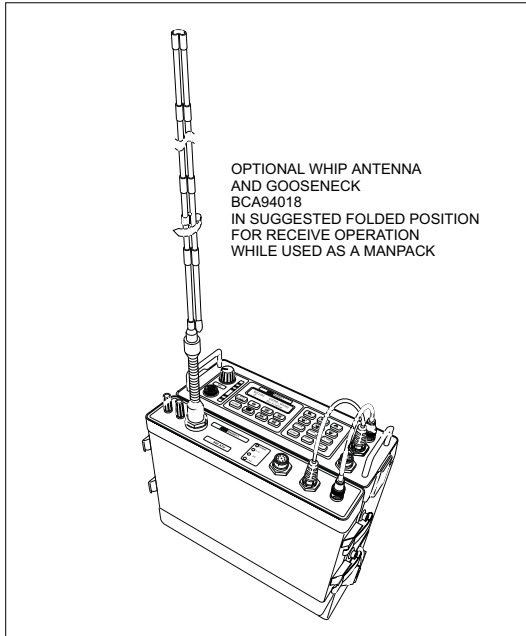

Using the throw over long wire antenna

The long wire antenna should be unfurled and the end away from the 940 transceiver should be attached to any structure available and as high as possible. When ever a channel is changed, and the next time the 940 is switched to transmit the antenna tuner will tune automatically.

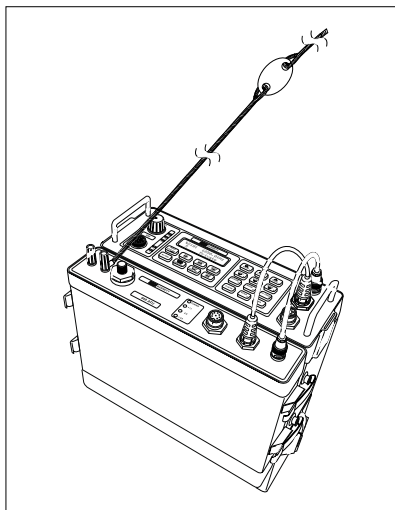

Man-pack operation with manual tapped whip antenna

The whip antenna should now be mounted on the antenna stud of the 940 portable as indicated in the diagram below.

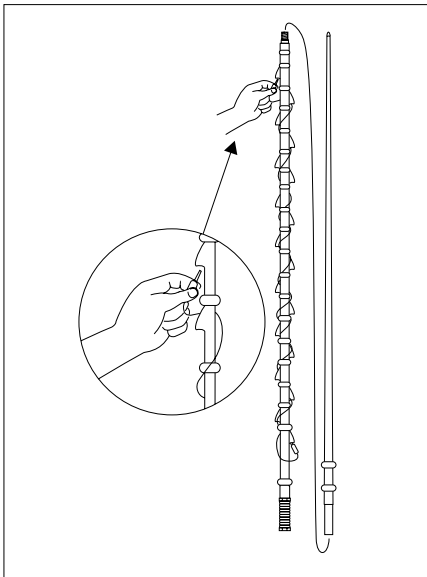
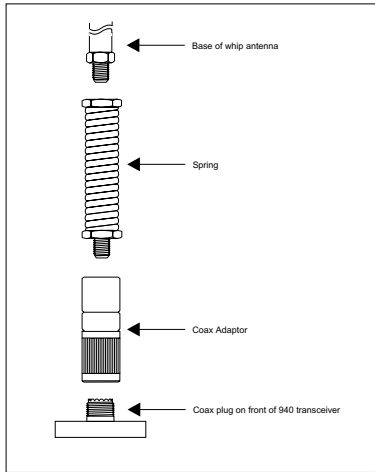

The frequency shown on the transceiver should now be selected on the antenna. This is done with the supplied jumper lead.

When using the lowest frequency the jumper lead should be removed from the bottom antenna socket and stored in the side pocket of the canvas carry case.

On all other channels the jumper lead is required and should be plugged into the bottom socket, wound around the antenna up to the socket marked with the channel frequency required.

Illustrated is a 18 frequency 914 manual tapped whip antenna with the highest frequency being selected.

Note:- It is important for correct operation of the whip antenna to have the right frequency tap selected as indicated above and that the jumper lead is wrapped tightly around the antenna between sockets

Battery Charging

The Barrett 940 portable transceiver uses a 13Ah NiMH battery pack. The battery can be charged from either a mains AC source between 90VAC and 264VAC or from a 12V nominal DC source, capable of supplying 5Amps, such as a car vehicle battery or solar supply. To maximize the battery life, charging must be performed according to the manufacturers specifications.

Spare battery packs are available so one can be charged while the other is in service.

NiMH batteries are sensitive to temperature. Charging should not be attempted when the ambient temperature is lower than -10°C or higher than 40°C .

Charging the 940 13Ah NiMH battery from a mains supply.

To charge the 13Ah battery pack from the mains both the mains charger supply Barrett P/N BCA94012 and the 12V input charge regulator Barrett P/N BCA94021 are required. Refer to the diagram for connection details.

Charging the 940 13Ah NiMH battery from a 12V DC supply.

To charge the 13Ah battery pack from a 12V nominal DC supply the 12V input charge regulator Barrett P/N BCA94021 and the DC power lead Barrett P/N BCA94015 are required. Refer to the diagram for connection details. Note:- The DC supply must be capable of at least 5 Amps

Charging

The following describes the charging process for both mains and DC charging:-

As indicated above, refer to the relevant diagrams for connection details dependant upon whether you are charging from the mains or from a DC source.

The charge regulator, Barrett P/N BCA94021, has a green LED, this flashes during normal charging conditions then stops flashing and is illuminated continuously when the battery is charged.

Charging proceeds at approximately 2.5A until the battery reaches a fully charged state. Charging time will be approximately 6 hours from a fully discharged state.

If during the charging cycle the battery starts to over-heat or is too cold, the charge cycle is interrupted until the battery returns to the correct temperature. This condition is indicated by the illumination of the red LED.

During charging the case of both the charge regulator and the mains charger supply (if used) will feel warm. This is normal.

If the battery pack has been over discharged, i.e. by being left in storage for extended periods without use, the charge regulator may need to trickle charge the battery pack for up to 5 hours to gain a minimum safe voltage level before fast charging can occur. This function is handled automatically by the charge regulator but obviously increases the charging time.

Note:- The input labelled "DC Input" must be supplied with a voltage between 10.8V and 15.6V, capable of at least 5A. If the supply is not capable of at least 5A continuous output at a minimum voltage of 10.8V the under-voltage protection will be triggered and a relay chatter is likely to be heard. If this chatter continues disconnect the charger from the power source. Always plug the DC input into the charger before connecting the battery to be charged. If the supply current capability is close to 5A and the battery is connected before the DC supply the previously mentioned chatter may be heard briefly.

The input labelled "BCA94012 Input" must only ever be supplied by a BCA94012 AC Input Charger Supply. Using any other supply is likely to trip the over- or under-voltage protection, disabling charging completely.

Note:-The battery charger will not provide power for the 940 transceiver.

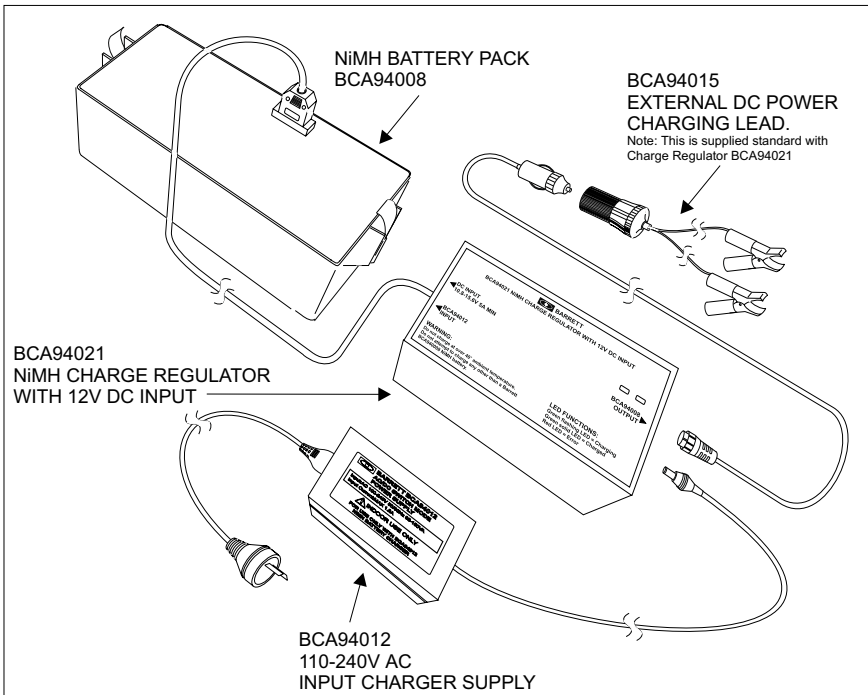

Operation from a external 12V supply

An external power / charging lead P/N BCA94015 is available for powering the 940 from an external DC power source such as a vehicle battery. It comes with a cigarette lighter plug for use with vehicle cigarette lighter sockets. A separate cable that has a socket that plugs into the cigarette plug, described above, provides alligator clips.

Note:- When using the leads above a change over switch within the transceiver disconnects the clip on battery pack. **The battery pack does not charge when the transceiver is connected to an external 12V supply.**

Note:- The external DC power source must be capable of supplying 12.4V DC minimum at 10Amps peak.

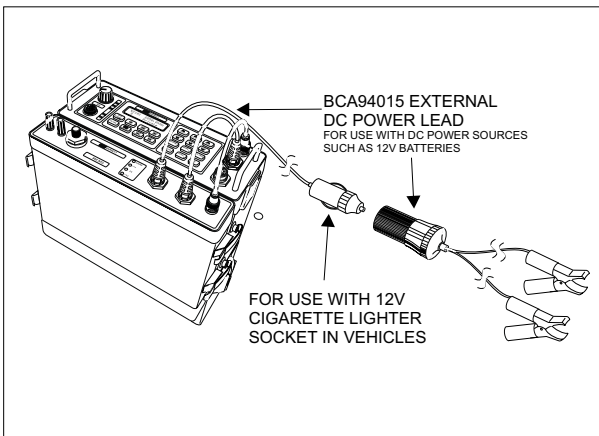
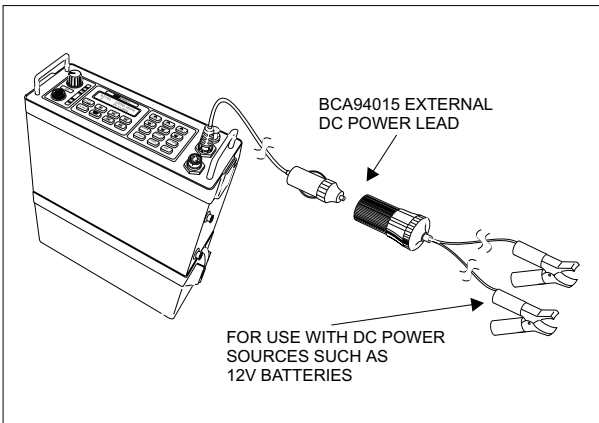

BCA94010 940 Multiple-use distribution unit

The distribution unit enables the user to simultaneously connect the following equipment to the 940 transceiver:

- a) A PC to enable programming of the 940 transceiver. Requires a programming cable (Barrett P/N BCA94014). The cable connects to the "RS-232" connector on the distribution unit.
- b) An external 13.8VDC power supply. Requires an external DC power cable (Barrett P/N BCA94015). The cable connects to the "13.8VDC Input" connector on the distribution unit.
- c) A morse key (Barret P/N BCA94002), which connects to the "Morse Key" connector on the distribution unit.
- d) Headphones (Barrett P/N BCA94004), which connects to the "Headphones" connector on the distribution unit.

The distribution unit may be connected directly to the 8-pin male connector on the 940 transceiver. If a 940 ATU (Barrett P/N BCA94009) is being used with the 940 transceiver, then the distribution unit is connected to the transceiver via the 8-pin male connector on the ATU.

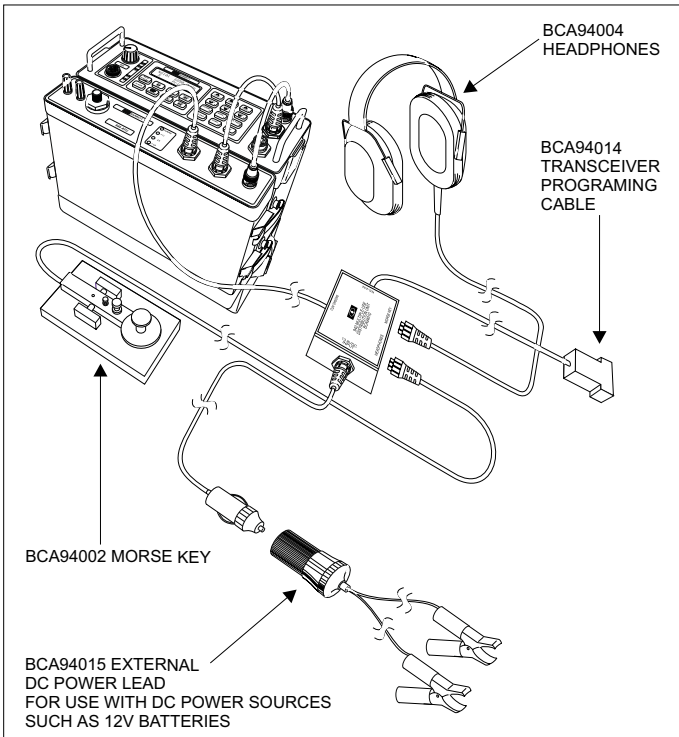

Connectors

8 pin waterproof panel mounted plug

Pin	Name	Description of function	Level	Option required to activate
1	Ground	Ground	0 VDC	None
2	Rx Data	RS-232 data input (for cloning/programming function only)	True RS-232	None
3	Tx Data	RS-232 data output (for cloning function only)	True RS-232	None
4	CW key	CW key input	Ground to activate	None
5	External Speaker	External speaker output	0-10V	None
6	Tune command	Antenna tune command to 940 automatic tuner option	Low going pulse	None
7	+13.8VDC	External power input - positive	+13.8VDC	None
8	+13.8VDC	Power output - to 940 ATU	+13.8VDC	None

5 pin waterproof panel mounted socket

Pin	Name	Description of function	Level	Option required to activate
1	Ground	Ground	0 V	None
2	Speaker	Speaker output	0-10 V	None
3	PTT	Transmit key.	Ground to activate	None
4	Mic in	Microphone input	10 mV	None
5	CW key	CW key input	Low to activate	None

Overview of HF operation

HF (High Frequency) is the radio spectrum with frequencies between 1.6 and 30MHz. Within this radio spectrum an efficient form of transmitter modulation, SSB (Single Side Band), is used. This, combined with the use of the ionosphere - a layer of ionisation gases that resides between 100 and 700km above the earth's surface, provides efficient, cost effective communications over short, medium and long distances - without the need for expensive re-transmission devices, such as the VHF or UHF repeaters or satellites, all of which have on going operational costs and a reliance on a physical infrastructure.

In many remote areas , HF/SSB is the only form of communication possible.

HF propagation

When HF/SSB radio waves are generated by the transceiver there are usually two components:-

- The ground-wave, which travels directly from the transmitting antenna to the receiving antenna following the contours of the earth.
- The sky-wave, which travels upward and at an angle from the antenna, until it reaches the ionosphere (an ionised layer high above the earth's surface) and is refracted back down to earth, to the receiving antenna.

Generally speaking, ground-wave is used to communicate over shorter distances usually less than 50km. Because ground-wave follows the contours of the earth, it is affected by the type of terrain it passes over. Ground wave is rapidly reduced in level when it passes over heavily forested areas or mountainous terrain.

Sky-wave is used to communicate reliably over medium to long distances up to 3,000km. Whilst the nature of sky-wave propagation means it is not affected by the type of terrain as in ground waves it is affected by factors involving the ionosphere as described below.

Radio wave propagation illustrated

The following illustrations show the characteristics of ground-wave and sky-wave propagation during day and night time. In each illustration the height of the ionosphere above the ground is shown.

In both illustrations Station A communicates with Stations B, C and D. Propagation from Station A to B is by ground-wave. The diagrams illustrate that the ground wave is not affected by the time of day and the height of the ionosphere above the ground.

Propagation from Station A to C and D, however, is by sky-wave and as the diagrams illustrate the sky wave is significantly affected by the time of day and the height of the ionosphere above the ground.

Under each diagram there are recommended working frequencies listed. Please note that these will vary according to time of year and other factors. They are intended only as a guide and are subject to change.

Day

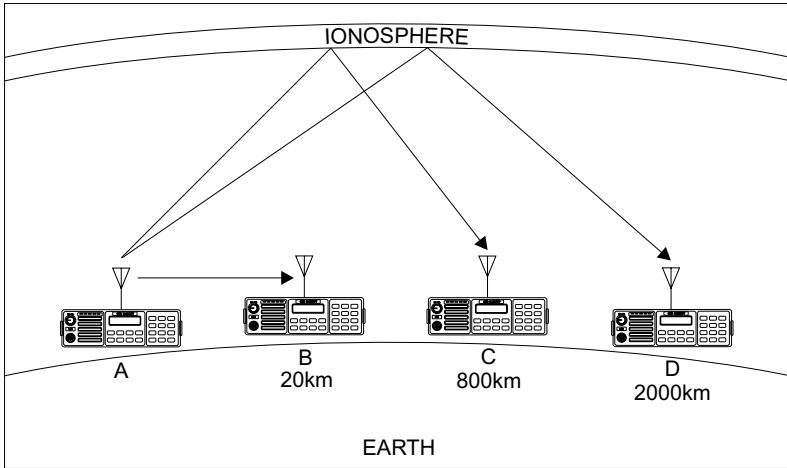

The sun is higher, the ionosphere is higher, the best frequency to use is higher

- A to B - Possible optimum working frequency is 3 MHz
- A to C - Possible optimum working frequency is between 7 - 9 MHz
- A to D - Possible optimum working frequency is between 13-16 MHz

Night

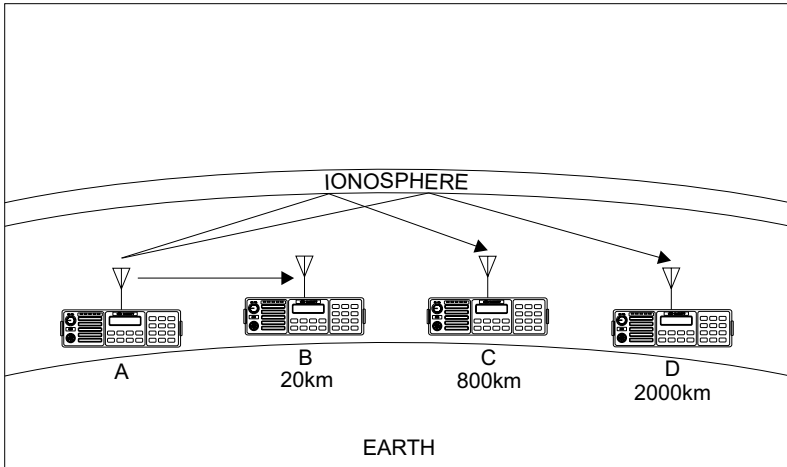

The sun is lower, ionosphere is lower, best frequency to use is lower

- A to B - Possible optimum working frequency is 3 MHz
- A to C - Possible optimum working frequency is between 5 - 7 MHz
- A to D - Possible optimum working frequency is between 9 - 12 MHz

Factors which affect HF/SSB communications

There are a number of different factors which will affect the success of your communications via HF/SSB radio. These are outlined below:-

Frequency selection

Frequency selection is perhaps the most important factor that will determine the success of your HF/SSB communications.

Generally speaking the greater the distance over which you want to communicate, the higher the frequency you should use.

Beacon call, a Selcall (selective call) function built into the Barrett 940 transceiver, makes finding the correct frequency to use easy. Beacon call is based on the network transceivers all having a selection of frequencies that will accommodate most ionospheric conditions. When in standby the network transceivers scan these frequencies waiting for a call (Selcall or beacon call) from another transceiver. The transceiver wishing to check for the best frequency to operate on sends a Beacon Call to the station he wishes to contact. If his call to the other station is successful he will hear a reverte call from the station he is calling, indicating the channel he selected was suitable for the ionospheric conditions prevailing. If he does not hear this reverte call or it is very weak, he tries on another channel until a reverte call of a satisfactory signal strength is heard.

(Refer to Selcall (selective call) section of this manual for full details on Beacon call operation.)

Time of day

As a rule, the higher the sun, the higher the frequency that should be used. This means that you will generally use a low frequency to communicate early morning, late afternoon and evening, but you will use a higher frequency to cover the same distance during times when the sun is high in the sky (e.g. midday). You will need to observe the above rule carefully if your transceiver has a limited number of frequencies programmed into it, as you may only be able to communicate effectively at certain times of the day.

Weather Conditions

Certain weather conditions will also affect HF/SSB communications. Stormy conditions will increase the background noise as a result of 'static' caused by lightning. This background noise could rise to a level that will blank out the signals you are trying to receive.

Man-made electrical interference

Interference of an electrical nature can be caused by overhanging power lines, high power generators, air-conditioners, thermostats, refrigerators and vehicle engines, when in close proximity to your antenna. The result of such interference may cause a continuous or intermittent increase in the level of background noise.

System configuration and installation

The method in which your system is configured and installed will also affect the success of your HF/SSB communications. Your choice of antenna system and power supply is critical. Correct installation is also extremely important. An HF/SSB transceiver is generally installed using different rules to those used to install VHF or UHF transceivers. Failure to correctly install an HF/SSB system will greatly affect the communications quality you will obtain. Refer to the installation section of this manual for details.

Your local Barrett representative will be able to assist with your system configuration and/or installation.

Special note - HF communications compared with VHF or UHF short distance communications

Communications on any HF/SSB transceiver will sound different to that on a VHF (Very High Frequency) radio or UHF (Ultra High Frequency) radio or telephone. This is because of the nature of HF propagation and the modulation methods used. On HF/SSB transceivers there will always be background noise evident behind the signal you are receiving and this will increase when there is electrical interference or thunderstorm activity in the area.

