

CUNNINGHAM TRANSMITTERS



MODEL CM 30 - 50

FRONT PANEL VIEW

8 - 3/4 inches high by 19 inches wide by 12 inches deep

POWER: Adjusts from 0 - 50 Watts
Shown on Front Panel Meter

FCC TYPE APPROVED

Number KJVCM 30 -50



REAR VIEW

CRYSTAL CONTROLLED
OPERATES DIRECTLY FROM LINE LEVEL INPUT
SUCH AS FROM A MIXER OR AUDIO UNIT

Available from:
J.R. CUNNINGHAM
P.O. BOX 8
Stonewall, OK 74871

JAMES R. CUNNINGHAM TRANSMITTERS

MODEL 30 - 50

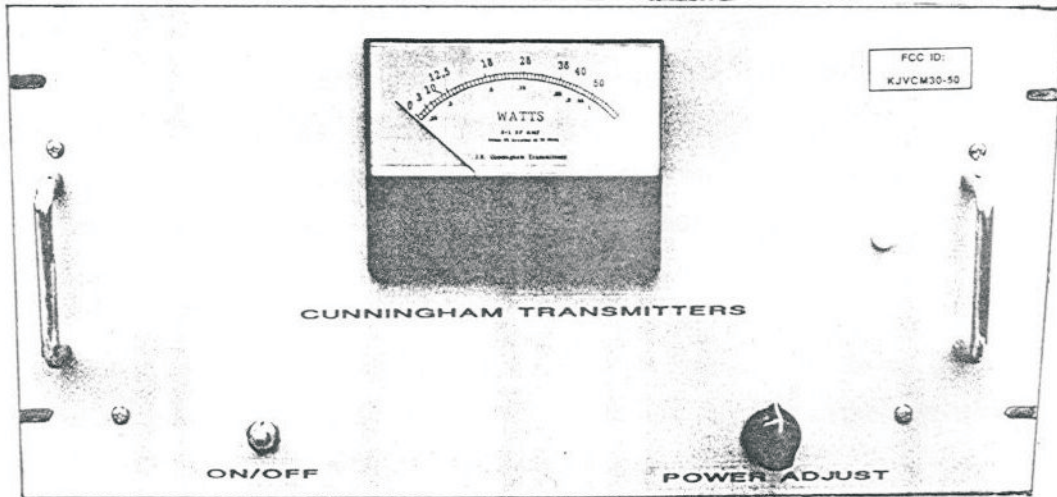

FRONT PANEL VIEW

8 3/4 inches High by 19 inches Wide by 11 1/2 inches Deep

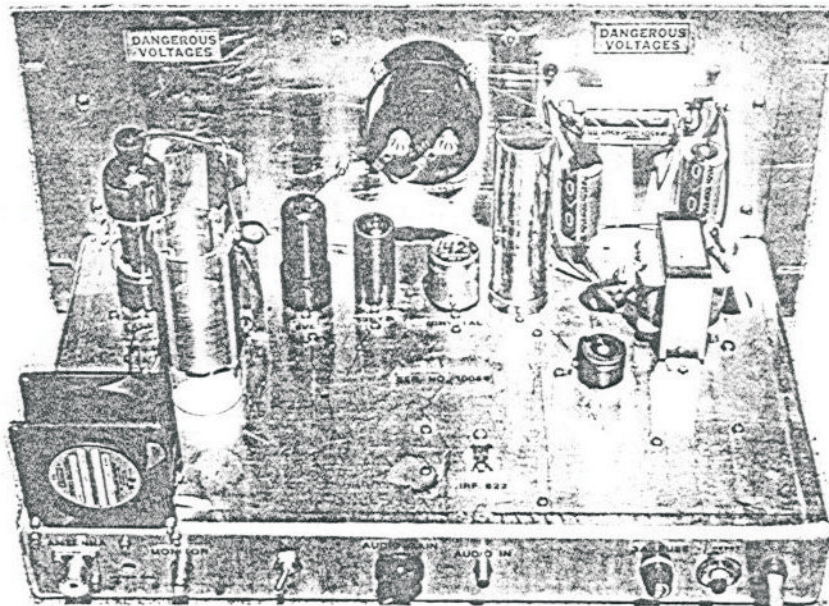

REAR CHASSIS VIEW
FCC ID # KJVCM30-50



Southeastern

TECHNICAL SERVICES

— BROADCAST

— RADIO

— MISSIONS

JAMES R. CUNNINGHAM, Broadcast Engineer

P.O. Box 8, Stonewall, OK 74871

(405)265-4496

ABOUT THIS TRANSMITTER

IF THE TRANSMITTER IS PLACED TOO CLOSELY TO YOUR ANTENNA TUNING UNIT, SOME RF FEEDBACK MAY ENTER THE AUDIO AMPLIFIER CIRCUITRY CAUSING SEVERE AUDIO DISTORTION. IT IS RECOMMENDED THAT THE TRANSMITTER ITSELF BE SEPARATED FROM THE ANTENNA TUNER BY AT LEAST 30 FEET, FOR BEST PERFORMANCE.

HIGHER LEVEL MODULATION

THIS UNIT HAS A SWITCH ON THE CHASSIS WHICH ALLOWS A DISCONNECT FROM THE INTERNAL MODULATOR AMPLIFIER AND AUTOMATICALLY SWITCHES IN A HIGH QUALITY MODULATOR TRANSFORMER. THIS MUST BE USED WITH A "USER SUPPLIED" AMPLIFIER OF ABOUT 10-25 WATTS POWER. YOUR AUDIO INPUT WIRES MUST BE REMOVED FROM THE BACK OF THE TRANSMITTER, AND CONNECTED TO YOUR "USER SUPPLIED" AMPLIFIER. A VERY HIGH LEVEL MODULATION IS NOW POSSIBLE. (This is desirable when used with strong audio processing).

If distortion is present in the audio, it is most likely caused by RF OVERLOAD due to close proximity to the ATU. Moving, or shielding (inside a cabinet, for example) may correct this. A Ground wire or strap connected to the back of the Transmitter may help, but in some cases does not. IN EVERY CASE, BE SURE THAT THE ATU IS FULLY GROUNDED TO THE ANTENNA GROUND RADIAL SYSTEM.

THE INTERNAL TRANSISTOR MODULATOR

The internal Modulator is so designed that it will give 125 percent modulation when used without modern processing methods. The intensity of many Audio Processors may cause modulation capability to fall short of expectations. HOWEVER, where A NATURAL DYNAMIC RANGE is desired, this Transistor Modulator performs in a superior fashion, adjusting itself to the natural internal dynamics of the ear. If this feature is not desired, SWITCH TO EXTERNAL MODULATOR and provide your own Amp. with your NRSC Approved Processor.

CHECKING THE MODULATION

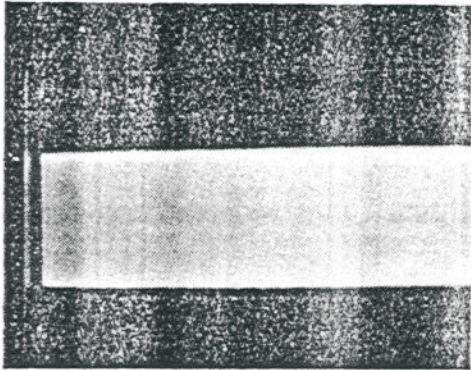

(A) Unmodulated carrier.

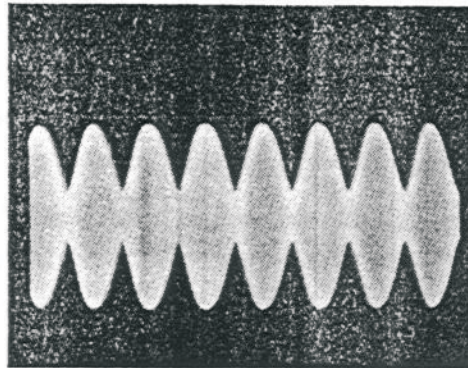

(B) 50% modulation.

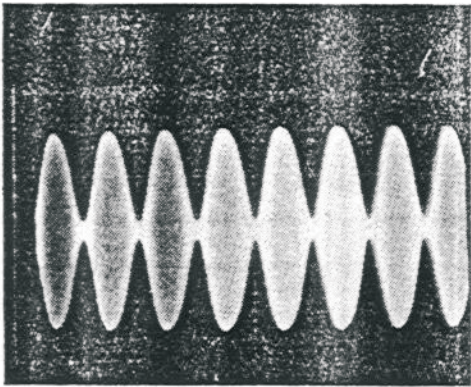

(C) 100% modulation.

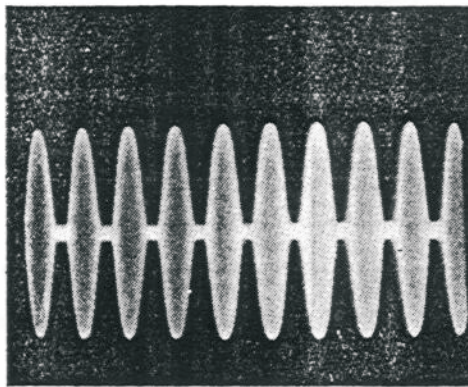

(D) Overmodulation.

Connect a BNC Cable at the rear of the Transmitter, where it is labeled "MONITOR" and view the sample on an Oscilloscope. The 'scope should be set for audio frequency response. Run a single tone, such as 500 Hz or 1000 Hz into the audio input terminals or jack. The following patterns will show up on the screen of the 'scope according to how much audio is being fed into the Transmitter (patterns shown above).

TRANSMITTER OUTPUT POWER

Your Model CM 30-50 Transmitter is designed to produce a maximum of 36 watts as Licensed by the F.C.C. into your Antenna System. "Proofs" show good performance at outputs below 36 watts. Users often try to exceed 36 watts (50 watts for example) and encounter CARRIER SHIFT REGISTRY on a modulation monitor. The Transmitter is Licensed for 0-36 Watts but do not expect the same quality audio response if 36 Watts is exceeded.

TROUBLESHOOTING THE SOLID STATE
DARLINGTON MODULATOR

1. When changing frequency of transmitter, it is advisable to use a jumper from the cathode of the P.A. FINAL TUBE TO GROUND until tuning is completed. Otherwise you may cause failure of the Darlington Transistor(s). This is because SURGES or VOLTAGE SPIKES travel along the wire from the tube to the transistor as well as RF Voltages causing the burnout. These things are improved by the presence of the toroid or RF Choke in line with the Cathode lead to the transistor modulator. The .01 Mf. capacitors help eliminate RF spikes which may damage the transistors.

2. CHECK THE TRANSISTOR STAGE AS FOLLOWS:

With the audio input gain control set all the way COUNTER-CLOCKWISE, measure RESISTANCE TO CHASSIS GROUND with an OHM METER. The READINGS SHOULD APPROXIMATE THE FOLLOWING:

A. From CATHODE OF TUBE TO GROUND - 100K to 150K ohms. If this is much lower, the Darlington is bad and will not amplify audio. (10K with meter leads reversed).

B. FROM BASE OF TRANSISTORS TO GROUND: 1,000 Ohms
APPX. (with leads reversed - 4,000 Ohms).

C. FROM NEGATIVE SIDE OF INPUT CAPACITOR TO GROUND: 150 Ohms, APPX.
(With Audio Level Control all the way CLOCK-WISE - 10,150 ohms, APPX).

POWER METER READINGS

The power meter is located on the front panel of the Model 50 Transmitter. It is capable of accurate readings of power as set up upon manufacture IF OPERATED INTO A NON-REACTIVE 50 Ohm LOAD.

The meter should be re-calibrated in cases where the load contains reactance. This may be more often than supposed.

Operate the Transmitter with a Bird Meter or Thermocouple R.F. Amp Meter in line with the Load and re-calibrate using the "Meter Calibrate" trim pot on the back or top of the chassis.

NEGATIVE MODULATION?

The Power Meter on the front panel is to be set up WITHOUT MODULATION because it deflects backwards under normal modulation due to its Design. This does not indicate negative modulation due to the fact that normal positive modulation is indicated both on the Oscilloscope and on a Thermocouple R.F. Amp Meter in line with the Antenna System.

Under full power, the Transmitter may actually modulate in a negative manner, but this does not indicate a sacrifice in audio quality, but is characteristic of CATHODE MODULATION as used in this Radio Transmitter. If a thermocouple type meter is used in line with this Transmitter, and if negative modulation actually occurs, reduce the power output setting and modulating factors will return to normal.

The Power Meter is designed to track accurately powers from 10 - 50 watts once it is calibrated to the antenna system used.

The meter's backward movement at higher powers may be used to indicate the amount of modulation according to the amount of deflection. Once normal operation is noted, you may be able to tell if the Transmitter is working properly at a glance toward the meter.

SERVICING THE MODEL 30-50

1. CHECKING THE ACCURACY OF THE CRYSTAL OSCILLATOR:

[a] Connect a frequency counter to the BNC Connector at the rear of the transmitter where it is labeled "Monitor" and read the frequency with the transmitter at a power level of at least 10 watts R.F. Output into the Antenna System or into a dummy load resistor.

[b] Adjust frequency using C4 trim capacitor or one of the other trimmers in the oscillator circuit. THIS OPERATION SHOULD BE DONE FROM BENEATH THE CHASSIS. IT MAY BE NECESSARY TO PLACE THE TRANSMITTER "ON THE BENCH" as described below.

2. CHECKING TUBES: The Model 50 does not employ a built-in tube checker circuit, but tubes may be unplugged and tested in any commercially available Tube Checker. IMPORTANT NOTE: Many tube checkers have only limited accuracy and may not tell you the truth. In this case, you may test by Substitution.

[a] TESTING TUBES BY SUBSTITUTION: First, observe the operation of the Transmitter with the old tubes, then substitute a tube known to be good (new tube) in place of one tube at a time, being sure to turn the Transmitter "Off" before removing or replacing tubes. The Voltages in the Transmitter may cause serious shock, so avoid contact with any wires containing voltage. If a new tube improves the performance of the Transmitter, leave it in the socket and then go on to the next tube, substituting a new tube there as well. If the Transmitter is restored to normal operation by replacing a tube, you have found the problem. Discard the old tube if it tests bad in the Transmitter, even if it checks perfect in a tube checker. The checker is obviously "wrong."

3. After replacing tubes

[a] After replacing the Oscillator Tube, CHECK THE FREQUENCY FOR ACCURACY. If off more than 20 Hz. either way, adjust C4 from beneath to center frequency.

[b] After replacing Buffer/Driver tube (6V6 or 6L6) adjust R9 for correct power output into Antenna or Dummy Load.

[c] After replacing 6DQ5 Power Amp Tube, adjust R9 for correct power output into the Antenna System or Dummy Load.

TYPICAL VOLTAGE READINGS

[taken without modulation]

NOTE: These Readings are typically taken with the Transmitter on the Service Bench with the power transformer side down. This exposes the bottom of the transmitter circuitry. Output should be into a 50 ohm non-reactive dummy load resistor.

ALL READINGS TAKEN AT 40 - 50 Watt Output.

VOLTAGES

1. Line Voltage: 120 - 124 VAC 60 Hz. typical
2. Filament Voltages: 6.3 VAC
3. B+ Voltage taken at C1[B] on filter choke lead [420 - 450 VDC]
4. OSCILLATOR PLATE SUPPLY VOLTAGE - 230 to 260 VDC [measure at junction of R2 - R3.
5. Oscillator Screen Supply Voltage - 145 VDC [taken at pin number 8 of 12BY7]
6. Negative Bias Voltage on 6DQ5 grid - 100 V B- [taken at bottom end of R.F. Choke Coil where R6 joins R8].
7. Driver/Buffer Plate Voltage - 420 VDC [measure at bottom of L3 R.F. Choke where R5 joins R3.
8. 6DQ5 Power Amp Plate Voltage - 420 - 450 VDC [taken at bottom end of L4 where R7 ties into the B+ line]. This voltage may be checked by carefully removing the 6DQ5 from the socket and reading voltage directly from the plate cap on the top side of the chassis.
9. 6DQ5 Screen Voltage - 230 VDC [read from pins 4 & 8]

TUBE PLACEMENT CHART

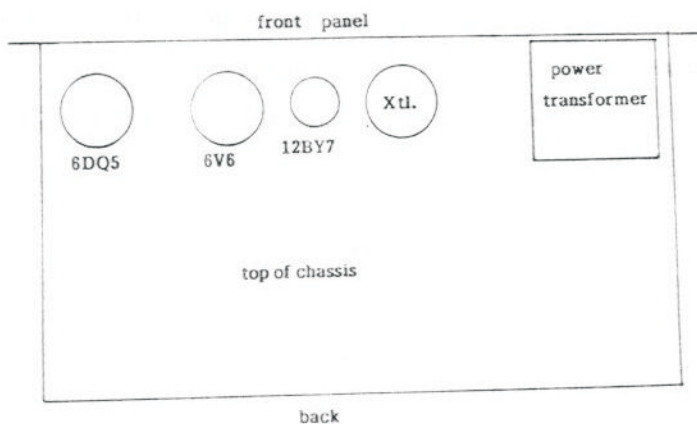

OPTIONAL
P.A. GRID DRIVE ADJUSTMENT

1. The Coil or capacitor assembly for grid drive tuning may need to be adjusted if the frequency of operation is changed or when the Unit is serviced. The COIL ASSEMBLY is normally used only in the SHORT WAVE version.
2. Adjust trim capacitor for a lower setting to where Bias Control R-9 (this is known as the "Level Control") will adjust power output from low to high with a very smooth operation. Some Units do not use this Control, if it is not needed.
3. (VERY IMPORTANT!) If the trimmer is set too high, R-9 Level Control will not operate at all or it will work in an erratic manner. In extreme cases, there will be harmonic distortion of the signal when the trim capacitor is set for too high of a drive level. Drive level adjustment provides for a "linear" Waveform.
4. The purpose of the Grid Drive Tuning Network is to provide complete control over P.A. Grid Drive Level. It is almost never set for resonance. To do so will usually ruin frequency response of the audio and distort the P.A. Tank Waveform. An Oscilloscope may be connected to the "BNC" jack while making adjustments to the transmitter to insure against improper tuning or erratic operation.
5. R.F. Grid Drive is set for a balance between R.F. Drive and Grid Bias, so that Cathode Modulation will occur SMOOTHLY. When this balance is lost, the Modulation suffers as well as the Output Waveform. In most cases, this adjustment seldom needs any attention, but if disturbed, erratic performance may result.

PREMATURE LOSS OF P.A. TUBES (6DQ5) MAY BE CAUSED BY TOO MUCH R.F. DRIVE INTO IT'S GRID [pin numbers 1G5].

In order to check for correct drive, it may be necessary to remove the Model 50 from it's rack and place the Unit on it's side (power transformer down) on the work bench. Now, operate the Unit into a 50 Ohm non-reactive Dummy Load at normal power (40 to 50 watts). Output may be read using a Bird Meter or a calibrated 0-1 Amp R.F. Thermocouple Meter in line with the Dummy Load. With the Unit operating as described, the grid bias on THE BOTTOM END OF the R.F. Grid Choke will be about 100 volts B- (negative). If this voltage is much greater, there is too much R.F. Drive into the grid of the 6DQ5 causing premature burnout. This can be adjusted using the trim capacitor in the grid circuit[see Schematic].

HOW TO ADJUST GRID DRIVE LEVEL if ever needed:

[a] Turn the trim capacitor to a TIGHTER SETTING. This will give a greater capacitance reducing the drive. If the Transmitter output will turn up and down smoothly using R9, you are OK. If the Transmitter shows a GREATER power output at the lowest setting, YOU HAVE GONE THE WRONG WAY, there is too little capacitance and TOO MUCH R.F. GRID DRIVE. Make the setting so that there is as little grid drive as necessary to obtain proper operation of the R9 Level Control.

[b] When R9 will turn the Power Output SMOOTHLY from almost Zero [0] to about 50 Watts, you have achieved a normal setting of R.F. Grid Drive Level.

[c] IN EXTREME CASES it may be necessary to change out the Trim Capacitor in the 6DQ5 Grid Circuit with one of a greater value (if you have too much drive) or one of a smaller value (if you have too little power output from the 6DQ5. These adjustments should be done only by service technicians acquainted with R.F. Circuits.

MODULATOR SWITCHING
Model CM 30 - 50 Radio Transmitters

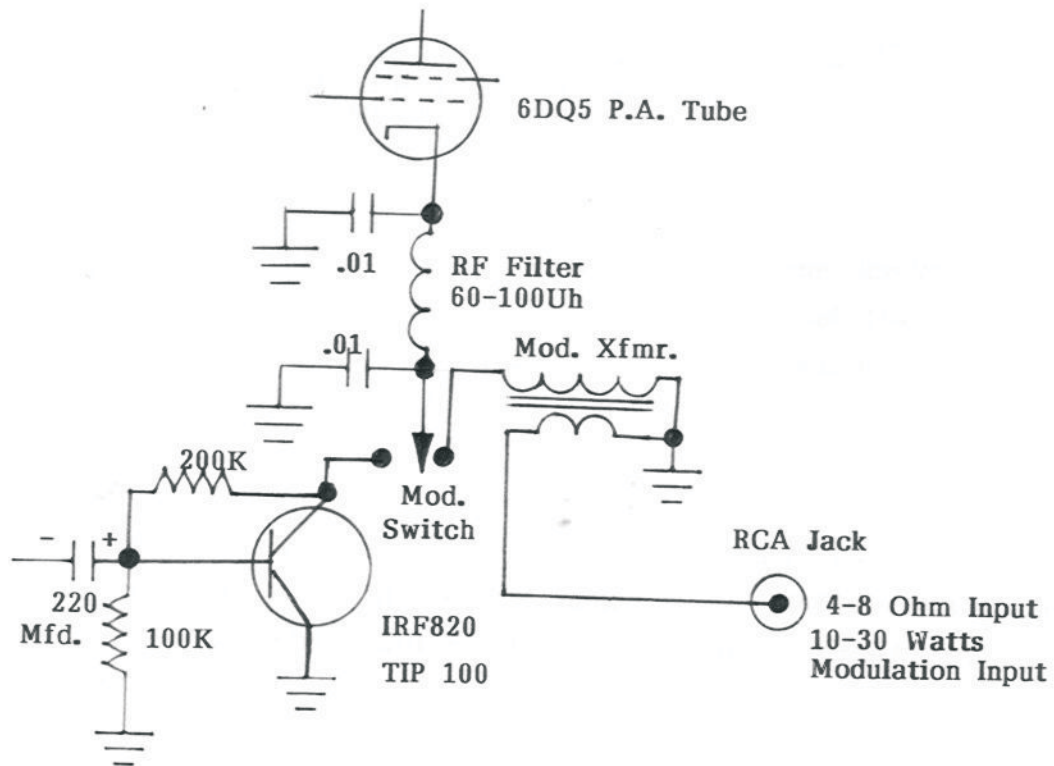

The Modulator Switch provides for two Methods of Modulation. One: Internal - the other: External, using a separate Audio Amplifier of 10 - 30 Watts Power.

The User may select between "INTERNAL/EXTERNAL" as desired. If Audio Equipment is located too close to Antenna, RF may feed back into Transmitter Audio Section, possibly damaging Transistors, or Audio Amplifier. Recommended separation between Transmitter and Antenna is 30 feet Minimum. Separation between Transmitter and Audio Equipment should be 15 feet or more for proper operation.

Audio requirements for 100 Percent Modulation is 4 Watts at 36 Watts of Output from the Radio Transmitter. A 10 Watt Amplifier allows extra "Headroom" for a brighter sounding Signal, selectable at the User's Option.

Southeastern TECHNICAL SERVICES

BROADCAST

RADIO

MISSIONS

JAMES R. CUNNINGHAM, Broadcast Engineer

P.O. Box 8, Stonewall, OK 74871 3-14-95

(405)265-4496

MODIFICATIONS FOR TRANSISTOR MODULATOR FOR 50 and 100 WATT TRANSMITTERS

1. REPLACEMENT PART NUMBER; 511-IRF 822 (FET TRANSISTOR)
source: MOUSER 800-346-6873
cost: .97 each

TIP-100

(.66)

MODIFICATION NECESSARY
AS SHOWN

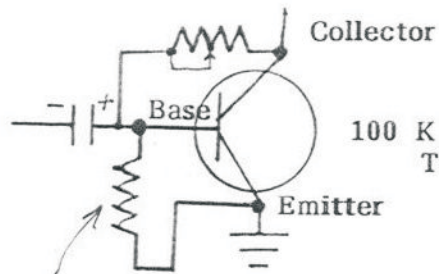

100 K 1/2 W Resistor goes from BASE
TO EMITTER ONLY!

1/2 W. 100K
ADD THIS PART

INSTALLATION

NOTICE THAT THE PART (100K 1/2W)
SHOULD BE LOCATED ACROSS THE TWO LEGS
OF THE TRANSISTOR (ON THE BOTTOM OF THE SOCKET)

PICTORAL INSTRUCTIONS

BOTTOM VIEW OF SOCKET

ADD 100K as
SHOWN HERE

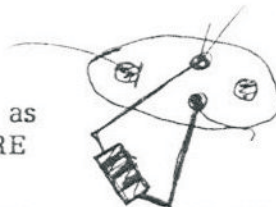

USE 1 (one) RESISTOR ONLY!

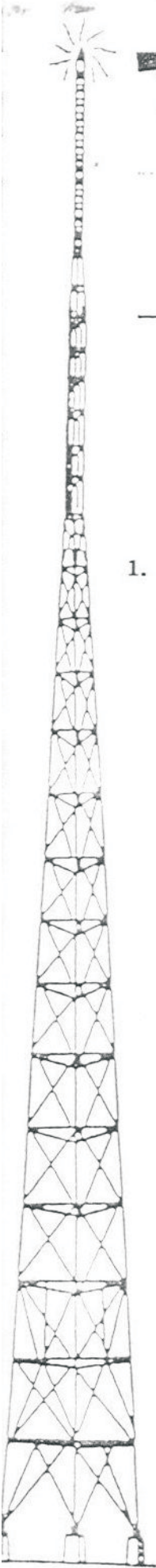

Southeastern TECHNICAL SERVICES

BROADCAST

RADIO

MISSIONS

JAMES R. CUNNINGHAM, Broadcast Engineer

P.O. Box 8, Stonewall, OK 74871 3-14-95

(405)265-4496

MODIFICATIONS FOR TRANSISTOR MODULATOR FOR 50 and 100 WATT TRANSMITTERS

1. REPLACEMENT PART NUMBER; 511-IRF 822 (FET TRANSISTOR)
source: MOUSER 800-346-6873
cost: .97 each

TIP-100

(.66)

MODIFICATION NECESSARY
AS SHOWN

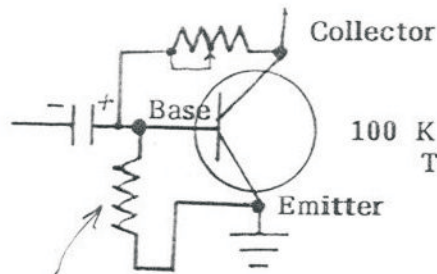

100 K 1/2 W Resistor goes from BASE
TO EMITTEER ONLY!

1/2 W. 100K
ADD THIS PART

INSTALLATION

NOTICE THAT THE PART (100K 1/2W)
SHOULD BE LOCATED ACROSS THE TWO LEGS
OF THE TRANSISTOR (ON THE BOTTOM OF THE SOCKET)

PICTORAL INSTRUCTIONS

BOTTOM VIEW OF SOCKET

ADD 100K as
SHOWN HERE

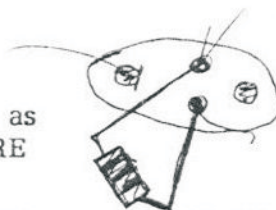

USE 1 (one) RESISTOR ONLY!

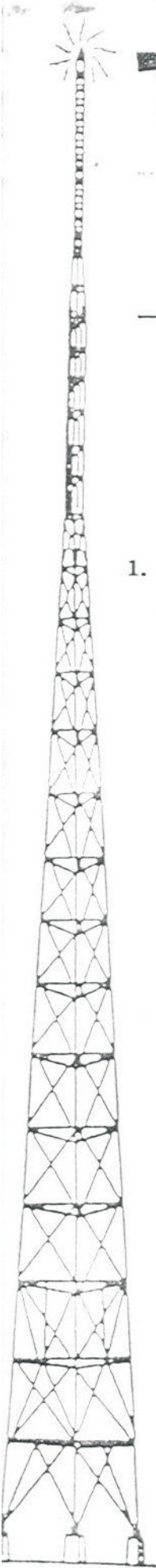

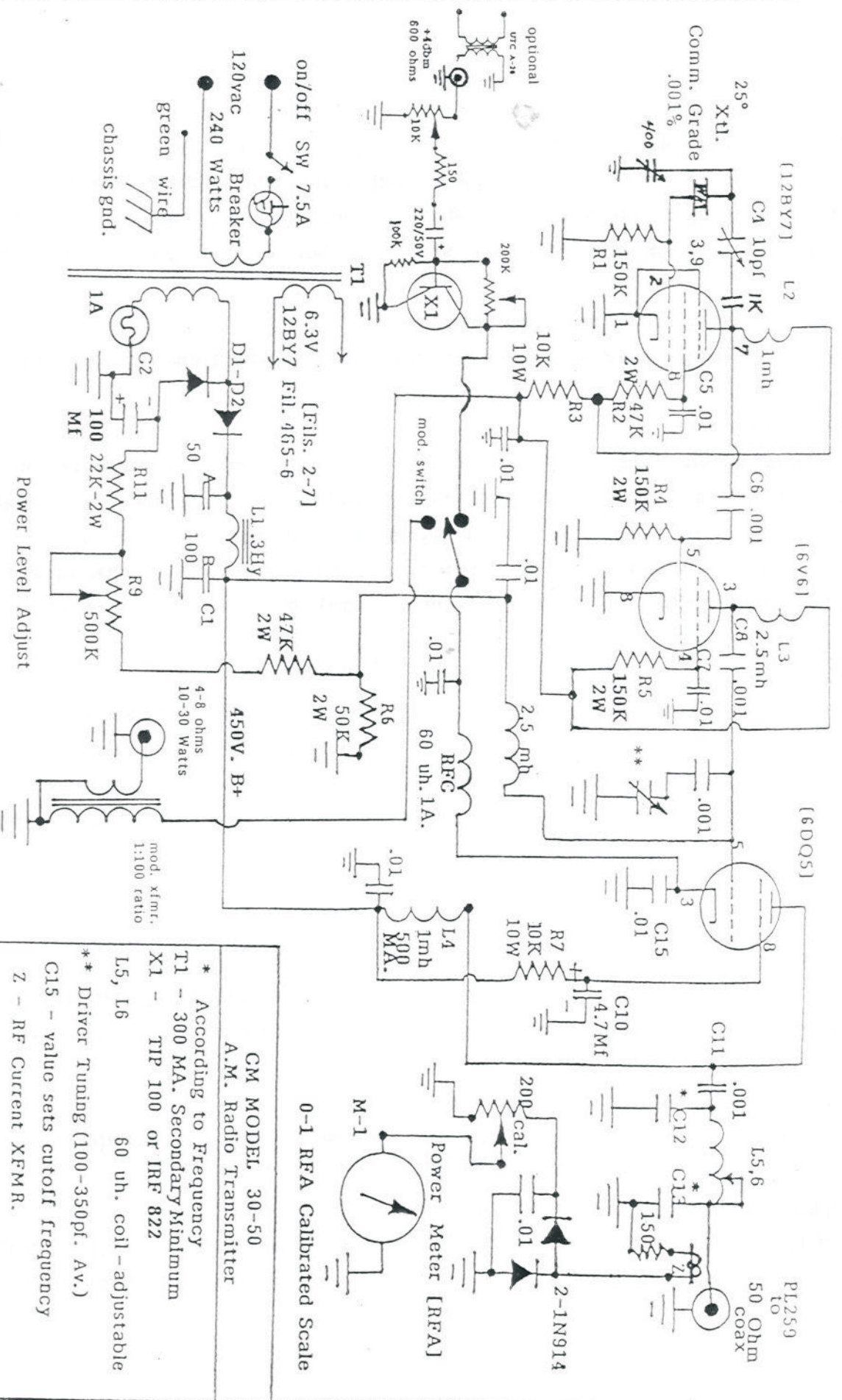

0-1 RFA Calibrated Scale

CM MODEL 30-50
A.M. Radio Transmitter

- * According to Frequency
- T1 - 300 MA. Secondary Minimum
- X1 - TIP 100 or IRF 822
- L5, L6 60 uh. coil - adjustable
- ** Driver Tuning (100-350pf. Av.)
- C15 - value sets cutoff frequency
- Z - RF Current XFMR.

M-1 Set by calibrated Standard
R-7 may vary from value shown
by James R. Cunningham

TROUBLE SHOOTING FLOW CHART

SYMPTOM: Low Output

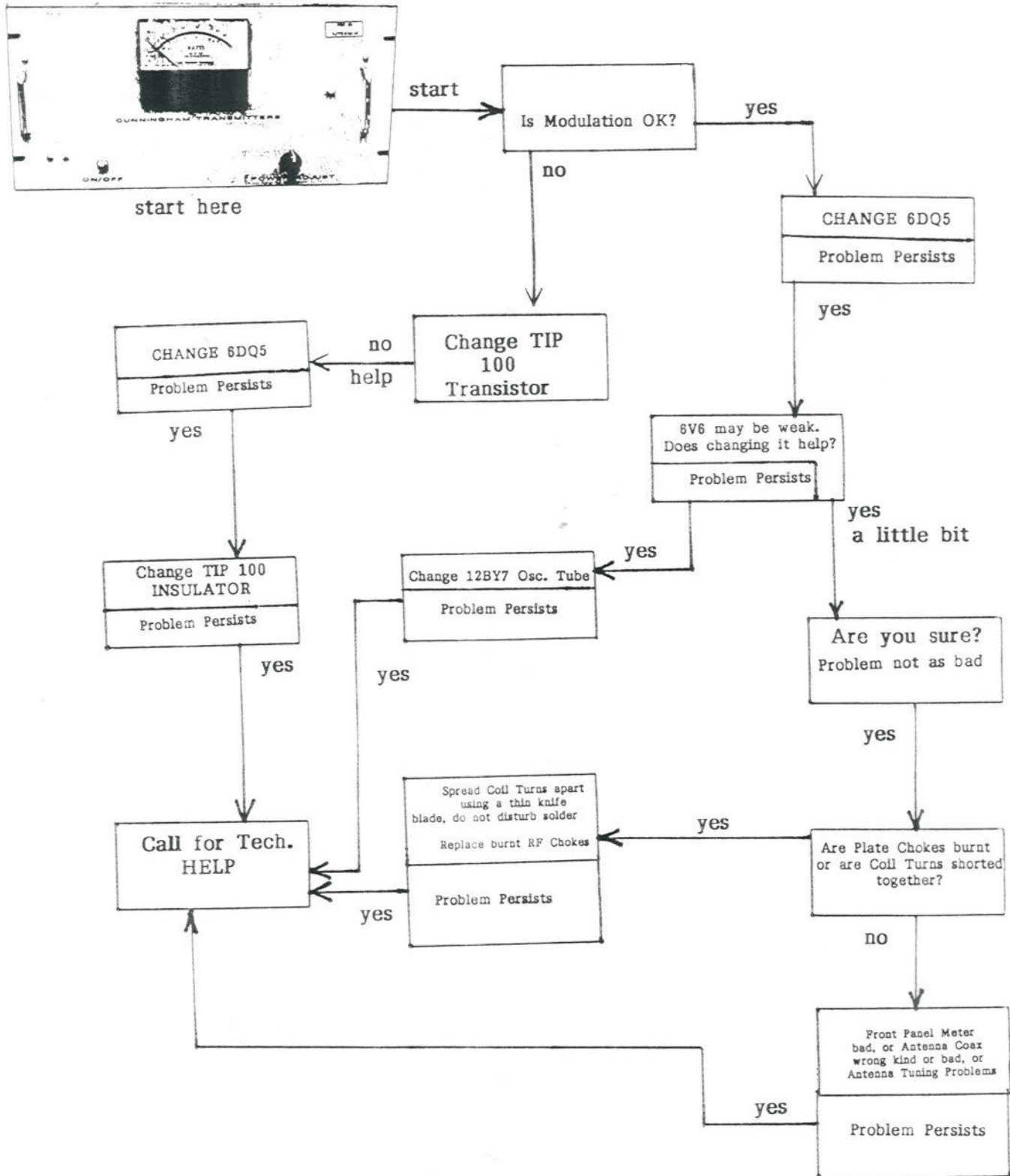

TROUBLE SHOOTING FLOW CHART AUDIO PROBLEMS

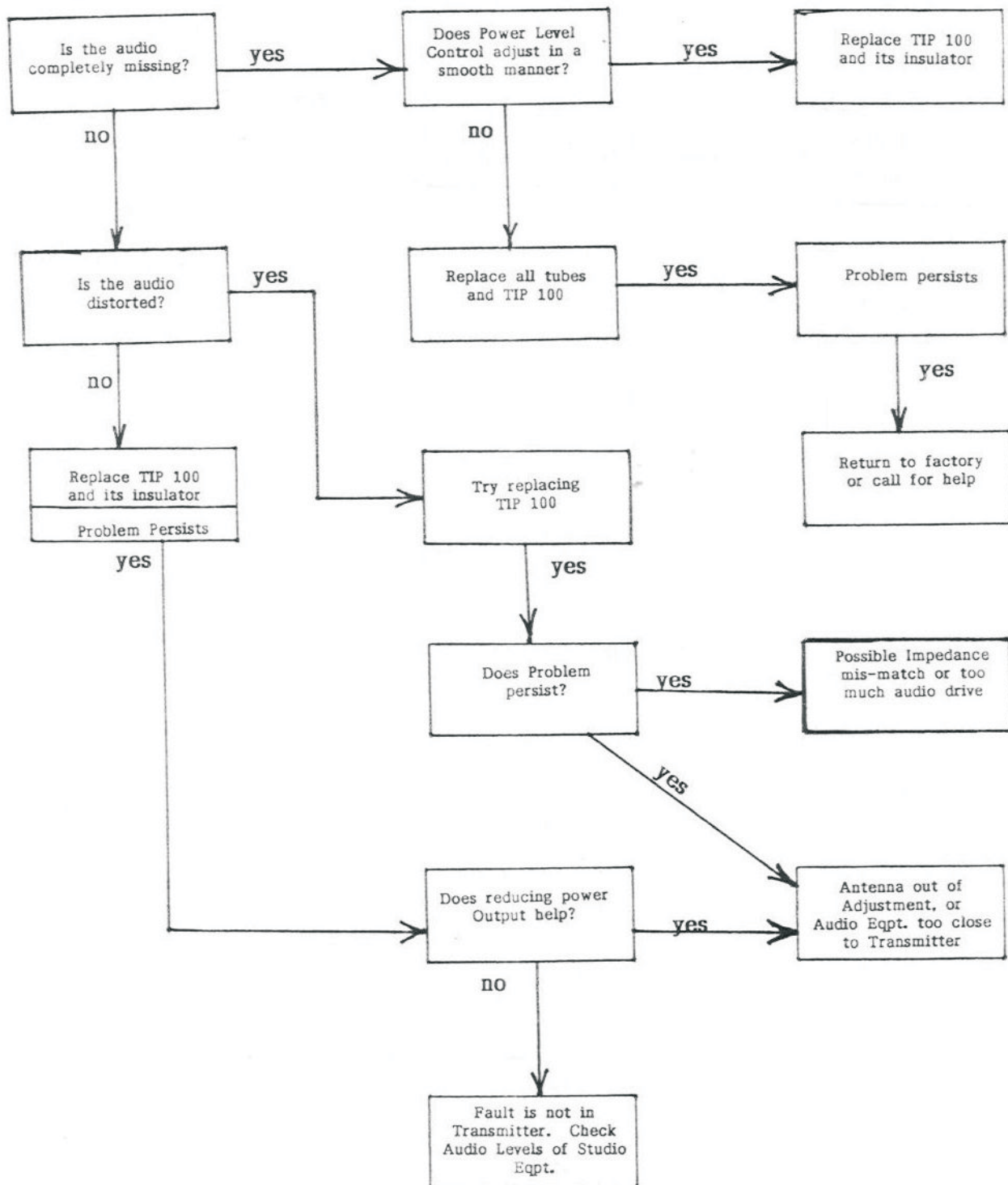

TRUBLE SHOOTING FLOW CHART
 SYMPTOM: NO RF OUTPUT

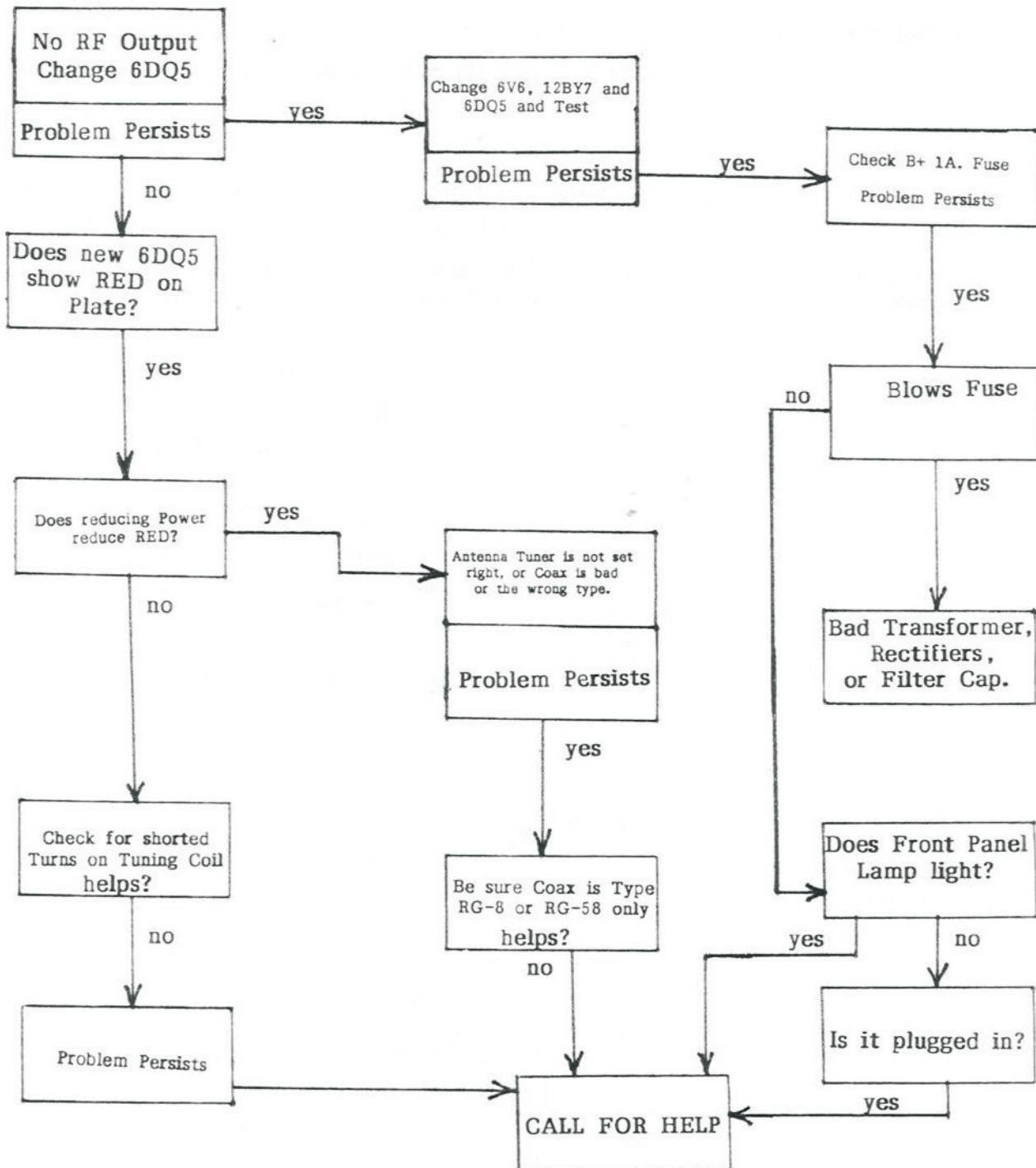

MASTER TUNE UP CHART
FOR CUNNINGHAM MODEL CM 30-50
A.M. RADIO TRANSMITTER

SEE REVERSE FOR ADDITIONAL INFORMATION

| FREQ. | SHORT BETWEEN | ACTIVE | INDUCT. | PLATE LOADING ADDED CAPACITOR | TOTAL PF. PLATE CAP. |
|-----------|---------------|----------|----------|----------------------------------|-------------------------|
| 1600-1620 | #17-18 | 33 Turns | 28uh | orig. only | 300-310 pf |
| 1510-1590 | #16-17 | 34 | 29 | - | - |
| 1470-1500 | #15-16 | 35 | 30 | - | - |
| 1410-1460 | #14-15 | 36 | 31 | - | - |
| 1400 | #13-14 | 37 | 32 | - | - |
| 1360-1390 | #9-10 | 41 | 36 | - | - |
| 1300-1350 | #8-9 | 42 | 37 uh | - | - |
| 1200 | #3-4 | 46 | 44 | - | - |
| 1110-1190 | use full coil | 48-50 | 50uh | - | - |
| 1010-1100 | #9-10 | 41 | 36 | ADD 150pf | 450pf |
| 910-1000 | FULL COIL | 48 | 48-50 | ADD 230pf | 530pf |
| 810-900 | FULL COIL | 48 | 48-50 uh | ADD 260pf | 560-600pf |
| 710-800 | FULL COIL | 48 | 48-50 | ADD 350pf | 650pf |
| 660-700 | FULL COIL | 48 | 48-50 | ADD 450pf | 750pf |
| 610-650 | FULL COIL | 48 | 48-50 | ADD 700pf | 1000pf |
| 535-600 | FULL COIL | 48 | 48-50 | ADD 1000pf | 1200-1500pf |

TUNING COIL EXAMPLE

1. HOW TO COUNT TURNS: Begin at the bottom of the coil and count upwards towards the top. The wire clip is inserted between turns as indicated. There is no need to solder the clip in place, as it will stay and make good contact. If contact ever loosens, tighten by inserting a sharp knife blade inside the clip and expanding it SLIGHTLY. Don't over do it, as it is possible to ruin the clip.
2. ACTIVE TURNS: Count from the wire clip upwards to determine the Active Turns.
3. PLATE LOADING CAPACITORS ARE ADDED AT "POINT A"
4. Use only MICA or AIR GAP Capacitors at Point "A" of 500 V. or greater Rating. DO NOT use ceramic Capacitors of less than 5/8 DIA. with 3KV. Rating or greater.

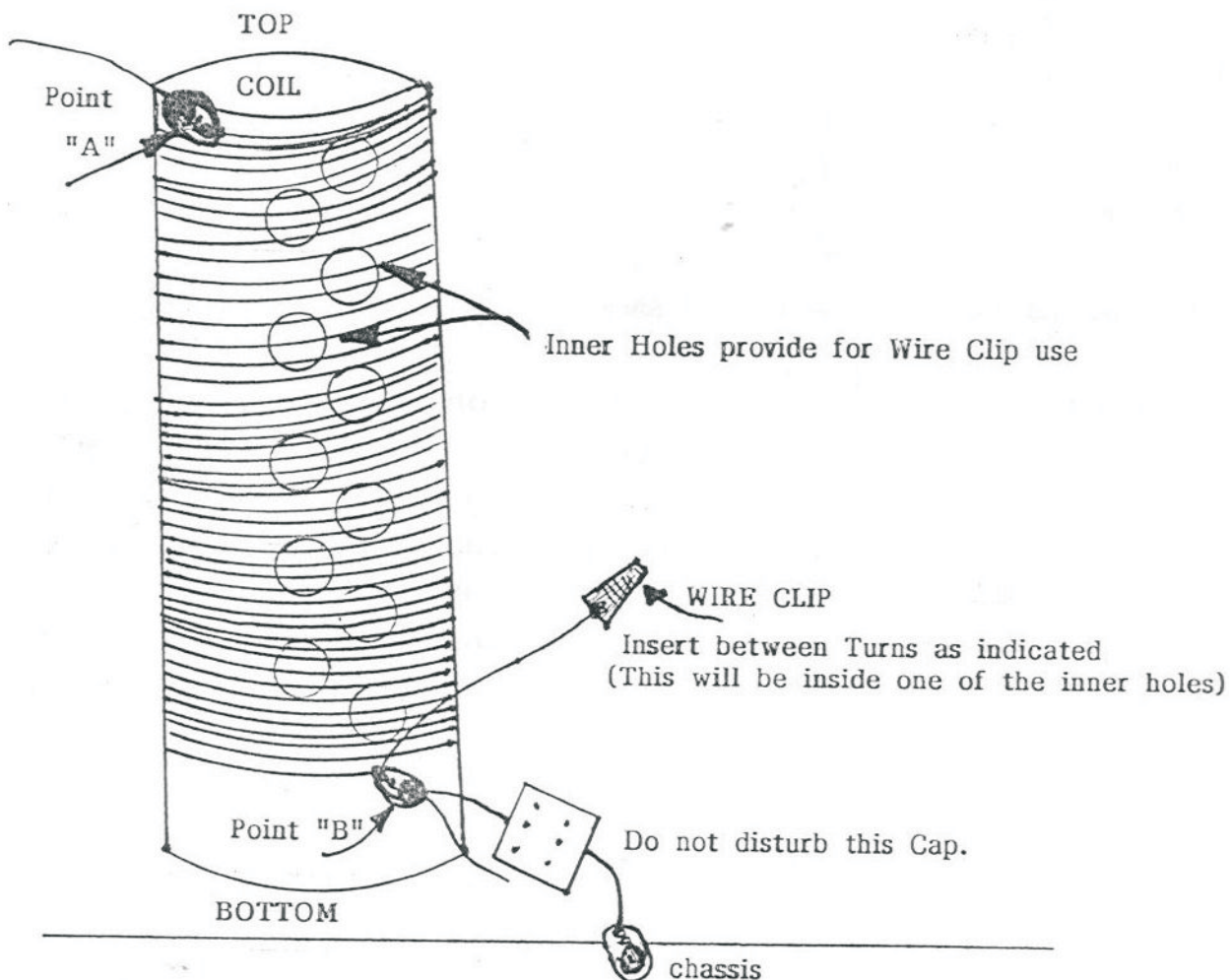

NOTES: Follow Instructions. LOW FREQUENCIES require a tighter setting of the GRID DRIVE TRIM CAPACITOR. INSTRUCTIONS ARE IN THE BOOK THAT COMES WITH YOUR TRANSMITTER.

BOTTOM VIEW OF CHASSIS

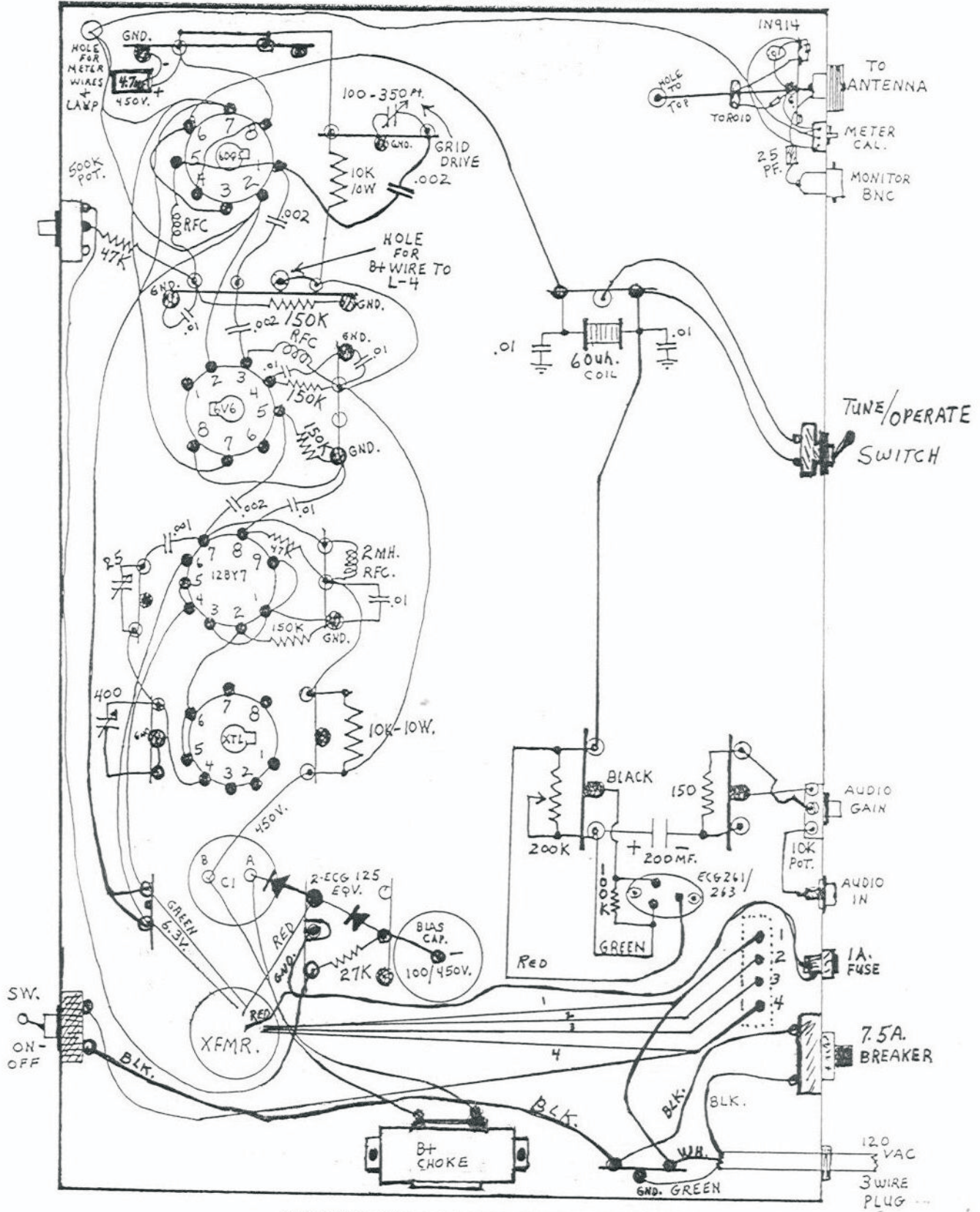

SERVICE TECHNICIAN'S WIRING LAYOUT

[Practical Pictorial Wiring Diagram]

by JRC © 1992

MODEL 30-50

The Models 30 - 50 Standard Broadcast Radio Transmitter is available from 500 Khz through 1700 Khz. This Radio Transmitter is useful as a Low Power Broadcast Transmitter for "Standby," for Carrier Current Applications, or as a first Radio Transmitter for use in Missionary and other applications in Foreign Nations.

The power level is adjustable using "Panel Knob" to the desired level up to 50 watts of power output. Once this is set up, it should not be moved unless due to tube aging or FCC Requirements, it must be changed.

The tubes in this Transmitter are selected for long life and cost effectiveness. These are commonly available from Electronics Dealers. The Transmitter comes in a Standard RACK MOUNT CASE but is available at an extra cost in an enclosed case equipped with an exhaust fan. Unless conditions demand, the Rack Mount Style is highly recommended due to fewer problems with servicing, etc.

Audio frequency response is in the high fidelity range and is limited to FCC Specifications through the use of Capacitor **C15**. If this transmitter is used in a closed music system (carrier current), this may be changed to a smaller value to increase response and bandwidth. FCC Specifications dictate the use of a **NRSC-1** or **NRSC-2** processor ahead of this transmitter if used in the USA.

Please consult the latest FCC Rules in regards to AM Standards.

Distortion and noise measurements from 50hz through 7500Hz are typically less than .1 percent.

Transmitters up to 5000 watts power are available using the unique **CUNNINGHAM METHOD** of modulation and construction technology.

Address inquiries to: James Cunningham - "Engineering"
P.O. BOX 8, Stonewall, OK 74871 USA

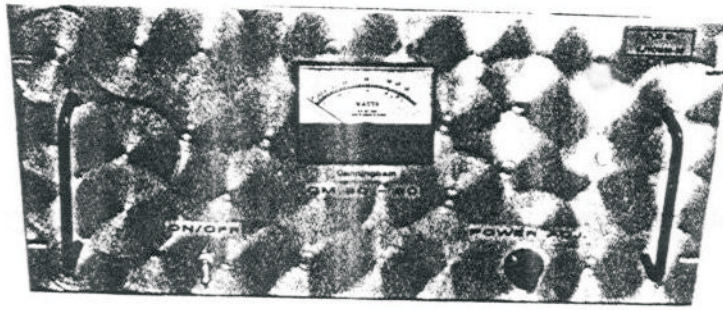

CM Model 30-50
F.C.C. ID # KJVCM 30-50

The CM (Cathode Modulation) Model 30-50 is a Standard Broadcast A.M. Radio Transmitter that is superior to other Transmitters in several ways:

1. The Unit weighs far less than other Transmitters with similar power Outputs. Each Unit weighs about **12** pounds, which makes possible shipping by U.S. Mail Service to most parts of the world. This can result in substantial savings to the Foreign Broadcaster.
2. Its CATHODE MODULATION Design results in BETTER FREQUENCY RESPONSE as well as less harmonic content in its R.F. Signal. A PURE SINE WAVE flows from its oscillator all the way through to the antenna, regardless of modulation percentage!



back view

3. Its TUBE TYPE design makes possible EASY SERVICING (a complete INSTRUCTION MANUAL comes with each Unit) and the tube compliment is available in most nations, including the U.S.A.
4. Its dependable Design is highly RESISTANT TO POWER BROWNOUTS and SURGES which damage most solid state equipment.
5. The Tube Type Design results in MUCH LOWER PURCHASE PRICE, less weight, and its simple solid state modulator section provides reliability with added savings in maintenance and monthly electric bills.
6. The entire Unit measures 19 inches wide by 8-3/4 inches high by 11 inches deep, a Standard Rack Mount Configuration, ideal for the Professional. A small blower quietly cools components for increased reliability and safety.

-- Model 30-50
SPECIFICATIONS
F.C.C. ID # KJVCM 30-50

Frequency Range: 530 KHZ through 1710 KHZ

RF POWER OUTPUT: 5 watts through 36 watts adjustable (typical 50 watts)

OUTPUT IMPEDANCE: 50 Ohm load (coaxial cable)

RF Output Fitting: UG/U SO 239 or any other upon request

Harmonic and Spurious: -60db or better

CARRIER REGULATION: 3% max. (400 HZ. 95% Modulation)

FREQUENCY STABILITY: \pm 10 HZ. (0-50 deg. Cent.)

AUDIO RESPONSE: \pm 1 db. 20 HZ - 7500 HZ. 95% Modulation (15Khz special req.)

NOISE: - 60 db. or better (400 HZ. 95% Modulation)

AUDIO INPUT: + 4 dbm. 600 ohm balanced input (100% Mod. at 30 watts)
+ 8 dbm. for 100% Mod. at 50 watts

MODULATION CAPABILITY: 100%

AMBIENT TEMPERATURE: 0 Degrees F. through +120 Degrees F.

HUMIDITY: 95% Maximum

ALTITUDE: 8000 ft. max.

WEIGHT UNCRATED: 12 lbs.

FEATURES: SINGLE POWER CONTROL ADJUSTS TO ANY POWER BETWEEN 5 WATTS AND 50 WATTS INSTANTLY. CONTROL SERVES TO COMPENSATE FOR TUBE AGING OR LINE VOLTAGE CHANGES. TRANSMITTER IS HIGHLY RESISTANT TO "BROWN OUTS." SUITABLE FOR CARRIER CURRENT USE OR PRE-SUNRISE OR POST-SUNSET USES. TRANSMITTER TYPICALLY HAS MUCH LOWER HARMONIC AND NOISE CONTENT THAN LISTED ABOVE, MAKING IT A BEST CHOICE IN DEMANDING SITUATIONS. EASY SERVICING DUE TO ITS SIMPLE DESIGN AND COMPLETE INSTRUCTION MANUAL.

POWER CONSUMPTION: 200 - 240 watts (depending on output used)

TYPICAL PLATE EFFICIENCY: 50 - 65 Percent (depending on output)

SUPPLY VOLTAGE: 120 volts/50 - 60 HZ. (220 volts upon request)

OVERALL EFFICIENCY: 20 - 30 percent depending on output power used

TYPICAL OPERATION

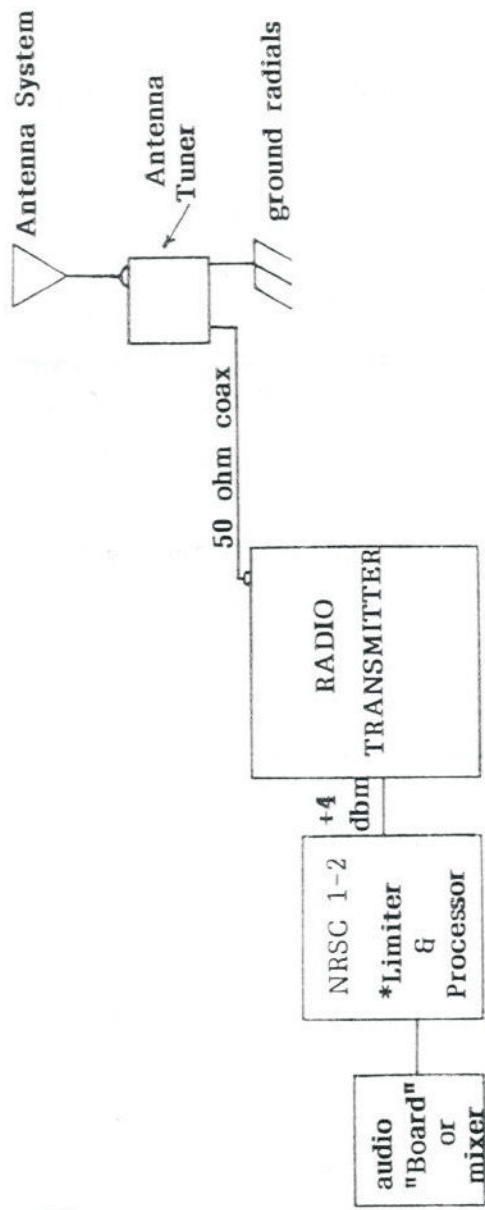

*NRSC 1 & 2

Limiters are required by the FCC for use in the USA

CM Model 50
SPECIFICATIONS

Tests Results are for 30 watts
through 50 watts

AUDIO FREQUENCY RESPONSE AT 100 PERCENT MODULATION

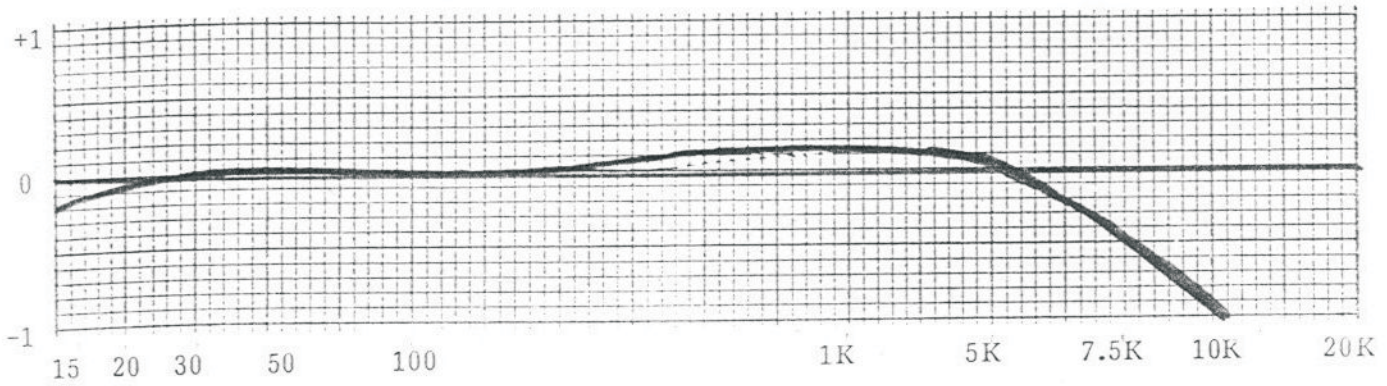

Results shown are without NRSC in Line
600 Ohm Balanced Line Input

1000 HZ. REFERENCE

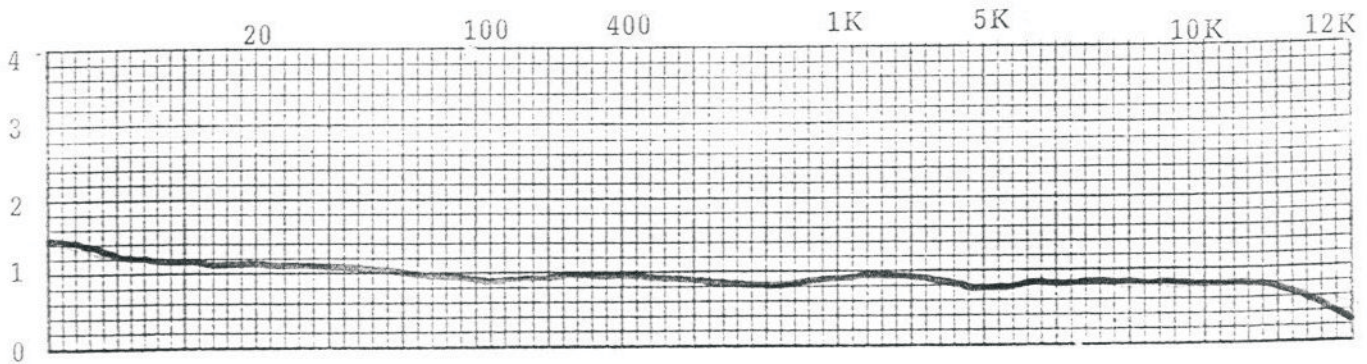

TOTAL HARMONIC DISTORTION
95 Percent Modulation

Tests performed by
JAMES R. CUNNINGHAM
FCC Lic. # PG 10-21117 (10/27/92)

James R. Cunningham