



# INSTRUCTION MANUAL



## **TR-M**

**SSB RADIOTELEPHONE**

R. L. DRAKE COMPANY, MIAMISBURG, OHIO, U.S.A.



### LIMITED WARRANTY

R. L. DRAKE COMPANY warrants to the original purchaser that this product shall be free from defects in material (except tubes and RF output transistors) or workmanship for ninety (90) days from the date of original purchase.

During the warranty period the R. L. DRAKE COMPANY or an authorized Drake service facility will provide free of charge both parts (except tubes and RF output transistors) and labor necessary to correct defects in material or workmanship.

To obtain such warranty service, the original purchaser must:

- (1) Complete and send in the Warranty Registration Card.
- (2) Notify R. L. DRAKE COMPANY or its nearest authorized service facility, as soon as possible after discovery of a possible defect, of:
  - (a) The model number and serial number, if any;
  - (b) The identity of the seller and the approximate date of purchase;
  - (c) A detailed description of the problem, including details on the electrical connection to associated equipment and the list of such equipment.
- (3) Deliver the product to the R. L. DRAKE COMPANY or the nearest authorized service facility, or ship the same in its original container or equivalent, fully insured and shipping charges prepaid.

Correct maintenance, repair and use are important to obtain proper performance from this product. Therefore, carefully read the Instruction Manual. This warranty does not apply to any defect that R. L. DRAKE COMPANY determines is due to:

- (1) Improper maintenance or repair, including the installation of parts or accessories that do not conform to the quality and specifications of the original parts.
- (2) Misuse, abuse, neglect or improper installation.
- (3) Accidental or intentional damage.

All implied warranties, if any, terminate ninety (90) days from the date of the original purchase.

The foregoing constitutes R. L. DRAKE COMPANY'S entire obligation with respect to this product, and the original purchaser and any user or owner shall have no other remedy and no claim for incidental or consequential damages. Some states do not allow limitations on how long an implied warranty lasts or do not allow the exclusion or limitation of incidental or consequential damages, so the above limitation and exclusion may not apply to you.

This warranty gives specific legal rights and you may also have other rights which vary from state to state.

R. L. DRAKE COMPANY  
540 Richard Street • Miamisburg, Ohio 45342

### TABLE OF CONTENTS

	Page
CHAPTER I INTRODUCTION . . . . .	1-1
1-1. GENERAL DESCRIPTION . . . . .	1-1
1-2. MANUAL COVERAGE . . . . .	1-1
SPECIFICATIONS . . . . .	1-3
CHAPTER II INSTALLATION . . . . .	2-1
2-1. UNPACKING . . . . .	2-1
2-2. LOCATION . . . . .	2-1
2-3. VIEWING/MOUNTING OPTIONS . . . . .	2-1
2-4. POWER RATING . . . . .	2-1
2-5. CRYSTAL INSTALLATION AND PROGRAMMING . . . . .	2-1
2-6. PROGRAMMING . . . . .	2-1
2-7. TEST EQUIPMENT . . . . .	2-2
2-8. RECEIVE CRYSTAL INSTALLATION . . . . .	2-2
2-9. TRANSMIT CRYSTAL INSTALLATION . . . . .	2-2
2-10. ANTENNA REQUIREMENTS - GENERAL . . . . .	2-3
2-11. 50 OHM OUTPUT . . . . .	2-4
2-12. ANTENNA COUPLER . . . . .	2-4
2-13. 6 OR 8 MHz OPERATION . . . . .	2-4
2-14. 2 OR 4 MHz OPERATION . . . . .	2-5
2-15. ANTENNA COUPLER TUNING HINTS . . . . .	2-5
2-16. USING THE ANTENNA COUPLER ON 50 OHM ANTENNAS . . . . .	2-6
2-17. EXTERNAL CONNECTIONS . . . . .	2-6
CHAPTER III OPERATION . . . . .	3-1
3-1. GENERAL . . . . .	3-1
3-2. RECEIVE ONLY/REDUCED POWER CONSUMPTION . . . . .	3-1
3-3. RECEIVE/TRANSMITTER READY . . . . .	3-1
3-4. TRANSMITTING . . . . .	3-1
FRONT PANEL CONTROLS . . . . .	3-3



TABLE OF CONTENTS (continued)

	Page
CHAPTER IV THEORY OF OPERATION . . . . .	4-1
4-1. RECEIVER . . . . .	4-1
4-2. TRANSMITTER . . . . .	4-2
4-3. POWER SUPPLIES . . . . .	4-3
CHAPTER V MAINTENANCE . . . . .	5-1
5-1. SERVICE DATA . . . . .	5-1
5-2. ALIGNMENT - GENERAL . . . . .	5-1
5-3. TEST EQUIPMENT . . . . .	5-1
5-4. RECEIVER ALIGNMENT . . . . .	5-1
5-5. 10.7 MHz BFO FREQUENCY ADJUSTMENT . . . . .	5-2
5-6. IF AND MIXER ALIGNMENT . . . . .	5-2
5-7. 10.7 AND 5.35 MHz TRAP ALIGNMENT . . . . .	5-2
5-8. HF OSCILLATOR FREQUENCY ADJUSTMENT . . . . .	5-2
5-9. AUDIO AMPLIFIER BIAS ADJUSTMENT . . . . .	5-2
5-10. TRANSMITTER ALIGNMENT . . . . .	5-3
5-11. IF ALIGNMENT . . . . .	5-3
5-12. CARRIER BALANCE ADJUSTMENT . . . . .	5-3
5-13. 10.7 MHz TRAP ADJUSTMENT . . . . .	5-3
5-14. TRANSMITTER AGC ALIGNMENT . . . . .	5-4
5-15. TRANSMITTER FREQUENCY ADJUSTMENT . . . . .	5-4
5-16. PARTS LISTS . . . . .	5-4

LIST OF ILLUSTRATIONS

Figure		Page
1-1.	MODEL TR-M RADIOTELEPHONE . . . . .	1-2
2-1.	VIEWING/MOUNTING OPTIONS . . . . .	2-7
2-2.	PROGRAM BOARD (A8) . . . . .	2-8
2-3.	RECEIVE CRYSTAL INSTALLATION AND ALIGNMENT . . . . .	2-9
2-4.	ALIGNMENT LOCATIONS AND TEST POINTS - TOP VIEW . . . . .	2-10
2-5.	TRANSMIT CRYSTAL TRIMMERS . . . . .	2-11
2-6.	BOTTOM COVER SCREW IDENTIFICATION . . . . .	2-12
2-7.	CONNECTIONS FOR 50 OHM OUTPUT . . . . .	2-13
2-8.	BOTTOM VIEW WITH COVER REMOVED . . . . .	2-14
2-9.	TRIMMERS AND COIL TAPS FOR 23 FOOT WHIP ANTENNAS . . . . .	2-15
2-10.	TRIMMERS AND COIL TAPS FOR 35 FOOT WHIP ANTENNAS . . . . .	2-16
2-11.	REAR PANEL ARRANGEMENT . . . . .	2-17
2-12.	TRIMMERS AND COIL TAPS FOR 75 FOOT LONGWIRE ANTENNA . . . . .	2-18
3-1.	FRONT PANEL CONTROLS . . . . .	3-2
4-1.	TR-M BLOCK DIAGRAM . . . . .	4-5
5-1.	CHASSIS-MOUNTED COMPONENTS, TOP VIEW . . . . .	5-6
5-2.	BULKHEAD-MOUNTED COMPONENTS . . . . .	5-8
5-3.	CHASSIS-MOUNTED COMPONENTS, BOTTOM VIEW . . . . .	5-10
5-4.	TRANSMIT OSCILLATOR BOARD (A1) . . . . .	5-12
5-5.	DRIVER BOARD (A2) . . . . .	5-14
5-6.	RF FILTER BOARD (A3) . . . . .	5-16
5-7.	ALC BOARD (A4) . . . . .	5-18
5-8.	POWER DETECTOR BOARD (A5) . . . . .	5-20
5-9.	RF - IF BOARD (A6) . . . . .	5-22
5-10.	RECEIVE OSCILLATOR BOARD (A7) . . . . .	5-28
5-11.	PROGRAM BOARD (A8) . . . . .	5-31
5-12.	IF FILTER BOARD (A9) . . . . .	5-32
5-13.	POWER SUPPLY FILTER BOARD (A13) . . . . .	5-34



## LIST OF ILLUSTRATIONS (continued)

Figure		Page
5-14.	MICROPHONE BOARD (A16) . . . . .	5-35
5-15.	REAR PANEL COUPLER BOARD (A17) . . . . .	5-36
5-16.	12.9 VOLT DC POWER SUPPLY BOARD (A11) . . . . .	5-38
5-17.	12.9 VOLT DC POWER SUPPLY COMPONENTS . . . . .	5-39
5-18.	35 VOLT DC POWER SUPPLY BOARD (A15) . . . . .	5-40
5-19.	35 VOLT DC POWER SUPPLY COMPONENTS . . . . .	5-41
5-20.	TO COME . . . . .	5-42
5-21.	TO COME . . . . .	5-43
5-22.	12.9 VOLT DC POWER SUPPLY SCHEMATIC. . . . .	5-44
5-23.	35 VOLT DC POWER SUPPLY SCHEMATIC . . . . .	5-45
5-24.	AC POWER SUPPLY SCHEMATIC. . . . .	5-46
5-25.	MODEL TR-M SSB RADIOTELEPHONE SCHEMATIC. . . . .	5-47
5-26.	COMPONENT LEAD IDENTIFICATION. . . . .	5-48

## CHAPTER I INTRODUCTION

### 1-1. GENERAL DESCRIPTION.

The Drake Model TR-M Radiotelephone provides communications in the 2 MHz, 4 MHz, 6 MHz, and 8 MHz marine bands. The unit has 11 channels, all of which are field programmable to select the band, receive frequency, transmit frequency, and mode of operation. All programming is done without soldering and is accomplished by the insertion of nickel-plated screws. The TR-M can be programmed to operate in the A3J, A3A, or A3H mode. When programmed for A3H operation, a true AM detector is automatically switched in for reception.

Power output is 150 Watts PEP with approximately 50 Watts of carrier when in the A3H mode.

The unit is all solid state except for the final power amplifier tubes. Modular construction permits easy servicing. Any one of four built-in power supplies is available: 12.9 or 35 Volts DC and 115 or 230 Volts AC.

The TR-M meets or exceeds all applicable FCC requirements and has been type-accepted for parts 81, 83, 89 and 91.

Features of the TR-M include:

- a. ALC control: 20 dB to limit output to 150 Watts. Additional control loop to limit intermodulation in driver stages under reduced power output.
- b. All solid state except final power output tubes.
- c. Protection circuit for antenna mismatch.
- d. 2182 kHz included—transmit and receive. Other channels optional.
- e. 11 programmable channels. Any mode A3A, A3J, or A3H can be set up on any channel.
- f. Channel frequency is easily established by inserting the proper crystal and trimming a capacitor to set that crystal on frequency. No other tuning or soldering in the radio is necessary.

- g. True AM reception with a diode detector.
- h. A test jack at back and a reduced power tune switch provide easy field tune up of the transmitter.
- i. Panel switch to turn off transmitter filaments. The transmit crystal oven and the receiver section remain on.
- j. RF indicator (LED).
- k. Built in power supply.
- l. Capable of being programmed to operate on any frequency in the 2, 4, 6 and 8 MHz marine bands.
- m. Printed circuit construction utilizing fiber glass filled epoxy printed circuit boards.
- n. Constructed for ease of maintenance. PC boards are accessible from both sides without removal from chassis.
- o. Plug in T/R relay.
- p. Carbon microphone attached.
- q. Accessory connector for external speaker and microphone operation.

### 1-2. MANUAL COVERAGE.

This manual is presented in 5 chapters for the convenience of the operator and service technician:

- |             |  |
|-------------|--|
| Chapter I   | Introduction. (self-explanatory)   |
| Chapter II  | Installation. Describes the procedures to be followed prior to operation.                                  |
| Chapter III | Operation. Illustrates and describes the front panel controls and outlines proper operating procedures.    |
| Chapter IV  | Theory of Operation. Describes all critical circuits and networks.   |
| Chapter V   | Maintenance. Provides sufficient information for maintenance of the TR-M by a licensed service technician. |





Figure 1-1. Model TR-M Radiotelephone

**SPECIFICATIONS**

<b>GENERAL</b>												
Frequency Range:	2, 4, 6 and 8 MHz Marine Bands.											
Channels:	Eleven (semi-duplex or simplex) programmable on any band.											
Input Voltage:	12.9 or 35 Volts DC $\pm$ 15%. 115 or 230 Volts AC $\pm$ 15%.											
Operating Modes:	A3A, A3J, A3H.											
Temperature Range:	-30°C to + 50°C.											
Weight:	22 pounds.											
Size:	5-3/8" high, 12" wide and 15-1/2" deep.											
Certification:	Type accepted by FCC under parts 81, 83, 89, and 91.											
DC Power Consumption:	<table border="0"> <tr> <td>12.9 Volt operation</td> <td>35 Volt operation</td> </tr> <tr> <td>Receiver (oven warmup)</td> <td>1.5 Ampere</td> <td>0.7 Ampere</td> </tr> <tr> <td>Receiver (after warmup)</td> <td>0.7 Ampere</td> <td>0.45 Ampere</td> </tr> <tr> <td>Transmitter (150 Watts PEP)</td> <td>25 Amperes</td> <td>10 Amperes</td> </tr> </table>	12.9 Volt operation	35 Volt operation	Receiver (oven warmup)	1.5 Ampere	0.7 Ampere	Receiver (after warmup)	0.7 Ampere	0.45 Ampere	Transmitter (150 Watts PEP)	25 Amperes	10 Amperes
12.9 Volt operation	35 Volt operation											
Receiver (oven warmup)	1.5 Ampere	0.7 Ampere										
Receiver (after warmup)	0.7 Ampere	0.45 Ampere										
Transmitter (150 Watts PEP)	25 Amperes	10 Amperes										
<b>RECEIVER</b>												
Sensitivity:	0.5 microvolts produces at least a 10 dB S + N/N ratio.											
AGC:	Fast attack (1 m sec); slow release (750 m sec).											
Clarifier:	Not less than $\pm$ 250 Hz.											
Selectivity:	A3A, A3J, 2.2 kHz at -6 dB, 5.5 kHz at -60 dB. A3H: 4.0 kHz at -6 dB, 10 kHz at -60 dB.											
Modes:	A3A, A3J—product detector. A3H—True AM detection with diode detector.											
Spurious Response:	Internally generated spurious responses are less than 0.1 uV equivalent level.											
Image Rejection:	Greater than 60 dB.											
IF Rejection:	Greater than 90 dB on 2 and 4 MHz band. Greater than 60 dB on 6 MHz band. Greater than 50 dB on 8 MHz band.											
Audio Output:	4 Watts with less than 10% THD.											
<b>TRANSMITTER</b>												
Power Output:	A3A, A3J—150 Watts PEP USB. A3H—150 Watts PEP, Carrier 3-6 dB down.											
Spurious Emission:	Exceeds FCC requirements under parts 81, 83, 89 and 91. Third order intermodulation better than -25 dB. Fifth order intermodulation better than -35 dB. Harmonics and others better than -65 dB.											
Frequency Stability:	$\pm$ 20 Hz maximum drift at -30°C to + 50°C.											
Antenna Coupler:	Built-in coupler that will match most marine antennas including 23 foot whips above 4 MHz, 35 foot whips, long wire antennas up to 75 feet long, and 50 Ohm antennas.											
Microphone:	Ruggedized hand-held carbon, high impact case.											



## CHAPTER II INSTALLATION

### 2-1. UNPACKING.

Carefully remove the unit from the shipping carton and examine it for evidence of damage. If any damage is discovered, immediately notify the transportation company that delivered the unit. Be sure to keep the shipping carton and packing material as the transportation company will want to examine them if there is a damage claim. Keep the carton and packing material even if no shipping damage occurs. Having the original carton available makes packing the unit much easier to store it or return it to the factory for service.

#### NOTE

Fill out the enclosed registration card and return it to the factory immediately to insure registration and validation of the warranty.

### 2-2. LOCATION.

In general the location of the TR-M is not critical. However, care should be taken to insure that space is provided around the unit to allow adequate air circulation. Extremely hot locations should be avoided. Do not cover the top of the unit with books, papers or pieces of equipment or over heating may result.

### 2-3. VIEWING/MOUNTING OPTIONS.

Figure 2-1 illustrates some of the mounting and viewing angle options possible with the TR-M. Each unit is furnished with a mounting bracket and thumb screws to provide a variety of mounting and viewing arrangements.

### 2-4. POWER RATING.

As shipped from the factory, the TR-M is configured for 12.9 or 35 Volt DC operation or 115 Volt or 230 Volt AC operation. If the power supply is changed to convert a unit from one voltage to another, the following components must be changed:

- Bottom plate with power supply (labeled with the proper voltage rating).
- Two crystal ovens (for transmitter and carrier oscillator). Each oven is labeled with its voltage rating. Use the 12 Volt ovens with the AC power supplies.
- Two power amplifier tubes. 6LQ6 for 12 Volt DC and AC operation and 31LQ6 for 35 Volt DC operation.

### 2-5. CRYSTAL INSTALLATION AND PROGRAMMING.

Any of the eleven channels of the TR-M may be used in any of the four bands. However, the TR-M is preprogrammed at the factory for 2 MHz operation on Channels 1 through 7, 4 MHz operation on Channels 8 through 10, and 6 MHz operation on Channel 11. For 8 MHz operation see paragraph 2-6. The trimmers in the Antenna Coupler are those required to tune antennas commonly encountered on these bands. If it is desired to use a preprogrammed channel on a different band, the programming is easily changed, but a different set of trimmers for that channel may be required in the Antenna Coupler. See paragraph 2-12.

### 2-6. PROGRAMMING.

- Remove the six screws, three on each side, securing the top cover, and remove the cover.
- Remove the eleven screws securing the bottom cover. Five are located on the cover bottom, and three on each side of the cover. Carefully lift the main chassis off the bottom cover.
- Locate the programming matrix PC board on the bottom of the chassis. Refer to figure 2-2.

The band programming matrix consists of four columns labeled 2, 4, 6 and 8, and eleven rows labeled 1 through 11. The rows labeled 1 through 7 on the TR-M will have a screw in the 2 MHz column, rows 8 through 10 will have a screw in the column labeled 4.



The row labeled 11, corresponding to Channel 11 has a screw in the column labeled 6. This is the channel set aside for 6 MHz or 8 MHz operation. If it is to be used on 8 MHz, remove the screw from the 6 MHz position and insert the programming screw in row 11 in the column corresponding to band 8. The 11 row, 2 column matrix next to the band programming matrix is the Mode Programming matrix. For a particular channel, inserting a programming screw in the A3A column (towards rear of TR-M) provides A3A operation on that channel. Inserting a programming screw in the column labeled A3J programs A3J operation.

The absence of a programming screw in either column will automatically provide A3H operation. Under no circumstances should screws be placed simultaneously in the A3J and A3A columns for the same channel. The unit is factory programmed on all channels for A3J operation except Channel 1 (2182 kHz). After the programming is completed for the channels to be used, make sure the TUNE slide switch is positioned toward the rear of the chassis and carefully put the chassis back on the bottom cover. Secure the bottom cover with eleven screws previously removed. If the sideholes in the cover do not line up, the power connector (bottom cover and chassis) is not mated properly.

## 2-7. TEST EQUIPMENT.

The following list of test equipment represents the minimum required to align the TR-M Radio telephone at installation.

- Frequency Counter: 2 to 20 MHz; 0.00001% accuracy.
- VOM: At least 10,000 Ohms/V sensitivity. Not affected by RF fields.
- Wattmeter: 5% accuracy at 4 Watts, 50 Watts, 150 Watts; 2-9 MHz.
- Dummy Load: 50 to 52 Ohm; 200 Watts.
- Alignment Tool: Insulated.

## 2-8. RECEIVE CRYSTAL INSTALLATION.

Refer to figure 2-3. Remove the two screws securing the plate covering the Receiver Oscillator board (A7). Install the proper receive crystal in the socket corresponding to the channel to be used. The re-

ceive crystals are stamped with "REC" and the crystal frequency. The crystal frequency required for a given carrier frequency is:  $f(\text{xtal}) = 10.7 \text{ MHz} + f(\text{car}) \text{ (MHz)}$ . Replace the cover over the Receiver Oscillator board.

### NOTE

Be sure to adjust trimmers with cover plate on, and use an insulated alignment tool. Allow a five minute warm-up period before frequency adjustments are made.

Set CLARIFIER to 12 o'clock position. Refer to figure 2-4. Locate terminal No. 13 on the RF/IF board (A6). This is in the left rear portion of the board, and is the center conductor of a coax supplying receiver injection to the Receive Mixer. Make sure the Band and Channel Switches are in proper position for the crystal to be trimmed on frequency. Connect a frequency counter through a 470 Ohm resistor between terminal No. 13 and ground and trim the Receive Injection frequency to the required frequency (stamped on crystal case) using the trimmer corresponding to the channel in use.

## 2-9. TRANSMIT CRYSTAL INSTALLATION.

- Refer to figure 2-4. Remove the screw securing the strap around the transmit crystal oven, and carefully remove the oven from its socket. Care should be taken when removing the oven, as the oven fits very tightly. If necessary use a screwdriver blade between the bottom of the oven and the oven socket to aid in removing the oven to avoid flexing the oscillator PC board.
- Remove the three screws securing the oven cover. Remove the cover and the insulating cover to expose the crystal sockets.
- Install proper crystals in appropriate sockets corresponding to the numbers of the channels to be used. See table in figure 2-5. The transmit crystals are marked with "XMIT" and the crystal frequency. Crystal frequency is 10.7 MHz above the desired carrier frequency.
- Replace insulating cover and outer cover. Replace oven cover screws and replace oven in its socket. Secure the oven with the strap and screw removed in step a. above.

### NOTE

Allow a twenty minute warmup period for oven stabilization.

- Connect the 50 Ohm dummy load to the 50 Ohm output connector. Connect a frequency counter through a 470 Ohm resistor to the antenna connector. Place the TUNE switch in the tune position. Refer to figure 2-5 which illustrates the associated trimmers on the Transmit Oscillator board (A1). Depress PTT switch and adjust oscillator frequency for required operating carrier frequency as measured on the counter using trimmer corresponding to channel in use. A short insulated alignment tool is required for this adjustment.
- Place TUNE-NORMAL slide switch in the NORMAL position. Allow required warmup time for crystal ovens. Set CHANNEL switch to a channel with no crystal, or to an A3J programmed channel. Connect VTVM or VOM to bias test points on bottom of unit. Key transmitter PTT switch and adjust bias potentiometer for .75 Volts on the VTVM or VOM. Using the 50 Ohm output (see paragraph 2-11) connect TR-M to a 50 Ohm dummy load and wattmeter. For each channel which is programmed for A3H, key the Push-To-Talk switch and adjust Carrier Level

potentiometer for that channel, through the corresponding hole in the bottom cover, for a carrier power level of 55 Watts. For each channel which is programmed for A3A, adjust the appropriate potentiometers for a carrier power level of 4 Watts. No adjustment is required for channels programmed for A3J.

- If the Antenna Coupler is to be used, refer to paragraph 2-12. If 50 Ohm output is to be used, replace top cover. The TR-M is now ready for operation.

## 2-10. ANTENNA REQUIREMENTS—GENERAL.

The TR-M has a 50 Ohm output available for use with 50 Ohm resonant antennas. These antennas usually limit operation to one channel per band. The TR-M also has an Antenna Coupler built in to match non-resonant antennas. When the Antenna Coupler is used, two outputs are available. The antenna terminal labeled MF is for 2 MHz antennas, the antenna terminal labeled HF is for antennas to be used on the 4, 6 and 8 MHz bands.

If an antenna is to be used on all four bands, and use of the Antenna Coupler is required, the HF and MF antenna terminals can be strapped together to accommodate a single feedline.



The use of a good ground cannot be stressed too heavily. The use of an effective counterpoise ground is highly recommended. The length of the ground connection to the TR-M is equally important and should be kept as short as possible. The length of the ground connection effectively adds to the length of the antenna. A long ground connection or a high resistance ground connection will make the antenna charts useless.

### 2-11. 50 OHM OUTPUT.

The 50 Ohm output of the TR-M is accessible by way of an SO-239 receptacle. The TR-M is shipped with the 50 Ohm output connected to the SO-239 and the Antenna Coupler disconnected. This 50 Ohm output is needed for adjustment when setting up the TR-M on the desired channels. When channelization is completed, the TR-M is ready for operation if the 50 Ohm output is to be used exclusively. Figure 2-7 illustrates the proper connections required for 50 Ohm output.

### 2-12. ANTENNA COUPLER.

If the Antenna Coupler is to be used, the following steps should be followed.

- a. Connect a 50 Ohm dummy load to the SO-239 connector. Connect a VOM to the test points on the rear panel and set it on the microammeter scale. With the TR-M keyed on an A3J channel and no modulation, observe the reading on the meter and record it for future reference. This residual reading is the null reference by which the Antenna Coupler will be tuned. Be sure the TUNE/NORMAL Switch on the bottom of the TR-M is in the NORMAL position.
- b. After the desired crystals have been installed and necessary adjustments made, refer to figure 2-7. Locate the short lead from the SO-239 receptacle to the Power Detector PC board. The end of this lead going to the Power Detector board should be disconnected. No soldering iron is needed as this lead plugs into the terminal on the board.

- c. Unplug the Antenna Coupler input lead from the Power Detector PC board, and connect it to the terminal where the 50 Ohm lead to the SO-239 was removed (center of toroid).
- d. Finally, connect the end of the short lead from the SO-239 to the terminal where the Antenna Coupler input lead was originally connected.

The Antenna Coupler is now ready for operation. The Antenna Coupler in the TR-M is basically a T configuration as shown on the Antenna charts. For antennas which are somewhat longer than a quarter wavelength a point is reached where the resistive component of the antenna impedance becomes greater than 50 Ohms. This can occur on the HF bands; therefore, provisions are provided on the 4, 6 and 8 MHz bands to install a fixed capacitor (see table 2-3) from the HF antenna terminal to ground. The Antenna Coupler then becomes a Pi-L network and is capable of matching a wide range of antenna impedances. Refer to figure 2-8 to locate the point where the fixed capacitor is to be added if needed. This capacitor should be connected from the switch wafer indicated to RF ground lug.

### 2-13. 6 or 8 MHz OPERATION.

Channel 11, as previously stated, is set aside for either 6 or 8 MHz operation. Figure 2-9 and figure 2-10 show Antenna Coupler trimmers and coil tap positions needed to match a 23 foot and 35 foot whip respectively. These charts are based on antenna manufacturer's data, and should provide values relatively close to those needed if a good, low resistance ground is used. The ground lead should be of minimum length as previously stated.

Select the chart corresponding to the antenna to be used. Locate the operating frequency on the horizontal scale. Using a straight edge drop vertically from the selected frequency to the curve. At this intersection read coil tap in "turns from end" on vertical scale. Refer to figure 2-4 to determine starting point for coil turn count. Taps are attached with screw clamps provided. Count the number of turns, determined from the chart, from the end of

the coil. At this point on coil attach tap marked with an 11 corresponding to Channel 11.

Directly below each curve on the antenna chart for a given band is a list of trimmers and fixed capacity required, if any.

The back panel of the TR-M, figure 2-11, is labeled showing the two trimmers used for each channel. Trimmer A corresponds to the series capacitor  $C_A$  referred to on the antenna charts. Trimmer B corresponds to  $C_B$  on the charts, and  $C_C$  is the fixed shunt capacitor added if required.

Table 2-1 shows the capacitors supplied with the TR-M on the various channels. For example, if a 23 foot whip is to be used, and it is desired to use Channel 11 for a 6 MHz channel, figure 2-9 shows  $C_A$  required as a No. 305 trimmer and  $C_B$  required as a No. 302 trimmer + 100 pf additional capacity in parallel with it. Referring to table 2-1, it is seen that Channel 11 is equipped with the required capacity and no changes are needed. If the same 23 foot whip is used and 8 MHz operation is desired on Channel 11, the chart, figure 2-9, shows the same capacity required for 6 MHz operation except that the 100 pf fixed capacitor is not used. By locating trimmer B for Channel 11, and removing the 100 pf capacitor that is connected in parallel with it, the Antenna Coupler will be capable of matching the 23 foot whip on 8 MHz.

Due to variations in conditions and installations, the capacities indicated on the charts may have to be modified slightly. Usually this will occur at the band edges. Table 2-2 shows the capacity ranges of the various trimmers used in the Antenna Coupler. Refer to this table if conditions indicate that different capacity values are needed. Generally it is easier to add additional parallel capacity than to change trimmers if more capacity is required. If less capacity is needed, a lower range trimmer can be installed. Capacitors added in parallel with the trimmers should have a minimum 350 Volt rating.

Remove the small bottom plate and switch the TUNE/NORMAL switch to TUNE. Key the transmitter and alternately adjust the two trimmers on the back panel corresponding to Channel 11 until the reading on the VOM is

equal to or very near the reference observed in paragraph 2-12. a. (observed when keying the TR-M on an A3J channel with no modulation and the TUNE/NORMAL switch in NORMAL). This indication is proportional to reflected power. If a null close to the reference level cannot be obtained, adjust coil tap a turn at a time until null can be reached. An insulated screwdriver should be used to tune the trimmers.

### 2-14. 2 OR 4 MHz OPERATION.

Figures 2-9 and 2-10 also show approximate coil tap positions and required capacities for matching a 23 foot and 35 foot whip on the 4 MHz band. Use channels 8, 9, and 10 for this band.

Figure 2-12 shows a range of coil tap positions for a given frequency which should allow matching of a correctly installed 75 foot longwire. Note that the 300 pf capacitor in parallel with  $C_B$  on channels 1 through 7 should be removed when using a 75 foot longwire antenna. The 300 pf will normally be needed to match a 35 foot whip on the 2 MHz bands.

### 2-15. ANTENNA COUPLER TUNING HINTS.

The antenna charts, figures 2-9, 2-10 and 2-12 are intended as a guide only. Variations in conditions and installations will cause considerable variations in  $C_B$ .

For matching other types of antennas such as load-whips, trial and error must be used until correct settings are obtained.

The range of  $C_A$  (No. 305) should be sufficient for all types of antennas. It transforms the 50 Ohm Power Amplifier output impedance to a level of approximately 150 Ohms. This makes coil tap setting less critical. It may prove helpful to preset the  $C_A$  trimmer before tuning. Turn the trimmer adjusting screw counterclockwise until snug. Turn clockwise 1/2 turn for a 2 or 4 MHz channel, preset 1 turn from snug position for channels in the 6 MHz band, and preset 1-1/2 turns from snug end for 8 MHz channels.

If the  $C_A$  trimmer is preset, and tuning the  $C_B$  capacitor gives no change in the tuning indicator, this usually means more coil is needed. Increase





coil one turn at a time (decrease turns from end as referred to on antenna charts) until null can be reached.

Matching loaded whips such as a 23 foot loaded whip will probably require modification of the  $C_B$  capacitor, particularly towards the edges of the 2 MHz band (see paragraph 2-12).

**2-16. USING THE ANTENNA COUPLER ON 50 OHM ANTENNAS.**

As previously mentioned, if the Antenna Coupler is used it must be used exclusively. Refer to table 2-3 for selection of the fixed shunt capacitor to be used if a 50 Ohm antenna is to be used on either the 4, 6, or 8 MHz bands. If an HF antenna is to be used which is resonant on one or more HF bands, the antenna can be fed with 50 Ohm coax by connecting the SO-239 lead to the pin on the HF antenna post. The Antenna Coupler input lead is connected to the 50 Ohm output on the Power Detector board as previously described. Since the Antenna Coupler is being used, a better match can be obtained, and the antenna can be made to operate over a wider range in each HF band.

**2-17. EXTERNAL CONNECTIONS.**

A terminal strip TB1 is provided on the bottom of the unit for remote connection of a speaker and microphone.

Connections are available for the speaker and the audio and PTT leads of the microphone. If a remote microphone is used, shielded cable should be used for the audio connection to the microphone element. A carbon microphone must be used.

The 4 - 8 Ohm speaker connection should be made between the SPKR terminal and the adjacent GND terminal. The carbon microphone element should be connected to the MIC terminal with its shield connected to the adjacent GND terminal. The push-to-talk switch lead should be connected to the PTT terminal. The switch should provide a connection between the PTT and GND terminals when depressed.

Table 2-1. Capacitors Supplied

CHANNEL NO.	$C_A$ (SERIES)	$C_B$ (SHUNT)
1	305 + 500 DM20	307 + 300 DM20
2	305 + 500 DM20	307 + 300 DM20
3	305 + 500 DM20	307 + 300 DM20
4	305 + 500 DM20	307 + 300 DM20
5	305 + 500 DM20	307 + 300 DM20
6	305 + 500 DM20	307 + 300 DM20
7	305 + 500 DM20	307 + 300 DM20
8	305	304 + 200 DM20
9	305	304 + 200 DM20
10	305	304 + 200 DM20
11	305	302 + 100 DM20

Table 2-2. Antenna Trimmers Supplied

TRIMMER NO.	CAPACITY IN PICO FARADS
302	15 to 120
304	100 to 500
305	180 to 690
307	340 to 1070

Table 2-3. Components to Convert to Pi-L

BAND	$C_A$	$C_B$	$C_C^*$	APPROX. TURNS FROM END
4 MHz	305 Trimmer	304 Trimmer	700 pf	34
6 MHz	305 Trimmer	302 + 100 pf	500 pf	36
8 MHz	305 Trimmer	302	375 pf	37

\*1000 Volt rating minimum

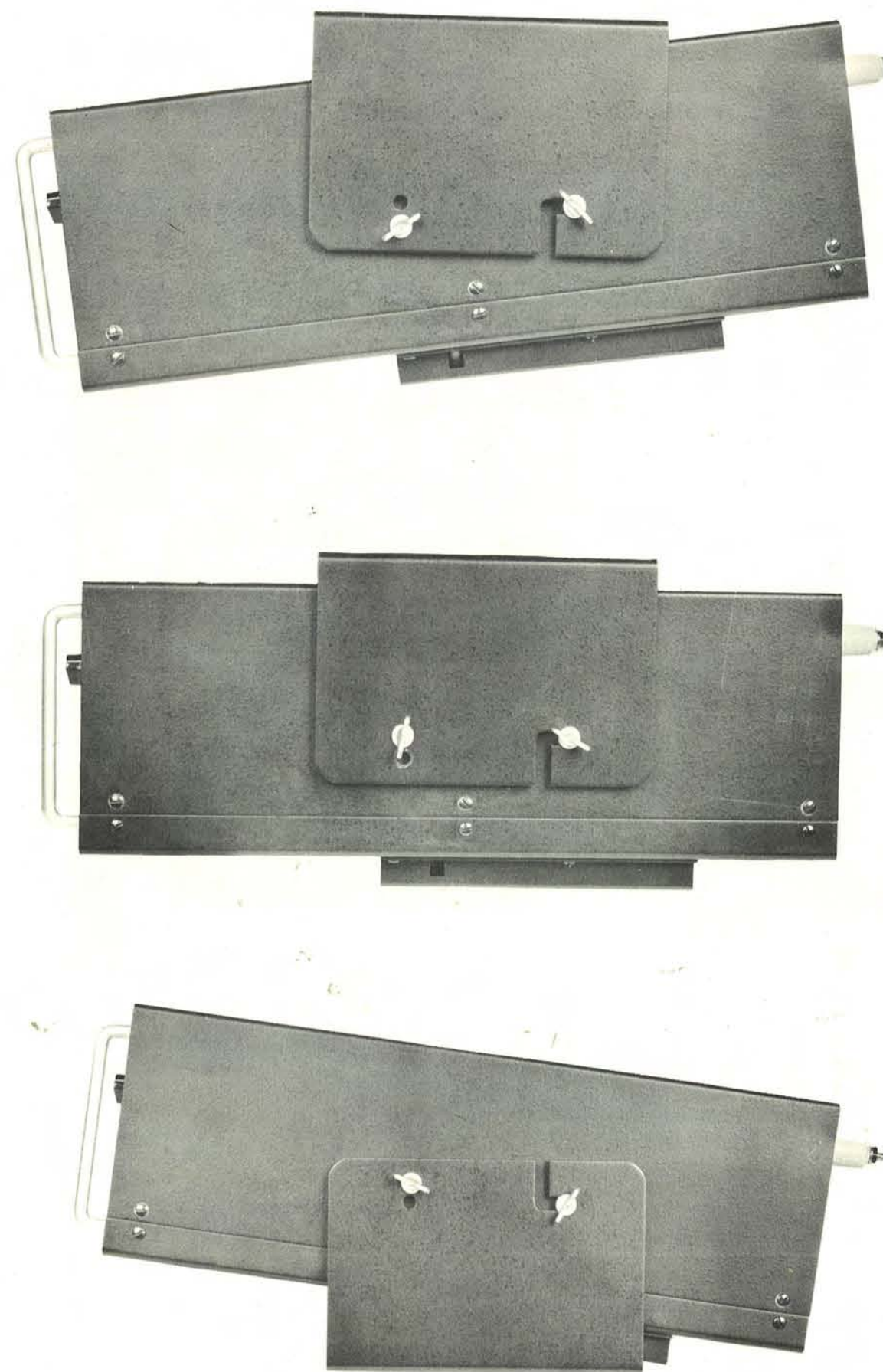
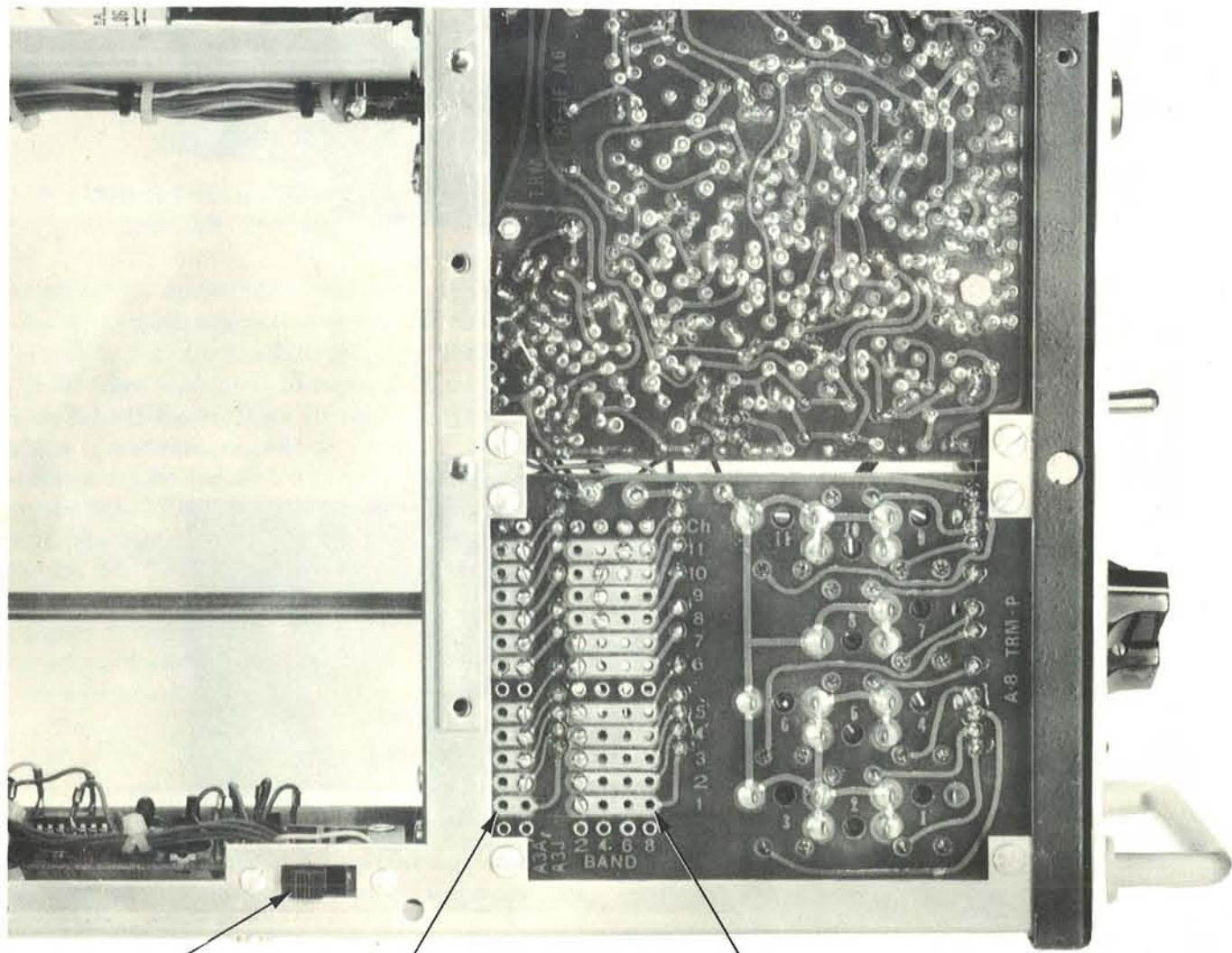

Figure 2-1. Viewing/Mounting Options





TUNE SWITCH S3  
 MODE PROGRAMMING MATRIX  
 BAND PROGRAMMING MATRIX

Figure 2-2. Program Board (A8)

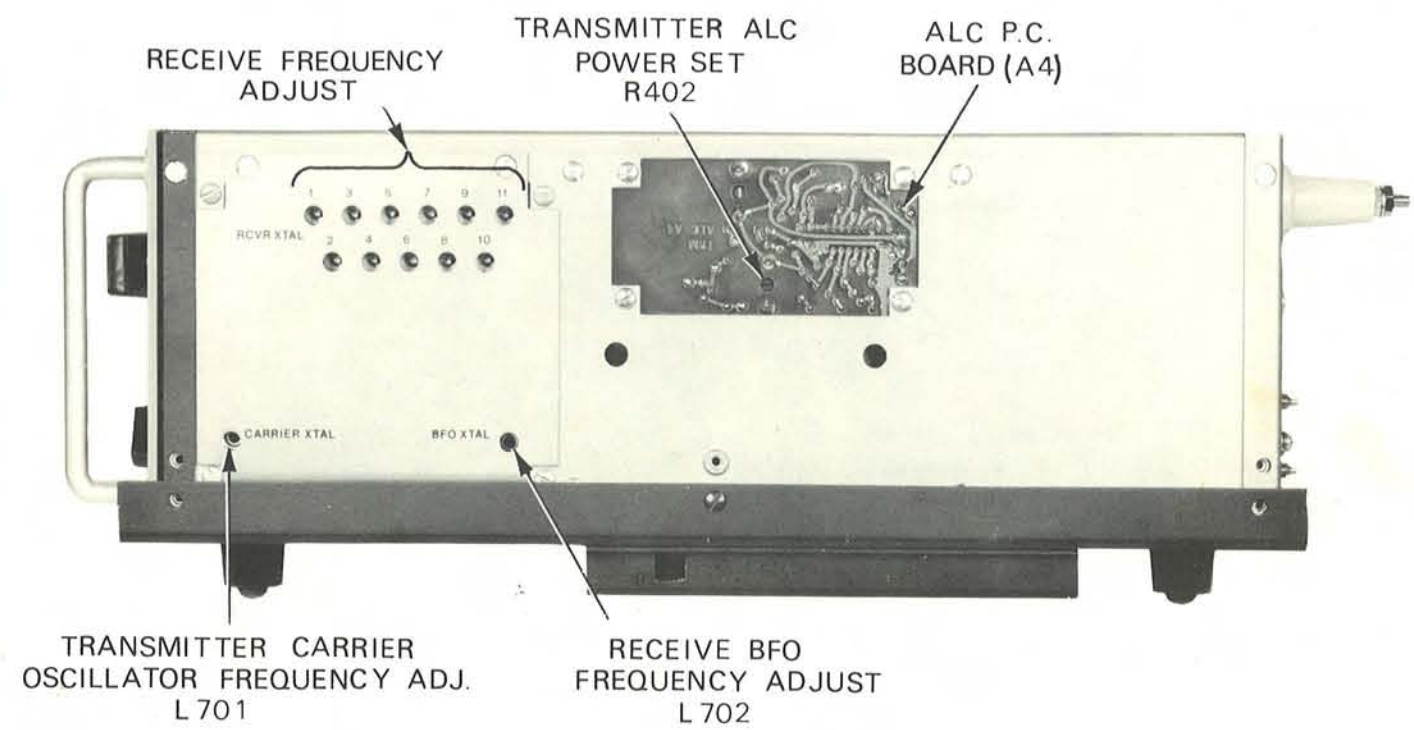

RECEIVE FREQUENCY ADJUST  
 TRANSMITTER ALC POWER SET R402  
 ALC P.C. BOARD (A4)  
 TRANSMITTER CARRIER OSCILLATOR FREQUENCY ADJ. L 701  
 RECEIVE BFO FREQUENCY ADJUST L 702

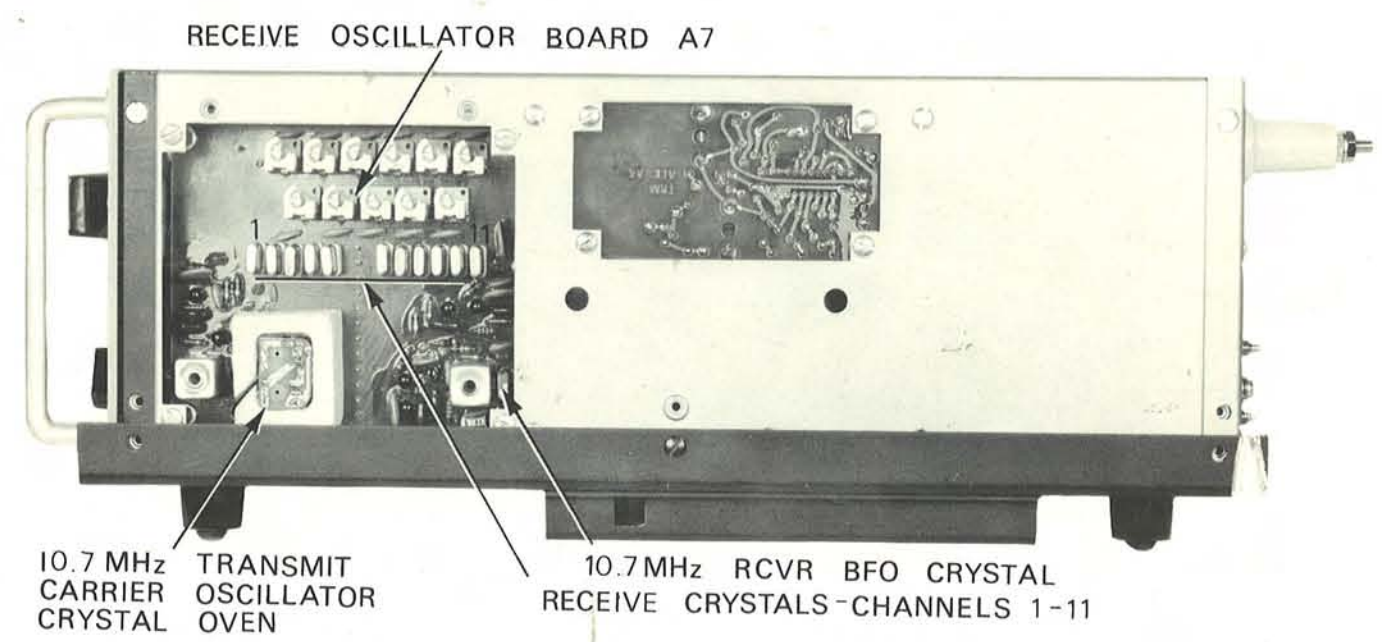

RECEIVE OSCILLATOR BOARD A7  
 10.7 MHz TRANSMIT CARRIER OSCILLATOR CRYSTAL OVEN  
 10.7MHz RCVR BFO CRYSTAL RECEIVE CRYSTALS-CHANNELS 1-11

Figure 2-3. Receive Crystal Installation and Alignment



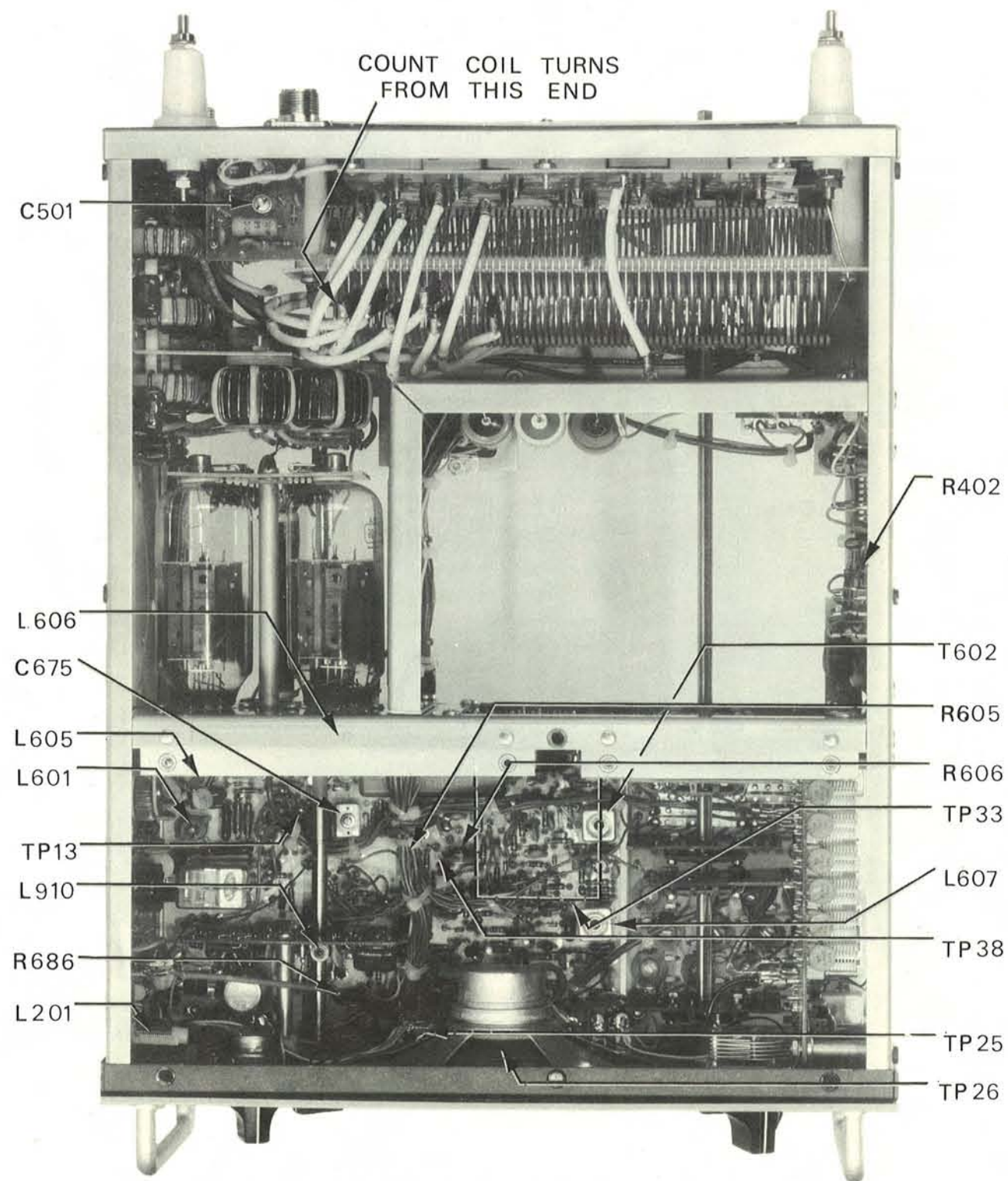
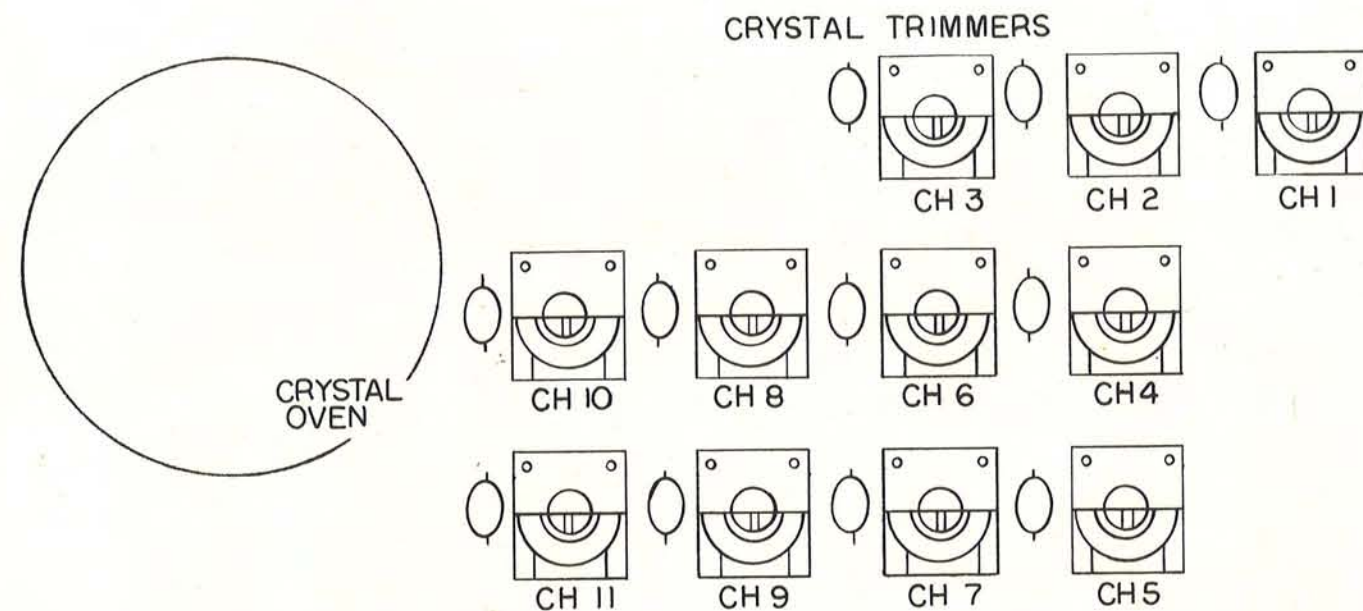

Figure 2-4. Alignment Locations and Test Points—Top View



SOCKET NO.	11	10	9	8	7	6	5	4	3	2	1
CHANNEL NO.	1	2	3	4	5	6	7	8	9	10	11

Figure 2-5. Transmit Crystal Trimmers



3 SCREWS EACH SIDE

11 BOTTOM COVER SCREWS

5 SCREWS

POWER SUPPLY 4 SCREWS

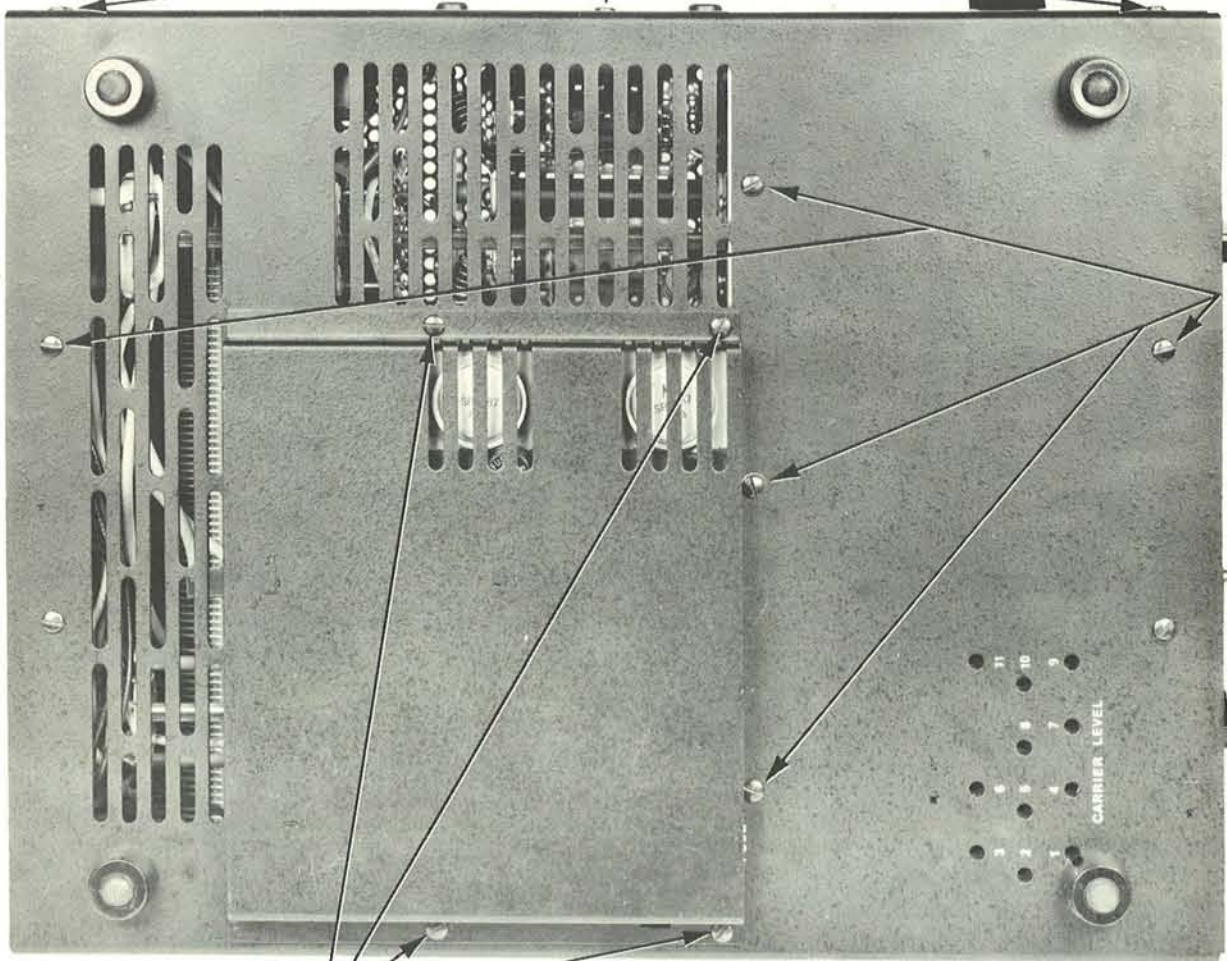

Figure 2-6. Bottom Cover Screw Identification

50Ω LINE

ANTENNA COUPLER INPUT LEAD

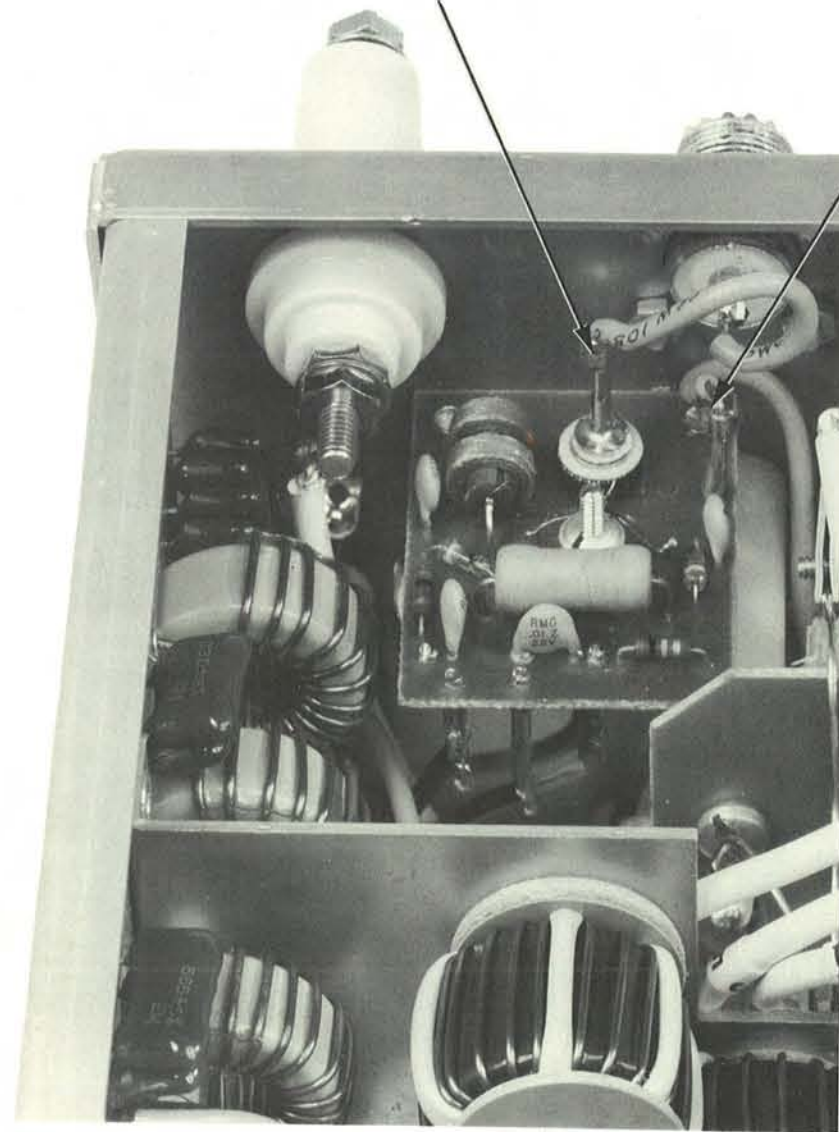

Figure 2-7. Connections for 50 Ohm Output



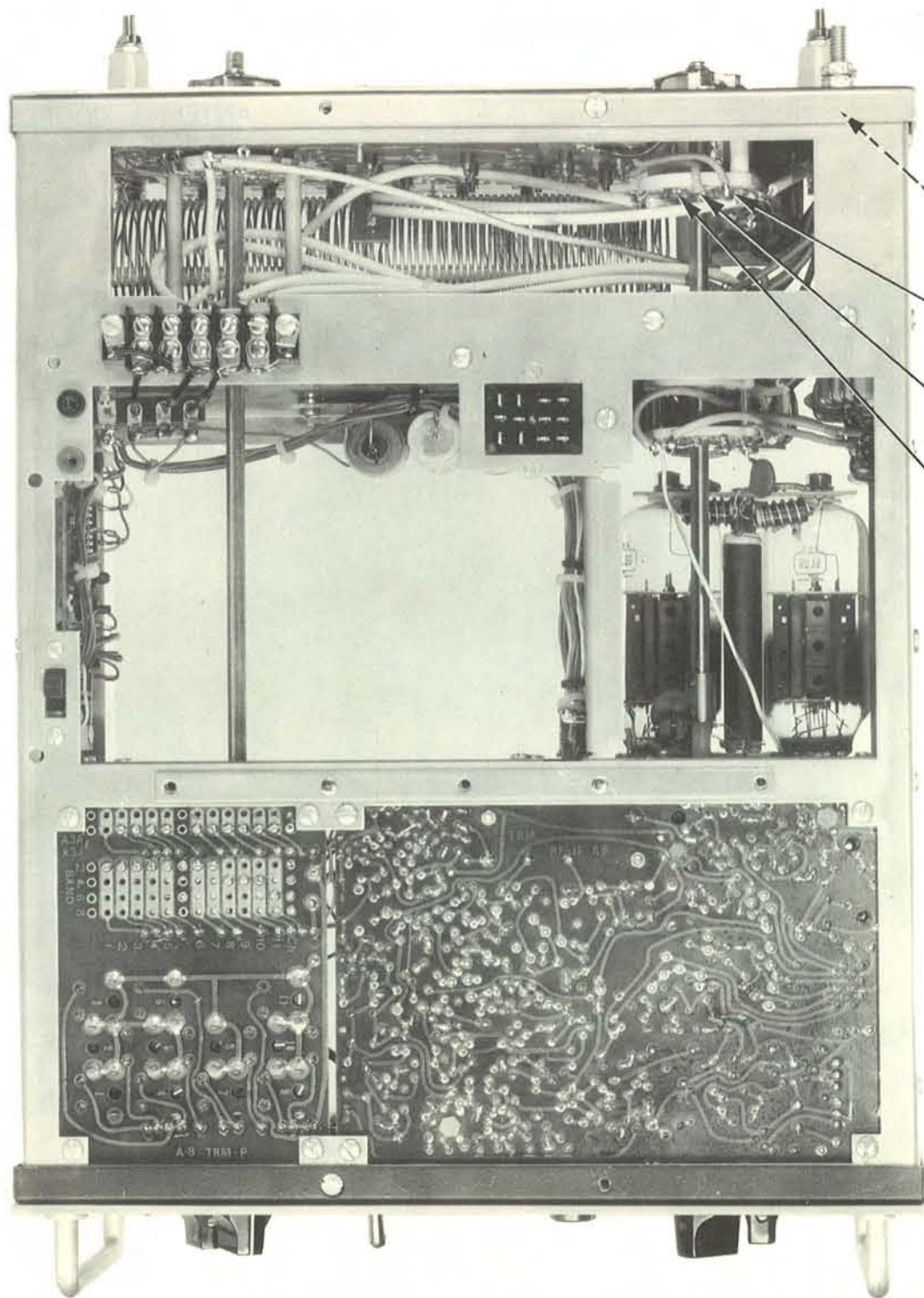

Figure 2-8. Bottom View with Cover Removed

RF GROUND LUG  
 8 MHz FXD CAP CONN POINT  
 6 MHz FXD CAP CONN POINT  
 4 MHz FXD CAP CONN POINT

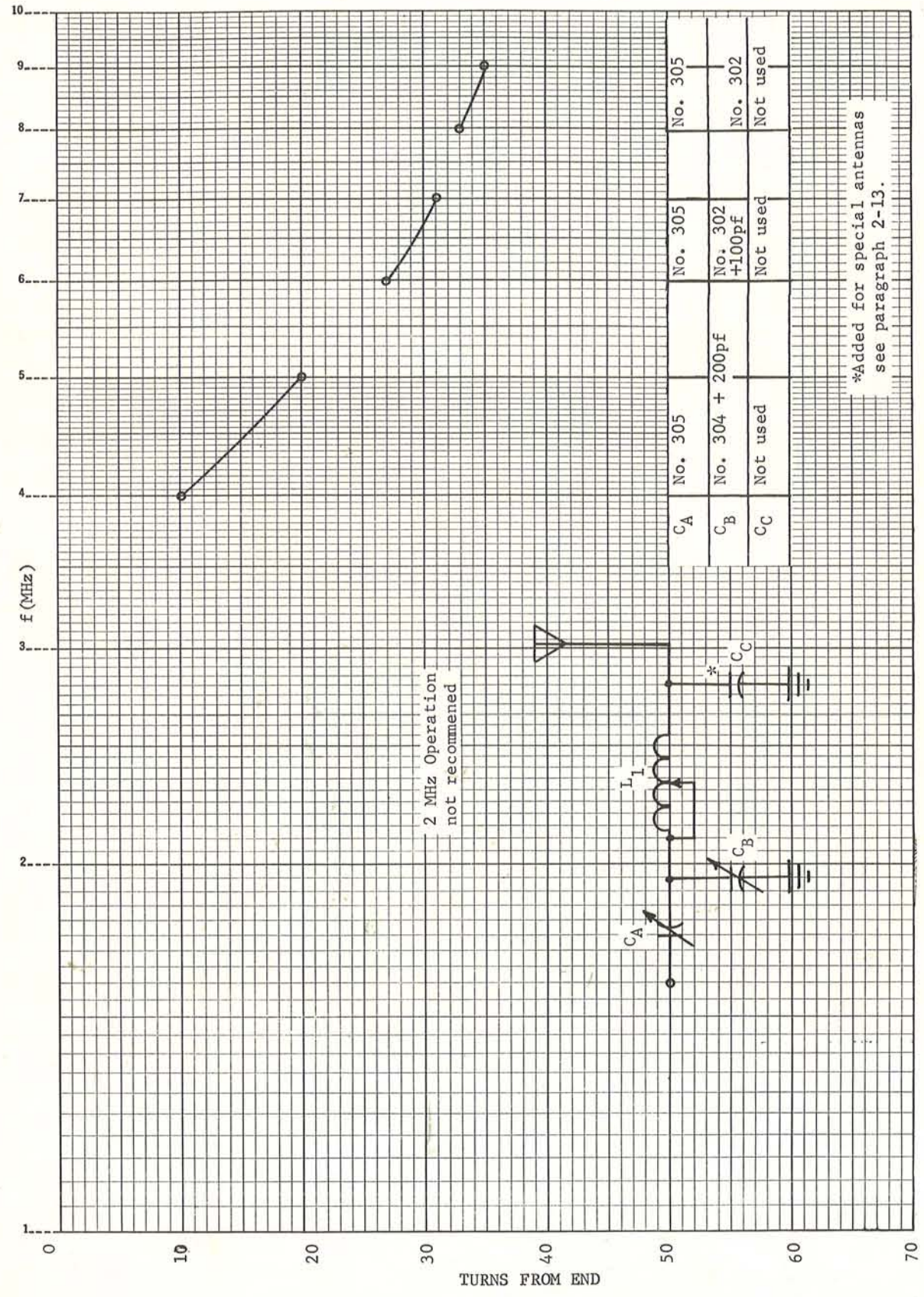

Figure 2-9. Trimmers and Coil Taps for 23 Foot Whip Antenna



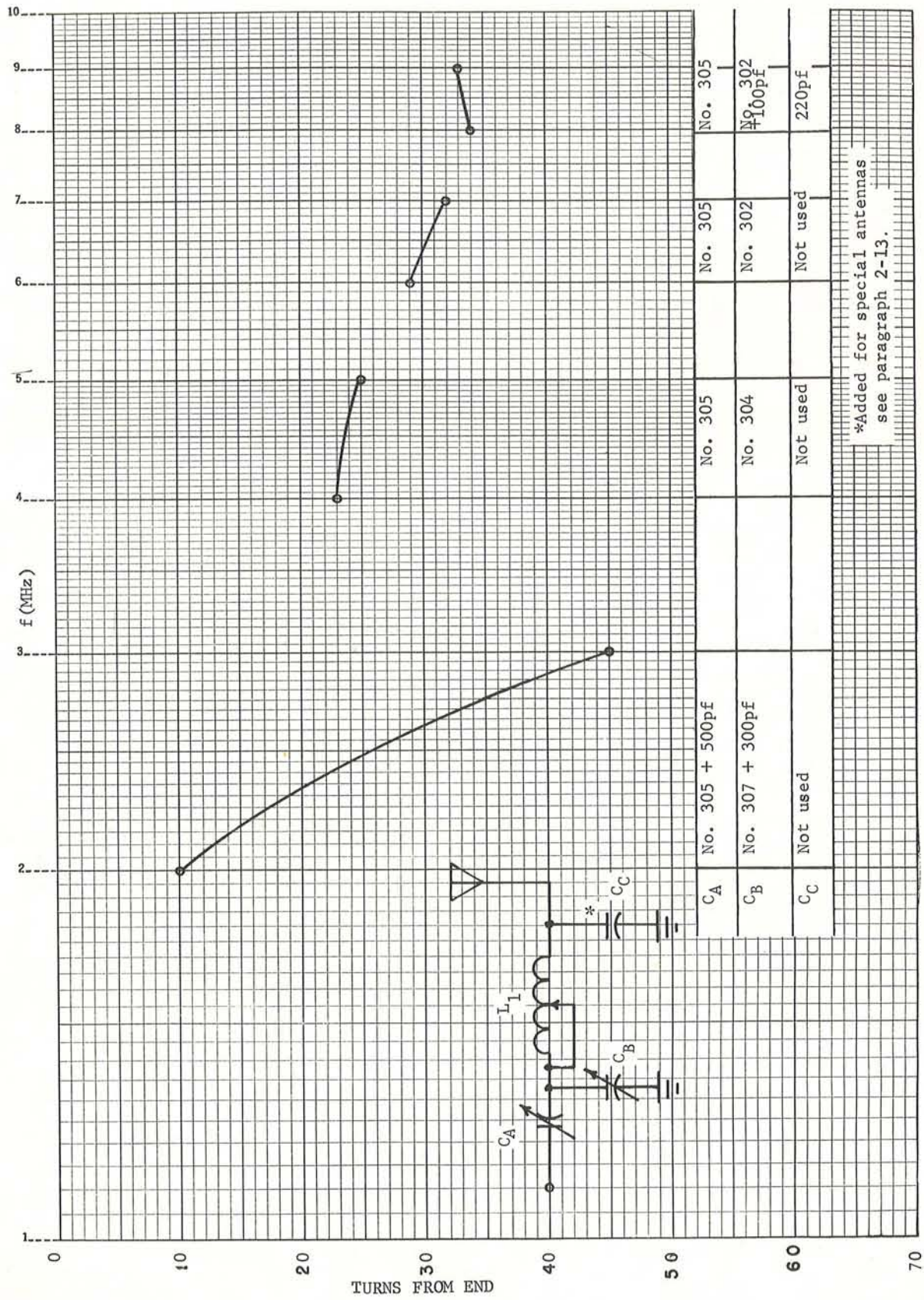

Figure 2-10. Trimmers and Coil Taps for 35 Foot Whip Antenna

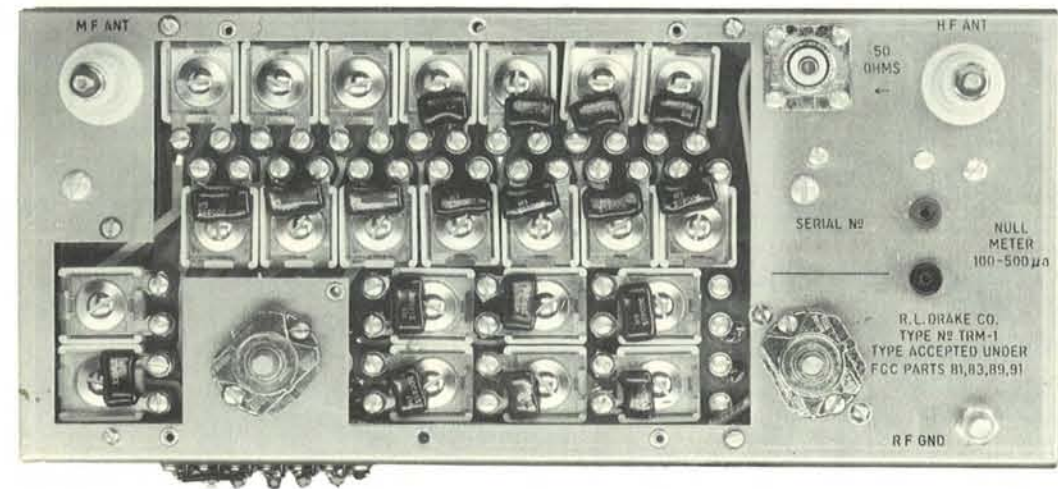
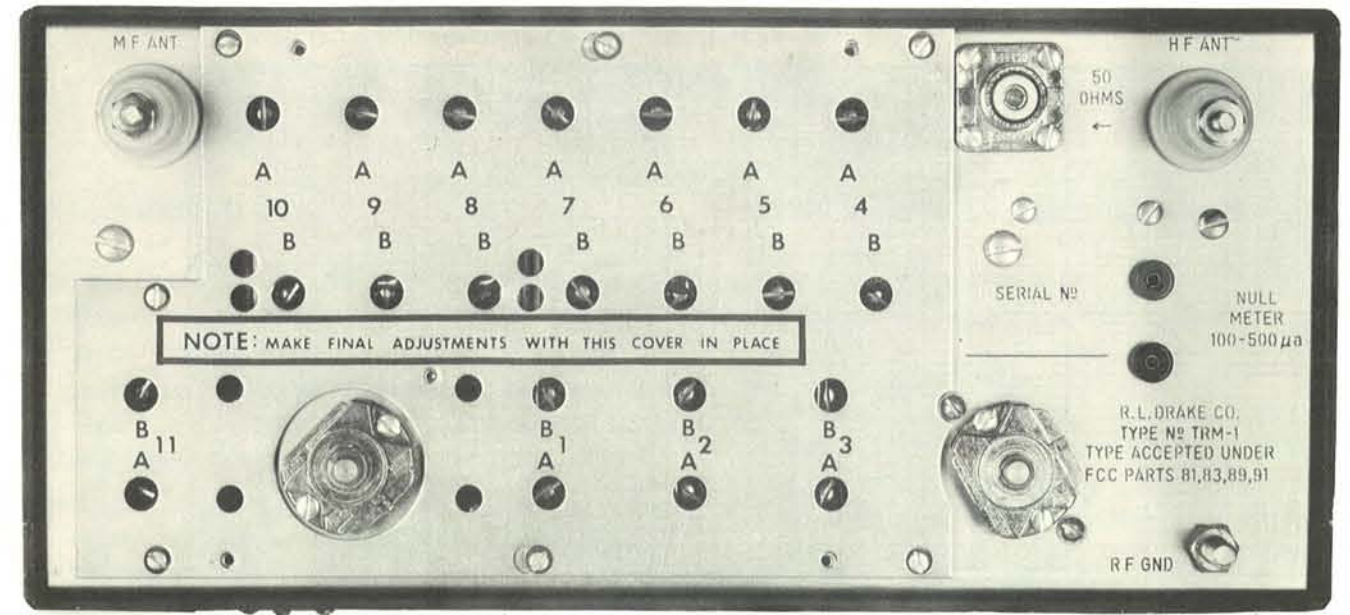

Figure 2-11. Rear Panel Arrangement



## CHAPTER III OPERATION

### 3-1. GENERAL.

Before the TR-M is ready for operation, the following must be completed:

- After installing the proper crystals, a licensed technician must test and install the unit. The station log book must show that this installation and adjustment has been accomplished.
- The operator of the TR-M must hold the appropriate FCC operator permit—see applicable FCC regulations.

### 3-2. RECEIVE ONLY/REDUCED POWER CONSUMPTION.

- Set XMTR toggle switch to OFF.
- Turn VOLUME control clockwise past the switch detent to turn on power. The POWER ON indicator will light.
- Set CHANNEL selector to desired channel.
- Set BAND MHz control to the band in which the desired channel is programmed. The SET BAND indicator will light if band switch does not agree with programmed channel.
- Advance VOLUME control to desired listening level.
- If necessary, fine-tune the station with the CLARIFIER control until voices sound natural.

With these control settings the receiver is operational but the transmitter is turned off, resulting in reduced power consumption. However, the transmitter crystal oven remains on, to provide quick recovery (no warmup) when the transmitter is re-energized.

### 3-3. RECEIVE/TRANSMITTER READY.

- Set XMTR toggle switch ON.

- Follow steps b. through f. in paragraph 3-2 above.

With the XMTR switch ON, power is supplied to the transmitter power amplifier filaments.

### 3-4. TRANSMITTING.

Follow instructions in paragraph 3-3 above noting:

- If the XMTR switch has just been turned on, allow 2 minutes minimum for filament warmup before transmitting.
- If the VOLUME switch has just been turned on, a crystal oven warmup waiting period must be observed before operating the transmitter. Operation of the transmitter too soon after supplying power to the ovens will result in *OFF-FREQUENCY* operation and result in possible citations from the FCC. The time required for oven warmup is:
  - 10 minutes minimum when ambient temperature is 25°C (room temperature) or above.
  - 20 minutes at colder temperatures down to -30°C.

To avoid the filament warmup waiting periods, always place XMTR switch in the ON position several minutes before anticipated transmissions. If power drain is not a consideration, leave the XMTR switch in the ON position at all times. Be sure to turn the main power switch ON in time to allow oven warmup as specified above.

- To transmit, push the push-to-talk (PTT) button on the side of the microphone. Speak in a normal voice with the microphone approximately 2 to 3 inches away. After completing a transmission, release the PTT button to reactivate the receiver.

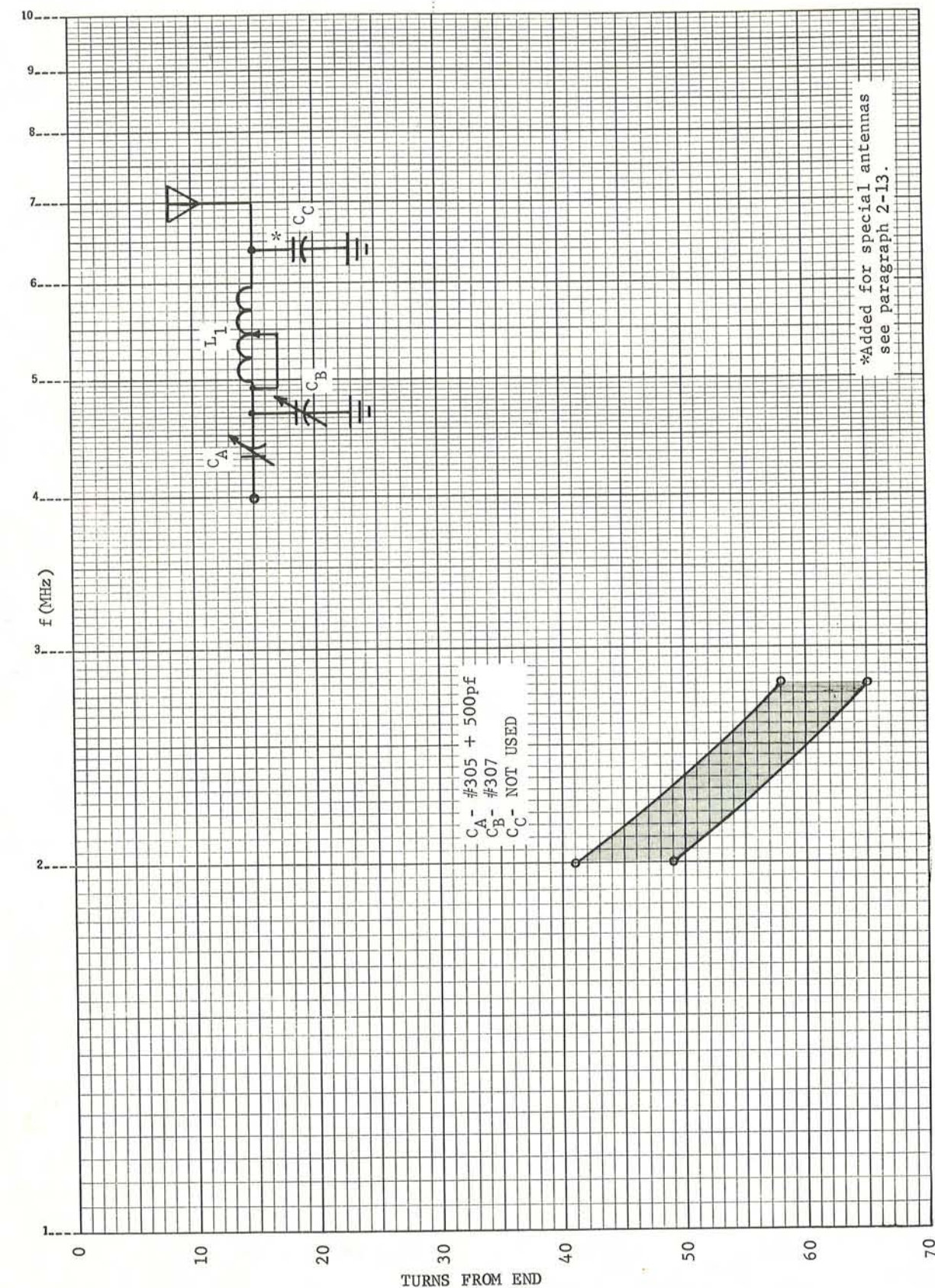

Figure 2-12. Trimmers and Coil Taps for 75 Foot Long-Wire Antennas





### FRONT PANEL CONTROLS

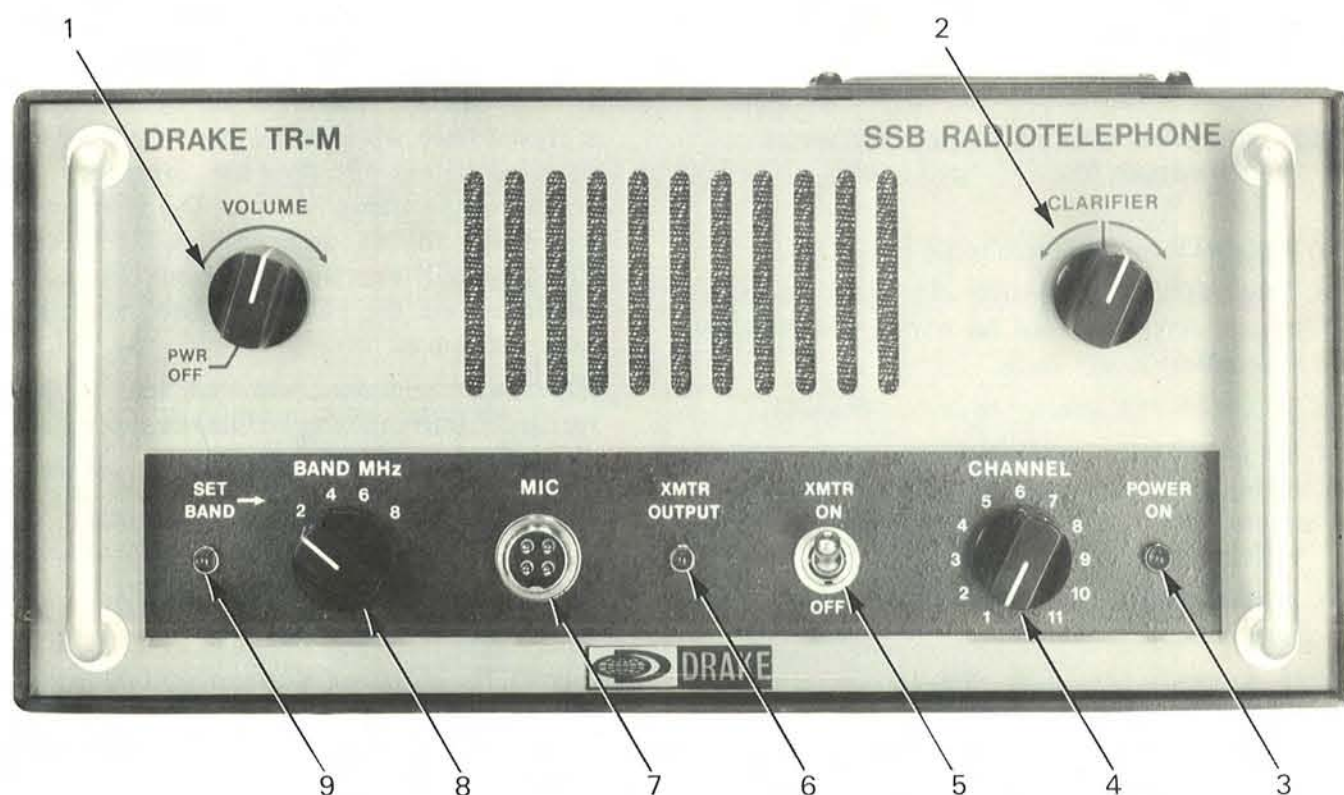

Figure 3-1. Front Panel Controls

1. **VOLUME Control:** Turns power on and adjusts receiver volume. This knob controls power to all circuitry in the unit and must be turned on to supply power to the transmitter crystal oven.
2. **CLARIFIER:** This control varies only the receive frequency by approximately  $\pm 250$  Hz. Normal operation should occur at the 12 o'clock position, however the control can be varied to fine-tune stations exactly to the proper frequency. Tune this control until voices sound natural.
3. **POWER ON Indicator (CR1):** This light emitting diode glows when the power is turned on. When this indicator is illuminated, power is being supplied to the receiver and to the crystal ovens.
4. **CHANNEL Selector:** This control selects the desired operating channel. Note that after selecting the desired operating channel, the SET BAND indicator will light if the BAND switch is not set to the proper band for the channel selected.
5. **XMTR Switch:** In the OFF position, the transmitter power amplifier filaments are disabled to reduce power consumption during "receive only" periods. (Power is still supplied to the crystal ovens as long as the VOLUME/PWR OFF switch is on.) In the ON position, filament power is connected to the power amplifier tubes and the transmitter may be activated by depressing the push-to-talk (PTT) button in the microphone.
6. **XMTR OUTPUT Indicator (CR3):** This light emitting diode indicates relative transmitter output. This indicator should flicker while speaking into the microphone on A3J or A3A modes. On the A3H mode, the indicator will remain partially illuminated whenever the transmitter is keyed and reach full brightness when speaking into the microphone.
7. **MIC Connector:** Provides a connection for the microphone.
8. **BAND Switch:** This control selects the desired band of operation.
9. **SET BAND Indicator (CR2):** This light emitting diode will be off during all operation. Illumination indicates that the BAND switch is not set to the proper band for the channel which has been selected by the channel switch.



## CHAPTER IV THEORY OF OPERATION

### 4-1. RECEIVER.

Refer to the block diagram figure 4-1 and the schematic diagrams in Chapter V. The signal from the antenna is applied to the appropriate low-pass filter A300 for the band in use. The output of the low-pass filter is applied to a high-pass filter with a cutoff frequency of 2 MHz. The front end selectivity resulting is a band-pass characteristic due to the net response of the low-pass and high-pass filters.

The output of the 2 MHz high-pass filter is applied to gate 1 of the RF amplifier Q601 through step-up transformer T601. The amplified output of Q601 is applied to gate 1 of receive mixer Q602. The frequency of the local oscillator injection is 10.7 MHz above the desired receiving frequency. The output of receive mixer Q602 is tuned to 10.7 MHz, the difference frequency of the injection and the desired signal. This 10.7 MHz IF output of the receive mixer is applied to the crystal filter from a capacitive tap on the receive mixer's tank circuit which provides proper impedance matching.

The crystal filter is a dual mode type. The mode of the filter is controlled by the diode OR gate composed of diodes CR101, CR102 and CR103. If the channel in use is programmed for A3A or A3J, voltage is applied to the LSB terminal of the crystal filter through the channel switch, the programming matrix, and the A3A or A3J diode of the OR gate. Under these conditions, the filter functions as a 10.7 MHz LSB filter with a 6 dB bandwidth of 2.2 kHz. Although A3J, A3A and A3H signals received are USB, an LSB filter is needed due to the inversion that takes place in the receive mixer. If the channel in use is not programmed for A3A or A3J, no voltage is applied to the LSB terminal of the crystal filter and it functions as a filter with a 6 dB bandwidth of 4 kHz centered about 10.7 MHz for better AM reception. The crystal filter output is applied to the 10.7 MHz IF strip composed of IF amplifiers Q603, Q604 and Q605. High impedance output from IF Amplifier Q605 is applied to the AVC amplifier Q608. Low impedance output is

obtained from a capacitive tap on Q605's tank and applied to AM detector CR607 and the product detector composed of diodes CR608, CR609 and their associated circuitry. The A3H control line is the inverted output of the diode OR gate composed of CR101, CR102 and CR103 used to control the crystal filter mode. It is obtained from the collector of transistor Q103 and applied to the AM detector CR607, audio preamplifier Q614, and BFO switch Q703. When the particular channel in use is programmed for A3A or A3J the output of the above mentioned diode OR gate switches the crystal filter to the LSB mode and also saturates Q103 causing the A3H control line to be close to zero Volts. With no voltage applied to AM preamplifier Q606, it is disabled and BFO signal is applied through T603 causing the product detector to function. If the channel in use is programmed for A3H, no voltage is applied to either the A3A or A3J inputs of the diode OR gate. This puts the crystal filter in the AM mode and causes the A3H control line to assume a voltage level of 11 to 12 Volts DC. This voltage, which acts as supply voltage for the AM detector preamplifier, enables the AM detector and disables the product detector by turning on switch Q705 which disables the BFO.

The audio output of each detector is applied to audio preamplifier Q614. The output of Q614 is applied through the volume control to the audio amplifier composed of Q615, Q616, Q617, Q618, Q619, and finally audio output transistors Q620 and Q621 which drive the speaker.

The IF output applied to AVC amplifier Q608 causes it to conduct on negative half cycles. The collector current of Q608 is filtered by C601 and charges C602 through R601. This DC voltage is applied to gate 1 of RF amplifier Q601 through R602, gate 1 of IF amplifier Q604 through R634, and gate 1 of IF amplifier Q605 through R640 to control their gain. The AVC associated circuit components are chosen to provide AVC attack and release times of 1 millisecond and 0.75 second respectively, and to provide a delayed AVC action of the RF amplifier Q601.



#### 4-2. TRANSMITTER.

Microphone audio is applied to the Balanced Modulator composed of diodes CR603, CR604, CR605 and CR606 through MIC gain control R606. Carrier Oscillator voltage of 10.7 MHz is also applied to the Balanced Modulator through Carrier Balance control R605. The output of the Balanced Modulator is a 10.7 MHz double sideband (DSB) suppressed carrier signal. Transformer T604 couples this signal to the crystal filter. The crystal filter mode control gate composed of diodes CR101, CR102 and CR103 has +13T (13 Volts DC on transmit) connected to the CR103 input. This automatically places the crystal filter in the LSB mode on transmit.

The 10.7 MHz LSB signal at the output of the crystal filter is amplified by IF amplifiers Q603 and Q604, and applied to Balanced Mixer U601. Local oscillator injection which is higher in frequency than the 10.7 MHz IF by the desired transmitting frequency is applied to pin 4 of the Balanced Mixer. The output of the Balanced Mixer, consisting basically of the sum and difference frequencies of the 10.7 MHz IF and the local oscillator is applied to the appropriate filter for the band in use through RF amplifier Q607. A low-pass filter is used on the 2 MHz band, and band-pass filters are used on the remaining bands to remove the undesired mixer products. The output of the filter, due to the inversion in the mixer, is an USB signal at the desired transmitting frequency.

The Carrier Oscillator injection is also applied to the carrier reinsertion circuit through C653. When the channel in use is programmed for A3J, voltage is applied to CR102 through the mode programming switch and the programming matrix. This voltage also biases on diodes CR617 and CR619 through R662 and R661 respectively. This attenuates the carrier oscillator signal and no carrier is reinserted.

If the channel is programmed for A3A, 13 Volts DC is applied to CR101 through the mode programming switch and the programming matrix. This voltage forward-biases CR615 causing C604 to be effectively grounded. Grounding C604 presents a voltage divider to the carrier oscillator injection whose output is of the proper level to provide A3A

operation (carrier  $16 \pm 2$  dB down). This selected amount of Carrier Oscillator is reinserted at gate 1 of Q604 through C603. This insertion point is after the ALC controlled stage Q603 insuring the carrier level stays constant with respect to the 150 Watt PEP level.

If neither A3A nor A3J is programmed, the mode is automatically A3H and the carrier oscillator level injected at Q604 is sufficient to provide normal A3H operation (carrier 3 to 6 dB down).

For either A3A or A3H operation, separate controls, one for each channel, are provided to trim the reinserted carrier to exactly the right level. For a particular channel, the carrier level adjustment forward-biases CR620 through R658 and thus comprises a variable attenuator to facilitate adjustment of the reinserted carrier to the proper level for each channel. The signal from the filter output is applied to the input terminals of the driver board (A200). Stage Q201 is an emitter follower which matches the output impedance of the filter to the input impedance of stage Q202. Stage Q202 is a class A amplifier with bandwidth characteristics from 2 to 9 MHz. The amplified output from this stage is coupled into transformer T201 which in turn matches the input of transistors Q203 and Q204 which form a push-pull class AB driver stage. Q203 and Q204 boost the power level to a sufficient level to drive the two power amplifier tubes V1 and V2. Transformers T202 and T203 perform the necessary impedance matching and voltage step-up. The grid of the power amplifier stage is tuned with low Q tuned circuits for each of the four bands. V1 and V2 are capable of boosting the power level to over 150 Watts output. The plate circuit of the power amplifier is matched to 50 Ohms by broadband matching transformer T1 or T2 depending on the band of operation. The 50 Ohm output from these transformers is then connected to one of the three low-pass filter sections. These filters are 3-section filters of elliptical design which provide the necessary harmonic attenuation. The 50 Ohm output of the filter may be connected to the 50 Ohm output connector or to the antenna matching network.

An RF output detector circuit A5 measures the power output and generates an AGC voltage when

the output power reaches a level of 150 Watts PEP. This AGC voltage is applied to the first IF amplifier stage which adjusts the drive level to maintain 150 Watts output. The AGC circuit functions by comparing the DC output of the forward power detector rectifier with a fixed DC voltage which is set by R402. U401 is a quad monolithic operational amplifier. When voltage from the detector slightly exceeds the reference voltage, U401A amplifies the difference voltage and applies it to IF amplifier Q603 as AGC control voltage. This prevents the PEP output from exceeding the 150 Watt level.

Reverse power is also measured. When the VSWR exceeds a predetermined level, the DC voltage from the reverse power detector CR502, which is compared with a fixed reference voltage by op-amp U401C, generates AGC voltage which is applied to IF amplifier stages Q604 and Q605 via the receiver AGC source. This AGC reduces drive level to protect the final amplifier tubes under conditions of high reflected power. The time constant of the reverse AGC is slow (in the order of 5 seconds) so that intermittent variations (such as wind blowing the antenna) will not cause a reduction in output when such temporary variations would not be detrimental to the final amplifier tubes. A third AGC circuit detects grid current of final amplifier tubes. At the first trace of grid current, voltage is developed across resistor R608 which turns on transistor Q610. This biases transistor Q611 so that it conducts and applies positive AGC voltage to the AGC line which prevents the drive level from exceeding the level where grid current just begins. This circuit normally is not necessary because the 150 Watt PEP output detector is already producing AGC voltage which keeps the drive level well below that which would cause grid current. However, if for some reason the power output was low (due to very weak final tubes, etc.) the grid AGC circuit would function to prevent overdrive of the power amplifier grids and thus prevent generation of 'splatter' and distortion. The AGC voltage which is generated by the forward power detector CR501 is applied to the first IF amplifier where it does not affect the carrier level in the A3A and A3H modes. This insures that the carrier levels will remain the proper amount below the 150 Watt PEP output even with very high voice levels.

#### 4-3. POWER SUPPLIES.

Four power supplies are available for use with the TR-M: 12.9 Volt and 35 Volt DC and 115 Volt and 230 Volt AC.

The 12.9 and 35.0 Volt units have DC to DC converters for supplying the proper voltages to the Power Amplifier. The 35 Volt supply, in addition to having the DC to DC converter, has a regulator to develop 12.9 Volts from the 35 Volt source. Taking the 12.9 Volt unit for an example, Relay K1101 is energized when the PTT switch on the microphone is keyed. The relay contacts apply  $\pm 12.9$  Volts DC to the multivibrator consisting of Q1101, Q1102, T1102, and R1108. R1101, R1102, and C1102 comprise a starting circuit which applies a pulse to the bases of Q1101 and Q1102 to assure that oscillation starts. The outputs of transformer T1101 are rectified, filtered, and supplied to the Power Amplifier in the TR-M. Diode CR1110 and fuse F1102 form the reverse polarity protector circuit. If the input line is accidentally reversed, diode CR1110 will conduct and blow fuse F1102. Filament voltage for the Power Amplifier tubes is supplied directly from the DC source.

The operation of the 35 Volt power supply is identical to the 12.9 Volt supply except for the addition of a +12.9 Volt regulator. Transistor Q1503 is a series pass regulator. The base of Q1503 is held at a fixed voltage by zener diodes CR1511 and CR1512. Resistor R1510 limits the collector current of Q3 to a safe value in case of a +12.9 Volt short and prevents damage to Q3. Resistor R1513 is used in the 35 Volt supply to drop the voltage to relay K1 to +12.9 Volts. Resistor R1512 is used to drop the input voltage to 31 Volts for the 31LQ6 filaments. The two AC power supplies are identical except for the power transformer primary voltage. Voltage doubler circuits are used to provide 650 Volts DC and 250 Volts DC and a half-wave rectifier provides bias voltage for the Power Amplifier tubes. Filament voltage is obtained from a winding on the transformer. Voltage for the semiconductors is obtained from the full-wave bridge rectifier and associated regulator circuit. The MC7805 regulator is connected to provide approximately 14 Volts regulated output. The 40310 voltage follower is used to increase the current capacity of the supply. The .15 Ohm resistor and diodes CR1809 and CR1810 form a current limiting circuit.



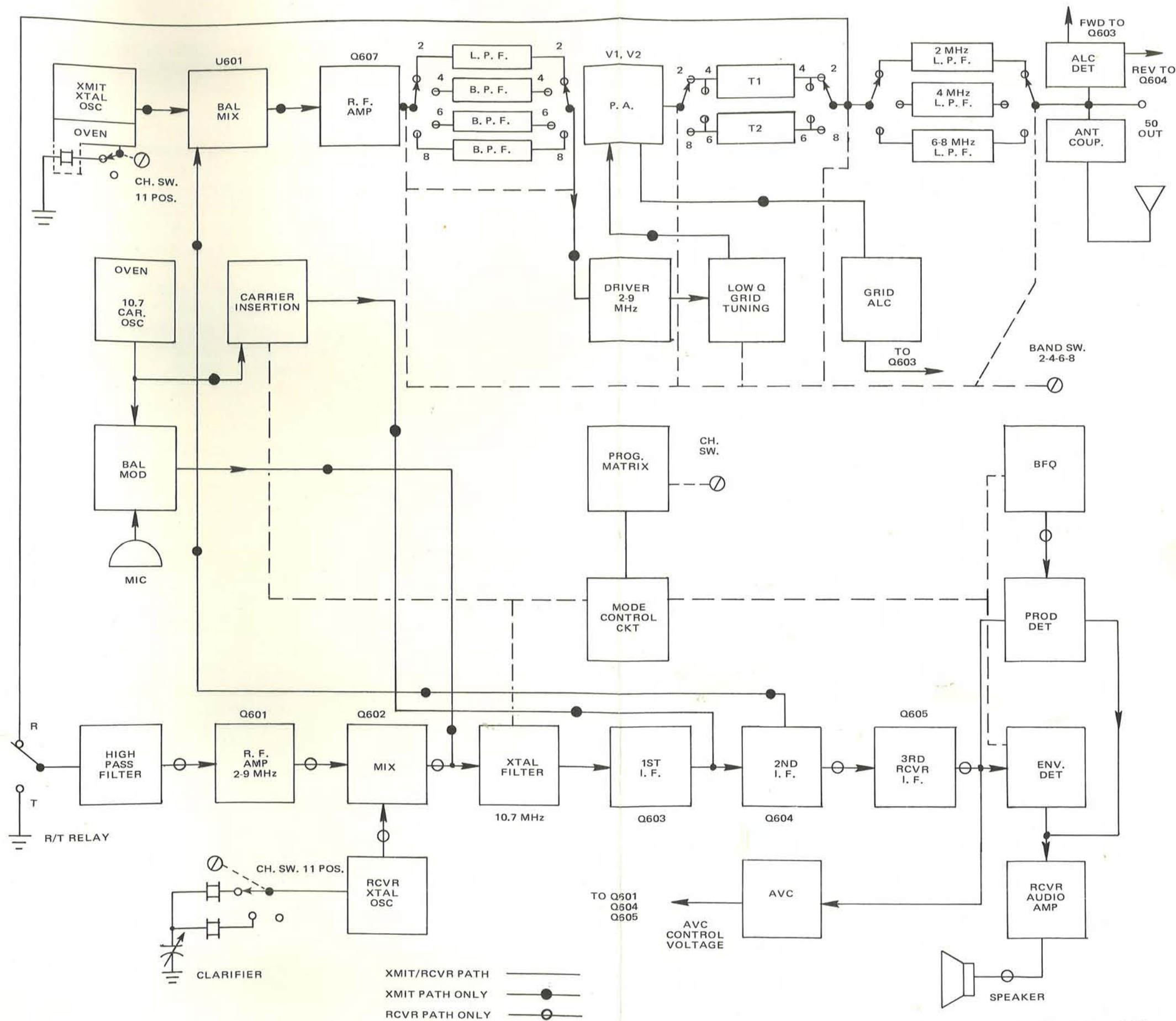

Figure 4-1. TR-M Block Diagram



## CHAPTER V MAINTENANCE

### 5-1. SERVICE DATA.

In case of malfunction, contact your dealer or the R. L. Drake Company at the address below. We will check and align your unit at the factory for a nominal fee if it has not been tampered with. Transportation charges are extra. Any necessary repairs will be made on a time and material basis. Please write or call the factory for authorization before returning your unit for alignment or service. Address your request for authorization to:

R. L. Drake Company  
540 Richard Street  
Miamisburg, Ohio 45342  
ATTN: Customer Service Department  
Telephone: (Area Code 513) 866-3211  
Telex No. 288-017

### 5-2. ALIGNMENT – GENERAL.

#### NOTE

Maintenance, alignment and adjustment procedures must be performed by a qualified radio technician.

Connect the TR-M to a power source matching the voltage marked on the bottom of the unit. For the alignment procedures, the power source must provide regulated voltage within  $\pm 5\%$  of the rated voltage under all load conditions.

### 5-3. TEST EQUIPMENT.

The following list of test equipment represents the minimum required to test and align the TR-M.

- a. Frequency Counter: 2 to 20 MHz; 0.00001% accuracy.
- b. VTVM: at least 11 Megohm input impedance. Not affected by RF fields.
- c. VOM: at least 10,000 Ohms/V sensitivity. Not affected by RF fields.
- d. RF Voltmeter: capable of measuring RF voltage as low as 0.1 Volt RMS (HP-401B, HP-410C or equal). For carrier balance adjustment.
- e. Signal Generator: 2 to 10.7 MHz with variable attenuator.
- f. Wattmeter: 5% accuracy at 4 Watts, 50 Watts, 150 Watts; 2-9 MHz.
- g. Dummy Load: 50 to 52 Ohm; 200 Watts.
- h. Alignment Tool: Insulated.
- i. Audio Oscillator: Lo-impedance.

### 5-4. RECEIVER ALIGNMENT.

Alignment of the receiver section consists of adjusting the two 10.7 MHz IF transformers T602 and L607, adjusting mixer output coil L606, adjusting the 10.7 MHz antenna trap L601 and 5.35 MHz trap L605 and setting the crystal oscillators to the proper frequency. Apply power to unit (turn VOLUME switch ON). Remove the top cover only for this procedure.



### 5-5. 10.7 MHz BFO FREQUENCY ADJUSTMENT.

- Select a channel which is programmed for A3A or A3J mode.
- Refer to figure 2-4. Connect a frequency counter through a 470 Ohm resistor to terminal No. 26 on RF-IF board A6 (or at the other end of the coax connected to board A7).
- Adjust L702 on the RCVR OSC board A7 for exactly 10.700000 MHz. This adjustment is accessible from the right side of the unit (see figure 2-3).

### 5-6. IF AND MIXER ALIGNMENT.

- Select a channel programmed for A3A or A3J mode.
- Refer to figure 2-4. Connect an 11 Megohm VTVM to the receiver AVC point terminal No. 33 on the RF-IF board A6. With no signal input, voltage should be approximately 1.2 Volt DC.
- Apply a signal from a signal generator to the antenna jack using any of the channels which may be installed in the unit. Tune the generator frequency to the channel frequency and adjust to obtain maximum AVC voltage.
- Adjust the signal generator level until the AVC voltage is in the 2.0 to 2.5 Volt range.
- Adjust T602 and L607 for maximum AVC voltage.
- Adjust L606, mixer coil, for maximum AVC voltage.

### 5-7. 10.7 AND 5.35 MHz TRAP ALIGNMENT.

- Set signal generator frequency to 10.7 MHz with the generator connected to the transceiver antenna jack. Set the BAND and CHANNEL switches so that a channel in the 8 MHz band is selected. If the unit is not programmed for an 8 MHz channel, temporarily install a receive crystal and a program screw for this band.
- Refer to figure 2-4. Adjust the generator frequency and level to obtain approximately 2.0 Volts of AVC voltage at the AVC test point, terminal No. 33 on board A6.

- Tune L601, the 10.7 MHz trap, for minimum AVC voltage. If the voltage drops below 1.8 Volts, increase the generator level to keep the AVC voltage around the 2.0 level.
- Retune the generator to 5.35 MHz. Repeat steps b. and c. except adjust L605, the 5.35 MHz trap, for minimum AVC voltage.

### 5-8. HF OSCILLATOR FREQUENCY ADJUSTMENT.

- Set the CHANNEL switch to the channel to be adjusted. Make sure the BAND switch is on proper band.
- Refer to figure 2-4. Connect the frequency counter through a 470 Ohm resistor to terminal No. 13 on board A6.
- Set the CLARIFIER control to the center of its range.
- Refer to figure 2-3. Adjust the appropriate receive oscillator variable capacitor on board A7 for the channel selected for the proper frequency.

#### NOTE

Injection is 10.7 above the carrier frequency to be received. Therefore, the oscillator should be adjusted to the following frequency: Carrier Freq. + 10.7 MHz.

Repeat the above procedure for each channel to be adjusted being careful to adjust only the capacitor for the channel being set.

### 5-9. AUDIO AMPLIFIER BIAS ADJUSTMENT.

This potentiometer adjustment was set at the factory and should not require readjustment unless the audio output transistors are replaced. If the audio output transistors are replaced proceed as follows:

- Set the CHANNEL selector to a channel programmed for A3J or A3H.
- Connect an audio oscilloscope across the speaker terminals.
- Connect the CW output of a signal generator to the antenna input and set the frequency to produce an audio beat note of approximately 1 kHz.

- Set the VOLUME control to a low listening level.
- Observe the sine wave on the oscilloscope. Refer to figure 2-4. Turn potentiometer R686 clockwise (as viewed from the front panel of the TR-M) until crossover distortion is noticeable. Turn R686 counterclockwise until crossover just disappears. Do not adjust R686 beyond that point.

### 5-10. TRANSMITTER ALIGNMENT.

Connect a 50 Ohm dummy load to the SO-239 and connect the TR-M for 50 Ohm output as outlined in paragraph 2-11. Set the XMTR toggle switch to ON. Apply power to unit and allow 10 minutes warmup.

#### NOTE

This adjustment must be made under conditions of zero transmitter output; therefore, be sure the conditions of step a. below are observed.

- Set CHANNEL switch to a channel with no crystal or to a channel programmed to A3J. BAND switch may be in any position.
- Connect a VTVM or VOM to bias test point on Power Supply bottom.
- Key transmitter microphone PTT switch and adjust the bias potentiometer (on the bottom of the unit) for a reading of 0.75 Volts.

Transmitter Alignment (not including antenna tuner) consists of tuning IF transformer T602; adjusting carrier balance adjustments R605 and C675; adjusting 10.7 MHz traps L201 and L910; setting up the proper crystal oscillator frequencies, and AGC adjustments. Adjustment of the carrier reinsertion levels is covered in the section on programming in Chapter II.

### 5-11. IF ALIGNMENT.

- Set the BAND and CHANNEL selectors to any convenient channel.
- Place the TUNE switch in the TUNE position (switch is on bottom of unit).

- Refer to figure 2-4. Carefully peak T602 for maximum output. Note that this transformer was tuned in the receiver alignment procedure but should be retuned as the adjustment is slightly more critical in the transmit mode.

### 5-12. CARRIER BALANCE ADJUSTMENT.

- Set the unit to a channel which is programmed for A3J operation.
- Refer to figure 2-4. Turn the microphone gain control R606 to minimum setting. (Fully clockwise as viewed from front panel.)
- Adjust C675 until snug; maximum capacity.
- Connect an RF voltmeter across the 50 Ohm dummy load.
- Key transmitter by depressing PTT switch.
- Adjust R605 for carrier null as indicated on RF voltmeter.
- Adjust C675 in small increments toward minimum capacity and after each increment readjust R605 for null. Continue until the deepest null is reached. Note that these adjustments are critical and should be made very carefully.

### 5-13. 10.7 MHz TRAP ALIGNMENT.

- Set the BAND switch to 8 MHz. Set the CHANNEL switch to a channel on another band. The SET BAND indicator will light.
- Connect a VTVM or VOM to the bias test point (on bottom of unit).
- Connect the signal generator in series with a 100 Ohm resistor to the input terminals of the driver board A2. Key the transmitter PTT switch. Set frequency to exactly 10.7 MHz and increase level until voltage measured at the bias test point increases about 0.2 Volt. (This may require an output level of approximately 1 Volt RMS from the generator.)
- Refer to figure 2-4. Adjust L201 and L910 for minimum voltage at the bias test point.
- Remove the generator and 100 Ohm resistor from driver board input.



#### 5-14. TRANSMITTER AGC ALIGNMENT.

- a. Wire for 50 Ohm output (see figure 2-7) and connect the TR-M to an accurate Wattmeter and a high quality 50 to 52 Ohm dummy load.
- b. Set transmitter to a channel on the 6 or 8 MHz band and program for A3J. If not normally programmed for 6 or 8 MHz, temporarily install a crystal and program screw to operate on this band.
- c. Place the TUNE switch in the TUNE position.
- d. Connect a VTVM or VOM to the reflected power tip jacks on the rear of the TR-M (plus terminal to red tip jack). Set meter range to approximately 1.5 Volt full scale.
- e. Activate the PTT switch (power out should be approximately 50-100 Watts).
- f. Refer to figure 2-4. Carefully adjust C501 with an *insulated* alignment tool for minimum reflected power voltage at the test jacks as read on the VTVM or VOM.
- g. Remove VTVM or VOM probes and return TUNE switch to the NORMAL position.
- h. Connect an audio oscillator (LO-impedance) across the microphone input terminals.
- i. Set MIC gain pot R606 at mid range.
- j. Activate the PTT switch.
- k. Set the level from the audio generator 10 dB above that required to produce 100 W output.
- l. Adjust R402 (forward power set) for an output

- power of 135 Watts. It should be possible to set output power above this level. (This shows that the AGC is operative.) Note the 135 Watt setting will allow the PEP output on voice peaks to approach 150 Watts but not to exceed this limit under temperature and voltage variations.
- m. Remove the Wattmeter, oscillator, etc. and re-program for changes made in step b. if necessary.

#### 5-15. TRANSMITTER FREQUENCY ADJUSTMENT.

- a. Refer to figure 2-4. Connect frequency counter to terminal No. 38 on board A6 or at Receive Oscillator board A7 at the other end of the coax and adjust L701 (see figure 2-3) for a reading of exactly 10.700000 MHz when the transmitter is keyed.
- b. Follow the steps in paragraph 2-9.
- c. Refer to figure 2-5. For each channel to be adjusted, key the PTT and adjust the frequency adjusting trimmer on board A1 for that channel for the proper carrier frequency.

#### 5-16. PARTS LISTS.

The parts lists which follow present a complete parts breakdown of all electrical subassemblies in the transceiver. Printed circuit board illustrations are shown viewing the circuit side of the board. Reference designations keying the parts lists to the illustrations are identical to those used on the schematic diagrams in the rear of the manual.

#### NOTES



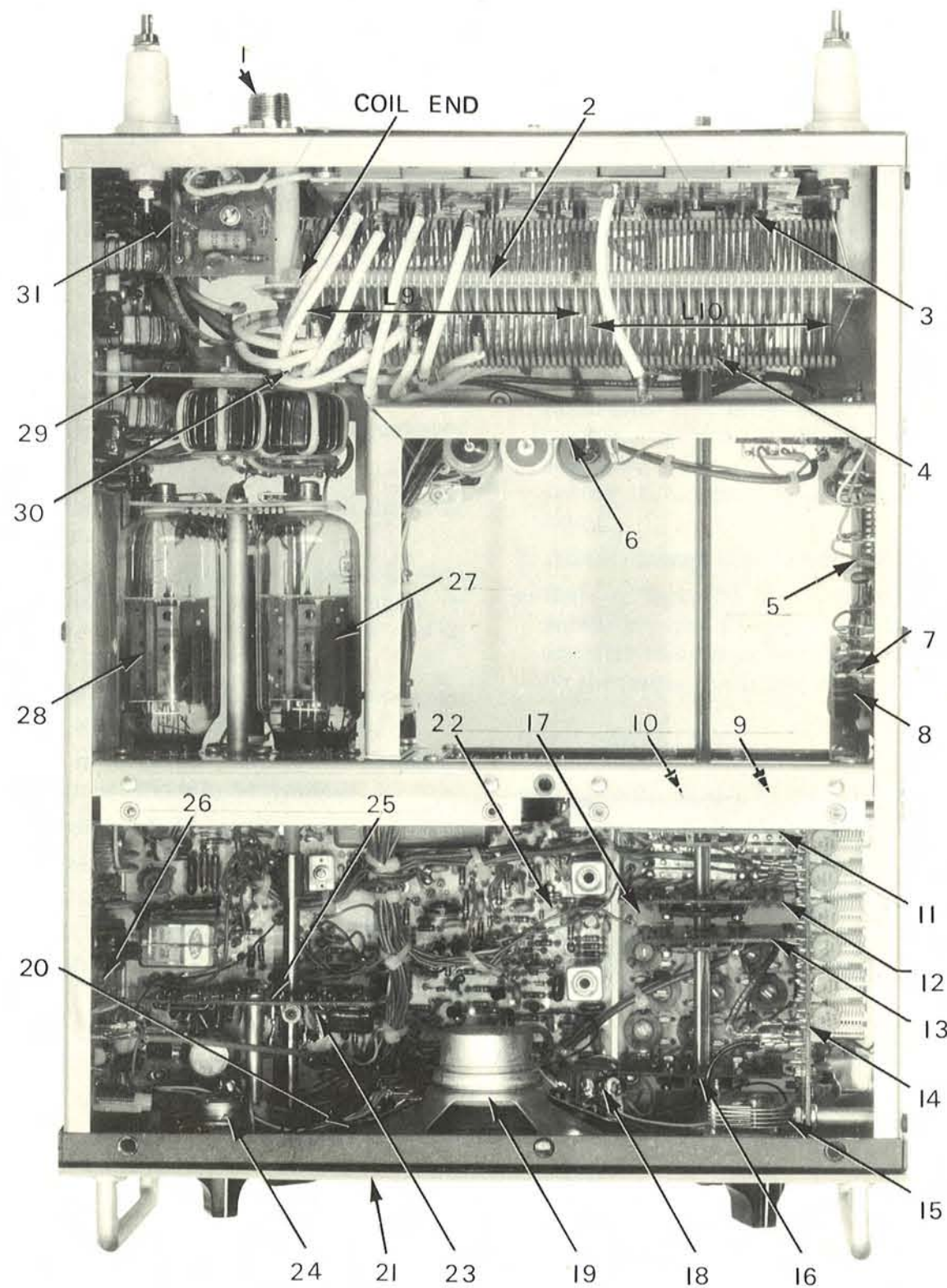

Figure 5-1. Chassis-Mounted Components, Top View

Figure 5-1. Parts List

ITEM	REF DES	DESCRIPTION
1	J2	Connector SO-239
2	L9/L10	Air Inductor (R. L. Drake B-2694-A)
3	A17	Coupler Board
4	S14	Switch (R. L. Drake A-2623-D-3)
5	A4	ALC Board
6	A13	Power Supply Filter Board
7	R15	Resistor, Carbon Comp., 22 K 10%, 2 W
8	R13	Resistor, Carbon Comp., 27 Ohm 10%, 1/4 W
9	A1	Transmit Oscillator Board
10	S101	Switch (R. L. Drake A-2621-D-2)
11	S1003	Switch (R. L. Drake A-2621-D-1)
12	S1002	Switch (R. L. Drake A-2621-D-1)
13	S1201	Switch (R. L. Drake A-2621-D-1)
14	A7	Receive Oscillator Board
15	C17	Capacitor, Variable, 4-37 pf, 16APL73
16	S1001	Switch (R. L. Drake A-2621-D-1)
17	A8	Program Board
18	S2	Toggle Switch DPDT, 20902CX
19	LS1	Speaker, 3" x 5"; 3.2 Ohm, Waterproof Cone
20	A16	Microphone Board
21	J3	Connector, Microphone
22	A6	RF-IF Board
23	S901	Switch (R. L. Drake A-2622-D-1)
24	R12/S1	Potentiometer, 3 K, with SPST Switch (R. L. Drake B-2270-R)
25	A9	IF Filter Board
26	A2	Driver Board
27	V2	Tube (12 V: RCA 6LQ6; 35 V: RCA 31LQ6)
28	V1	Tube (12 V: RCA 6LQ6; 35 V: RCA 31LQ6)
29	A3	Filter Board
30	S7	Switch (R. L. Drake A-2625-D-3)
31	A5	Power Detector Board
	C15	Capacitor (CC) Not Shown. (Selected at Installation as required.)
	C16	Capacitor (CC) Not Shown. (Selected at Installation as required.)
	C26	Capacitor (CC) Not Shown. (Selected at Installation as required.)



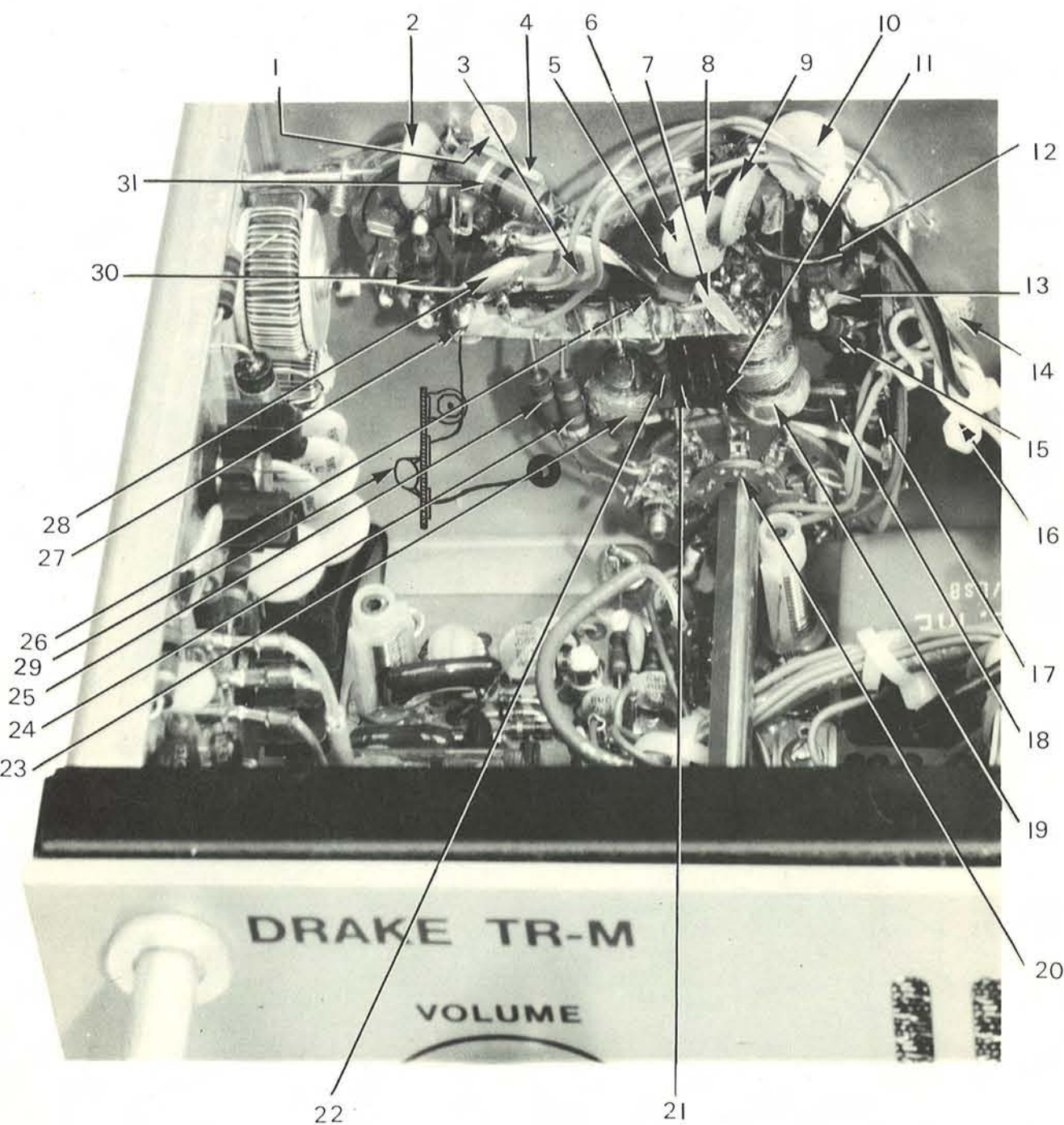

Figure 5-2. Bulkhead-Mounted Components

Figure 5-2. Parts List

ITEM	REF DES	DESCRIPTION
1	C22	Capacitor, Ceramic Disc, .01 uf 20%, Z5U
2	C7	Capacitor, Ceramic Disc, .01 uf 20%, Z5U
3	C19	Capacitor, Ceramic Disc, .01 uf 20%, Z5U
4	C6	Capacitor, Ceramic Disc, .001 uf 20%, Z5U
5	R7	Resistor, Carbon Comp., 15 Ohm 10%, 2 W
6	C9	Capacitor, Ceramic Disc, .001 uf 20%, Z5U
7	C21	Capacitor, Ceramic Disc, .01 uf 20%, Z5U
8	C20	Capacitor, Ceramic Disc, .01 uf 20%, Z5U
9	C18	Capacitor, Ceramic Disc, .01 uf 20%, Z5U
10	C8	Capacitor, Ceramic Disc, .01 uf 20%, Z5U
11	L7	Choke Coil (R. L. Drake B-2648-12)
12	R14	Resistor, Carbon Comp., 100 Ohm 10%, 1/2 W
13	C10	Capacitor, Ceramic Disc, 470 pf 20%, Z5U
14	C3	Capacitor, Ceramic Disc, .005 uf 20%, Z5U
15	R4	Resistor, Carbon Comp., 100 Ohm 10%, 1/2 W
16	C14	Capacitor, Ceramic Disc, .005 uf 20%, Z5U
17	R11	Resistor, Carbon Comp., 3.3 K 10%, 1/2 W
18	C13	Capacitor, Mica, 865 pf 10%, DM-19
19	L8	Choke Coil (R. L. Drake B-2648-9)
20	S4	Switch (R. L. Drake B-2270-R)
21	L6	Choke Coil (R. L. Drake B-2648-11)
22	R10	Resistor, Carbon Comp., 4.7 K 10%, 1/2 W
23	L5	Choke Coil (R. L. Drake B-2648-10)
24	R9	Resistor, Carbon Comp., 4.7 K 10%, 1/2 W
25	R8	Resistor, Carbon Comp., 1.5 K 10%, 1/2 W
26	R1	Resistor, Carbon Comp., 100 Ohm 10%, 1/2 W
27	C5	Capacitor, Ceramic Disc, 470 pf 20%, Z5U
28	C4	Capacitor, Ceramic Disc, .005 uf 20%, Z5U
29	C12	Capacitor, Ceramic Disc, 5.6 pf 5%, NPO
30	R5	Resistor, Carbon Comp., 100 Ohm 10%, 1/2 W
31	R6	Resistor, Carbon Comp., 15 Ohm 10%, 2 W



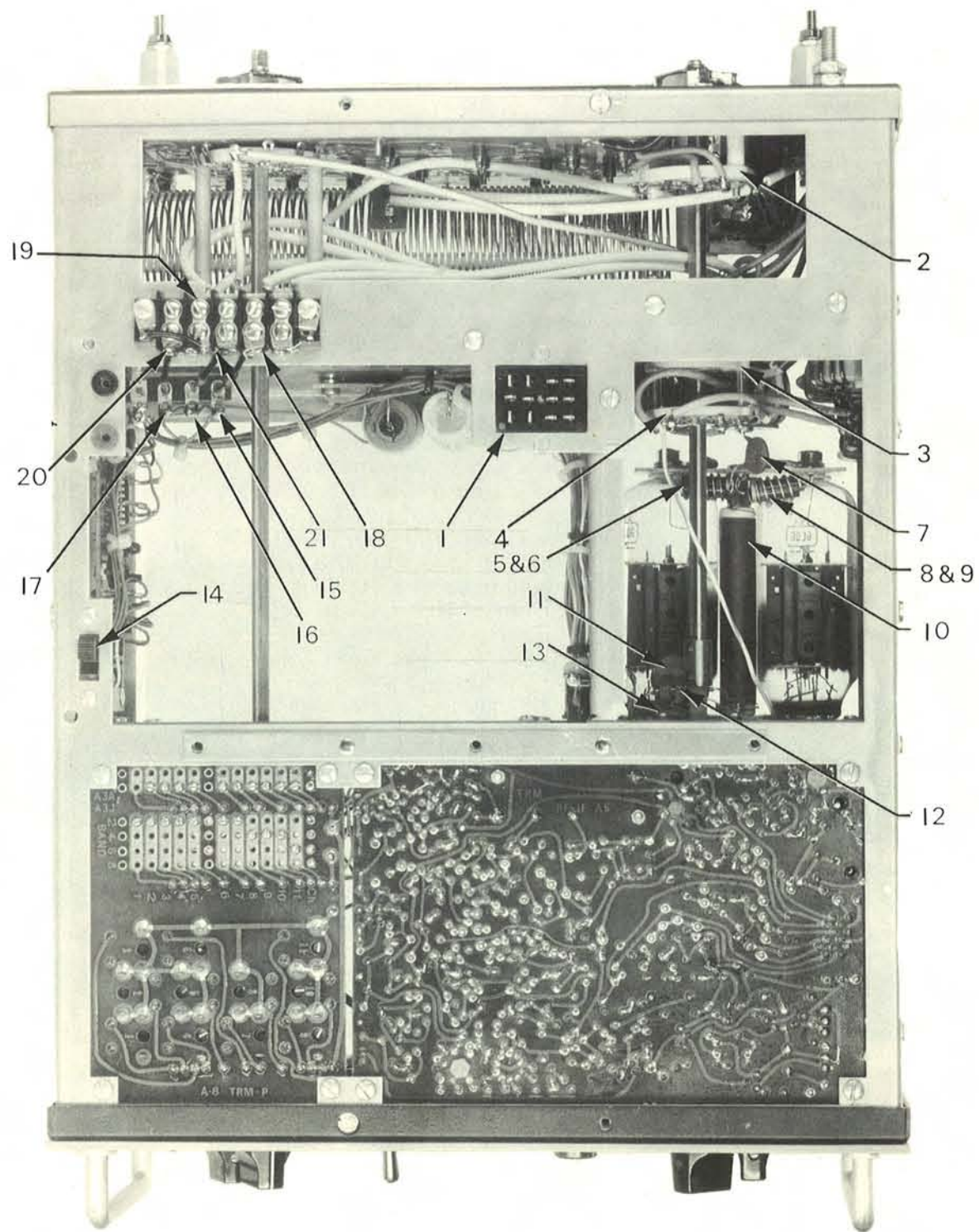

Figure 5-3. Chassis-Mounted Components, Bottom View

Figure 5-3. Parts List

ITEM	REF DES	DESCRIPTION
1	J1	Connector, (Cinch-Jones S-312-AB)
2	S8	Switch (R. L. Drake A-2678-D-1)
3	S6	Switch (R. L. Drake A-2625-D-2)
4	S5	Switch (R. L. Drake A-2625-D-1)
5	R3	Resistor, Carbon Comp., 47 Ohm 10%, 2 W
6	L4	Parasitic Choke, 7 Turns of No. 18 AWG around R3
7	C11	Capacitor, Ceramic Disc, .0027 uf, 2 kV, Z5U
8	R2	Resistor, Carbon Comp., 47 Ohm 10%, 2 W
9	L3	Parasitic Choke, 7 Turns of No. 18 AWG around R2
10	L2	R F Choke, 92 uH (R. L. Drake A-2693-E)
11	C2	Capacitor, Ceramic Disc, .001 uf Z5U, 1400 V
12	L1	R F Choke, 140 uH (R. L. Drake B-2648-E-9)
13	C1	Capacitor, Ceramic Disc, .001 uf Z5U, 1400 V
14	S3	Slide Switch, DPDT
15	L13	Inductor, Fixed (R. L. Drake B-2648-16)
16	L12	Inductor, Fixed (R. L. Drake B-2648-16)
17	L11	Inductor, Fixed (R. L. Drake B-2648-16)
18	C25	Capacitor, Ceramic Disc, .01 uf + 80 -20%, 25 V
19	C24	Capacitor, Ceramic Disc, .01 uf + 80 -20%, 25 V
20	C23	Capacitor, Ceramic Disc, .01 uf + 80 -20%, 25 V
21	TB1	Terminal Board (Cinch-Jones 5-140)



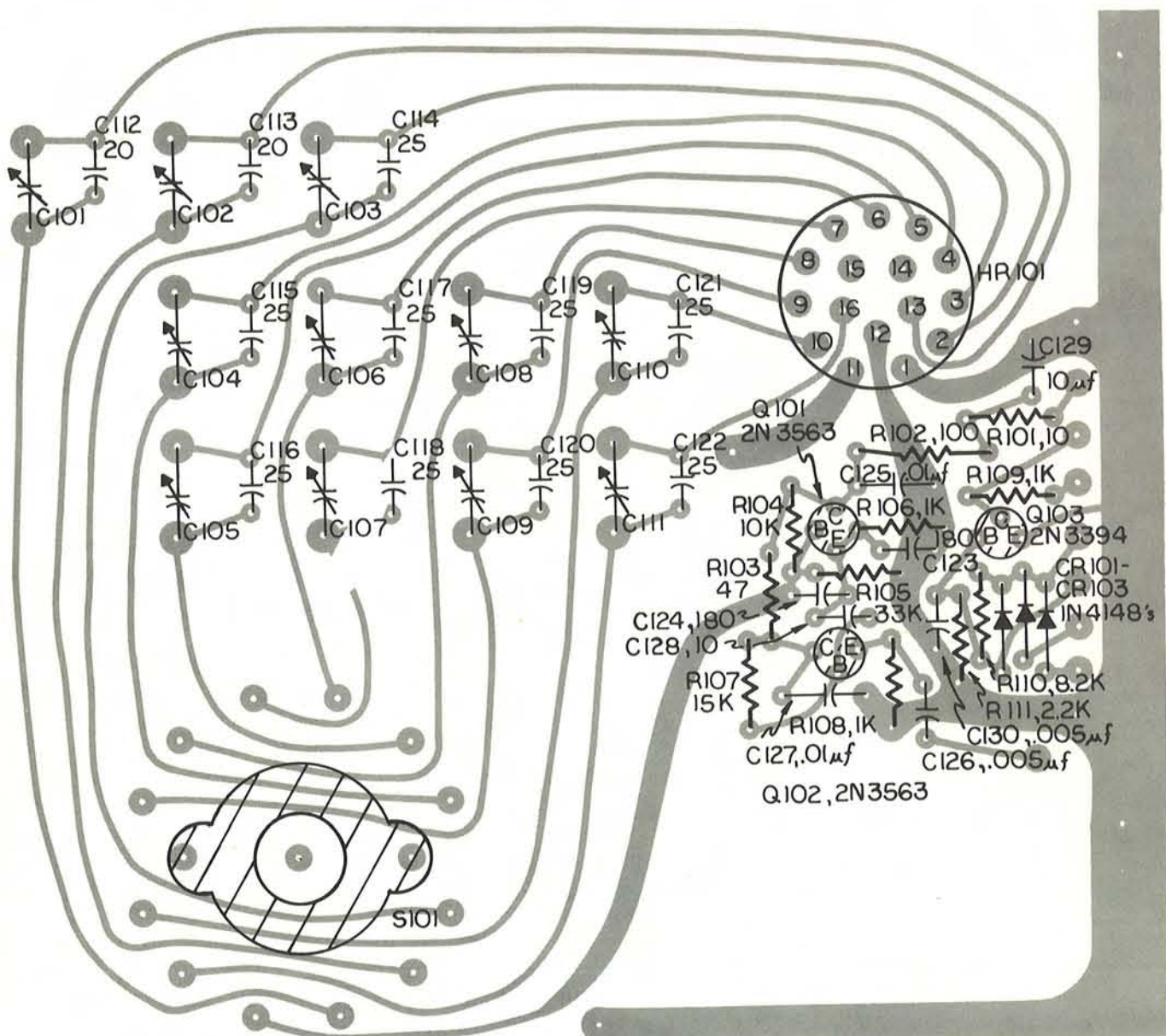

Figure 5-4. Transmit Oscillator Board (A1)

Figure 5-4. Parts List

REF DES	DESCRIPTION
Q101	Transistor, 2N3563
Q102	Transistor, 2N3563
Q103	Transistor, 2N3394
CR101	Diode, 1N4148
CR102	Diode, 1N4148
CR103	Diode, 1N4148
C101	Through
C111	Capacitor, Variable, 1.7-12 pf (EFJ 189-505-5)
C112	Capacitor, Disc, 20 pf 5%, NPO
C113	Capacitor, Disc, 20 pf 5%, NPO
C114	Capacitor, Disc, 25 pf 5%, NPO
C115	Capacitor, Disc, 25 pf 5%, NPO
C116	Capacitor, Disc, 25 pf 5%, NPO
C117	Capacitor, Disc, 25 pf 5%, NPO
C118	Capacitor, Disc, 25 pf 5%, NPO
C119	Capacitor, Disc, 25 pf 5%, NPO
C120	Capacitor, Disc, 25 pf 5%, NPO
C121	Capacitor, Disc, 25 pf 5%, NPO
C122	Capacitor, Disc, 25 pf 5%, NPO
C123	Capacitor, Disc, 180 pf 5%, N1500
C124	Capacitor, Disc, 180 pf 5%, N1500
C125	Capacitor, Disc, .01 uf 20%, Z5U
C126	Capacitor, Disc, .005 uf 20%, Z5U
C127	Capacitor, Disc, .01 uf 20%, Z5U
C128	Capacitor, Disc, 10 pf 5%, NPO
C129	Capacitor, Tantalum, 1 uf 10%, 25 V
C130	Capacitor, Disc, .005 uf 20%, Z5U
R101	Resistor, Carbon Comp., 10 Ohm 10%, 1/4 W
R102	Resistor, Carbon Comp., 100 Ohm 10%, 1/4 W
R103	Resistor, Carbon Comp., 47 Ohm 10%, 1/4 W
R104	Resistor, Carbon Comp., 10 K 10%, 1/4 W
R105	Resistor, Carbon Comp., 33 K 10%, 1/4 W
R106	Resistor, Carbon Comp., 1 K 10%, 1/4 W
R107	Resistor, Carbon Comp., 15 K 10%, 1/4 W
R108	Resistor, Carbon Comp., 1 K 10%, 1/4 W
R109	Resistor, Carbon Comp., 1 K 10%, 1/4 W
R110	Resistor, Carbon Comp., 8.2 K 10%, 1/4 W
R111	Resistor, Carbon Comp., 2.2 K 10%, 1/4 W
S101	Switch, Rotary, (R. L. Drake A-2621-D)
HR101	Crystal Oven, Transmit Osc., 12 V (R. L. Drake A-2722-V-1)
HR101	Crystal Oven, Transmit Osc., 35 V (R. L. Drake A-2722-V-2)



Figure 5-5. Parts List

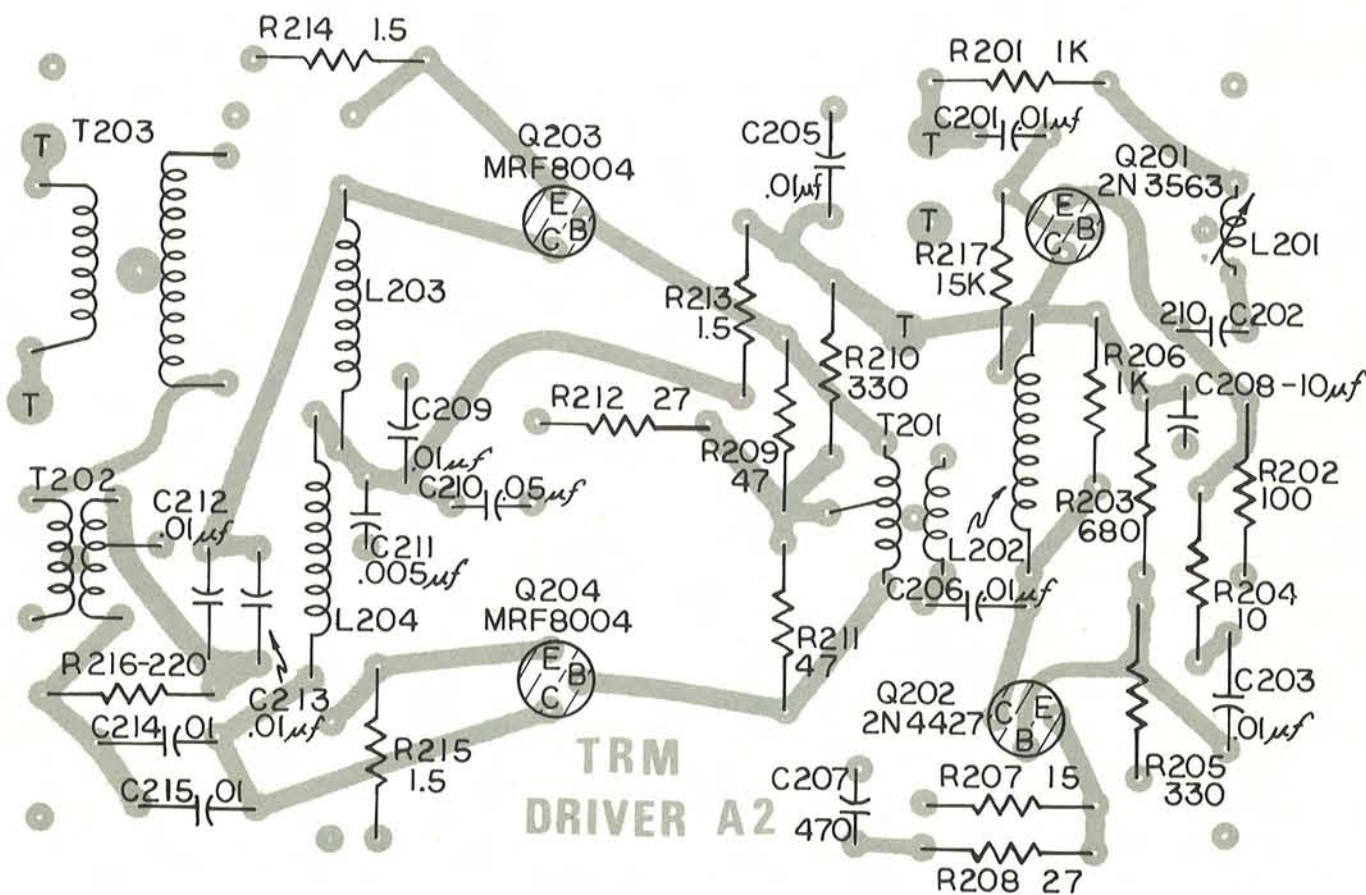

Figure 5-5. Driver Board (A2)

REF DES	DESCRIPTION
C201	Capacitor, Ceramic Disc, .01 uf 20%, Z5U
C202	Capacitor, Ceramic Disc, 210 pf 5%, DM-15
C203	Capacitor, Ceramic Disc, .01 uf 20%, Z5U
C204	Not Used
C205	Capacitor, Ceramic Disc, .01 uf 20%, Z5U
C206	Capacitor, Ceramic Disc, .01 uf 20%, Z5U
C207	Capacitor, Ceramic Disc, 470 pf 20%, Z5U
C208	Capacitor, Tantalum, 10 uf 20%, 25 VDC
C209	Capacitor, Ceramic Disc, .01 uf 20%, Z5U
C210	Capacitor, Ceramic Disc, .05 uf, + 80 -20%, 16 VDC
C211	Capacitor, Ceramic Disc, .005 uf 20%, Z5U
C212	Capacitor, Ceramic Disc, .01 uf 20%, Z5U
C213	Capacitor, Ceramic Disc, .01 uf 20%, Z5U
C214	Capacitor, Ceramic Disc, .01 uf 20%, Z5U
C215	Capacitor, Ceramic Disc, .01 uf 20%, Z5U
L201	Inductor, (Paul Smith SK304-1)
L202	RF Choke, (R. L. Drake B-2648-8)
L203	RF Choke, (R. L. Drake B-2648-8)
L204	RF Choke, (R. L. Drake B-2648-8)
R201	Resistor, Carbon Comp., 1 K 10%, 1/2 W
R202	Resistor, Carbon Comp., 100 Ohm 10%, 1/2 W
R203	Resistor, Carbon Comp., 680 Ohm 10%, 1/2 W
R204	Resistor, Carbon Comp., 10 Ohm 10%, 1/2 W
R205	Resistor, Carbon Comp., 330 Ohm 10%, 1/2 W
R206	Resistor, Carbon Comp., 1 K 10%, 1/2 W
R207	Resistor, Carbon Comp., 15 Ohm 10%, 1/2 W
R208	Resistor, Carbon Comp., 27 Ohm 10%, 1/2 W
R209	Resistor, Carbon Comp., 47 Ohm 10%, 1/2 W
R210	Resistor, Carbon Comp., 330 Ohm 10%, 1/2 W
R211	Resistor, Carbon Comp., 47 Ohm 10%, 1/2 W
R212	Resistor, Carbon Comp., 27 Ohm 10%, 1/2 W
R213	Resistor, Carbon Comp., 1.5 Ohm 5%, 1/2 W
R214	Resistor, Carbon Comp., 1.5 Ohm 5%, 1/2 W
R215	Resistor, Carbon Comp., 1.5 Ohm 5%, 1/2 W
R216	Resistor, Carbon Comp., 220 Ohm 10%, 1/2 W
R217	Resistor, Carbon Comp., 15 K 10%, 1/2 W
R218	Not Used
T201	Toroid, (R. L. Drake A-2636-E)
T202	Toroid, (R. L. Drake A-2637-E)
T203	Toroid, R. L. Drake A-2638-E)
Q201	Transistor, 2N3563
Q202	Transistor, 2N4427
Q203	Transistor, MRF8004
Q204	Transistor, MRF8004



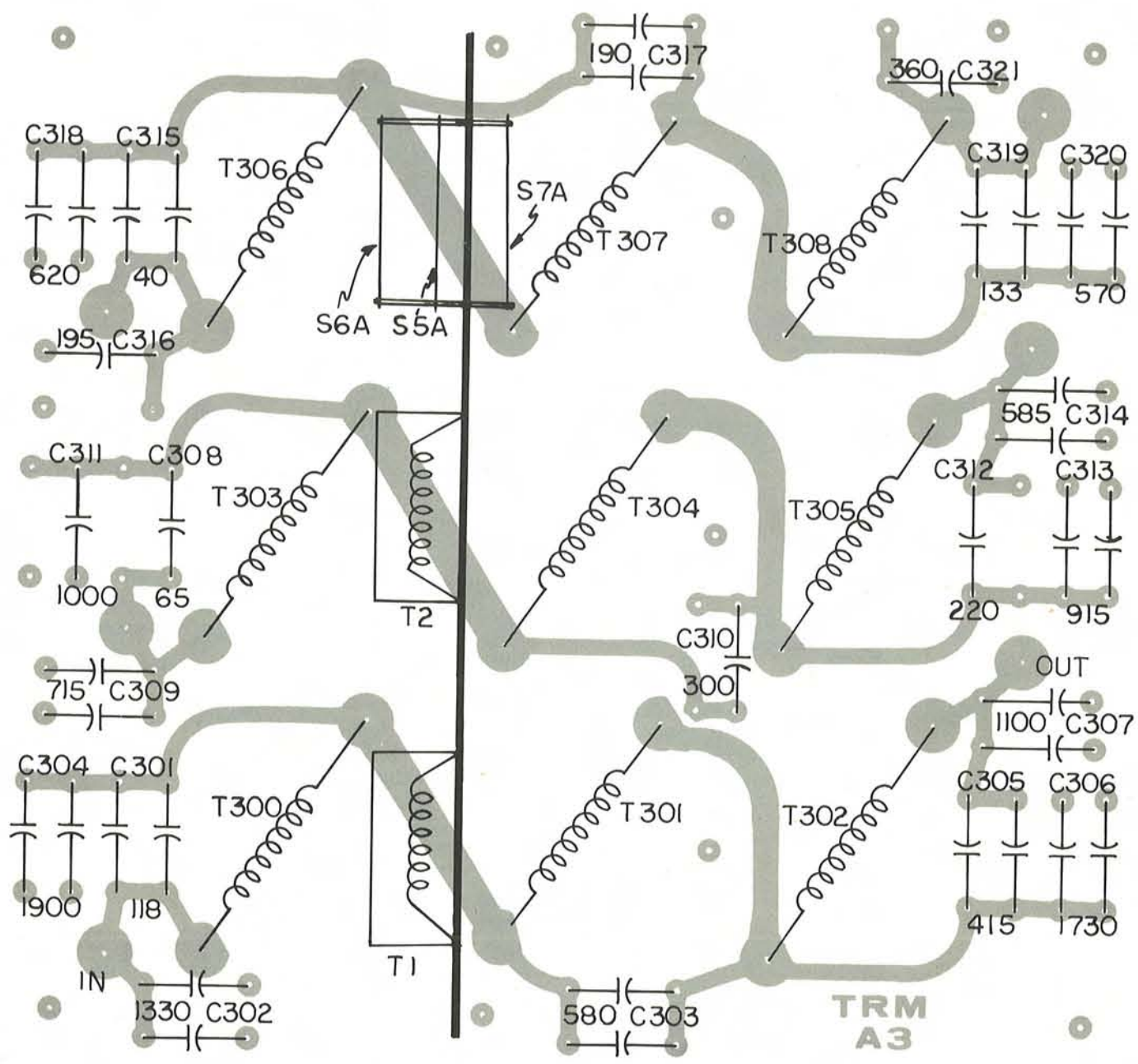

Figure 5-6. RF Filter Board (A3)

Figure 5-6. Parts List

REF DES	DESCRIPTION
C301	Capacitor, Mica, 68 pf 5%, DM-19 and 50 pf 5%, DM-20
C302 (2)	Capacitor, Mica, 665 pf 5%, DM-20
C303	Capacitor, Mica, 330 pf 5%, DM-19 and 250 pf 5%, DM-20
C304	Capacitor, Mica, 1800 pf 2%, DM-20 and 100 pf 5%, DM-20
C305	Capacitor, Mica, 220 pf 5%, DM-20 and 195 pf 5%, DM-20
C306 (2)	Capacitor, Mica, 865 pf 1%, DM-20
C307	Capacitor, Mica, 500 pf 5%, DM-19 and 600 pf 5%, DM-19
C308	Capacitor, Mica, 65 pf 5%, DM-20
C309	Capacitor, Mica, 665 pf 5%, DM-20 and 50 pf 5%, DM-20
C310	Capacitor, Mica, 300 pf 5%, DM-20
C311	Capacitor, Mica, 1000 pf 2%, DM-20
C312	Capacitor, Mica, 220 pf 5%, DM-20
C313	Capacitor, Mica, 865 pf 1%, DM-20 and 50 pf 5%, DM-20
C314	Capacitor, Mica, 390 pf 5%, DM-20 and 195 pf 5%, DM-20
C315 (2)	Capacitor, Mica, 20 pf 5%, DM-20
C316	Capacitor, Mica, 195 pf 5%, DM-20
C317	Capacitor, Mica, 100 pf 5%, DM-20 and 90 pf 5%, DM-20
C318	Capacitor, Mica, 350 pf 5%, DM-20 and 270 pf 5%, DM-19
C319	Capacitor, Mica, 68 pf 5%, DM-19 and 65 pf 5%, DM-20
C320	Capacitor, Mica, 300 pf 5%, DM-20 and 270 pf 5%, DM-19
C321	Capacitor, Mica, 360 pf 5%, DM-19
T300	Transformer, (R. L. Drake B-2633-1)
T301	Transformer, (R. L. Drake B-2633-2)
T302	Transformer, (R. L. Drake B-2633-3)
T303	Transformer, (R. L. Drake B-2633-4)
T304	Transformer, (R. L. Drake B-2633-5)
T305	Transformer, (R. L. Drake B-2633-6)
T306	Transformer, (R. L. Drake B-2633-7)
T307	Transformer, (R. L. Drake B-2633-8)
T308	Transformer, (R. L. Drake B-2633-9)
T1	Transformer, 2 and 4 MHz, (R. L. Drake B-2634-E)
T2	Transformer, 6 and 8 MHz, (R. L. Drake B-2635-E)
S5A	Switch, Part No. R. L. Drake A-2625-D1
S6A	Switch, Part No. R. L. Drake A-2625-D2
S7A	Switch, Part No. R. L. Drake A-2625-D3



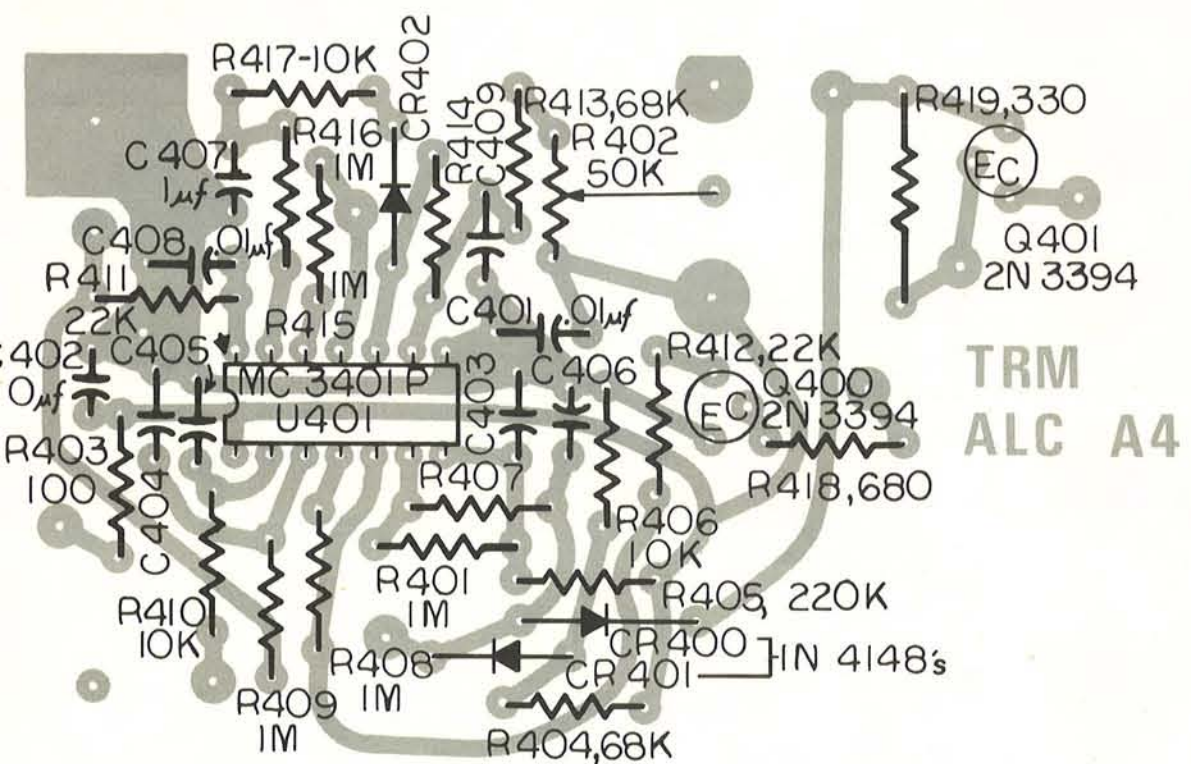

Figure 5-7. ALC Board (A4)

Figure 5-7. Parts List

REF DES	DESCRIPTION
Q401	Transistor, 2N3394
Q402	Transistor, 2N3394
U401	Integrated Circuit, MC3401P
CR400	Silicon Diode, 1N4148
CR401	Silicon Diode, 1N4148
CR402	Silicon Diode, 1N4148
R401	Resistor, Carbon Comp., 1 Meg 10%, 1/4 W
R402	Resistor, Variable, Carbon, 50 K
R403	Resistor, Carbon Comp., 100 K 10%, 1/4 W
R404	Resistor, Carbon Comp., 68 K 10%, 1/4 W
R405	Resistor, Carbon Comp., 220 K 10%, 1/4 W
R406	Resistor, Carbon Comp., 10 K 10%, 1/4 W
R407	Resistor, Carbon Comp., 1 Meg 10%, 1/4 W
R408	Resistor, Carbon Comp., 1 Meg 10%, 1/4 W
R409	Resistor, Carbon Comp., 1 Meg 10%, 1/4 W
R410	Resistor, Carbon Comp., 10 K 10%, 1/4 W
R411	Resistor, Carbon Comp., 22 K 10%, 1/4 W
R412	Resistor, Carbon Comp., 22 K 10%, 1/4 W
R413	Resistor, Carbon Comp., 68 K 10%, 1/4 W
R414	Resistor, Carbon Comp., 1 Meg 10%, 1/4 W
R415	Resistor, Carbon Comp., 1 Meg 10%, 1/4 W
R416	Resistor, Carbon Comp., 1 Meg 10%, 1/4 W
R417	Resistor, Carbon Comp., 10 K 10%, 1/4 W
R418	Resistor, Carbon Comp., 680 Ohm 10%, 1/4 W
R419	Resistor, Carbon Comp., 330 Ohm 10%, 1/2 W
C401	Capacitor, Ceramic Disc, .01 uf 20%, Z5U
C402	Capacitor, Tantalum, 10 uf 20%, 35 V
C403	Capacitor, Ceramic Disc, .01 uf 20%, Z5U
C404	Capacitor, Ceramic Disc, .01 uf 20%, Z5U
C405	Capacitor, Ceramic Disc, .01 uf 20%, Z5U
C406	Capacitor, Tantalum, 10 uf 20%, 35 V
C407	Capacitor, Tantalum, 1 uf 20%, 35 V
C408	Capacitor, Ceramic Disc, .01 uf 20%, Z5U
C409	Capacitor, Ceramic Disc, .01 uf 20%, Z5U



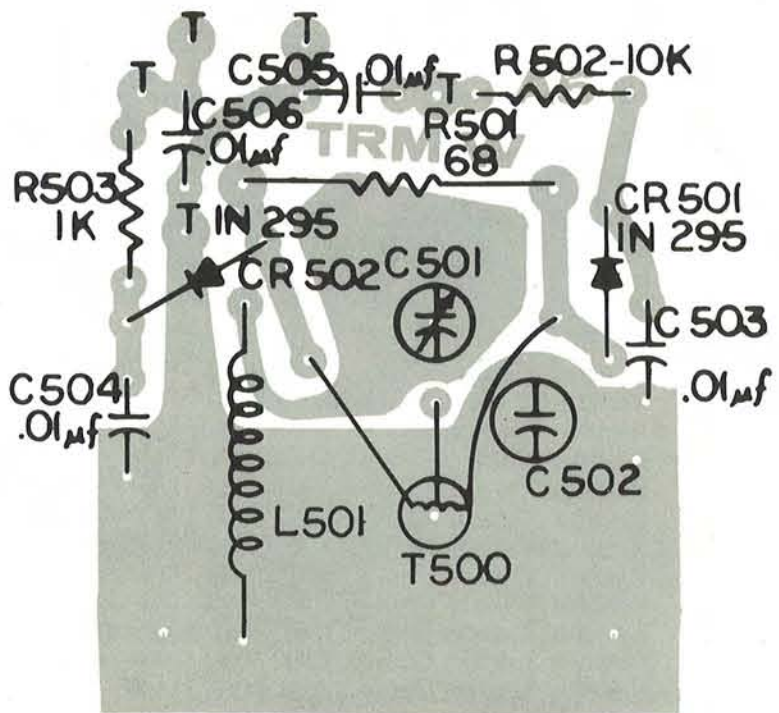

Figure 5-8. Power Detector Board (A5)

Figure 5-8. Parts List

REF DES	DESCRIPTION
R501	Resistor, Metal Film, 68 Ohm 5%, 2 W
R502	Resistor, Carbon Comp., 10 K 10%, 1/4 W
R503	Resistor, Carbon Comp., 1 K 10%, 1/4 W
C501	Capacitor, Piston Trimmer 3-8 pf
C502	Capacitor, Ceramic, 200 pf 5%
C503	Capacitor, Ceramic Disc, .01 uf 20%, Z5U
C504	Capacitor, Ceramic Disc, .01 uf 20%, Z5U
C505	Capacitor, Ceramic Disc, .01 uf 20%, Z5U
C506	Capacitor, Ceramic Disc, .01 uf 20%, Z5U
CR501	Diode, Germanium, 1N295
CR502	Diode, Germanium, 1N295
L501	RF Choke, 440 uH, Part No. R. L. Drake B-2648-E-13
T500	Toroid Transformer, Part No. R. L. Drake A-2733-E



Figure 5-9. Parts List

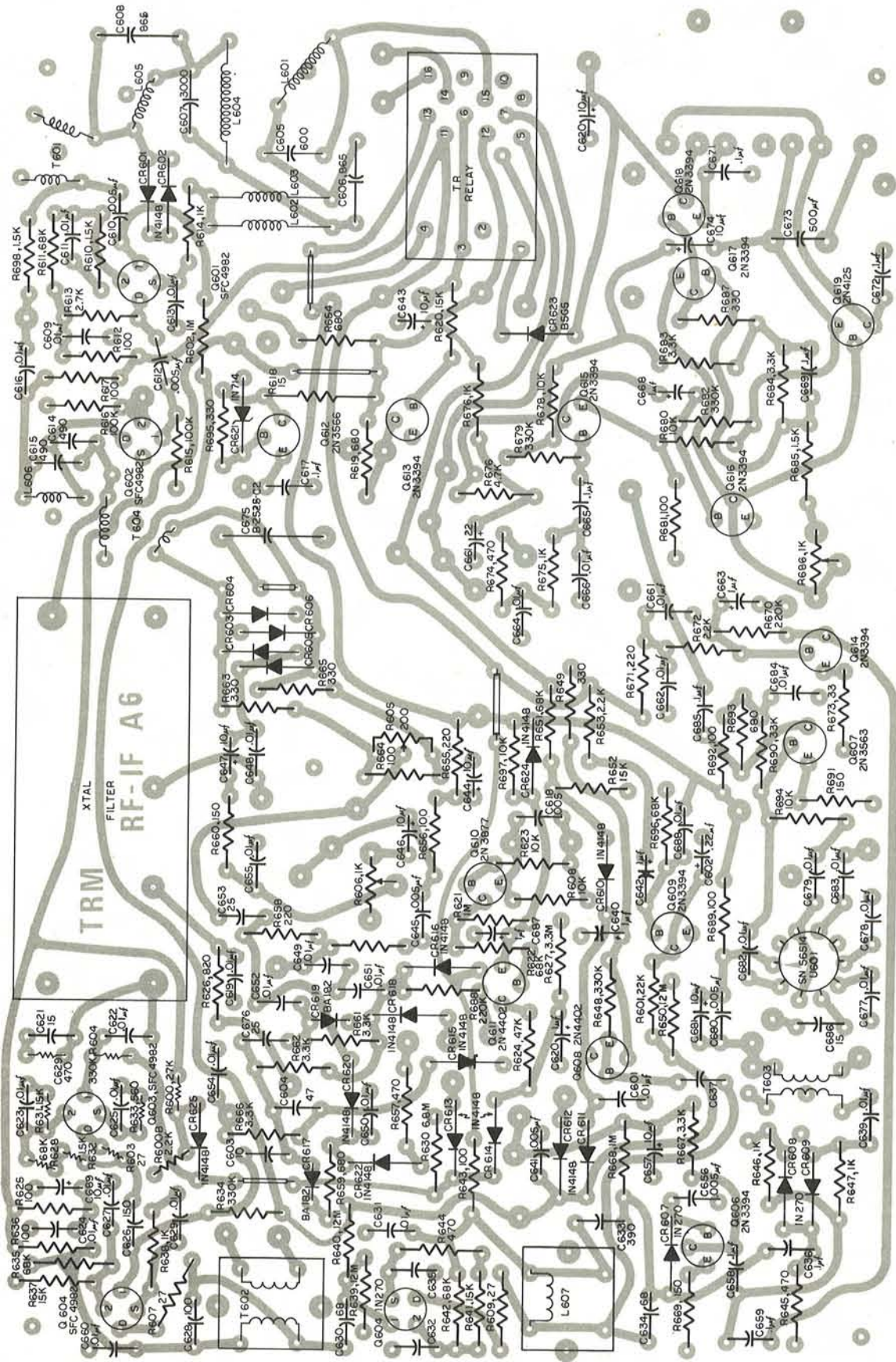

Figure 5-9. RF-IF Board (A6)

REF DES	DESCRIPTION
R600	Resistor, Carbon Comp., 27 K 10%, 1/4 W
R600A	Resistor, Carbon Comp., 2.2 K 10%, 1/4 W
R601	Resistor, Carbon Comp., 22 K 10%, 1/4 W
R602	Resistor, Carbon Comp., 1 Meg 10%, 1/4 W
R603	Resistor, Carbon Comp., 27 Ohm 10%, 1/4 W
R604	Resistor, Carbon Comp., 330 K 10%, 1/4 W
R605	Resistor, Variable, 200 Ohm, (CTS 360T201B)
R606	Resistor, Variable, 1 K (R. L. Drake RA-3643)
R607	Resistor, Carbon Comp., 27 Ohm 10%, 1/4 W
R608	Resistor, Carbon Comp., 10 K 10%, 1/4 W
R609	Resistor, Carbon Comp., 27 Ohm 10%, 1/4 W
R610	Resistor, Carbon Comp., 15 K 10%, 1/4 W
R611	Resistor, Carbon Comp., 68 K 10%, 1/4 W
R612	Resistor, Carbon Comp., 100 Ohm 10%, 1/4 W
R613	Resistor, Carbon Comp., 2.7 K 10%, 1/4 W
R614	Resistor, Carbon Comp., 1 K 10%, 1/4 W
R615	Resistor, Carbon Comp., 100 K 10%, 1/4 W
R616	Resistor, Carbon Comp., 100 Ohm 10%, 1/4 W
R617	Resistor, Carbon Comp., 100 Ohm 10%, 1/4 W
R618	Resistor, Carbon Comp., 15 Ohm 10%, 1/2 W
R619	Resistor, Carbon Comp., 680 Ohm 10%, 1/4 W
R620	Resistor, Carbon Comp., 15 K 10%, 1/4 W
R621	Resistor, Carbon Comp., 1 Meg 10%, 1/4 W
R622	Resistor, Carbon Comp., 68 K 10%, 1/4 W
R623	Resistor, Carbon Comp., 10 K 10%, 1/4 W
R624	Resistor, Carbon Comp., 47 K 10%, 1/4 W
R625	Resistor, Carbon Comp., 100 Ohm 10%, 1/4 W
R626	Resistor, Carbon Comp., 220 Ohm 10%, 1/4 W
R627	Resistor, Carbon Comp., 3.3 Meg 10%, 1/4 W
R628	Resistor, Carbon Comp., 68 K 10%, 1/4 W
R629	Resistor, Carbon Comp., 470 Ohm 10%, 1/4 W
R630	Resistor, Carbon Comp., 6.8 Meg 10%, 1/4 W
R631	Resistor, Carbon Comp., 15 K 10%, 1/4 W
R632	Resistor, Carbon Comp., 1.5 K 10%, 1/4 W
R633	Resistor, Carbon Comp., 560 Ohm 10%, 1/4 W
R634	Resistor, Carbon Comp., 330 K 10%, 1/4 W
R635	Resistor, Carbon Comp., 68 K 10%, 1/4 W
R636	Resistor, Carbon Comp., 100 Ohm 10%, 1/4 W
R637	Resistor, Carbon Comp., 15 K 10%, 1/4 W
R638	Resistor, Carbon Comp., 1 K 10%, 1/4 W
R639	Resistor, Carbon Comp., 12 Meg 10%, 1/4 W
R640	Resistor, Carbon Comp., 12 Meg 10%, 1/4 W
R641	Resistor, Carbon Comp., 15 K 10%, 1/4 W
R642	Resistor, Carbon Comp., 68 K 10%, 1/4 W
R643	Resistor, Carbon Comp., 100 Ohm 10%, 1/4 W
R644	Resistor, Carbon Comp., 470 Ohm 10%, 1/4 W
R645	Resistor, Carbon Comp., 470 Ohm 10%, 1/4 W
R646	Resistor, Carbon Comp., 1 K 10%, 1/4 W
R647	Resistor, Carbon Comp., 1 K 10%, 1/4 W
R648	Resistor, Carbon Comp., 330 K 10%, 1/4 W
R649	Resistor, Carbon Comp., 330 Ohm 10%, 1/4 W
R650	Resistor, Carbon Comp., 12 Meg 10%, 1/4 W
R651	Resistor, Carbon Comp., 68 K 10%, 1/4 W
R652	Resistor, Carbon Comp., 15 K 10%, 1/4 W
R653	Resistor, Carbon Comp., 2.2 K 10%, 1/4 W





Figure 5-9. Parts List (continued)

REF DES	DESCRIPTION
R654	Resistor, Carbon Comp., 680 Ohm 10%, 1/4 W
R655	Resistor, Carbon Comp., 220 Ohm 10%, 1/4 W
R656	Resistor, Carbon Comp., 100 Ohm 10%, 1/4 W
R657	Resistor, Carbon Comp., 470 Ohm 10%, 1/4 W
R658	Resistor, Carbon Comp., 220 Ohm 10%, 1/4 W
R659	Resistor, Carbon Comp., 680 Ohm 10%, 1/4 W
R660	Resistor, Carbon Comp., 150 Ohm 10%, 1/4 W
R661	Resistor, Carbon Comp., 3.3 K 10%, 1/4 W
R662	Resistor, Carbon Comp., 3.3 K 10%, 1/4 W
R663	Resistor, Carbon Comp., 330 Ohm 10%, 1/4 W
R664	Resistor, Carbon Comp., 100 Ohm 10%, 1/4 W
R665	Resistor, Carbon Comp., 330 Ohm 10%, 1/4 W
R666	Resistor, Carbon Comp., 3.3 K 10%, 1/4 W
R667	Resistor, Carbon Comp., 3.3 K 10%, 1/4 W
R668	Resistor, Carbon Comp., 1 Meg 10%, 1/4 W
R669	Resistor, Carbon Comp., 150 Ohm 10%, 1/4 W
R670	Resistor, Carbon Comp., 220 K 10%, 1/4 W
R671	Resistor, Carbon Comp., 220 Ohm 10%, 1/4 W
R672	Resistor, Carbon Comp., 2.2 K 10%, 1/4 W
R673	Resistor, Carbon Comp., 68 Ohm 10%, 1/4 W
R674	Resistor, Carbon Comp., 470 Ohm 10%, 1/4 W
R675	Resistor, Carbon Comp., 1 K 10%, 1/4 W
R676	Resistor, Carbon Comp., 1 K 10%, 1/4 W
R677	Resistor, Carbon Comp., 4.7 K 10%, 1/4 W
R678	Resistor, Carbon Comp., 10 K 10%, 1/4 W
R679	Resistor, Carbon Comp., 330 K 10%, 1/4 W
R680	Resistor, Carbon Comp., 10 K 10%, 1/4 W
R681	Resistor, Carbon Comp., 100 Ohm 10%, 1/4 W
R682	Resistor, Carbon Comp., 330 K 10%, 1/4 W
R683	Resistor, Carbon Comp., 3.3 K 10%, 1/4 W
R684	Resistor, Carbon Comp., 3.3 K 10%, 1/4 W
R685	Resistor, Carbon Comp., 1.5 K 10%, 1/4 W
R686	Resistor, Variable, 1 K. Part No. R. L. Drake RA-4633
R687	Resistor, Carbon Comp., 330 Ohm 10%, 1/4 W
R688	Resistor, Carbon Comp., 220 K 10%, 1/4 W
R689	Resistor, Carbon Comp., 100 Ohm 10%, 1/4 W
R690	Resistor, Carbon Comp., 33 K 10%, 1/4 W
R691	Resistor, Carbon Comp., 10 K 10%, 1/4 W
R692	Resistor, Carbon Comp., 100 Ohm 10%, 1/4 W
R693	Resistor, Carbon Comp., 680 Ohm 10%, 1/4 W
R694	Resistor, Carbon Comp., 150 Ohm 10%, 1/4 W
R695	Resistor, Carbon Comp., 330 Ohm 10%, 1/4 W
R696	Resistor, Carbon Comp., 68 K 10%, 1/4 W
R697	Resistor, Carbon Comp., 10 K 10%, 1/4 W
R698	Resistor, Carbon Comp., 1.5 K 10%, 1/4 W
R699	Resistor, Carbon Comp., 15 K 10%, 1/4 W
C601	Capacitor, Ceramic Disc, .01 uf, + 80 -20%, 25 V
C602	Capacitor, Tubular, .22 uf 10%, 80 VDC
C603	Capacitor, Ceramic Disc, 10 pf 5%, NPO
C604	Capacitor, Ceramic Disc, 47 pf 5%, NPO
C605	Capacitor, Mica, 600 pf 5%, DM-19
C606	Capacitor, Mica, 865 pf 5%, DM-20
C607	Capacitor, Mica, 3000 pf 5%, DM-19
C608	Capacitor, Mica, 210 pf 5%, DM-15
C609	Capacitor, Ceramic Disc, .01 uf, + 80 -20%, 25 V
C610	Capacitor, Ceramic Disc, .005 uf 20%, Z5U
C611	Capacitor, Ceramic Disc, .01 uf, + 80 -20%, 25 V
C612	Capacitor, Ceramic Disc, .005 uf 20%, Z5U
C613	Capacitor, Ceramic Disc, .01 uf, + 80 -20%, 25 V

Figure 5-9. Parts List (continued)

REF DES	DESCRIPTION
C614	Capacitor, Mica, 490 pf 5%, DM-15
C615	Capacitor, Mica 490 pf 5%, DM-15
C616	Capacitor, Ceramic Disc, .01 uf, + 80 -20%, 25 V
C617	Capacitor, Ceramic Disc, .1 uf, + 80 -20%, 12 V
C618	Capacitor, Ceramic Disc, .005 uf 20%, Z5U
C619	Capacitor, Ceramic Disc, .01 uf, + 80 -20%, 25 V
C620	Capacitor, Tantalum, 1 uf 20%, 35 V
C621	Capacitor, Ceramic Disc, 15 pf 5%, NPO
C622	Capacitor, Ceramic Disc, .001 uf 20%, Z5U
C623	Capacitor, Ceramic Disc, .01 uf, + 80 -20%, 25 V
C624	Capacitor, Tantalum, 1 uf 20%, 35 VDC
C625	Capacitor, Ceramic Disc, .01 uf, + 80 -20%, 25 V
C626	Capacitor, Ceramic Disc, 150 pf 20%, Z5U
C627	Capacitor, Ceramic Disc, .01 uf, + 80 -20%, 25 V
C628	Capacitor, Mica, 100 pf 5%, DM-15
C629	Capacitor, Ceramic Disc, .01 uf, + 80 -20%, 25 V
C630	Capacitor, Mica, 68 pf 5%, DM-15
C631	Capacitor, Ceramic Disc, .01 uf, + 80 -20%, 25 V
C632	Capacitor, Ceramic Disc, .01 uf, + 80 -20%, 25 V
C633	Capacitor, Mica, 390 pf 5%, DM-15
C634	Capacitor, Mica, 68 pf 5%, DM-15
C635	Capacitor, Ceramic Disc, .01 uf, + 80 -20%, 25 V
C636	Capacitor, Ceramic Disc, .1 uf, + 80 -20%, 12 V
C637	Capacitor, Mica, 300 pf 5%, DM-15
C638	Capacitor, Ceramic Disc, .01 uf, + 80 -20%, 25 V
C639	Capacitor, Ceramic Disc, .01 uf, + 80 -20%, 25 V
C640	Capacitor, Tantalum, 1 uf 20%, 35 VDC
C641	Capacitor, Ceramic Disc, .005 uf 20%, Z5U
C642	Capacitor, Ceramic Disc, .01 uf, + 80 -20%, 25 V
C643	Capacitor, Tantalum, 10 uf 20%, 25 VDC
C644	Capacitor, Tantalum, 10 uf 20%, 25 VDC
C645	Capacitor, Ceramic Disc, .005 uf 20%, Z5U
C646	Capacitor, Tantalum, 10 uf 20%, 25 VDC
C647	Capacitor, Tantalum, 10 uf 20%, 25 VDC
C648	Capacitor, Ceramic Disc, .01 uf, + 80 -20%, 25 V
C649	Capacitor, Ceramic Disc, .01 uf, + 80 -20%, 25 V
C650	Capacitor, Ceramic Disc, .01 uf, + 80 -20%, 25 V
C651	Capacitor, Ceramic Disc, .01 uf, + 80 -20%, 25 V
C652	Capacitor, Ceramic Disc, .01 uf, + 80 -20%, 25 V
C653	Capacitor, Ceramic Disc, 25 pf 5%, NPO
C654	Capacitor, Ceramic Disc, .01 uf, + 80 -20%, 25 V
C655	Capacitor, Ceramic Disc, .01 uf, + 80 -20%, 25 V
C656	Capacitor, Ceramic Disc, .005 uf 20%, Z5U
C657	Capacitor, Tantalum, 10 uf 20%, 25 VDC
C658	Capacitor, Ceramic Disc, .1 uf, + 80 -20%, 12 V
C659	Capacitor, Ceramic Disc, .1 uf, + 80 -20%, 12 V
C660	Capacitor, Ceramic Disc, .01 uf, + 80 -20%, 25 V
C661	Capacitor, Ceramic Disc, .01 uf, + 80 -20%, 25 V
C662	Capacitor, Tantalum, 10 uf 20%, 25 VDC
C663	Capacitor, Tantalum, 1 uf 20%, 35 VDC
C664	Capacitor, Ceramic Disc, .01 uf, + 80 -20%, 25 V
C665	Capacitor, Ceramic Disc, .1 uf, + 80 -20%, 12 V
C666	Capacitor, Ceramic Disc, .01 uf, + 80 -20%, 25 V
C667	Capacitor, Tantalum, 22 uf 20%, 15 VDC
C668	Capacitor, Tantalum, 1 uf 20%, 35 VDC
C669	Capacitor, Ceramic Disc, 0.1 uf, + 80 -20%, 12 V



Figure 5-9. Parts List (continued)

REF DES	DESCRIPTION
C670	Capacitor, Tantalum, 10 uf 20%, 25 VDC
C671	Capacitor, Ceramic Disc, .1 uf, + 80 -20%, 12 V
C672	Capacitor, Ceramic Disc, .1 uf, + 80 -20%, 12 V
C673	Capacitor, Electrolytic, 680 uf 20%, 25 VDC
C674	Capacitor, Tantalum, 10 uf 20%, 25 VDC
C675	Capacitor, Trimmer, (R. L. Drake B-2525-C2)
C676	Capacitor, Ceramic Disc, 25 pf 5%, NPO
C677	Capacitor, Ceramic Disc, .01 uf, + 80 -20%, 25 V
C678	Capacitor, Ceramic Disc, .01 uf, + 80 -20%, 25 V
C679	Capacitor, Ceramic Disc, .01 uf, + 80 -20%, 25 V
C680	Capacitor, Ceramic Disc, .005 uf 20%, Z5U
C681	Capacitor, Tantalum, 10 uf 20%, 25 VDC
C682	Capacitor, Ceramic Disc, .01 uf, + 80 -20%, 25 V
C683	Capacitor, Ceramic Disc, .01 uf, + 80 -20%, 25 V
C684	Capacitor, Ceramic Disc, .01 uf, + 80 -20%, 25 V
C685	Capacitor, Ceramic Disc, .1 uf, + 80 -20%, 12 V
C686	Capacitor, Ceramic Disc, 15 pf 5%, NPO
C687	Capacitor, Tantalum, 10 uf 20%, 35 VDC
C688	Capacitor, Ceramic Disc, .01 uf + 80 -20%, 25 VDC
C689	Capacitor, Tantalum, 10 uf 20%, 25 VDC
C690	Capacitor, Ceramic Disc, .01 uf + 80 -20%, 25 V
C691	Capacitor, Ceramic Disc, .005 uf 20%, Z5U
C692	Capacitor, Ceramic Disc, .001 uf 20%, Z5U
L601	Inductor, Variable, 7-1/2 turns, SK-308
L602	Inductor, Fixed, (R. L. Drake B-2648-2)
L603	Inductor, Fixed, (R. L. Drake B-2648-2)
L604	Inductor, Fixed, (R. L. Drake B-2648-1)
L605	Inductor, Variable, 18 1/3 turns, SK-304-1
L606	Inductor, Variable, 18 1/3 turns, SK-304-1
L607	Inductor, Variable, (R. L. Drake B-2632-2)
Q601	Transistor, SFC4982/MFE535
Q602	Transistor, SFC4982/MFE535
Q603	Transistor, SFC4982/MFE535
Q604	Transistor, SFC4982/MFE535
Q605	Transistor, SFC4982/MFE535
Q606	Transistor, 2N3394
Q607	Transistor, 2N3563
Q608	Transistor, 2N4402
Q609	Transistor, 2N3394
Q610	Transistor, 2N3877
Q611	Transistor, 2N4402
Q612	Transistor, 2N3566
Q613	Transistor, 2N3394
Q614	Transistor, 2N3394
Q615	Transistor, 2N3394
Q616	Transistor, 2N3394
Q617	Transistor, 2N3394
Q618	Transistor, 2N3394
Q619	Transistor, 2N4125
Q620	Transistor, EP487
Q621	Transistor, EP487
U601	Integrated Circuit, SN56514
K601	Relay (VP4CAB/12)

Figure 5-9. Parts List (continued)

REF DES	DESCRIPTION
T601	Transformer, Toroid, (R. L. Drake A-2649-E)
T602	Transformer, Variable, (R. L. Drake B-2632-E-1)
T603	Transformer, Toroid, (R. L. Drake A-2651-E)
T604	Transformer, Toroid, (R. L. Drake A-2650-E)
CR601	Diode, 1N4148
CR602	Diode, 1N4148
CR603	Diode, 1N541
CR604	Diode, 1N541
CR605	Diode, 1N541
CR606	Diode, 1N541
CR607	Diode, 1N270
CR608	Diode, 1N270
CR609	Diode, 1N270
CR610	Diode, 1N4148
CR611	Diode, 1N4148
CR612	Diode, 1N4148
CR613	Diode, 1N4148
CR614	Diode, 1N4148
CR615	Diode, 1N4148
CR616	Diode, 1N4148
CR617	Diode, BA182
CR618	Diode, 1N4148
CR619	Diode, BA182
CR620	Diode, 1N4148
CR621	Diode, Zener, 1N714
CR622	Diode, 1N4148
CR623	Diode, B5G5
CR624	Diode, 1N4148



Figure 5-10. Parts List

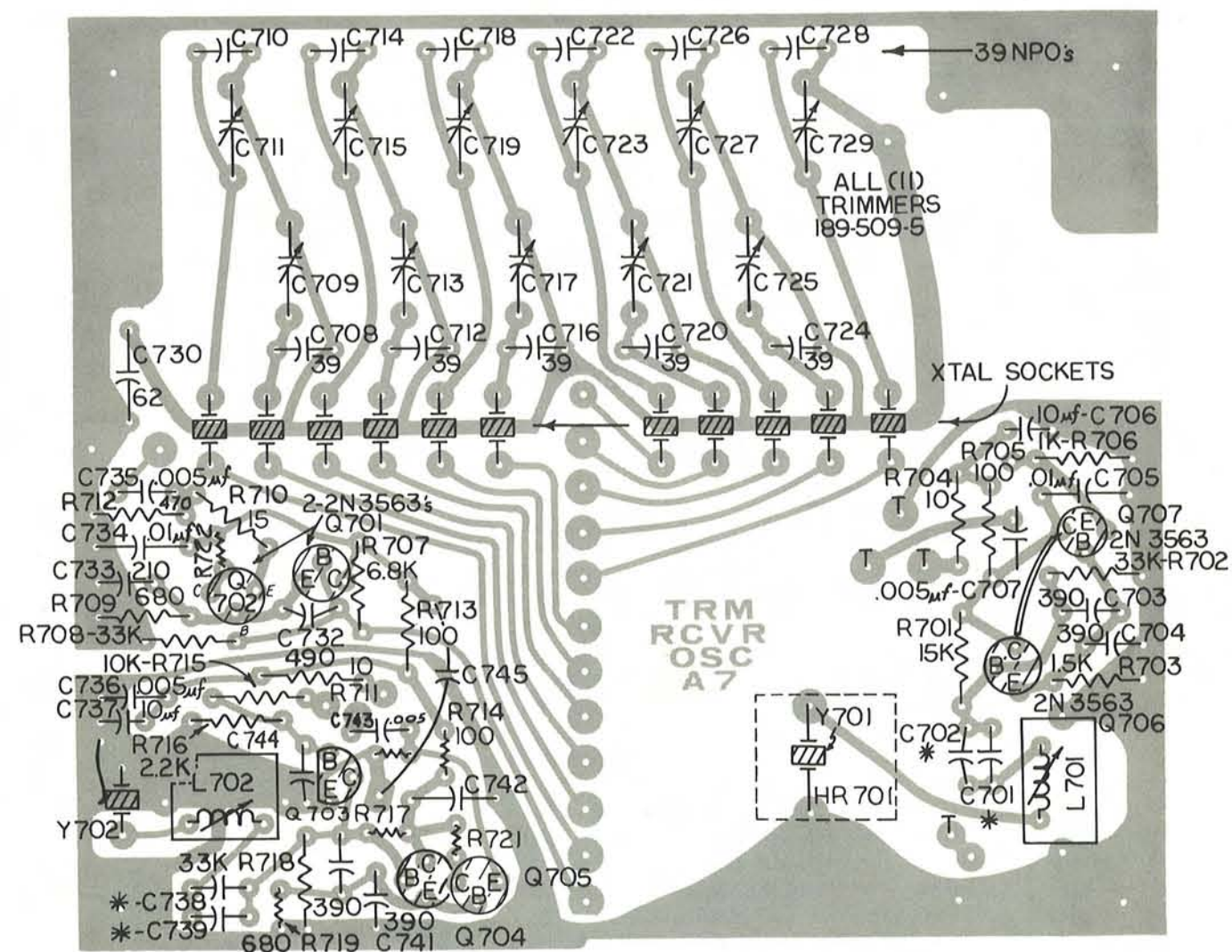

Figure 5-10. Receive Oscillator Board (A7)

REF DES	DESCRIPTION
Q701	Transistor, 2N3563
Q702	Transistor, 2N3563
Q703	Transistor, 2N3394
Q704	Transistor, 2N3563
Q705	Transistor, 2N3563
Q706	Transistor, 2N3563
Q707	Transistor, 2N3563
C701	Capacitor, Disc, (Selected)
C702	Capacitor, Tubular, (Selected)
C703	Capacitor, Mica, 390 pf 5%, DM-15
C704	Capacitor, Mica, 390 pf 5%, DM-15
C705	Capacitor, Disc, .01 uf 20%, Z5U
C706	Capacitor, Tantalum, 10 uf, 25 V
C707	Capacitor, Disc, .005 uf 20%, Z5U
C708	Capacitor, Disc, 39 pf 5%, NPO
C709	Capacitor, Variable, 2.4-24.5 pf (EFJ 189-509-5)
C710	Capacitor, Disc, 39 pf 5%, NPO
C711	Capacitor, Variable, 2.4-24.5 pf (EFJ 189-509-5)
C712	Capacitor, Disc, 39 pf 5%, NPO
C713	Capacitor, Variable, 2.4-24.5 pf (EFJ 189-509-5)
C714	Capacitor, Disc, 39 pf 5%, NPO
C715	Capacitor, Variable, 2.4-24.5 pf (EFJ 189-509-5)
C716	Capacitor, Disc, 39 pf 5%, NPO
C717	Capacitor, Variable, 2.4-24.5 pf (EFJ 189-509-5)
C718	Capacitor, Disc, 39 pf 5%, NPO
C719	Capacitor, Variable, 2.4-24.5 pf (EFJ 189-509-5)
C720	Capacitor, Disc, 39 pf 5%, NPO
C721	Capacitor, Variable, 2.4-24.5 pf (EFJ 189-509-5)
C722	Capacitor, Disc, 39 pf 5%, NPO
C723	Capacitor, Variable, 2.4-24.5 pf (EFJ 189-509-5)
C724	Capacitor, Disc, 39 pf 5%, NPO
C725	Capacitor, Variable, 2.4-24.5 pf (EFJ 189-509-5)
C726	Capacitor, Disc, 39 pf 5%, NPO
C727	Capacitor, Variable, 2.4-24.5 pf (EFJ 189-509-5)
C728	Capacitor, Disc, 39 pf 5%, NPO
C729	Capacitor, Variable, 2.4-24.5 pf (EFJ 189-509-5)
C730	Capacitor, Disc, 62 pf 5%, NPO
C731	Not Used
C732	Capacitor, Mica, 490 pf 5%, DM-15
C733	Capacitor, Mica, 210 pf 5%, DM-15
C734	Capacitor, Disc, .01 uf 20%, Z5U
C735	Capacitor, Disc, 68 pf 5%, N750
C736	Capacitor, Disc, .005 uf 20%, Z5U
C737	Capacitor, Tantalum, 10 uf 20%, 25 V
C738	Capacitor, Disc, (Selected)
C739	Capacitor, Tubular, (Selected)
C740	Capacitor, Mica, 390 pf 5%, DM-15
C741	Capacitor, Mica, 390 pf 5%, DM-15
C742	Capacitor, Disc, .01 uf 20%, Z5U
C743	Capacitor, Disc, .005 uf 20%, Z5U
C744	Capacitor, Disc, .005 uf 20%, Z5U
C745	Capacitor, Tantalum, 1 uf 20%, 25 V
R701	Resistor, Carbon Comp., 15 K 10%, 1/4 W
R702	Resistor, Carbon Comp., 33 K 10%, 1/4 W
R703	Resistor, Carbon Comp., 1.5 K 10%, 1/4 W
R704	Resistor, Carbon Comp., 10 Ohm 10%, 1/4 W



Figure 5-10. Parts List (continued)

REF DES	DESCRIPTION
R705	Resistor, Carbon Comp., 100 Ohm 10%, 1/4 W
R706	Resistor, Carbon Comp., 1 K 10%, 1/4 W
R707	Resistor, Carbon Comp., 6.8 K 10%, 1/4 W
R708	Resistor, Carbon Comp., 33 K 10%, 1/4 W
R709	Resistor, Carbon Comp., 680 Ohm 10%, 1/4 W
R710	Resistor, Carbon Comp., 15 Ohm 10%, 1/4 W
R711	Resistor, Carbon Comp., 10 Ohm 10%, 1/4 W
R712	Resistor, Carbon Comp., 470 Ohm 10%, 1/4 W
R713	Resistor, Carbon Comp., 100 Ohm 10%, 1/4 W
R714	Resistor, Carbon Comp., 100 Ohm 10%, 1/4 W
R715	Resistor, Carbon Comp., 10 K 10%, 1/4 W
R716	Resistor, Carbon Comp., 2.2 K 10%, 1/4 W
R717	Resistor, Carbon Comp., 15 K 10%, 1/4 W
R718	Resistor, Carbon Comp., 33 K 10%, 1/4 W
R719	Resistor, Carbon Comp., 680 Ohm 10%, 1/4 W
R720	Resistor, Carbon Comp., 1.5 K 10%, 1/4 W
R721	Resistor, Carbon Comp., 68 Ohm 10%, 1/4 W
R722	Resistor, Carbon Comp., 68 Ohm 10%, 1/4 W
L701	Inductor, Variable, 18 1/3 Turns (Paul Smith SK-304-1)
L702	Inductor, Variable, 18 1/3 Turns (Paul Smith SK-304-1)
Y701	Crystal, 10.700 MHz, (R. L. Drake A-2689-V)
Y702	Crystal, 10.700 MHz, (R. L. Drake A-2688-V)
HR701	Crystal Oven, Carrier Osc., 12 V, (R. L. Drake A-2723-V-1)
HR701	Crystal Oven, Carrier Osc., 34 V, (R. L. Drake A-2723-V-2)

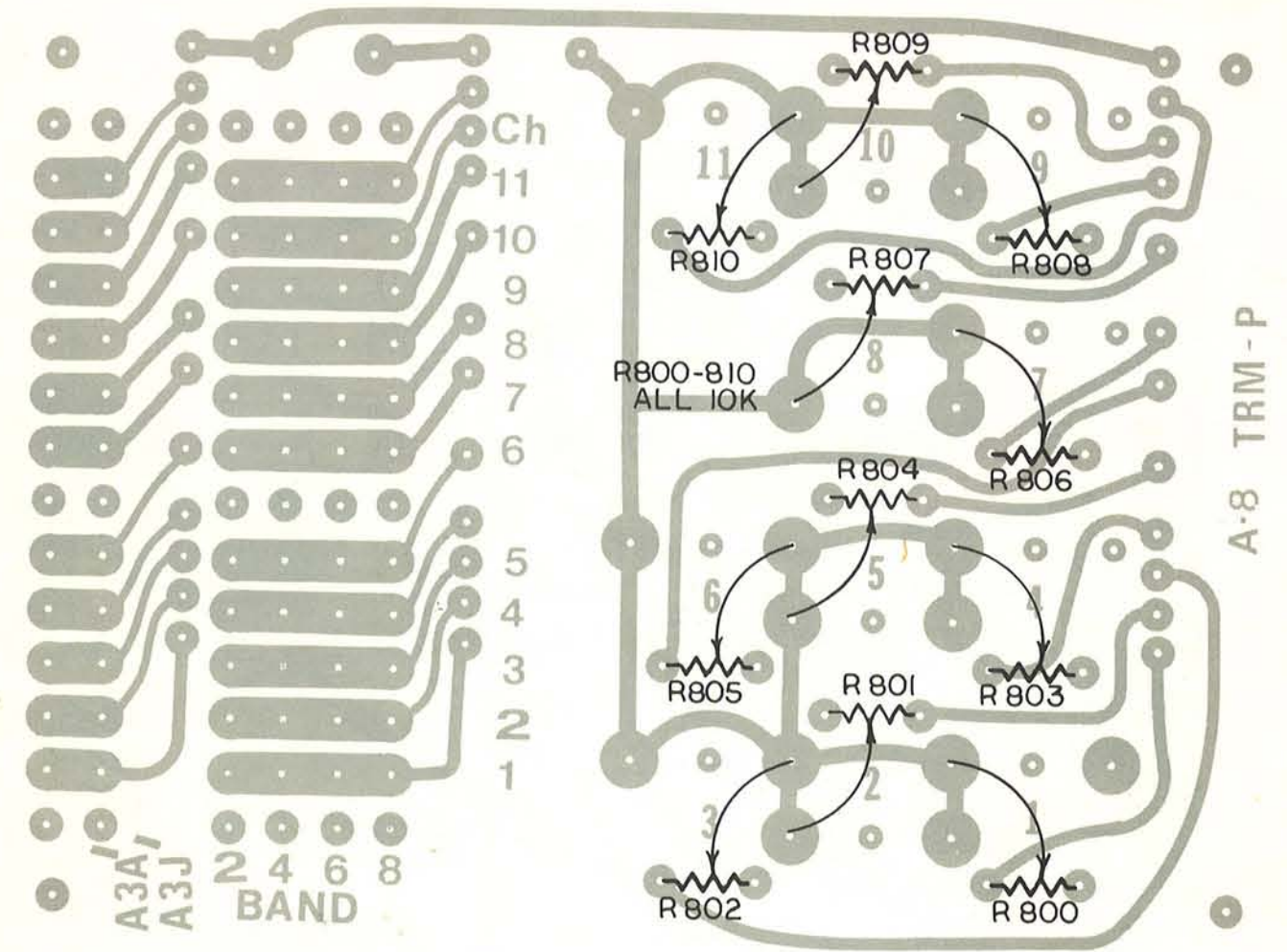

Figure 5-11. Program Board (A8)

REF DES	DESCRIPTION
R800	Resistor, Variable, 10 K (R. L. Drake WF-2395)
R801	Resistor, Variable, 10 K (R. L. Drake WF-2395)
R802	Resistor, Variable, 10 K (R. L. Drake WF-2395)
R803	Resistor, Variable, 10 K (R. L. Drake WF-2395)
R804	Resistor, Variable, 10 K (R. L. Drake WF-2395)
R805	Resistor, Variable, 10 K (R. L. Drake WF-2395)
R806	Resistor, Variable, 10 K (R. L. Drake WF-2395)
R807	Resistor, Variable, 10 K (R. L. Drake WF-2395)
R808	Resistor, Variable, 10 K (R. L. Drake WF-2395)
R809	Resistor, Variable, 10 K (R. L. Drake WF-2395)
R810	Resistor, Variable, 10 K (R. L. Drake WF-2395)



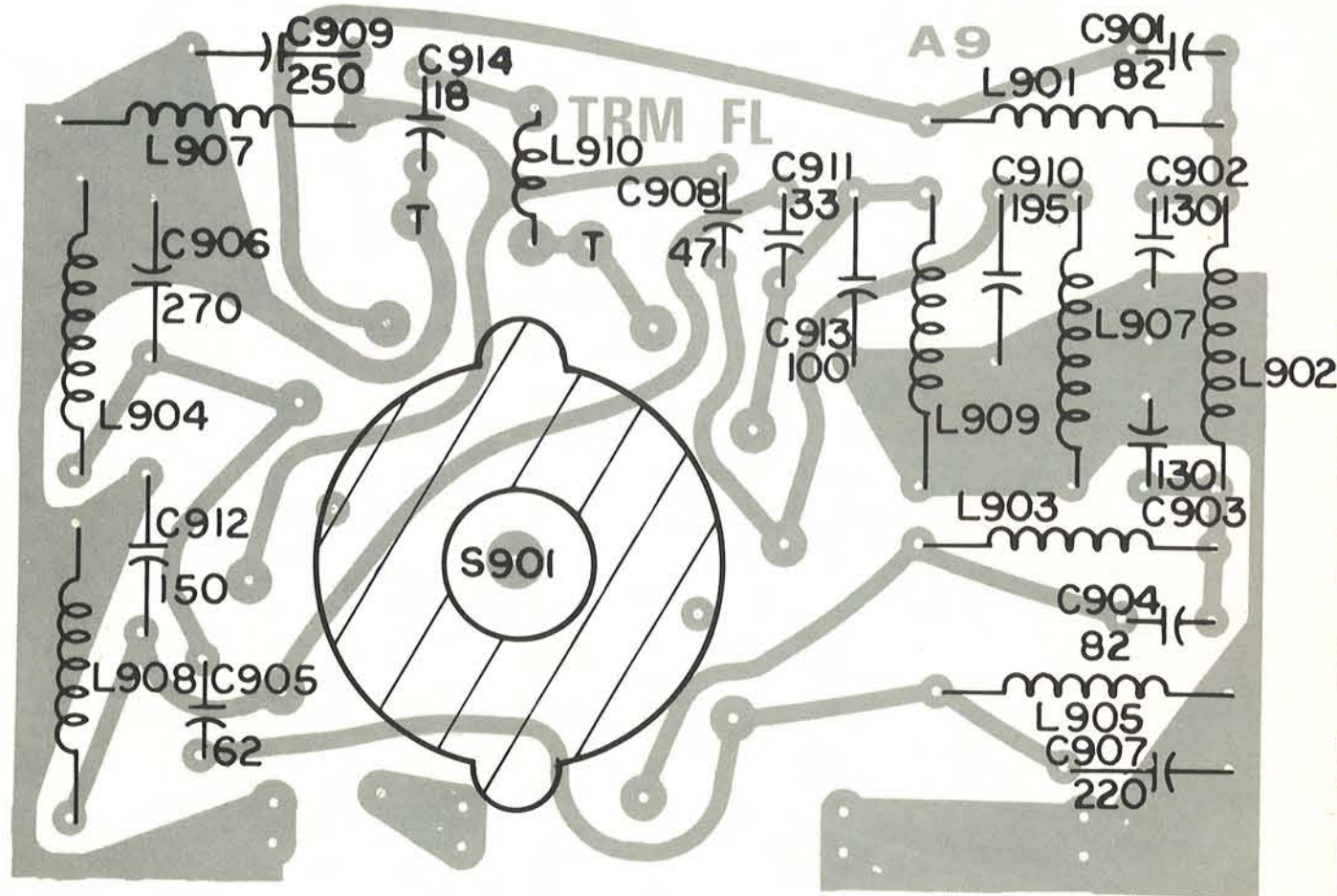

Figure 5-12. IF Filter Board (A9)

Figure 5-12. Parts List

REF DES	DESCRIPTION
L901	Inductor, Fixed (R. L. Drake B-2648-E-3)
L902	Inductor, Fixed (R. L. Drake B-2648-E-4)
L903	Inductor, Fixed (R. L. Drake B-2648-E-3)
L904	Inductor, Fixed (R. L. Drake B-2648-E-1)
L905	Inductor, Fixed (R. L. Drake B-2648-E-1)
L906	Inductor, Fixed (R. L. Drake B-2648-E-5)
L907	Inductor, Fixed (R. L. Drake B-2648-E-5)
L908	Inductor, Fixed (R. L. Drake B-2648-E-6)
L909	Inductor, Fixed (R. L. Drake B-2648-E-6)
L910	Inductor, Variable (R. L. Drake A-2505-L-7)
C901	Capacitor, Ceramic Disc, 82 pf 5%, N750
C902	Capacitor, Mica, 130 pf 5%, DM-15
C903	Capacitor, Mica, 130 pf 5%, DM-15
C904	Capacitor, Ceramic Disc, 82 pf 5%, N750
C905	Capacitor, Ceramic Disc, 62 pf 5%, NPO
C906	Capacitor, Mica, 270 pf 5%, DM-19
C907	Capacitor, Mica, 220 pf 5%, DM-19
C908	Capacitor, Ceramic Disc, 47 pf 5%, NPO
C909	Capacitor, Mica, 250 pf 5%, DM-20
C910	Capacitor, Mica, 195 pf 5%, DM-20
C911	Capacitor, Ceramic Disc, 33 pf 5%, NPO
C912	Capacitor, Mica, 150 pf 5%, DM-15
C913	Capacitor, Mica, 100 pf 5%, DM-20
C914	Capacitor, Ceramic Disc, 18 pf 5%, NPO



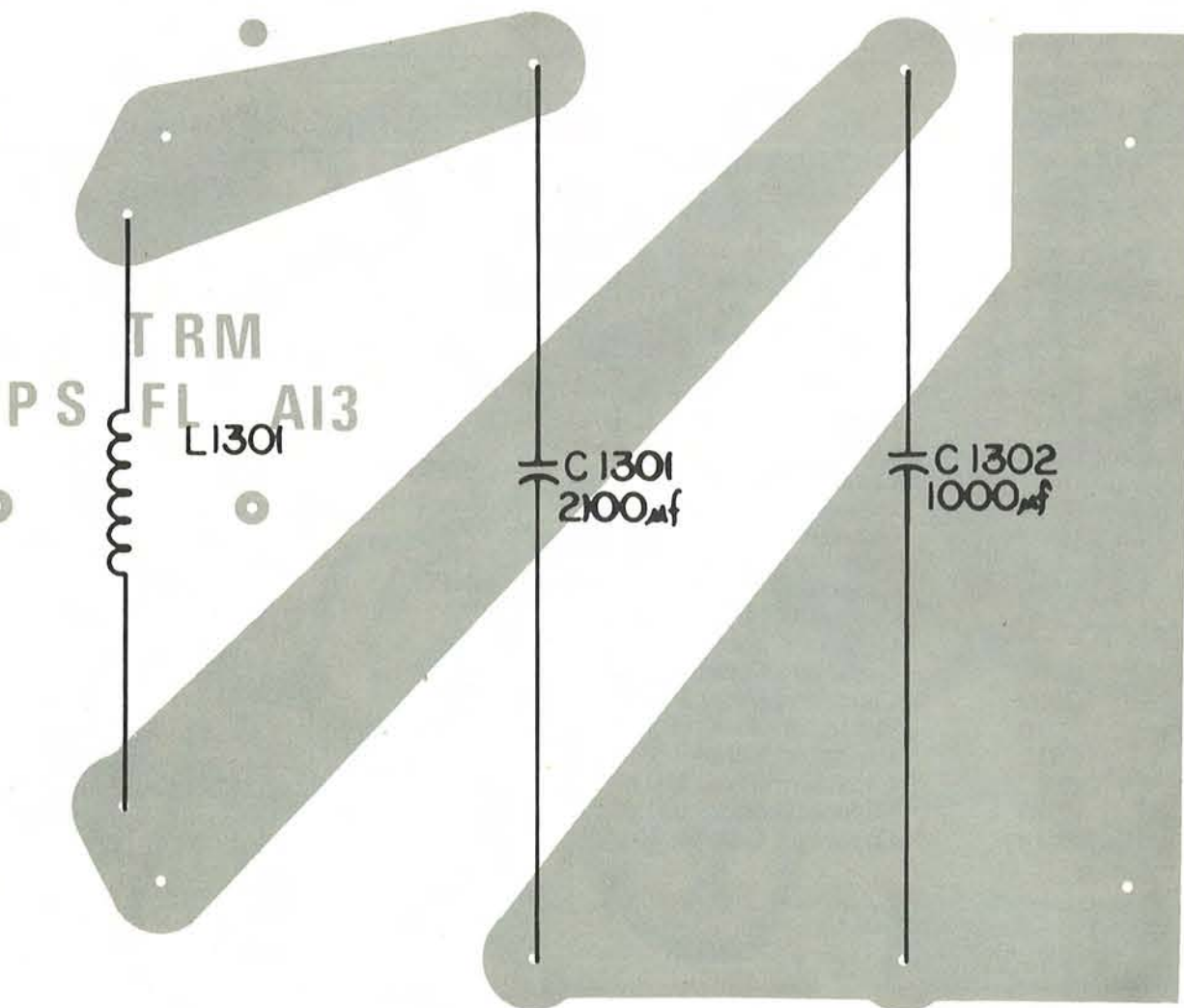

Figure 5-13. Power Supply Filter Board (A13)

REF DES	DESCRIPTION
L1301	Choke, 1.4 mH (R. L. Drake A-2728-E)
C1301	Capacitor, Electrolytic, 2100 uf, 25 V
C1302	Capacitor, Electrolytic, 1000 uf, 25 V

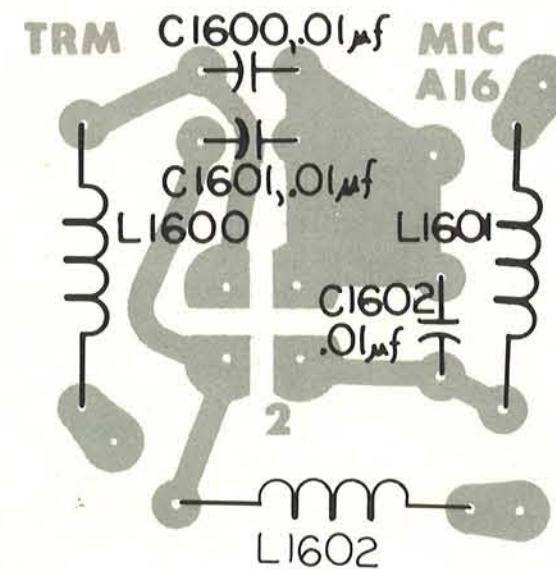

Figure 5-14. Microphone Board (A16)

REF DES	DESCRIPTION
L1600	Inductor, Fixed (R. L. Drake B-2648-16)
L1601	Inductor, Fixed (R. L. Drake B-2648-16)
L1602	Inductor, Fixed (R. L. Drake B-2648-16)
C1600	Capacitor, Ceramic Disc, .01 uf + 80 -20%, 25V
C1601	Capacitor, Ceramic Disc, .01 uf + 80 -20%, 25V
C1602	Capacitor, Ceramic Disc, .01 uf + 80 -20%, 25V



Figure 5-15. Parts List

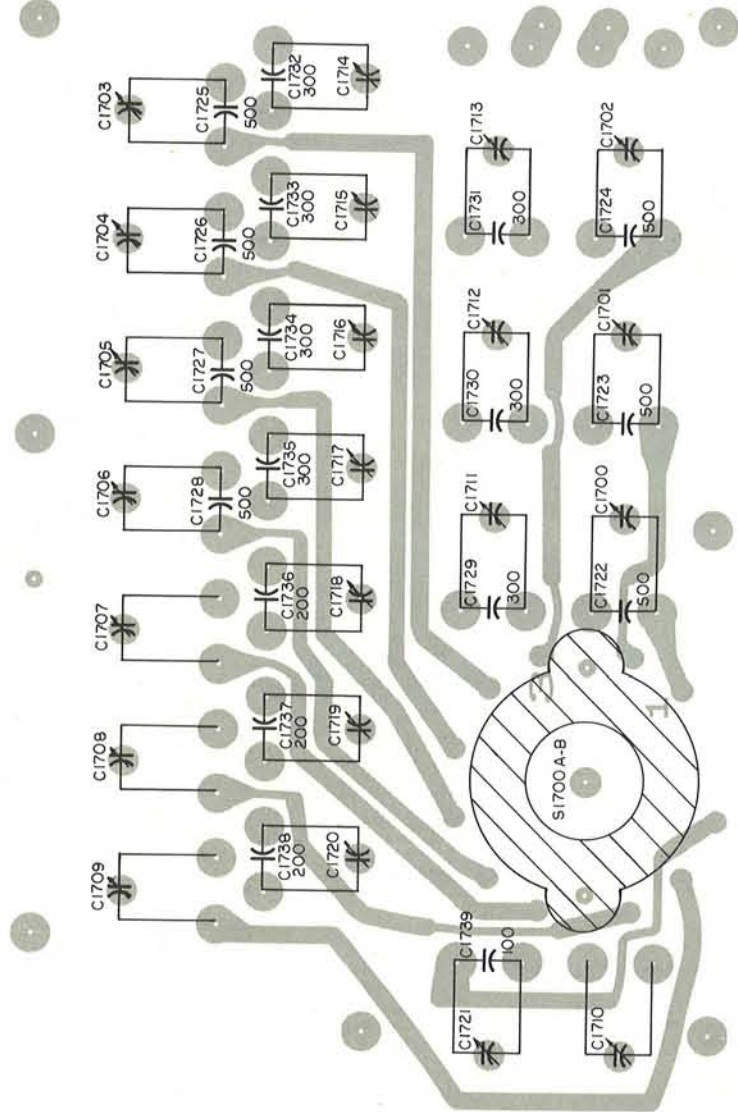

Figure 5-15. Rear Panel Coupler Board (A17)

REF. DES.	DESCRIPTION	CHANNEL
C1700	Capacitor, Variable, 180-690 pf (305)	1A
C1701	Capacitor, Variable, 180-690 pf (305)	2A
C1702	Capacitor, Variable, 180-690 pf (305)	3A
C1703	Capacitor, Variable, 180-690 pf (305)	4A
C1704	Capacitor, Variable, 180-690 pf (305)	5A
C1705	Capacitor, Variable, 180-690 pf (305)	6A
C1706	Capacitor, Variable, 180-690 pf (305)	7A
C1701	Capacitor, Variable, 180-690 pf (305)	8A
C1708	Capacitor, Variable, 180-690 pf (305)	9A
C1709	Capacitor, Variable, 180-690 pf (305)	10A
C1710	Capacitor, Variable, 180-690 pf (305)	11A
C1711	Capacitor, Variable, 340-1070 pf (307)	1B
C1712	Capacitor, Variable, 340-1070 pf (307)	2B
C1713	Capacitor, Variable, 340-1070 pf (307)	3B
C1714	Capacitor, Variable, 340-1070 pf (307)	4B
C1715	Capacitor, Variable, 340-1070 pf (307)	5B
C1716	Capacitor, Variable, 340-1070 pf (307)	6B
C1717	Capacitor, Variable, 340-1070 pf (307)	7B
C1718	Capacitor, Variable, 100-500 pf (304)	8B
C1719	Capacitor, Variable, 100-500 pf (304)	9B
C1720	Capacitor, Variable, 100-500 pf (304)	10B
C1721	Capacitor, Variable, 15-120 pf (302)	11B
C1722	Capacitor, Fixed, 500 pf, DM-20	1A
C1723	Capacitor, Fixed, 500 pf, DM-20	2A
C1724	Capacitor, Fixed, 500 pf, DM-20	3A
C1725	Capacitor, Fixed, 500 pf, DM-20	4A
C1726	Capacitor, Fixed, 500 pf, DM-20	5A
C1727	Capacitor, Fixed, 500 pf, DM-20	6A
C1728	Capacitor, Fixed, 500 pf, DM-20	7A
C1729	Capacitor, Fixed, 300 pf, DM-20	1B
C1730	Capacitor, Fixed, 300 pf, DM-20	2B
C1731	Capacitor, Fixed, 300 pf, DM-20	3B
C1732	Capacitor, Fixed, 300 pf, DM-20	4B
C1733	Capacitor, Fixed, 300 pf, DM-20	5B
C1734	Capacitor, Fixed, 300 pf, DM-20	6B
C1735	Capacitor, Fixed, 300 pf, DM-20	7B
C1736	Capacitor, Fixed, 200 pf, DM-20	8B
C1737	Capacitor, Fixed, 200 pf, DM-20	9B
C1738	Capacitor, Fixed, 200 pf, DM-20	10B
C1739	Capacitor, Fixed, 100 pf, DM-20	11B
S1700	Switch (R. L. Drake A-2623-D)	
S1701	Switch (R. L. Drake A-2623-D)	



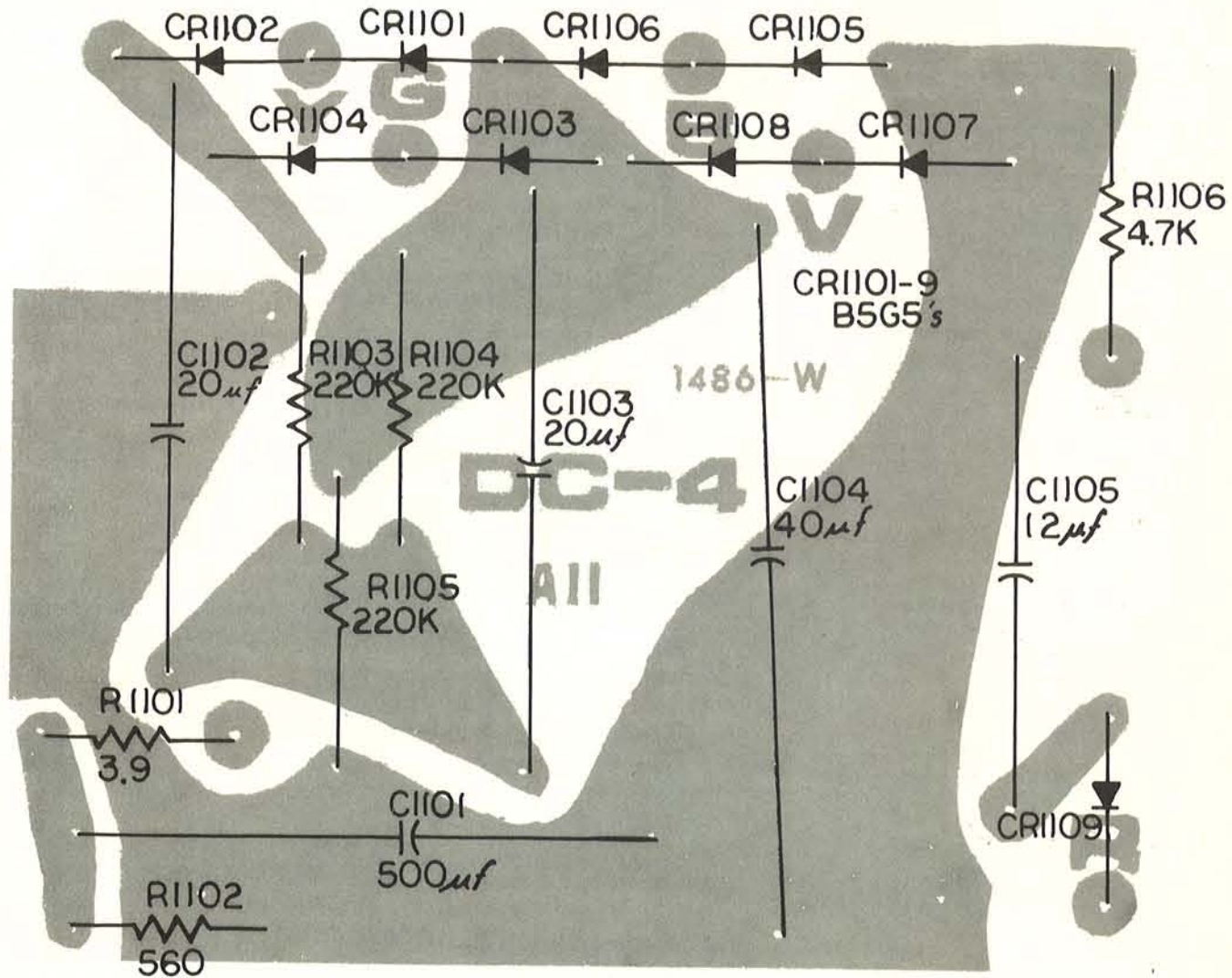

Figure 5-16. 12.9 Volt DC Power Supply Board (A11)

REF DES	DESCRIPTION
R1101	Resistor, Carbon Comp., 3.9 Ohm 5%, 1/2 W
R1102	Resistor, Carbon Comp., 15 Ohm 10%, 1/2 W
R1103	Resistor, Carbon Comp., 220 K 10%, 1 W
R1104	Resistor, Carbon Comp., 220 K 10%, 1 W
R1105	Resistor, Carbon Comp., 220 K 10%, 1 W
R1106	Resistor, Carbon Comp., 4.7 K 10%, 1 W
C1101	Capacitor, Electrolytic, 500 uf 15 V
C1102	Capacitor, Electrolytic, 20 uf 350 V
C1103	Capacitor, Electrolytic, 20 uf 350 V
C1104	Capacitor, Electrolytic, 40 uf 350 V
C1105	Capacitor, Electrolytic, 12 uf 350 V
CR1101 Through CR1109	Diode B5G5

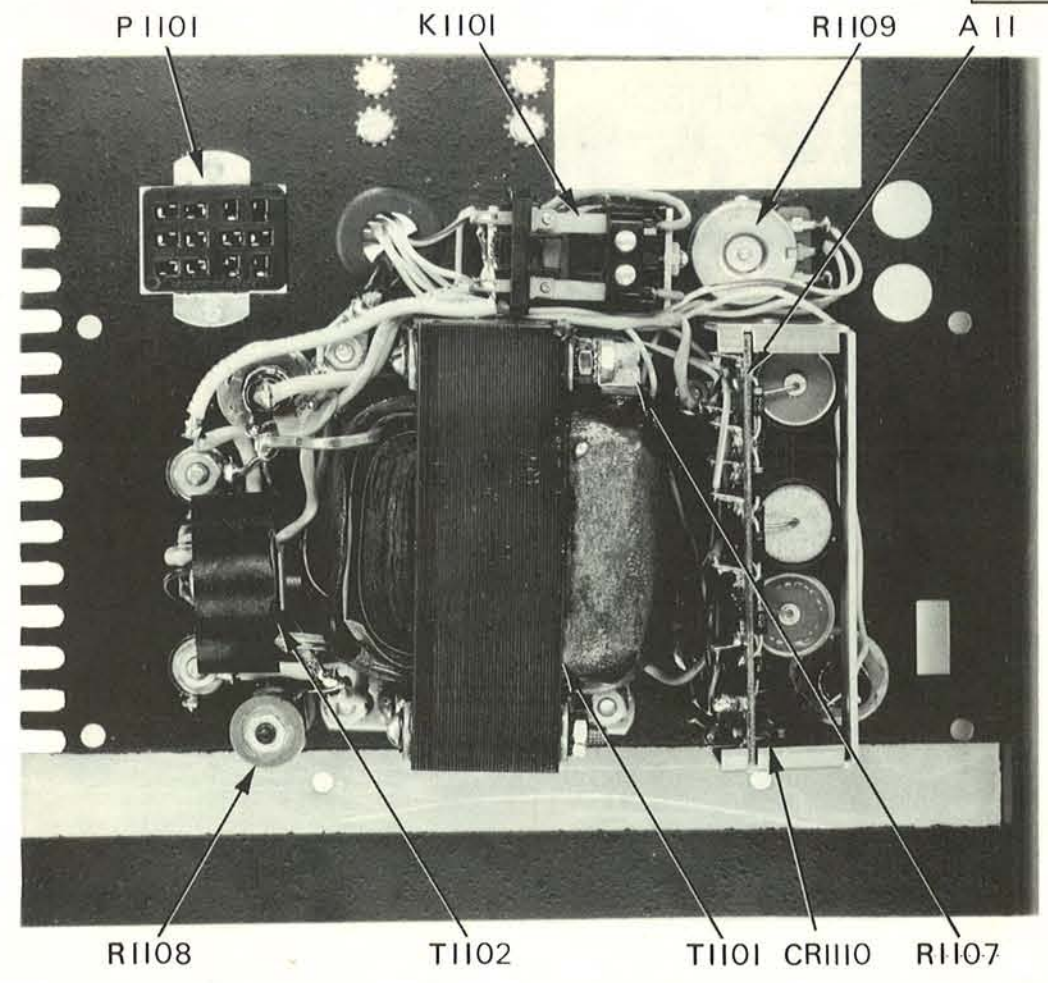

Figure 5-17. 12.9 Volt DC Power Supply Components

REF DES	DESCRIPTION
R1107	Resistor, Wire Wound, .82 Ohm 5%, 10 W
R1108	Resistor, Wire Wound, 25 Ohm 5%, 20 W
R1109	Resistor, Variable, 5 K, 5 W
CR1110	Diode B5G5
F1101	*Fuse, 30 Amp, 3AG
F1102	*Fuse, 5 Amp, SLO-BLOW 3AG
K1101	Relay, (CD 302DIO-38)
P1101	Connector, (Cinch-Jones S-310-AB)
T1101	Transformer, Power (R. L. Drake C-2076-E)
T1102	Transformer, Toroid (R. L. Drake A-1494-E)
Q1101	*Transistor SP-2687
Q1102	*Transistor SP-2687
TB1101	*Terminal Block, Power (R. L. Drake A-2666-B)
	*Not Shown



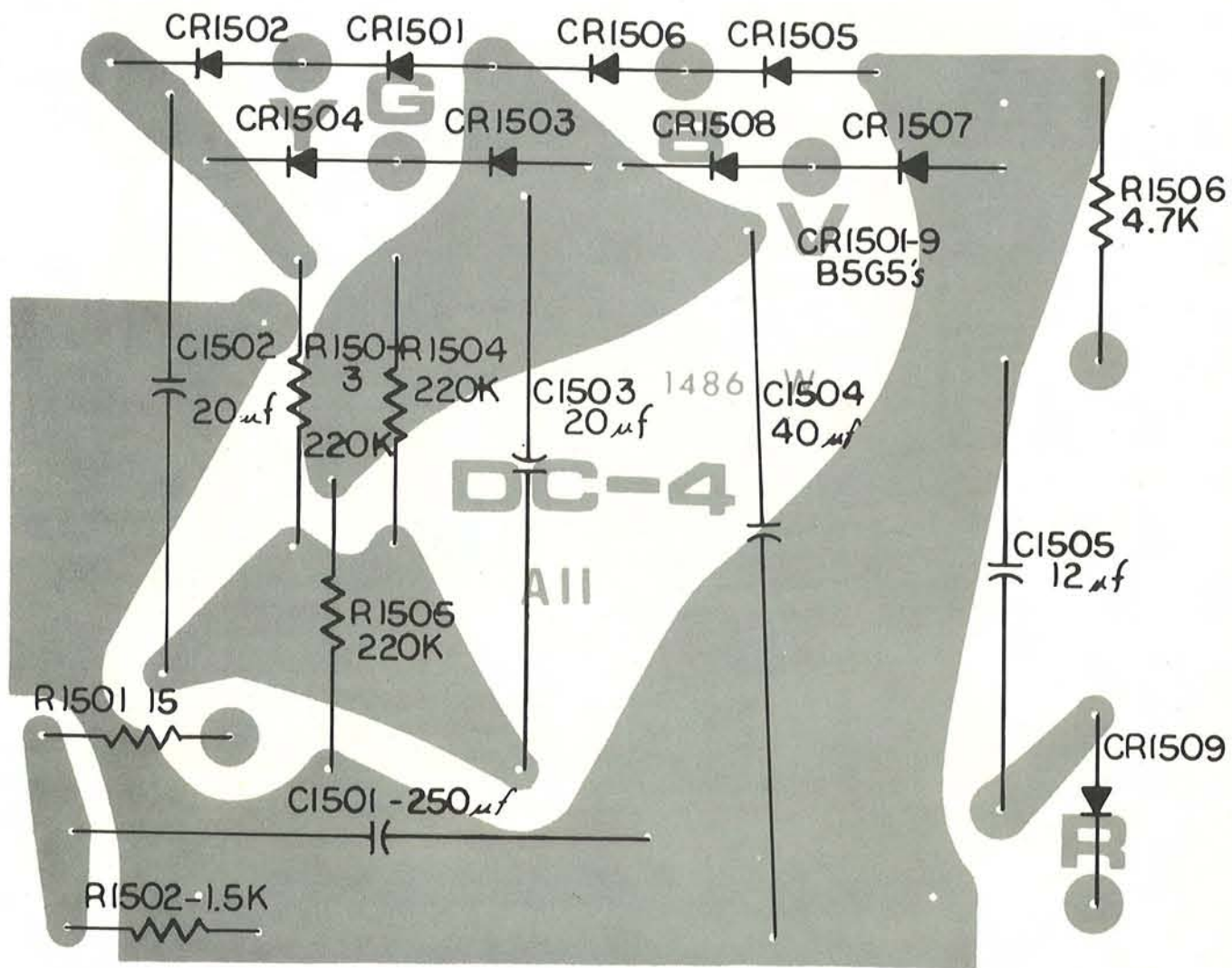

Figure 5-18. 35 Volt DC Power Supply Board (A15)

REF DES	DESCRIPTION
R1501	Resistor, Carbon Comp., 15 Ohm 10%, 1/2 W
R1502	Resistor, Carbon Comp., 1.5 K 10%, 1/2 W
R1503	Resistor, Carbon Comp., 220 K 10%, 1 W
R1504	Resistor, Carbon Comp., 220 K 10%, 1 W
R1505	Resistor, Carbon Comp., 220 K 10%, 1 W
R1506	Resistor, Carbon Comp., 4.7 K 10%, 1 W
C1501	Capacitor, Electrolytic, 250 uf 50 V
C1502	Capacitor, Electrolytic, 20 uf 350 V
C1503	Capacitor, Electrolytic, 20 uf 350 V
C1504	Capacitor, Electrolytic, 40 uf 350 V
C1505	Capacitor, Electrolytic, 12 uf 350 V
CR1501 Through CR1509	Diode B5G5

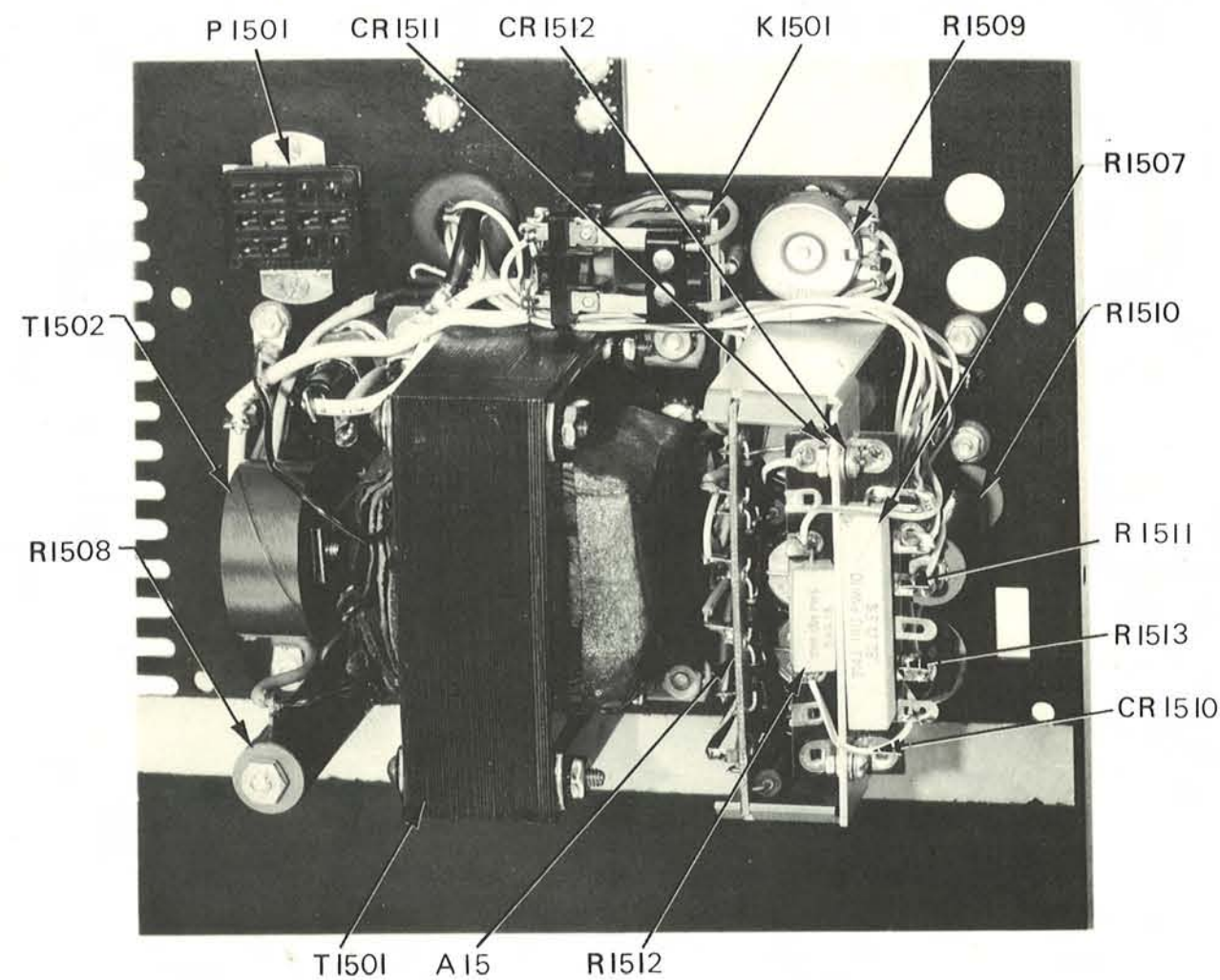

Figure 5-19. 35 Volt DC Power Supply Components

REF DES	DESCRIPTION
R1507	Resistor, Wire Wound, .82 Ohm 5%, 10 W
R1508	Resistor, Wire wound, 175 Ohm 5%, 35 W
R1509	Resistor, Variable, 5 K, 5 W
R1510	Resistor, Wire Wound, 10 Ohm 5%, 20 W
R1511	Resistor, Wire Wound, 180 Ohm 5%, 5 W
R1512	Resistor, Wire Wound, 3.9 Ohm 5%, 5 W
R1513	Resistor, Carbon Comp., 220 Ohm 10%, 2 W
CR1510	Diode B5G5
CR1511	Diode, Zener, AN994
CR1512	Diode, Zener, AN994
F1501	*Fuse, 20 Amp, 3AG
F1502	*Fuse, 3 Amp, SLO-BLOW, 3AG
K1501	Relay (CD 302DIO-38)
P1501	Connector (Cinch-Jones S-313-AB)
T1501	Transformer, Power (R. L. Drake C-2639-E)
T1502	Transformer, Toroid (R. L. Drake A-2732-E)
TB1501	*Terminal Block, Power (R. L. Drake A-2666-B)
Q1501	*Transistor 2N6030
Q1502	*Transistor 2N6030
Q1503	*Transistor 40310
C1506	Capacitor, Paper, .22 uf 200 V
	*Not Shown



DRAKE

INSTRUCTION MANUAL



**TR-M**

SSB RADIOTELEPHONE

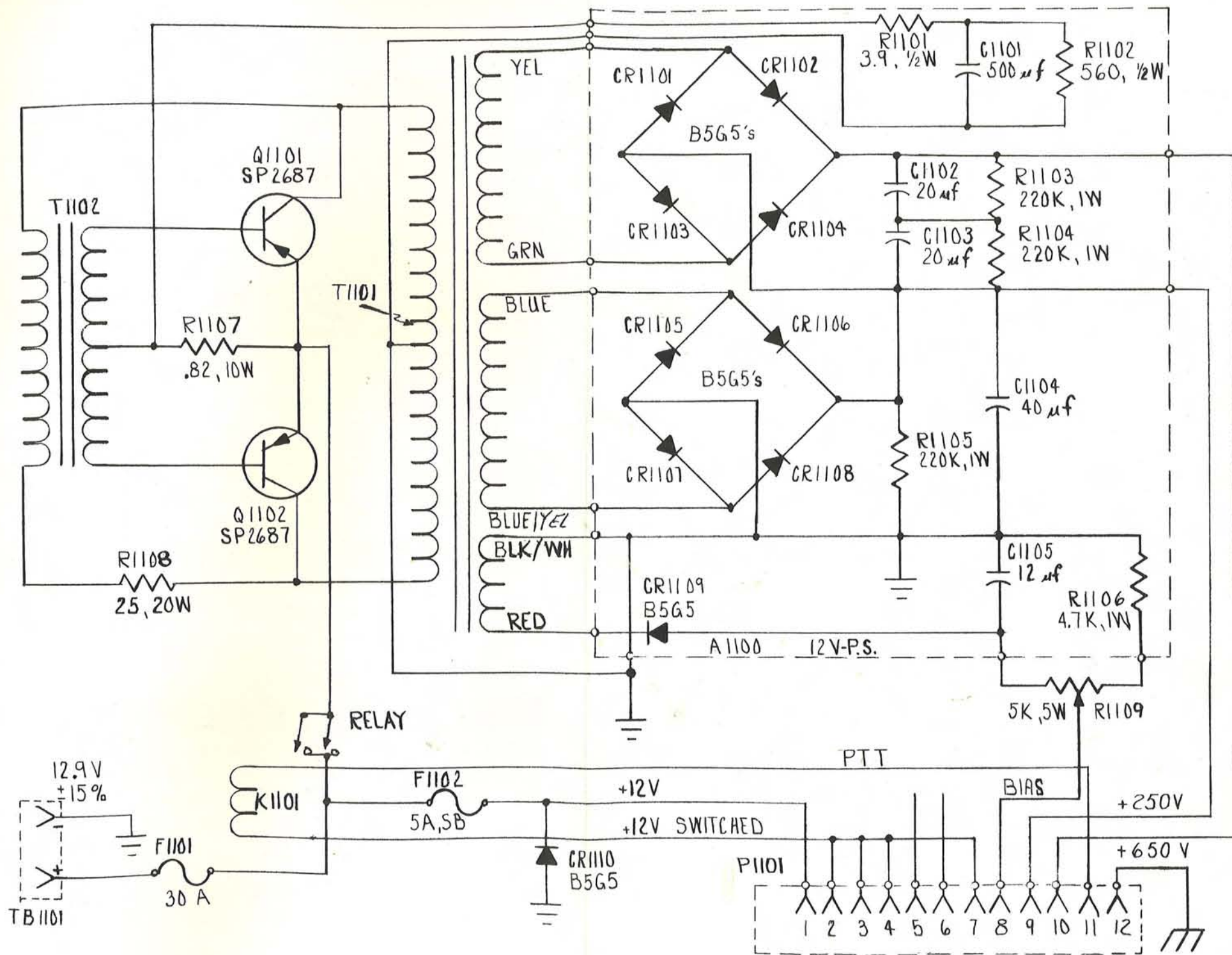

Figure 5-22. 12.9 Volt DC Power Supply Schematic



DRAKE

DRAKE

INSTRUCTION MANUAL



**TR-M**  
SSB RADIOTELEPHONE

R. L. DRAKE COMPANY, MIAMISBURG, OHIO, U.S.A.

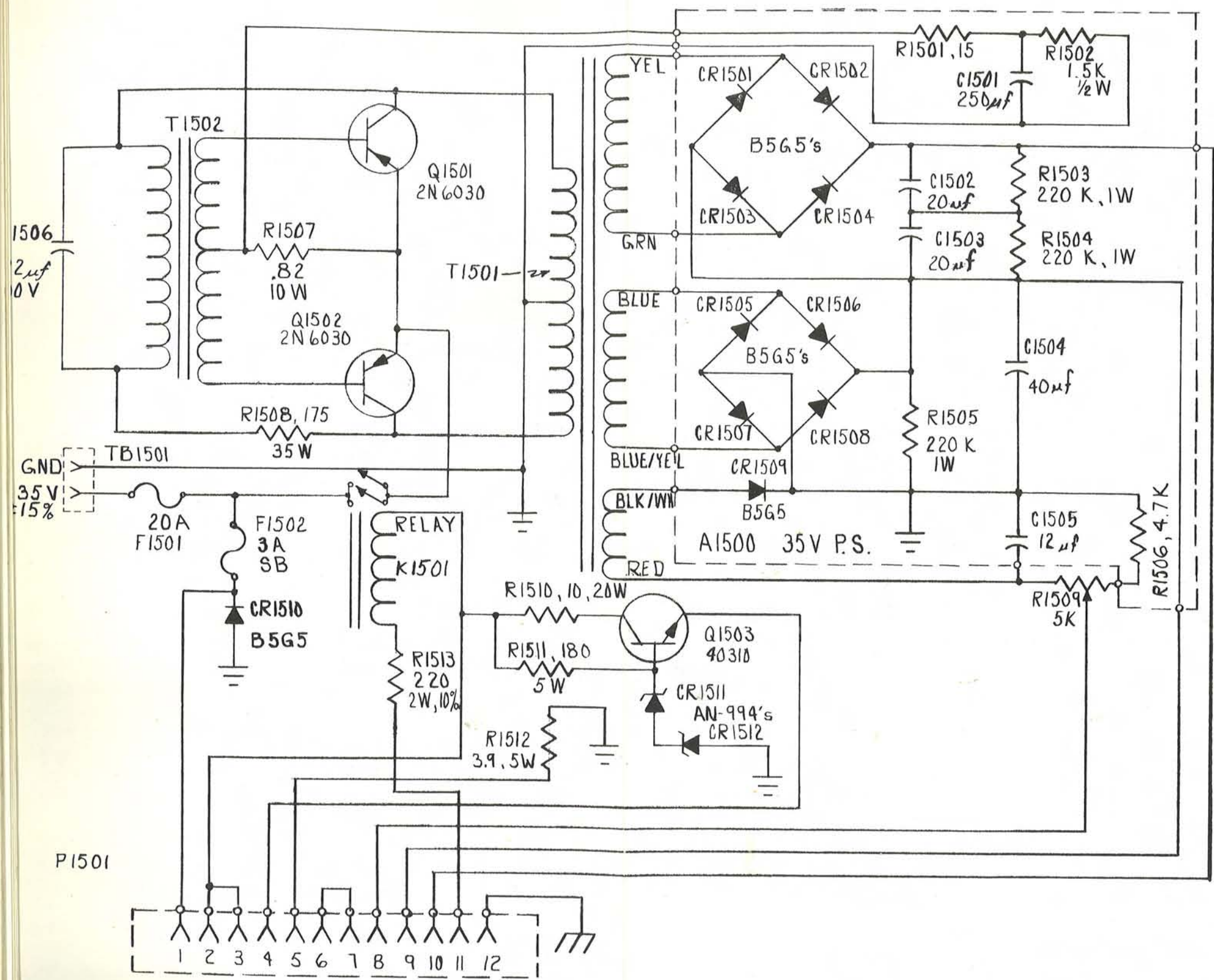

Figure 5-23. 35 Volt DC Power Supply Schematic



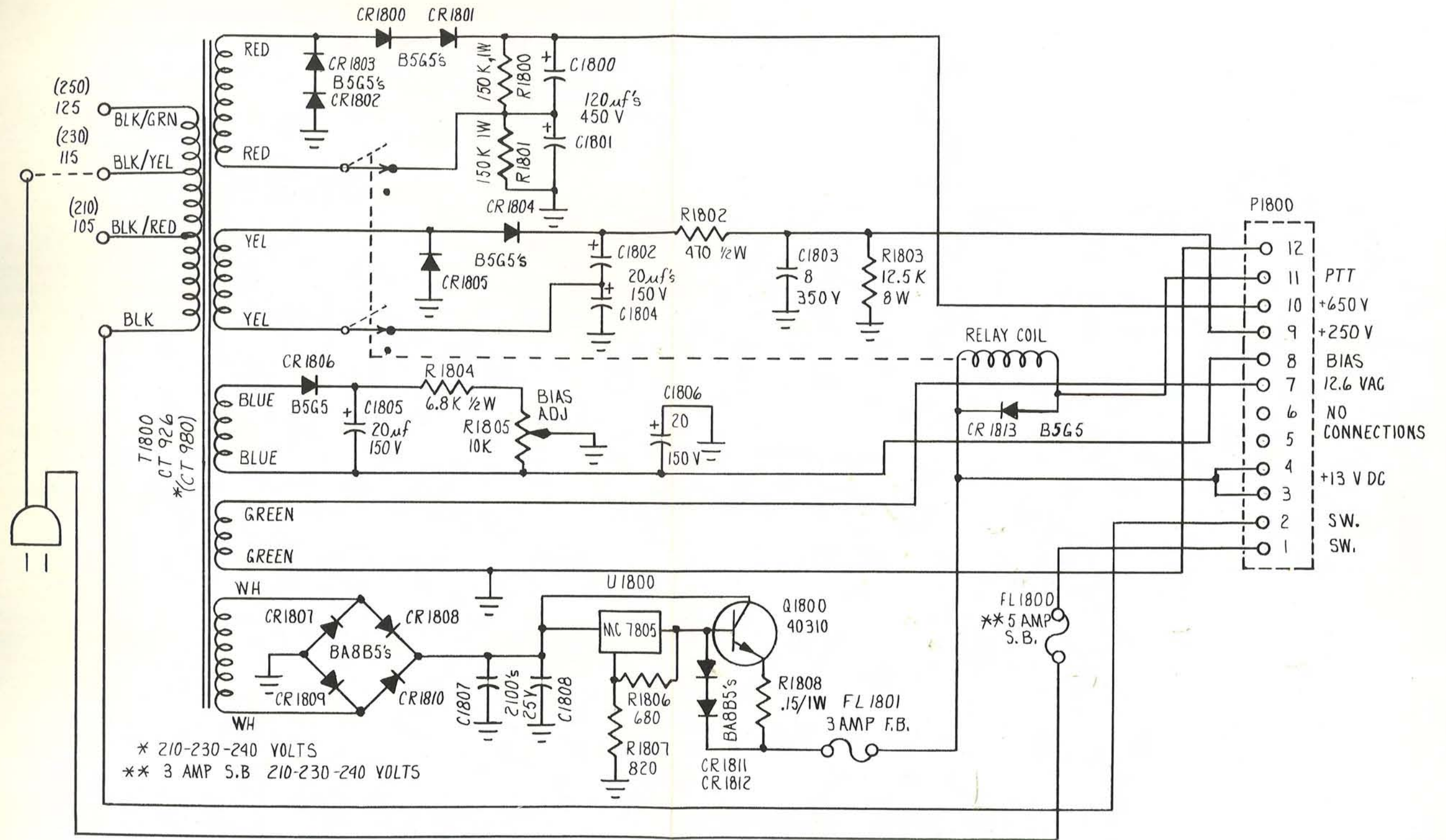
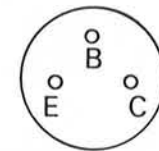

Figure 5-24. AC Power Supply Schematic









2N 3563  
 2N 3566  
 2N 4125  
 2N 4402  
 2N 4427  
 MRF 8004

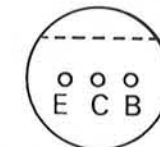

2N 3394

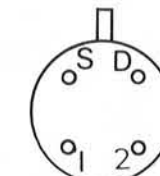

SFC 4982

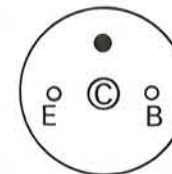

SP 2687

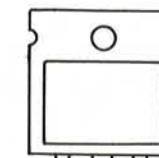

EP 487

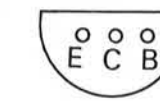

2N 3877

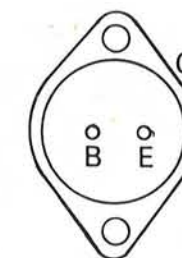

40310  
 6030

Figure 5-26. Component Lead Identification



TR-M ANTENNA COUPLER

R. L. Drake Co.  
540 Richard Street  
Miamisburg, Ohio 45342



## TR-M ANTENNA COUPLER

### GENERAL DESCRIPTION

The TR-M Antenna Coupler is a T configuration as shown in figure #1.

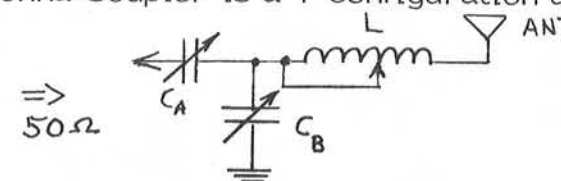

Fig. 1

This configuration is primarily intended for matching antennas which are one-quarter wavelength long, or less.

The loading coil L shown in figure #1 consists of two sections. One section is used on all bands, another section is used in series with the first section on the 2 MHz band to provide sufficient loading coil.

By adding a fixed shunt capacitor from the antenna terminal to ground, the antenna coupler configuration is modified as shown in figure #2.

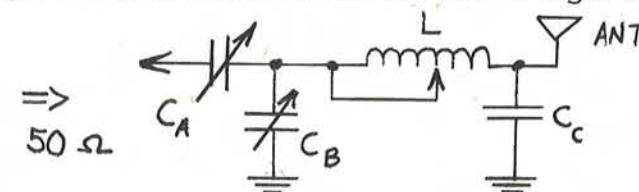

Fig. 2

This configuration is normally needed when the antenna exceeds one-quarter wavelength in length.

Terminals for adding this capacitor,  $C_C$ , on the 6 MHz and 8 MHz bands are provided on the rear of the TR-M on the Antenna Coupler board. If the need should arise for this capacitor on the 4 MHz band, the capacitor can be added between ground and the 4 MHz switch contact shown in figure #3. This capacitor is never required on the 2 MHz band. This capacitor should have a voltage rating of at least 3 kV.



Fig. 3

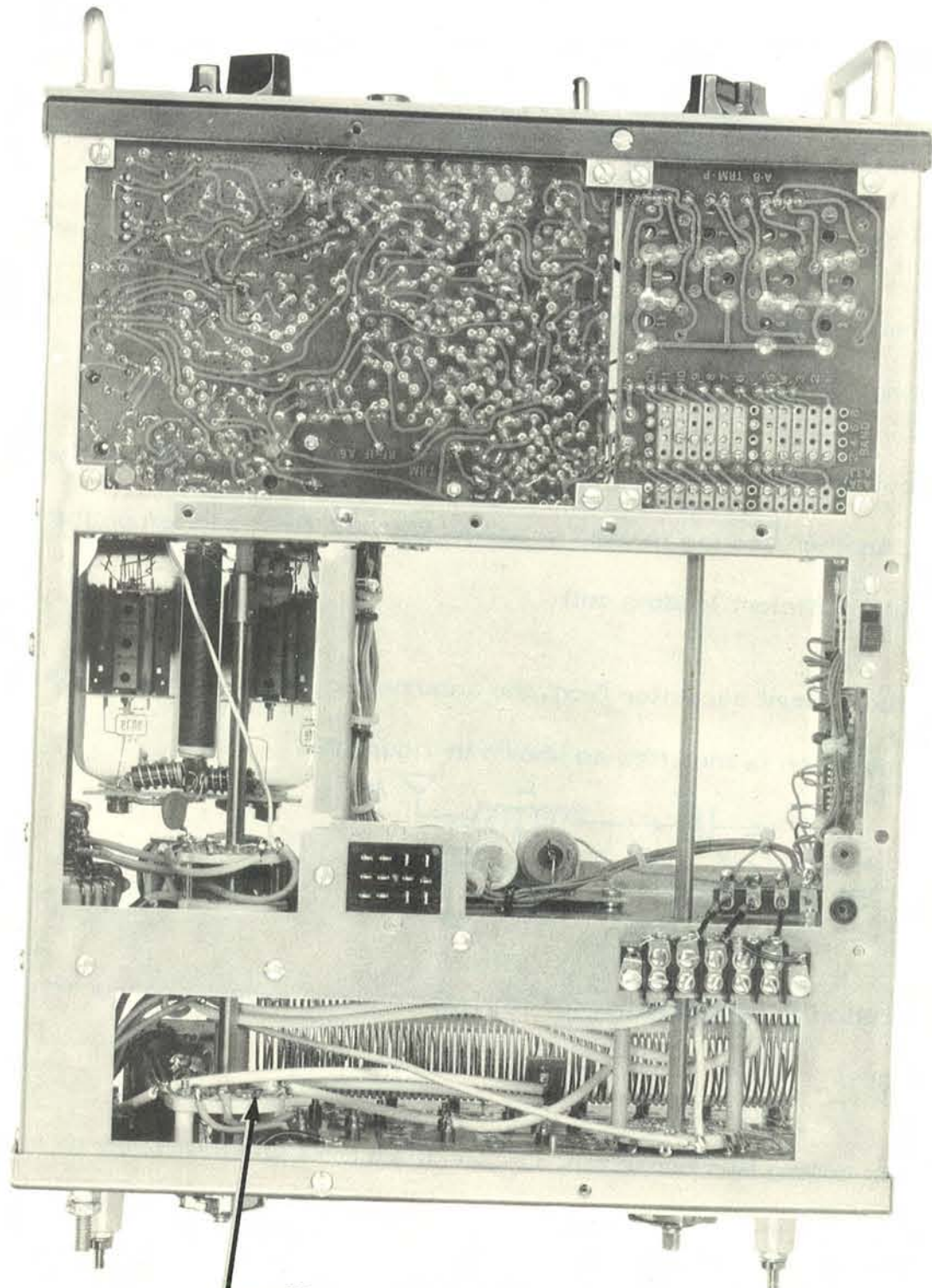

If required, add  $C_C$  capacitor for 4 MHz band from this switch terminal to ground.

### GROUND SYSTEMS & FEEDLINE

The use of a good ground system cannot be stressed too heavily. Poor, high resistance ground connections appear in series with the radiation resistance of the antenna and cause part of the RF energy to be dissipated as heat in these poor ground connections.

If the ground system is steel or aluminum the ground bond can be made with aluminum flashing to minimize galvanic corrosion. All bonds should be made with stainless steel or monel hardware and then covered with silicone rubber.

A good ground system consists of several square feet of metal in contact with the water and a good low resistance bond between the transceiver and the metal. Usually the propellers, rudders, and shafts are sufficient and the ground connection can be made to the engine block providing all of the above are well bonded. The bond between the transceiver and the ground system should consist of copper strap 4 to 6 inches wide. If the bond between the engine block and the transceiver would exceed 3 to 4 feet, better performance can be obtained using a counterpoise ground attached to the hull if a shorter ground connection would result.

The feedline to the antenna should be insulated high-voltage wire, should run as vertical as possible, and should be as out of reach as possible. The length of the feedline effectively adds to the length of the antenna and should be taken into account as shown in the antenna tables.



TUNING PROCEDURE

A. Connect feedline from the antenna to be used on the 4, 6 and 8 MHz bands to the HF ANT post. Connect the feedline from the antenna to be used on the 2 MHz band to the MF ANT post. If one antenna is to be used on all four bands, the HF ANT and MF ANT posts can be tied together to accommodate the single feedline. If one antenna is to be used on all four bands, a 35 foot whip with a short feedline or a 23 foot whip with 10 feet to 12 feet of feedline is recommended.

B. Be sure a good connection from the TR-M to an adequate ground system is made following the recommendations previously outlined.

C. The antenna tables show components required and their approximate settings for typical antenna/feedline length combination. Locate the table for the antenna which is the closest to approximating the installation being used.

D. As shown in figure #1 and figure #2, the capacitor designated  $C_A$  is a series capacitor,  $C_B$  is a shunt capacitor, and  $C_C$  is a fixed shunt capacitor used only if required by the antenna installation.

The columns labeled  $C_A$  and  $C_B$  on the antenna tables show the trimmer required plus any fixed capacity required in parallel with the trimmer. The column labeled  $C_C$  gives the value of the fixed shunt capacitor if required.

The plate on the rear of the TR-M shows the location of the  $C_A$  and  $C_B$  trimmers for each channel. It also shows the location of the terminals used to install the fixed  $C_C$  capacitor for either the 6 MHz or 8 MHz band. As previously mentioned, figure #3 shows location of a switch contact where a  $C_C$  shunt capacitor can be installed for use on the 4 MHz band should it ever be required.

Remove the rear plate and check to see if the trimmers and capacitors installed in the  $C_A$  and  $C_B$  positions for the channels to be used correspond to the trimmers and capacitors called out in the antenna table being used. Change trimmers and capacitors as required so each channel's components correspond to the components called out for a frequency closest the channel frequency. Turn trimmers CW until they are just slightly snug, and then preset the number of turns CCW as called out by the antenna table in use. Do not overtighten trimmers as permanent damage can result.

The trimmers furnished with the TR-M are color coded to facilitate identification without removal.

<u>Color</u>	<u>Trimmer No.</u>
Green	305
Violet	307
Red	302
Yellow	304

Tables 1 and 2 show trimmers and fixed capacitors furnished with TR-M and capacity range of trimmers.

Table 2 Capacity Range

Trimmer No.	Capacity Range (pf)
#302	15 - 120
#304	100 - 500
#305	180 - 690
#307	340 - 1070

Table 1 Capacitors Supplied

Channel No.	$C_A$	$C_B$
1	#305 + 500 pf	#307 + 300 pf
2	#305 + 500 pf	#307 + 300 pf
3	#305 + 500 pf	#307 + 300 pf
4	#305 + 500 pf	#307 + 300 pf
5	#305 + 500 pf	#307 + 300 pf
6	#305 + 500 pf	#307 + 300 pf
7	#305 + 500 pf	#307 + 300 pf
8	#305	#304 + 200 pf
9	#305	#304 + 200 pf
10	#305	#304 + 200 pf
11	#305	#302 + 100 pf



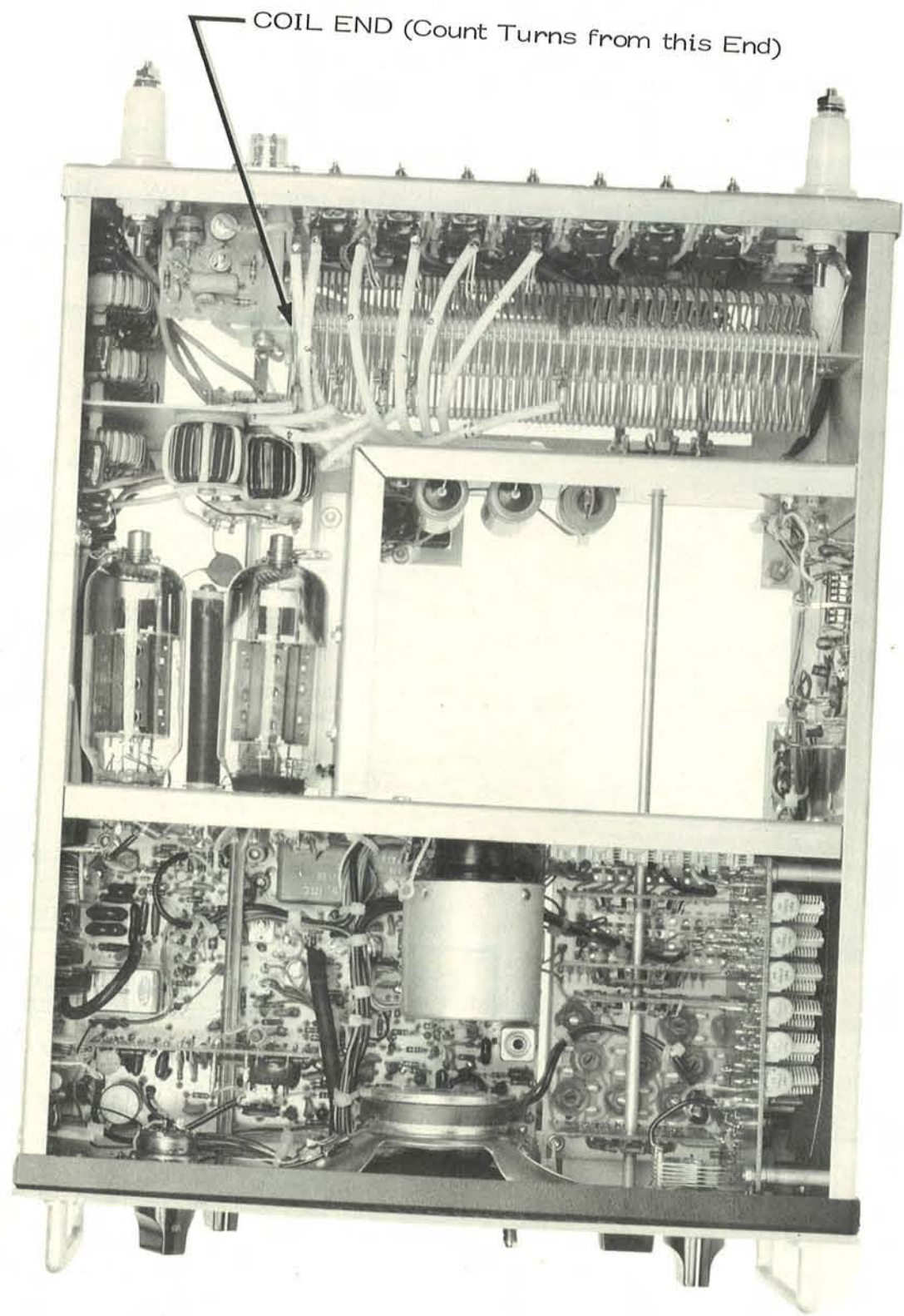

Fig. 4

HF Ant. Pin Terminal (Connect 50 Ohm Output Receptacle Here to Feed HF Antennas with Coax).

50 Ohm Line

Antenna Coupler Input Lead

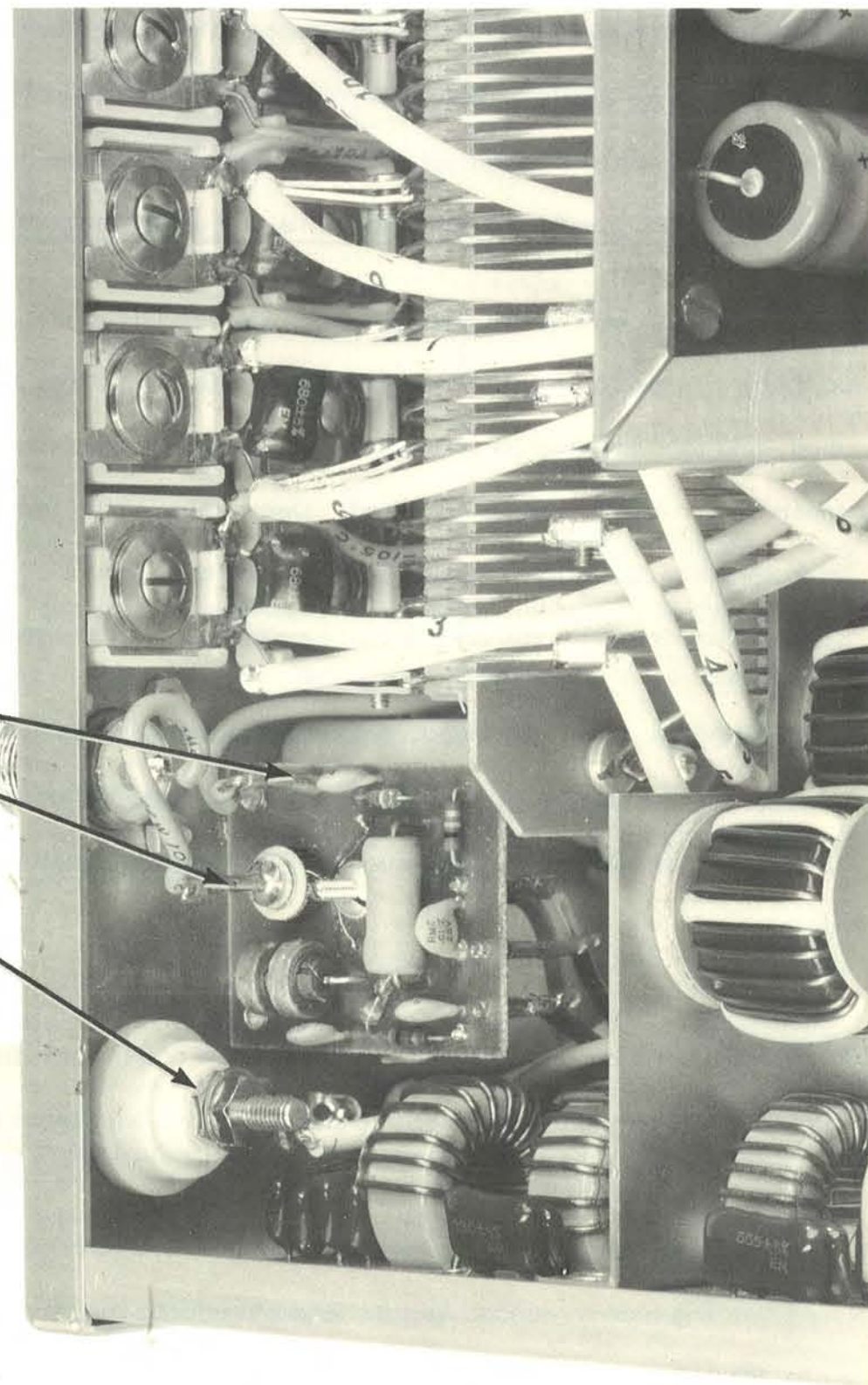

Fig. 5



E. Referring to figure #4, the end of the coil referred to as COIL END, is the end from which turns are counted and tabulated in the antenna tables. The section of coil from this end to approximately the middle is the section of coil used on the HF bands (4 MHz, 6 MHz and 8 MHz). This point is marked on the coil by a mark of green paint. All coil taps for HF channels will end up somewhere on this section of coil.

The section of coil from the mark of green paint to the end of the coil by the MF ANT post is switched in on the 2 MHz band only. On this band, the whole loading coil is used, and taps for this band could end up anywhere on the complete length of coil depending on the antenna being used. Decreasing turns from reference end as tabulated in the tables corresponds to increasing the amount of loading coil used since the tap shorts out the portion of coil between the tap and the reference end.

With TR-M top cover removed, relocate the taps corresponding to the tap positions given in the antenna table being used. Be sure to use the tap position given for a frequency close to the actual channel frequency. The taps are labeled corresponding to channel numbers.

F. Connect the antenna coupler to the 50 Ohm output as follows:

1. Referring to figure #5, locate the short lead from the SO-239 50 Ohm output receptacle to the Power Detector PC board, A 500. The end of this lead going to the Power Detector board should be disconnected. No soldering iron is needed as this lead plugs onto the terminal on the board.
2. Unplug antenna coupler input lead, see figure #5, from the terminal it is on, and connect it to the terminal where the lead from the 50 Ohm output receptacle was removed. (Center of toroid).

3. Finally, connect the end of the short lead from the 50 Ohm output receptacle to the terminal where the antenna coupler input lead was originally connected. This is a ground terminal used to retain the unused lead.

G. Begin coupler tuning on the highest frequency channel in the 8 MHz band. Progress downward to the 6 MHz band, 4 MHz band and finally the 2 MHz band.

Remove the small cover on the bottom of the TR-M to expose the TUNE/NORMAL switch. Connect a VOM to the NULL METER jacks on the rear panel of the TR-M. Set the VOM to a microamp scale capable of reading 1000 - 1500  $\mu\text{A}$ .

Switch TUNE/NORMAL switch to TUNE position. Key the transmitter and adjust the  $C_B$  trimmer for minimum reading on the meter. Adjust  $C_A$  trimmer for a further null in the meter reading. If the coil tap position is correct, alternately adjusting the  $C_A$  and  $C_B$  trimmers should result in a null reading of 20 - 100  $\mu\text{A}$ , depending on band being used and power output in TUNE position. This null represents a SWR of 1:1. A meter reading of 200 - 300  $\mu\text{A}$  indicates the SWR is in the 1.5:1 to 2:1 range.

Best results will be obtained if the  $C_A$  trimmer is not detuned more than 1/2 - 1 turn from its preset position called for in the antenna tables. If a null cannot be obtained with each trimmer, change coil tap one turn at a time until both trimmers null. Be sure to return trimmers to preset position to begin tuning sequence after changing tap position.

After tuning each channel in this manner, replace back plate over trimmers and check each channel again and readjust if needed. Return TUNE/NORMAL switch to NORMAL position and replace cover over TUNE/NORMAL switch. TR-M is now ready for operation.



USING THE ANTENNA COUPLER ON 52 OHM ANTENNAS

Antennas are available which have a 52 Ohm impedance over a narrow band of frequencies in one or more of the HF bands (4, 6 or 8 MHz). These antennas can be fed with 52 Ohm coax and still retain use of the coupler for operation on a separate antenna on the 2 MHz band. Referring to figure # 5, connect the lead from the SO-239 output receptacle to the pin terminal on the HF ANT terminal. Connect the antenna coupler input lead to the pin terminal on the Power Detector PC board, A500, as previously outlined (center of toroid).

The HF antenna can now be fed with 52 Ohm coax with the ground connection to the ground system made at the antenna base. The antenna used on the 2 MHz band should be connected to the MF ANT post as usual.

The use of the antenna coupler with these antennas will allow a better match to be obtained under varying installation conditions, plus they can be made to operate over a wider frequency range than normal.

To set up the coupler for use with these 52 Ohm antennas, refer to the table showing components and coil tap positions for matching 52 Ohm antennas on the HF bands.

ANTENNA: 23' WHIP  
(Shakespeare #390)

LEAD IN: 3' Long

1. Turn trimmers CW until snug, then pre-set number of turns CCW shown in parenthesis next to trimmer number.
2. C<sub>C</sub> should have a minimum voltage rating of 3 kV.
3. Capacitors used in parallel with C<sub>A</sub> and C<sub>B</sub> trimmers should have a minimum rating of 500 V.
4. Count turns for coil tap from end of coil next to the 50 Ohm output receptacle.

FREQUENCY (kHz)	C <sub>A</sub>	C <sub>B</sub>	C <sub>C</sub>	COIL TAP (TURNS)
2000	—	—	—	—
2200	—	—	—	—
2400	—	—	—	—
2600	—	—	—	—
2800	—	—	—	—
3000	—	—	—	—
4000	#305(1/2)	#307(1)	NOT USED	13
4200	#305(1/2)	#307(1)	NOT USED	16
4400	#305(1/2)	#307(1)	NOT USED	19
6200	#305(1)	#304(1)	NOT USED	30
6500	#305(1)	#304(1)	NOT USED	31
8200	#305(1/2)	#302(1)	NOT USED	37
8500	#305(1/2)	#302(1)	NOT USED	37
8800	#305(1/2)	#302(1)	NOT USED	38



ANTENNA: 23' WHIP  
(Shakespeare #390)

LEAD IN: 6' Long

1. Turn trimmers CW until snug, then pre-set number of turns CCW shown in parenthesis next to trimmer number.
2. C<sub>C</sub> should have a minimum voltage rating of 3 kV.
3. Capacitors used in parallel with C<sub>A</sub> and C<sub>B</sub> trimmers should have a minimum rating of 500 V.
4. Count turns for coil tap from end of coil next to the 50 Ohm output receptacle.

FREQUENCY (kHz)	C <sub>A</sub>	C <sub>B</sub>	C <sub>C</sub>	COIL TAP (TURNS)
2000	—	—	—	—
2200	—	—	—	—
2400	—	—	—	—
2600	—	—	—	—
2800	—	—	—	—
3000	—	—	—	—
4000	#305(1/2)	#307(1)	NOT USED	17
4200	#305(1/2)	#307(1)	NOT USED	19
4400	#305(1/2)	#307(1)	NOT USED	21
6200	#305(1)	#304(1)	NOT USED	32
6500	#305(1)	#304(1)	NOT USED	33
8200	#305(1 1/2)	#304(1)	500pf	35
8500	#305(1 1/2)	#304(1)	500pf	36
8800	#305(1 1/2)	#304(1)	500pf	37

ANTENNA: 23' WHIP  
(Shakespeare #390)

LEAD IN: 9' Long

1. Turn trimmers CW until snug, then pre-set number of turns CCW shown in parenthesis next to trimmer number.
2. C<sub>C</sub> should have a minimum voltage rating of 3 kV.
3. Capacitors used in parallel with C<sub>A</sub> and C<sub>B</sub> trimmers should have a minimum rating of 500 V.
4. Count turns for coil tap from end of coil next to the 50 Ohm output receptacle.

FREQUENCY (kHz)	C <sub>A</sub>	C <sub>B</sub>	C <sub>C</sub>	COIL TAP (TURNS)
2000	—	—	—	—
2200	—	—	—	—
2400	—	—	—	—
2600	—	—	—	—
2800	—	—	—	—
3000	—	—	—	—
4000	#305(1/2)	#307(1)	NOT USED	21
4200	#305(1/2)	#307(1)	NOT USED	22
4400	#305(1/2)	#307(1)	NOT USED	24
6200	#305(1)	#302(1)	NOT USED	35
6500	#305(1)	#302(1)	NOT USED	36
8200	#305(1 1/2)	#304(1)	300pf	34
8500	#305(1 1/2)	#304(1)	300pf	35
8800	#305(1 1/2)	#304(1)	300pf	35



ANTENNA: 23' WHIP  
(Shakespeare #390)

LEAD IN: 12' Long

1. Turn trimmers CW until snug, then pre-set number of turns CCW shown in parenthesis next to trimmer number.
2.  $C_C$  should have a minimum voltage rating of 3 kV.
3. Capacitors used in parallel with  $C_A$  and  $C_B$  trimmers should have a minimum rating of 500 V.
4. Count turns for coil tap from end of coil next to the 50 Ohm output receptacle.

FREQUENCY (kHz)	$C_A$	$C_B$	$C_C$	COIL TAP (TURNS)
2000	#305(1/2) +500pf	#312(1)	NOT USED	1
2200	#305(1/2) +500pf	#312(1)	NOT USED	10
2400	#305(1/2) +500pf	#312(1)	NOT USED	19
2600	#305(1/2) +500pf	#312(1)	NOT USED	30
2800	#305(1/2) +500pf	#312(1)	NOT USED	36
3000	#305(1/2) +500pf	#312(1)	NOT USED	44
4000	#305(1/2) +200pf	#304(1)	NOT USED	22
4200	#305(1/2) +200pf	#304(1)	NOT USED	24
4400	#305(1/2) +200pf	#304(1)	NOT USED	27
6200	#305(1)	#302(1)	NOT USED	36
6500	#305(1)	#302(1)	NOT USED	37
8200	#305(1 1/2)	#302(1)	200pf	33
8500	#305(1 1/2)	#304(1)	200pf	34
8800	#305(1 1/2)	#304(1)	200pf	35

ANTENNA: 50' LONG WIRE

LEAD IN: INCLUDED IN 50'

1. Turn trimmers CW until snug, then pre-set number of turns CCW shown in parenthesis next to trimmer number.
2.  $C_C$  should have a minimum voltage rating of 3 kV.
3. Capacitors used in parallel with  $C_A$  and  $C_B$  trimmers should have a minimum rating of 500 V.
4. Count turns for coil tap from end of coil next to the 50 Ohm output receptacle.

FREQUENCY (kHz)	$C_A$	$C_B$	$C_C$	COIL TAP (TURNS)
2000	#305(1/2) +500 pf	#312(1)	NOT USED	7
2200	#305(1/2) +500 pf	#312(1)	NOT USED	15
2400	#305(1/2) +500 pf	#312(1)	NOT USED	24
2600	#305(1/2) +500 pf	#312(1)	NOT USED	32
2800	#305(1/2) +500 pf	#312(1)	NOT USED	40
3000	#305(1/2) +500 pf	#312(1)	NOT USED	49
4000	#305(1/2) +200 pf	#304(1)	NOT USED	29
4200	#305(1/2) +200 pf	#304(1)	NOT USED	31
4400	#305(1/2) +200 pf	#304(1)	NOT USED	34
6200	#305(1)	#304(1)	200 pf	29
6500	#305(1)	#304(1)	200 pf	31
8200	#305(1 1/2)	#304(1)	50 pf	28
8500	#305(1 1/2)	#304(1)	50 pf	29
8800	#305(1 1/2)	#304(1)	50 pf	30



ANTENNA: 75' LONG WIRE

LEAD IN: INCLUDED IN 75'

1. Turn trimmers CW until snug, then pre-set number of turns CCW shown in parenthesis next to trimmer number.
2.  $C_C$  should have a minimum voltage rating of 3 kV.
3. Capacitors used in parallel with  $C_A$  and  $C_B$  trimmers should have a minimum rating of 500 V.
4. Count turns for coil tap from end of coil next to the 50 Ohm output receptacle.

FREQUENCY (kHz)	$C_A$	$C_B$	$C_C$	COIL TAP (TURNS)
2000	#305(1/2) +500 pf	#312(1)	NOT USED	40
2200	#305(1/2) +500 pf	#312(1)	NOT USED	46
2400	#305(1/2) +500 pf	#312(1)	NOT USED	53
2600	#305(1/2) +500 pf	#307(1)	NOT USED	58
2800	#305(1/2) +500 pf	#307(1)	NOT USED	63
3000	#305(1/2) +500 pf	#307(1)	NOT USED	68
4000	#305(1/2)	#304(1) +200 pf	500 pf	29
4200	#305(1/2)	#304(1) +200 pf	500 pf	31
4400	#305(1/2)	#304(1) +200 pf	500 pf	33
6200	#305(1)	#304(1)	100 pf	28
6500	#305(1)	#304(1)	100 pf	28
8200	#305(1 1/2)	#304(1)	100 pf	34
8500	#305(1 1/2)	#304(1)	100 pf	36
8800	#305(1 1/2)	#304(1)	100 pf	38

ANTENNA: 50  $\Omega$

LEAD IN: FED WITH COAX

1. Turn trimmers CW until snug, then pre-set number of turns CCW shown in parenthesis next to trimmer number.
2.  $C_C$  should have a minimum voltage rating of 3 kV.
3. Capacitors used in parallel with  $C_A$  and  $C_B$  trimmers should have a minimum rating of 500 V.
4. Count turns for coil tap from end of coil next to the 50 Ohm output receptacle.

FREQUENCY (kHz)	$C_A$	$C_B$	$C_C$	COIL TAP (TURNS)
4000	#305(1/2)	#304(1)	700 pf	34
4100	#305(1/2)	#304(1)	700 pf	34
4200	#305(1/2)	#304(1)	700 pf	34
4300	#305(1/2)	#304(1)	700 pf	34
4400	#305(1/2)	#304(1)	700 pf	34
4500	#305(1/2)	#304(1)	700 pf	34
6200	#305(1)	#302(1) +50 pf	500 pf	36
6400	#305(1)	#302(1) +50 pf	500 pf	36
6600	#305(1)	#302(1) +50 pf	500 pf	36
8400	#305(1 1/2)	#302(1)	375 pf	37
8600	#305(1 1/2)	#302(1)	375 pf	37



ANTENNA: 23' LOADED WHIP  
(SHAKESPEARE #208B)

LEAD IN: 10' LEAD-IN

1. Turn trimmers CW until snug, then pre-set number of turns CCW shown in parenthesis next to trimmer number.
2.  $C_C$  should have a minimum voltage rating of 3 kV.
3. Capacitors used in parallel with  $C_A$  and  $C_B$  trimmers should have a minimum rating of 500 V.
4. Count turns for coil tap from end of coil next to the 50 Ohm output receptacle.

FREQUENCY (kHz)	$C_A$	$C_B$	$C_C$	COIL TAP (TURNS)				
2000	#305(1/2) +500pf	#312(1)	NOT USED	12				
2200	#305(1/2) +500pf	#312(1)	NOT USED	25				
2400	#305(1/2) +500pf	#312(1)	NOT USED	40				
2600	#305(1/2) +500pf	#307(1)	NOT USED	50				
2800	#305(1/2) +500pf	#304(1)	NOT USED	52				
3000	#305(1/2) +500pf	#302(1)	NOT USED	76				
4000	}	}	}	}				
4200					NOT RECOMMENDED			
4400					}			
6200					}			
6500	}	}	}	}				
8200					#305(1/2)	#304(1)	NOT USED	34
8500					#305(1/2)	#304(1)	NOT USED	35
8800					#305(1/2)	#304(1)	NOT USED	36