

Maintenance Manual
***Monogram* Series**
VHF MOBILE RADIO
MODEL MGM 148 & 160



MONOGRAM SERIES LBI-38864B

TABLE OF CONTENTS

TABLE OF CONTENTS	
SPECIFICATIONS	1-4
<i>Receiver (PER EIA RS-204-C)</i>	2
<i>Transmitter (PER EIA RS-152-B)</i>	3
<i>Options And Accessories</i>	4
UNPACKING	5
GENERAL DESCRIPTION	6
DESCRIPTION OF CONTROLS	7-8
<i>Front Panel Controls</i>	7
<i>Rear Panel Controls</i>	8
GENERAL OPERATION	9-10
<i>Radio On/off, Power Up</i>	9
<i>Receiving</i>	9
<i>Transmitting</i>	9
<i>Digital Channel Guard</i>	10
CIRCUIT ANALYSIS	11-13
<i>Receiver</i>	11
<i>Transmitter</i>	12
<i>Frequency Synthesizer</i>	12
PREVENTIVE MAINTENANCE	14
<i>Connections</i>	14
<i>Electrical System</i>	14
<i>Mechanical Inspection</i>	14
<i>Antenna</i>	14
<i>Alignment</i>	14
<i>Frequency Check</i>	14
DISASSEMBLY	15-16
<i>Top And Bottom Covers</i>	15
<i>Front Panel</i>	15
<i>RF Board</i>	15
<i>Digital Board</i>	16
PROGRAMMING INSTRUCTIONS	17
TEST EQUIPMENT SETUP	18
ALIGNMENT PROCEDURE	19-23

MONOGRAM SERIES LBI-38864B

TABLE OF CONTENTS

<i>Suggested Test Equipment</i>	19
<i>Pre-Alignment Notes:</i>	19
<i>Programming For Alignment</i>	19
<i>PLL Alignment</i>	20
<i>Transmitter Alignment</i>	20
<i>Receiver Alignment</i>	22
ALIGNMENT POINTS 406041-F Issue:H DIGITAL BOARD	24
ALIGNMENT POINTS 406039-E Issue:H RF BOARD	25
PERFORMANCE TEST	26-28
<i>Transmitter</i>	26
<i>Receiver</i>	27
COMPONENT REPLACEMENT	29-30
<i>Surface Mount Component Replacement</i>	30
ELECTRICAL PARTS LIST	31
PRINTED CIRCUIT BOARD LAYOUTS	32
<i>Top View 406041-F Issue: H / DIGITAL Board</i>	32.1
<i>Bottom View 406041-F Issue: H / DIGITAL Board</i>	32.2
<i>Top View 406039-E Issue: H / RF Board</i>	32.3
<i>Bottom View 406039-E Issue: H / RF Board</i>	32.4
<i>Misc. Printed Circuit Boards</i>	32.5
<i>Misc. Printed Circuit Boards</i>	32.6
EXPLODED VIEW	33
SCHEMATICS	34

MONOGRAM SERIES LBI-38864B

SPECIFICATIONS

SPECIFICATIONS

GENERAL

Frequency Range

VHF Low Band	136-150 MHz
VHF Mid Band	148-165 MHz
VHF High Band	160-174 MHz

Channel Capability

16 max

Channel Spacing

25 or 30 kHz

Input Voltage

13.8 VDC negative ground

Current Drain

Standby	0.4 Amps (max)
Receive	0.8 Amps (max)
Transmit	9.5 Amps (max)

Temperature Range

-30° to +60° C

Dimensions

2 x 6 x 8-1/4 in
(51 x 152 x 210 mm)

Weight

4 lbs, 3 oz
(1.9 kg) w/mic

FCC Compliance

Parts 15, 22, 74, 90

FCC ID Designation

136-150 MHz	N / A
148-165 MHz	F3J9QLSM4150
160-174 MHz	F3JSM415H

DOC (Canada) Type Approval

136-150 MHz	N / A
148-165MHz	287194150I
160-174 MHz	287194100I

MONOGRAM SERIES LBI-38864B

SPECIFICATIONS

RECEIVER (PER EIA RS-204-C)

RF Input Impedance	50 ohms nominal
Sensitivity	
EIA 12 dB SINAD	0.30 mV
20 dB QUIETING	0.50 μ V
Squelch Sensitivity	0.25 mV threshold
Selectivity	-70 dB
Inter modulation	-70 dB
Modulation Acceptance Bandwidth	\pm 7.5 kHz
Spurious and Image	70 dB mx
Audio Power Output	5 Watts @ % distortion into 4 ohm load)
Frequency Stability	\pm 0.0005%
Operational Bandwidth	10 MHz
	(3 dB degradation at band limits)

VHF PROGRAMMING CHART RECEIVE

Frequency Spread	Band Width	Factory Programmed Freq. Spreads
136 - 150 MHz	10 MHz	136 - 146 MHz (3 dB Degradation at limits)
148 - 165 MHz	10 MHz	150 - 160 MHz (3 dB Degradation at limits)
160 - 174 MHz	10 MHz	162 - 172 MHz (3 dB Degradation at limits)

MONOGRAM SERIES LBI-38864B

SPECIFICATIONS

TRANSMITTER (PER EIA RS-152-B)

RF Power Output	40 W (adjustable)
RF Output Impedance	50 ohms
Spurious and Harmonics	-70 dBc
Modulation	16 K0F3E
FM Hum and Noise	-45dB nominal
Audio Distortion	< 3 % @ 1000 Hz
Frequency Stability	± 0.0005%
Operational Bandwidth	10 MHz (3 dB degradation at band limits)

VHF PROGRAMMING CHART TRANSMIT

Frequency Spread	Band Width	Factory Programmed Freq. Spreads
136 - 150 MHz	10 MHz	136 - 146 MHz (3 dB Degradation at limits)
148 - 165 MHz	10 MHz	150 - 160 MHz (3 dB Degradation at limits)
160 - 174 MHz	10 MHz	162 - 172 MHz (3 dB Degradation at limits)

MONOGRAM SERIES LBI-38864B

SPECIFICATIONS

OPTIONS AND ACCESSORIES

CONTROL STATION OPTIONS:



Power Supply MGPS5V



External Speaker MGZM7C



Desk Microphone MGMC5H

NOT SHOWN:

Antenna - MGAN1A

Relay Kit - MGSU1C

Noise Suppression Kit - MGPD1A

MONOGRAM SERIES LBI-38864B

UNPACKING

UNPACKING

Check the carton and packing material carefully for the following items:

1. Transceiver Unit
2. Microphone
3. DC power Cord
4. Mobile Mounting Bracket
5. Assembly Hardware
6. Operating Guide

Styrofoam not used

Inner packing is now cardboard tray box.

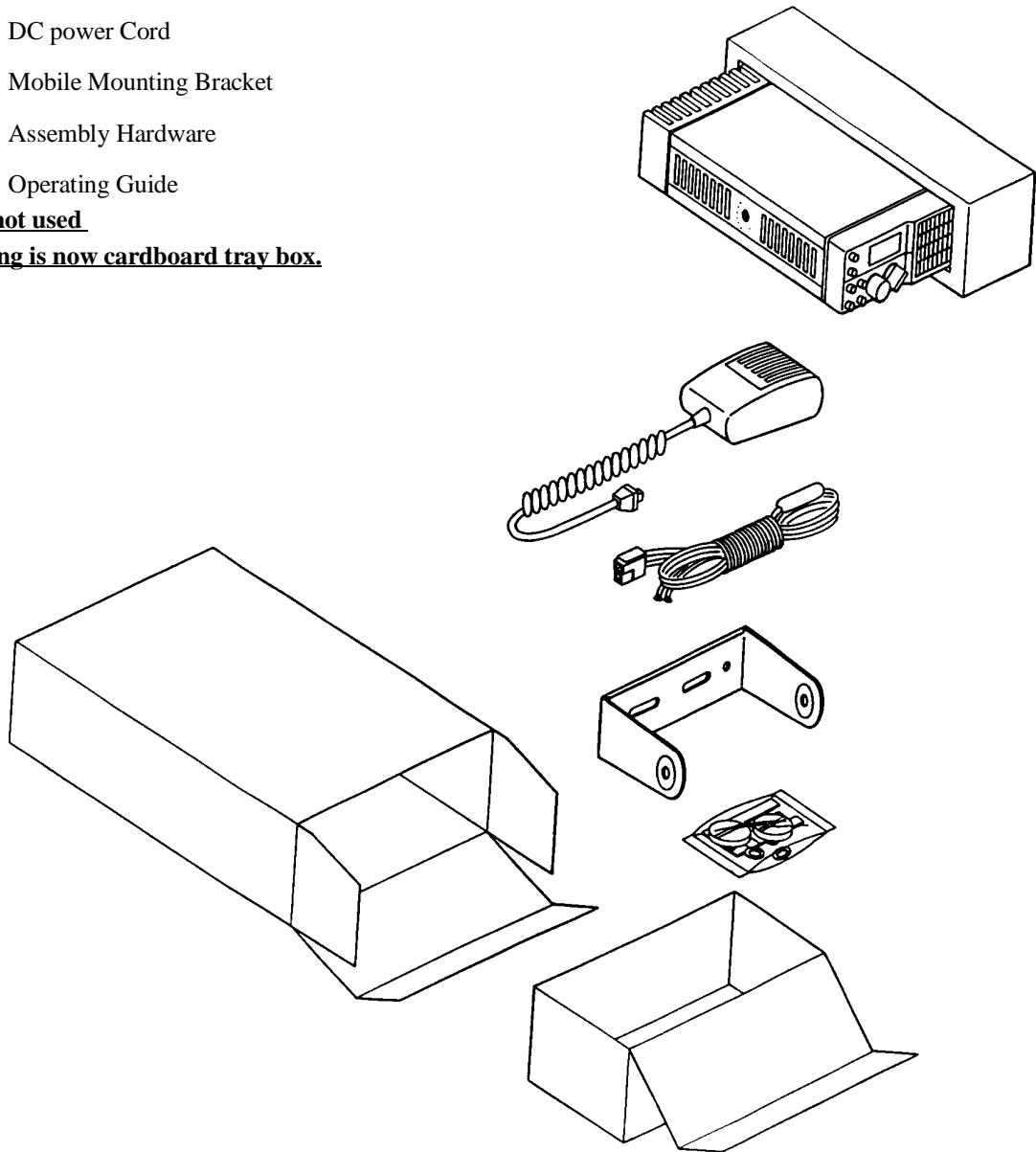

FIGURE 1 - Unpacking Diagram

MONOGRAM SERIES LBI-38864B

GENERAL DESCRIPTION

GENERAL DESCRIPTION

Introduction

The Conventional Monogram Series Radio is a rugged, two-way FM mobile radio which operates in either the 148-165 MHz band split or the 160-174 MHz band split. The Monogram is a synthesized radio utilizing microcomputer technology to provide reliable high-quality simplex two-way mobile communications. Its transmitter output power level is 40 watts over the wide bandwidth, with an allowable 10 MHz maximum receive channel separation. The basic radio package includes the following features:

Features

- * **Microprocessor Control**
- * **Synthesized RF Channel Selection (Frequency Control)**
- * **Vacuum Fluorescent Channel Selection Display**
- * **Channel Guard (CTCSS) Encode/Decode**
- * **Digital Channel Guard (DCS Encode/Decode)**
- * **Priority Scan**
- * **± 5 PPM Frequency Stability**
- * **Field Programmable with PC**
- * **Variable Squelch**
- * **Internal 5-watt Speaker, with Volume Control**
- * **Side Mounted Microphone Connector**
- * **Rear Mounted Antenna Connector (SO-239)**
- * **Rear Power Connections**

The small size of the Monogram radio makes it ideal for front mounting in conventional vehicles. The radio is operated with a simple hand-held microphone in combination with the operating controls described in the following section.

MONOGRAM SERIES LBI-38864B

DESCRIPTION OF CONTROLS

DESCRIPTION OF CONTROLS

FRONT PANEL CONTROLS

1. **SQUELCH Control:** The squelch control will silence the receiver when no signal is being received.
2. **ON/OFF/VOLUME Control:** This is the main power switch and volume control.
3. **Monitor Button (2):** This button performs three functions:
 - a. Disables tone or digital squelch options when in receive mode.
 - b. Returns to normal radio operation from the programming mode.
 - c. Controls display intensity.
4. **Auxiliary Speaker Button (1):** This button silences the internal speaker and connects the auxiliary speaker (requires the auxiliary option printed circuit board to be installed). It also deletes channels from the scan list while in the programming mode.
5. **SCAN Push Button (S):** This button turns the scan function "ON" (indicated by a red backlight) and "OFF". It also serves as the ENTER function during SCAN programming.
6. **PRIORITY SCAN Push Button (P):** This button turns the PRIORITY SCAN function "ON" (indicated by a red backlight) and "OFF". It also provides access to the programming mode when the radio is turned on.
7. **Channel Change buttons (CH):** The channel change buttons allow the operator to scroll either up or down through the programmed channels.
8. **Call Light Indicator (CALL):** This green Light Emitting Diode (LED) indicator illuminates to indicate activity on the channel during receive when coded squelch or digital signaling options are used.
9. **Busy Channel Indicator (BUSY):** This yellow Light Emitting Diode (LED) indicator illuminates to indicate activity on the channel during receive.
10. **Transmit LED Indicator (TX):** This red Light Emitting Diode (LED) indicator illuminates during transmit mode. It also will flash to indicate that the synthesizer is out of lock.
11. **Channel Display:** The front panel display indicated channel number, priority scan numbers, programming mode and error messages.

FIGURE 2 - Front Panel Controls

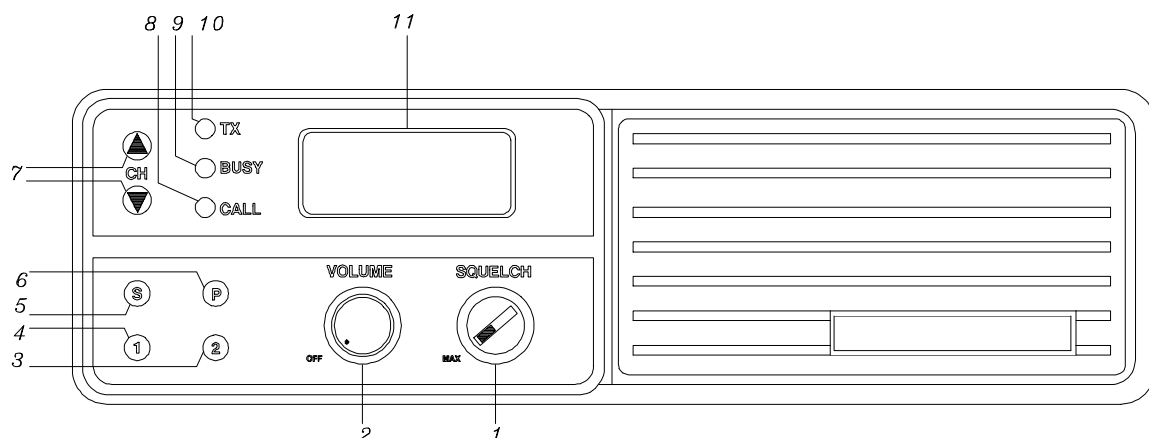

MONOGRAM SERIES LBI-38864B

DESCRIPTION OF CONTROLS

BACK PANEL CONNECTORS

1. External Speaker Connector: This 3.5mm diameter jack is provided for a 4 ohm external speaker. The internal speaker is silenced when the external speaker is connected.
2. Auxiliary Speaker Connector: This 3.5mm diameter jack is provided for an auxiliary speaker (Option MGSU1C Relay Kit is required).
3. Antenna Connector: An SO-239 type connector. The output load must be 50 ohms.
4. DC 13.8V Connector: Polarized plug for 13.8 VDC power input-FOR NEGATIVE GROUND SYSTEMS ONLY.

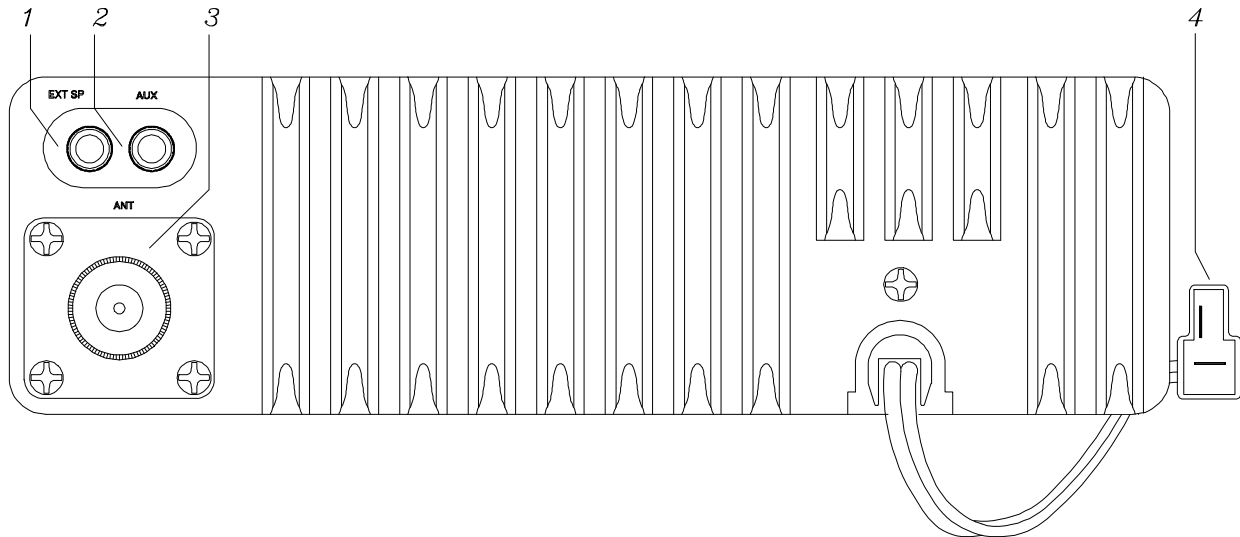

FIGURE 3 - Back Panel Controls

MONOGRAM SERIES LBI-38864B

GENERAL OPERATION

GENERAL OPERATION

- **NOTE:** *The following description briefly outlines the operation of your VHF synthesized mobile radio. Consult the operator's manual for a complete description of all the modes of operation.*

RADIO ON/OFF, POWER UP

1. Turn the radio on by turning the VOLUME control one-half turn clockwise. After "4000" appears in the display and the power up alert tone is generated, the display will change to the #1 priority channel. If no priority channel has been programmed, the display will change to channel 1.
2. Turn the radio off by rotating the VOLUME control fully counter-clockwise.

RECEIVING

1. Turn the radio on and select the desired channel.
 2. Depress the MONITOR button (2) if necessary to illuminate its backlight. Adjust the volume control to a comfortable listening level.
 3. Rotate the SQUELCH control clockwise until the squelch noise (rushing sound) is no longer present.
 4. Depress the MONITOR button (2) to extinguish the black light.
- **NOTE:** *If the radio is equipped with coded squelch options, depress the MONITOR button (2) to enable the option; the CALL indicator will no longer be illuminated.*

TRANSMITTING

1. Turn the radio on and select the desired channel.
2. Pick up the microphone and listen briefly to insure the channel is clear. Alternatively, leave the microphone on-hook and depress the MONITOR button (2).
3. Depress the PTT switch on the side of the microphone. Hold the microphone one to two inches from the mouth and speak in a normal tone of voice. The TX indicator should be illuminated.
4. Release the PTT switch when the message is completed.

MONOGRAM SERIES LBI-38864B

GENERAL OPERATION

DIGITAL CHANNEL GUARD

Channel Guard provides a means of restricting calls to specific radios through the use of a CTCSS (Continuous Tone Coded Squelch) or DCS (Digitally Coded Squelch). The tone frequencies range from 67 Hz to 250.3 Hz and there are 83 programable codes.

Channel Guard tone frequencies and codes are software programmable. Both tone frequencies and digital codes may be mixed on each channel. The frequencies and codes are shown in Tables 1 and 2. A Channel Number display that does not flash, indicates that Channel Guard is not programmed. A flashing Channel Number indicates that Channel Guard is programmed and disabled.

Table 1 - Channel Guard Tone Frequencies

67.0	71.9	74.4	77.0	79.7	82.5	85.4	88.5
91.5	94.8	97.4	100.0	103.5	107.2	110.9	114.8
118.8	123.0	127.3	131.8	136.5	141.3	146.2	151.4
156.7	162.2	167.9	173.8	179.9	186.2	192.8	203.5
210.7	218.1	225.7	233.6	241.8	250.3		

Table 2 - Primary DCS Codes

023	114	174	266	411	506	703
025	115	205	271	412	516	712
026	116	212	274	413	523	723
031	122	223	306	423	526	731
032	125	225	311	431	532	732
036	131	226	315	432	546	734
043	132	243	325	445	565	743
047	134	244	331	446	606	754
051	143	245	332	452	612	
053	145	246	343	454	624	
054	152	251	346	455	627	
065	155	252	351	462	631	
071	156	255	356	464	632	
072	162	261	364	465	654	
073	165	263	365	466	662	
074	172	265	371	503	664	

MONOGRAM SERIES LBI-38864B

CIRCUIT ANALYSIS

CIRCUIT ANALYSIS

RECEIVER

RF Amplifier

Incoming signals from the antenna jack are routed backwards through the transmitter lowpass filter in PIN diode switch D12. In receive mode, D12 conducts allowing a low impedance path through the diode to the receiver front end circuitry. The receiver RF amplifier section is comprised of two bandpass filter sections separated by an amplifier based around Q1. These two filters allow signals at or near the operating frequency to pass but provide strong rejection of the mixer's spurious response frequencies. The first filter section is a two pole design formed around RF transformers T1, T2 and their associated circuitry. This filter is followed by the RF amplifier transistor Q1. This device is a dual-gate MOSFET which, with its low noise figure, yields good receiver sensitivity while showing strong resistance to overload from strong signals. The output of Q1 drives a three-pole filter section formed around T3, T4 and T5. The output of the RF amplifier stage is routed to the first mixer.

First Mixer and First IF Amplifier

The action of the first mixer transistor Q2 is to convert incoming signals at the operating frequency to the frequency of the first IF which is 21.4 MHz. The output of the mixer is at a frequency which is equal to the difference between the frequency of the incoming signal and the local oscillator. In this radio, the local oscillator signal is chosen to be 21.4 MHz below the operating frequency. The device chosen to perform the mixing operation is Q2, a high performance JFET. The incoming signal is applied to the gate of Q2, and the local oscillator signal is filtered by transformers T6, T7 and associated circuitry before being supplied to the drain of Q2. The difference frequency signal at 21.4 MHz exits the mixer at the source of Q2 drives the first IF filter XF1 and XF2. XF1 and XF2 form a 4-pole monolithic crystal filter pair which in part determines the selectivity of the radio. The output of the crystal filter is routed to the first IF amplifier formed around Q3. RF transformer T8 and T9 provide proper matching of the crystal filters to insure good pass band response and selectivity.

Second Mixer, Second IF, and FM Detector

The output of Q3 is applied to the input (pin 16) of IC2. IC2 is a single conversion FM receiver on one integrated circuit chip. The signal at the input is routed straight to a mixer which converts the incoming signal to the second IF frequency of 455 kHz. The second local oscillator is formed with crystal X1 and circuitry within IC2. The output of the second mixer is at pin 23 which is connected to a ceramic bandpass filter CF1 and centered at 455 kHz. This filter, along with XF1 and XF2, determine the adjacent channel selectivity of the radio. The output of CF1 drives a high gain IF amplifier chain internal to IC2 which in turn drives the quadrature detector. The output of the detector is amplified and exits IC2 at pin 9.

Audio

Detected audio from IC2 passes through a lowpass filter formed around L7, C53 and C52 which removes IF frequency components at 455 kHz. The audio signal then passes through buffer amplifier transistor Q6 before being filtered by a two section, 4-pole high pass filter (IC3) This filter removes DCS and CTCSS low frequency tones from the recovered audio. Transistors Q7 and Q8 act as switches around volume control VR2 to mute the audio during squelched receive operation. The audio signal is finally routed to audio power amplifier IC5 and then to the speaker.

MONOGRAM SERIES LBI-38864B

CIRCUIT ANALYSIS

Squelch

The presence of an RF carrier is determined by noting the level of ultrasonic noise at the detector output (pin 9) of IC2. When a carrier is present, the noise level drops. The audio at pin 9 of IC2 is filtered by a two-pole bandpass filter formed around L5, L6 C48 and C50. This filter passes at and near an audio frequency of 50 kHz. This frequency is high enough that voice audio and its harmonics will not cause improper squelch operation. The output of the filter is routed to an amplifier internal to IC2. The output of the amplifier drives the squelch detector D7 and D8. The DC voltage at the detector output is amplified and filtered by Q4. The output of Q4 sends its squelch signal to the microprocessor. When the microprocessor determines that a valid carrier exists, it sends an unmute signal to the audio switch transistors Q7 and Q8.

TRANSMITTER

Audio

The microphone audio is amplified, pre-emphasized and peak limited by circuits within IC113. The output of the limiter is routed through RV4, the microphone; deviation control. Input CTCSS and routed DCS signals are routed through RV5, the CTCSS/DCS deviation control. Both signals are summed and lowpass filtered to remove high frequency components from the limiter which could cause channel splatter. When the microprocessor enables the TX 8 Volt supply, analog gate IC115 delivers the modulation signal to the VCO transistor Q112.

RF Driver and Power Amplifier

Diode D9 acts as a switch allowing the RF signal from the phase locked loop frequency synthesizer to pass through to the RF driver and power amplifier during receive. Buffer amplifier Q9 amplifies the carrier to the level needed by the driver amplifier stages. The driver amplifiers, of which the last 2 stages are gain controlled by the automatic power control, drive the final amplifier stage formed around Q12. The final amplifier boosts the carrier level to the power level set by the automatic power control. The carrier signal passes through the automatic power control directional coupler, the RF output lowpass filter, and then is routed to the antenna connector.

Automatic Power Control

The automatic power control directional coupler samples a portion of the forward RF power output to determine the RF level. Diode D10 rectifies this RF sample and produces a DC voltage which is proportional to the RF output level. This DC signal is summed with the voltage set from the power output control RV2. This voltage is compared with a voltage derived from the TX 8 Volt supply and the difference is amplified by IC4. The output is further amplified by Q14 and Q13. The output voltage on Q13 is the supply voltage for the RF driver stage. The output of the RF driver is proportional to its supply voltage. This completes a negative feedback loop which results in constant output power over supply voltage and temperature variations.

FREQUENCY SYNTHESIZER

The phase locked loop (PLL) frequency synthesizer section is responsible for generating the RF signal at the carrier frequency during transmit and at the local oscillator frequency for the receiver during receive. A PLL functions by comparing the output frequency of a voltage controlled oscillator (VCO) with a fixed frequency reference. An error signal is generated which drives the control input of the voltage controlled oscillator to force its frequency to match the reference. The PLL based frequency synthesizer has a digital frequency divider inserted between the output of the VCO and the frequency comparison circuitry. As this divider number is varied, the output frequency of the VCO varies as well with a frequency step size equal to the reference frequency (5 kHz in this radio). This allows a large range of frequencies to be generated with one well controlled oscillator signal, the reference.

PLL Integrated circuit

IC108 contains most of the digital circuitry to form a PLL frequency synthesizer. This includes a reference oscillator, programmable variable frequency divider, a modulus control counter, a phase/frequency comparator and a frequency lock detector. The operation of this integrated circuit is controlled by the radio's microprocessor through a serial data line.

MONOGRAM SERIES LBI-38864B

CIRCUIT ANALYSIS

Reference Oscillator

Crystal X3, varactor diode D119, a thermistor/resistor network and oscillator stage of IC108 form a temperature compensated 10.24 MHz oscillator. This frequency is divided by 2084 to generate the 5 kHz reference frequency for the PLL frequency synthesizer. This reference determines the frequency stability of the overall radio.

Voltage Controlled Oscillator

FET transistor Q112 and its associated circuitry form a grounded gate oscillator which is voltage tuned by varactor diodes D120 and D121 and which is bandswitched by diodes D122 and D123 (D126 and D127 for Low band). The VCO output is buffered and isolated by Q113, Q114 and Q119. Audio modulation is applied to the source of Q112 to produce frequency modulation during transmit.

Dual Modulus Prescaler

The internal dividers within IC108 are not able to operate at the VCO output frequency. To alleviate this problem, part of the overall frequency division necessary between the VCO and the phase/frequency comparator is placed external to, and controlled by, IC108. IC109 divides the VCO frequency by 64 or 65, determined by the state of IC108 pin 6. This produces a lower frequency which can be further divided by IC108. By strategic timing when to divide by 64 or 65, the overall division will be that necessary to put the VCO on the correct frequency.

Loop Filter

Resistors R316, R323, R324, R325, R326 and capacitors C263, C264 and C265 form the loop filter. The purpose of the loop filter is to filter out the 5 kHz reference frequency products from the output of phase/frequency comparator IC108 and to determine the dynamic operation of the overall loop.

R315, C262, Q107 and Q108 act to speed up operation of the synthesizer loop during channel changes and during frequency transition (receive to transmit and transmit to receive).

Out-Of-Lock Detector

IC108 contains a circuit which compares the timing difference of the 5 kHz reference frequency and the divided down VCO frequency. The output is a 5 kHz pulse whose duration is equal to the timing difference. R312 and C295 filter this pulse and average it producing a DC voltage which is proportional to the pulse width. When the loop is in lock, this voltage is zero, but when the loop is out of lock, this voltage rises to a level which will forward bias Q106. The output of Q106 drives the microprocessor. The microprocessor will not allow the radio to transmit unless the synthesizer is in lock. This is to prevent out of band signals from being transmitted.

MONOGRAM SERIES LBI-38864B

PREVENTIVE MAINTENANCE

PREVENTIVE MAINTENANCE

To ensure high operating efficiency and to prevent mechanical and electrical failures from interrupting system operations, routing checks should be made of all mechanical and electrical parts at regular intervals. Preventive maintenance should include the following checks:

CONNECTIONS

Ground connections to the voltage source should be periodically checked for tightness. Loose or poor connections to the power source will cause excessive voltage drops and faulty operation. When ground connections are not made directly to the battery, the connection from the battery to vehicle chassis must be checked for low impedance. A high impedance may cause excessive voltage drops and alternator noise problems.

ELECTRICAL SYSTEM

Check the voltage regulator and alternator or generator periodically to keep the electrical system within safe and economical operation limits. Over voltage is indicated when the battery loses water rapidly. Usage of 1 or 2 ounces of water per cell per week is acceptable for batteries in continuous operation. A weak battery will often cause excessive noise or faulty operation.

MECHANICAL INSPECTION

Since mobile units are subject to constant shock and vibration, check for loose plugs, nuts, screws and other parts to make sure that nothing is working loose.

ANTENNA

The antenna, antenna base and all contacts should be kept clean and free from corrosion. If the antenna or its base should become coated or poorly grounded, loss of radiation and a weak signal will result.

ALIGNMENT

The transmitter and receiver meter readings should be checked periodically, and the alignment "touched up" when necessary. Refer to the Alignment Procedure in this Service Manual.

FREQUENCY CHECK

Check the transmitter frequency and deviation. Normally, these checks are made when the unit is first put into operation, after the first six months, and once a year thereafter.

MONOGRAM SERIES LBI-38864B

DISASSEMBLY

DISASSEMBLY

TOP AND BOTTOM COVERS

There are no screws used to secure the top and bottom covers. Both top and bottom covers are removed with a flat blade screwdriver or similar tool. On each side of the radio there are two small slots (one at the top and one at the bottom). Insert the screwdriver into the slot and gently pry the lip of the cover out from the radio. Without removing the screwdriver from the slot and in the same motion, pry the cover up. Both covers can be removed from either side of the radio.

FRONT PANEL

1. Remove the (6) M3 x 6 machine screws (3 on top and 3 on bottom) that secure the Front Panel to the chassis.
2. Two cables connect the Control Board to the RF Board (at PL1) and to the Digital Board (at PL2). These cables may be unplugged at the RF Board and at the Digital Board. A ribbon cable from the Display Board is connected to the Digital Board (at FLT) and may be unplugged to remove it.

RF BOARD

- *NOTE: Any reference to item's in the following disassembly procedure pertain to the Exploded View Parts Breakdown page.*
1. Remove the (13) M3 x 24 machine screws securing the RF shield to the chassis.
 2. Remove the M3 x 8 machine screw that secure the DC Cord bracket to the chassis. Slide the bracket and cord out of the chassis.
 3. Remove the (6) M3 x 6 machine screws (3 on top and 3 on bottom) that secure the Front Panel to the chassis.
 4. Remove the RF shield by pushing the Front Panel forward so the shield will clear and then sliding the DC Cord, bracket and connector through the rectangular hole in the shield.
 5. De-solder the antenna connector from the RF Board.
 6. Remove the remaining (11) machine screws securing RF Board, IC1, Q11 and Q13.
 7. Unplug the VCO cable from the jack and remove the RF Board

MONOGRAM SERIES LBI-38864B

DISASSEMBLY

DIGITAL BOARD

1. Remove the (6) M3 x 18 machine screws that secure the Top Panel shield to the chassis.
2. Unplug and remove the Auxillary Relay P.C.B. at PL5.
3. Remove the (6) machine screws (3 on top and 3 on bottom) that secure the Front Panel to the chassis.
- *The following steps detail the removal of the RF shield which is necessary before continuing with the removal of the Digital Board.*
4. Remove the (13) M3 x 24 machine screws securing the RF shield to the chassis.
5. Remove the M3 x 8 machine screw that secure the DC Cord bracket to the chassis. Slide the bracket and cord out of the chassis.
6. Remove the RF shield by pushing the Front Panel forward so the shield will clear and then sliding the DC Cord, bracket and connector through the rectangular hole in the shield.
7. Unplug the VCO cable from the jack.
8. Remove the remaining (10) screws securing the Digital Board, IC5, IC6 and IC104 to the chassis.
9. The Digital Board can now be removed from the chassis, however the Front Panel assembly is still attached by two cables (one from the Control board and one from the Display board). The cable from the Control Board at PL2 may be unplugged. The ribbon cable from Digital Board may be unplugged at FLT.

MONOGRAM SERIES LBI-38864B

PROGRAMMING INSTRUCTIONS

PROGRAMMING INSTRUCTIONS

The VHF synthesized mobile radio is equipped with a personality EEPROM. All customer information such as the customer frequencies, customer tones and customer options are stored in the EEPROM. The EEPROM contains all information to tailor the operation of the radio to the user's requirements. The EEPROM is programmed by using an IBM compatible personal computer with MSDOS, Programming Cable TQ-3376 and Programming software TQ-3375.

PROGRAMMING THE RADIO

The programming Cable TQ-3376 is a Y-cable. The base of the "Y" has a standard 25 pin connector which plugs into the computer, the remaining end has a 6 pin connector which fits into the connector PL1 on the digital board inside the radio. To use this cable, remove the top cover of the radio as described in the DISASSEMBLY section. Plug the 6 pin connector into the socket inside the radio (PL1), which is located near the EEPROM IC107. Plug the base of the "Y" into the computer that will program the radio. See the diagram in TQ-3375 Software Manual. In order to program the radio with the programming cable, it is necessary to put the radio into the programming mode. To do this, press the **P** "Priority" button/LED on the radio and turn the radio ON. The radio will sound a prompt tone and show the words "PROG" on the display. Please refer to the Software Manual for further instructions on the operation of the Programming Software. After completing the programming instructions in the Manual, remove the cable from PL1 and replace the cover on your VHF synthesized mobile radio.

MONOGRAM SERIES LBI-38864B

TEST EQUIPMENT SETUP

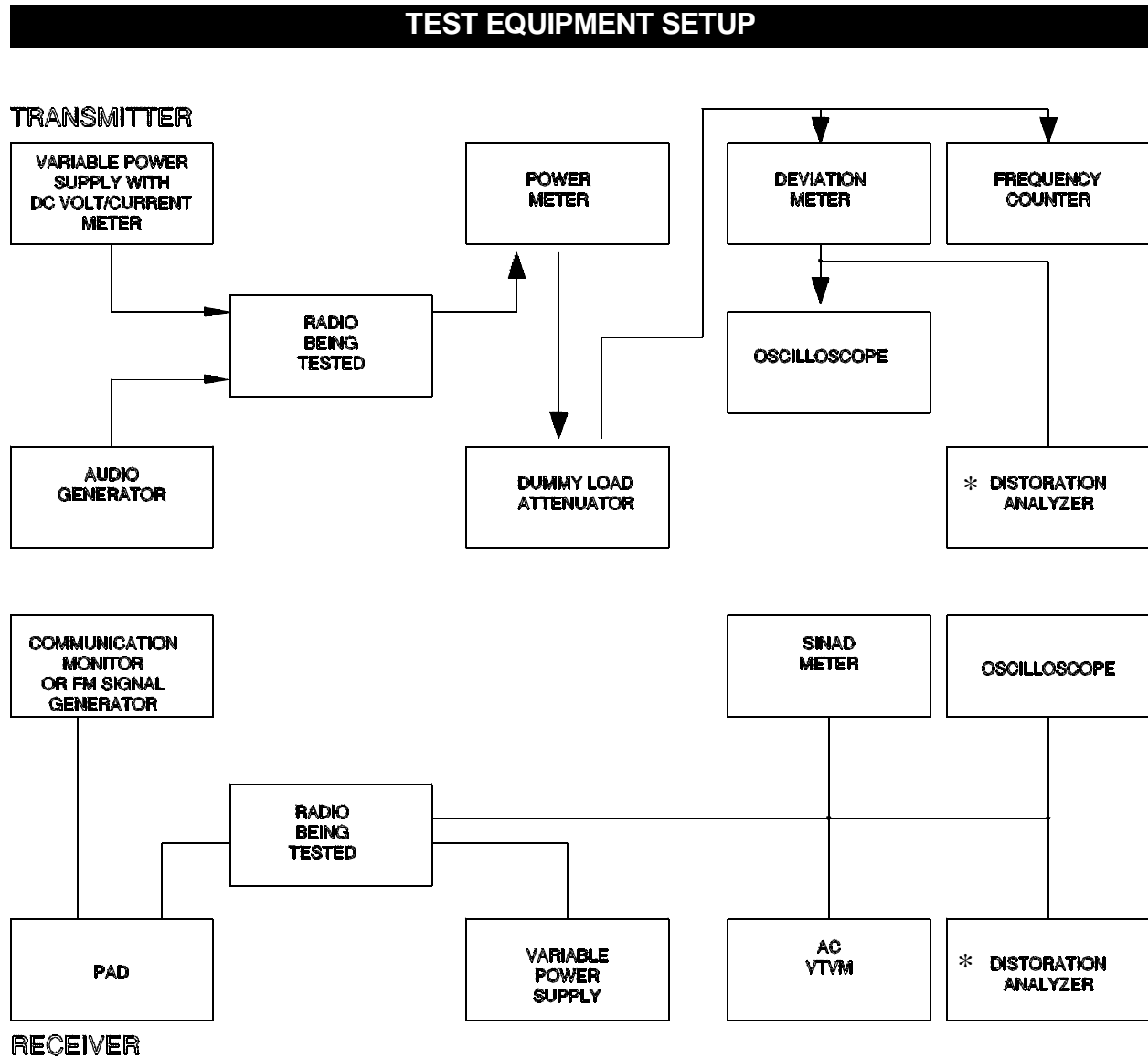

Figure 4 - Test Equipment Setup

* Optional Test Equipment

MONOGRAM SERIES LBI-38864B

ALIGNMENT PROCEDURE

ALIGNMENT PROCEDURE

- **WARNING:** Any repairs or adjustments should be made under the supervision of a certified technician.

SUGGESTED TEST EQUIPMENT

The following equipment, or its equivalent, is required for proper alignment of your VHF synthesized mobile radio:

1. Termlaine Watt meter, or Through-line Watt meter with termination into 50 ohm dummy load.
2. AC/DC VOM with a minimum of 1 M Ω input impedance.
3. SINAD Meter.
4. FM Communications Monitor.
5. Regulated Power Supply capable of 9 volts to 16 volts adjustable; at least 10 ampere capability.
6. Oscilloscope.
7. Audio Distortion Meter (desirable but not necessary).
8. Frequency Counter.

PRE-ALIGNMENT NOTES:

1. Refer to the Alignment Points Drawings as required for location of components.
2. The VHF synthesized mobile radio covers the following frequency ranges, 148-165 MHz band and 160-174 MHz band, without component changes.
3. The radio has been factory aligned for operation within the center 10 MHz portion of each of the bands. If operation is to be within this range, no further alignment is necessary. If operation outside this range (but still within the appropriate frequency band) is desired, the following alignment procedure should be performed.

PROGRAMMING FOR ALIGNMENT

For the alignment procedures the EEPROM should be programmed as follows:

1. An EEPROM should be programmed with 3 transmit and 3 receive frequencies.
2. The lowest and highest frequencies should enclose the user's frequencies and be 8 MHz apart. The lowest and highest frequencies must be within the appropriate frequency band.
3. In addition to programming frequencies, CTCSS and DCS codes must also be programmed to insure that the modulation deviation for these potential options is correct, even if they are not to be used for the customer's operation. The following format should be used:

Lowest RX/TX frequency	67.0 Hz CTCSS Tone
Middle RX/TX frequency	DCS Code 072
Highest RX/TX frequency	250.3 Hz CTCSS Tone
Highest RX/TX frequency	No Tone Options

MONOGRAM SERIES LBI-38864B

ALIGNMENT PROCEDURE

4. The middle RX/TX frequencies should be halfway between the lowest and the highest frequencies.

- **NOTE:** There should be 4 channels programmed with a total of 3 different frequencies.

PLL ALIGNMENT

1. Connect an RF dummy load or power attenuator (50 watt minimum rating) to the antenna connector.
2. Connect a VOM or DVM to TP1, accessed through a hole in the VCO cover.
3. Set the CHANNEL selector to the highest transmit frequency.
4. Press the push-to-talk (PTT) switch. Adjust TC5 for a 7.0 VDC reading on the VOM. Release the PTT switch.
5. Change the CHANNEL selector to the lowest transmit frequency.
6. Press the PTT switch. The VOM should read 1.5 VDC \pm 0.2V VDC. If not, re-adjust TC5 slightly for a 1.5 VDC reading. Release the PTT switch.
7. Return to the highest transmit channel and verify that the TP1 voltage does not exceed 8 volts in transmit. On the lowest transmit frequency, the voltage must be 1.5 \pm 0.2 VDC, and on the highest transmit frequency, the voltage must be less than 7.5 VDC. Repeat steps 3 through 6 if necessary.
8. Set the CHANNEL selector to the lowest receive frequency.
9. Adjust TC3 to obtain a 2 VDC reading on the VOM.
10. Change the CHANNEL selector to the highest receive frequency. Verify that the DC voltage does not exceed 7.0 VDC. If it does, re-adjust TC3 for a 7.0 VDC reading.
11. The following chart shows typical voltages at TP1:

CHANNEL	TP1 VOLTAGE	
	TRANSMIT	RECEIVE
Lowest Frequency	1.5 VDC	2.0 VDC
Highest Frequency	7.5 VDC	7.0 VDC

TRANSMITTER

TRANSMITTER ALIGNMENT

1. Connect a 50 ohm RF dummy load or a power attenuator (50 watt minimum rating) through a watt meter (50 watt scale) to the antenna connector.
2. Turn RV2 (Automatic Power Adjustment) fully clockwise.
3. Connect variable DC power supply (10 Ampere capability) to the DC power cable on the radio. Set the voltage to 12 VDC measured at the radio during transmit. (Voltage drops in the power cable during transmit will lower the voltage at the radio).
4. Set the CHANNEL selector to a mid-frequency transmit channel.
5. Press the PTT switch.
6. Adjust RV2 for 40 watts, or the desired power output (10 - 40 watts). Release the PTT switch.

MONOGRAM SERIES LBI-38864B

ALIGNMENT PROCEDURE

- **WARNING:** To prevent damage to the radio, avoid keying the radio for periods longer than 1 minute. Allow a 5 minute cool down period after keying the radio for 1 minute.

7. Repeat step 6 above for the lowest, middle, and highest frequency transmit channel with the goal to achieve the least variation in power output across the band.

8. Increase the power supply voltage to 13.8 VDC measured at the radio during transmit.

DCS Modulation Balance Adjustment

1. Connect test equipment to the radio as shown in Figure 4.

2. Set the CHANNEL selector to a transmit channel which has a DCS code pre-programmed (should be mid-frequency channel).

- **WARNING:** The power attenuator must have enough attenuation to prevent damage to the Deviation Meter.

3. Press the PTT switch.

4. Observe the wave form on the Oscilloscope and compare with that shown in Figure 5.

5. Adjust RV5 and TC7 to achieve the proper wave form. Release the PTT switch.

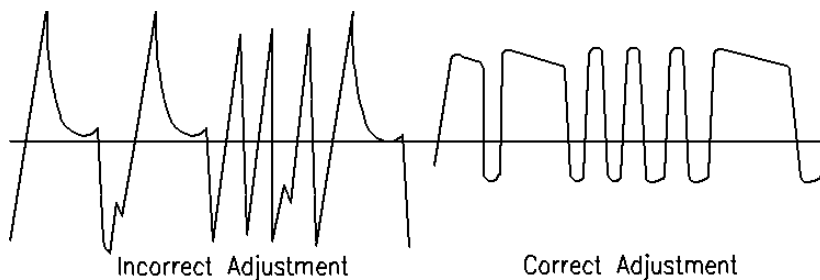

DCS Modulation Waveform

6. Replace the deviation meter with a frequency counter.

7. Set the CHANNEL selector to the highest transmit channel. Ensure that this channel has no DCS or CTCSS tones pre-programmed.

8. Press the PTT switch. Adjust TC6 for the correct transmit frequency. Release the PTT.

- **NOTE:** TC7 should not be allowed to be placed at the maximum capacitance position. If TC7 is found to be at the maximum capacitance position, place TC7 at the typical position and adjust RV5 for the proper wave form.

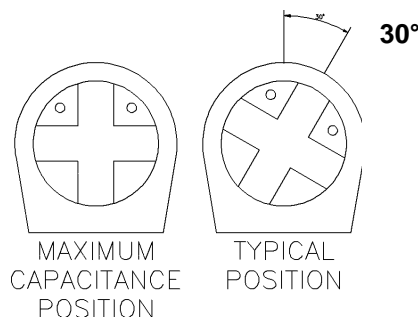

TC7 Maximum Capacitance Position

MONOGRAM SERIES LBI-38864B

ALIGNMENT PROCEDURE

Modulation Deviation Adjustment

1. Connect an RF deviation meter to the radio through a power attenuator.
2. Set the CHANNEL selector to a transmit channel which has a DCS code pre-programmed (should be a mid-frequency channel).
3. Press the PTT switch.
4. Adjust RV3 for proper deviation, typically 750 Hz. Release the PTT switch.
5. Set the CHANNEL selector to a transmit channel which has a low-frequency CTCSS tone (67.0Hz) preprogrammed.
6. Press the PTT switch and verify that the deviation is between 500 Hz and 1000 Hz. Release the PTT switch.
7. Set the CHANNEL selector to a transmit channel which has a high-frequency CTCSS tone (250.3 Hz) preprogrammed.
8. Press the PTT switch and verify that the deviation is between 500 Hz and 1000 Hz. Release the PTT switch. If deviation is above or below 500-1000 Hz, adjust RV 401 (filter) to same level as obtained in Step 6.
9. Connect an audio frequency generator to the MIC input (connected to the white wire in the microphone cable) of the radio. Set the audio output level for 30 mV. The audio frequency should be 1 kHz.
10. Press the PTT switch.
11. Adjust RV4 (Maximum Deviation Adjustment) for the 4.2 kHz deviation if no CTCSS tones are present, and 4.8 kHz deviation if CTCSS tones are present.

RECEIVER ALIGNMENT

1. Connect an RF signal generator or communications service monitor to the antenna connector.
 2. Connect a SINAD meter and an audio distortion analyzer across the speaker terminals. If an audio distortion analyzer is not available, connect an oscilloscope across the speaker terminals.
 3. Turn the SQUELCH control fully counter-clockwise.
 4. Adjust the VOLUME control to the proper level for the sinad meter and audio distortion analyzer.
 5. Set the CHANNEL selector to a mid-frequency receive channel.
 6. Tune the RF signal generator to the channel frequency. The RF output level should be set for 47 dBm. The modulation should be set for ± 3 kHz FM deviation of a 1 kHz tone.
 7. Adjust T10 for maximum audio output. Readjust the VOLUME control if necessary to avoid clipping on the output audio wave form. (This adjustment is typically not required.)
 8. Decrease the RF generator output and adjust T1 through T5 for maximum sensitivity.
- **NOTE: During this adjustment signal generator level should be reduced periodically to keep the Sinad meter reading near 12 dB.**

MONOGRAM SERIES LBI-38864B

ALIGNMENT PROCEDURE

9. Adjust T6 and T7 for maximum sensitivity. These adjustments have a very broad range where little change in sensitivity is noted while the adjustment is being made. The slugs should be set in the middle of this range.
10. Check the sensitivity at the lowest and highest receive frequencies. If necessary, repeat steps (8) and (9) above at the lowest middle and highest frequencies for the best overall sensitivity.

Receiver Squelch Adjustment

1. Set the channel selector for the mid-frequency receive channel.
 2. Connect an RF signal generator or communications service monitor to the antenna connector. The modulation should be set for ± 3 kHz FM modulation of a 1 kHz tone. The RF output level should be at a minimum.
 3. Adjust the squelch control to the threshold point (the point where the speaker audio disappears).
 4. Increase the RF signal generator output level until speaker audio output reappears. Note the generator level.
 5. Turn the SQUELCH control fully clockwise.
 6. Increase the RF signal generator level by 16 dB.
 7. Adjust RV1 until the squelch is again at threshold.
- ***NOTE: This squelch adjustment procedure is very important for the correct operation of the microprocessor aided squelch system.***

MONOGRAM SERIES LBI-38864B
ALIGNMENT POINTS 406041-F Issue:H DIGITAL BOARD

ALIGNMENT POINTS 406041-F Issue:H DIGITAL BOARD

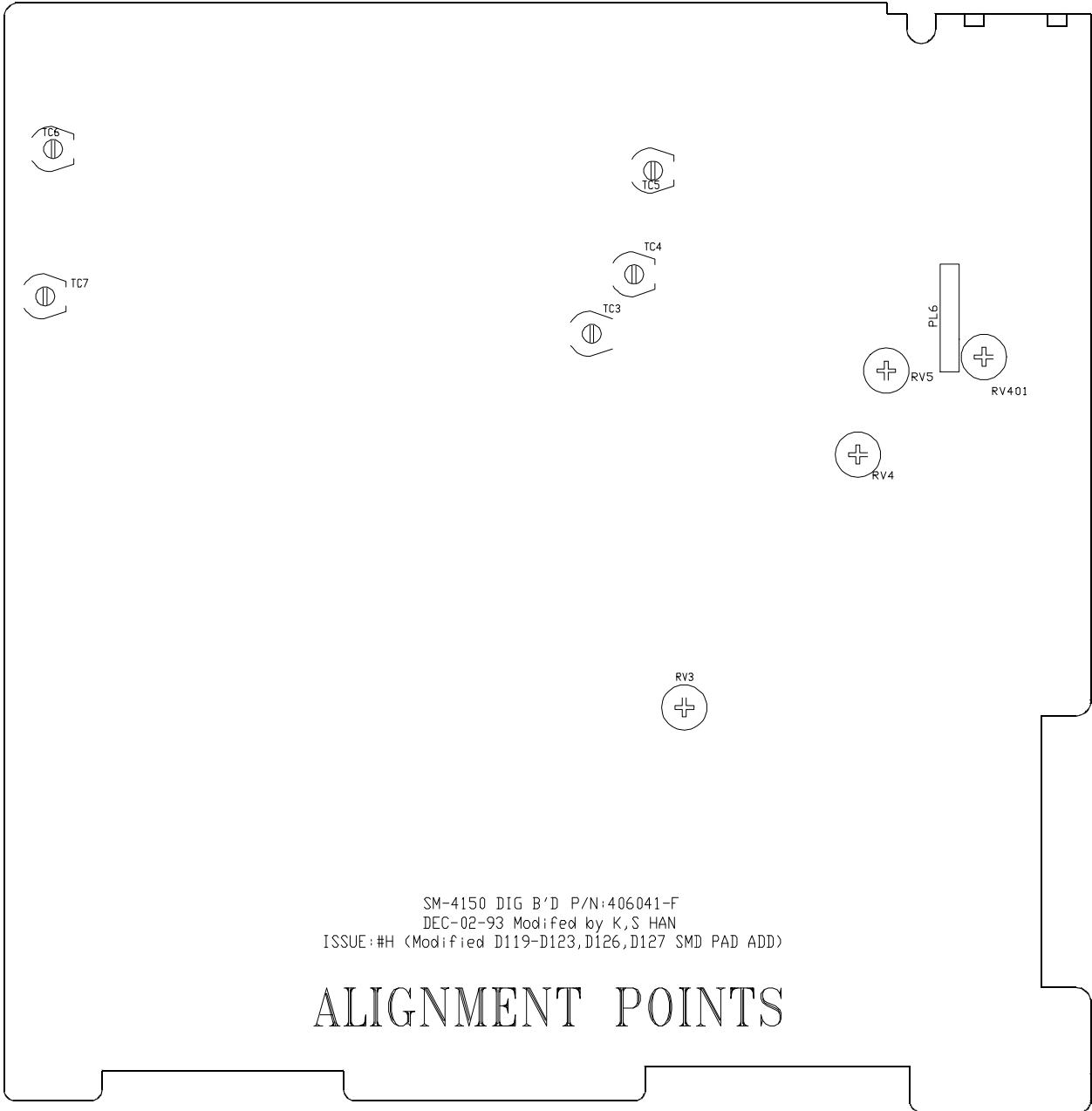

MONOGRAM SERIES LBI-38864B

ALIGNMENT POINTS 406039-E Issue:H RF BOARD

ALIGNMENT POINTS 406039-E Issue:H RF BOARD

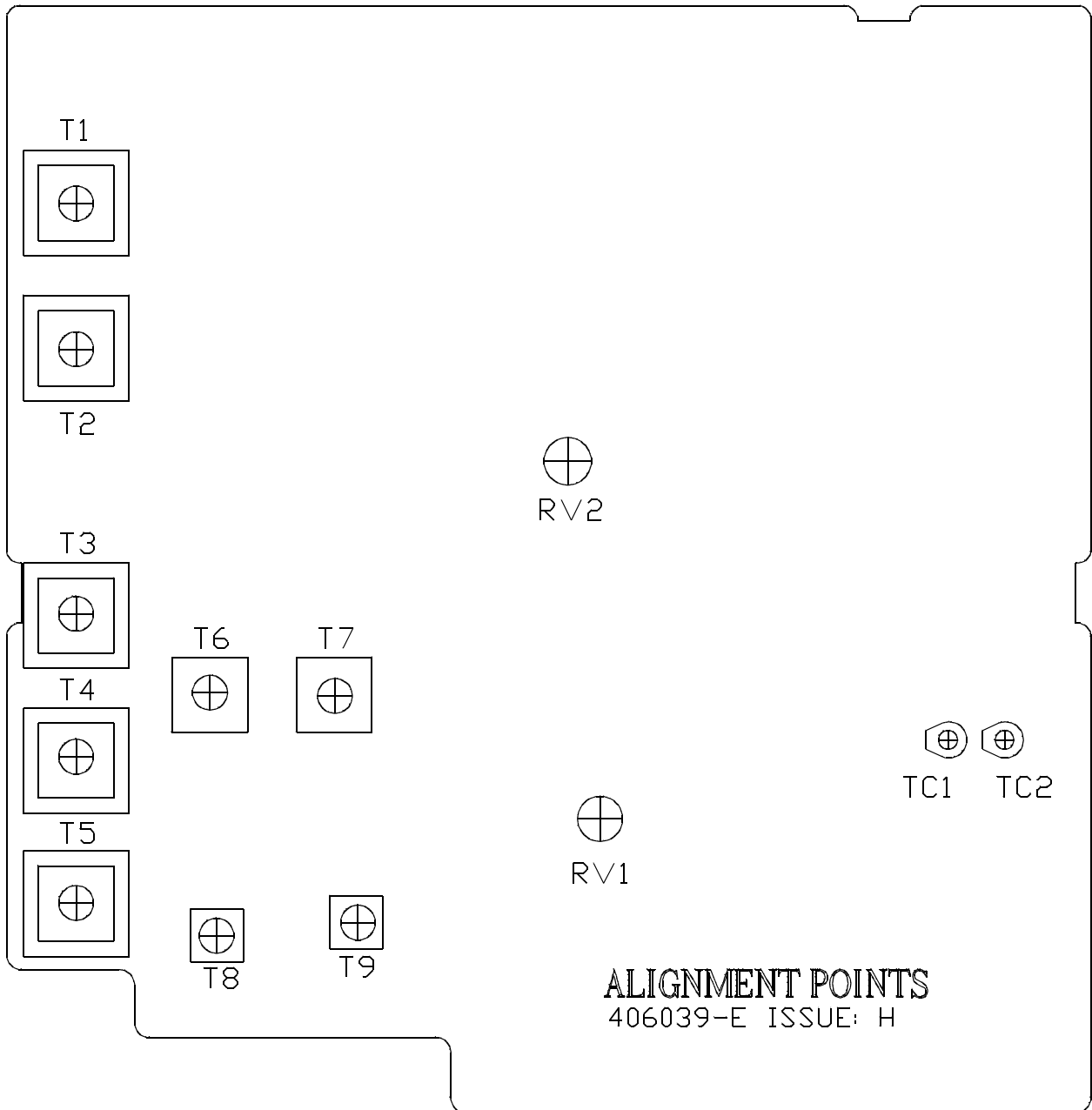

PERFORMANCE TEST

TRANSMITTER PERFORMANCE TEST

Power Output

1. Set the power supply voltage to 13.8 VDC (measured at the radio during transmit).
2. Connect an RF wattmeter and dummy load to the antenna connector.
3. Press the PTT switch.
4. Verify that the output is at least 40 watts.
5. Reduce the power supply voltage to 11 volts.
6. Verify that the output is at least 15 watts.
7. Release the PTT switch.

Audio Response

1. Connect an audio generator to the microphone jack on the radio. Set the monitor to read average peak FM deviation.
3. Press the PTT switch.
4. Adjust the audio generator level to produce 1 kHz deviation.
5. Set the audio generator frequency to 500 Hz. The transmitter deviation should decrease to approximately 500 Hz.
6. Set the audio generator frequency to 2 kHz. The transmitter deviation should be approximately 2 kHz.
7. As the audio generator frequency is varied from 300 Hz to 10 kHz, the deviation should increase until it reaches a maximum at an audio frequency of 2.5 kHz to 2.9 kHz. At higher frequencies, the deviation should decrease. The deviation at an audio frequency of 6 kHz should be less than 1 kHz.
8. Release the PTT switch.

Limiting Test

1. Set the audio generator frequency to 1 kHz.
2. Press the PTT switch and adjust the generator level to produce 3 kHz deviation. Note the generator level.
3. Increase the audio generator level by 20 dB.
4. Sweep the audio generator over a frequency range of 300 Hz to 3 kHz. The deviation should not exceed ± 5 KHz within this range.
5. Release the PTT switch.

MONOGRAM SERIES LBI-38864B

PERFORMANCE TEST

Spectrum Test

1. Connect a spectrum analyzer to a sampled RF output of the radio.
2. Press the PTT switch. Observe the output spectrum on the spectrum analyzer.
3. All spurious and harmonics should be at least 60 dB below the carrier level.
4. Release the PTT switch.

RECEIVER PERFORMANCE TESTS

SINAD Sensitivity

1. Connect the FM signal generator of communication service monitor to the antenna jack.
2. Connect a SINAD Meter across the speaker leads.
3. Turn the SQUELCH control fully counterclockwise for maximum noise.
4. Adjust the VOLUME control to approximately mid-range.
5. Set the FM signal generator/service monitor to the receive frequency. The modulation should be set for 3 kHz deviation of a 1 kHz tone.
6. Adjust the generator RF level so that the SINAD meter reads 12 dB. The signal generator RF level should be .30 μ V or less.

Noise Quieting Sensitivity

1. Connect a VOM to the speaker leads.
2. Turn the SQUELCH control fully counterclockwise for maximum noise.
3. With no RF signal generator or communication service monitor connected to the radio, adjust the VOLUME control to obtain a noise reading of 1 volt RMS on the VOM.
4. Connect the RF signal generator/service monitor to the radio. Set the RF frequency to the receiver frequency of the radio and remove any modulation.
5. Adjust the signal generator RF level for a noise reading on the VOM of 0.1 volt RMS. This is the 20 dB noise quieting point. The RF level should be 0.5 μ V or less.

Squelch Sensitivity

1. Set the RF signal generator/service monitor to the receive frequency. Set the modulation to 3 kHz deviation of a 1 kHz audio tone.
2. Reduce the signal generator RF output to zero.
3. Rotate the SQUELCH control clockwise to the point where the speaker noise just goes away.
4. Increase the signal generator/service monitor RF level until the speaker noise returns. This is the threshold squelch setting. The generator output level should not exceed 0.20 μ V.
5. Turn the SQUELCH control to maximum clockwise rotation.
6. Increase the generator output level until the squelch opens (busy LED is on). The output level should be between 10 and 20 dB (3 to 10 times) above the threshold setting.

MONOGRAM SERIES LBI-38864B

PERFORMANCE TEST

Audio Output

1. Increase the RF signal generator/service monitor RF level to 1000 μ V.
2. Connect a 4 ohm audio dummy load to the AUXILIARY speaker jack.
3. Connect a true RMS audio voltmeter (the audio distortion analyzer may include this function) to the speaker leads.
4. With a 3 kHz deviation of a 1 kHz tone modulation applied to the signal generator, rotate the VOLUME control clockwise until the audio distortion is 10% or until the VOLUME control reaches stop, whichever comes first.
5. The audio voltmeter should read 4.0 volts or greater.

MONOGRAM SERIES LBI-38864B

COMPONENT REPLACEMENT

COMPONENT REPLACEMENT

SURFACE MOUNT COMPONENTS

Surface mount components should always be replaced using a temperature controlled soldering system. The soldering tools may be either a temperature controlled soldering iron or a temperature controlled hot-air soldering station. A hot-air system is recommended for the removal of components on the multi-layered boards used in the VHF synthesized mobile radio. With either soldering system, a temperature of 700ø F (371ø C) should be maintained.

The following procedures outline the removal and replacement of surface mount components. If a hot-air soldering system is employed, see the manufacturer's operating instructions for detailed information on the use of your system.

- **CAUTION:** *Avoid applying heat to the body of any surface mount component using standard soldering methods. Heat should be applied only to the metalized terminals of the components. Hot-air systems do not damage the components since the heat is quickly and evenly distributed to the external surface of the component.*
- **CAUTION:** *The CMOS Integrated Circuit devices used in this equipment can be destroyed by static discharges. Before handling one of these devices, service technicians should discharge themselves by touching the case of a bench test instrument that has a 3-prong power cord connected to an outlet with a known good earth ground. When soldering or desoldering a CMOS device, the soldering equipment should have a known good earth ground.*

SURFACE MOUNT REMOVAL

1. Grip the component with tweezers or small needle nose pliers.
2. Alternately heat the metalized terminal ends of the surface mount component with the soldering iron. If a hot-air system is used, direct the heat to the terminals of the component. Use extreme care with the soldering equipment to prevent damage to the printed circuit board (PCB) and the surrounding components.
3. When the solder on all terminals is liquefied, gently remove the component. Excessive force may cause the PCB pads to separate from the board if all solder is not completely liquefied.
4. It may be necessary to remove excess solder using a vacuum de-soldering tool or Solder wick . Again, use great care when de-soldering or soldering on the printed circuit boards. It may also be necessary to remove the epoxy adhesive that was under the surface mount component and any flux on the printed circuit board.

MONOGRAM SERIES LBI-38864B

COMPONENT REPLACEMENT

SURFACE MOUNT COMPONENT REPLACEMENT

1. "Tin" one terminal end of the new component and the corresponding pad of the PCB. Use as little solder as possible.
2. Place the component on the PCB pads, observing proper orientation for capacitors, diodes, transistors, etc.
3. Simultaneously touch the "tinned" terminal end and the "tinned" pad with the soldering iron. Slightly press the component down on the board as the solder liquefies. Solder all terminals, allowing the component time to cool between each application of heat. Do not apply heat for an excessive length of time and do not use excessive solder.

With a hot-air system, apply hot air until all "tinned" areas are melted and the component is seated in place. It may be necessary to slightly press the component down on the board. Touch-up the soldered connections with a standard soldering iron if needed. Do not use excessive solder.

- **CAUTION:** *Some chemicals may damage the internal and external plastic parts of the radio.*

4. Allow the component and the board to cool and then remove all flux from the area using alcohol or another approved flux remover.

SURFACE MOUNTED INTEGRATED CIRCUIT REPLACEMENT

Soldering and de-soldering techniques of the surface mounted IC's are similar to the above outlined procedures for the surface mounted chip components. Use extreme care and observe static precautions when removing or replacing the defective (or suspect) IC's. This will prevent any damage to the printed circuit board or the surrounding circuitry.

The hot-air soldering system is the best method of replacing surface mount IC's. The IC's can easily be removed and installed using the hot-air system. See the manufacturers instructions for complete details on tip selection and other operating instructions unique to your system.

If a hot-air system is not available, the service technician may wish to clip the pins near the body of the defective IC and remove it. The pins can then be removed from the PCB with a standard soldering iron and tweezers, and the new IC installed following the Surface Mount Component Replacement procedures. It may not be necessary to "tin" all (or any) of the IC pins before the installation process.

ELECTRICAL PARTS LIST

NOTE

Only those items indicated by shading will be stocked by After Market Services. All other items are for reference only.

When ordering parts for your Monogram Series radio, precede all part numbers with the prefix "R29/"

Part No.	Description	Symbol
	TAN DIP 0.1UF 35V :489D104X0035A1	C1
	CAP, CER 4.7 pF, NPO	C2
	CAP, CER AXIAL 0.01UF	C4
	CAP, CER 4.7PF, NPO	C5
	CAP, CER 1PF, NPO (MID BAND)	C6
	CAP, CER 1pF, NPO (LOW BAND) 3.3pF	C6
	CAP, CER AXIAL .001UF	C7
	CAP, TAN 4.7UF 16WV	C8
	CAP, CER AXIAL .001UF	C9
	CAP, CER .68 pF, P100	C10
	CAP, CER AXIAL 0.001UF	C11
	CAP, CER 4.7PF, NPO (LOW BAND)	C12
	CAP, CER 3.9PF, NPO (MID BAND)	C12
	CAP, CER 2.7PF, NPO (HIGH BAND)	C12
	CAP, CER 1.5PF, P100	C13
	CAP, CER 4.7PF, NPO (MID/LOW BAND)	C14
	CAP, CER 6.8PF, NPO (HIGH BAND)	C14
	CAP, CER 1.5PF, P100	C15
	CAP, CER AXIAL 0.001UF	C16
	CAP, ELEC 100 UF, 25V	C17
	CAP, CER AXIAL 0.001UF	C18
	CAP, ELEC 47 UF, 10V	C19
	CAP, CER AXIAL .01UF	C20
	CAP, ELECTTOLYTIC 47UF, 10V	C21
	CAP, ELEC 47UF, 10V	C22
	CAP, CER AXIAL .001 UF	C23
	CAP, ELEC 10UF, 16V	C24
	CAP, CER AXIAL .001 UF	C25
	CAP, CER AXIAL .001 UF	C26
	CAP, CER AXIAL .01 UF	C27
	CAP, CER AXIAL .001 UF	C28
	CAP, CER AXIAL .001 UF	C29
	CAP, CER 10PF,NPO	C30
	CAP, CER 12PF, NPO (LOW BAND)	C31
	CAP, CER 8.2PF,NPO (MID BAND)	C31
	CAP, CER 6.8PF, NPO (HIGH BAND)	C31
	CAP, CER 8.2PF NPO (MID BAND)	C32
	CAP, CER 12PF, NPO (LOW BAND)	C32
	CAP, CER 6.8.PF, NPO (HIGH BAND)	C32
	CAP, CER AXIAL 0.001UF	C33

Part No.	Description	Symbol
	CAP, CER AXIAL .01UF	C34
	CAP, CER AXIAL .01UF	C35
	CAP, CER AXIAL .01UF	C36
	CAP, CER AXIAL .001UF	C37
	CAP, CER AXIAL .001UF	C38
	CAP, CER AXIAL .001UF	C39
	CAP, CER AXIAL .001UF	C40
	CAP, TAN 2.2UF, 1W6V	C41
	CAP, MULTILAYER CER .047UF	C42
	CAP ELEC 22UF, 16V	C43
	CAP ELEC 4.7UF, 16V	C44
	CAP MYLAR .01UF, 50WV +/-5%	C45
	CAP MYLAR .0022UF, 50WV +/-5%	C46
	CAP, CER 56PF, NPO	C47
	CAP, MYLAR .0068UF, 50WV +/-2%	C48
	CAP, MYLAR .0039UF, 50WV +/-5%	C49
	CAP, MYLAR .0068UF, 50WV +/-2%	C50
	CAP MYLAR .01UF, 50WV +/-5%	C51
	CAP, MYLAR .0047UF, 50WV +/-5%	C52
	CAP, CER AXIAL .001UF	C53
	CAP, ELEC 10UF, 16V	C54
	CAP, CER AXIAL .001UF	C55
	CAP, MULTILAYER CER .1UF,50V	C56
	CAP, CER 12PF, NPO	C57
	CAP, MULTILAYER CER .1UF,50V	C58
	CAP, MULTILAYER CER .1UF,50V	C59
	CAP, 100PF, NPO	C60
	CAP, CER 39PF, NPO	C61
	CAP, ELEC 10UF, 16V	C62
	CAP, CER .01UF	C63
	CAP, MYLAR .047UF, 50WV +/-2%	C64
	CAP, MYLAR .047UF, 50WV +/-2%	C65
	CAP, MYLAR .047UF, 50WV +/-2%	C66
	CAP, MYLAR .047UF, 50WV +/-2%	C67
	CAP, CER .01 UF	C68
	CAP, ELEC 10 UF, 16V	C69
	CAP, TAN 1UF, 16V	C70
	CAP, TAN 1UF, 16V	C71
	CAP, CER AXIAL .001UF	C72
	CAP, ELEC 10UF, 16V	C73

Part No.	Description	Symbol
	(HIGH BAND)	C74
	CAP, CER 1PF, NPO (MID BAND)	C74
	CAP, CER 2.2PF, NPO (LOW BAND)	C74
	CAP, CER AXIAL .001UF	C75
	CAP ELEC 1.0UF, 16V	C76
	CAP ELEC 1.0UF, 16V	C77
	CAP ELEC 1.0UF, 16V	C78
	CAP, TAN 10UF	C79
	CAP, ELEC 1000 UF, 16V	C80
	CAP, MYLAR .1UF, 50WV +/-10%	C81
	CAP, ELEC 470UF, 16V	C82
	CAP, MYLAR .01UF, 50WV +/-5%	C83
	CAP, CER AXIAL .001UF	C84
	CAP, ELEC 470UF, 16V	C85
	CAP, ELEC 1000UF, 25V	C86
	CAP, CER AXIAL .01UF	C87
	CAP, CER AXIAL .001UF	C88
	CAP, CER AXIAL .001UF	C89
	CAP, CER .01UF	C90
	CAP, CER AXIAL .001UF	C91
	CAP, CER AXIAL .001UF	C92
	CAP, CER AXIAL .001UF	C93
	CAP, ELEC 10UF, 16V	C94
	CAP, CER AXIAL .001UF	C95
	CAP ELEC 47UF, 25V	C96
	CAP, CER AXIAL .001UF	C97
	CAP, CER AXIAL .001UF	C98
	CAP, CER 10PF, NPO (HIGH BAND)	C99
	CAP, CER 15PF, NPO (MID, LOW BAND)	C99
	CAP, CER .01UF	C100
	CAP, CER AXIAL .001UF	C101
	CAP, CER 68 pF, NPO (HIGH BAND)	C102
	CAP, CER 82PF, NPO (MID BAND)	C102
	CAP, CER 100PF, NPO (LOW BAND)	C102
	CAP, CER 10PF, NPO (HIGH MID BAND)	C103
	CAP, CER 56PF, NPO (MID HIGH BAND)	C104
	CAP, CER 68PF, NPO (LOW BAND)	C104
	CAP, CER .01UF	C105
	CAP, ELEC 100 UF, 25V	C106
	CAP, CER 22PF, (HIGH BAND)	C107

Part No.	Description	Symbol
	CAP, CER 27PF, (LOW MID BAND)	C107
	CAP, CER 27PF, NPO (MID BAND)	C108
	CAP, CER 22PF, NPO (HIGH LOW BAND)	C108
	CAP, CER 75PF, NPO (MID LOW BAND)	C109
	CAP, CER 120PF, NPO (HIGH LOW BAND)	C109
	CAP, CER MONO 180PF	C110
	CAP, CER MONO 180PF	C111
	CAP, CER .01UF	C112
	CAP, CER .01UF	C113
	CAP, ELEC 100 UF, 25V	C114
	CAP, CER .01UF	C115
	CAP, CER .01UF	C116
	CAP, CER .01UF	C117
	CAP, CER 68PF, NPO (HIGH MID BAND)	C118
	CAP, CER 82PF, NPO (LOW BAND)	C118
	CAP, CER 100PF, NPO	C119
	CAP, CER 68PF, NPO (MID BAND)	C119
	CAP, CER 82PF, NPO (LOW BAND)	C119
	CAP, CER 47PF, NPO (HIGH MID BAND)	C120
	CAP, CER 56PF, NPO (LOW BAND)	C120
	CAP, CER .01UF	C121
	CAP, CER AXIAL .001UF	C122
	CAP MYLAR .01UF, 50WV +/-5%	C123
	CAP, ELEC 220 UF, 16V	C124
	CAP, CER AXIAL .001UF	C125
	CAP, CER AXIAL .001UF	C126
	CAP, CER AXIAL .001UF	C127
	CAP, CER 6.8PF, NPO (HIGH BAND)	C128
	CAP, CER 10PF, NPO (MID BAND)	C128
	CAP, CER 12PF, NPO (LOW BAND)	C128
	CAP, CER MONO 1000PF	C129
	CAP, CER MONO 15 PF (HIGH/MID BAND)	C131
	CAP, CER MONO 18PF (LOW BAND)	C131
	CAP, CER MONO 10PF (HIGH/MID BAND)	C132
	CAP, CER MONO 18PF (LOW BAND)	C132
	CAP, CER MONO 10PF (HIGH/MID BAND)	C133
	CAP, CER MONO 18PF (LOW BAND)	C133
	CAP, CER MONO 1000PF	C134
	CAP, CER MONO 18PF (HIGH BAND)	C135

Part No.	Description	Symbol
	CAP, CER MONO 22PF (MID BAND)	C135
	CAP, CER MONO 30PF (LOW BAND)	C135
	CAP, CER MONO 18PF (HIGH BAND)	C136
	CAP, CER MONO 22PF (MID BAND)	C136
	CAP, CER MONO 32PF (LOW BAND)	C136
	CAP, CER MONO 15 PF (HIGH/MID BAND)	C137
	CAP, CER MONO 18PF (LOW BAND)	C137
	CAP, CER MONO 1000PF	C138
	CAP, CER AXIAL .001UF	C139
	CAP, CER .82PF, P100	C140
	CAP, CER 220PF, N750	C141
	CAP, MYLAR .1UF, 50WV +/-10%	C142
	CAP, CER .68PF, P100 (HIGH MID BAND)	C143
	CAP, CER 1.2PF, P100 (LOW BAND)	C143
	CAP, CER AXIAL .001UF	C144
	CAP, CER AXIAL .001UF	C145
	CAP, CER AXIAL .001UF	C146
	CAP, CER .56PF (MID HIGH BAND)	C147
	CAP, CER .82PF (LOW BAND)	C147
	CAP, CER 5.6PF (HIGH BAND)	C149
	CAP, CER 3.3PF (MID BAND)	C149
	CAP, CER 4.7PF (LOW BAND)	C149
	CAP, CER AXIAL .001UF	C150
	CAP, CER AXIAL .001UF	C151
	CAP, CER AXIAL .001UF	C152
	CAP, CER AXIAL .001UF	C153
	CAP, CER AXIAL .001UF	C154
	CAP, CER AXIAL .01UF	C155
	CAP, CER AXIAL .001UF	C156
	CAP, CER AXIAL .01UF	C157
	CAP, CER AXIAL .001UF	C158
	CAP, CER AXIAL .01UF	C159
	CAP, ELEC 10 UF, 16V	C160
	CAP, CER AXIAL .01UF	C162
	CAP, CER AXIAL .01UF	C163
	CAP, CER AXIAL .001UF	C164
	CAP, CER .01UF	C165
	CAP, CER AXIAL .001UF	C166
	CAP, CER .68PF, P100 (HIGH MID BAND)	C167
	CAP, CER 1.2PF, P100 (LOW BAND)	C167

Part No.	Description	Symbol
	CAP, CER AXIAL .001UF	C168
	CAP, CER .01UF	C169
	CAP, CER .01UF	C170
	CAP, CER AXIAL .001UF	C171
	CAP, CER .01UF	C172
	CAP, CER .01UF	C173
	CAP, CER .01UF	C173
	CAP, CER AXIAL .001UF	C174
	CAP, CER .01UF	C177
	CAP, CER AXIAL .001UF	C178
	CAP, CER AXIAL .001UF	C179
	CAP, CER AXIAL .001UF	C180
	CAP, MONO 3.9 PF (MID/HIGH BAND)	C181
	CAP, MONO 4.7PF (LOW BAND)	C181
	CAP, CER 1.8PF (MID BAND)	C182
	CAP, CER 2.2PF (LOW BAND)	C182
	CAP, MONO 0.47UF	C183
	CAP, MONO 0.47UF	C184
	CAP, CER AXIAL .001UF	C185
	CAP, MONO .001PF	C186
	CAP, MONO 47UF	C187
	CER CHIP 10PF (HIGH BAND)	C192
	CAP, CER AXIAL .001UF	C193
	CAP, ELEC 1.0 UF, 50V	C201
	CAP, CER .01UF	C202
	CAP ELEC 47UF, 25V	C203
	CAP, CER .01UF	C204
	CAP, CER .01UF	C205
	CAP, MYLAR .01UF, 50WV +/-5%	C206
	CAP, TAN 1UF, 16WV	C207
	CAP, CER AXIAL .001UF	C208
	CAP ELEC 47UF, 16V	C209
	CAP, CER AXIAL .001UF	C210
	CAP ELEC 22UF, 16V	C211
	CAP, CER 30PF, 50WV	C212
	CAP, CER 30PF, 50WV	C213

Part No.	Description	Symbol
	CAP, TAN .1UF 16WV	C214
	CAP, CER AXIAL .001UF	C215
	CAP, TAN 1UF, 16WV	C216
	CAP, CER AXIAL .001UF	C217
	CAP ELEC 470UF, 16V	C218
	CAP, TAN 6.8UF, 16WV	C219
	CAP, MYLAR .018UF, 50WV +/-5%	C220
	CAP MYLAR .033UF 50V +/-5%	C221
	CAP MYLAR .0018UF, 50WV +/-5%	C222
	CAP MYLAR .047UF, 50WV +/-5%	C223
	CAP POLY 820PF, 50WV	C224
	CAP, CER .01UF	C225
	CAP, CER AXIAL .001UF	C226
	CAP, MONO 470UF	C227
	CAP, TAN 4.7UF, 16WV	C228
	CAP, TAN 10UF, 16WV	C229
	CAP, ELEC 10 UF, 16V	C230
	CAP, ELEC 47UF, 16V	C231
	CAP, MYLAR .0056UF, 50WV +/-5%	C232
	CAP, MYLAR .0056UF, 50WV +/-5%	C233
	CAP MYLAR .047UF, 50WV +/-5%	C234
	CAP, CER 68PF, NPO	C235
	CAP, TAN 4.7UF, 16WV	C236
	CAP MYLAR .018UF, 50WV +/-5%	C237
	CAP, TAN 10UF, 16WV	C238
	CAP, TAN 10UF, 16WV	C239
	CAP, ELEC 47UF, 16V	C240
	CAP MYLAR .047UF, 50WV +/-5%	C241
	CAP, CER 56PF, NPO	C242
	CAP MYLAR .015UF, 50WV +/-10%	C243
	CAP, ELEC 10UF, 16V	C244
	CAP, CER 56PF, NPO	C245
	CAP, ELEC 22UF, 16V	C246
	CAP, MYLAR .0056UF, 50WV +/-5%	C247
	CAP, MYLAR .0047UF, 50WV +/-5%	C248
	CAP, CER .01UF	C249
	CAP, ELEC 10UF, 16V	C250
	CAP, MYLAR .022UF, 50WV +/-5%	C251
	CAP, MYLAR .0018UF, 50WV +/-5%	C252
	CAP, ELEC 47UF, 16V	C253

Part No.	Description	Symbol
	CAP, ELEC 47UF, 16V	C254
	CAP, CER .01UF	C255
	CAP, TAN 1UF, 16WV	C256
	CAP, CER 100PF, NPO	C257
	CAP, CER AXIAL .001UF	C258
	CAP, CER 47PF, NPO	C259
	CAP, CER 15PF, NPO	C260
	CAP, CER 68PF, NPO	C261
	CAP, CER AXIAL .001UF	C262
	CAP, TAN 1UF, 16WV	C263
	CAP, TAN .1UF 16WV	C264
	CAP, TAN .1UF 16WV	C265
	CAP, CER AXIAL .001UF	C266
	CAP, TAN 10UF, 16WV	C267
	CAP, CER AXIAL .001UF	C268
	CAP, CER AXIAL .001UF	C269
	CAP, CER AXIAL .001UF	C270
	CAP, TAN 10UF, 16WV	C271
	CAP, CER .01UF	C272
	CAP, CER AXIAL .001UF	C273
	CAP, TAN 10UF, 16WV	C274
	CAP, CER MONO 75PF (HIGH BAND)	C275
	CAP, CER MONO 180PF (MID BAND)	C275
	CAP, CER MONO 330PF (LOW BAND)	C275
	CAP, CER MONO 33PF (HIGH BAND)	C276
	CAP, CER MONO 36PF (MID BAND)	C276
	CAP, CER MONO 51PF (LOW BAND)	C276
	CAP, CER MONO .001UF (HIGH MID BAND)	C277
	CAP, CER MONO .01UF (LOW BAND)	C277
	CAP, CER MONO 6PF (MID BAND)	C278
	CAP, CER MONO 8PF (LOW BAND)	C278
	CAP, CER MONO 4PF (MID BAND)	C279
	CAP, CER MONO 7PF (LOW BAND)	C279
	CAP, CER 15PF, NPO (HIGH MID BAND)	C280
	CAP, CER 18PF, NPO (LOW BAND)	C280
	CAP, ELEC 100UF, 10V	C281
	CAP, ELEC 100UF, 10V	C282
	CAP, TAN 10UF, 16WV	C283
	CAP, CER .01UF	C284
	CAP, CER 18PF, NPO (HIGH BAND)	C285

Part No.	Description	Symbol
	CAP, CER 22PF, NPO (MID BAND)	C285
	CAP, CER 27PF, NPO (LOW BAND)	C285
	CAP, CER 2.2PF, NPO	C286
	CAP, CER .01UF	C287
	CAP, CER 2.2PF, NPO	C288
	CAP, CER 1.8PF, NPO	C289
	CAP, CER 3.9PF, NPO	C290
	CAP, CER .01UF	C291
	CAP, TAN 10UF, 16WV	C292
	CAP, CER .01UF	C293
	CAP, CER .01UF	C294
	CAP, TAN .1UF, 16WV	C295
	CAP, CER AXIAL .001UF	C296
	CAP, TAN 10UF, 16WV	C297
	CAP, CER .01UF	C298
	CAP, CER .01UF	C299
	CAP, CER .01UF	C300
	CAP, CER AXIAL .001UF	C301
	CAP, CER .01UF	C302
	CAP, CER AXIAL .001UF	C303
	CAP, CER AXIAL .001UF	C304
	CAP, CER AXIAL .001UF	C305
	CAP, CER 8.2PF, NPO	C306
	CAP, TAN 10UF, 16WV	C307
	CAP, CER 12PF, NPO (HIGH BAND)	C308
	CAP, CER 7PF, NPO (LOW MID BAND)	C308
	CAP, CER MONO 3.3PF, 50WV	C309
	CAP, TAN 10UF, 16WV	C310
	CAP, CER MONO .01UF	C311
	CAP, CER MONO .01UF	C312
	CAP, CER MONO .01UF	C313
	CAP, CER MONO .01UF	C314
	CAP, ELEC 47UF, 10V	C315
	CAP, CER .01UF	C316
	CAP, TAN 10UF, 16WV	C320
	CAP, CER AXIAL .001UF	C321
	CAP, TAN 10UF, 16WV	C325
	CAP, CER MONO .047UF	C326

Part No.	Description	Symbol
	CAP, CER MONO .047UF	C327
	CAP, CER MONO .047UF	C328
	CAP, CER MONO .047UF	C329
	CAP, CER MONO .047UF	C330
	CAP CHIP .047UF	C401
	CAP CHIP .047UF	C402
	CAP CHIP .047UF	C403
	TAN CHIP 10YF	C404
	CAP CHIP .047UF	C405
	CAP CHIP .047UF	C406
	CAP, CHIP 0.047UF	C420
	CAP, CHIP 0.047UF	C421
	CAP, CHIP 0.047UF	C422
	CAP, CHIP 0.047UF	C423
	CAP, CER 470PF	C501
	FILTER, CER	CF1
	CAP, FEED THROUGH 1000PF	CF2
	DIODE SI 282-BA	D1
	DIODE SI 1N4148	D2
	DIODE SI 1N4148	D3
	DIODE GE 1N602	D4
	DIODE GE 1N602	D5
	DIODE 1SS133	D6
	DIODE 1SS133	D7
	DIODE 1SS133	D8
	DIODE SI 282-BA	D9
	DIODE, SILICON SCHOTTKEY 1SS97	D10
	DIODE PIN UM9401	D11
	DIODE PIN UM9401	D12
	DIODE SI 1N4148	D13
	DIODE RECTIN5404T/R	D14
	DIODE SI 1N4148	D15
	DIODE SI 1N4148	D16
	DIODE IN4003 (1A,200V)	D101
	DIODE IN4003 (1A,200V)	D102
	DIODE 1N5819	D103
	DIODE, ZENER 1N5252B	D104
	DIODE. ZENER 1N5227B	D105

Part No.	Description	Symbol
		D106-D108
	DIODE,LED LAMP SLC-22YY3	D109
	DIODE, LED LAMP SLC22GG3	D111
	DIODE, LED LAMP SLC22UR3	D112
	DIODE 1N4148	D113
	DIODE 1N4148	D114
	DIODE 1N4148	D115
	DIODE ZENER 1N5235B	D116
	DIODE 1N4148	D117
	DIODE 1N4148	D118
	DIODE SI BB609A	D119
	DIODE, VARACTOR 1SV50	D120
	DIODE, VARACTOR 1SV50	D121
	DIODE SI 282-BA	D122
	DIODE SI BA-282	D123
	DIODE SI 1N4148	D124
	DIODE, VARACTOR 1SV50	D125
	DIODE 15V50 (LOW BAND)	D126
	DIODE, ZENER 6.8V	DZ116
	BEAD CORE 56 59065-4B	FB1
	BEAD CORE 56 59065-4B	FB2
	BEAD CORE 56 59065-4B	FB3
	BEAD CORE 56 59065-4B	FB4
	BEAD CORE 56 59065-4B	FB5
	BEAD CORE 56 59065-4B	FB6
	BEAD CORE 56 59065-4B	FB7
	BEAD CORE 56 59065-4B	FB8
	BEAD CORE 56 59065-4B	FB9
	FLUORESCENT DISPLAY 4-ST-01ZS1	FL1
R29/ 229-074-0	I.C. MB3756	IC1
R29/ 223-008-1	I.C. MC3357P	IC2
	I.C. KIA358P	IC3
	I.C. KIA358P	IC4
R29/ 229-075-1	I.C. TDA2003H	IC5
	I.C. KIA7805PI	IC6
R29/ 231-064-4	I.C. LM358M	IC7
R29/ 229-383-9	I.C. UCN 5810A or AF	IC101
R29/ 229-383-9	I.C. UCN 5810A or AF	IC102

Part No.	Description	Symbol
	I.C. SN74LS257A	IC103
	I.C. AN6540	IC104
R29/ 229-503-1	I.C. MICROPROCESSOR	IC105
R29/ 229-463-8Z	I.C. AT93C56-10PC	IC106
	I.C. KA78L05	IC107
	I.C. MC145156P2	IC108
R29/ 229-104-4	I.C. MB504P	IC109
R29/ 223-152-7	I.C. MC145048	IC110
	I.C. MC142100CP	IC111
	I.C. LA6458S	IC112
	I.C. KIA4558P	IC113
	I.C. KIA4558P	IC114
	I.C. MC14066B	IC115
	I.C. LA6458S	IC116
	I.C. KIA358P	IC117
	I.C. LM358M	IC120
	ANTENNA CONNECTOR	J1
	MINIATURE JACK	J2
	MINIATURE JACK	J3
	11 PIN CONNECTOR	J4
	RIBBON CABLE CONNECTOR	J5
	11 PIN (OPTION INTERFACE) CONNECTOR	J6
	6 PIN (PROGRAM) CONNECTOR	J7
	10 PIN INTER-PCP CONNECTOR	J8
	2 PIN MINIATURE COAXIAL CONNECTOR	J9
	9 PIN CONNECTOR	J10
	MICROPHONE CONNECTOR	J11
	6 PIN (AUX RELAY INTERFACE) CONNECTOR	J12
	RIBBON CABLE CONNECTOR	J13
	COIL, AXIAL 1 mH	L1
	COIL, AXIAL .22uH	L2
	COIL, AXIAL 1 mH	L3
	COIL, AXIAL .22uH	L4
	COIL, AXIAL 1 mH	L5
	COIL, AXIAL 1 mH	L6
	COIL, AXIAL 1 mH	L7
	COIL, AXIAL .22uH	L8
	COIL, AXIAL 100uH	L9
	COIL, AXIAL .82uH	L10

Part No.	Description	Symbol
	SEE R62,FB8, AND FB9	L11
	COIL .009uH	L12
	COIL .29uH	L13
	COIL INDUCT. MK-30 (8 TURNS ON 100 OHM, 1/2W)	L14
	COIL .12uH	L15
	COIL .0084uH	L16
	COIL, 5T	L17
	COIL ASSEMBLY	L18
	COIL .225uH	L19
	COIL, ASSEMBLY	L20
	COIL, SPRING, .295uH (MID/HIGH BAND)	L21
	COIL, SPRING, 2T (MID/HIGH BAND)	L22
	COIL, SPRING, .375uH (MID/HIGH BAND)	L23
	COIL, SPRING, 2T (MID/HIGH BAND)	L24
	COIL, SPRING, .335uH (MID/HIGH BAND)	L25
	COIL, SPRING, 6T (MID/HIGH BAND)	L26
	COIL, SPRING, .295uH (LOW BAND)	L21
	COIL, SPRING, 2T (LOW BAND)	L22
	COIL, SPRING, .375uH (LOW BAND)	L23
	COIL, SPRING, 2T (LOW BAND)	L24
	COIL, SPRING, .335uH (LOW BAND)	L25
	COIL, SPRING, 6T (LOW BAND)	L26
	COIL, 7T	L27
	COIL, AXIAL .22uH	L28
	COIL, AXIAL .22uH	L29
	COIL, AXIAL 1 mH	L30
	TRANSFORMER, CHOKE	L31
	COIL, AXIAL .22uH	L32
	COIL, AXIAL 1 mH	L33
	COIL, AXIAL 100uH	L34
	COIL, AXIAL .22uH	L35
	COIL, AXIAL .22uH	L36
	COIL, AXIAL 1 mH	L37
	COIL, AXIAL .22uH	L38
	COIL, AXIAL 1 mH	L39
	COIL, AXIAL 1 mH	L40
	COIL, AXIAL .22uH	L41
	COIL, AXIAL 1uH	L42
	COIL, AXIAL .22uH	L43
	COIL, AXIAL .22uH	L44

Part No.	Description	Symbol
	COIL, AXIAL .22uH	L45
	COIL, AXIAL 1uH	L101
	COIL, AXIAL 1uH	L102
	COIL, AXIAL 6.8uH (HIGH MID BAND)	L103
	COIL, AXIAL 1uH (LOW BAND)	L103
	COIL, AXIAL 2.2uH	L104
	COIL, AXIAL 2.2uH	L105
	COIL, AXIAL 2.2uH	L106
	COIL, AXIAL 2.2uH	L107
	COIL, .205uH	L108
	COIL, AXIAL	L109
	COIL, .12uH	L110
	COIL, AXIAL 2.2uH	L111
	COIL, AXIAL 100uH	L112
	COIL, AXIAL 100uH	L113
	COIL, AXIAL 2.2uH	L114
	COIL, AXIAL 2.2uH	L115
	COIL, AXIAL 2.2uH	L116
	11 PIN HOUSING ASSEMBLY	P4
	10 PIN INTER-PCB PLUG	P8
	VCO CABLE ASSEMBLY	P9
	9 PIN HOUSING ASSMEBLY	P10
	FET MFE211	Q1
	FET J310	Q2
	TRANSISTOR MPS9426(C)	Q3
	TRANSISTOR MPS9631(T)	Q4
	TRANSISTOR MPS9681(T)	Q5
	TRANSISTOR MPS9631(T)	Q6
	TRANSISTOR MPS9631(T)	Q7
	TRANSISTOR MPS9631(T)	Q8
	TRANSISTOR MPS9426(C)	Q9
	TRANSISTOR 2N4427	Q10
	TRANSISTOR SRFH1900	Q11
	TRANSISTOR MRF1946	Q12
	TRANSISTOR KTA1658	Q13
	TRANSISTOR MPS9600(I)	Q14

Part No.	Description	Symbol
	TRANSISTOR MPS9681(T)	Q101
	TRANSISTOR MPS9618(T)	Q102
	TRANSISTOR MPS9618(T)	Q103
	TRANSISTOR KSP2222	Q104
	TRANSISTOR KSP2222	Q105
	TRANSISTOR MPS9631(T)	Q106
	TRANSISTOR 2N3904	Q107
	TRANSISTOR 2N3906	Q108
	TRANSISTOR MPS9681(T)	Q109
	TRANSISTOR MPS9618(T)	Q111
	FET J310	Q112
	TRANSISTOR MPS9426(C)	Q113
	TRANSISTOR BF961	Q114
	TRANSISTOR MPS9426(C)	Q115
	TRANSISTOR MPS9631(T)	Q116
	TRANSISTOR MPS9681(T)	Q117
	TRANSISTOR MPS9681(T)	Q118
	TRANSISTOR MPS9631(T)	Q119
	RES, 3.3M OHM 1/8W +/-5%	R1
	RES, 220K OHM 1/8W +/-5%	R2
	RES, 560K OHM 1/8W +/-5%	R3
	RES, 120 OHM 1/8W +/-5%	R4
	RES, 680 OHM 1/8 +/-5%	R5
	RES, 1.2K OHM 1/8W +/-5%	R6
	RES, 390 OHM 1/8W +/-5%	R8
	RES, METAL 8.2K OHM 1/8W +/-5%	R9
	RES, METAL 3.3K OHM 1/8W +/-5%	R10
	RES, 470 OHM 1/8 +/-5%	R11
	RES, 2.2K OHM 1/8W +/-5%	R12
	RES, 820 OHM 1/8 +/-5%	R13
	RES,100 OHM 1/8W +/-5%	R14
	RES, METAL 10K OHM 1/8W +/-5%	R15
	RES, 270 OHM 1/8W +/-5%	R16
	RES, 2.2K OHM 1/8W +/-5%	R17
	RES, 2.2K OHM 1/8W +/-5%	R18
	RES, METAL 10K OHM 1/8W +/-5%	R19
	RES, 270 OHM 1/8W +/-5%	R20
	RES, 47K OHM 1/8W +/-5%	R21

Part No.	Description	Symbol
	RES, 5.1K OHM 1/8W +/-5%	R22
	RES, METAL 2.7K OHM 1/8W +/-5%	R23
	RES, 560 OHM 1/8W +/-5%	R25
	RES, 47 OHM 1/8W +/-5%	R26
	RES, 22K OHM 1/8W +/-5%	R27
	RES, 68K OHM 1/8W +/-5%	R28
	RES, 2.7K OHM 1/8W +/-5%	R29
		R30
	RES, 1.5K OHM 1/8W +/-5%	R31
	RES, 1.5K OHM 1/8W +/-5%	R32
	RES, 47K OHM 1/8W +/-5%	R33
	RES, 33K OHM 1/8W +/-5%	R34
	RES, 3.3K OHM 1/8W +/-5%	R36
	RES, 2.42K OHM 1/8W +/-1%	R37
	RES, 4.43K OHM 1/8W +/-1%	R38
	RES, 2K OHM 1/8W +/-2%	R39
	RES, 21.3K OHM 1/8W +/-1%	R40
	RES, 39K OHM 1/8W +/-5%	R41
	RES, 33K OHM 1/8W +/-5%	R42
	RES, 8.2K OHM 1/10W +/-5%	R43
	RES, METAL 1K OHM 1/10W +/-5%	R44
	RES, METAL 1K OHM 1/10W +/-5%	R45
	RES, METAL 10K OHM 1/8W +/-5%	R46
	RES, METAL 10K OHM 1/8W +/-5%	R47
	RES, METAL 10K OHM 1/8W +/-5%	R48
	RES, 2.2 OHM 1/5W +/-5%	R49
	RES, METAL 100K OHM 1/8W +/-5%	R50
	RES, METAL 47 OHM 1/8W +/-5%	R51
	RES, 8.2K OHM 1/8W +/-5%	R52
	RES, 2.2 OHM 1/5W +/-5%	R53
	RES, 330 OHM 1/8W +/-5%	R54
	RES, 5.6K OHM 1/8W +/-5%	R55
	RES, 1.8K OHM 1/8W +/-5%	R56
	RES, 100 OHM 1/8W +/-5%	R57
	RES, METAL 3.3K OHM 1/8W +/-5%	R58
	RES, 390 OHM 1/8W +/-5%	R59
	RES, 47 OHM 1/4W +/-5%	R60
	RES, 47 OHM 1W +/-5%	R61

Part No.	Description	Symbol
	RES, 10 OHM 1W +/-5%	R62
	RES, METAL 220 OHM 1W +/-5%	R63
	RES, METAL 2.7K OHM 1W +/-5%	R64
	RES, METAL 3.3K OHM 1/8W +/-5%	R65
	RES, METAL 22K OHM 1/8W +/-5%	R66
	RES, METAL 10K OHM 1/8W +/-5%	R67
	RES, 1.5M OHM 1/8W +/-5%	R68
	RES, 1.2K OHM 1/8W +/-5%	R69
	RES, 330 OHM 1/2W +/-5%	R70
	RES, 1.8K OHM 1/2W +/-5%	R71
	RES, 150 OHM 1/8W +/-5%	R72
	RES, 2.2 OHM 1/5W +/-5%	R73
	RES, 150 OHM 1/8W +/-5%	R74
	RES, METAL 1K OHM 1/8W +/-5%	R75
	RES, METAL 1K OHM 1/8W +/-5%	R76
	RES, METAL 1K OHM 1/8W +/-5%	R77
	RES, 100 OHM 1/8W +/-5%	R78
	RES, METAL 1K OHM 1/8W +/-5%	R79
	RES, 470 OHM 1/8W +/-5%	R80
	RES, 150 OHM 1/8W +/-5%	R81
	RES, 100 OHM 1/8W +/-5%	R82
	RES, 100 OHM 1/8W +/-5%	R83
	RES, 10 OHM 1/8W +/-5%	R84
	RES, METAL 1K OHM 1/8W +/-5%	R85
	RES, 100 OHM 1/8W +/-5%	R86
	RES, METAL 8.2K OHM 1/8W +/-5%	R87
	RES, CHIP 1.2K OHM 1/10W +/-5%	R91
	RES, CHIP 220 OHM 1/10W +/-5%	R92
	RES, CHIP 68K OHM 1/10W +/-5%	R93
	RES, CHIP 12K OHM 1/10W +/-5%	R94
	RES, CHIP 470 OHM 1/10W +/-5%	R95
	RES, CHIP 33 OHM 1/10W +/-5%	R96
	RES, CHIP 270K OHM 1/10W +/-5%	R97
	RES, 120 OHM 1/8W +/-5%	R108
	RES, 5.6K OHM 1/8 +/-5%	R201
	RES, METAL 22K OHM 1/8W +/-5%	R202
	RES, METAL 10K OHM 1/8W +/-5%	R203
	RES, METAL 15K OHM 1/8W +/-5%	R204

Part No.	Description	Symbol
	RES, METAL 120 OHM 1/8W +/-5%	R205
	RES, METAL 100 OHM 1/8W +/-5%	R206
	RES, METAL 47K OHM 1/8W +/-5%	R207
	RES, METAL 68 OHM 1/8W +/-5%	R208
	RES, METAL 22K OHM 1/8W +/-5%	R209
	RES, METAL 1M OHM 1/4W +/-5%	R210
	RES, METAL 8.2K OHM 1/8W +/-5%	R211
	RES, METAL 10K OHM 1/8W +/-5%	R212
	RES, METAL 220 OHM 1/8W +/-5%	R213
	RES, METAL 220 OHM 1/8W +/-5%	R214
	RES, 3.3 OHM 1/8W +/-5%	R215
	RES, 3.3 OHM 1/8W +/-5%	R216
	RES, 3.3 OHM 1/8W +/-5%	R217
	RES, 3.3 OHM 1/8W +/-5%	R218
	RES, 3.3 OHM 1/8W +/-5%	R219
	RES, 3.3 OHM 1/8W +/-5%	R220
	RES, 3.3 OHM 1/8W +/-5%	R220
	RES, 3.3 OHM 1/8W +/-5%	R221
	RES, 3.3 OHM 1/8W +/-5%	R222
	RES, 4.7K OHM 1/8W +/-5%	R223
	RES, 4.7K OHM 1/8W +/-5%	R224
	RES, 4.7K OHM 1/8W +/-5%	R225
	RES, 4.7K OHM 1/8W +/-5%	R226
	RES, 4.7K OHM 1/8W +/-5%	R227
	RES, 4.7K OHM 1/8W +/-5%	R228
	RES, 4.7K OHM 1/8W +/-5%	R229
	RES, 4.7K OHM 1/8W +/-5%	R230
	RES, METAL 10K OHM 1/8W +/-5%	R231
	RES, METAL 10K OHM 1/8W +/-5%	R232
	RES, METAL 10K OHM 1/8W +/-5%	R233
	RES, METAL 10K OHM 1/8W +/-5%	R234
	RES, METAL 10K OHM 1/8W +/-5%	R235
	RES, METAL 100K OHM 1/8W +/-5%	R236
	RES, CARBONFILM 2.2 OHM 1/5W +/-5%	R238
	RES, 10K OHM 1/8W +/-5%	R239
	RES, CARBONFILM 2.2K OHM 1/5W +/-5%	R245
	RES, CARBONFILM 2.2K OHM 1/5W +/-5%	R246
	RES, CARBONFILM 2.2K OHM 1/5W +/-5%	R247

Part No.	Description	Symbol
	RES, CARBONFILM 24K OHM 1/5W +/-5%	R248
	RES, CARBONFILM 18K OHM 1/5W +/-5%	R249
	RES, CARBONFILM 56K OHM 1/5W +/-5%	R250
		R251-R259
	RES, METAL 1K OHM 1/8W +/-5%	R260
	RES, METAL 100K OHM 1/8W +/-5%	R261
	RES, METAL 100K OHM 1/8W +/-5%	R262
	RES, METAL 10K OHM 1/8W +/-5%	R263
	RES, METAL 100K OHM 1/8W +/-5%	R264
	RES, METAL 100K OHM 1/8W +/-5%	R265
	RES, METAL 100K OHM 1/8W +/-5%	R266
	RES, METAL 100K OHM 1/8W +/-5%	R267
	RES, METAL 2.2K OHM 1/8 +/-5%	R268
	RES, METAL 10K OHM 1/8W +/-5%	R269
	RES, METAL 220K OHM 1/8W +/-5%	R270
	RES, METAL 5.6K OHM 1/8W +/-5%	R271
	RES, 4.7K OHM 1/8W +/-5%	R272
	RES, 47K OHM 1/8W +/-5%	R273
	RES, METAL 3.3K OHM 1/8 W +/-5%	R274
	RES, 4.7K OHM 1/8W +/-5%	R275
	RES, 3.9K OHM 1/8W +/-5%	R276
	RES, 5.6K OHM 1/8W +/-5%	R277
	RES, METAL 10K OHM 1/8W +/-5%	R278
	RES, 680K OHM 1/8W +/-5%	R279
	RES, 680K OHM 1/8W +/-5%	R280
	RES, 680K OHM 1/8W +/-5%	R281
	RES, METAL 10K OHM 1/8W +/-5%	R282
	RES, METAL 220K OHM 1/8W +/-5%	R283
	RES, METAL 150K OHM 1/8W +/-5%	R284
	RES, METAL 82K OHM 1/8W +/-5%	R285
	RES, METAL 3.3K OHM 1/8 W +/-5%	R286
	RES, METAL 10K OHM 1/8 W +/-5%	R287
	RES, METAL 1K OHM 1/8 W +/-5%	R288
	RES, METAL 620 OHM 1/8 W +/-5%	R289
	RES, METAL 22K OHM 1/8 W +/-5%	R290
	RES, METAL 27K OHM 1/8 W +/-5%	R291
	RES, METAL 33K OHM 1/8 W +/-5%	R292
	RES, METAL 240K OHM 1/8 W +/-5%	R293
	RES, METAL 10K OHM 1/8W +/-5%	R294
	RES, METAL 1.5K OHM 1/8 W +/-5%	R295

Part No.	Description	Symbol
	RES, METAL 270K OHM 1/8 W +/-5%	R296
	RES, METAL 1.53.3K OHM 1/8 W +/-5%	R297
	RES, METAL 10K OHM 1/8W +/-5%	R298
	RES, METAL 10K OHM 1/8W +/-5%	R299
	RES, METAL 5.6K OHM 1/8W +/-5%	R300
	RES, METAL 10K OHM 1/8W +/-5%	R301
	RES, METAL 47K OHM 1/8W +/-5%	R302
	RES, 4.7K OHM 1/8W +/-5%	R303
	RES, METAL 10K OHM 1/8W +/-5%	R304
	RES, METAL 5.6K OHM 1/8W +/-5% (HIGH BAND)	R305
	RES, METAL 27K OHM 1/8W +/-5%	R306
	RES, METAL 1.5K OHM 1/8W +/-5%	R307
	RES, METAL 22K OHM 1/8W +/-5%	R308
	RES, METAL 47K OHM 1/8W +/-5%	R309
	RES, METAL 10K OHM 1/8W +/-5%	R310
	RES, METAL 470 OHM 1/8W +/-5%	R311
	RES, METAL 22K OHM 1/8W +/-5%	R312
	RES, METAL 2.2K OHM 1/8 +/-5%	R313
	RES, 3.9K OHM 1/8W +/-5%	R315
	RES, 15K OHM 1/8W +/-5%	R316
	RES, 3.9K OHM 1/8W +/-5%	R317
	RES, 6.8K OHM 1/8W +/-5%	R318
	RES, METAL 3.3K OHM 1/8 W +/-5%	R319
	RES, METAL 8.2K OHM 1/8W +/-5%	R320
	RES, METAL 1K OHM 1/8W +/-5%	R323
	RES, METAL 1.2K OHM 1/8W +/-5%	R324
	RES, METAL 5.6K OHM 1/8W +/-5%	R325
	RES, METAL 1.2K OHM 1/8W +/-5%	R326
	RES, 100 OHM 1/8W +/-5%	R327
	RES, 56 OHM 1/8W +/-5%	R328
	RES, METAL 10K OHM 1/8W +/-5%	R329
	RES, METAL 220 OHM 1/8W +/-5%	R330
	RES, METAL 470 OHM 1/8W +/-5%	R331
	RES, METAL 1K OHM 1/8W +/-5%	R332
	RES, METAL 100K OHM 1/8W +/-5%	R333
	RES, METAL 22 OHM 1/8W +/-5%	R334
	RES, METAL 220 OHM 1/8W +/-5%	R235
	RES, METAL 100K OHM 1/8W +/-5%	R336

Part No.	Description	Symbol
	RES, METAL 82K OHM 1/8W +/-5%	R237
	RES, METAL 220 OHM 1/8W +/-5%	R338
	RES, METAL 8.2K OHM 1/8W +/-5%	R339
	RES, METAL 68 OHM 1/8W +/-5% (LOW HIGH BAND)	R340
	RES, 4.7K OHM 1/8W +/-5%	R341
	RES, 100 OHM 1/8W +/-5%	R342
	RES, METAL 8.2K OHM 1/8W +/-5%	R343
	RES, 4.7K OHM 1/8W +/-5%	R344
	RES, 100 OHM 1/8W +/-5%	R345
	RES, 6.8K OHM 1/8W +/-5%	R346
	RES, METAL 1K OHM 1/8W +/-5%	R347
	RES, METAL 3.3K OHM 1/8 W +/-5%	R348
	RES, METAL 330 OHM 1/8 W +/-5%	R349
	RES, METAL 1 OHM 1/8 W +/-5%	R353
	RES, METAL 390K OHM 1/8 W +/-5%	R354
	RES, METAL 1.5K OHM 1/8 W +/-5%	R355
	RES, METAL 5.6K OHM 1/8 W +/-5%	R356
	RES, METAL 10K OHM 1/8W +/-5%	R357
	RES, METAL 10K OHM 1/8W +/-5%	R368
	RES, CHIP 56K OHM 1/10 +/-5%	R400
	RES, CHIP 56K OHM 1/10W +/- 5%	R401
	RES, CHIP 10K OHM 1/10W +/- 5%	R402
	RES, CHIP 33K OHM 1/10W +/- 5%	R403
	RES, CHIP 4.7K OHM 1/10W +/- 5%	R404
	RES, CHIP 100K OHM 1/10W +/- 5%	R405
	RES, CHIP 3.3K OHM 1/10W +/- 5%	R406
	RES, CHIP 270K OHM 1/10W +/- 5%	R407
	RES, CHIP 270K OHM 1/10W +/- 5%	R408
	RES, CHIP 1.2K OHM 1/10W +/- 5%	R420
	RES, CHIP 220 OHM 1/10W +/- 5%	R421
	RES, CHIP 68K OHM 1/10W +/- 5%	R422
	RES, CHIP 12K OHM 1/10W +/- 5%	R423
	RES, CHIP 470 OHM 1/10W +/- 5%	R424
	RES, CHIP 33 OHM 1/10W +/- 5%	R425
	RES, CHIP 270K OHM 1/10W +/- 5%	R426
	RES, CHIP 560 OHM 1/10W +/- 5%	R427
	RES, 10K OHM 1/8W +/-5%	R814
	RES, 6.8K OHM 1/8W +/-5%	R815

Part No.	Description	Symbol
R29/ 069-023-4	RES, ARRAY mHR-8-103JA 10K X 8, 9 PIN	RA1
R29/ 069-023-4	RES, ARRAY mHR-8-103JA 10K X 8, 9 PIN	RA2
R29/ 069-023-4	RES, ARRAY mHR-8-103JA 10K X 8, 9 PIN	RA3
	RES, SEMIFIXED 10K OHM	RV1
	RES, SEMIFIXED 10K OHM	RV2
	RES, SEMIFIXED 10K OHM	RV3
	RES, SEMIFIXED 4.7K OHM	RV4
	RES, SEMIFIXED 22K OHM	RV5
	RES, SEMIFIXED 2.2K OHM	RV401
	RES, SEMIFIXED 2.2K OHM, H0614C	RV10
	COIL, 144-04J12	T1
	SHIELD CASE, 14 X 14 X 18.5 (H)	(T1)
	COIL, 144-04J12	T2
	SHIELD CASE, 14 X 14 X 18.5 (H)	(T2)
	COIL, 144-04J12	T3
	SHIELD CASE, 14 X 14 X 18.5 (H)	(T3)
	COIL, 144-04J12 (HIGH BAND)	T4
	COIL, 144-04J12 (MID/LOW BAND)	T4
	SHIELD CASE, 14 X 14 X 18.5 (H)	(T4)
	COIL, 144-04J12	T5
	SHIELD CASE, 14 X 14 X 18.5 (H)	(T5)
	COIL, 144-04J12	T6
	COIL, 144-04J12	T7
	COIL, IFT 21.4 mHZ (A)	T8
	COIL, IFT 21.4 mHZ (B)	T9
	455 KHZ DET	T10
R29/ 310-677-8	TRANSFORMER DC/DC CONVERTER	T101
	COIL, 144-03J12	T12
R29/ 171-013-9	CAP, TRIMMER 10 PF (HIGH MID BAND)	TC1
	CAP, TRIMMER 20 PF (LOW BAND)	TC1
R29/ 171-013-9	CAP, TRIMMER 10 PF (HIGH MID BAND)	TC2
	CAP, TRIMMER 20 PF (LOW BAND)	TC2
	CAP, TRIMMER 6 PF	TC3
	CAP, TRIMMER 6 PF (MID LOW BAND)	TC4
	CAP, TRIMMER 6 PF	TC5
R29/ 171-014-0	CAP, TRIMMER	TC6
R29/ 171-014-0	CAP, TRIMMER	TC7
R29/ 098-252-8	THERMISTOR, 2.5K OHM +/-15% (RED)	TH1
R29/ 097-102-1	THERMISTOR, 1K OHM +/-15% (RED)	TH2
R29/ 099-303-6	THERMISTOR, 30K OHM +/-15% (GRAY)	TH3

Part No.	Description	Symbol
R29/ 098-101-5	THERMISTOR, 100K OHM +/-15% (WHITE)	TH4
R29/ 097-503-0	THERMISTOR, 50K OHM +/-15% (RED)	TH5
R29/ 450-104-0	RES, VARIABLE 10K (C)	VR1
R29/ 450-105-1	RES, VARIABLE 10K (A)	VR2
	RIBBON CABLE	W1
	CRYSTAL UNIT 20.945 mHZ	X1
	CRYSTAL, UNIT 8.2944 mHZ	X2
	CRYSTAL, UNIT 10.240 mHZ	X3
	FILTER CRYSTAL 21F15B	XF1
	FILTER CRYSTAL 21F15B	XF2

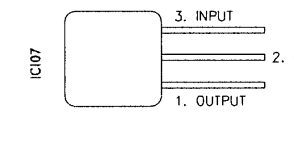
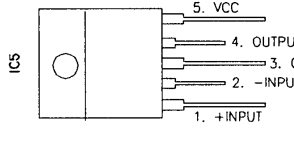
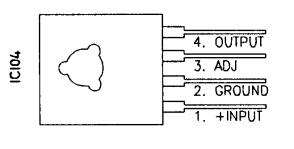
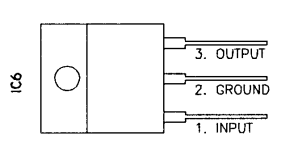
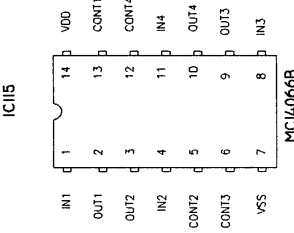
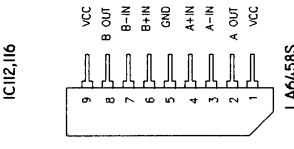
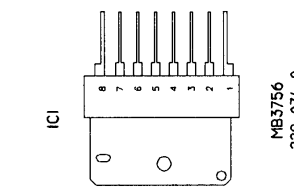
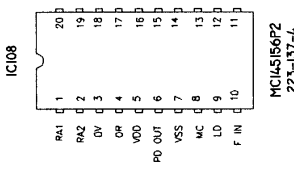
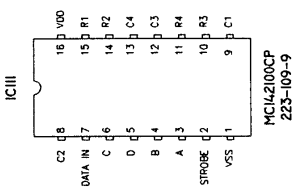
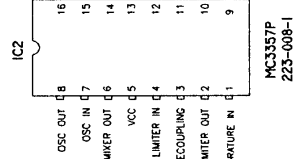
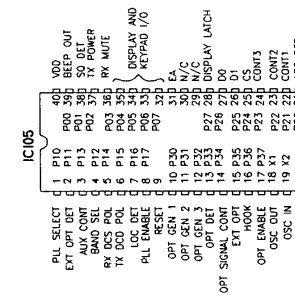
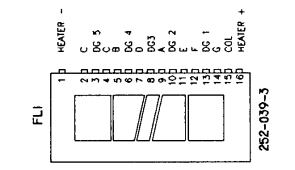
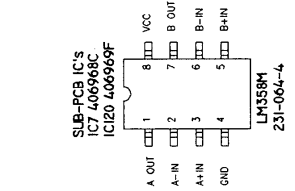
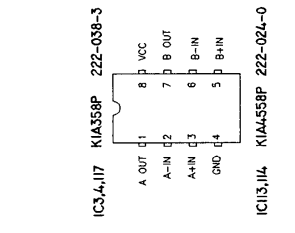
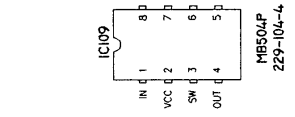
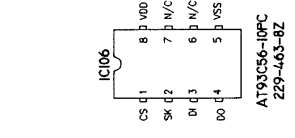
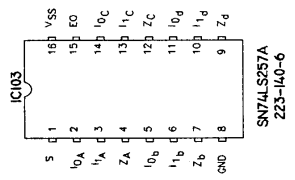
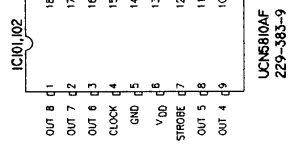

PRINTED CIRCUIT BOARD LAYOUT

MONOGRAM SERIES LBI-38864B TOP VIEW 406041-F ISSUE: H / DIGITAL BOARD

TOP VIEW 406041-F ISSUE: H / DIGITAL BOARD

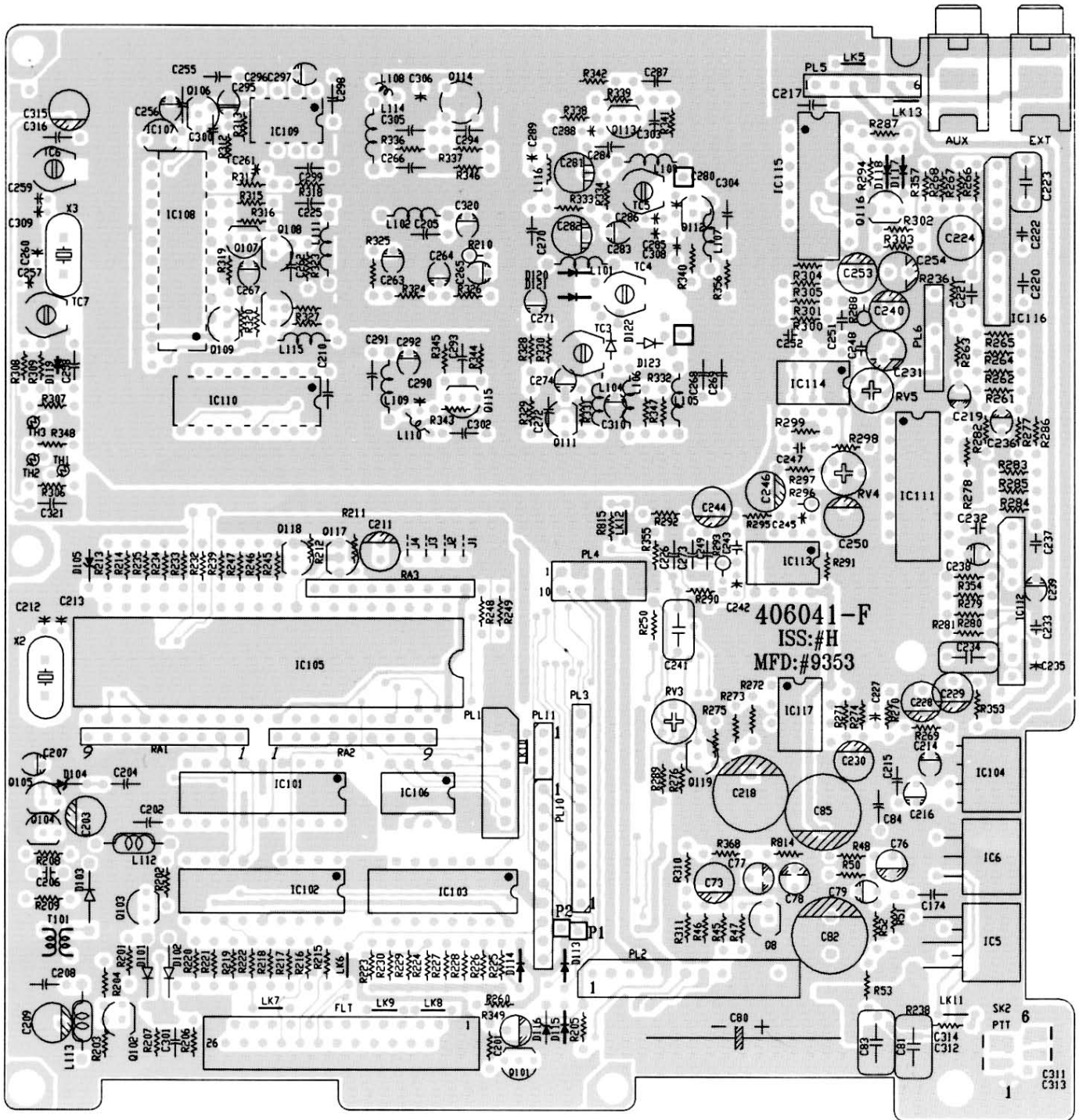

**MONOGRAM SERIES LBI-38864B
BOTTOM VIEW 406041-F ISSUE: H / DIGITAL BOARD**

BOTTOM VIEW 406041-F ISSUE: H / DIGITAL BOARD

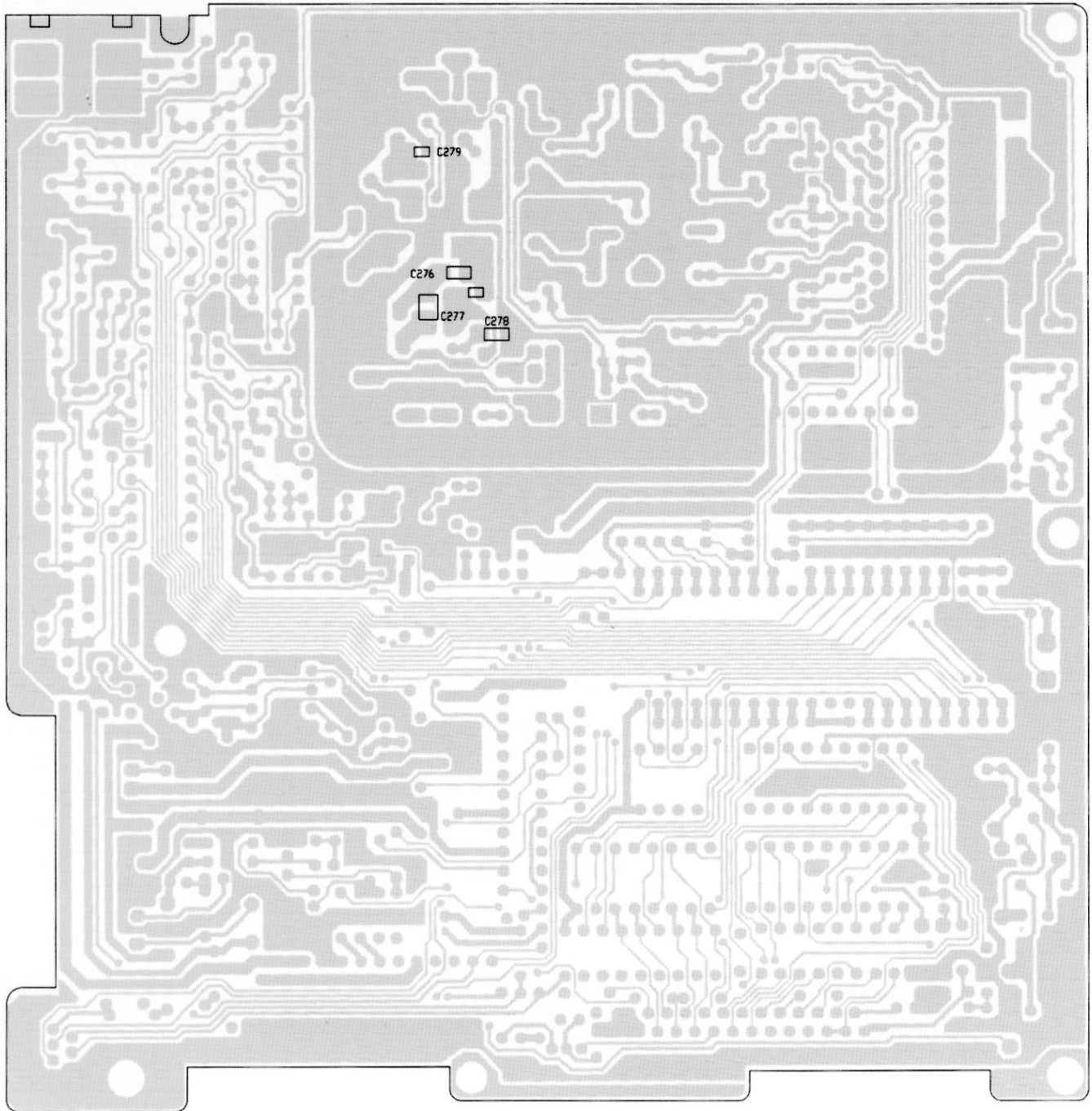

**MONOGRAM SERIES LBI-38864B
TOP VIEW 406039-E ISSUE: H / RF BOARD**

TOP VIEW 406039-E ISSUE: H / RF BOARD

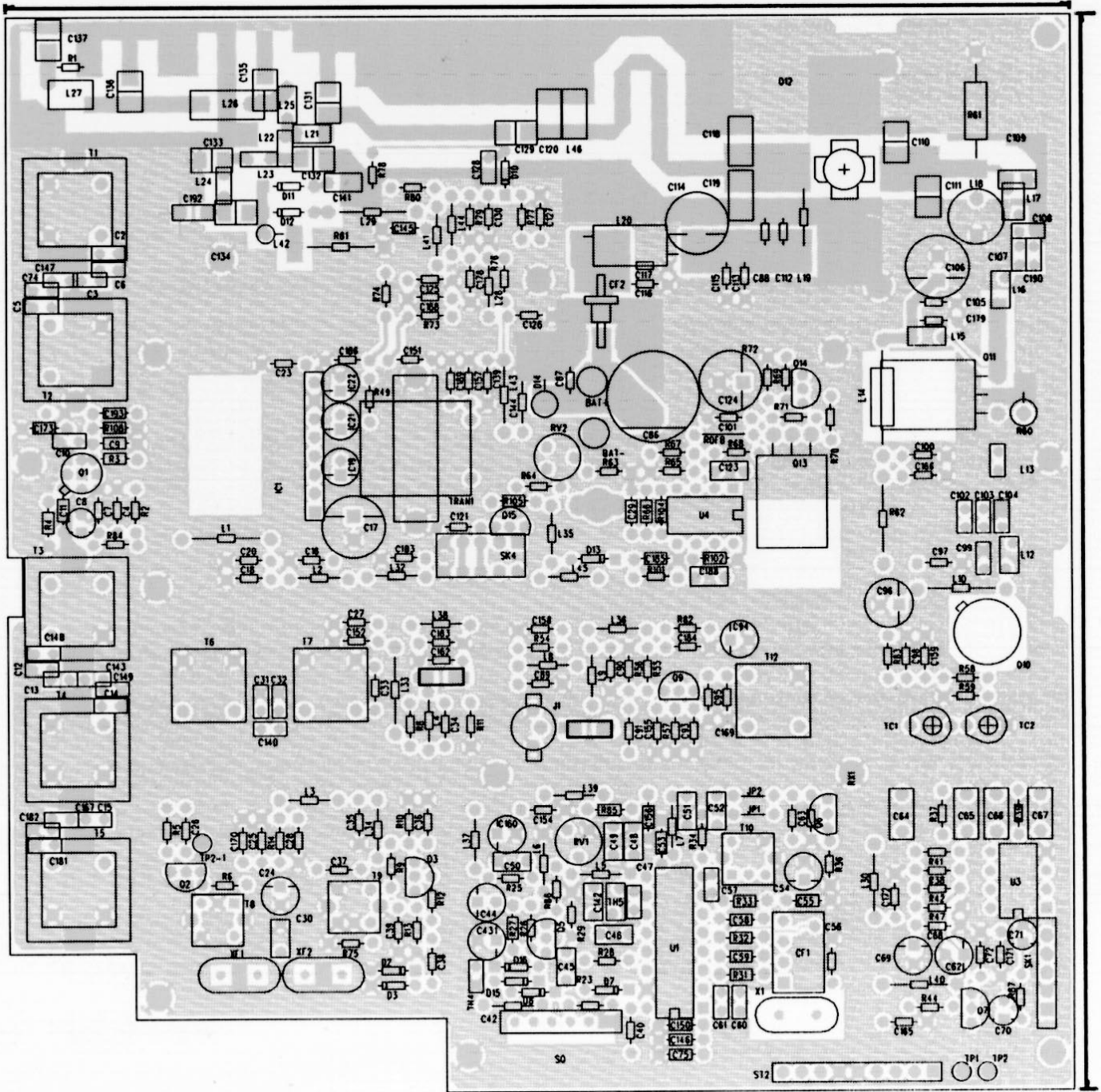

**MONOGRAM SERIES LBI-38864B
BOTTOM VIEW 406039-E ISSUE: H / RF BOARD**

BOTTOM VIEW 406039-E ISSUE: H / RF BOARD

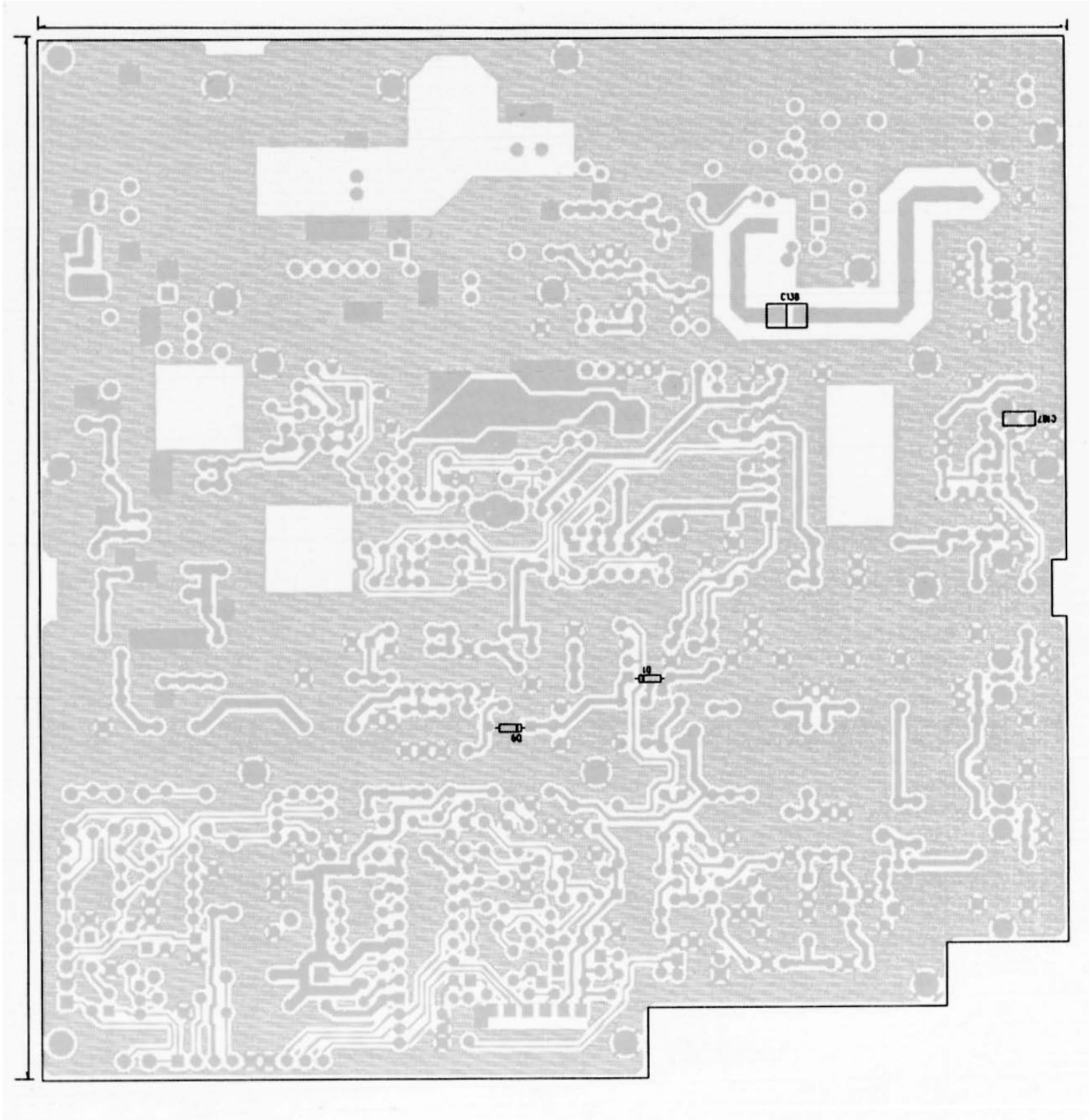

MONOGRAM SERIES LBI-38864B PRINTED CIRCUIT BOARDS

PRINTED CIRCUIT BOARDS

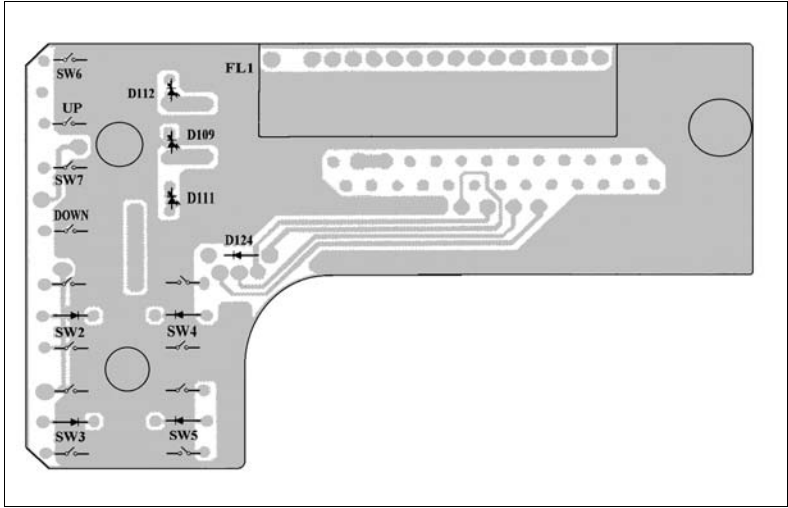

DISPLAY BOARD TOP VIEW

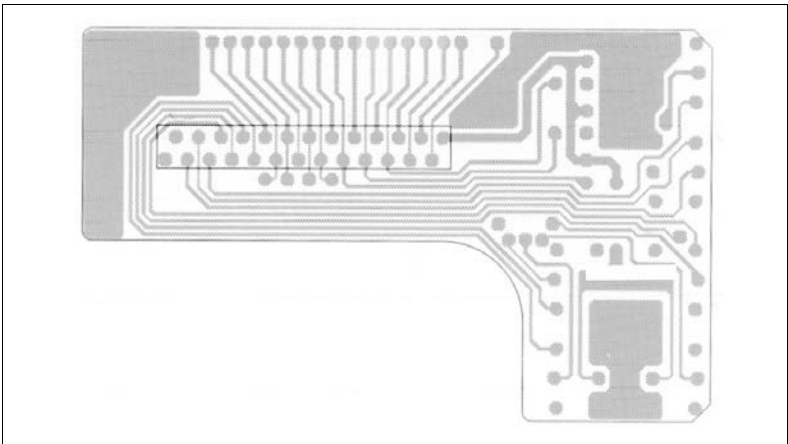

DISPLAY BOARD BOTTOM VIEW

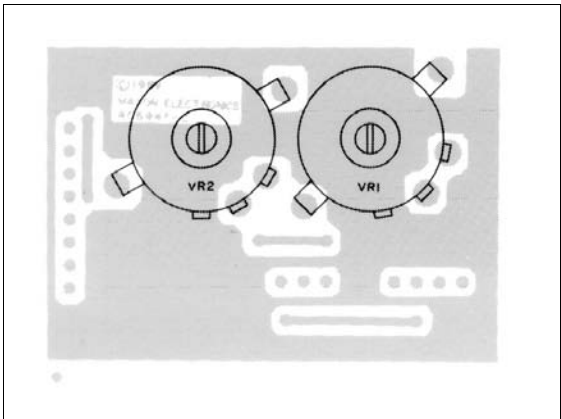

VOLUME BOARD TOP VIEW

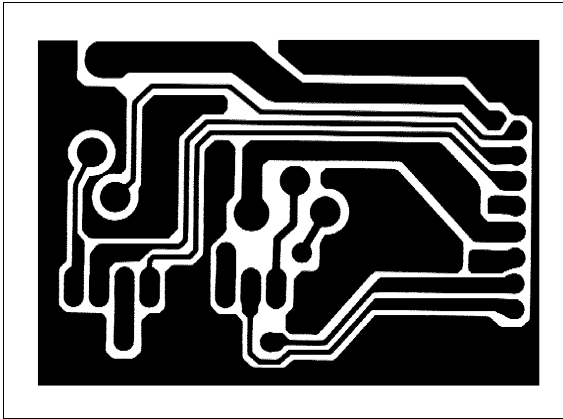

VOLUME BOARD BOTTOM VIEW

MONOGRAM SERIES LBI-38864B PRINTED CIRCUIT BOARDS

PRINTED CIRCUIT BOARDS

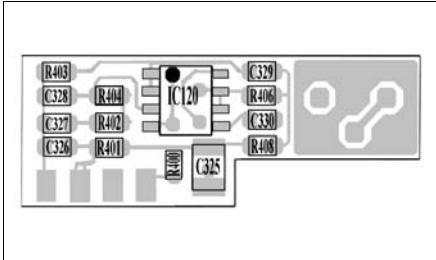

406-969-F (DIG. PCB) TOP

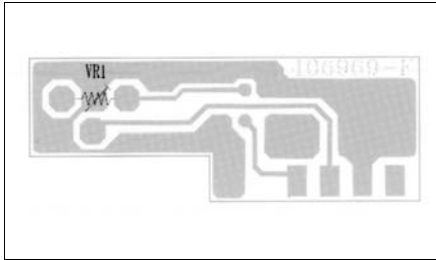

406-969-F (DIG. PCB) BOTTOM

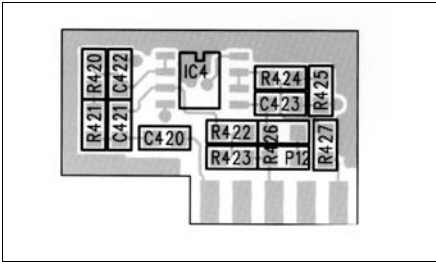

406-968-C (RF. PCB) TOP

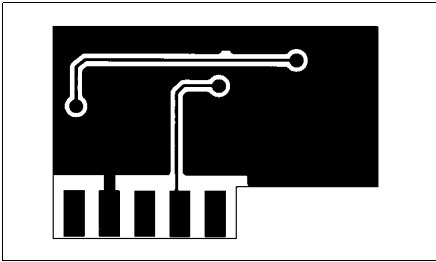

406-968-C (RF. PCB) BOTTOM

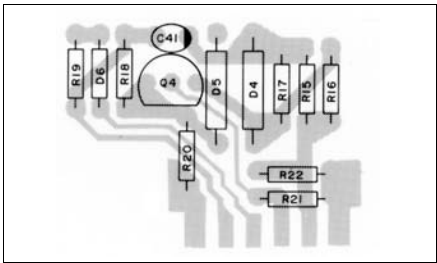

406-973-A TOP

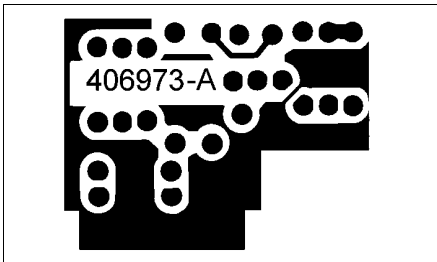

406-973-A BOTTOM

MONOGRAM SERIES LBI-38864B

VOLTAGE CHARTS

VOLTAGE CHARTS

RF PCB

Q1	RX	TX
Gate 1	6.0	0.0
Gate 2	1.0	0.0
Drain	8.0	0.0
Source	1.5	0.0

Q2	RX	TX
Gate	0.0	0.0
Drain	2.5	0.0
Source	7.5	0.0

Q3	RX	TX
B	2.3	0.0
E	1.5	0.0
C	3.9	0.0

Q4	RX Signal Applied		
	UNSQ	SQ	TX
E	7.0	4.4	7.84
B	1.7	4.2	1.0
C	1.0	3.3	0.3

Q5	RX	TX
E	7.2	7.2
B	6.85	6.58
C	2.6	4.2

Q6	RX	TX
E	3.8	0.0
B	4.5	0.0
C	8.20	8.23

Q7	RX		
	UNSQ	SQ	TX
E	0.0	0.0	0.0
B	0.0	0.65	0.65
C	0.0	0.0	0.0

Q9	RX	TX
B	0.0	1.58
E	0.0	1.45
C	0.0	6.75

Q10	RX	TX
E	0.0	0.0
B	0.0	0.0
C	0.0	7.8

Q11	RX	TX
C	0.0	8.4
E	0.0	0.0
B	0.0	0.4

Q12	RX	TX
E	0.0	0.0
B	0.0	0.0
C	13.8	13.8

Q13	RX	TX
E	13.8	13.3
B	0.0	8.0
C	13.8	12.7

Q14	RX	TX
E	0.0	0.60
B	0.0	1.20
C	13.8	11.6

IC1	RX	TX
1	8.3	8.3
2	13.8	13.5
3	8.3	8.3
4	0.0	0.0
5	4.25	0.0
6	8.3	0.0
7	0.0	0.0
8	0.0	8.3

IC2	RX		
	UNSQ	SQ	TX
1	7.95	8.01	0.0
2	7.47	7.43	0.0
3	7.68	7.74	0.0
4	8.0	8.0	0.0
5	1.0	1.0	0.0
6	1.0	1.0	0.0
7	1.0	1.0	0.0
8	8.0	8.0	0.0
9	3.9	4.5	0.0
10	1.95	1.95	.05
11	1.95	1.95	1.0
12	0.3	1.40	0.2
13	7.4	0.0	0.0
14	0.0	5.0	5.0
15	0.0	0.0	0.0
16	2.0	2.0	0.0

IC3	RX	TX
1	4.5	4.5
2	4.5	4.5
3	4.4	4.4
4	0.0	0.0
5	4.5	4.5
6	4.5	4.5
7	4.5	4.5
8	8.2	8.2

IC4	RX	TX
1	0.0	1.4
2	0.6	1.0
3	0.0	1.0
4	0.0	0.0
5	0.5	0.18
6	0.5	0.4
7	7.0	7.30
8	8.3	8.3

406968-F	Sub	PCB
	IC4	RX TX
1	4.4	4.5
2	4.4	4.5
3	4.4	4.4
4	0.0	0.0
5	4.3	4.3
6	4.5	4.6
7	4.5	4.6
8	8.2	8.2

MONOGRAM SERIES LBI-38864B VOLTAGE CHARTS

VOLTAGE CHARTS

DIGITAL PCB

IC5	RX	TX
1	1.40	1.40
2	0.82	0.84
3	0.0	0.0
4	6.56	6.52
5	13.8	13.7

IC6	RX	TX
IN	13.8	13.7
GND	0.0	0.0
OUT	5.0	5.0

IC101	RX	TX
1	0.0	0.0
2	0.0	0.0
3	3.80	3.80
4	4.50	4.50
5	0.0	0.0
6	5.0	5.0
7	0.0	0.0
8	3.7	3.7
9	3.8	3.8
10	3.8	3.8
11	3.8	3.8
12	3.8	3.8
13	0.0	0.0
14	4.6	4.6
15	24.2	24.2
16	0.8	0.1
17	3.9	3.9
18	3.9	24.1

IC104	RX	TX
1	13.8	13.6
2	0.0	0.0
3	0.0	0.0
4	8.5	8.5

IC102	RX	TX
1	0.65	0.65
2	4.50	4.50
3	4.50	4.50
4	4.50	4.50
5	0.0	0.0
6	5.0	5.0
7	0.0	0.0
8	6.76	6.80
9	6.80	6.80
10	4.6	4.6
11	6.82	7.30
12	4.6	4.6
13	0.0	0.0
14	4.7	4.7
15	13.13	13.13
16	1.63	0.23
17	4.90	4.90
18	4.80	12.95

IC103	RX	TX
1	0.07	0.07
2	5.0	0.0
3	5.0	5.0
4	4.50	4.50
5	5.0	5.0
6	5.0	5.0
7	4.69	4.71
8	0.0	0.0
9	5.0	5.0
10	5.0	5.0
11	5.0	5.0
12	4.6	4.6
13	5.0	5.0
14	5.0	5.0
15	5.0	5.0
16	5.0	5.0

	IC105 RX		
	UNSQ	SQ	TX
1	5.0	5.0	5.0
2	5.0	5.0	5.0
3	5.0	5.0	5.0
4	5.0	5.0	5.0
5	5.0	5.0	5.0
6	5.0	5.0	5.0
7	0.0	0.0	0.0
8	0.0	0.0	0.0
9	0.0	0.0	0.0
10	0.1	0.1	0.125
11	0.1	0.1	0.125
12	0.1	0.1	0.124
13	5.0	5.0	5.0
14	0.0	0.0	0.0
15	0.0	0.0	0.0
16	0.0	0.0	0.0
17	5.0	5.0	0.0
18	2.6	2.6	2.6
19	2.4	2.4	2.4
20	0.0	0.0	0.0
21	5.0	5.0	5.0
22	0.0	0.0	0.0
23	5.0	5.0	5.0
24	0.0	0.0	0.0
25	0.0	0.0	0.0
26	0.0	0.0	0.0
27	5.0	5.0	5.0
28	0.0	0.0	0.0
29	5.0	5.0	5.0
30	1.60	1.60	1.60
31	5.0	5.0	5.0
32	5.0	5.0	5.0
33	4.7	4.7	4.7
34	4.6	4.6	4.6
35	4.5	4.5	4.5
36	0.0	0.8	0.9
37	0.0	4.3	0.0
38	0.0	5.0	5.0
39	2.58	2.58	2.59
40	5.0	5.0	5.0

MONOGRAM SERIES LBI-38864B

VOLTAGE CHARTS

VOLTAGE CHARTS

IC106	RX	TX
1	0.0	0.0
2	0.0	0.0
3	0.0	0.0
4	5.0	5.0
5	0.0	0.0
6	5.0	5.0
7	0.0	0.17
8	5.0	5.0

IC107	RX	TX
OUT	5.0	5.0
GND	0.0	0.0
IN	8.5	8.5

IC108	RX	TX
1	8.5	8.5
2	8.5	8.5
3	8.5	8.5
4	8.5	8.5
5	8.5	8.5
6	2.8	2.4
7	0.0	0.0
8	8.2	7.6
9	8.5	8.5
10	4.2	4.2
11	0.0	0.0
12	0.0	0.0
13	0.0	0.0
14	0.0	8.56
15	0.0	0.14
16	0.0	0.0
17	4.6	4.6
18	4.4	4.4
19	3.87	3.87
20	8.5	8.5

IC109	RX	TX
1	2.6	2.6
2	5.0	5.0
3	0.24	0.24
4	2.95	3.0
5	0.0	0.0
6	4.95	4.62
7	0.0	0.0
8	2.55	2.55

IC110	RX	TX
1	5.0	5.0
2	8.5	8.5
3	0.0	0.0
4	8.6	8.6
5	0.0	0.14
6	0.0	0.0
7	0.0	0.0
8	0.0	0.0
9	0.0	0.0
10	0.0	0.0
11	0.0	0.0
12	0.0	0.0
13	5.0	5.0
14	0.0	0.13
15	0.0	0.0
16	8.55	8.55

IC111	RX	TX
1	0.0	0.02
2	0.025	0.043
3	0.10	0.21
4	0.10	0.12
5	0.10	0.12
6	5.0	5.0
7	0.0	0.0
8	0.0	0.0
9	1.8	0.3
10	2.0	2.0
11	1.87	1.87
12	0.0	0.0
13	2.6	2.6
14	1.86	1.86
15	2.8	2.7
16	5.0	5.0

IC114	RX	TX
1	4.54	2.83
2	4.54	2.83
3	0.11	2.83
4	0.0	0.0
5	2.83	2.83
6	2.83	2.83
7	2.83	2.83
8	5.0	5.0

IC115	RX	TX
1	3.36	3.36
2	0.38	0.40
3	0.0	0.0
4	2.83	2.85
5	0.0	0.0
6	0.0	5.0
7	0.0	0.0
8	0.0	2.75
9	4.54	2.83
10	0.0	0.0
11	0.0	2.85
12	4.30	0.0
13	0.55	0.59
14	5.0	5.0

IC112	RX	TX
1	5.0	5.0
2	1.88	1.88
3	1.88	1.88
4	1.88	1.88
5	0.0	0.0
6	1.7	1.7
7	2.0	2.0
8	2.0	2.0
9	5.0	5.0

IC113	RX	TX
1	2.8	2.8
2	2.8	2.8
3	2.8	2.8
4	0.0	0.0
5	2.8	2.8
6	2.8	2.8
7	2.8	2.8
8	5.0	5.0

IC116	RX	TX
1	5.0	5.0
2	2.58	2.58
3	2.58	2.58
4	2.52	2.55
5	0.0	0.0
6	2.5	2.5
7	2.56	2.56
8	2.55	2.56
9	0.0	0.0

IC117	RX	TX
1	0.0	0.0
2	1.88	1.88
3	1.73	1.73
4	0.0	0.0
5	1.87	1.87
6	1.87	1.90
7	1.87	1.89
8	5.0	5.0

MONOGRAM SERIES LBI-38864B VOLTAGE CHARTS

VOLTAGE CHARTS

Q8	RX	TX
E	0.0	0.0
B	0.65	0.65
C	0.0	0.0

Q101	RX	TX
C	4.0	4.0
B	5.1	5.1
E	5.84	5.84

Q102	RX	TX
E	0.0	0.0
B	0.117	0.143
C	11.6	11.6

Q103	RX	TX
E	13.6	13.6
B	14.14	14.14
C	24.3	24.3

Q104	RX	TX
E	0.0	0.0
B	0.33	0.36
C	13.6	13.3

Q105	RX	TX
E	0.0	0.0
B	0.6	0.6
C	0.33	0.36

Q106	RX	TX
C	0.0	0.0
B	0.68	0.7
E	0.0	0.0

Q107	RX	TX
C	8.55	8.55
B	3.2	2.9
E	3.3	2.9

Q108	RX	TX
C	0.0	0.0
B	3.3	2.9
E	3.3	2.9

Q109	RX	TX
C	8.5	0.60
B	7.8	8.56
E	8.55	8.55

Q111	RX	TX
C	0.0	8.5
B	0.7	0.55
E	0.0	0.0

Q112	RX	TX
GATE	0.0	0.0
SRC	1.18	1.27
DRN	6.6	6.6

Q113	RX	TX
C	5.95	6.0
E	1.12	1.15
B	1.8	1.77

Q114	RX	TX
GATE1	0.9	0.9
GATE2	4.25	4.25
D	0.0	0.0
S	8.5	8.5

Q115	RX	TX
C	8.53	8.53
E	1.76	1.80
B	2.55	2.55

Q116	RX	TX
E	0.0	0.0
B	0.65	0.0
C	0.0	5.0

Q117	RX	TX
E	5.0	5.0
B	5.0	5.0
C	0.0	0.0

Q118	RX	TX
E	5.0	5.0
B	4.3	4.3
C	5.0	5.0

Q119	RX	TX
E	5.0	5.0
B	0.0	0.0
C	0.0	0.0

406969 Sub PCB		
IC102	RX	TX
1	1.85	1.89
2	1.85	1.87
3	1.85	1.85
4	0.0	0.0
5	1.86	1.86
6	1.86	1.86
7	1.86	1.86
8	5.0	5.0

EXPLODED VIEW AND EXPLODED VIEW PARTS LIST

NOTE

Only those items indicated by shading will be stocked by After Market Services. All other items are for reference only.

When ordering parts for your Monogram Series radio, precede all part numbers with the prefix "R29/"

MONOGRAM SERIES LBI-38864B

EXPLODED VIEW PARTS LIST

EXPLODED VIEW PARTS LIST		
REF. NO	PART NO	DESCRIPTION
1	R29 - 801-272	E.S.C NORYL N190-7002 BLK SPRAY
2	R29 - 813-854	LENS ACRYL BLUE
3	R29 - 420-152-4	SPEAKER A1727C03
3B	R29 - 905-510	FELT (SPEAKER)
4	R29 - 623-034	(+)TAPPING SCREW(PH)3X8-1S ZN-PLAT
5		P.C.B DISPLAY 71.5X44X1.2T FR4 1/1
6A	R29 - 436-013-5	LIGHTED SWITCHES (GREEN)
6B	R29 - 436-012-4	LIGHTED SWITCHES (RED)
7	R29 - 893-685	RUBBER SPONGE 38X9X1/2 RUBBER STICKER BLK
8	R29 - 252-039-3	FLUORESCENT DISPLAY 4-ST-01ZS1
9	R29 - 825-155-A	KNOB (FUNCTION KEY S) ACRYL CLEAR GOLD
10	R29 - 825-156-A	KNOB (FUNCTION KEY P) ACRYL CLEAR GOLD
11	R29 - 825-157-A	KNOB (FUNCTION KEY 1) ACRYL CLEAR GOLD
12	R29 - 825-158-A	KNOB (FUNCTION KEY 2) ACRYL CLEAR GOLD
13	R29 - 825-159-A	KNOB (FUNCTION KEY) ACRYL CLEAR GOLD
14	R29 - 622-201	(+)TAPPING SCREW (PH)2X6-1S ZN-PLAT
15	R29 - 622-201	(+)TAPPING SCREW (PH)2X6-1S ZN-PLAT
16		P.C.B VR 50X35X1.2T FR4 1/1
17-A	R29 - 450-104-0	VR 171PN2-4 C10K12KC
17-B	R29 - 450-105-1	VR 171PS2-4 A10K12KC
18	R29 - 650-220	NUT HEXAGON BSBM M7 (P:0.75)
19	R29 - 825-125-A	KNOB (SQUELCH) N190J-7002 RED
20	R29 - 825-120-A	KNOB (VOLUME) N190J-7002 RED
21		FRAME ALDC12 BLK SANDTONE SPRAY
22		P.C.B DIGITAL 164.4X147X1.2T FR4 1/1
23		CRYSTAL HC-18U 8.2944MHZ 703142
24		CRYSTAL 10.240MHZ SI-1060-0510-32
25	R29 - 420-728-5	JACK MINIATURE HSJ1785-01-030
26		SEMI-RIGID COAXIAL UT85
27	R29 - 660-314	WASHER(SQUARE) SPC 10X7X&3.2XT1 ZN-PLAT
28	R29 - 613-040	(+)MACHINE SCREW(PH)3X6 ZN-PLAT 1
29		PANEL TOP ALDC12 IRIDITE FINISH
30	R29 - 613-147	(+)MACHINE SCREW(PH)3X18 ZN-PLAT
31	R29 - 613-068	(+)MACHINE SCREW(PH)3X8 ZN-PLAT
32	R29 - 893-675	CUSHION SPO.BLK T2 STIC.
33	R29 - 422-907-0	CONNECTOR ANT SO-239 "M" TYPE
34	R29 - 613-755	(+)MACHINE SCREW(PH)3X7 NI-PLAT
35		P.C.B RF MAIN 164.4X147X1.6T FR4 1/1
36		SPONGE RUBBER SPO.T2 STIC.
37	R29 - 406-973-A	P.C.B SQ SUB 19X25X1.2T FR4 1/1
38		CUSHION 10X20XT8 RUBB.SPO.STIC.
39		CUSHION 10X20XT8 RUBB.SPO.STIC.
40		PANEL BOTTOM ALDC12 IRIDITE FINISH
41	R29 - 723-400-D	BRACKET (DC CORD)
42	R29 - 750-233	CORD STOPPER SR-6W-1
43	R29 - 613-314	(+)MACHINE SCREW(BH)3X8 BLK
44		(+)MACHINE SCREW(PH)3X24 ZN-PLAT 1

MONOGRAM SERIES LBI-38864B

EXPLODED VIEW PARTS LIST

EXPLODED VIEW PARTS LIST		
REF. NO	PART NO	DESCRIPTION
45	R29 - 613-192	(+)MACHINE SCREW(FH)3X6 BLK
46		FELT 10X130XT0.5 FELT STIC.
47		FCC LABEL MADE IN KOREA
47		FCC LABEL MADE IN THAILAND
47		POLY LABEL COVER FOR FCC LABEL
48	R29 - 717-315-C	COVER BOTTOM EGI T1 BLK ST.SPRAY
49	R29 - 717-320-C	COVER TOP EGI T1 BLK ST.SPRAY
50	R29 - 894-185	CUSHION 16X20XT4 RUBB.SPO.STIC.
51		BRACKET ALDC12 SANDTONE SPRAY
52	R29 - 625-007	(+)TAPPING SCREW(TH)5X12-1S ZN-PLAT
53	R29 - 661-605	WASHER(FLAT) M6 ZN-PLAT
54	R29 - 662-606	WASHER(SPRING) M6 ZN-PLAT
55	R29 - 600-051	SECURING SCREW M6X9(P:1) BLK
56		TRANSISTOR MRF-1946
57		SHIELD PLATE PBSP 2X7XT0.2 (LOCATED IN SOLDER)
58	R29 - 508-085-A	BRACKET (MICROPHONE)
59		(+)MACHINE SCREW(BH)3X4 NI-PLAT
60	R29 - 662-310	WASHER (SPRING) M3 NI-PLAT
61		MICROPHONE JACK
62	R29 - 664-305	WASHER (LOCK "A"TYPE)M3 ZN-PLAT 1
63	R29 - 662-305	WASHER (SPRING) M3 ZN-PLAT 2
64		P.C.B PLL B'D FILTER30X11X1.6T FR4 1/1
65		P.C.B RF B'D FILTER 23X15X1.6T FR4 1/1
66	R29 - 504-367	PLUG ASS'Y W/CABLE TMP-P01X-A1 85M/M
67-68		NO LONGER USED
69		POWER CORD WITH INLINE FUSE

MONOGRAM SERIES LBI-38864B

MGM-148 / MGM-160 EXPLODED VIEW

MGM-148 / MGM-160 EXPLODED VIEW

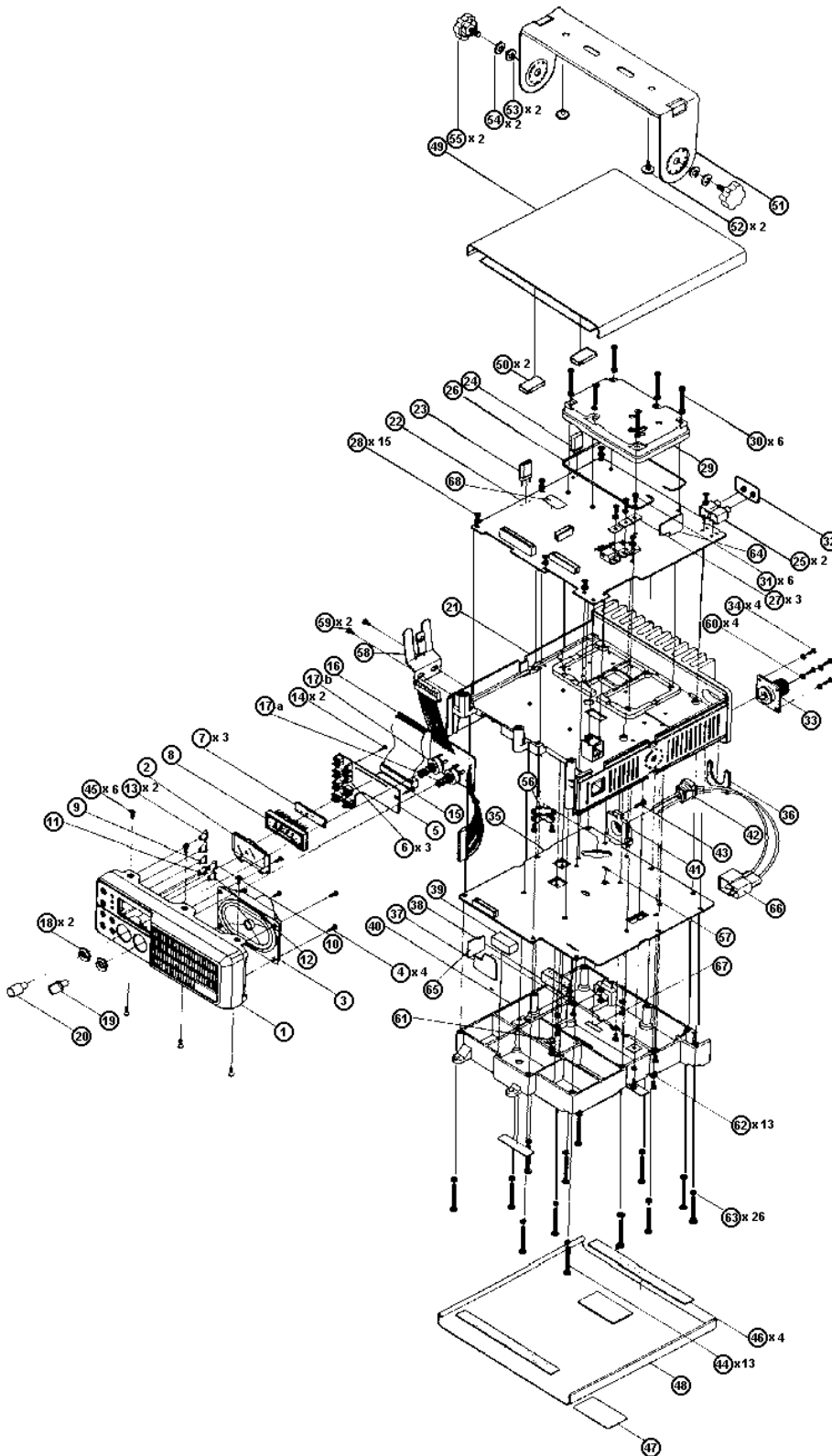

SCHEMATICS

Ericsson Inc.
Private Radio Systems
Mountain View Road
Lynchburg, Virginia 24502
1-800-528-7711 (Outside USA, 804-528-7711)

Printed in U.S.A.

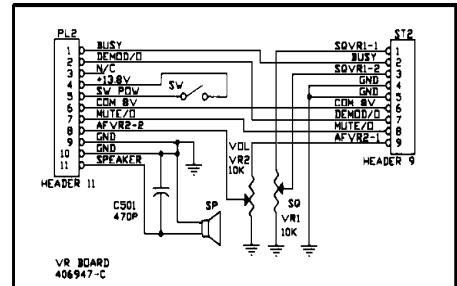
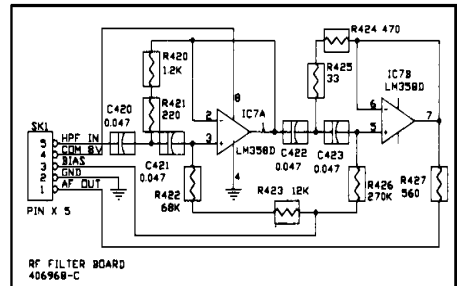
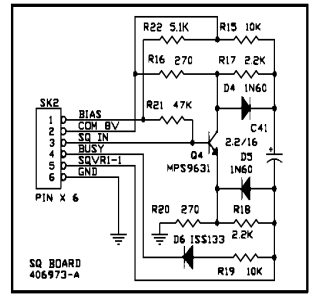
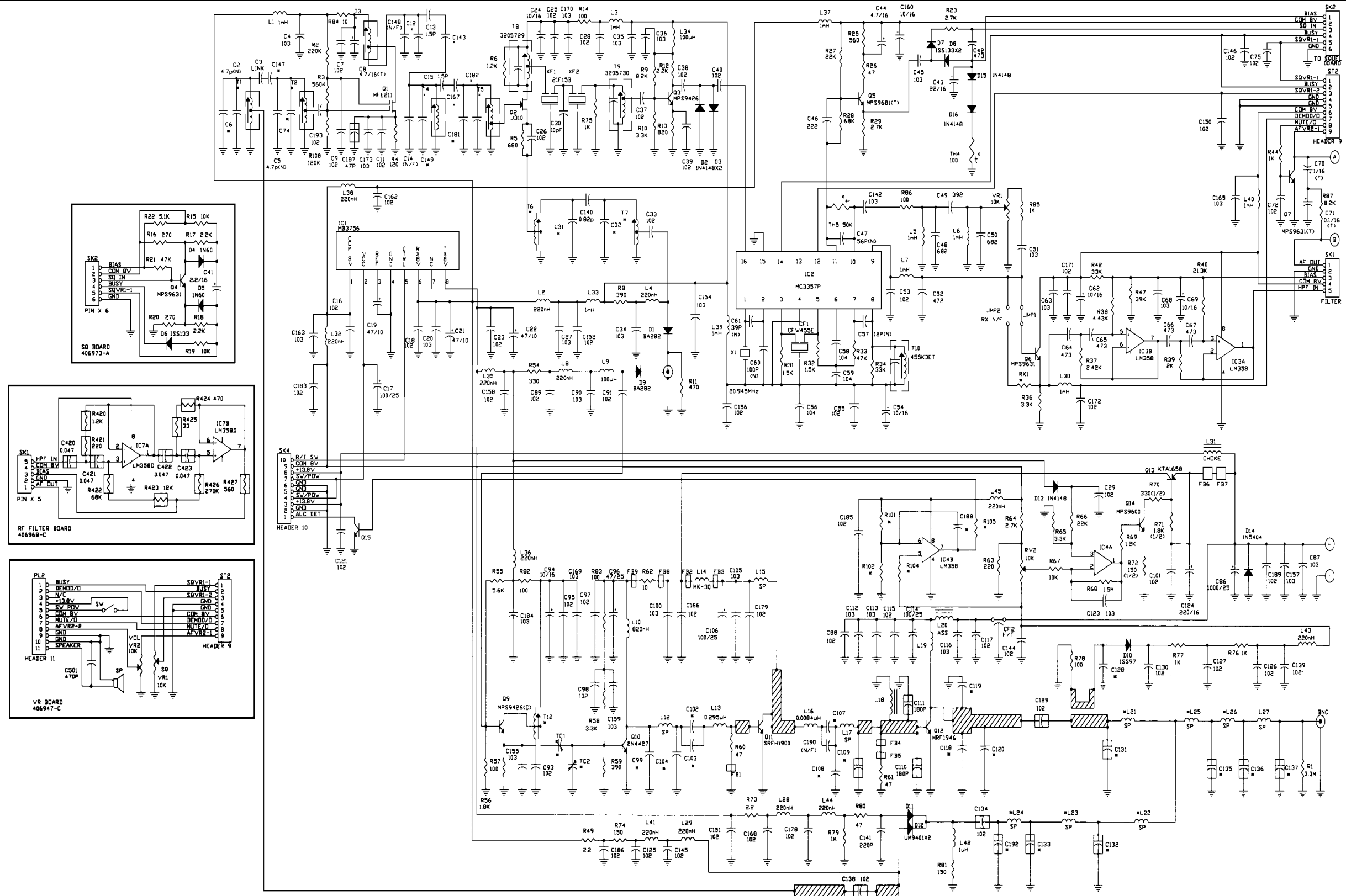

BAND CHANGE LIST

BAND	REF NO	T4	L21	L22,24	L23	L25	L26	TCL2	C6	C12	C12	C31	C32	C74	C99	C102	C103	C104	C107	C108	C109	C118	C119	C120	C128	C131	C132	C133	C135	C136	C137	C143	C147	C149	C167	C181	C182	C192
136-150	3101894	3105001	3105023	3104994	3105034	3105012	20pF	3.3pF	4.7pF	2.2pF	2.2pF	150pF	100pF	N/F	80pF	2.7pF	2.2pF	180pF	75pF	75pF	56pF	12pF	18pF	18pF	30pF	33pF	18pF	1.2pF	0.82pF	4.7pF	1.2pF	4.7pF	2.2pF	N/F				
148-165	3101894	3101739	3103854	3101784	3101740	3103865	10pF	1pF	3.9pF	0.2pF	1pF	150pF	80pF	10pF	56pF	2.7pF	2.7pF	180pF	60pF	60pF	47pF	10pF	15pF	10pF	22pF	22pF	15pF	0.48pF	0.56pF	3.3pF	0.48pF	3.9pF	1.8pF	15pF	N/F			
160-175	3102956	3101739	3103854	3101784	3101740	3103865	10pF	N/F	2.7pF	6.8pF	N/F	10pF	6.8pF	N/F	56pF	2.2pF	2.2pF	75pF	60pF	100pF	47pF	6.8pF	15pF	10pF	18pF	18pF	15pF	0.48pF	0.56pF	3.4pF	0.48pF	3.9pF	N/F	10pF	N/F			

**RF BOARD
R29/406039-E**

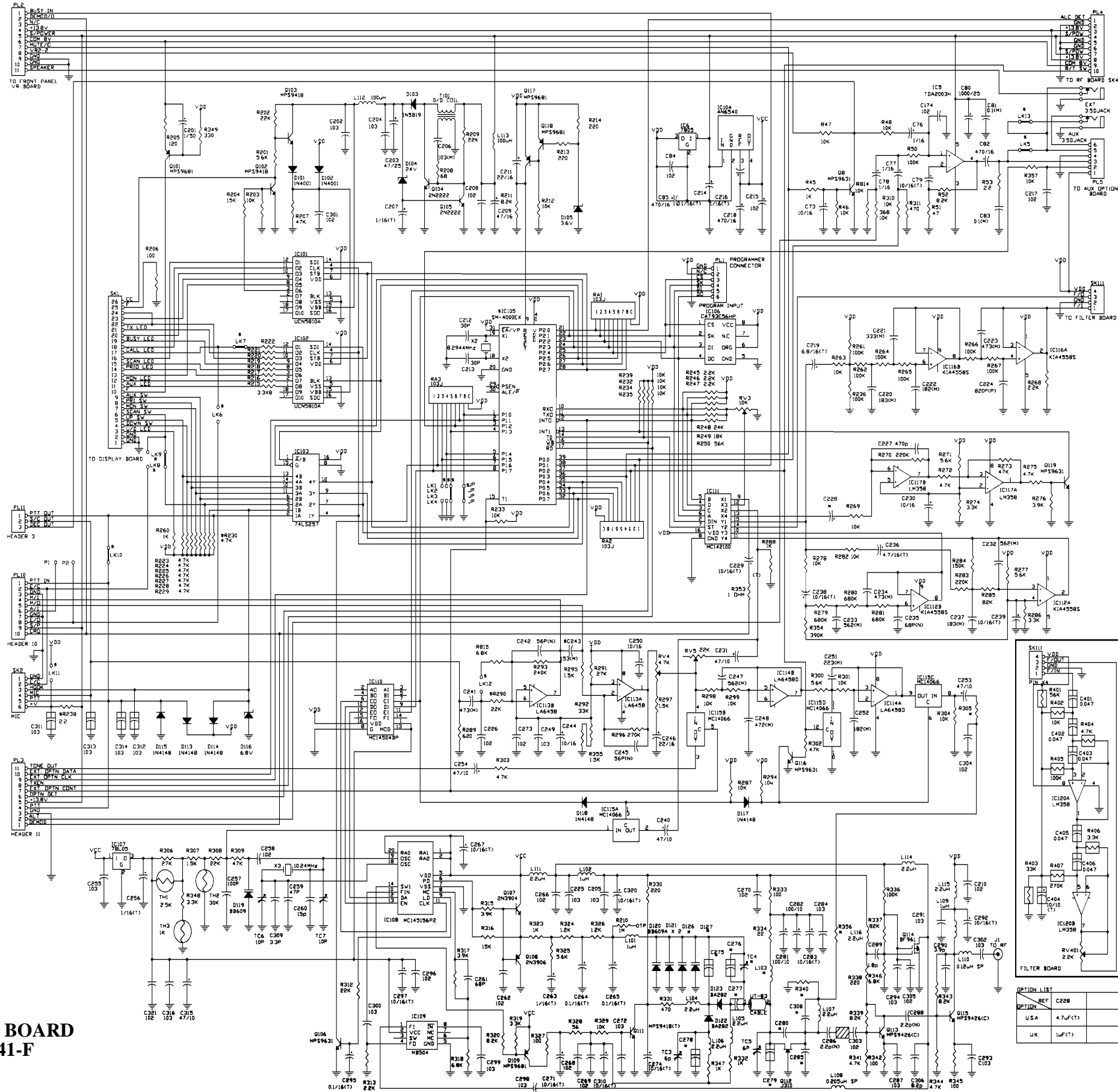

BAND CHANGE LIST

REF. NO.	R305	R340	L103	C875	C877	C876	C878	C879	C880	C885	TC4	D126	C308	D127
LOW BAND	5.6K	68	1uH	330P	0.01uF	51P	6P	6P	18P	27P	6P	BB609A	7P	BB609A
MID BAND	5.6K	100	6.8uH	180P	0.001uF	36P	6P	2P	15P	22P	6P	BB609A	7P	
HIGH BAND	5.6K	68	6.8uH	75P	0.001uF	33P	N/F	N/F	15P	18P	N/F	N/F		18P

SIGNALING OPTIONS (S)

OPTION	LK1	J3	J8	J1	LK5	LK6	LK7	LK8	LK9	LK10	LK11	LK12	LK13	RE28	RE30	RE90	RE91	IC105	IC106
NORMAL	N/F	N/F	FIT	FIT	FIT	N/F	FIT	N/F	FIT	FIT	N/F	FIT	FIT	FIT	FIT	FIT	FIT	FIT	93C46
CALL26/CALL27	N/F	N/F	FIT	FIT	FIT	N/F	FIT	N/F	FIT	FIT	FIT	FIT	FIT	N/F	N/F	N/F	N/F	N/F	93C66
CALL28	N/F	N/F	FIT	FIT	FIT	FIT	N/F	N/F	N/F	N/F	N/F	FIT	FIT	FIT	FIT	FIT	FIT	FIT	93C46

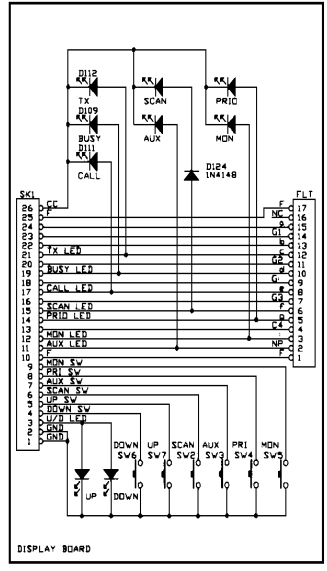
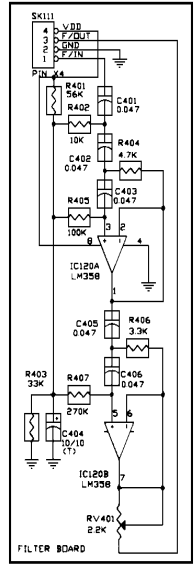

**DIGITAL BOARD
R29/406041-F**