

# RF-3200

HF-SSB TRANSCEIVER

USER'S GUIDE

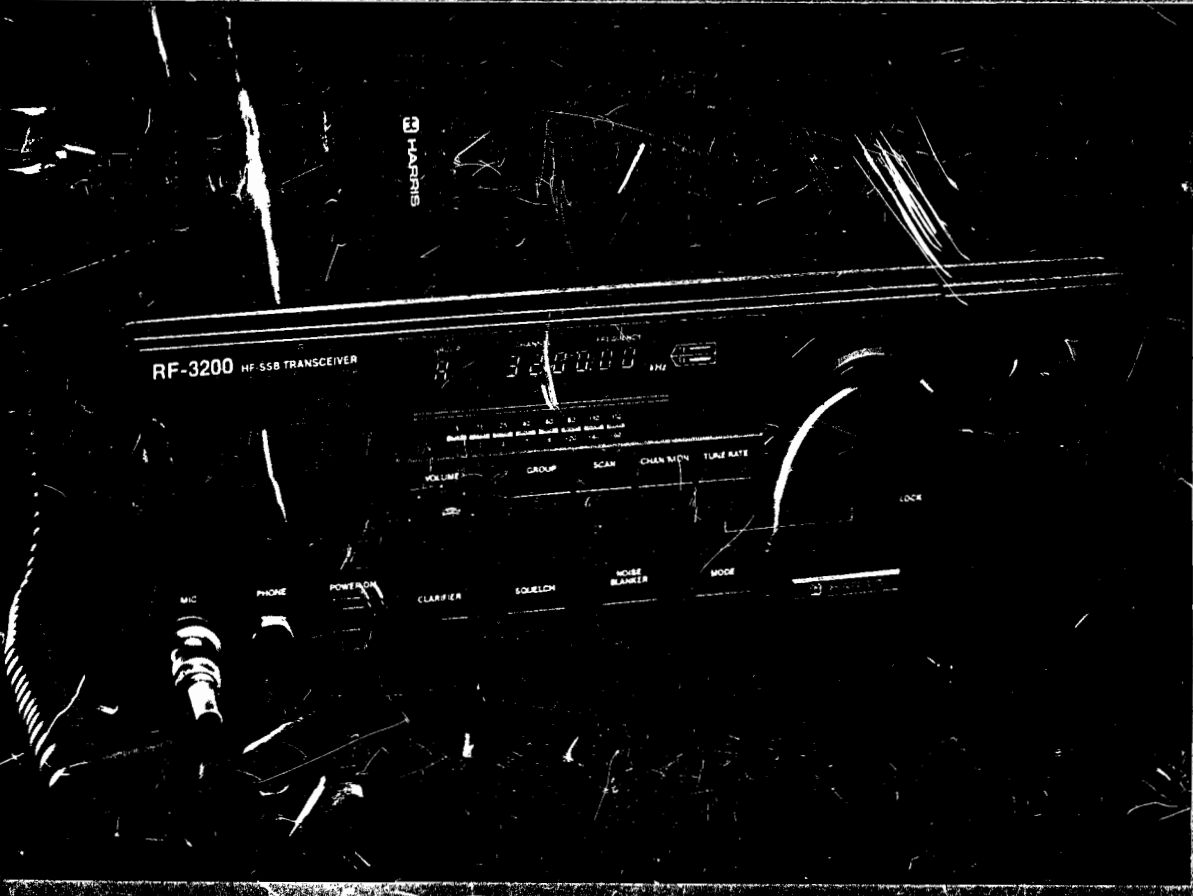

**Installation and Operation Instructions**





**HARRIS**

**LIMITED ONE YEAR WARRANTY  
HARRIS CORPORATION, RF Communications Group**

**FROM HARRIS TO YOU**—This warranty is extended to the original buyer and applies to all Harris Corporation, RF Communications Group equipment purchased and employed for the service normally intended, except those products specifically excluded.

**WHAT WE WILL DO**—If your Harris Corporation, RF Communications Group equipment purchased from us for use outside the United States fails in normal use because of a defect in workmanship or materials within one year from the date of shipment, we will repair or replace (at our option) the equipment or part without charge to you, at our factory. If the product was purchased for use in the United States, we will repair or replace (at our option) the equipment or part without charge to you at our Authorized Repair Center or factory.

**WHAT YOU MUST DO**—You must notify us promptly of a defect within one year from date of shipment. Assume that Harris concurs that the complaint is valid, and is unable to correct the problem without having the equipment shipped to Harris:

- Customers with equipment purchased for use outside the United States will be supplied with information for the return of the defective equipment or part to our factory in Rochester, NY, U.S.A., for repair or replacement. You must prepay all transportation, insurance, duty and customs charges. We will pay for return to you of the repaired/replaced equipment or part, C.I.F. destination; you must pay any duty, taxes or customs charges.
- Customers with equipment purchased for use in the United States must obtain a Return Authorization Number, properly pack, insure, prepay the shipping charges and ship the defective equipment or part to our factory address listed below, or to the Authorized Repair Center indicated by us.

**HARRIS CORPORATION**, RF Communications Group, Customer Service, 1680 University Avenue, Rochester, NY 14610, U.S.A., Telephone: (716) 244-5830, Telex: 240313, Cable: RFCOM UR

Harris will repair or replace the defective equipment or part and pay for its return to you, provided the repair or replacement is due to a cause covered by this warranty.

**WHAT IS NOT COVERED**—We regret that we cannot be responsible for:

- Defects or failures caused by buyer or user abuse or misuse.
- Defects or failures caused by unauthorized attempts to repair or alter the equipment in any way.
- Consequential damages incurred by a buyer or user from any cause whatsoever, including, but not limited to transportation, non-Harris repair or service costs, downtime costs, costs for substituting equipment or loss of anticipated profits or revenue.
- The performance of the equipment when used in combination with equipment not purchased from Harris.
- **HARRIS MAKES NO OTHER WARRANTIES BEYOND THE EXPRESS WARRANTY AS CONTAINED HEREIN. ALL EXPRESS OR IMPLIED WARRANTIES OF FITNESS FOR A PARTICULAR PURPOSE OR MERCHANTABILITY ARE EXCLUDED.**

**SERVICE WARRANTY**—Any repair performed by Harris under this limited warranty is warranted to be free from defects in material or workmanship for sixty days from date of repair. All terms and exclusions of this limited warranty apply to the service warranty.

**IMPORTANT**—Customers who purchased equipment for use in the United States must obtain a Return Authorization Number before shipping the defective equipment to us. Failure to obtain a Return Authorization Number before shipment may result in a delay in the repair/replacement and return of your equipment.

**IF YOU HAVE ANY QUESTIONS**—Concerning this warranty or equipment sales or services, please contact our Customer Service Department.

# ADDENDUM

<b>ADDENDUM NO:</b> L794	<b>APPLIES TO (RF Model or Product Name):</b> RF-3200 User's Guide	<b>DATE:</b> April 1992
<b>ADDENDUM TO (Publication Number/Revision):</b> 10212-0050D	<b>FOR (Specific Application):</b> All Manuals	

Programming for the RF-3200 has been made easier by the addition of a new feature. This new feature includes the capability to scroll through the various parameters when configuring the radio. Since this addition is only a software change, a simple pen-and-ink change is required to add the feature to your manual.

Make the following pen-and-ink change to the manual, and insert this addendum inside the front cover.

## PROGRAMMING AND CONFIGURATION SECTION

- Page 3-13, step 3 - at the end of the sentence, add "or use the tuning knob to scroll through the selections."
- Add the following note at the bottom of the page:

### NOTE

The direction of scrolling may differ among some versions of the software.

SHEET 1 OF 1



# RF-3200 EQUIPMENT EVALUATION FORM

## HARRIS RF-3200 HF-SSB Transceiver

Product Serial No.: \_\_\_\_\_

Date Purchased: \_\_\_\_\_

Purchased From: \_\_\_\_\_

HARRIS CORPORATION - RF Communications Group, and our engineering staff are continually striving to improve product design and performance to better fulfill our customer's needs.

NAME	DATE
COMPANY/ORGANIZATION	
ADDRESS	
CITY	STATE
ZIP	COUNTRY
PHONE NO. (PLEASE INCLUDE AREA CODE)	

You can assist in this process by completing, and returning this postage paid form:

GENERAL COMMENTS:	EXCELLENT	GOOD	FAIR	POOR
<b>RADIO/SYSTEM PERFORMANCE</b> <i>Please Comment -</i>	<input type="checkbox"/>	<input type="checkbox"/>	<input type="checkbox"/>	<input type="checkbox"/>

<b>FEATURES:</b> <i>Please Comment -</i>	<input type="checkbox"/>	<input type="checkbox"/>	<input type="checkbox"/>	<input type="checkbox"/>
---	--------------------------	--------------------------	--------------------------	--------------------------

<b>EASE-OF-USE</b> <i>Please Comment -</i>	<input type="checkbox"/>	<input type="checkbox"/>	<input type="checkbox"/>	<input type="checkbox"/>
---	--------------------------	--------------------------	--------------------------	--------------------------

<b>ANTENNA COUPLER PERFORMANCE</b> <i>Please Comment -</i>	<input type="checkbox"/>	<input type="checkbox"/>	<input type="checkbox"/>	<input type="checkbox"/>
---	--------------------------	--------------------------	--------------------------	--------------------------

<b>TACTICAL PACKAGING</b> <i>Please Comment -</i>	<input type="checkbox"/>	<input type="checkbox"/>	<input type="checkbox"/>	<input type="checkbox"/>
--	--------------------------	--------------------------	--------------------------	--------------------------

<b>COST VALUE</b> <i>Please Comment -</i>	<input type="checkbox"/>	<input type="checkbox"/>	<input type="checkbox"/>	<input type="checkbox"/>
--	--------------------------	--------------------------	--------------------------	--------------------------

Are there any additional features/equipment modifications you would like see incorporated into the RF-3200 HF-SSB Transceiver?

TEAR HERE

TEAR HERE

TEAR HERE

NOTE: U.S. POSTAL REGULATIONS NO LONGER PERMIT THE USE OF STAPLES. PLEASE SEAL THIS FORM WITH TAPE.

▲ TEAR HERE ▲

▼ FOLD HERE ▼

▲ TEAR HERE ▲

▲ TEAR HERE ▲



NO POSTAGE  
NECESSARY  
IF MAILED  
IN THE  
UNITED STATES

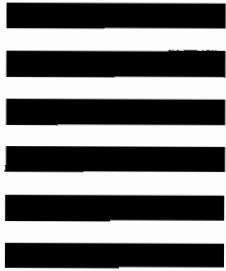

**BUSINESS REPLY MAIL**  
FIRST-CLASS MAIL PERMIT NO. 4033 ROCHESTER, N.Y.

POSTAGE WILL BE PAID BY ADDRESSEE

**HARRIS CORPORATION**  
**RF Communications Group**  
Attn: George Helm  
1680 University Avenue  
Rochester, New York 14610-9983



▲ PLEASE FOLD HERE ▲, AND SEAL WITH TAPE.

▲ TEAR HERE ▼

**Please record the serial number and date purchased before reading the remainder of this manual.**

Date purchased: \_\_\_\_\_

Serial number: \_\_\_\_\_

At this time you may also want to record your password.

Note: If other users of this manual are not allowed to program the radio either: do not record your passwords in this book; or remove this page and store it in a safe location after recording your passwords.

\_\_\_\_\_  
\_\_\_\_\_

▲ TEAR HERE ▼

▲ TEAR HERE ▼



**NOTES:**

A large rectangular box with a thin black border, intended for handwritten notes. The interior of the box is currently blank.

Handwritten text along the right edge of the page, possibly a page number or reference code, including the number '11'.



**GENERAL INFORMATION /AND INSTALLATION:**

Options ..... 1-2  
 RF-3200 Transceiver Dimensions ..... 1-3  
 RF-3281 Antenna Coupler Dimensions ..... 1-3  
 Required Tools ..... 1-4  
 Items Supplied for Installation ..... 1-4  
 Installation Pointers ..... 1-4  
 Installation Precautions ..... 1-4  
 Mounting The Radio ..... 1-5  
 RF-3236 Power Supply Dimensions ..... 1-7  
 Connecting The Radio ..... 1-8  
 DC Power Cable Preparation ..... 1-8  
 Antenna Coupler Installation ..... 1-11  
 Safety Precautions ..... 1-14

**OPERATION:**

Tones Generated by the Radio ..... 2-1  
 CW Operation ..... 2-1  
 Transmit Power with RF-3281 ..... 2-1A  
 Front Panel Diagrams and Explanations ..... 2-2  
 Full Frequency (Group F) Operation Overview ..... 2-4  
 Channel Operation (Group 1 to 9 or A) Overview ..... 2-4  
 Using Pre-Programmed Channels ..... 2-6  
 Using Full Frequency Tuning (Group F) In Simplex Operation ..... 2-8  
 Using Full Frequency Tuning (Group F) in Half-Duplex Operation ..... 2-10  
 RF-3281 Antenna Coupler General Information ..... 2-12  
 Channel Scan Operation ..... 2-14  
 Entering Channel Scan Operation ..... 2-14  
 Types of Scan Operation ..... 2-14  
 Exiting Scan Operation ..... 2-15

**PROGRAMMING & CONFIGURATION:**

Programming Channel and Group Overview ..... 3-1  
 Programming Simplex Channels ..... 3-2  
 Programming Half-Duplex Channels ..... 3-4  
 To Store Channels from Group A into Groups 1 to 9 ..... 3-7  
 To Delete Channels from Groups 1 to 9 ..... 3-9  
 Configuring The Radio ..... 3-10  
 Option Configuration Items ..... 3-11  
 Configuration Parameters ..... 3-12  
 To Change Configuration Parameter Values ..... 3-13

**DISPLAY MESSAGES:**

Error Messages ..... 4-1  
 Normal Operating Messages ..... 4-2  
 Antenna Coupler Status Messages ..... 4-3

**CARE & TROUBLESHOOTING:**

Preventive Maintenance Tips ..... 5-1  
 Troubleshooting Table ..... 5-2  
 RF-3200 System Block Diagram ..... 5-3

## TABLE OF CONTENTS

### REFERENCE INFORMATION:

RF-3200 125 Watt HF-SSB Transceiver Specifications .....	6-1
RF-3281 Antenna coupler Specifications .....	6-3
Propagation and Antenna Considerations .....	6-4
Antenna System .....	6-5
Operating Frequency .....	6-5
Ground Plane .....	6-5
Time Of Day .....	6-5
Weather Conditions .....	6-5
Sunspot Cycle .....	6-6
Sudden Ionospheric Disturbances (SID) .....	6-6
Group A (Channels 0-120) User Programmed Channel Log .....	6-7
Group A Preprogrammed Channel Log .....	6-11
Group Channel Log .....	6-13
Glossary .....	6-17

### OPTIONS:

Options and Accessories Available .....	7-1
---	-----

## GENERAL INFORMATION & INSTALLATION

Carefully remove the transceiver and accessories from the shipping container and retain the carton for repacking if necessary. Inspect the items for damage and check the packing list to account for all equipment on the list. Immediately notify the shipping carrier if any items are damaged or missing.

GENERAL  
INFORMATION &  
INSTALLATION

## GENERAL INFORMATION AND INSTALLATION

Equipment manufactured by Harris Corporation, RF Communications Group meets stringent quality and safety standards. However, high voltages are present in many radio products, and only a skilled technician should attempt to remove outer covers and make adjustments or repairs. All personnel who operate and maintain the equipment should be familiar with this page as a safety preparedness measure. Although this procedure is reproduced as a service to the personnel involved with this equipment, Harris Corporation assumes no liability regarding any injuries incurred during the operation and repair of such equipment, or the administration of this suggested procedure.

### ELECTRICAL SHOCK: EMERGENCY PROCEDURE

The victim will appear unconscious and may not be breathing. If the victim is still in contact with the voltage source, disconnect the power source in a manner safe to you, or remove the victim from the source with an insulated aid (wooden pole or rope). Next, determine if the victim is breathing and has a pulse. If there is a pulse but no breathing, administer artificial respiration. If there is no pulse and no breathing, perform CPR (if you have been trained to do so). If you have not been trained to perform CPR, administer artificial respiration anyway. Never give fluids to an unconscious person.

### WHEN BREATHING STOPS



**FIRST**, send someone to get a **DOCTOR**.

**THEN**, administer first aid to restore breathing (artificial respiration):

**1 IF A VICTIM APPEARS TO BE UNCONSCIOUS**  
TAP VICTIM ON THE SHOULDER AND SHOUT, "ARE YOU OKAY?"



**2 IF THERE IS NO RESPONSE**

**TILT THE VICTIM'S HEAD, CHIN POINTING UP.** Place one hand under the victim's neck and gently lift. At the same time, push with the other hand on the victim's forehead. This will move the tongue away from the back of the throat to open the airway.

**IMMEDIATELY LOOK, LISTEN, AND FEEL FOR AIR.**

While maintaining the backward head tilt position, place your cheek and ear close to the victim's mouth and nose. Look for the chest to rise and fall while you listen and feel for the return of air. Check for about five seconds.



**3 IF THE VICTIM IS NOT BREATHING**

**GIVE FOUR QUICK BREATHS.**

Maintain the backward head tilt, pinch the victim's nose with the hand that is on the victim's forehead to prevent leakage of air, open your mouth wide, take a deep breath, seal your mouth around the victim's mouth, and blow into the victim's mouth with four quick but full breaths just as fast as you can. When blowing, use only enough time between breaths to lift your head slightly for better inhalation.

If you do not get an air exchange when you blow, it may help to reposition the head and try again.

**AGAIN, LOOK, LISTEN, AND FEEL FOR AIR EXCHANGE.**



**4 IF THERE IS STILL NO BREATHING**

**CHANGE RATE TO ONE BREATH EVERY FIVE SECONDS.**

OPTIONS

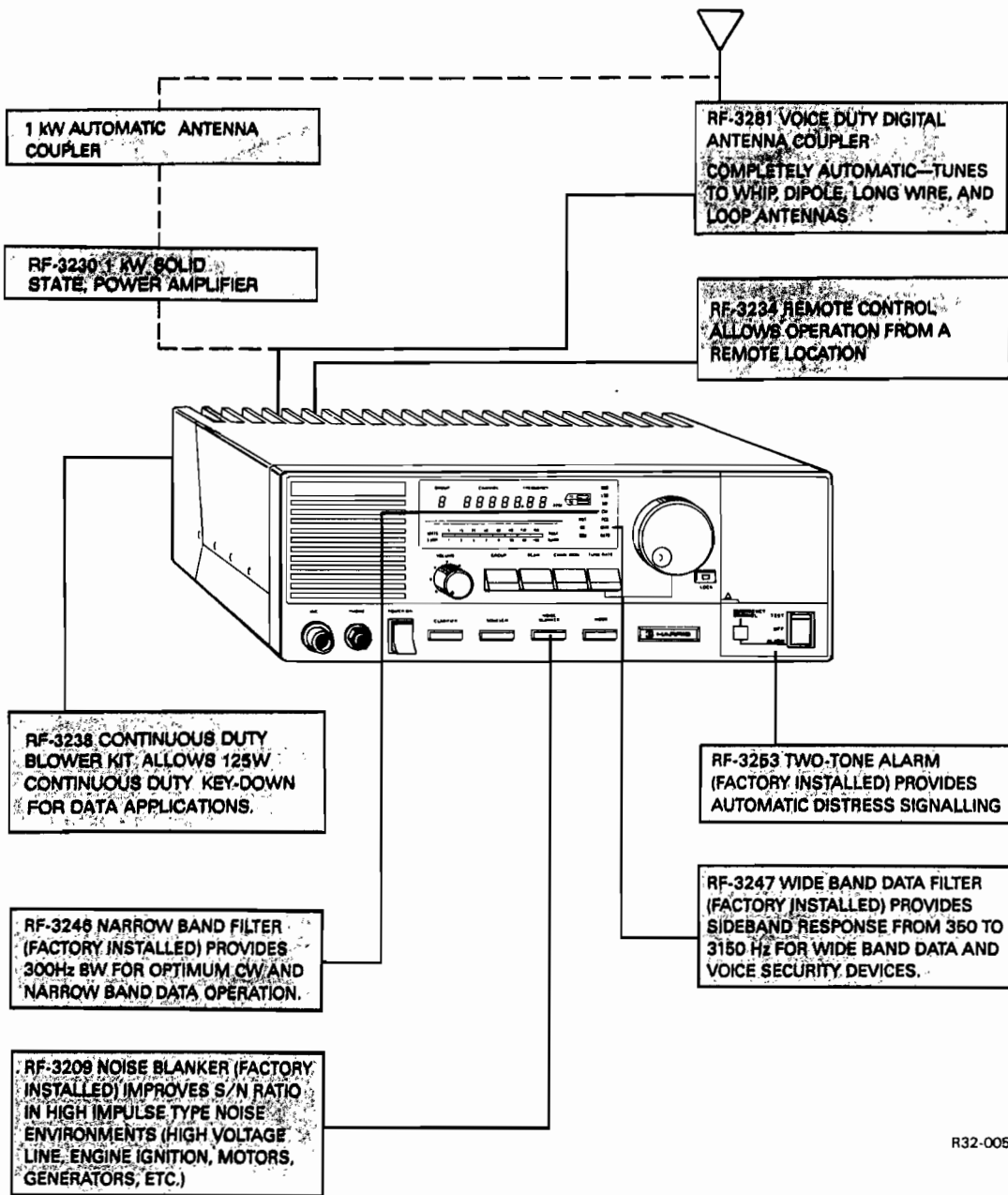

R32-005A

**NOTE:** See Options section for complete options and accessories available. Refer to order form at back of this User's Guide for options ordering information.

**GENERAL INFORMATION AND INSTALLATION**

**RF-3200 TRANSCEIVER DIMENSIONS**

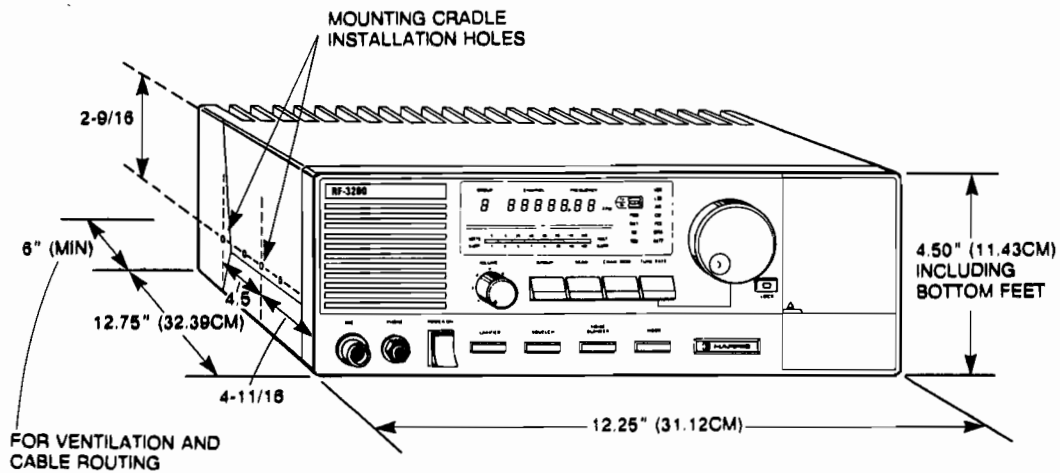

R32-007A

**RF-3281 ANTENNA COUPLER DIMENSIONS**

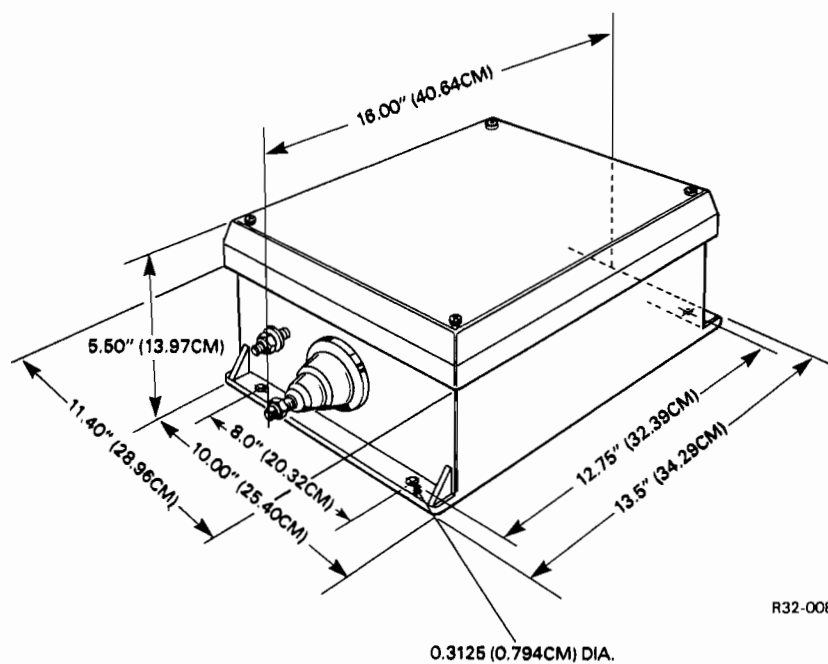

R32-008

**REQUIRED TOOLS**

- Mechanic's/Technician's standard tool set: standard and phillips screwdrivers; box and open-end wrenches; pliers; punches; hammer; soldering iron, tape measure.
- Power drill with bits (sizes 1/4" and 5/16" dia.)

**ITEMS SUPPLIED FOR INSTALLATION**

The following items are supplied with the RF-3200 radio:

- Ancillary Kit (P.N. 10212-0500)

Item	Part Number
Fuse, 8.0A, 125V, 3AG	F-0017
Connector, UHF, PL-259	J-0002
Connector Housing, 2-Pin	J40-0002-0002
Crimp Pins	J45-0011-003
Connector, 15-Pin, D	J22-0070-115
Connector Housing, 15-Pin	J22-0070-514

- Power Cable Kit (P.N. 10212-0600)
- Microphone Assembly (P.N. 10212-0200)
- Trunion Mount (P.N. 10212-0400)
- RF-3200 User's Guide

**NOTE:** An Ancillary Kit (P.N. 10228-0800) is also supplied with the RF-3281 Antenna Coupler (see Options section).

**INSTALLATION POINTERS**

The following factors should be considered when selecting the location of the RF-3200 Transceiver and associated components:

- Availability of power source, earth ground, antenna, etc.
- Ease of operation, maintenance, or removal and replacement.
- Ventilation (radio bottom ventilation slots and rear panel heat sink holes must be clear of obstructions).
- Clearance for connection of cables to the back of the radio.

**INSTALLATION PRECAUTIONS**

- Avoid installing in a location that receives direct sunlight. Select a dry ventilated location.
- Avoid direct surface contact with the radio's rear panel heat sink. Allow a minimum of 6" of space between rear heat sink and back surface for ventilation and cable routing.
- Avoid, if possible, installing the radio in a high impulse noise environment such as near high voltage lines, electronic ignitions, motors, generators, etc. The optional (RF-3209) Noise Blanker can improve reception in these environments (see Options section).
- When installing in a vehicle, avoid mounting the radio in front of the vehicle's heater air outlet.
- Avoid excessive vibration. Shock mounting is recommended in certain cases where a rigid mount would subject the radio to excessive shock or vibration (see Options section).
- DO NOT locate the antenna near trees, power lines, or large metal structures.
- Avoid installing interconnecting cables in high traffic areas.

### MOUNTING THE RADIO

The RF-3200 Transceiver can be mounted in one of several ways:

- Placed on a flat surface with or without the mounting cradle.
- Mounted underneath a flat surface using the mounting cradle.
- Shock mounted in high vibration and shock environments (see Options section).
- Rack mounted in a standard 19 inch equipment rack (see Options section).

### MOUNTING CRADLE INSTALLATION

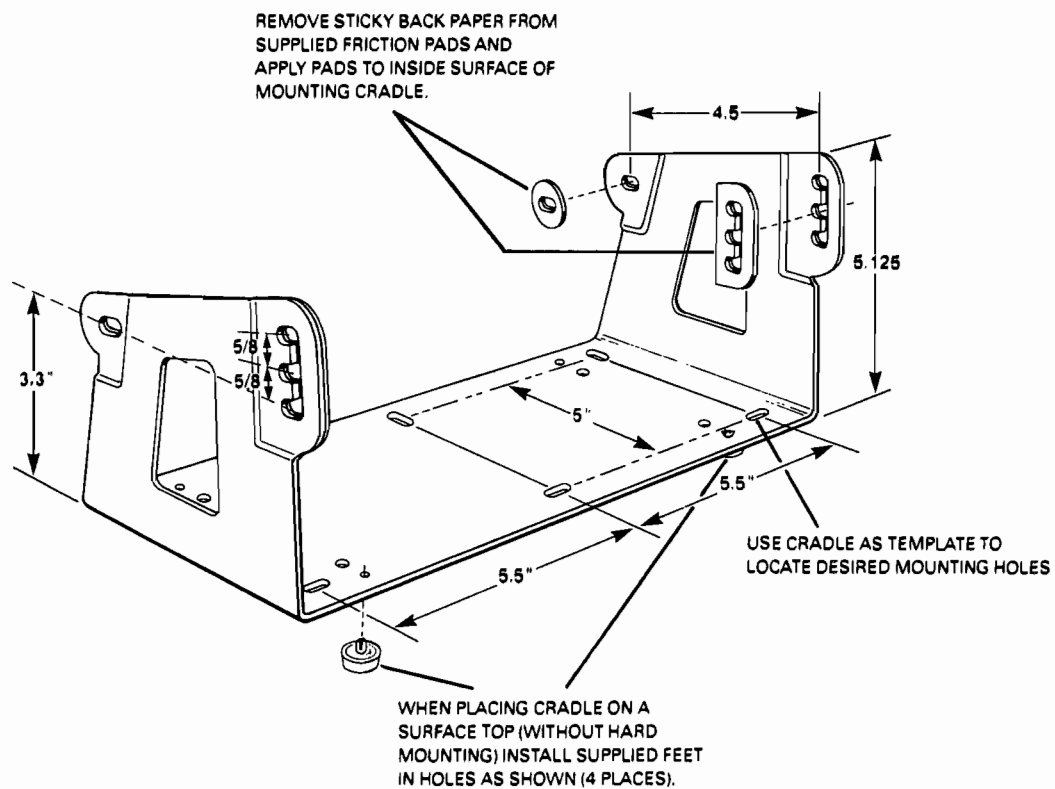



**SURFACE TOP MOUNTING**

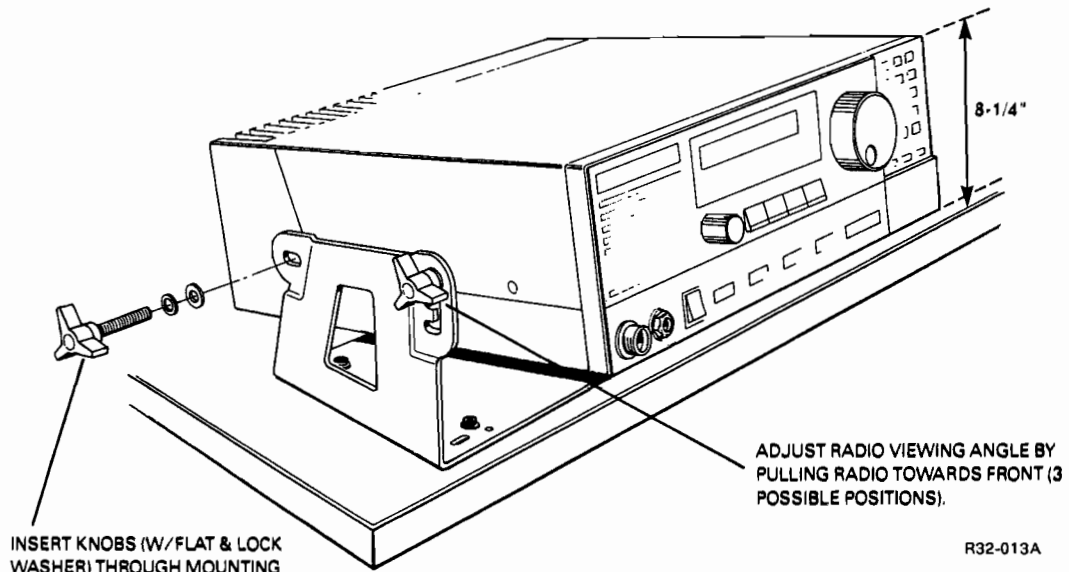

INSERT KNOBS (W/ FLAT & LOCK WASHER) THROUGH MOUNTING CRADLE AND SCREW INTO RADIO (4 PLACES).

ADJUST RADIO VIEWING ANGLE BY PULLING RADIO TOWARDS FRONT (3 POSSIBLE POSITIONS).

R32-013A

*NOTE: The radio can also be tilted downward for surface top mounting (or upward for under surface mounting) by positioning the mounting cradle with the adjusters toward the rear of the radio.*

**UNDER SURFACE MOUNTING**

CLEARANCE FOR VENTILATION & CABLES

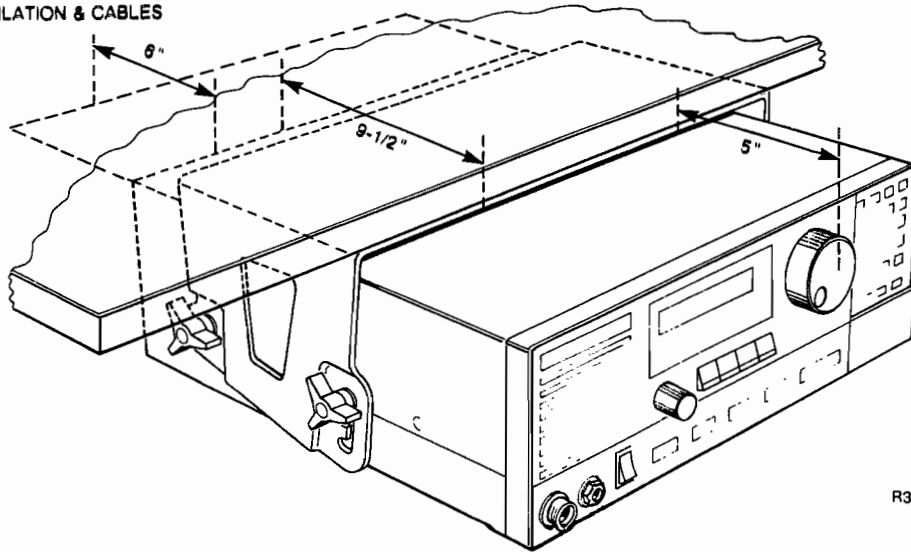

R32-014A

**GENERAL INFORMATION AND INSTALLATION**

**RF-3236 CONTINUOUS DUTY POWER SUPPLY**

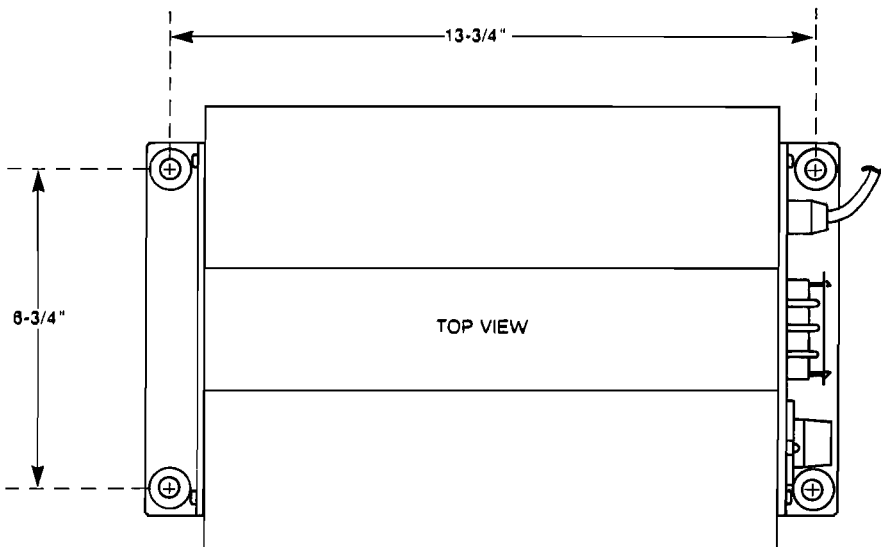
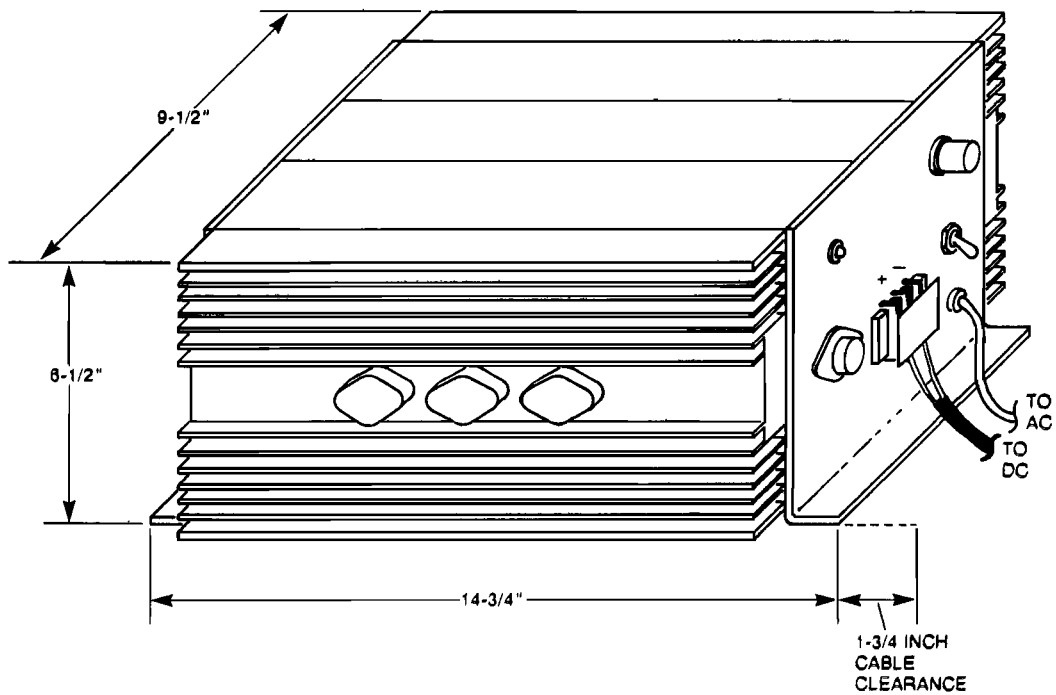

## CONNECTING THE RADIO

## Power Connection

The radio is supplied with a DC power cable kit used to connect the radio to the power source. Prepare the supplied power cable and connect it to the 13.6 VDC power source (insure power switch on the radio is off and the power source is turned off). The cable should be connected to the power source by the shortest possible route, and the in-line fuse must be located as close as possible to the main source.

## DC POWER CABLE PREPARATION

1. Cut supplied cable to desired length.
2. Cut and remove cable jacket  $\approx 18''$ .
3. Cut red wire 7'' from cable.
4. Slide rubber boot **C** onto cable.
5. Strip 7'' piece of red wire **A**  $\frac{3}{4}''$ . Do the same for the red wire on cable **B**.
6. Crimp fuse receptacle **E** (with locking nut **D** attached) onto cable.
7. Crimp mating fuse holder **F** onto stripped piece of red wire **A**.
8. Slide locking threads **G** onto mating fuse holder **F**.
9. Slide rubber washer **H** onto fuse receptacle **E**.
10. Insert 30A fuse **I** in receptacle **E**.
11. Connect fuse receptacle **E** to mating fuse holder **F**, and tighten locking nut **D**.
12. Slide rubber boots **C** and **J** over fuse holder so that only locking nut **D** and threads **G** are exposed.
13. Strip ends of both brown and red wires as required to connect to power source.

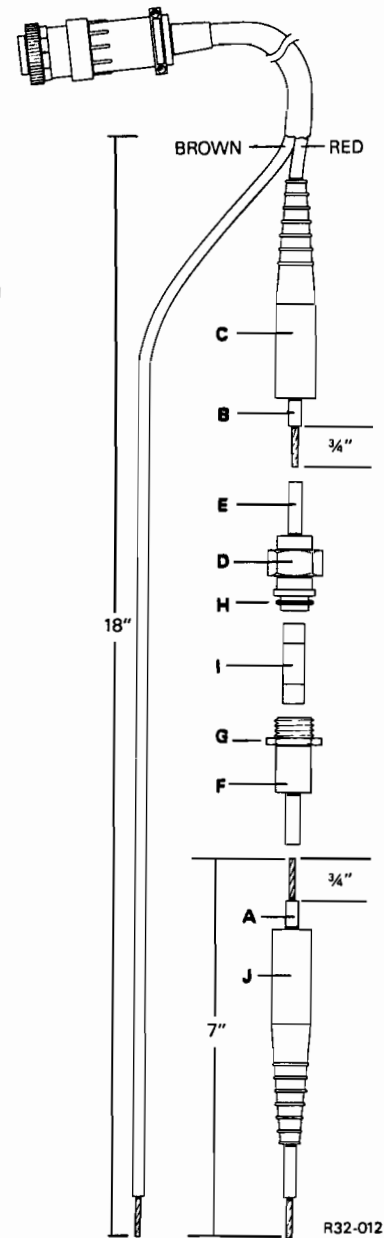

## FRONT PANEL CONNECTIONS

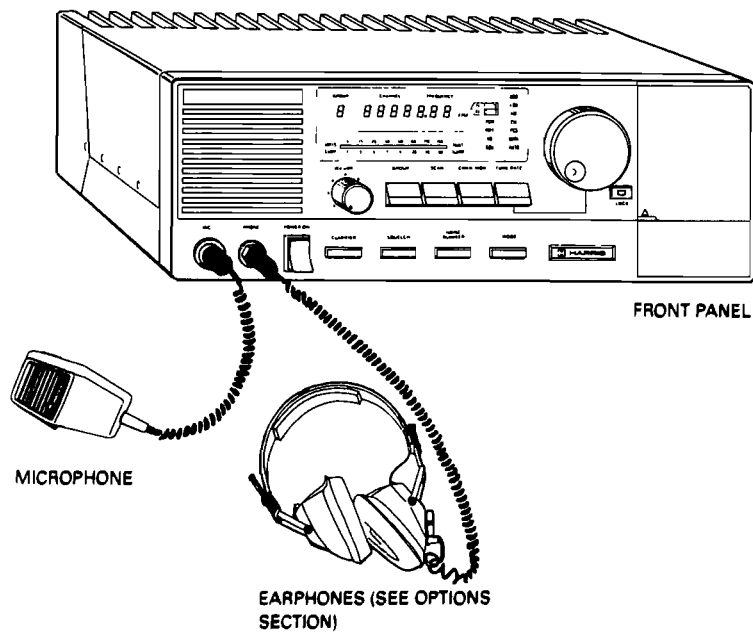

R32-010

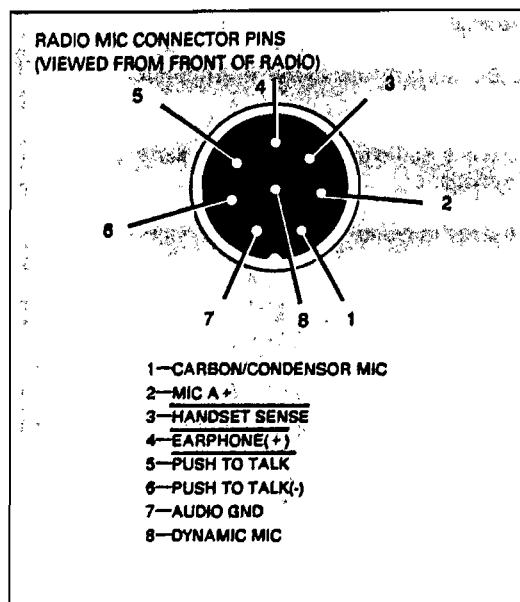

*NOTE: Refer to the technical service manual for more detailed information (see Options section).*

REAR PANEL CONNECTIONS

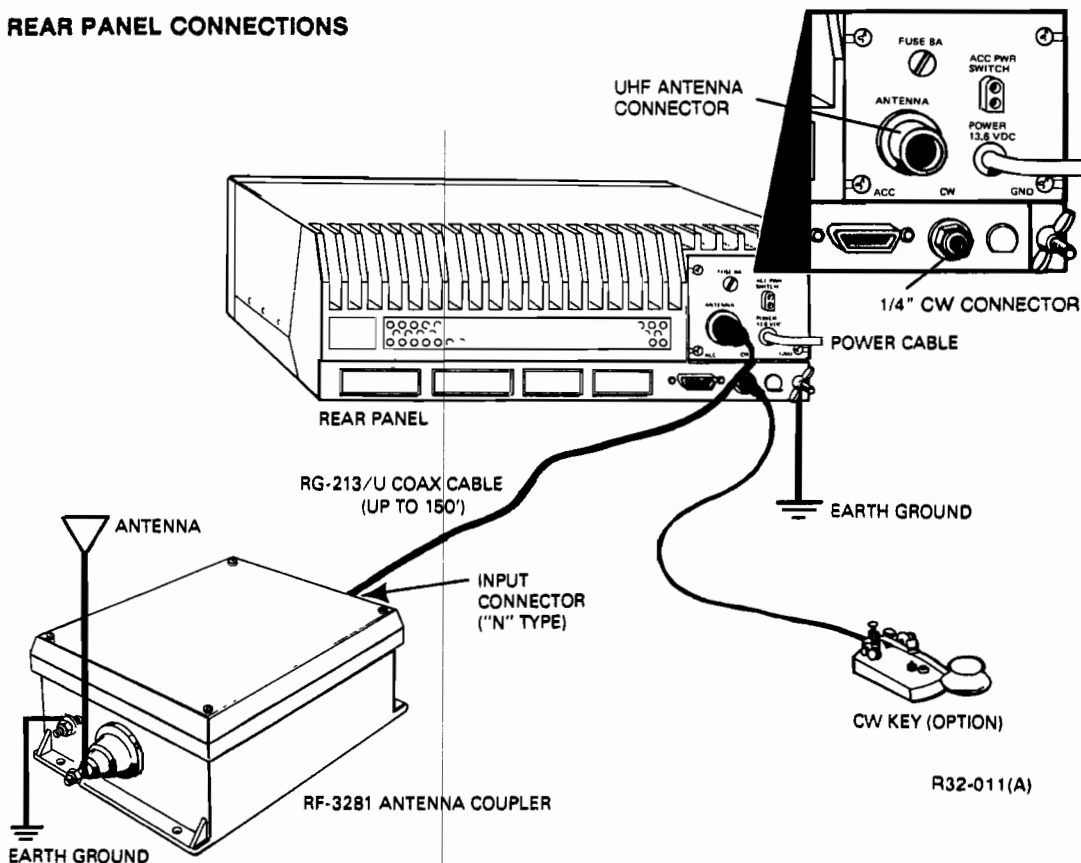

ACCESSORY CONNECTOR PINS (WHEN VIEWED FROM REAR OF RADIO)

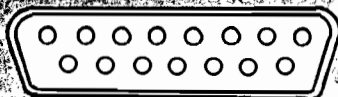

- 1—SPEAKER
- 2—SPEAKER
- 3—RX AUDIO OUT (600 Ω)
- 4—TX AUDIO IN (600 Ω)
- 5—KEY REQUEST
- 6—AUDIO GND
- 7—TX GAIN CONTROL
- 8—TR+ RELAY CONTACTS
- 9—TR- RELAY CONTACTS
- 10—REMOTE SWITCH (POWER SWITCH)
- 11—SWITCHED 13.6 VDC (FUSED MAX 800 MA)
- 12—RESERVED
- 13—LOGIC GND
- 14—RESERVED
- 15—RESERVED

POWER CONNECTOR PINS (WHEN VIEWED FROM REAR OF RADIO)

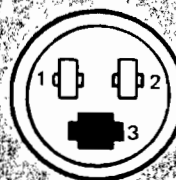

- 1—13.6 VDC
- 2—GROUND
- 3—NOT USED

ACCESSORY POWERSWITCH: PROVIDES CONTACT CLOSURE WHEN RADIO IS TURNED ON.



NOTE: MATING CONNECTOR AND PINS ARE SUPPLIED WITH THE RADIO.

NOTE: Refer to the technical service manual for more detailed information (see Options section).

**GENERAL INFORMATION AND INSTALLATION****Antenna Connection**

The radio is designed to operate into any antenna system with an impedance of 50 ohms. Connect a broadband antenna or a single frequency tuned antenna to the radio's rear panel antenna connector.

When using the RF-3281 antenna coupler, connection is made using a single coaxial cable. RG-213/U type coax is recommended for lengths greater than 25 feet.

**Ground Connection**

Grounding the radio to a good earth ground is important for preventing electric shock and for transmitting a high quality signal with minimum spurious radiation. The surest and safest earth ground is made by using a commercially available ground rod or copper plate under the ground and connecting it to the "GND" terminal at the radio back panel. **NEVER USE** a gas pipe or electrical conduit pipe for the earth ground connection. Use a heavy gauge aluminum ground wire to make the connection.

**ANTENNA COUPLER INSTALLATION (see note below)**

The RF-3281 Antenna Coupler is configured for long-wire/dipole operation when the unit is shipped from the factory. If the antenna coupler is to be used to match whip antennas, the long wire jumper must be removed.

To configure the unit for whip antennas, remove the coupler's cover by removing the four cover screws. Locate JMP4, on the board. Next, cut its leads, remove and discard the jumper. Replace the cover and secure with the four cover screws.

The RF-3281 Antenna Coupler, if used, can be mounted: on the ground; to a surface top; to a ship's bulkhead; to an antenna mast, or vehicle's frame using the holes located at the base of the unit as a template. Use appropriate hardware for 5/16" diameter holes when mounting the unit.

The coupler should be located as close as possible to the antenna, keeping the feedline to the antenna as short as possible. The ground system (connected to the coupler's ground terminal) should be as close as possible to the antenna coupler.

The wide copper ground strap (supplied with the antenna coupler) should be connected from the antenna coupler's ground terminal to the ground system (ground rod, ground plate, steel bulkhead, etc.) and should be as short as possible (preferably less than 10 inches). A good ground system connected to the antenna coupler is very important for effective antenna performance. The following recommendations should be followed to insure good performance:

- When mounting the coupler on the ground, a commercially available ground rod at least 6-8 feet long should be driven into the earth and connected to the coupler's ground terminal. At least sixteen 50 foot long ground radials should be clamped (mechanically & electrically) to the ground rod (especially for vertically polarized antennas) and spaced 4 to 5 feet apart and around the coupler's ground terminal. The radials should be laid on or just under the earth's surface. Radials should also be used for roof top installations.
- For shipboard installations, the coupler's ground terminal should be connected to either the ship's steel bulkhead or a special grounding system (for ships constructed with a non-conductive material). The grounding system, for a ship constructed of non-conductive material, can be accomplished by installing a copper or brass plate to the underside of the ship and then connecting it to a solid conductor (No. 12 AWG or larger) wire run the shortest possible distance to the transceiver, antenna coupler, and antenna.
- For vehicular installations, the coupler's ground terminal should be connected to the vehicle's metal frame.

**WARNING**

Inadequate or defective grounding at the radio or antenna coupler can present dangerous RF voltages on the equipment grounds.

**NOTE:** Refer to the RF-3281 Antenna Coupler Service Manual for further information. This Service Manual includes proper installation procedures for the antenna coupler option board.

**TYPICAL ANTENNA COUPLER INSTALLATIONS**

(Contact a Harris representative for information on the specific antenna to meet your application needs. Also, see order form in back of this User's Guide).

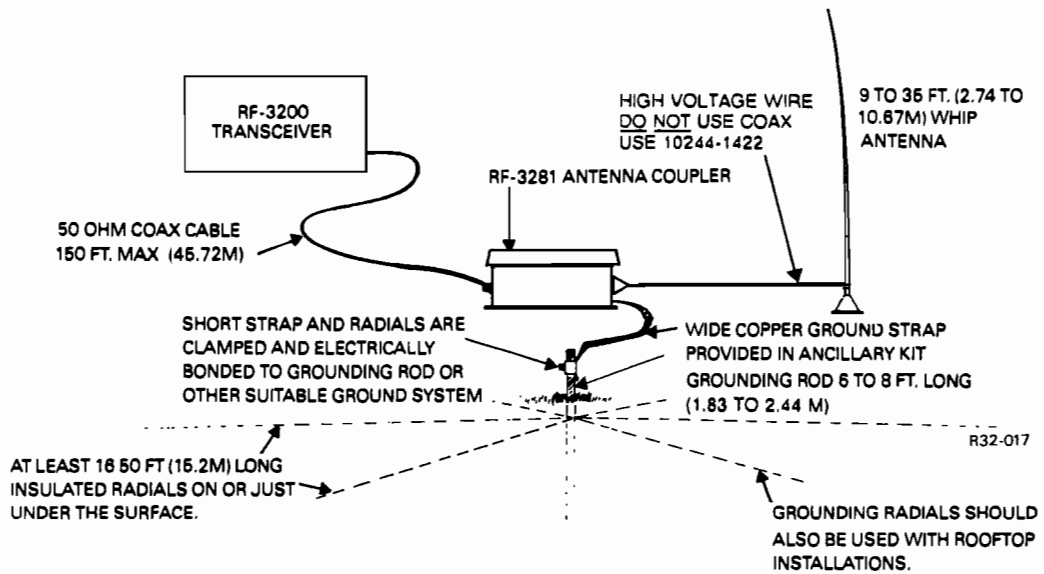
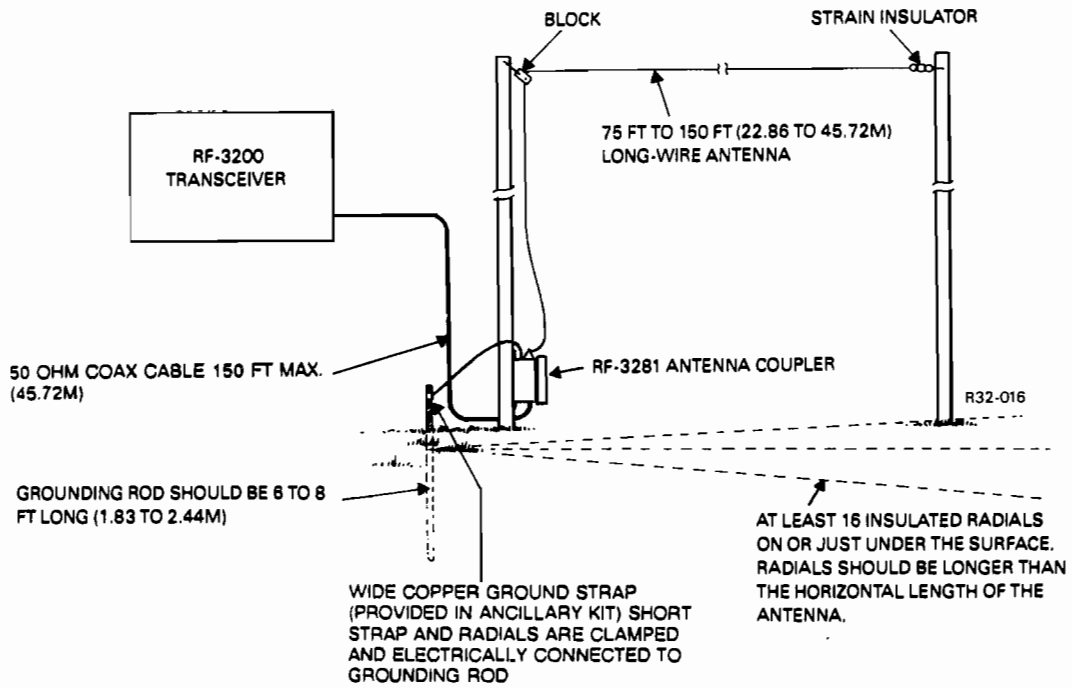

## GENERAL INFORMATION AND INSTALLATION

## STEP

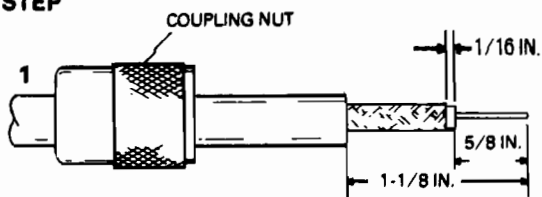
**PL-259 ("UHF") CONNECTOR ASSEMBLY**

(Connects to the Antenna Connector on the Radio)

Cut cable end square. Slide coupling nut on cable. Trim cable to dimensions shown. Tin braid and center conductor.

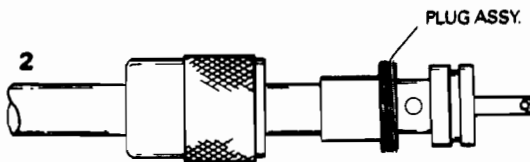

Screw plug assembly on cable. Solder braid through holes. To avoid deforming dielectric, use minimum heat required to produce good bond. Solder center conductor.



Complete assembly by screwing coupling nut over plug assembly. Check assembly by checking for shorts and continuity to other end of cable using ohmmeter.

## STEP

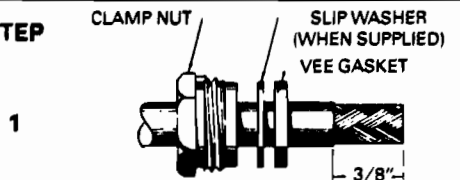
**UG-21D/U ("N") CONNECTOR ASSEMBLY**

(Connects to the Input Connector on the Coupler)

Cut cable end square, place clamp-nut, slip washer (when supplied), and gasket over jacket. Remove  $\frac{3}{8}$ " of vinyl jacket.



Place braid clamp over braid against jacket cut. Comb out copper braid as shown.



Fold braid back over braid clamp and trim as shown. Cut off dielectric  $\frac{3}{16}$ " from end. Tin center conductor.



Solder contact to center conductor. Avoid use of excessive heat. See that end of dielectric is clean. Contact must be flush against dielectric. Outside of contact must be free of solder.

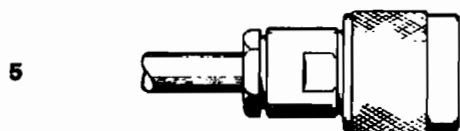

Thread assembly into connector, and lock securely. Vee gasket must be split by braid clamp.

After connector has been threaded onto RF-3281 Coupler, wrap connector with several layers of plastic electrical tape (or heat shrink material), as close to the coupler case as possible. This protects against corrosion of mating threads in wet or humid environments.



**BEFORE APPLYING POWER TO THE RADIO:**

- Insure that power is properly connected and the correct voltage (13.6 Vdc nominal) is applied.
- Insure that the radio is unkeyed and no-one is within two feet (0.6 meter) of the antenna.
- Insure the antenna (and coupler if used) is properly connected (not shorted or open).
- Insure the radio and system components are securely mounted and will not move around from vibration or shock.

**SAFETY PRECAUTIONS**

To avoid personal injury when operating the RF-3200 equipment, adhere to the following precautions:

- **DO NOT** transmit when located near blasting operations or flammable materials. For extra safety, turn the radio **OFF**.
- **DO NOT** store flammable liquids, gases, or explosive materials near the radio or antenna cables.
- **DO NOT** operate the equipment, if possible, during a lightning storm and **ALWAYS** use a commercially available lightning protection device on the radio's antenna input line.
- Operation of the equipment in a vehicle can affect the vehicle's electronic speed control, anti-skid brake, or fuel injection system. If you notice these devices malfunctioning when using the equipment, **IMMEDIATELY TURN POWER OFF** and contact a Harris service representative.
- **ALWAYS** ground the equipment in accordance with the procedures in this guide.
- **ALWAYS** remove power from the equipment when disassembling or making repairs.
- The equipment should be serviced only by a qualified technician.



**NOTES:**

A large rectangular box with a thin black border, intended for handwritten notes. The interior of the box is currently blank.



# OPERATION

The RF-3200 radio is easy to operate. The procedures provided in this section serve as a guide in operating the radio. When necessary, refer to the controls and indicators diagram at the front of this section.

OPERATION

**OPERATION**

**BEFORE APPLYING POWER TO THE RADIO, REVIEW THE PRECAUTIONS OUTLINED IN THE INSTALLATION SECTION.**

**WARNING**

Dangerous RF voltages may be present at the antenna terminal. Insure that no one is within two feet (0.6 meter) of the antenna before transmitting.

**TONES GENERATED BY THE RADIO**

When operating the radio, the following tones may be heard from the speaker or headphones.

STONE	DESCRIPTION	FUNCTION
CW Tone	1-kHz tone	Audible feedback
Tune Tone	A steady short tone	Indicates antenna coupler is tuning
General Error Tone	A high-pitched tone followed by a low-pitched tone.	Indicates an operator error. An Error message may appear on the display (see Display Message section). The following generate error tones: <ul style="list-style-type: none"> <li>● Keypad entry error.</li> <li>● Pressing an option button while the option isn't installed.</li> </ul>
Transmit Error Tone	Two short tones	Indicates a transmit/keying error, such as attempting to key: <ul style="list-style-type: none"> <li>● outside the transmit frequency range,</li> <li>● with the CW keyer while not in CW mode,</li> <li>● on a receive only channel, or</li> <li>● during receive-only group F operation.</li> </ul>

**CW OPERATION:**

The radio allows two different methods of CW keying while in the CW mode. In the first method, the radio can be keyed by the Accessory key line (on the accessory connector) or the microphone. Then the CW key is used to generate the CW tones. In the second method, the CW key is used for both keying the radio and for generating the tones.

**NOTE:** If the RF-3281 antenna coupler is connected and CW mode is selected, the radio's output power is reduced. This is done to protect the coupler.

**NOTE**

The "PCS" mode indicators function has been changed to "ARQ" mode.

**TRANSMIT POWER WITH RF-3281**

When using the RF-3281 Antenna Coupler with the RF-3200 in CW mode, the transmit power level is now configurable. By default the radio will automatically select low power for CW mode. To select full power the "CW mode output power level" must be configured to full power. This is different from the descriptions on pages 2-1 and 2-12.



**NOTES:**

A large, empty rectangular box with a thin black border, intended for handwritten notes. The word "NOTES:" is printed in the top-left corner of the box.

Vertical text on the right margin, possibly bleed-through from the reverse side of the page. The text is faint and difficult to read, appearing as a series of small, scattered characters and symbols.

## DISPLAY AND INDICATORS

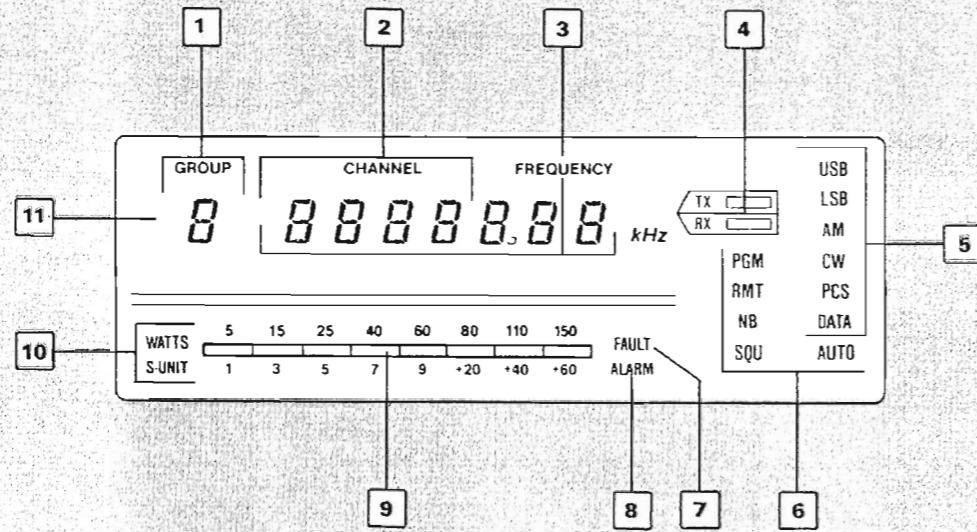

- 1 **GROUP** - Displays group number 1-9,A (all channels), or F (frequency).
- 2 **CHANNEL** - Displays channel number.
- 3 **FREQUENCY** - Displays frequency (kHz).
- 4 **TX, RX DISPLAY INDICATORS** - Shows which frequency is in the display; "TX" (Transmit), "RX" (Receive), or both "TX" and "RX" (used for simplex).
- 5 **MODE** - **USB, LSB, AM, CW, PCS, DATA**- Indicates current mode (upper sideband, lower sideband, amplitude modulation, continuous wave, partial carrier suppression, or data).
- 6 **FUNCTIONS** - **PGM, RMT, NB, SQU, AUTO** - Indicates active function (program, remote, noise blanker, squelch, or autolink).

- 7 **FAULT** - Indicates internal fault condition.
- 8 **ALARM** - Indicates testing or transmitting the two-tone international distress alarm signal (option).
- 9 **LED METER** - Indicates transmit forward or reflected power (watts scale) or receive signal strength (s-unit scale).
- 10 **WATTS/S-UNIT** - Indicates whether the radio is transmitting (watts) or receiving (s-units) and units of the LED meter.
- 11 **VACUUM FLUORESCENT DISPLAY (VFD)**- Displays frequency, channel clarifier, group information, and status/error messages. Eight digits used.

## FRONT PANEL CONTROLS

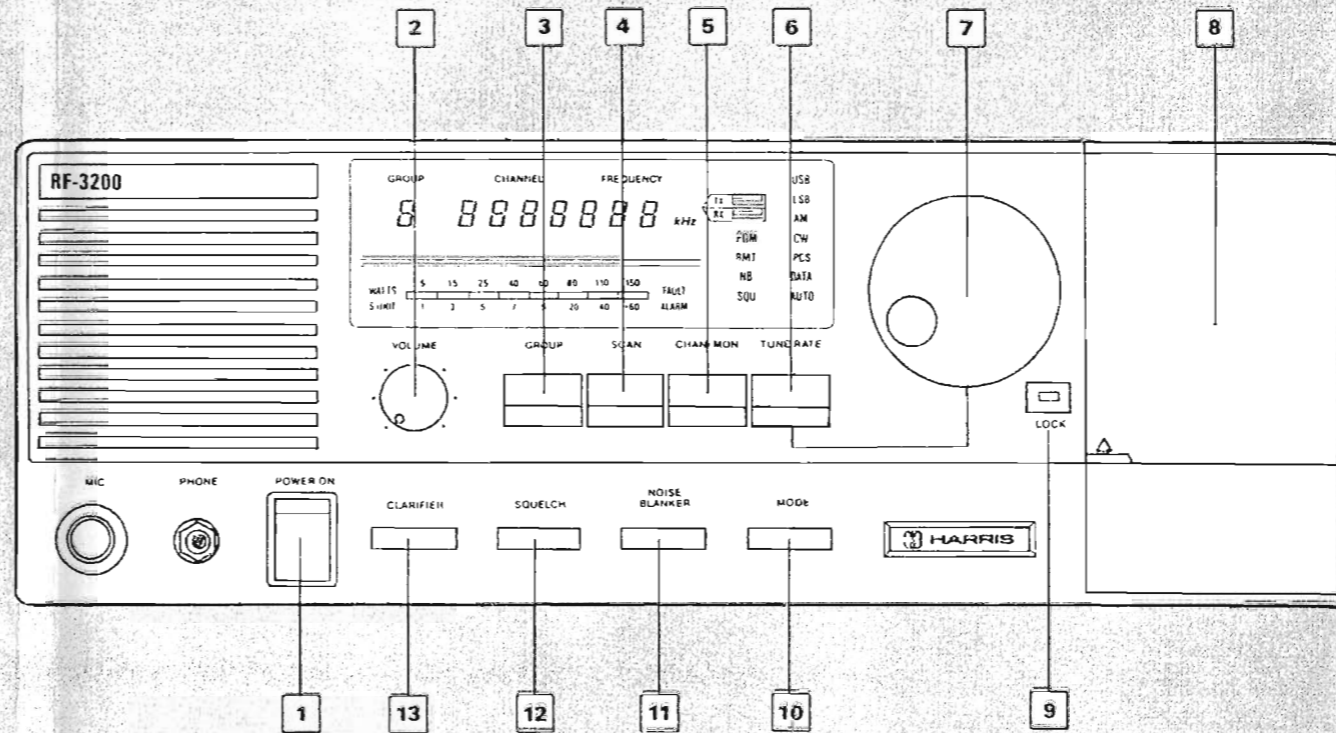

- 1 **POWER ON** - Provides power to the radio.
- 2 **VOLUME** - Controls volume of the speaker or headphones.
- 3 **GROUP** - Selects channel groups 1 to 9, "A" (All) or "F" (frequency). Only programmed or enabled groups will be displayed.
- 4 **SCAN** - Enables/disables group scan feature. Indicated by the letters "Sc" to the right of the channel number.
- 5 **CHAN/MON** - Monitors and displays channel number, RX frequency, or TX frequency during channel operation. Also monitors RX frequency and TX frequency during group "F" operation.
- 6 **TUNE RATE** - Selects frequency adjustment rate of the tuning knob. Setting indicated by flashing the digit position.
- 7 **TUNING KNOB** - Adjusts frequency, channel, or clarifier setting.

- 8 **KEYPAD ACCESS DOOR** - To open, push up at arrow and release.
- 9 **LOCK** - Enables/disables tuning knob. Indicator is lit when the tuning knob is locked.
- 10 **MODE** - Selects mode indicated in display. Inactive during normal operation if a specific mode has been programmed into the channel.
- 11 **NOISE BLANKER** - Enables/disables optional noise blanker circuit. When option is not installed, pressing this button will cause an error tone to be heard. The "NB" indicator is lit when enabled.
- 12 **SQUELCH** - Enables/disables squelch. The "SQU" indicator is lit when enabled.
- 13 **CLARIFIER** - Enables/disables clarifier adjustment. When the letters "CL" are displayed, the tuning knob is used to adjust receive frequency offset.

## KEYPAD CONTROLS

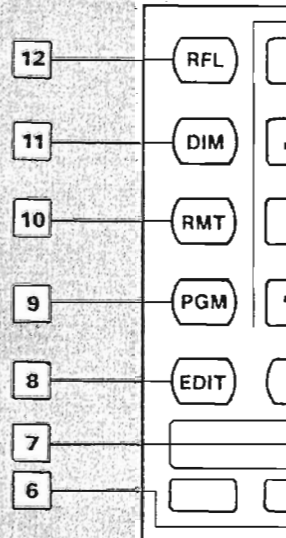

- 1 **NUMERIC KEYPAD** - Enter frequencies, passwords, channels and configuration data. Digits entered scroll from right to left on display. The last digit entered will blink until the ENT key is pressed.
- 2 **\*KEY** - Displays antenna coupler status messages in normal operation. Scrolls through parameters during configuration programming.
- 3 **#KEY** - Scrolls through and displays software revision (shown by "Cr" in the display) and serial number in normal operation. Toggles display between parameter value and parameter code during configuration programming.
- 4 **ENTER (ENT)** - MUST be pressed after a numeric keypad entries.
- 5 **CLEAR (CLR)** - Deletes incorrect keypad entries one digit at a time from right to left. Removes error messages from the display. Also, deletes channels from groups during group programming.
- 6 **OPTION KEYS** - Available for future options.

## FRONT PANEL CONTROLS

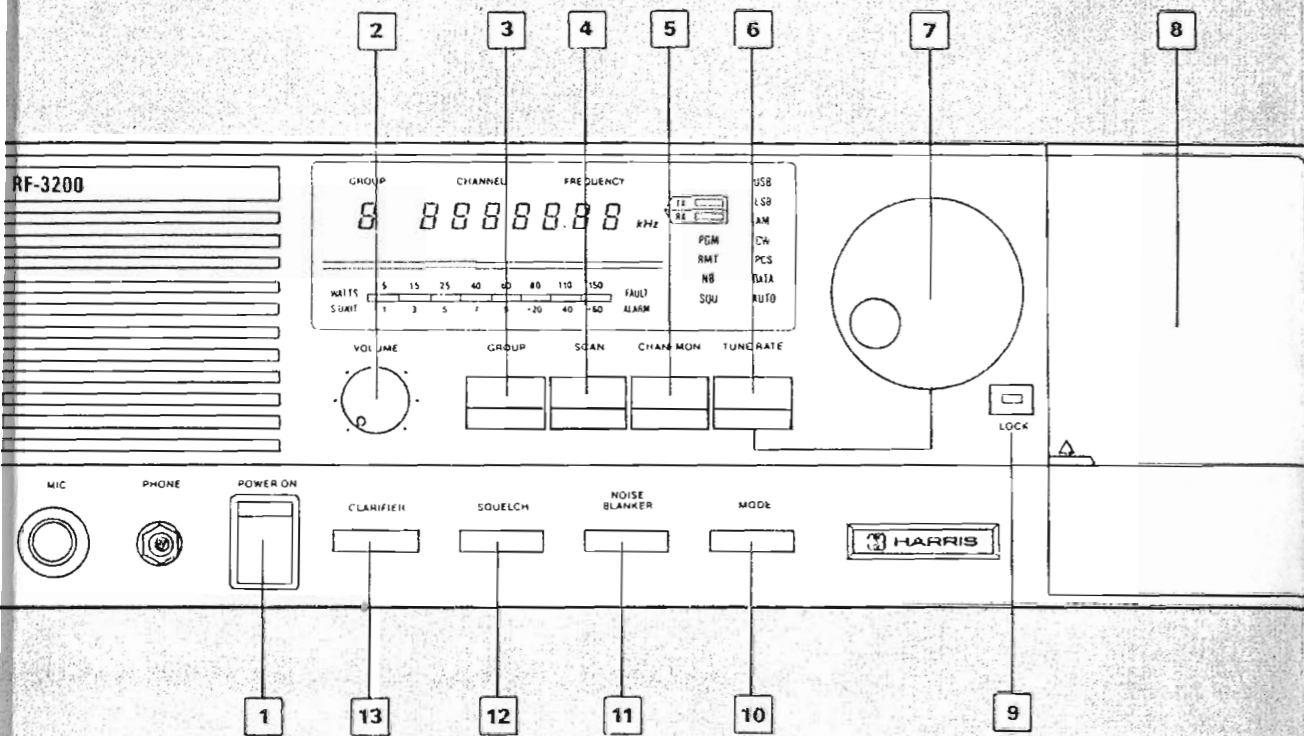

- 1 POWER ON** - Provides power to the radio.
- 2 VOLUME** - Controls volume of the speaker or headphones.
- 3 GROUP** - Selects channel groups 1 to 9, "A" (All) or "F" (frequency). Only programmed or enabled groups will be displayed.
- 4 SCAN** - Enables/disables group scan feature. Indicated by the letters "Sc" to the right of the channel number.
- 5 CHAN/MON** - Monitors and displays channel number, RX frequency, or TX frequency during channel operation. Also monitors RX frequency and TX frequency during group "F" operation.
- 6 TUNE RATE** - Selects frequency adjustment rate of the tuning knob. Setting indicated by flashing the digit position.
- 7 TUNING KNOB** - Adjusts frequency, channel, or clarifier setting.
- 8 KEYPAD ACCESS DOOR** - To open, push up at arrow and release.
- 9 LOCK** - Enables/disables tuning knob. Indicator is lit when the tuning knob is locked.
- 10 MODE** - Selects mode indicated in display. Inactive during normal operation if a specific mode has been programmed into the channel.
- 11 NOISE BLANKER** - Enables/disables optional noise blanker circuit. When option is not installed, pressing this button will cause an error tone to be heard. The "NB" indicator is lit when enabled.
- 12 SQUELCH** - Enables/disables squelch. The "SQU" indicator is lit when enabled.
- 13 CLARIFIER** - Enables/disables clarifier adjustment. When the letters "CL" are displayed, the tuning knob is used to adjust receive frequency offset.

## KEYPAD CONTROLS

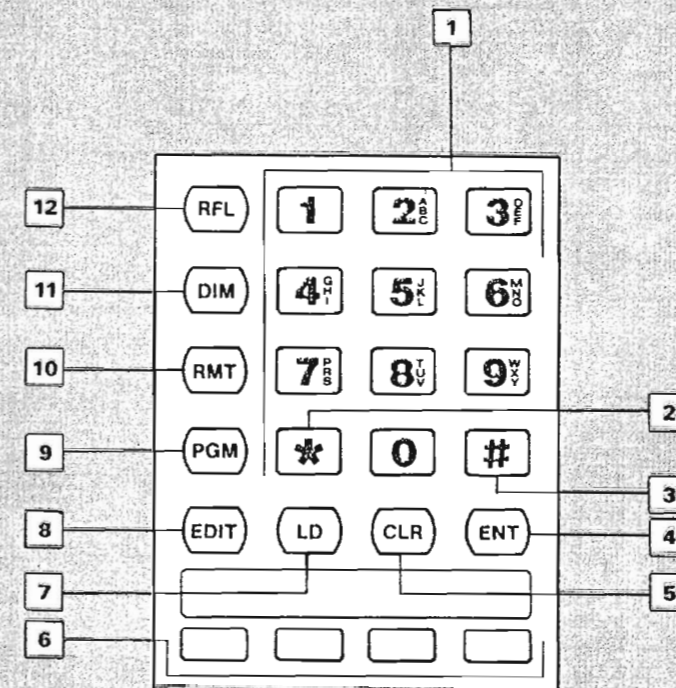

- 1 NUMERIC KEYPAD** - Enter frequencies, passwords, channels and configuration data. Digits entered scroll from right to left on display. The last digit entered will blink until the ENT key is pressed.
- 2 \* KEY** - Displays antenna coupler status messages in normal operation. Scrolls through parameters during configuration programming.
- 3 # KEY** - Scrolls through and displays software revision (shown by "Cr" in the display) and serial number in normal operation. Toggles display between parameter value and parameter code during configuration programming.
- 4 ENTER (ENT)** - MUST be pressed after all numeric keypad entries.
- 5 CLEAR (CLR)** - Deletes incorrect keypad entries one digit at a time from right to left. Removes error messages from the display. Also, deletes channels from groups during group programming.
- 6 OPTION KEYS** - Available for future options.
- 7 LOAD (LD)** - Stores information into groups (1 to 9) during group programming or channels (0 to 120) during channel programming.
- 8 EDIT** - Used during group programming to toggle the display between the group to be programmed and the list of channels that can be programmed.
- 9 PROGRAM (PGM)** - Used to enter/exit program and configuration operations.
- 10 REMOTE (RMT)** - Enables/disables the optional remote control. The "RMT" indicator will light when enabled. When option is not installed pressing this button will cause the error tone to be heard.
- 11 DIMMER (DIM)** - Adjusts brightness level of display and indicators (bright, normal or off). Alarm and Fault indicators are not affected.
- 12 REFLECTED POWER (RFL)** - When pressed during transmit, displays the reflected power on the LED meter and the word "rEFLECT" appears on the display.

NOTES:



The RF-3200 can be set up to operate in two ways: Full Frequency\* (group F), or Channel operation (group A and groups 1 to 9).

### **FULL FREQUENCY (GROUP F) OPERATION\***

While in group F the radio can be continuously operated over the allowable receive and transmit frequency range. Also, while in group F, the mode (USB, LSB, AM, CW, PCS, or DATA) may be selected to suit the operation.

Group F may be operated in three ways:

- **SIMPLEX operation:** both the receive and transmit frequencies are the same (RX and TX indicators lit).
- **HALF-DUPLEX operation:** the receive and transmit frequencies are different (only RX or only TX indicator lit).
- **RECEIVE ONLY operation:** access to only the receive frequency (only RX indicator lit).

### **CHANNEL OPERATION (GROUP A OR GROUPS 1 TO 9)**

Channel operation refers to accessing one of 321 available channels. Channels contain receive and transmit frequencies, and may have a programmed mode. Channels can be defined as one of three types:

- **SIMPLEX CHANNELS:** both the receive and transmit frequencies are the same (RX and TX indicators lit).
- **HALF-DUPLEX CHANNELS:** the receive and transmit frequencies are different (only RX or only TX indicator lit).
- **RECEIVE ONLY CHANNELS:** access to only the receive frequency; while the transmit frequency is programmed to zero (only the RX indicator lit).

**\*NOTE:** Regulatory requirements may limit access to group F (full frequency tuning).

- Group F may not be available on some radios.
- The allowable frequency range may be set narrower than 500 kHz to 30 MHz.
- Transmit operation may be disabled, only receive operation allowed.

### Group A Operation

Group A, the master channel list, contains all 321 channels stored in the radio. The channels in group A include the 121 user-programmable channels (0 to 120) and the 200 factory-programmed channels.

- User-Programmable Channels (0 to 120)

Information associated with channels 0 to 120 may be changed only during CHANNEL PROGRAMMING. Once the frequency and specific mode information have been programmed into a channel, they can not be changed during normal operation. However, if a channel has been programmed without a specific mode, the mode may be changed during normal operation. In addition, channels are stored as one of the three channel types.

- Factory-Programmed Channels

Group A contains 200 factory-programmed channels. These channels contain predefined frequency and mode information which cannot be changed by the user. Refer to the Reference Information section of this manual for the channel numbers and the contents of the channels.

### Groups 1 to 9

Groups 1 to 9 are used for channel scanning and storing frequently used channels. The nine groups let the operator form convenient subsets of group A. Up to 135 total channels can be stored among the 9 groups. Thus, the user is able to vary the sizes of the nine groups to fit the need. Channels can be stored into a group more than once, and can be stored into more than one group at a time. This is useful during channel scanning, because it allows a channel to be scanned more frequently, or for a longer period of time. The contents of groups 1 to 9 can be recorded in the Reference Information section of this manual.

### USING PRE-PROGRAMMED CHANNELS

Your radio may have the user-programmable channels 0-120 already custom-programmed. If the radio is not custom-programmed, then channels 0-120 will contain the following:

- Channel 0, the international distress frequency 2182 kHz.
- Channels 1 to 120, receive-only channels on 1.6 MHz in USB mode; (Refer to the Channel Programming section for information on programming channels 0-120.)

The balance of the channels are non-alterable. Refer to the Reference Information section for a list of channels and associated frequencies.

- Channels 201-224, useful marine frequencies
- Channels 401-2240, standard ITU (International Telecommunications Union) channels.

To operate on the preprogrammed channels, perform the following steps:

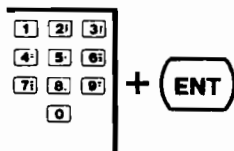
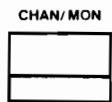
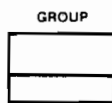

1. **PRESS GROUP BUTTON** until the desired group appears in the display. (Group A, if enabled, or groups 1-9. Groups that do not contain channels will not appear in the display.)

2. **PRESS THE CHAN/MON BUTTON** until a channel number appears in the display. This button cycles the display through the channel number, receive frequency, and transmit frequency. For simplex channels (when the receive and transmit frequencies are the same) or for channels programmed for receive-only operation, only one frequency is shown.

3. **SELECT THE DESIRED CHANNEL**, in one of three ways:

- With the **TUNING KNOB**. Rotate to move through the channels. If a channel's receive frequency appears in the display, rotate the tuning knob to change to the next channel and display its receive frequency. (Refer to the Configuration Programming section for information on how to change the Tune Knob Resolution).

**OR**

- With the **NUMERIC KEYPAD** and the **ENT** key. Select the desired channel number and then press the ENT (enter) key. Use the CLR key to clear mistakes.

**OR**

SCAN

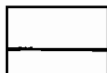

- c. With the SCAN button. (Only for groups 1-9). Press the SCAN button to start channel scanning. When scanning, the letters "Sc" will appear in the right two digits of the display, and each channel in the group will be monitored for the Channel Scan Time set during Configuration Programming. Press the SCAN button again, or key the radio, to stop channel scanning.

MODE



4. PRESS THE MODE BUTTON to select the desired mode. (The mode can ONLY be changed if a mode has NOT been specifically programmed for that channel. Refer to the Channel Programming section.)

CHAN/MON



5. PRESS THE CHAN/MON BUTTON to insure the channel is not in use. For simplex channels, monitor the receive frequency. For half-duplex channels, press the CHAN/MON button until only the TX display indicator is lit.



6. KEY THE RADIO and begin transmission. (If an antenna coupler is installed, it will tune automatically.)



7. OPTIONAL: PRESS THE RFL BUTTON while transmitting to check reflected power. To measure the reflected power, press the RFL key (located behind the access door) while transmitting and read the LED meter. A reflected power of less than 15 watts should be maintained for good performance.

CLARIFIER

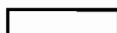

AND



8. OPTIONAL: PRESS THE CLARIFIER BUTTON to fine tune the receive frequency for best audio clarity. When the letters "CL", followed by the current clarifier setting, appear in the display, clarifier operation is active. The receive frequency offset can then be adjusted with the TUNING KNOB. Press the CLARIFIER button again when finished. The receiver will stay clarified until the channel number is changed.

SQUELCH



9. OPTIONAL: PRESS THE SQUELCH BUTTON to squelch the receive background noise. Disable the squelch by pressing the squelch button (SQU indicator turned off) when listening to weak stations.

### USING FULL FREQUENCY TUNING (GROUP F) IN SIMPLEX OPERATION

Perform the following steps to operate on simplex frequencies. (Simplex means receive and transmit frequencies are the same. This is shown by the RX and TX display indicators both being lit).

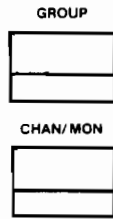

1. PRESS THE GROUP BUTTON TO SELECT GROUP F\*. If full frequency tuning is not allowed group F will not be displayed.
2. PRESS THE CHAN/MON BUTTON until both the RX and TX display indicators are lit.

**NOTE:** Some radios may be configured for receive only full frequency tuning. In this case, the receive frequency is displayed and the CHAN/MON button is inactive.

3. SELECT THE DESIRED SIMPLEX FREQUENCY in one of two ways:

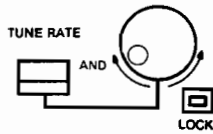

- a. With the TUNING KNOB and TUNE RATE button. Press the TUNE RATE button to select the desired tuning rate; and then use the TUNING KNOB to adjust the frequency. The tuning rate is indicated on the display by flashing the corresponding digit.

OR

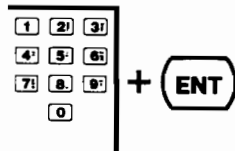

- b. With the NUMERIC KEYPAD and the ENT key. Select the desired simplex frequency and then press the ENT (enter) key. Use the CLR key to clear mistakes.

MODE



4. PRESS THE MODE BUTTON to select the desired mode.



5. KEY THE RADIO and begin transmission.  
(If an antenna coupler is installed, it will tune automatically.)



6. OPTIONAL: PRESS THE RFL BUTTON while transmitting to check reflected power. To measure the reflected power, press the RFL key while transmitting and read the LED meter. A reflected power of less than 15 watts should be maintained for good performance.

**\*NOTE:** Regulatory requirements may limit access to group F (full frequency tuning).

- Group F may not be available on some radios.
- The allowable frequency range may be set narrower than 500 kHz to 30 MHz.
- Transmit operation may be disabled, only receive operation allowed.

## CLARIFIER

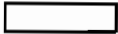

AND



## SQUELCH



7. **OPTIONAL: PRESS THE CLARIFIER BUTTON** to fine tune the receive frequency for best audio clarity. When the letters "CL" followed by the current clarifier setting appear in the display, clarifier operation is active. The receive frequency offset can then be adjusted with the TUNING KNOB. Press the CLARIFIER button again when finished. The receiver will stay clarified until the frequency is changed.
  
8. **OPTIONAL: PRESS THE SQUELCH BUTTON** to squelch the receive background noise. Disable the squelch (SQU indicator turned off), by pressing the squelch button, when listening to weak stations.

### USING FULL FREQUENCY TUNING (GROUP F\*) IN HALF-DUPLEX OPERATION

Perform the following steps to operate in half-duplex operation. (Half-Duplex means the receive and the transmit frequencies are different. This is shown by only the RX or only the TX display indicator being lit).

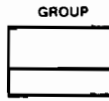

1. PRESS THE GROUP BUTTON TO SELECT GROUP F\*. If full frequency tuning is not allowed group F will not be displayed.

#### SELECT DESIRED RECEIVE FREQUENCY

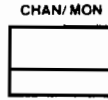

2. PRESS THE CHAN/MON BUTTON until only the RX display indicator is lit.
3. SELECT THE DESIRED RECEIVE FREQUENCY in one of two ways.

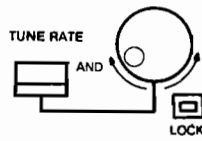

- a. With the TUNING KNOB and the TUNE RATE button. Press the TUNE RATE button to select the desired tuning rate; and then use the TUNING KNOB to adjust the frequency. The tuning rate is indicated on the display by flashing the corresponding digit.

OR

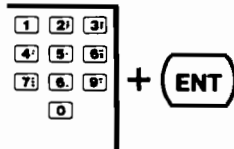

- b. With the NUMERIC KEYPAD and the ENT key. Select the desired receive frequency and then press the ENT (enter) key. Use the CLR key to clear mistakes.

**\*NOTE:** Regulatory requirements may limit access to group F (full frequency tuning).

- Group F may not be available on some radios.
- The allowable frequency range may be set narrower than 500 kHz to 30 MHz.
- Transmit operation may be disabled, only receive operation allowed.

### SELECT DESIRED TRANSMIT FREQUENCY

**\*NOTE:** For radios configured for receive only in Group F, half-duplex operation is not accessible. The receive frequency will be displayed and the CHAN/MON button will be inactive.



4. PRESS THE CHAN/MON BUTTON until only the TX display indicator is lit.

5. SELECT THE DESIRED TRANSMIT FREQUENCY in one of two ways:

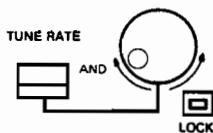

a. With the TUNING KNOB and TUNE RATE button. Press the TUNE RATE button to select the desired tuning rate; and then use the TUNING KNOB to adjust the frequency. The tuning rate is indicated on the display by flashing the corresponding digit.

OR

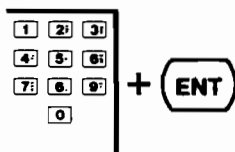

b. With the NUMERIC KEYPAD and the ENT key. Select the desired transmit frequency and then press the ENT (enter) key. Use the CLR key to clear mistakes.

MODE



6. PRESS THE MODE BUTTON to select the desired mode.

CHAN/MON

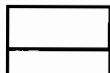

7. PRESS THE CHAN/MON BUTTON to insure the frequency is not in use. For half-duplex operation, monitor the transmit frequency (only the TX indicator is lit).

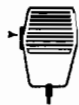

8. KEY THE RADIO and begin transmission. (If an antenna coupler is installed, it will tune automatically.)



9. OPTIONAL: PRESS THE RFL BUTTON while transmitting to check reflected power. To measure the reflected power, press the RFL key (located behind the access door) while transmitting and read the LED meter. A reflected power of less than 15 watts should be maintained for good performance.

CLARIFIER



AND



10. OPTIONAL: PRESS THE CLARIFIER BUTTON to fine tune the receive frequency for best audio clarity. When the letters "CL" followed by the current clarifier setting appear in the display, clarifier operation is active. The receive frequency offset can then be adjusted with the TUNING KNOB. Press the CLARIFIER button again when finished. The receiver will stay clarified until the receive frequency is changed.

SQUELCH



11. OPTIONAL: PRESS THE SQUELCH BUTTON to squelch the receive background noise. Disable the squelch by pressing the squelch button, (SQU indicator turned off) when listening to weak stations.



**GENERAL INFORMATION**

The RF-3281 Antenna Coupler automatically matches the radio to a variety of antenna types over the 1.6 to 30 MHz frequency range. The power capacity of the coupler is 125 watts PEP (voice duty) and 30 watts average. Because the RF-3281 is a voice duty coupler, the radio will automatically transmit low power during CW operation. The RF-382-01 Antenna Coupler should be used for continuous operation at 125 watts average power.

**OPERATION**

Coupler operation is FULLY AUTOMATIC. When transmitting on a new frequency or channel, the coupler will perform an initial learning sequence. The learning sequence is indicated by the tune tone and the word "tuning" in the display. Tuning information for 321 channels and 16 random frequencies (group F) are stored in memory. If transmitting on a channel or frequency already stored in memory, the coupler will tune in less than 30 msec.

**MESSAGES**

The coupler and radio provide the user with many useful display messages (refer to the Display Messages section). In addition, if the radio cannot communicate with the coupler during power up, the No CPLR (no coupler) message is displayed. However, if the radio cannot communicate with the coupler AFTER power up, both the error tone and the No CPLR message will result. Refer to Care & Troubleshooting section

The radio also allows the user to check the last power level requested by the coupler. Press the ★ key to display the last power level (refer to the Display Messages section). Press the ★ key to return to normal operations

**NOTES:**

## CHANNEL SCAN OPERATION

### ENTERING CHANNEL SCAN OPERATION

Channel Scan operation is entered when the SCAN button is pressed while viewing groups 1 to 9. The letters "Sc" will appear to the right of the channel number to indicate that scan operation is active.

### TYPES OF SCAN OPERATION

Two different types of operation occur depending on the mode assigned to the current channel.

1. USB, LSB, or AM Mode

- a. Stop on Squelch

Stop on squelch only occurs on channels which have USB, LSB or AM modes; and if the scan dwell time is NOT zero. In addition, the squelch circuit must be activated ("SQU" indicator lit). During stop on squelch the radio will remain on each channel for the configured scan time if the signal is squelched. However, once squelch is broken the radio will remain on that channel until the receive signal is removed and then will hold for the configured scan dwell time. If the receive signal does not reappear during the scan dwell time the radio will resume scanning. Stop on squelch can be disabled by two methods, either set scan dwell time to zero, or deactivate the squelch ("SQU" indicator turned off).

If stop on squelch is disabled, each channel in the current group will be monitored for the configured channel scan time regardless of the receive signal.

- b. Transmitting During Scan Operation

When the radio is keyed while scanning a channel with USB, LSB, or AM mode, scan operation is exited.

2. CW, DATA, or ARQ Mode

- a. Channel Scanning

Each channel in the current group will be monitored for the configured channel scan time regardless of the receive signal.

- b. Transmitting During Scan Operation

When the radio is keyed with the microphone, while scanning a channel with CW, DATA, or ARQ mode, scanning is exited.

When the radio is keyed through the CW or accessory connectors, while scanning a channel with CW, DATA or ARQ mode, scanning is halted while the radio is transmitting. Upon returning to receive the radio will remain on the current channel for the DATA/CW/ARQ key dwell time. If the radio is in receive for this dwell time, scanning is resumed. This function can be disabled if the key dwell time is set to zero, in this case scanning is exited when the radio is keyed.

### EXITING SCAN OPERATION

Channel scanning can be exited by two methods.

1. With the SCAN Button

Scanning can be exited by pressing the SCAN button.

2. By Transmitting

When the radio is keyed while on a channel with USB, LSB, or AM mode, scanning is exited. When the radio is keyed with the microphone, while scanning a channel with CW, DATA, or ARQ, mode scanning is exited. Also, when the key dwell time is set to zero, scanning is exited when the radio is keyed, regardless of mode.

The letters "Sc" are removed from the display to indicate channel scanning has been stopped.

# PROGRAMMING & CONFIGURATION

Programming refers to channel or group programming. Channel programming is storing frequency and mode information into the user programmable channels. Group programming is storing channels into groups 1-9.

Configuration refers to setting the radio to fit the user's needs.

PROGRAMMING &  
CONFIGURATION

**PROGRAMMING THE RADIO:**

There are two different types of programming; CHANNEL PROGRAMMING and GROUP PROGRAMMING. Programming is performed in the following sequence:

- Programming individual channels (0 to 120) in group A (the master channel list).
- Programming channels from the master channel list into groups 1 to 9.

**A. CHANNEL PROGRAMMING:**

Channel programming is done by loading frequency and mode information into channel numbers 0 to 120 (the user programmable channels) in group A. Each channel contains a receive frequency, transmit frequency, and may contain a specified mode. Once the specific frequency and mode data are loaded into a channel, they cannot be changed during normal operation. However, there are some channels for which the user may want to change the mode during normal operations. The radio allows the user to program a channel without selecting a specific mode; then during normal operation, the mode may be changed for that channel.

Channels can be defined as one of three types: SIMPLEX, HALF-DUPLEX, or RECEIVE ONLY.

- **SIMPLEX CHANNELS:** the receive and the transmit frequencies are the same, (both RX and TX indicators are lit).
- **HALF-DUPLEX CHANNELS:** the transmit and receive frequencies are different, (only the TX or only the RX indicator is lit).
- **RECEIVE ONLY CHANNELS:** access to only the receive frequency, (only the RX indicator is lit). To make a channel RECEIVE ONLY, the transmit frequency must be set to zero during channel programming.

**B. GROUP PROGRAMMING**

Group programming allows the operator to subdivide the master channel list (group A) into smaller groups (1 to 9). This allows channels with common characteristics or uses to be stored in the same group. Groups 1 to 9 are used for channel operation and channel scanning. Up to 135 channels can be loaded among groups 1 to 9. This allows the size of the groups to vary. Channels can be loaded into a group more than once, and may be loaded into more than one group. This is useful during channel scanning because it enables a channel to be scanned more frequently or for a longer period of time. The contents of groups 1 to 9 should be recorded in the Reference Information section of this manual.

## TO PROGRAM CHANNELS 0 TO 120 IN GROUP "A" AS SIMPLEX CHANNELS.



1. PRESS THE PGM KEY until "Pg PASS" appears in the display. The program (PGM) indicator will light.

**NOTE:** Radios which are configured to prohibit programming will not display the "Pg PASS" prompt.

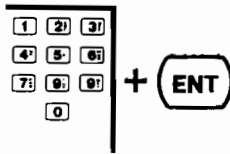

2. ENTER THE USER PASSWORD supplied with your radio. Use the numeric keypad and press the ENT (enter) key.

**NOTE:** If the password entered is valid, the display will indicate the group number and channel (or frequency) that was displayed before entering programming mode. If the password is not valid, the error tone will sound and the "Pg PASS" prompt will reappear in the display; re-enter the correct password.

GROUP

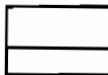

3. PRESS THE GROUP BUTTON to select group A. (Radios which are configured to prohibit channel programming will not display group A.)

CHAN/MON

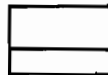

4. PRESS THE CHAN/MON BUTTON until a channel number appears in the display. In channel programming operation, this button sequences the display through: the channel number, simplex frequency, receive frequency, and transmit frequency.

5. SELECT THE DESIRED CHANNEL TO BE PROGRAMMED\*, in one of two ways:



- a. With the TUNING KNOB. Rotate to move through the channels in the group A.

OR

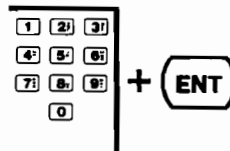

- b. With the NUMERIC KEYPAD and the ENT key. Select the desired channel number, and then press the ENT (enter) key. Use the CLR key to clear mistakes.

CHAN/MON

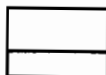

6. PRESS THE CHAN/MON BUTTON until both the RX and TX display indicators light, and a frequency is displayed.

**\*NOTE:** Channel 0 is used with the international distress alarm option and should be programmed at 2182 kHz. Other frequencies for channel 0 may be programmed if it is desired to have the alarm option operate on a frequency other than 2182 kHz.

7. SELECT THE DESIRED SIMPLEX FREQUENCY, in one of two ways:

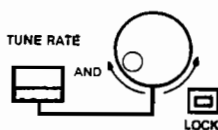

- a. With the TUNING KNOB and TUNE RATE button. Press the TUNE RATE button to select the desired tuning rate; and then use the TUNING KNOB to adjust the frequency. The tuning rate is indicated on the display by flashing the corresponding digit.

OR

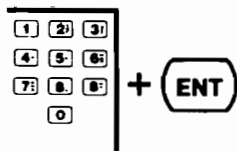

- b. With the NUMERIC KEYPAD and the ENT key. Select the desired simplex frequency and then press the ENT (enter) key. Use the CLR key to clear mistakes.

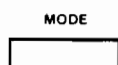

8. PRESS THE MODE BUTTON to select the desired mode. (To program the channel without a specific mode, press the mode button until none of the mode indicators are illuminated.)



9. PRESS THE LOAD KEY to store the channel setting.

*NOTE: During channel programming, if the frequency or mode is changed, a "C" will appear to the right of the channel number. This indicates that the current information (frequency or mode) is different from the information previously programmed in the channel. The user may either press the LD (load) key to replace the previous channel information or select a different channel without pressing the LD key. Selecting a different channel will leave the previous channel information unchanged.*

10. If more SIMPLEX channels are to be programmed, repeat the procedure beginning with step 4.



11. EXIT FROM THE PROGRAMMING MODE. Press PGM key until the PGM indicator turns off.



**TO PROGRAM CHANNELS 0 TO 120 IN GROUP A AS HALF-DUPLEX OR RECEIVE ONLY CHANNELS.**



1. PRESS THE PGM KEY until "Pg PASS" appears in the display. the program (PGM) indicator will light.

**NOTE:** Radios which are configured to prohibit programming will not display the "Pg PASS" prompt.

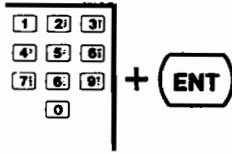

2. ENTER THE USER PASSWORD supplied with your radio, using the numeric keypad and the ENT (enter) key.

**NOTE:** If the password entered is valid, the display will indicate the group number and channel (or frequency) that was displayed before entering programming mode. If the password is not valid, the error tone will sound and the "Pg PASS" prompt will reappear in the display; re-enter the correct password.

GROUP

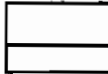

3. PRESS THE GROUP BUTTON to select group A. (Radios which are configured to prohibit channel programming will not display group A)

CHAN/MON

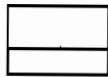

4. PRESS THE CHAN/MON BUTTON until a channel number appears in the display. In channel programming operation this button sequences the display through the channel number, simplex frequency, receive frequency, and the transmit frequency.

5. SELECT THE DESIRED CHANNEL TO BE PROGRAMMED\* in one of two ways:



- a. With the TUNING KNOB. Rotate to move through the channels in the group A.

OR

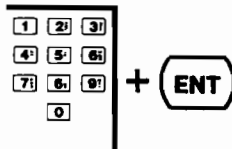

- b. With the NUMERIC KEYPAD and the ENT key. Select the desired channel number and then press the ENT (enter) key. Use the CLR key to clear mistakes.

**\*NOTE:** Channel 0 is used with the international distress alarm option and should be programmed at 2182 kHz. Other frequencies for channel 0 may be programmed if it is desired to have the alarm option operate on a frequency other than 2182 kHz.

### SELECT DESIRED RECEIVE FREQUENCY

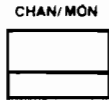

6. PRESS THE CHAN/MON BUTTON until only the RX display indicator is lit and a frequency is displayed.

7. SELECT RECEIVE FREQUENCY in one of two ways:

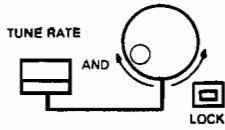

- a. With the TUNING KNOB and TUNE RATE button. Press the TUNE RATE button to select the desired tuning rate; and then use the TUNING KNOB to adjust the frequency. The tuning rate is indicated on the display by flashing the corresponding digit.

OR

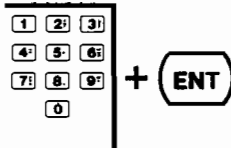

- b. With the NUMERIC KEYPAD and the ENT key. Select the desired receive frequency and then press the ENT (enter) key. Use the CLR key to clear mistakes.

**NOTE:** For RECEIVE ONLY channels the numeric keypad and the ENT button MUST be used to program a frequency of zero into the transmit frequency.

### SELECT DESIRED TRANSMIT FREQUENCY

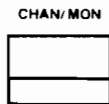

8. PRESS THE CHAN/MON BUTTON until only the TX display indicator is lit.

9. SELECT DESIRED TRANSMIT FREQUENCY in one of two ways:

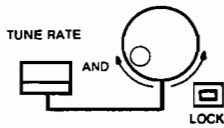

- a. With the TUNING KNOB and TUNE RATE button. Press the TUNE RATE button to select the desired tuning rate; and then use the TUNING KNOB to adjust the frequency. The tuning rate is indicated on the display by flashing the corresponding digit.

OR

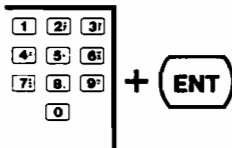

- b. With the NUMERIC KEYPAD and the ENT key. Select the desired transmit frequency and then press the ENT (enter) key. Use the CLR key to clear mistakes.

MODE

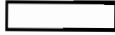

10. PRESS THE MODE BUTTON to select the desired mode. (To program the channel without a specific mode, press the mode button until NONE of the mode indicators are illuminated.)

LD



11. PRESS THE LOAD KEY to store the channel setting.

**NOTE:** During channel programming, if the frequency or mode is changed, a "C" will appear to the right of the channel number. This indicates that the current information (frequency or mode) is different from the information previously programmed in the channel. The user may either; press the LD (load) key to replace the previous channel information; or select a different channel without pressing the LD key. Selecting a different channel will leave the previous channel information unchanged.

12. If more HALF-DUPLEX channels need to be programmed, repeat the procedure beginning with step 4.

PGM



13. EXIT FROM THE PROGRAMMING MODE. Press PGM key until the PGM indicator turns off.

## TO STORE CHANNELS FROM GROUP A INTO GROUPS 1 TO 9



1. PRESS THE PGM KEY until "Pg PASS" appears in the display. The program (PGM) indicator will light.

**NOTE:** Radios which are configured to prohibit programming will not display the "Pg PASS" prompt.

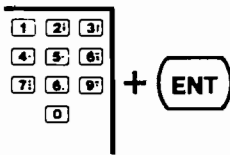

2. ENTER THE USER PASSWORD supplied with your radio. Use the numeric keypad and the ENT (enter) key.

**NOTE:** If the password entered is valid, the display will contain the group number and channel (or frequency) that was displayed before entering programming mode. If the password is not valid, an error tone will sound and "Pg PASS" will re-appear in the display; re-enter the correct password.

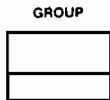

3. PRESS THE GROUP BUTTON to select the group (1 to 9) to be programmed. If the selected group is empty (indicated by "- - - -" in the display), go to step 6.



4. PRESS THE CHAN/MON BUTTON until any channel number appears in the display.

5. SELECT THE POSITION WHERE THE NEW CHANNEL WILL BE INSERTED. The new channel will be stored FOLLOWING the channel currently being displayed. The channel position can be selected in one of two ways:

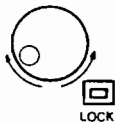

- a. With the TUNING KNOB. Rotate to move through the channels in the group.

OR

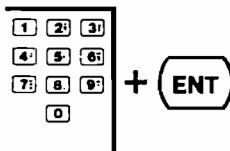

- b. With the NUMERIC KEYPAD and the ENT key. Select the desired channel number and then press the ENT (enter) key. Use the CLR key to clear mistakes.



6. PRESS THE EDIT KEY. A "P" will appear in the group area of the display. This "P" indicates that a channel can now be programmed into the group. (Pressing the EDIT button again returns the radio to the group being programmed.)

CHAN/MON

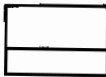

7. PRESS THE CHAN/MON BUTTON until any channel number appears in the display.

8. SELECT THE CHANNEL TO BE ADDED TO THE GROUP in one of two ways:



a. With the TUNING KNOB. Rotate to move through the channels in the master list.

OR

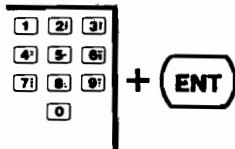

b. With the NUMERIC KEYPAD and the ENT key. Select the desired channel number and then press the ENT (enter) key. Use the CLR key to clear mistakes.

9. PRESS THE LOAD KEY to store the current channel into the group being programmed. The display will momentarily indicate the number of the group being programmed and the channel number. Then, the display will return to group P.



10. If more channels are to be stored into the current group, return to step 8.

11. IF ANOTHER GROUP IS TO BE PROGRAMMED, PRESS THE EDIT KEY. This will return the display to the group currently being programmed. Then return to step 3.



12. EXIT FROM THE PROGRAMMING MODE. Press PGM key until the PGM indicator turns off.



## TO DELETE CHANNELS FROM GROUPS 1 TO 9



1. PRESS THE PGM KEY until "Pg PASS" appears in the display. The program (PGM) indicator will light.

*NOTE: Radios which are configured to prohibit programming will not display the "Pg PASS" prompt.*

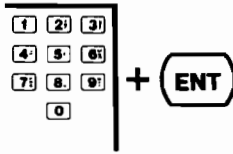

2. ENTER THE USER PASSWORD supplied with your radio. Use the numeric keypad and the ENT (enter) key.

*NOTE: If the password entered is valid, the display will indicate the group number and channel (or frequency) that was displayed before entering programming mode. If the password is not valid, the error tone will sound and the "Pg PASS" prompt will reappear in the display.*

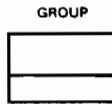

3. PRESS THE GROUP BUTTON to select the desired group (1 to 9) from which the channel is to be deleted. If the selected group is already empty (indicated by "- - - -" in the display), channels cannot be deleted from this group.

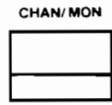

4. PRESS THE CHAN/MON BUTTON until any channel number appears in the display.

5. SELECT THE CHANNEL TO BE DELETED in one of two ways:



- a. With the TUNING KNOB. Rotate to move through the channels in the group.

OR

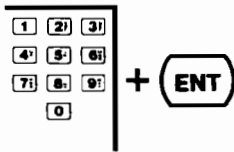

- b. With the NUMERIC KEYPAD and the ENT key. Select the desired channel number and then press the ENT (enter) key. Use the CLR key to clear mistakes.



6. PRESS THE CLEAR KEY to delete the selected channel. The next sequential channel in the group will be displayed. If the group is empty, "- - - -" will be displayed.

7. If more channels have to be deleted; return to step 3.



8. EXIT FROM THE PROGRAMMING MODE. Press the PGM key until the PGM indicator turns off.

**CONFIGURING THE RADIO**

Configuration allows the user to configure (style) the radio to meet the individual's requirements. The following items can be selected by the user. Other configuration items are dealer or factory set and are not covered in this manual.

- **DATA AGC SPEED:** This parameter selects AGC speed when using DATA mode. A value of one corresponds to fast AGC, and a value of zero corresponds to slow AGC. Default AGC speed is fast (1).
- **CW AGC SPEED:** This parameter selects AGC speed when using CW mode. A value of one corresponds to fast AGC, and a value of zero corresponds to slow AGC. Default AGC speed is slow (0).
- **ARQ AGC SPEED:** This parameter selects AGC speed when using ARQ mode. A value of one corresponds to fast AGC and a value of zero corresponds to slow AGC. Default AGC speed is fast (1).
- **DATA MODE OUTPUT POWER LEVEL:** This parameter allows the user to select the output power level when using the RF-3281. Since the RF-3281 is a voice duty coupler, low output power is automatically selected while in DATA mode. The user can override this setting by changing this parameter. Inputs are 0 and 1 (0 = low, 1 = full power). Default is low power.

**CAUTION**

When transmitting with a high average power, such as FSK, this parameter should be set to low (0) to prevent damage to the coupler.

- **CW MODE OUTPUT POWER LEVEL:** This parameter allows the user to select the output power level when using the RF-3281. Since the RF-3281 is a voice duty coupler, low output power is automatically selected while in CW mode. The user can override this setting by changing this item. Inputs are 0 and 1 (0 = low, 1 = full power). Default is low power.

**CAUTION**

When transmitting with a high average power, such as FSK, this parameter should be set to low (0) to prevent damage to the coupler.

- **LOW POWER:** Allows the user to transmit with a reduced power level. A value of one corresponds to the radio transmitting reduced power, instead of full power. This is useful in applications where full output power is not desired or where the radio is powered from a battery. Default is full power (1).
- **CHANNEL SCAN TIME:** Length of time that the radio stays on a channel while scanning before going to the next channel. Range is .5 to 9.9 seconds. Where a value of 1 corresponds to .1 second, and a value of 99 corresponds to 9.9 seconds. The default setting is 2 seconds.
- **CHANNEL DWELL TIME:** Length of time that the radio stays on a channel, during stop on squelch, after the received signal is gone. Range is 0 to 9.9 seconds, where a value of zero will allow the radio to continue scanning even when a receive signal is noticed. A value of 99 corresponds to 9.9 seconds. The default setting is 2 seconds.
- **DATA, CW and ARQ KEY DWELL TIME:** This parameter is used during scan operation to resume scanning, if the key line remains inactive for the key dwell time. Range is 0 to 600 seconds (10 min). Where a value of zero will cause the radio to exit scan operation if the radio is placed in transmit. A value of 6000 corresponds to 600 seconds or 10 minutes. Default setting is 10 minutes.
- **TUNING KNOB RESOLUTION:** Sensitivity of the tuning knob during channel operation. Range is 50 to 1/2 channels per revolution. Where a value of 1 corresponds to 50 channels per revolution and a value of 99 corresponds to 1 channel per 2 revolutions. The default setting is 4 (12 channels per revolution).
- **USER LEVEL PASSWORD:** Allows the user to change his password to any number 1-9999999.

**CAUTION:** Passwords should be kept in a safe location. If this password is lost, future configuration and programming can only be done by an authorized technician.

#### OPTION CONFIGURATION ITEMS

An option board may add configuration parameters to the current list. The meaning of the option configuration parameters are explained in the option's manual.

#### NOTE

If the address of an option board is changed, an option's software is changed, or other options are added, the option configuration parameters should be re-configured. See the option's service guide for details.



**CONFIGURATION PARAMETERS**

Refer to the following table for configuration parameters and values.

<b>PARAMETERS</b>	<b>PARAMETER CODE</b>	<b>PARAMETER VALUES</b>
DATA AGC Speed	d AgC	0-1
CW AGC Speed	C AgC	0-1
ARQ AGC Speed	A AgC	0-1
DATA Output Power	dAtA Pr	0-1
CW Output Power	C Pr	0-1
Low Power	Lo Pr	0-1
Channel Scan Time	SCAN t	1-99
Channel Dwell Time	SCAN dt	0-99
DATA, CW, ARQ Key Dwell Time	d-C dt	0-6000
User Level Password	PASS 3	1-9999999
Tuning Knob Resolution	tUN RES	1-99

**NOTE:** When a parameter value is displayed using the # button, no decimal points are displayed. However, while a new value is entered, a decimal point will appear to the left of the second digit from the right to indicate that a keypad edit is in progress.

## TO CHANGE CONFIGURATION PARAMETER VALUES

PGM

1. PRESS THE PGM KEY until "CF PASS" appears in the display. The program (PGM) indicator will light.

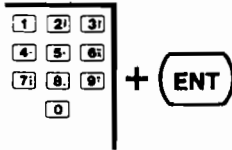

2. ENTER THE USER PASSWORD supplied with your radio, using the numeric keypad and push the enter (ENT) button.

*NOTE: If the password entered is valid, a configuration parameter will appear in the display. If the password is not valid, an error tone will sound and "CF PASS" will reappear in the display; re-enter the correct password.*

\*

3. PRESS THE \* KEY to select the desired parameter.

#

4. PRESS the # KEY to display the current parameter value.

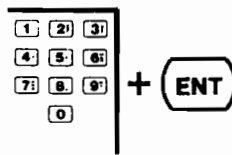

5. ENTER THE NEW PARAMETER VALUE with the NUMERIC KEYPAD and the ENT key. Enter the desired value and then press the ENT (enter) key. Use the CLR key to clear mistakes.

#

6. PRESS THE # KEY to display the new parameter value.

7. If more parameters are to be configured, return to step 3.

PGM

8. EXIT FROM CONFIGURATION. Press the PGM key until the PGM indicator turns off.

---

## DISPLAY MESSAGES

Display messages and their descriptions are provided in this section for quick referencing. The messages are listed as they would appear on the display.



DISPLAY MESSAGES

## DISPLAY MESSAGES

**ERROR MESSAGES** - ERROR MESSAGES CAN BE CLEARED BY USING THE CLR BUTTON.

GROUP	CHANNEL	FREQUENCY	KEYPAD ENTRY VALUE IS OUT OF THE ALLOWED FREQUENCY RANGE
	Error	0 kHz	
GROUP	CHANNEL	FREQUENCY	INVALID CHANNEL (CHANNEL NUMBER IS NOT IN CURRENT GROUP)
	Error	1 kHz	
GROUP	CHANNEL	FREQUENCY	NON-PROGRAMMABLE CHANNEL. (USER TRIED TO PROGRAM A CHANNEL NUMBER GREATER THAN 120)
	Error	2 kHz	
GROUP	CHANNEL	FREQUENCY	GROUP AREA FULL. THE MAXIMUM CHANNEL CAPACITY (135 CHANNELS) HAS ALREADY BEEN STORED AMONG THE NINE GROUPS
	Error	3 kHz	
GROUP	CHANNEL	FREQUENCY	RESERVED FOR FUTURE USE
	Error	4 kHz	
GROUP	CHANNEL	FREQUENCY	RESERVED FOR FUTURE USE
	Error	5 kHz	
GROUP	CHANNEL	FREQUENCY	RESERVED FOR FUTURE USE
	Error	6 kHz	
GROUP	CHANNEL	FREQUENCY	RESERVED FOR FUTURE USE
	Error	7 kHz	
GROUP	CHANNEL	FREQUENCY	RESERVED FOR FUTURE USE
	Error	8 kHz	

**CAUTION MESSAGES** - IF THE FOLLOWING MESSAGES APPEAR IN THE DISPLAY, THE RADIO MAY NOT OPERATE PROPERLY. IF THE MESSAGE IS CLEARED FROM THE DISPLAY, THE PROBLEM IS NOT ELIMINATED. CORRECTIVE ACTION SHOULD BE TAKEN.

GROUP	CHANNEL	FREQUENCY	
		9 kHz	CONFIGURATION MEMORY PROBLEM. WHEN THIS ERROR OCCURS, THE RADIO MAY NOT OPERATE PROPERLY AND MAY NEED SERVICING. REFER TO THE TECHNICAL SERVICE MANUAL (OPTION).
Error			

GROUP	CHANNEL	FREQUENCY	
		kHz	INTERNAL MEMORY BACK-UP BATTERY VOLTAGE IS LOW. BATTERY SHOULD BE REPLACED. REFER TO THE TECHNICAL SERVICE MANUAL (OPTION) FOR REPLACEMENT INFORMATION.
Lo BATT			

**NORMAL OPERATING MESSAGES**

GROUP	CHANNEL	FREQUENCY	
	- - - -	kHz	EMPTY GROUP, NO CHANNELS STORED

GROUP	CHANNEL	FREQUENCY	
-	- - - -	kHz	ALL GROUPS ARE EMPTY AND DISABLED

GROUP	CHANNEL	FREQUENCY	
		kHz	INDICATES LED METER IS DISPLAYING REFLECTED POWER
REFLECT			

GROUP	CHANNEL	FREQUENCY	
		kHz	TUNE POWER INDICATOR. DISPLAYED WHEN ANTENNA COUPLER IS TUNING
TUNING			

GROUP	CHANNEL	FREQUENCY	
		kHz	ENTER PROGRAMMING PASSWORD
PG PASS			

GROUP	CHANNEL	FREQUENCY	
		kHz	ENTER CONFIGURATION PROGRAMMING PASSWORD
CF PASS			

GROUP	CHANNEL	FREQUENCY	
		kHz	ANTENNA COUPLER DID NOT TUNE
No tune			

GROUP	CHANNEL	FREQUENCY	
		kHz	NO COUPLER PRESENT. THE RADIO IS CONFIGURED FOR THE RF-3281 ANTENNA COUPLER, BUT SENSES THAT ONE IS NOT PRESENT. <b>NOTE:</b> THE RADIO WILL STILL OPERATE
No CPLR			

## DISPLAY MESSAGES

**ANTENNA COUPLER STATUS MESSAGES** - TO VIEW THE ANTENNA COUPLER STATUS MESSAGES, PRESS THE \*KEY. TO RETURN TO NORMAL OPERATION PRESS THE \*KEY AGAIN.

GROUP	CHANNEL	FREQUENCY	
	FULL	PF kHz	FULL POWER SENT TO COUPLER DURING LAST TRANSMISSION
	Lo	PF kHz	LOW POWER SENT TO COUPLER DURING LAST TRANSMISSION
	tune	PF kHz	TUNE POWER SENT TO COUPLER DURING LAST TRANSMISSION
	BYPASS	kHz	COUPLER RECEIVED FULL POWER AND WAS BYPASSED DURING LAST TRANSMISSION
	No	PF kHz	NO POWER TO COUPLER DURING LAST TRANSMISSION

## CARE & TROUBLESHOOTING

The table of preventive maintenance tips provided in this section should be consulted to keep your equipment performing within specifications and to avoid damage.

The problems listed in the troubleshooting table normally occur due to improper operation or connection of the equipment. Use the table to check the corrective action listed. If the problem persists, contact a service technician. If more technical information is required, a service manual should be ordered (See ordering information in the back of the user's guide).

CARE &  
TROUBLESHOOTING

**PREVENTIVE MAINTENANCE TIPS**

DO NOT operate the equipment, if possible, during lightning storms. Disconnect the antenna feedline from the radio and ground it when the radio is not used.

To increase the life of the display, operate the radio using the normal brightness setting whenever possible.

Operate the radio only within its specified input voltage range (11-16 VDC, 13.6 VDC nominal).

DO NOT obstruct the radio's bottom ventilation slots or rear panel heatsink holes, (refer to Installation section).

Keep the radio's heatsink fins at the rear from becoming covered with dirt and grime. Use a soft bristled brush and damp cloth to clean the fins when necessary.

Keep the radio's front panel buttons and knobs free from dust and grime. Use a damp cloth to clean when necessary.

If the equipment is to be subjected to severe shock and vibration, use the optional shock mount RF-3241 (refer to the Option section).

AVOID stressing interconnecting cables.

Frequently inspect all cables and connections, especially those exposed to rain, snow, sun, etc. for loose connections, frayed wires, and corrosion.

Only a qualified technician should perform repairs or adjustments.

TURN OFF the equipment when it is not being used.

DO NOT replace a fuse with an unspecified part.



TROUBLESHOOTING TABLE

PROBLEM	PROBABLE CAUSE	CORRECTION ACTION
Radio does not turn on.	<ol style="list-style-type: none"> <li>1. Bad power cable/connection.</li> <li>2. Blown rear panel fuse or power cable in-line fuse.</li> <li>3. Bad power source.</li> </ol>	<ol style="list-style-type: none"> <li>1. Check power cable &amp; connections.</li> <li>2. Check for blown fuse, check cause before replacing.</li> <li>3. Replace power source.</li> </ol>
Radio is on, but front panel is not lit.	"DIM" key set to off position.	Press "DIM" key for normal brightness.
No signal is heard when antenna is connected.	<ol style="list-style-type: none"> <li>1. Radio is keyed.</li> <li>2. Squelch is on.</li> <li>3. Volume is too low.</li> </ol>	<ol style="list-style-type: none"> <li>1. Unkey radio (S-UNITS indicated on LED meter).</li> <li>2. Turn off squelch.</li> <li>3. Set volume control to midway position.</li> </ol>
Receiver noise is heard but no signal is received.	<ol style="list-style-type: none"> <li>1. Bad antenna or connections.</li> <li>2. No received signal on selected frequency.</li> </ol>	<ol style="list-style-type: none"> <li>1. Check all antenna connections.</li> <li>2. Select another frequency or channel.</li> </ol>
Audio is unintelligible.	<ol style="list-style-type: none"> <li>1. Receive signal is off frequency.</li> <li>2. Incorrect mode selected.</li> </ol>	<ol style="list-style-type: none"> <li>1. Use clarifier and tuning knob to adjust receive frequency.</li> <li>2. Select correct mode.</li> </ol>
Tuning knob has no affect.	"LOCK" feature is on.	Press LOCK button to unlock tuning knob.
Radio does not scan.	<ol style="list-style-type: none"> <li>1. Group "A" or "F" selected.</li> <li>2. The group to be scanned has only 1 channel stored.</li> </ol>	<ol style="list-style-type: none"> <li>1. Select another group. (1-9)</li> <li>2. Load more channels in the group to be scanned.</li> </ol>
No output power when radio is keyed.	<ol style="list-style-type: none"> <li>1. Bad MIC or cable.</li> </ol>	<ol style="list-style-type: none"> <li>1. Check MIC and cable.</li> </ol>
No output in CW.	<ol style="list-style-type: none"> <li>1. The CW key plug is not completely inserted.</li> <li>2. The CW key contacts are dirty or cable is bad.</li> <li>3. Radio is not in CW mode.</li> </ol>	<ol style="list-style-type: none"> <li>1. Insert CW key plug fully.</li> <li>2. Check CW key contacts and cable.</li> <li>3. Select CW mode.</li> </ol>
Error message appears on the display.	Operator or memory error.	See Display Messages section for description, then push CLR key to clear message.
Fault indicator comes on and stays on.	PA is too hot.	Check that rear panel heatsink & bottom ventilation slots are not obstructed. Allow time for PA to cool down.
"No CPLR" message appears on the display.	<ol style="list-style-type: none"> <li>1. Bad cable between radio and coupler.</li> <li>2. Antenna coupler disconnected.</li> <li>3. Blown coupler fuse on coupler option board.</li> </ol>	<ol style="list-style-type: none"> <li>1. Replace cable.</li> <li>2. Connect coupler to radio.</li> <li>3. Replace fuse.</li> </ol>

RF-3200 SYSTEM BLOCK DIAGRAM

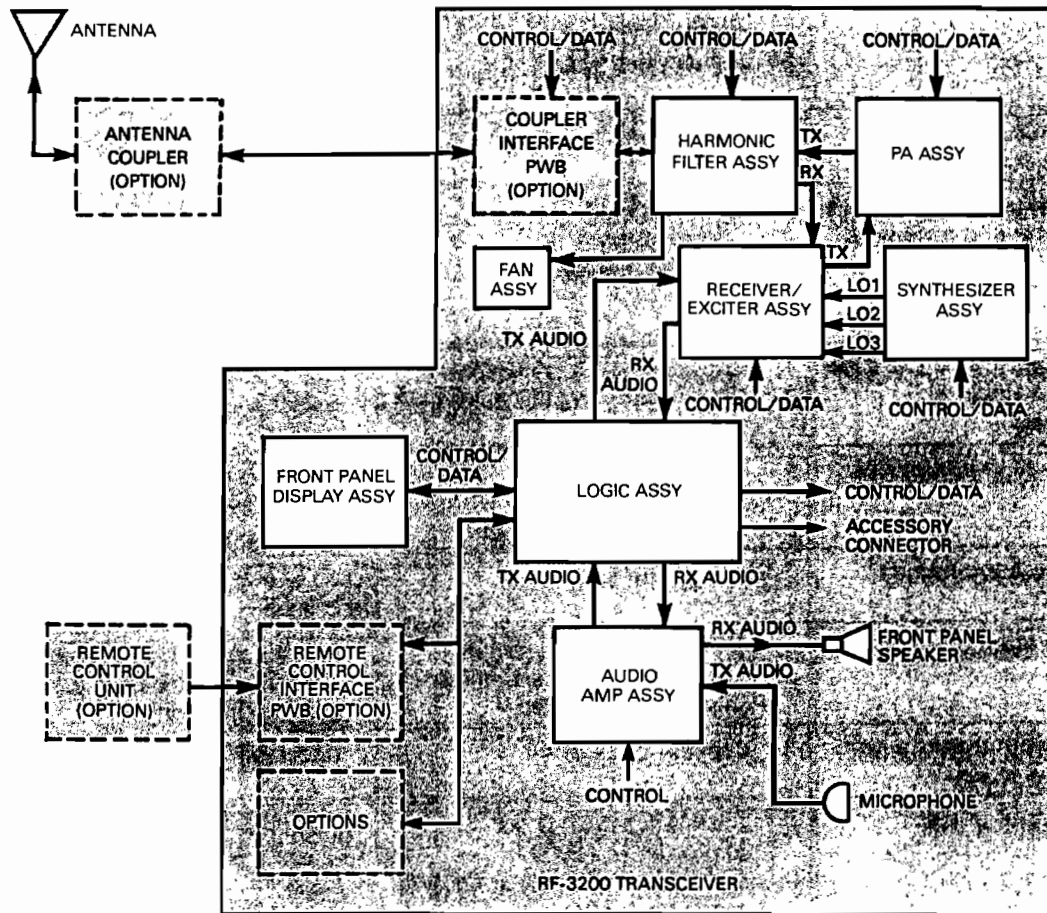

R32-006

**NOTE:** For complete technical information, order the RF-3200 Transceiver Service Manual. See order form at back of User Guide for manual ordering information.

# REFERENCE INFORMATION

Quick reference information on specifications, terminology, propagation, as well as channel programming tables, and group log tables are provided in this section for convenience.

REFERENCE  
INFORMATION

## SPECIFICATIONS FOR RF-3200 125 WATT HF-SSB TRANSCEIVER

## GENERAL

<b>Frequency Range</b>	1.6 to 30 MHz transmit, 0.5 to 30 MHz receive.
<b>Frequency Resolution</b>	10 Hz steps, digitally synthesized.
<b>Number of Channels</b>	200 preprogrammed (factory set); 121 user programmable; all channels simplex or half-duplex; non-volatile memory (battery back-up).
<b>Scan</b>	9 user programmable groups.
<b>RF Power Output</b>	125 watt PEP or Average with thermal protection.
<b>Frequency Stability</b>	$\pm 5$ parts in $10^7$ ( $\pm 15$ Hz).
<b>Emission Mode</b>	<ul style="list-style-type: none"> <li>● J3E-suppressed carrier (USB/LSB)</li> <li>● H3E-full carrier (AME)</li> <li>● R3E-reduced carrier (PCS)</li> <li>● J2A-CW (optional narrow band filter available)</li> <li>● J2B-FSK/TTY (optional filter available)</li> </ul>
<b>Display</b>	8-digit vacuum fluorescent display, LED status indicators.
<b>Power Input</b>	13.6 Vdc $\pm 20\%$ Standby: 1.0 Amps Full Audio: 1.25 Amps Voice Duty: 10 Amps Average 2 Tone PEP: 18 Amps Average
<b>Meter</b>	Front panel: Tx (watts), Reflected Power (watts), Rx (s-units).
<b>Diagnostic Fault Detection</b>	Monitor and indication of transmit forward/reflected power, VSWR, temperature, and antenna coupler fault conditions.
<b>Size</b>	4.35H x 12.25W x 12.75D in. (11.0H x 31.1W x 32.4D cm).
<b>Weight</b>	15.5 lbs. (7.0 kg).
<b>FCC Type Acceptance Parts 80, 87, 90</b>	AQZ9PT3200
<b>DOC Type Approval &amp; Certificates</b>	
<b>RS-125</b>	122 251 058LM B9144
<b>RS-181</b>	122 811 110C B9145

## ENVIRONMENTAL

<b>Temperature</b>	-30°C to +60°C.
<b>Shock</b>	MIL-STD-810D.
<b>Vibration</b>	MIL-STD-810D.
<b>Humidity</b>	MIL-STD-810D.

**TRANSMITTER**

<b>Power Output</b>	SSB (U/L sideband): 125 watt PEP/Average; AM compatible (H3E) 35 watts carrier.
<b>Overload Protection</b>	PA fully protected from mismatch including open or shorted antenna and thermal overload.
<b>Carrier Suppression (J3E Mode)</b>	55 dB below PEP.
<b>Intermodulation Distortion</b>	32 dB below PEP.
<b>Undesired Sideband Suppression</b>	55 dB at 1 kHz.
<b>Harmonic Suppression</b>	65 dB below PEP.
<b>Spurious Suppression</b>	65 dB below PEP.
<b>Audio Input</b>	Dynamic microphone. 600 ohm auxiliary input.
<b>Residual Noise Level</b>	50 dB below PEP.
<b>Audio Bandwidth</b>	2.4 kHz (standard), others optionally available. Automatic level control with companded voice processing.

**RECEIVER**

<b>Sensitivity</b>	SSB: 0.5 $\mu$ V for 10 dB SINAD; AM: 3 $\mu$ V for 10 dB SINAD.
<b>Audio Output</b>	5 watts with less than 5% distortion. 600 ohm auxiliary output.
<b>AGC Characteristics</b>	Audio output varies less than 2 dB for signals 10 $\mu$ V to 1 volt. Automatically selected dual time-constant AGC for voice or FSK/CW operation (standard).
<b>Selectivity</b>	SSB: 300 to 2700 Hz at 6 dB (standard). Others optionally available. AM: 6 kHz at 6 dB (standard).
<b>Image Rejection</b>	-70 dB.
<b>IF Rejection</b>	-80 dB.
<b>Intermodulation Distortion</b>	-80 dB.
<b>Desensitization</b>	100 dB (100 kHz separation).
<b>Spurious Response</b>	-70 dB.
<b>Squelch</b>	Syllabic, voice controlled, with noise immunity.
<b>Clarifier</b>	Digital $\pm$ 250 Hz (10 Hz steps).
<b>Overload Protection</b>	30 Vrms.
<b>Noise Blanker</b>	Impulse noise protection (optional).

*Because Harris engineers are continually striving to improve all aspects of our equipment, published specifications are subject to change without notice.*

## SPECIFICATIONS FOR RF-3281 ANTENNA COUPLER

## GENERAL

<b>Frequency Range</b>	1.6 to 30 MHz.
<b>Tuning Capability</b>	1.6 to 30 MHz: long-wires, dipoles, and 24 to 35 foot whips; 2.0 to 30 MHz: 16 foot whips; 4.0 to 30 MHz: 9 foot whips.
<b>RF Input Power</b>	125 watts PEP voice duty (30 watts average).
<b>Input Impedance</b>	50 ohms.
<b>Tuning Accuracy</b>	Less than 1.2:1 typical, 1.5:1 maximum.
<b>Tuning Mode</b>	Fully automatic
<b>Tuning Time</b>	30 msec tune from memory, 1 second typical in learn mode.
<b>Tune Memory</b>	321 channels, half-duplex or simplex; 16 random frequencies in Group F.
<b>RF Tune Power</b>	10 to 20 watts forward throughout tune cycle.
<b>Diagnostics/Protection</b>	Automatic cutback or bypass; over-temperature, over-voltage, excessive VSWR.
<b>Coupler Control</b>	All control and dc power is multiplexed on the RG-213/U coaxial cable.
<b>Remote Capability</b>	Up to 150-foot separation between transceiver and coupler. Optional bias tee permits extended range using dc power cable.
<b>Enclosure</b>	Sealed fiberglass enclosure for exposed installations.
<b>Primary Power Requirements</b>	13.6 Vdc $\pm$ 20%, 1.3 Amps. typical. Power supplied by RF-3200 Transceiver.
<b>Size</b>	5.5H x 11.4W x 13D inches (14.0H x 29.2W x 33.0D cm).
<b>Weight</b>	9.6 lbs. (4.4 kg).
<b>Connections</b>	Input (Transceiver): Type N (watertight), surge protection; Output (Antenna): Ceramic, high-voltage insulator, surge protection; Ground: ground lug.

## ENVIRONMENTAL

<b>Temperature</b>	-30°C to +60°C.
<b>Vibration</b>	MIL-STD-810D.
<b>Shock</b>	MIL-STD-810D.
<b>Humidity</b>	MIL-STD-810D.
<b>Enclosure</b>	MIL-STD-810D.

*Because Harris engineers are continually striving to improve all aspects of our equipment, published specifications are subject to change without notice.*

## PROPAGATION AND ANTENNA CONSIDERATIONS

To help get the maximum benefit from your RF-3200 system, the following information on propagation and antennas is provided.

### HF Radio Waves

Radio waves in the HF frequency band are propagated by either ground wave or sky wave.

The part of the transmitted signal that travels along the surface of the earth is called the ground wave. The ground wave reaches the receive station basically by line of sight and the higher the operating frequency the more it is attenuated. Therefore, ground wave communications are typically effective at distances between 1 and 100 miles when operating at frequencies below 4 MHz. The ground wave can travel at much greater distances over sea water than over average soil or dry, rocky land.

The part of the transmitted signal leaving the antenna at an angle above the earth's surface is called the sky wave. The sky wave is normally reflected back to the earth's surface by the ionosphere at a distant point (typically several thousand miles) from the transmitter. The distance that the transmitted signal travels is dependent on a number of factors discussed in the following paragraphs.

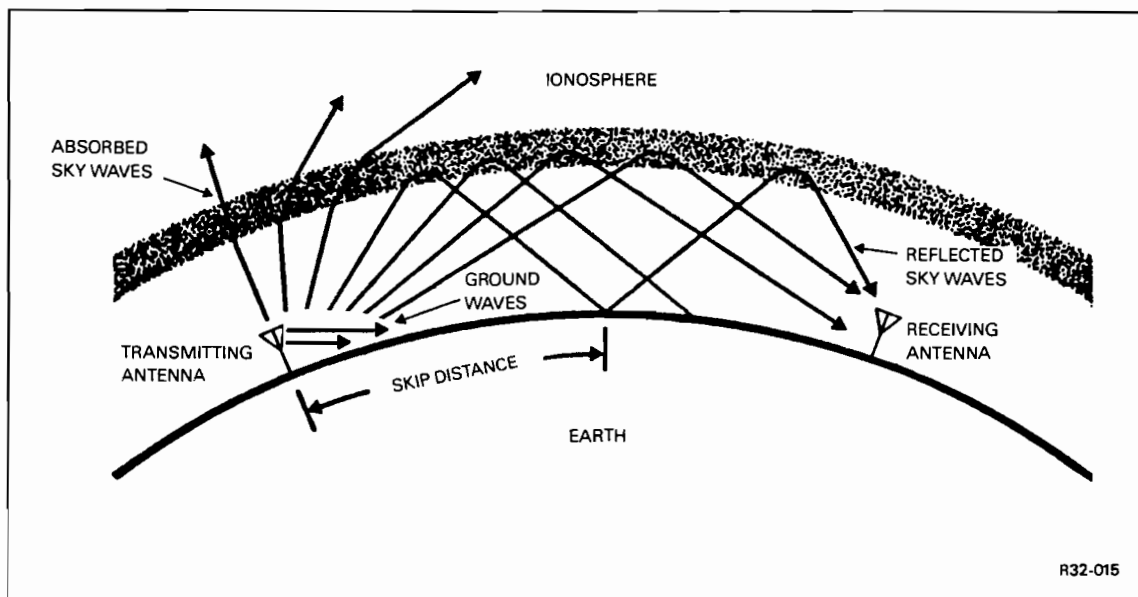

## ANTENNA SYSTEM

The antenna system is the most important element determining the distance of communications. Many factors affect the performance of the antenna system, most of which are practical considerations.

Some of the factors of the antenna system that will affect the communication distance are:

- Vertical or horizontal polarization.
- Surroundings (buildings, high power lines, generators, ground terrain, trees etc.).
- Frequency of operation.
- Available ground.
- Soil conductivity.

**NOTE:** A Harris representative should be contacted to help select the best antenna system for the specific application in question.

## OPERATING FREQUENCY

For a given path and time of day, an upper frequency limit exists called the maximum usable frequency (MUF). Above the MUF the signal is not reflected, but absorbed by the ionosphere; therefore, the higher the frequency, the less RF energy reaches the receiving station. In other words, for a given antenna system, the amount of radiated power is directly related to the operating frequency. The lower the frequency, the less power will be radiated, given the practical constraints of an antenna.

## GROUND PLANE

The ground plane of an antenna (with vertical polarization) affects the radiation pattern and efficiency of the antenna. If a good ground plane is not used, it will substantially reduce the communication range.

## TIME OF DAY

Since the ionosphere's density and location of reflecting layers are largely affected by the sun, the time of day will have a large affect on the angle of reflection or absorption by the ionosphere.

## WEATHER CONDITIONS

Weather conditions at both the transmitting and the receiving stations have an affect on the range of communication. Lightning is a major problem when communicating because it can cause a significant amount of noise which masks the received signal. Rain, sleet, and snow will absorb radiated energy from the transmitted signal, as well as affect the electrical properties of the antenna.



**SUNSPOT CYCLE**

The sun is the major source of energy that ionizes the earth's atmosphere. Therefore, any solar disturbance (such as sunspots) will produce variations in the ionosphere. The greater the number of sunspots, the greater the ionization and thus the more reflection of radio signals. The sunspot activity is a cyclic occurrence which repeats every 11.1 years. There are variations within this cycle and variations from cycle to cycle which make it necessary to know the predicted sunspot for a given time in order to determine the probability of skywave communication. The values of sunspot numbers range from about 5 during low periods to approximately 100 to 130 during high periods.

**SUDDEN IONOSPHERIC DISTURBANCES (SID)**

The effect of this condition is usually very sudden with recovery being more gradual. The condition may last from a few minutes to several hours. This condition is also known as a solar flare disturbance. The result of a SID is a sudden increase in the density of the highly absorptive part of the ionosphere, thus reducing the communication distance.

**REFERENCE INFORMATION**

**GROUP A (CHANNELS 0-120) USER PROGRAMMED CHANNEL LOG**

CH NO	TX FREQ	RX FREQ	MODE	COMMENTS
000				
001				
002				
003				
004				
005				
006				
007				
008				
009				
010				
011				
012				
013				
014				
015				
016				
017				
018				
019				
020				
021				
022				
023				
024				
025				
026				
027				
028				
029				
030				

GROUP A (CHANNELS 0-120) USER PROGRAMMED CHANNEL LOG

CH. NO.	TX FREQ.	RX FREQ.	MODE	COMMENTS
031				
032				
033				
034				
035				
036				
037				
038				
039				
040				
041				
042				
043				
044				
045				
046				
047				
048				
049				
050				
051				
052				
053				
054				
055				
056				
057				
058				
059				
060				

## REFERENCE INFORMATION

## GROUP A (CHANNELS 0-120) USER PROGRAMMED CHANNEL LOG

CH NO.	TX FREQ.	RX FREQ.	MODE	COMMENTS
061				
062				
063				
064				
065				
066				
067				
068				
069				
070				
071				
072				
073				
074				
075				
076				
077				
078				
079				
080				
081				
082				
083				
084				
085				
086				
087				
088				
089				
090				

GROUP A (CHANNELS 0-120) USER PROGRAMMED CHANNEL LOG

CH. NO.	TX FREQ.	RX FREQ.	MODE	COMMENTS
091				
092				
093				
094				
095				
096				
097				
098				
099				
100				
101				
102				
103				
104				
105				
106				
107				
108				
109				
110				
111				
112				
113				
114				
115				
116				
117				
118				
119				
120				

## GROUP A PREPROGRAMMED CHANNEL LOG

CHANNEL NUMBER	TX	RX
201-400 INVALID CHANNEL NUMBERS		
401	4065	4357
402	4068	4360
403	4071	4363
404	4074	4366
405	4077	4369
406	4080	4372
407	4083	4375
408	4086	4378
409	4089	4381
410	4092	4384
411	4095	4387
412	4098	4390
413	4101	4393
414	4104	4396
415	4107	4399
416	4110	4402
417	4113	4405
418	4116	4408
419	4119	4411
420	4122	4414
421	4125	4417
422	4128	4420
423	4131	4423
424	4134	4426
425	4137	4429
426	4140	4432
427	4143	4435
428	4060	4351
429	4354	4354
430-600 INVALID CHANNEL NUMBERS		
601	6200	6501
602	6203	6504
603	6206	6507
604	6209	6510
605	6212	6513
606	6215	6516
607	6218	6519
608	6221	6522
609-800 INVALID CHANNEL NUMBERS		
801	8195	8719
802	8198	8722
803	8201	8725
804	8204	8728
805	8207	8731
806	8210	8734
807	8213	8737

CHANNEL NUMBER	TX	RX
808	8216	8740
809	8219	8743
810	8222	8746
811	8225	8749
812	8228	8752
813	8231	8755
814	8234	8758
815	8237	8761
816	8240	8764
817	8243	8767
818	8246	8770
819	8249	8773
820	8252	8776
821	8255	8779
822	8258	8782
823	8261	8785
824	8264	8788
825	8267	8791
826	8270	8794
827	8273	8797
828	8276	8800
829	8279	8803
830	8282	8806
831	8285	8809
832	8288	8812
833	8291	8291
834	8707	8707
835	8710	8710
836	8113	8713
837	8128	8716
838-1200 INVALID CHANNEL NUMBERS		
1201	12230	13077
1202	12233	13080
1203	12236	13083
1204	12239	13086
1205	12242	13089
1206	12245	13092
1207	12248	13095
1208	12251	13098
1209	12254	13101
1210	12257	13104
1211	12260	13107
1212	12263	13110
1213	12266	13113
1214	12269	13116
1215	12272	13119
1216	12275	13122

**NOTE:** Radios may be configured to disable the preprogrammed channels.

GROUP A PREPROGRAMMED CHANNEL LOG

CHANNEL NUMBER	TX	RX
1217	12278	13125
1218	12281	13128
1219	12284	13131
1220	12287	13134
1221	12290	13137
1222	12293	13140
1223	12296	13143
1224	12299	13146
1225	12302	13149
1226	12305	13152
1227	12308	13155
1228	12311	13158
1229	12314	13161
1230	12317	13164
1231	12320	13167
1232	12323	13170
1233	12326	13173
1234	12329	13176
1235	12332	13179
1236	12335	13182
1237	12338	13185
1238	12341	13188
1239	12344	13191
1240	12347	13194
1241	12350	13197
1242-1600 INVALID CHANNEL NUMBERS		
1601	16360	17242
1602	16363	17245
1603	16366	17248
1604	16369	17251
1605	16372	17254
1606	16375	17257
1607	16378	17260
1608	16381	17263
1609	16384	17266
1610	16387	17269
1611	16390	17272
1612	16393	17275
1613	16396	17278
1614	16399	17281
1615	16402	17284
1616	16405	17287
1617	16408	17290
1618	16411	17293
1619	16414	17296
1620	16417	17299
1621	16420	17302

CHANNEL NUMBER	TX	RX
1622	16423	17305
1623	16426	17308
1624	16429	17311
1625	16432	17314
1626	16435	17317
1627	16438	17320
1628	16441	17323
1629	16444	17326
1630	16447	17329
1631	16450	17332
1632	16453	17335
1633	16456	17338
1634	16459	17341
1635	16462	17344
1636	16465	17347
1637	16468	17350
1638	16471	17353
1639	16474	17356
1640	16477	17359
1641	16480	17362
1642	16483	17365
1643	16486	17368
1644	16489	17371
1645	16492	17374
1646	16495	17377
1647	16498	17380
1648	16501	17383
1649	16504	17386
1650	16507	17389
1651	16510	17392
1652	16513	17395
1653	16516	17398
1654	16519	17401
1655	16522	17404
1656	16525	17407
1657-1800 INVALID CHANNEL NUMBERS		
1801	18780	19755
1802	18783	19758
1803	18786	19761
1804	18789	19764
1805	18792	19767
1806	18795	19770
1807	18798	19773
1808	18801	19776
1809	18804	19779
1810	18807	19782
1811	18810	19785

NOTE: Radios may be configured to disable the preprogrammed channels.

## GROUP A PREPROGRAMMED CHANNEL LOG

CHANNEL NUMBER	TX	RX
1812	18813	19788
1813	18816	19791
1814	18819	19794
1815	18822	19797
1816-2200 INVALID CHANNEL NUMBERS		
2201	22000	22696
2202	22003	22699
2203	22006	22702
2204	22009	22705
2205	22012	22708
2206	22015	22711
2207	22018	22714
2208	22021	22717
2209	22024	22720
2210	22027	22723
2211	22030	22726
2212	22033	22729
2213	22036	22732
2214	22039	22735
2215	22042	22738
2216	22045	22741
2217	22048	22744
2218	22051	22747
2219	22054	22750
2220	22057	22753
2221	22060	22756
2222	22063	22759
2223	22066	22762
2224	22069	22765
2225	22072	22768
2226	22075	22771
2227	22078	22774
2228	22081	22777
2229	22084	22780
2230	22087	22783

CHANNEL NUMBER	TX	RX
2231	22090	22786
2232	22093	22789
2233	22096	22792
2234	22099	22795
2235	22102	22798
2236	22105	22801
2237	22108	22804
2238	22111	22807
2239	22114	22810
2240	22117	22813
2241	22120	22816
2242	22123	22819
2243	22126	22822
2244	22129	22825
2245	22132	22828
2246	22135	22831
2247	22138	22834
2248	22141	22837
2249	22144	22840
2250	22147	22843
2251	22150	22846
2252	22153	22849
2253	22156	22852
2254-2500 INVALID CHANNEL NUMBERS		
2501	25070	26145
2502	25073	26148
2503	25076	26151
2504	25079	26154
2505	25082	26157
2506	25085	26160
2507	25088	26163
2508	25091	26166
2509	25094	26169
2510	25097	26172
2511-9999 INVALID CHANNEL NUMBERS		









**GLOSSARY**

---

**AGC** - Automatic Gain Control

---

**AM** - Amplitude Modulation

---

**AME** - Amplitude Modulation Equivalent (H3E)

---

**CW** - Continuous Wave (J2A)

---

**FSK** - Frequency Shift Keying

---

**Half-Duplex** - Receiver and transmitter operate on different frequencies using one antenna

---

**LED** - Light Emitting Diode

---

**LSB** - Lower Sideband

---

**PA** - Power Amplifier

---

**PCS** - Partial Carrier Suppression (R3E)

---

**PEP** - Peak Envelope Power

---

**PTT** - Push To Talk

---

**RX** - Receive

---

**Simplex** - Receiver and transmitter operate on the same frequency

---

**SINAD** - Measurement of signal quality

---

**S/N** - Signal-to-noise ratio

---

**SSB** - Single Sideband

---

**S-UNITS** - Signal Strength measurement units

---

**SWR** - Standing Wave Ratio

---

**TX** - Transmit

---

**VSWR** - Voltage Standing Wave Ratio

---

**USB** - Upper Sideband (J3E)

---

**VFD** - Vacuum Fluorescent Display

---

## OPTIONS

Supplied information on the options ordered with your radio should be inserted in this section. The pages supplied have T-Slots on the binding edge for easy insertion. When inserting pages, line up the T-slotted edge with the wire binding and press down on the slots.

OPTIONS

**OPTIONS AND ACCESSORIES AVAILABLE****RF-3200 OPTIONS:**

**RF-3209 Noise Blanker** - Improves received signal-to-noise ratio in high impulse-type noise environments. Automatically adjusts for changes in received signal strength and is immune to false triggering by out-of-band interfering signals.

**RF-3234 Remote Control** - Provides channelized operation of the radio from a remote location. Maximum separation of transceiver and remote control unit is 125 feet (38 m).

**RF-3246 Narrow Band Filter** - Provides a 300 Hz bandwidth for enhanced CW or narrowband data operation.

**RF-3247 Wide Band FSK Filter** - Provides upper sideband response from 350 to 3150 Hz. Should be ordered when operating with RF-3466 High-Speed Data Modem or with external FSK Keyer/Converter centered on 2000 Hz with  $\pm 425$  Hz shift. Factory installed only.

**RF-3253 Two-Tone Alarm** - Provides automatic transmission of programmed two-tone distress signal and automatically tunes the radio when energized.

**RF-3238 Continuous Duty Blower Kit** - Mounts over the RF-3200 Transceiver heat sink to provide 125-watt average power rating for FSK/ARQ operation.

**ANTENNA COUPLERS:**

**RF-3281 Voice-Duty Automatic Coupler** - 1.6-30 MHz range, tunes into whip, dipole, long-wire, and loop antennas. Typical tuning time is 1 second in learn mode and 30 msec maximum from memory. Connects to the radio with only one coax cable (RG-213/U) as all signals are multiplexed on the RF cable. Separation between transceiver and coupler can be up to 150 feet (46m). A mounting bracket is also available to make the RF-3281 fit the RF-281 footprint.

**RF-382-01 Continuous Duty Automatic Coupler** - 1.6-30 MHz range, 500 Watt PEP/250 Watt average continuous-duty rated antenna coupler. Tunes into whip, dipole, long-wire, and loop antennas. Typical tuning time is 1 second in learn mode and 25 msec from memory. Separation between transceiver and antenna coupler can be up to 250 feet. Requires RF-3220 Coupler/1 kW Interface Kit.

**RF-601A 1 kW Automatic Coupler** - 2.0-30 MHz range, tunes into 15-35 foot whip antennas. Requires RF-625A adapter for long-wire and RF-1912/1912A dipole antennas. Tuning time is 5 seconds. Separation between transceiver and antenna coupler can be up to 500 feet. For use with the RF-3200-10 1 kW System. Requires RF-3220 Coupler/1 kW Interface Kit.

**RF-2601 1 kW Fast-Tune Antenna Coupler** - Automatically matches the output of 1 kW transceivers and transmitters to a wide variety of whip, dipole, and long-wire antennas over the frequency range of 1.6-30 MHz. An RF-625A Long-Wire Adapter is necessary for use with long-wire antennas of more than 75 feet. Microprocessor controlled with 512-channel memory. Features 50-millisecond tuning from memory. Separation between antenna and transmitter can be up to 500 feet (152 m). Requires lengths of RF-322 multi-conductor control cable, and RF-3220 Coupler/1 kW Interface Kit.

**RF-3281 ARQ -Duty Automatic Digital Antenna Coupler** - For 125-watt ARQ data applications with the RF-3200. Similar to RF-3281, except with built-in demand cooling. Allows 125 watt operation at 50% duty cycle into all antennas longer than 24 feet (7.3m). Order Service Manual 10228-0300 separately.

*NOTE: See back of this section for ordering information.*

**TRANSCEIVER SYSTEMS:**

**RF-3200-10 1 kW Transceiver Rack** - Integrates an RF-3200 Transceiver and an RF-3230 1 kW Linear Power Amplifier. Provides 1 kW PEP and average power output over the 1.6-30 MHz range. Automatically controlled from the radio. Power input is 115-230 VAC  $\pm$  15%, 50/60 Hz.

**RF-3244-01** - Integrates an RF-3200 Transceiver with an RF-3236 Power Supply in an RF-3244 Rack Mount. The complete subsystem is designed for installation in a standard 19-inch rack. The subsystem is 7 inches high and 24 inches deep. The RF-3238 Continuous Duty Blower Kit should be ordered for use in high average power operating conditions such as FSK, Packet, or High Speed Data systems.

**RF-3200T HF-SSB Transportable Communications System** - Completely integrated transportable HF system, for quick deployment. Consists of the RF-3200 Transceiver, RF-3281T Automatic Digital Antenna Coupler, built-in AC power supply, and RF-1940 Portable Dipole/Long-Wire Antenna. The system is packaged in a rugged black suitcase, which will fit under an airline seat. It can be powered from 12 VDC or 115/230 VAC. Prices includes RF-3209 Noise Blanker, microphone grounding wire, DC power cable kit with battery clips, operator's manual, international AC power adapters, and an accessory bag. Order service manual 10262-0300 separately.

**RF-3211 Emergency Deployment RF-3200 HF-SSB System** - Provides complete 125 watt HF-SSB Transceiver System that can be quickly ordered, shipped, and set up to provide emergency operation. Kit consists of RF-3200 Transceiver, RF-3236 Power Supply, RF-3281 Automatic Antenna Coupler, RF-1940 Portable Dipole/Long-Wire Antenna, and all necessary interconnecting cables. Can be operated on 12 VDC or 115/230 VAC. Price includes RF-3209 Noise Blanker, microphone, grounding wire, DC power cable with battery clips, operator's manual, international AC power adapters, and accessory bag.

**POWER SUPPLY OPTIONS:**

**RF-3206 Battery Float Charger** - Provides the capability of operating the radio from an external 12 VDC (nominal) deep-discharge battery, such as the RF-4758. The radio is connected to the battery which is charged by the RF-3206 during normal AC operation. If AC power fails, the battery provides more than 10 hours of operation, when using a 4-to-1 (receive-to-transmit) duty cycle.

**RF-3236 Base Unit Power Supply Continuous Duty** - Allows operation of the radio from a 115/230 VAC, 50/60 Hz source.

**RF-3259 24 VDC/12 VDC Power Converter** - Provides the capability of operating the radio from an external 24 VDC battery.

**RF-4758 Heavy-Duty, Deep Discharge Battery** - 93 AH Lead acid battery for use with the RF-3206 Battery Float Charger.

**RF-3200 TBP Transportable Battery Pack** - 13.6 VDC, 25A battery provides at least 5 hours of operation (10% transmit) of an RF-3200 or RF-3200T. The built-in, dual-rate charger operates from 115/230 VAC, 50-60 Hz power and is thermally protected.

**MOUNTING OPTIONS:**

**RF-3241 Shock Mount** - Recommended for environments where unusually severe shock or vibrations are encountered.

**RF-3243 Rack Mounting Kit** - Enables the radio to be mounted in a standard 19 inch rack.

**RF-3260 Mounting Cradle** - "U" shaped cradle allows mounting of the radio to flat surfaces.

**RF-3244 Heavy Duty Rack Mounting Kit** - Rugged 19-inch rack mount for both the RF-3200 and RF-3236. The unit consists of a sturdy sheet metal tray, with full support on all corners. It mounts front-to-rear on 21-inch spaced cabinet rails. The front panel is 7-inches high, and includes space for the RF-3200 front panel, a filtered air intake, and a 1/4-inch CW jack with extension cable. Overall depth is 24 inches. The RF-3244 is slide-mounted to provide easy access and maintenance. This rack mount is recommended for most installations.

**AUDIO AND DATA ACCESSORIES:**

**RF-3207 CW KEY** - Includes key, cable, and plug for use with the radio's rear panel CW jack.

**RF-3003 Headset** - Recommended for private listening. Useful in areas with high ambient noise levels. Includes plug for use with the radio's phone jack.

**RF-3249 Desk Microphone** - Base station type microphone sits flat on a desktop.

**RF-3250 Telephone Handset (Wall Mount)** - Includes hook switch and hanging cradle. Speaker muted for privacy when handset is removed from cradle.

**RF-3251 Telephone Handset (Desk Mount)** - Includes desk cradle. Speaker muted for privacy when handset is removed from cradle.

**RF-3204 Remote Speaker** - Includes trunion mount and 5 foot (1.5 m) interconnecting cable.

**RF-3252 Dynamic Hand Microphone** - Includes coil cord and connector. Supplied as standard equipment with the RF-3200.

**RF-901A VOX/Hybrid Phone Patch** - Provides telephone interface with any transmitter, receiver, or transceiver. Order 10212-3330 Interface Kit for use with RF-3200 Series Transceivers.

**RF-3466 High-Speed Data Modem** - High-speed signal processing, up to 2400 bits per second, forward error correction, 115/230 Vac power input.

**ANTENNA COUPLER OPTIONS:**

**RF-3288 Coupler Mounting Bracket Kit** - Adapts the RF-3281 Antenna Coupler to the RF-281, RF-382 series mounting footprint.

**SPARE PARTS KITS:** (See Spare Parts Kit Section for details.)

**RF-3200/RSK** - Running Spares Kit for RF-3200 Transceiver.

**RF-3281/RSK** - Running Spares Kit for RF-3281 Digital Coupler.

**RF-3200/SSK** - Site Spare Parts Kit for RF-3200 Transceiver.

**RF-3281/SSK** - Sites Spare Parts Kit for RF-3281 Digital Coupler.

**RF-3200/ARK** - Assembly Repair Kit for RF-3200 Transceiver.

**RF-3281/ARK** - Assembly Repair Kit for RF-3281 Digital Coupler.

**TECHNICAL SERVICE MANUALS:**

10212-0300 RF-3200 Transceiver Technical Manual

10228-0300 RF-3281 Antenna Coupler Technical Manual

10262-0300 RF-3200T System Technical Manual



**RF-3200 USER'S GUIDE EVALUATION FORM**

**Manual Title: RF-3200 User's Guide**  
**Pub. No.: 10212-0050**

Harris Corporation, RF Communications Group, continually evaluates its technical publications for completeness, technical accuracy, and organization. You can assist in this process by completing and returning this form.

NAME	DATE
COMPANY/ORGANIZATION	
ADDRESS	
CITY	STATE
ZIP	COUNTRY
PHONE NO. (PLEASE INCLUDE AREA CODE)	

**GENERAL COMMENTS:** Please include your suggestions for improvements to the manual. Specify section, page, paragraph, figure number or table number as applicable. Attach samples or extra pages if more space is needed.

GENERAL	EXCELLENT	GOOD	FAIR	POOR
TEXT	<input type="checkbox"/>	<input type="checkbox"/>	<input type="checkbox"/>	<input type="checkbox"/>
INSTALLATION INSTRUCTIONS	<input type="checkbox"/>	<input type="checkbox"/>	<input type="checkbox"/>	<input type="checkbox"/>
OPERATION INSTRUCTIONS	<input type="checkbox"/>	<input type="checkbox"/>	<input type="checkbox"/>	<input type="checkbox"/>
TABLES	<input type="checkbox"/>	<input type="checkbox"/>	<input type="checkbox"/>	<input type="checkbox"/>
ILLUSTRATIONS	<input type="checkbox"/>	<input type="checkbox"/>	<input type="checkbox"/>	<input type="checkbox"/>
TROUBLESHOOTING INFORMATION	<input type="checkbox"/>	<input type="checkbox"/>	<input type="checkbox"/>	<input type="checkbox"/>
REFERENCE INFORMATION	<input type="checkbox"/>	<input type="checkbox"/>	<input type="checkbox"/>	<input type="checkbox"/>

**GENERAL INFORMATION AND INSTALLATION:**

**OPERATION:**

**PROGRAMMING AND CONFIGURATION:**

**DISPLAY MESSAGES:**

**CARE AND TROUBLESHOOTING:**

**REFERENCE INFORMATION:**

**OPTIONS:**

▲ TEAR HERE ▲

▼ FOLD HERE ▼

\_\_\_\_\_  
\_\_\_\_\_  
\_\_\_\_\_

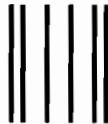

NO POSTAGE  
NECESSARY  
IF MAILED  
IN THE  
UNITED STATES

▲ TEAR HERE ▲

**BUSINESS REPLY MAIL**  
FIRST-CLASS MAIL PERMIT NO. 4033 ROCHESTER, N.Y.

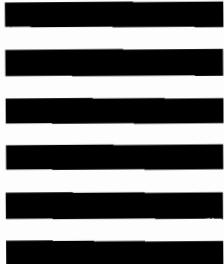

POSTAGE WILL BE PAID BY ADDRESSEE

**HARRIS CORPORATION**  
**RF Communications Group**  
Attn: Manager, Publications Dept.  
1680 University Avenue  
Rochester, New York 14610-9983



▲ TEAR HERE ▲

▲ PLEASE FOLD HERE ▲, AND SEAL WITH TAPE.

**RF-3200 INFORMATION ORDER FORM**

NAME \_\_\_\_\_ DATE \_\_\_\_\_

COMPANY/ORGANIZATION \_\_\_\_\_

ADDRESS \_\_\_\_\_

CITY \_\_\_\_\_ STATE \_\_\_\_\_

ZIP \_\_\_\_\_ COUNTRY \_\_\_\_\_

PHONE NO. (PLEASE INCLUDE AREA CODE) \_\_\_\_\_

- Have a sales representative call me.
- Please send product information on the following options and accessories

Check here



**RF-3200 Options:**

- RF-3209 Noise Blanker ..... \_\_\_\_\_
- RF-3234 Remote Control ..... \_\_\_\_\_
- RF-3246 CW Filter ..... \_\_\_\_\_
- RF-3247 Wide Band Data Filter ..... \_\_\_\_\_
- RF-3253 Two-tone Alarm ..... \_\_\_\_\_

**Antenna Couplers:**

- RF-3281 125 Watt Voice Duty Automatic Coupler ..... \_\_\_\_\_
- RF-382-01 500 Watt Fast Tune Automatic Coupler ..... \_\_\_\_\_
- RF-601A 1 kW Automatic Coupler ..... \_\_\_\_\_
- RF-2601 1 kW Fast-Tune Antenna Coupler ..... \_\_\_\_\_

**Antenna Coupler Options:**

- RF-3288 Mounting Bracket Kit ..... \_\_\_\_\_
- 10228-3110 Power Cable Kit ..... \_\_\_\_\_

**Power Amplifier:**

- RF-3230 1 kW Linear Power Amplifier ..... \_\_\_\_\_

**Power Supply Options:**

- RF-3206 DC Power Supply/Float Battery Charger ..... \_\_\_\_\_
- RF-3236 Base Unit Power Supply ..... \_\_\_\_\_
- RF-3259 24 Vdc/12 Vdc Power Converter ..... \_\_\_\_\_
- RF-4758 Heavy-Duty, Deep Discharge Battery ..... \_\_\_\_\_

**Mounting Options:**

- RF-3241 Shock Mount ..... \_\_\_\_\_
- RF-3234 Rack Mounting Kit ..... \_\_\_\_\_
- RF-3260 Mounting Cradle ..... \_\_\_\_\_

**Microphone/Telephone Handset Options:**

- RF-3249 Desktop Microphone ..... \_\_\_\_\_
- RF-3250 Telephone Handset (Wallmount) ..... \_\_\_\_\_
- RF-3251 Telephone Handset (Desk Mount) ..... \_\_\_\_\_

**Miscellaneous Items:**

- RF-3207 CW Key ..... \_\_\_\_\_
- RF-3003 Headphones ..... \_\_\_\_\_

**Antenna Options:**

**Manuals:**

- RF-3200 Technical Service Manual (P.N. 10212-0300) ..... \_\_\_\_\_
- RF-3200 Operator Card (P.N. 10212-0051) ..... \_\_\_\_\_
- RF-3281 Technical Service Manual (P.N. 10228-0300) ..... \_\_\_\_\_
- RF-3200T System Technical Manual (P.N. 10262-0300) ..... \_\_\_\_\_

10212-0300-01  
 10212-0051-01  
 10228-0300-01  
 10262-0300-01

▲ TEAR HERE ▲

▼ FOLD HERE ▼

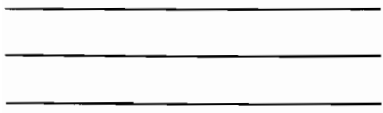

NO POSTAGE  
NECESSARY  
IF MAILED  
IN THE  
UNITED STATES

▲ TEAR HERE ▲

**BUSINESS REPLY MAIL**  
FIRST-CLASS MAIL PERMIT NO. 4033 ROCHESTER, N.Y.

POSTAGE WILL BE PAID BY ADDRESSEE

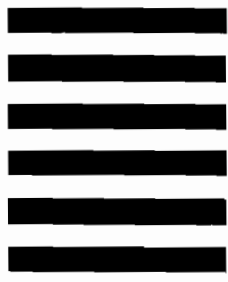

**HARRIS CORPORATION**  
**RF Communications Group**  
Attn: Product Marketing Department, LRRD  
1680 University Avenue  
Rochester, New York 14610-9983



▲ TEAR HERE ▲

▲ PLEASE FOLD HERE ▲, AND SEAL WITH TAPE.

# RF-3272 ALE OPTION SUPPLEMENT

This Supplement contains information for the RF-3200 User's Guide. This Option enables the RF-3200 to conduct Link Quality Analysis (LQA) and Automatic Link Establishment (ALE)

RF-3272 ALE OPTION  
SUPPLEMENT

**GENERAL INFORMATION:**

Introduction .....	1-1
Automatic Link Establishment .....	1-1
Link Quality Analysis .....	1-1
Calls .....	1-1

**OPERATIONAL OVERVIEW:**

Channel Scanning .....	2-1
Calls .....	2-1
Individual Calls .....	2-1
Net Calls .....	2-1
All Calls .....	2-2
Link Quality Analysis (LQA) .....	2-2
Sounding LQA .....	2-2
Exchange LQA .....	2-2
Channel Groups .....	2-2

**OPERATION:**

ALE Display and Indicators .....	3-1
ALE Front Panel Indications .....	3-1
Entering and Exiting ALE Operation .....	3-2
Scan Operation .....	3-2
Calls .....	3-3
Placing An Auto Call .....	3-3
Placing A Manual Call .....	3-4
Calling The Last Station Called .....	3-5
Terminating Calls .....	3-5
Link Quality Analysis .....	3-5
Manual LQA Exchanges .....	3-5
Manual LQA Sounds .....	3-6

**PROGRAMMING:**

Overview .....	4-1
Individual Addresses .....	4-2
Entering ALE Programming .....	4-2
To Add Channels To Individual Addresses .....	4-2
To Delete Channels From An Individual Address .....	4-3
Net Addresses .....	4-4
To Add Individual Addresses And Channels To Net Addresses .....	4-4
To Delete Individual Addresses And Channels From Net Addresses .....	4-5

**CONFIGURATION:**

Overview .....	5-1
Parameter Description .....	5-2
Configuration Parameters .....	5-3
Changing Parameter Values .....	5-3

**ALE ERROR MESSAGES:**

ALE Error Messages .....	6-1
--------------------------	-----

## INTRODUCTION

The RF-3272 is a plug-in, automatic link establishment option for the RF-3200 Transceiver. Operation is compatible with MIL-STD-188-141 A Appendix A and FED-STD-1045. The ALE option provides automatic HF frequency management through these features:

- Ability to automatically find the best operating channel for communication with a process called Link Quality Analysis (LQA)
- Automatic Link Establishment (ALE) on the best channel based on the LQA. Two or more stations are "linked" when they have stopped to communicate on a common channel.
- Ability to selectively call one station, a set of stations, or all stations that can receive the call.

## AUTOMATIC LINK ESTABLISHMENT

The RF-3272 simplifies communications by automatically performing channel evaluations and ALE which are normally done by radio operators. An ALE is the automatic selection of the best available channel to be used for a communications link with one or more remotely located stations. The best channel to be used depends on a number of factors, including the following:

- Distance between the local station and remote station
- Time of day
- Presence of noise or radio interference on the channels

## LINK QUALITY ANALYSIS

The RF-3272 ALE option selects the best channel for communication using LQA. An LQA is the measurement of the quality of signals between two or more HF radio stations. The LQA data is used to rank the channels from best to worst. The following two types of LQAs are possible:

- LQA sounds, where short, one-way broadcast messages are sent at periodic intervals by the calling station on all channels programmed into it. The receive quality of the messages are measured and recorded by the remotely located stations.
- LQA exchanges, where receive quality information is exchanged between the initiating station and the remotely located stations.

## CALLS

The RF-3272 ALE option can communicate and establish a link with a single station, a set of stations, or all stations that can receive it. Calls can be placed with the two following methods:

- Auto calls, where the RF-3272 selects the best channel, using the ALE feature
- Manual calls, where the operator selects the channel

Calls can be placed manually or automatically from the RF-3272 ALE option to the following addresses:

- Individual addresses, where a link is made to one station
- Net addresses, where a link is made to a group of stations
- All call addresses, where a one-way broadcast call is made which does not require an answer to link to stations

**NOTES:**

[Empty rectangular box for notes]



## CHANNEL SCANNING

The RF-3272 places and receives calls on channels programmed for the RF-3200. Scanning is performed on all channels the radio may be called on. When the radio is scanning, it can receive a call from any station on any channel.

Each station must be programmed to assign channels to every individual and net address it wishes to call. When calling an individual station, the RF-3272 only uses the channels assigned to that station's address. When calling a network of stations, the RF-3272 only uses the channels assigned to that net's address.

The RF-3272 can receive individual calls on the channels assigned to its self address, and can receive net calls on the channels assigned to any of the net addresses programmed into it. Because the ALE option receives calls on both types of addresses, it scans the sum of all the channels assigned to its own self address, as well as all the channels assigned to all the net addresses programmed into it.

## CALLS

Calls are placed using either manual or automatic channel selection. With auto calls, the RF-3272 selects the best channels. The channels are tried in order from best to worst. If an auto call is not linked on the first channel tried, the RF-3272 will step through the rest of the channels until it links or reaches the end of the list. With manual calls, the operator selects the channel.

The RF-3272 places manual or auto calls, using a three-digit dialing technique, to address numbers of the following three types:

- Individual addresses whose values range from 100 to 199
- Net addresses whose values range from 300 to 319
- The all call address whose address is 900

In this supplement, the use of these addresses is identical to their use in MIL-STD-188-141A and FED-STD-1045. The RF-3272 can also receive the remainder of call types: group calls, selective allcalls, anycalls, selective anycalls, and wildcard calls.

### Individual Calls

An individual call uses an individual address and establishes a link with one station. These calls can be placed to any individual station whose communication channels have been identified and programmed. With individual calls, both initiator and target stations receive confirmation that a link occurred, and the target station displays the calling station's address. While setting up the link, both stations update their channel quality measurements by exchanging LQA information.

Every station in a system has a self-address which identifies the radio to other stations. An individual address is a self address of another radio. When programming an individual address into a radio, the operator is actually programming the self addresses of other stations in the system.

### Net Calls

A net is a pre-arranged set of individual stations. A net call makes a link with several stations, all programmed to be members of the net, using a common set of channels. When a call is placed, the calling station will try to link with all member stations. If some of the stations do not answer the call, a link will still be made with those that do.

Network configuration information must be programmed into every station that is planned to be a member of the net.

## All Calls

An allcall makes a link with all stations who hear the initiator. This is a broadcast call that neither requests an answer nor calls a specific individual or net.

## LINK QUALITY ANALYSIS (LQA)

The RF-3272 selects the best channel for communications using link quality analysis (LQA). LQA measures the signal quality of the channels shared by two or more stations. The LQA data is used to rank the channels from best to worst. Two types of link quality analysis methods are used as shown below:

- Sounding Link Quality Analysis
- Exchange Link Quality Analysis

The RF-3272 can initiate LQAs automatically at timed intervals or manually on operator command. Automatic LQAs are scheduled to start at a specific time and repeat at times afterward. Manual LQAs are performed only once. They may be done in between automatic LQAs without affecting the automatic LQA schedule.

### Sounding LQA

The sounding LQA method uses short one-way broadcast messages sent at periodic intervals by the calling station on all programmed channels. In the message, the sending station identifies itself to all others who are listening so they may determine how well they receive the calling station on each channel. The calling station does this by transmitting its self address. The receiving station(s) detects the message, stops scanning, measures it, and stores the received signal quality as a score. Separate measurements are stored for every calling station on every channel on which they are received.

### Exchange LQA

The LQA exchange uses a message exchange between stations which measures and exchanges channel quality information. This differs from LQA sounding because both the initiating and target stations exchange each others link quality information during the LQA. An LQA exchange may be performed between two individual stations or between several stations in a network.

The LQA exchange gives a better measure of channel quality since it evaluates both the receive and transmit paths. LQA sounds evaluate only the receive path, but they are faster because they do not require the receiving stations to key up and transmit a response.

## CHANNEL GROUPS

The RF-3272 uses channel groups to simplify operation and allow prioritization (order of channels of importance) of communications channels. Ten groups, groups 1 through 9 and group A, are supported in ALE operation. Group A contains all channels, and groups 1 through 9 are subsets of group A. Refer to the Programming and Configuration section of the RF-3200 manual for channel group programming.

The groups are useful for the following:

- Day/night operation where it may be desirable to change the set of channels
- Quick, easy, network modification in emergency

When making a call or LQA, the radio uses the channels common to the current channel group and the individual or net address being called.

---

## ALE DISPLAY AND INDICATORS

## ALE Front Panel Indications

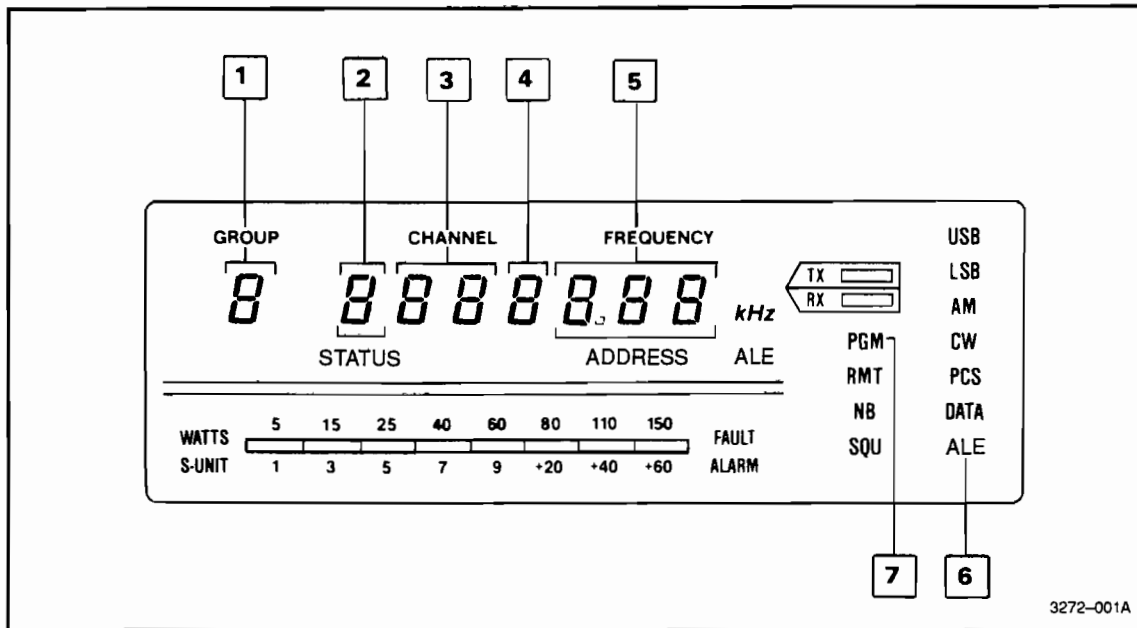

1. GROUP INDICATOR – Displays groups 1-9 and A in all operations. Group F (frequency access) is not available during ALE operation.
2. STATUS INDICATOR – Informs operator of ALE status as follows:
 

"C" (flashing)	Radio is calling another station
"C" (steady)	Calling radio connected to another station
"F" (flashing)	Call is being received from another station
"F" (steady)	Receiving radio is connected to another station
"L"	Radio is performing LQA exchange
"b"	Radio is performing LQA sound
3. CHANNEL FIELD INDICATOR – Displays the current channel and the channel being used to place a call.
4. PROGRAMMING STATUS INDICATOR – Displays a "c" when programming to indicate individual or net information has changed but not permanently loaded into memory.
5. ADDRESS INDICATOR – (a) Displays the address of the station being called or the address of the calling station. Also displays station address during programming. (b) When scanning, the left two digits display "Sc."
6. ALE INDICATOR – Indicates the RF-3200 is in ALE operation when lit.
7. PGM INDICATOR – Indicates the RF-3200 is in the program operation when lit.

### ENTERING AND EXITING ALE OPERATION

ALE operation can be entered in two different ways as follows:

- Upon power up, the radio automatically enters ALE operation and starts scanning if it is programmed. If it is not programmed, an error message is displayed. See the programming section of this supplement for instructions.
- ALE operation can be turned on and off from the front panel.

To exit ALE operation, do the following steps:

**NOTE:** ALE operation cannot be turned off if the radio is linked or scanning. Press the SCAN button to stop scanning channels, or press the CLR key to unlink the radio from another station.



1. PRESS THE OPTION KEY SEVERAL TIMES until "ALE On" is displayed.



2. PRESS THE \* KEY until "ALE OFF" is displayed.



3. PRESS THE OPTION KEY again to return to standard radio operation. The ALE indicator will extinguish, and the display will show a channel number and group indicator.

To enter ALE operation, do the following steps:



1. PRESS THE OPTION KEY until "ALE OFF" is displayed.



2. PRESS THE \* KEY until "ALE ON" is displayed. The ALE lamp will light, and the radio will start scanning. An error message will be displayed if addresses have not been programmed.

**NOTE:** ALE operation cannot be entered while in full frequency operation (group F). An error tone will be heard if the operator attempts this.

### SCAN OPERATION

To stop scanning, do the following:

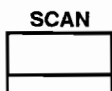

1. PRESS THE SCAN BUTTON. The radio will display the last station address used.

To start scanning, do the following:

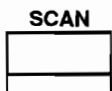

2. PRESS THE SCAN BUTTON. The radio will display "Sc" and the channel numbers being scanned.

## CALLS

Calls can be performed in the following three ways:

- Automatically – where the radio selects the best channel
- Manually – where the operator selects a channel
- Using the “last station called” feature – which simplifies repeated calls to the same station

All of the above calls are terminated the same way.

**NOTE:** If there are no channels in common to the current group and the address called, transmit error tones will be heard when placing the call.

### Placing An Auto Call

To place an auto call, do the following steps:

**NOTE:** A call cannot be placed if the radio is linked or scanning. Press the SCAN button to stop scanning channels, or press the CLR key to unlink the radio from another station.

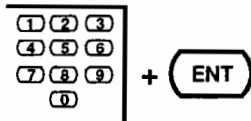
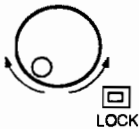
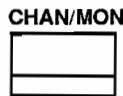

1. PRESS THE CHAN/MON BUTTON SEVERAL TIMES until only the addresses are displayed.
2. SELECT THE DESIRED INDIVIDUAL (100-199), NET (300-319), OR ALLCALL (900) in one of the following two ways:

- a. ROTATE THE TUNING KNOB until the desired address appears.

OR

- b. TYPE THE DESIRED ADDRESS ON THE KEYPAD; PRESS THE ENT KEY. Use the CLR key to clear any mistakes.

3. INITIATE THE CALL in one of the following two ways:

- a. PRESS THE CALL KEY.

OR

- b. PRESS THE MICROPHONE PUSH-TO-TALK KEY.



The status indicator will show a flashing “C” while the call is being placed. The indicator will show a steady “C” when the link is made. The link is now ready for voice or data communications.

### Placing A Manual Call

To place a manual call, do the following steps:

**NOTE:** A call cannot be placed if the radio is linked or scanning. Press the SCAN button to stop scanning channels, or press the CLR key to unlink the radio from another station.

CHAN/MON

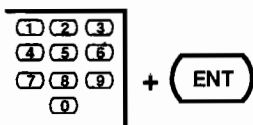
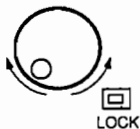
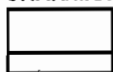

CHAN/MON

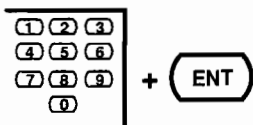
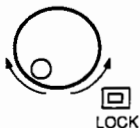
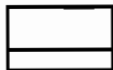

CALL



1. PRESS THE CHAN/MON BUTTON SEVERAL TIMES until only the addresses are displayed.
2. SELECT THE DESIRED INDIVIDUAL (100-199), NET (300-319), OR ALLCALL (900) in one of the following two ways:
  - a. ROTATE THE TUNING KNOB until the desired address appears.

OR

- b. TYPE THE DESIRED ADDRESS ON THE KEYPAD; PRESS THE ENT KEY. Use the CLR key to clear any mistakes.

3. PRESS THE CHAN/MON BUTTON several times until the channel numbers appear in the display.
4. SELECT THE DESIRED CHANNEL in one of the following two ways:

- a. ROTATE TUNING KNOB until the desired channel appears.

OR

- b. TYPE THE DESIRED CHANNEL ON THE KEYPAD; PRESS THE ENT KEY. Use the CLR key to clear any mistakes.

5. INITIATE CALL in one of the following two ways:

- a. PRESS THE CALL KEY.

OR

- b. PRESS THE MICROPHONE PUSH-TO-TALK KEY.

The status indicator will show a flashing "C" while the call is being placed. The indicator will show a steady "C" when the link is made.

### Calling The Last Station Called

To call the last station called, do the following steps:



WHILE SCANNING, PRESS THE MICROPHONE PUSH-TO-TALK KEY. The radio will call the same station using the same method (auto or manual) as the last call.

### Terminating Calls

1. When the call is over, terminate the call in one of the following two ways:

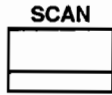

- a. PRESS THE SCAN BUTTON to return both the calling and called stations to scanning operation.

OR



- b. PRESS THE CLR KEY to return only the called station to scanning, and leave the calling station on the same channel.

### LINK QUALITY ANALYSIS

LQA exchanges and sounds can be either manual or automatic:

- Manual LQAs are started by the operator. These LQAs are described in this section.
- Automatic LQAs are programmed. Refer to the configuration section of this supplement for programming instructions.

### Manual LQA Exchanges

To perform a manual LQA exchange, do the following steps:

**NOTE:** Manual LQA exchanges cannot be started if the radio is linked or scanning. Press the SCAN button to stop scanning channels, or press the CLR button to unlink the radio from another station.

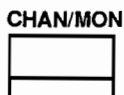

1. PRESS THE CHAN/MON BUTTON SEVERAL TIMES until only the addresses are displayed.
2. SELECT THE DESIRED INDIVIDUAL (100-199), OR NET (300-319) in one of the following two ways:

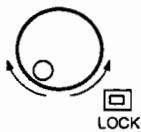

- a. ROTATE THE TUNING KNOB until the desired address appears.

OR

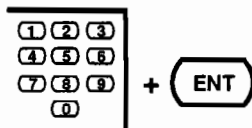

- b. TYPE THE DESIRED ADDRESS ON THE KEYPAD; PRESS THE ENT KEY. Use the CLR key to clear any mistakes.

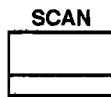

3. PRESS THE LQA KEY. The status indicator shows an "L" while the unit does the LQA on all channels assigned to the individual address. Channel numbers will appear in the display.
4. PRESS THE SCAN BUTTON when the LQA is complete.

### Manual LQA Sounds

To perform a manual LQA sound, do the following steps:

**NOTE:** Manual LQA sounds cannot be started if the radio is linked or scanning. Press the SCAN button to stop scanning channels, or press the CLR key to unlink the radio from another station.

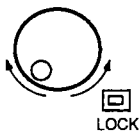
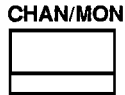

1. PRESS THE CHAN/MON BUTTON SEVERAL TIMES until only the addresses are displayed.
2. SELECT THE SELF ADDRESS (100-199) in one of the following two ways:
  - a. ROTATE THE TUNING KNOB until the self address appears.

OR

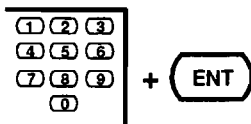

- b. TYPE THE SELF ADDRESS ON THE KEYPAD; PRESS THE ENT KEY. Use the CLR key to clear any mistakes.

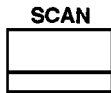

3. PRESS THE LQA KEY. The status indicator shows a "b" while the unit does the LQA on all channels with the self address and current group. Channel numbers will appear in the display.
4. PRESS THE SCAN BUTTON when the LQA is complete.



## OVERVIEW

The RF-3272 uses the following two types of programming:

- ALE programming
- ALE configuration

This section describes ALE programming, which is accessed through either the user or security-level password. This can be done from the front panel or through remote control. This supplement covers front-panel programming only.

### NOTE

Programming of the RF-3272 should only be done by qualified personnel. The password protection system is used to safeguard against personnel without proper programming knowledge of the RF-3200 or RF-3272.

The radio must be in the adaptive mode (front panel ALE indicator lit) to program adaptive features. Review the operation section of this supplement, and become familiar with the instructions on entering and exiting ALE operation.

The diagram below shows the relationship between the addresses and channel lists. Each net address is programmed with a channel list and a list of individual addresses. Each individual address is programmed with its own channel list. The individual and net address channel list are each used at different times during operation as shown below:

- The net's channel list is used only with net calls.
- The individual's channel list is used only with individual calls.

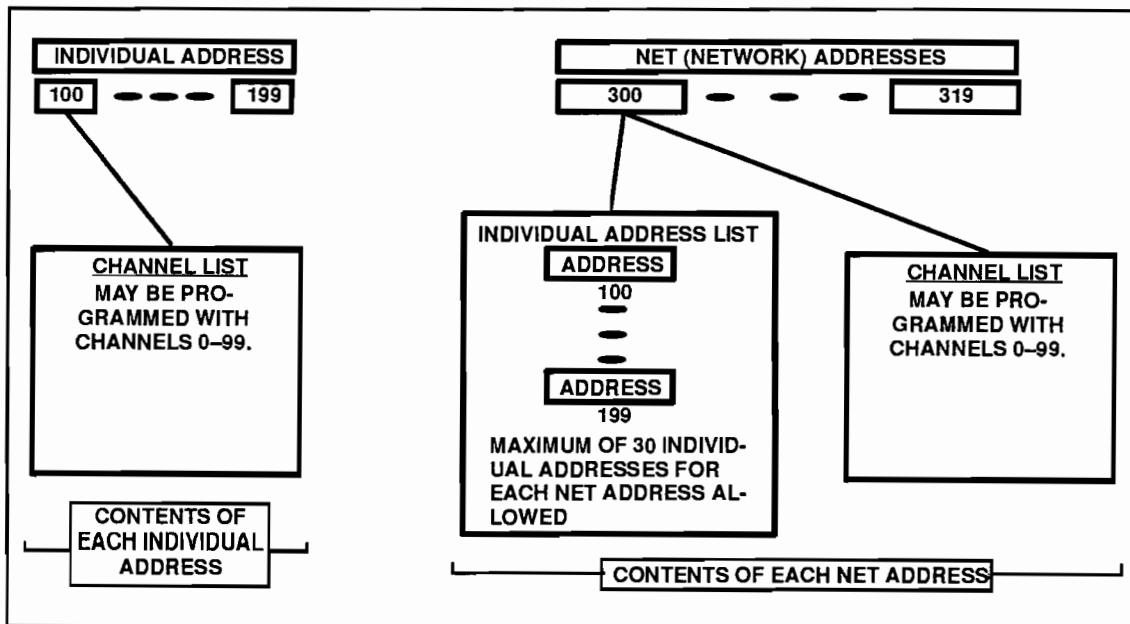

## INDIVIDUAL ADDRESSES

### Entering ALE programming

To enter ALE programming, do the following steps:

**NOTE:** ALE programming cannot be done if the radio is either linked or scanning. Pressing the SCAN button will stop scanning channels, and pressing the CLR key will unlink the radio from another station.

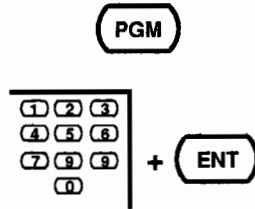

1. PRESS THE PGM KEY SEVERAL TIMES until "ALE PAS" appears in the display. The PGM lamp should now be lit.
2. TYPE SECURITY-LEVEL PASSWORD, supplied with the radio, ON THE KEYPAD; PRESS THE ENT KEY.

**NOTE:** If the password is correct, the first individual address is displayed. If the password is incorrect, error tones will sound, and "ALE PAS" will reappear; Re-enter the correct password.

### To Add Channels To Individual Addresses

To add channels to individual addresses, do the following steps:

1. Make sure the radio is in ALE programming as described in "Entering ALE Programming."
2. SELECT INDIVIDUAL ADDRESS (100-199) to be programmed, in one of two ways:

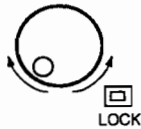

- a. ROTATE THE TUNING KNOB until the desired address appears.

OR

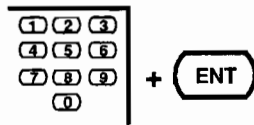

- b. TYPE THE DESIRED ADDRESS ON THE KEYPAD; PRESS THE ENT KEY. Use the CLR key to clear any mistakes.

**NOTE:** A self address will be displayed as "SLF," and an individual address will be displayed as "ind."

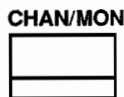

3. PRESS THE CHAN/MON BUTTON to select the channel field. A "C" will appear in the group field of the display. The "C" will be followed by the channel numbers if the address is programmed. If the address has no assigned channels, "--" will appear in the channel field of the display.

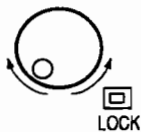

4. ROTATE THE TUNING KNOB to review the channel list.

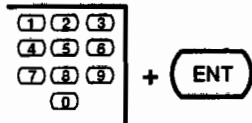
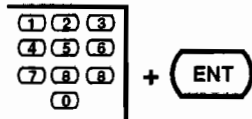

5. TYPE THE CHANNEL NUMBER ON THE KEYPAD; PRESS THE ENT KEY. Use the CLR key to clear any mistakes. The channel number is displayed after the "C" in the group field and is followed by a "c." The "c" indicates the channel list has been changed but not loaded into memory.
6. REPEAT STEP 5 until all channels are entered.
7. If the operator wishes to store all changes, PRESS THE LD KEY. (If not, go to step 9.) The "c" will disappear and the address prompt will return, indicating the channel list was loaded into memory.
8. Repeat steps 2 through 7 until all individual addresses have been programmed.
9. To exit programming, PRESS THE PGM KEY SEVERAL TIMES until the PGM lamp turns off.

**To Delete Channels From An Individual Address**

To delete channels from an individual address, do the following steps:

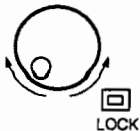
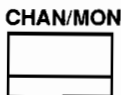
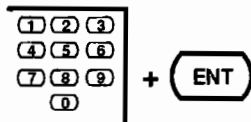
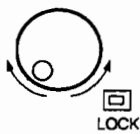

1. Make sure the radio is in ALE programming as described in "Entering ALE Programming."
  2. SELECT THE INDIVIDUAL ADDRESS (100-199) in one of two ways:
    - a. ROTATE THE TUNING KNOB until the desired address appears.
- OR
- b. TYPE THE DESIRED ADDRESS ON THE KEYPAD; PRESS THE ENT KEY. Use the CLR key to clear any mistakes.

**NOTE:** A self address will be displayed as "SLF," and an individual address will be displayed as "ind."

3. PRESS THE CHAN/MON BUTTON to select the channel field. A "C" will appear in the group field of the display. The "C" will be followed by the channel numbers if the address is programmed. If the address has no assigned channels, "--" will appear in the channel field of the display.
4. SELECT THE CHANNEL TO BE DELETED BY ROTATING THE TUNING KNOB.

CLR

5. PRESS THE CLR KEY. The next channel in the list will be displayed and followed by a "c." This indicates the channel list has been changed but not loaded into memory. If there are no more channels in the list, "--" will be displayed.

6. Repeat steps 4 and 5 until all channel deletions have been completed.

LD

7. If you wish to store all changes, PRESS THE LD KEY. (If not, go to step 8.) The "c" will disappear and the address prompt will return, indicating the channel list was loaded into memory.

PGM

8. To exit programming, PRESS THE PGM KEY SEVERAL TIMES until the PGM lamp turns off.

**NOTE:** If no channels remain, the individual will be deleted.

## NET ADDRESSES

### To Add Individual Addresses And Channels To Net Addresses

To add individual addresses and channels to net addresses, do the following steps:

1. Make sure the radio is in ALE programming as described in "Entering ALE Programming."

2. SELECT THE NET ADDRESS (300-319) TO BE PROGRAMMED in one of two ways:

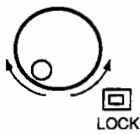

a. ROTATE THE TUNING KNOB until the desired address appears.

OR

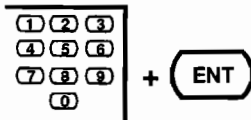

b. TYPE THE DESIRED ADDRESS ON THE KEYPAD; PRESS THE ENT KEY. Use the CLR key to clear any mistakes.

CHAN/MON

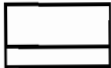

3. PRESS THE CHAN/MON BUTTON to select the address field. An "i" will appear in the group field of the display. The "i" will be followed by the individual address numbers if the net address is programmed. If the net address is not programmed, "---" will appear.

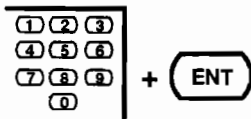

4. TYPE THE INDIVIDUAL ADDRESS NUMBER ON THE KEYPAD; PRESS THE ENT KEY. Use the CLR key to clear any mistakes. The individual address number will be displayed after the "i" in the group field and be followed by a "c." The "c" indicates the address list has been changed but not loaded into memory.

5. REPEAT STEP 4 until all the assigned individual addresses have been entered into the net.

**NOTE:** All stations in a network must add their individual addresses in the same order. Failure to do this will cause network linking failures.

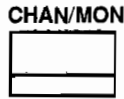

6. PRESS THE CHAN/MON BUTTON to view the net's channel list. A "C" will appear in the group field of the display. The "C" will be followed by the channel numbers if the address is programmed. If the address has no assigned channels, "--" will appear in the channel field of the display.

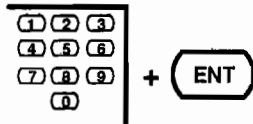

7. TYPE THE NEW CHANNEL NUMBER ON THE KEYPAD; PRESS THE ENT KEY. Use the CLR key to clear any mistakes. The channel number will be displayed followed by a "c." The "c" indicates the channel list has been changed but not loaded into memory.

8. REPEAT STEP 7 until all the net's channels have been entered.



9. If the operator wishes to store all changes, PRESS THE LD KEY. (If not, go to step 11.) The "c" will disappear and the address prompt will return, indicating the channel list was loaded into memory.

**NOTE:** If either the individual list or channel list are left empty, upon pressing the LD button, both lists will be cleared and the net will be deleted. A valid net must not have an empty individual address list or channel list.

10. Repeat steps 2 through 9 until all net addresses have been programmed.



11. To exit programming, PRESS THE PGM KEY SEVERAL TIMES until the PGM lamp turns off.

**To Delete Individual Addresses And Channels From Net Addresses**

To delete individual addresses and channels from net addresses, do the following steps:

1. Make sure the radio is in ALE programming as described in "Entering ALE Programming."

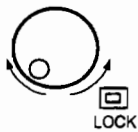

2. SELECT THE NET ADDRESS (300-319) TO BE CHANGED in one of the following two ways:

- a. ROTATE THE TUNING KNOB until the desired address appears.

OR

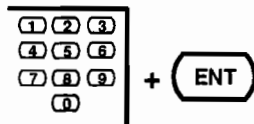

- b. TYPE THE DESIRED ADDRESS ON THE KEYPAD; PRESS THE ENT KEY. Use the CLR key to clear any mistakes.

CHAN/MON

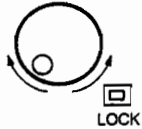
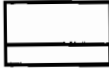

3. PRESS THE CHAN/MON BUTTON to select the address field. An "i" will appear in the group field of the display. The "i" will be followed by the individual address numbers if the address is programmed. If the address is not programmed, " --- " will appear in the display.
4. SELECT INDIVIDUAL ADDRESS (100-199) TO BE DELETED BY ROTATING THE TUNING KNOB. The tuning knob will stop on the first and last individual addresses in the list.
5. PRESS THE CLR KEY. The next individual address in the list will be displayed followed by a "c." This indicates the individual address list has been changed but not loaded into memory. If there are no more individual addresses in the list, " --- " will be displayed.
6. REPEAT STEPS 4 and 5 until all the individual addresses to be deleted from the list are removed.

**NOTE:** All stations in a network must program their individual addresses in the same order. Failure to do this will cause network linking failures.

CHAN/MON

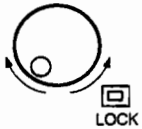
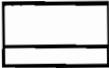

7. PRESS THE CHAN/MON BUTTON to view the net's channel list. A "C" will appear in the group field of the display. The "C" will be followed by the channel numbers if the address is programmed. If the address has no assigned channels, " -- " will appear in the channel field of the display.
8. SELECT THE CHANNEL TO BE DELETED BY ROTATING THE TUNING KNOB.
9. PRESS THE CLR KEY. The next channel in the list will be displayed and followed by a "c." This indicates the channel list has been changed but not loaded into memory. If there are no channels in the list, " -- " will be displayed.
10. Repeat steps 8 and 9 until all channels have been deleted.



11. If the operator wishes to store all changes, PRESS THE LD KEY. (If not, go to step 13.) The "c" will disappear and the address prompt will return, indicating the channel list was loaded into memory.

**NOTE:** If either the individual list or channel list are left empty, upon pressing the LD button, both lists will be cleared and the net will be deleted. A valid net must not have an empty individual address list or channel list.



12. Repeat steps 2 through 11 to delete all desired channels and individual addresses from the net.
13. To exit programming, PRESS THE PGM KEY SEVERAL TIMES until the PGM lamp turns off.

## OVERVIEW

The RF-3272 uses the two following types of programming:

- ALE programming
- ALE configuration

This section describes ALE configuration, which is accessed through the security level password. ALE configuration allows users to style the transceiver and RF-3272 ALE option to meet the specific needs of their system. This can be performed from the front panel or through remote control. This supplement covers front-panel configuration only.

### NOTE

Configuration of the RF-3272 should only be programmed by qualified personnel. The password protection system is used to safeguard against personnel without proper programming knowledge of the RF-3200 or RF-3272.

The radio must be in the adaptive mode (front panel ALE indicator lit) to configure adaptive features. Review the operation section of this supplement, and become familiar with the instructions on entering and exiting ALE operation.

## PARAMETER DESCRIPTION

The following table describes the programmable ALE configuration items.

RADIO SELF ADDRESS	Identifies the address other stations use to call this radio. One of the individual addresses programmed in ALE programming must be set to the radio's self index.
TIME	This parameter sets the internal clock of the radio. The clock is used for the timed LQAs.
LQA SOUND INTERVAL	This parameter sets the time interval between LQA sounds with units in hours and minutes. The first two digits display the hour, and the second two display the minute. A value of zero turns off the timed sounding.
LQA SOUND STARTING TIME	This parameter is the start time for LQA sounds with units in hours and minutes. The first two digits display the hour, and the second two digits display the minute.
LQA EXCHANGE TIME INTERVAL	This parameter is the time interval between LQA exchanges with units in hours and minutes. The first two digits display the hour, and the second two digits display the minute. A value of zero turns off the timed exchanges.
LQA EXCHANGE STARTING TIME	This parameter sets the start time for LQA exchanges with units in hours and minutes. The first two digits display the hour, and the second two digits display the minute. A value of zero turns off the timed exchanges.
LQA EXCHANGE ADDRESS	This parameter specifies the address of the net or individual station the timed LQA is performed with.
NUMBER OF SCAN CHANNELS	This parameter determines the length of the call preamble, which is used by the scanning receiver to recognize the call. This item must be set to the maximum number of channels scanned by any of the stations that can be called.
COUPLER TUNE TIME	This parameter sets the maximum time allowed for the target station's antenna coupler tuning in seconds.

**NOTE:** Changing or removing the self address will automatically remove the sounding LQA time interval and starting time. Individual and net addresses will be automatically reprogrammed for the new self address.



**CONFIGURATION PARAMETERS**

Refer to the following table for adaptive configuration parameters and values.

Radio Self Address	SELF id	100 to 199	"_ _ _"
Time	Hour	0 to 2359	
Sounding LQA Time Interval	Sd intr	0000 to 2400	0000
Sounding LQA Starting Time	Sd Strt	0000 to 2359	0000
Bi-directional LQA Time Interval	bL intr	0000 to 2400	0000
Bi-directional LQA Starting Time	bL Strt	0000 to 2359	0000
Bi-directional LQA Address	bL ind	100 to 199 or 300 to 319	"_ _ _"
Number of Scan Channels	SCAN CH	1 to 100	100
Coupler Tune Time	tUNE ti	1 to 60 seconds	2 seconds

**CHANGING PARAMETER VALUES**

**NOTE:** ALE configuration cannot be done if the radio is either linked or scanning. Pressing the SCAN button will stop scanning channels, and pressing the CLR key will unlink the radio from another station.

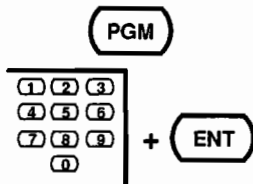

1. PRESS THE PGM KEY SEVERAL TIMES until "ALE Con" appears in the display. The PGM indicator should now be lit.
2. ENTER THE SECURITY LEVEL PASSWORD supplied with the radio using the KEYPAD and ENT key.

**NOTE:** If the password is correct, the first individual address is displayed. If the password is incorrect, error tones will sound and "ALE Con" will reappear. Re-enter the correct password.

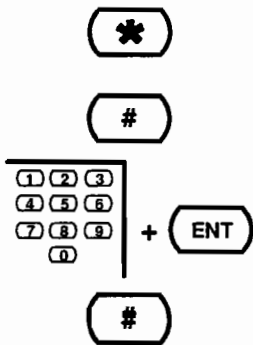

3. PRESS THE \* KEY SEVERAL TIMES until the prompt for the desired parameter is displayed.
4. PRESS THE # KEY to display the parameter's current value.
5. TYPE IN THE NEW PARAMETER VALUE on the KEYPAD; PRESS ENTER. Use the CLR key to clear mistakes.
6. PRESS THE # KEY to display the new parameter value. This can be used to see that the correct value was entered.

7. REPEAT STEPS 3 THROUGH 6 if more parameters are to be configured.

**LD**

8. If you wish to store all the changed parameters, PRESS THE LD KEY. (If not, go to step 9.) "LOADing" is displayed while the new values are stored.

**NOTES:** When programming LQAs, all parameters (for that LQA sound or exchange) must be entered before loading.

The internal clock is changed as soon as the ENT key is pressed. The other parameters must be loaded.

**PGM**

9. To exit programming, PRESS THE PGM KEY SEVERAL TIMES until the PGM indicator turns off.

## ALE ERROR MESSAGES

GROUP	CHANNEL	FREQUENCY	
	CHAN	Er kHz	INVALID CHANNEL NUMBER – CHANNEL NOT PROGRAMMED INTO CURRENT GROUP
	Ind	Err kHz	INVALID ADDRESS (NOT ADDRESS 100-199, 300-319, OR 900) OR ADDRESS NOT PROGRAMMED INTO UNIT
	In	FULL kHz	DISPLAYED ONLY DURING PROGRAMMING TO INDICATE A NET ADDRESS IS FULL (MAXIMUM OF 30 INDIVIDUAL ADDRESSES FOR EACH NET ADDRESS)
	No	SELF kHz	SELF ADDRESS CHANNEL LIST NOT PROGRAMMED OR SELF ID NOT SELECTED. THE SELF ADDRESS MUST BE PROGRAMMED (SEE CONFIGURATION) FOR ALE TO WORK.
	No	Ind kHz	NO INDIVIDUAL ADDRESS PROGRAMMED. AN INDIVIDUAL ADDRESS MUST BE PROGRAMMED FOR ALE TO WORK.



# RF-3200T USER'S GUIDE SUPPLEMENT

---

Pub. No. 10262-0051

This supplement contains information for the RF-3200 User's Guide.

Remove the wrap from this RF-3200T Supplement and insert behind the "Options" section in the RF-3200 User's Guide.

Discard this sheet.

# RF-3200T HF-SSB TRANSPORTABLE COMMUNICATIONS SYSTEM

This supplement contains or references user's information for the RF-3200T HF-SSB (High Frequency Single Sideband) Transportable Communications System. The system includes an RF-3200T 125W HF-SSB Transceiver, an RF-3281T Voice-Duty Automatic Antenna Coupler and other system components integrated into a suitcase-style package. The system includes everything needed to set up and operate a high quality, reliable, 125W HF communications station. The system weighs 47 pounds (21.3 kg) and operates in any standard communications mode, including USB, LSB, compatible AM (AME), CW, and DATA modes.

RF-3200T  
SUPPLEMENT



**ACCESSORIES AND SUPPLIED ITEMS**

Accessory Bag Contents ..... 4

**POWER SOURCE INFORMATION**

DC Operation ..... 6  
 AC Operation ..... 6

**ANTENNA DEPLOYMENT**

Center-Fed Antennas (Dipoles) ..... 7  
 Deployment of Dipole Antennas ..... 10  
 End-Fed Antennas (Whips and Long-wires) ..... 11  
 Deployment of End-Fed Antennas ..... 11  
 Broad band Antennas ..... 12

**REFERENCES FOR ADDITIONAL INFORMATION ON HF PROPAGATION AND ANTENNA CONSIDERATIONS**

**FIGURES**

RF-3200T HF-SSB Transportable Communications System ..... 3  
 Selected System Accessories ..... 5  
 Half-Wavelength Dipole Antenna Deployment ..... 8  
 Slant-Wire Doublet Deployment ..... 9  
 Inverted V Doublet Antenna Deployment ..... 9  
 Dipole Deployment of the RF-3200T Antenna System ..... 10  
 Long-wire Antenna Deployment of the RF-3200T Antenna System ..... 11  
 Long-wire with Counterpoise Deployment of the RF-3200T Antenna System ..... 12

**TABLE**

Accessory Bag Contents ..... 4  
 Other Items Supplied With The System ..... 4



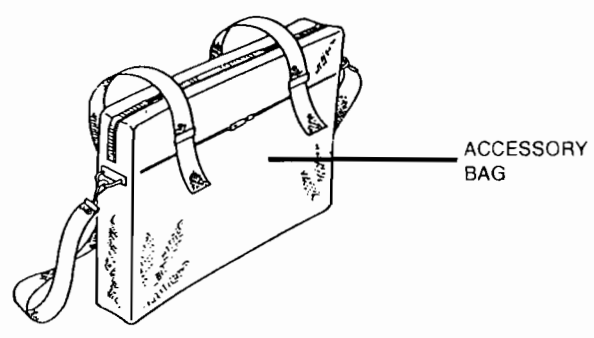
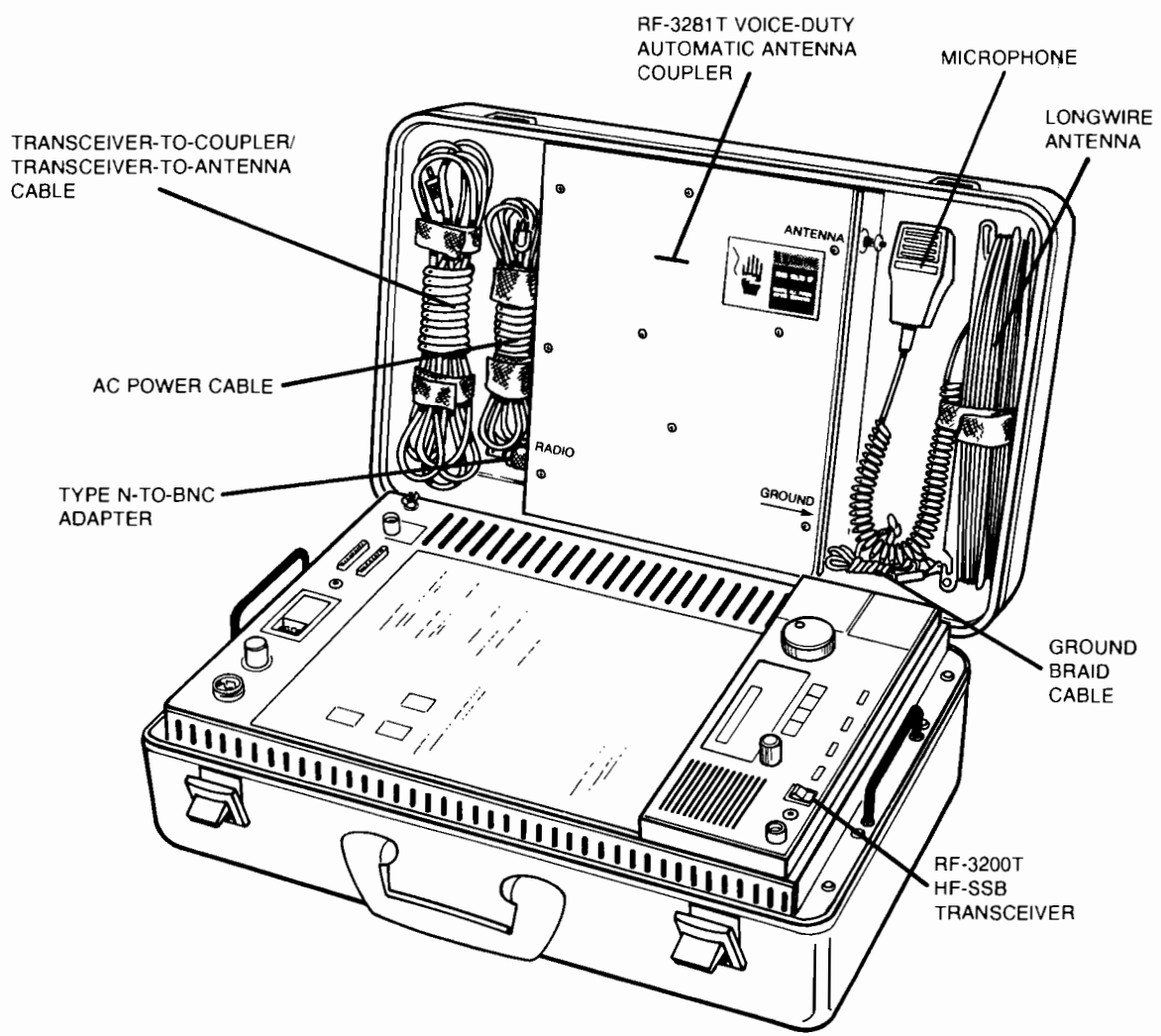

3200T-100

**RF-3200T HF-SSB TRANSPORTABLE COMMUNICATIONS SYSTEM**

## 1. ACCESSORIES AND SUPPLIED ITEMS

- Table 1 lists the contents of the accessory bag supplied with the system.
- Table 2 lists the other items supplied with the system.
- Figure 1 shows some of the accessories supplied with the system.

Table 1. Accessory Bag Contents

Fig. No.	Qty.	Part Number	Description
3	1	J-0060	AC Plug 3-to-2 Prong Connector Adapter
4	1	10262-0600	Auxillary DC Power Cable
6	1	p/o 10262-0700	Dipole Antenna *
7	1	p/o 10262-0700	Dipole Antenna Adapter
8	2	F-0016	Fuse, 6.0A, QA, 250V, Type 3AG
9	4	F-0013	Fuse, 3.0A, QA, 250V, Type 3AG
10	2	F-0105	Fuse, 30A, QA, 32V, Type 5AG
11	2	F-0017	Fuse, 8.0A, QA, 125V, Type 3AG
12	2	F15-0001-010	Fuse, 2.5A, QA, 125V, Type PIC
--	1	SK-0423	Flat Blade Screwdriver, 4-1/2 inch
17	1	J-0002	UHF Cable Plug Connector
18	1	J22-0070-115	15-Pin D Plug Connector
--	1	J22-0070-514	15-Pin Connector Metal/Plastic Hood
20	1	UG-21D/U	Type N Coax Connector

\*An additional long-wire antenna is stowed in the Unit's cover.

Table 2. Other Items Supplied With The System

Fig. No.	Qty.	Part Number	Description
--	1	W-0023	6-foot Line Cord
2	1	Z52-0003-000	Foreign Power Adapter Plug Kit
6	1	p/o 10262-0700	Long-wire Antenna*
--	1	10262-0650	Ground Strap Cable Assembly
--	1	10212-0200	Hand held Microphone
--	1	10262-6220	Carry Case (Accessory Bag)
--	1	10262-0050	RF-3200 User's Guide/RF-3200T Supplement
--	1	10212-0051	RF-3200 Operator's Card
--	1	UG-201A/U	BNC-to-N Adapter

\*An additional longwire antenna is stowed in the unit's accessory bag.

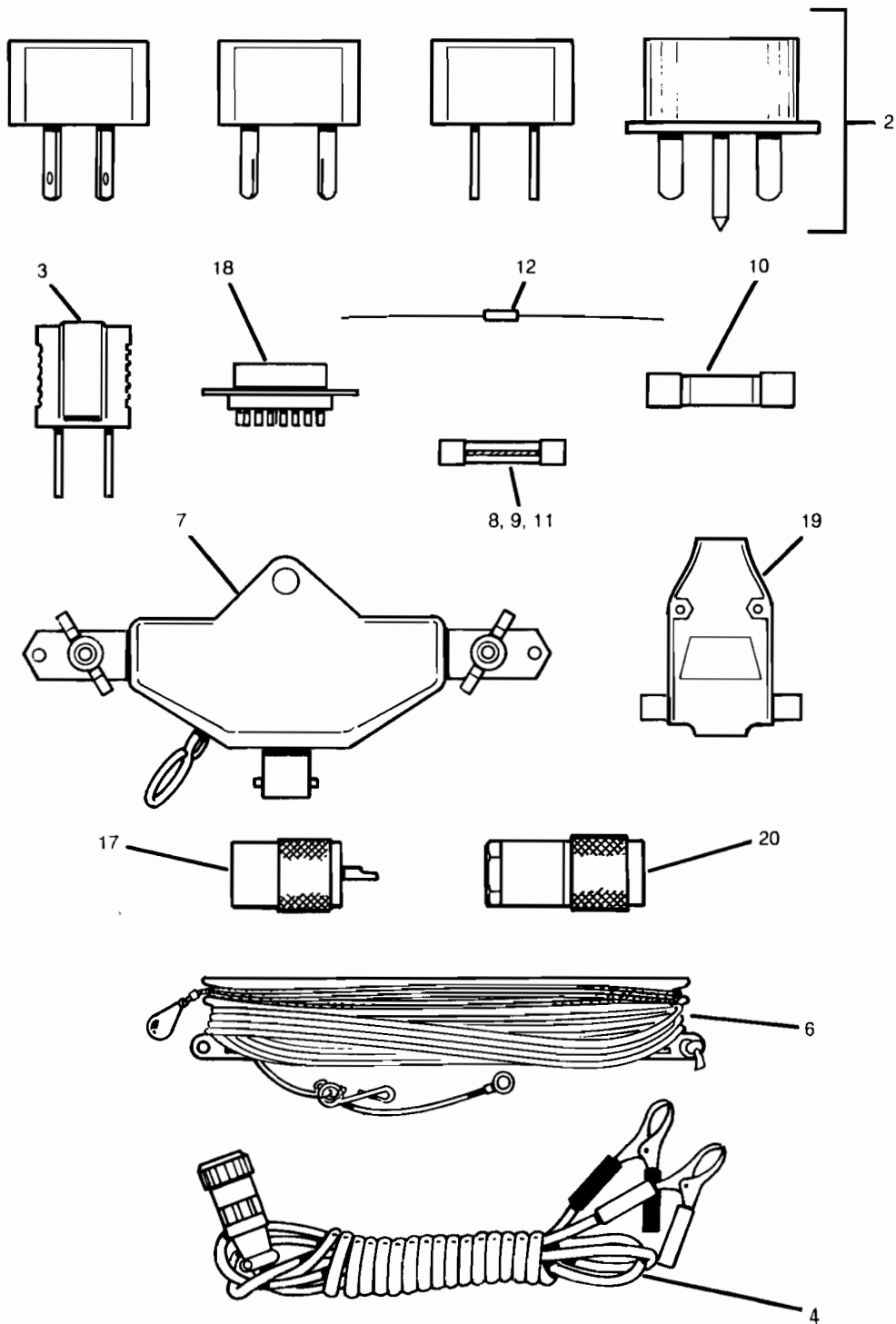

3200T-002

Figure 1. Selected System Accessories

## 2. POWER SOURCE INFORMATION

The RF-3200T HF-SSB Transportable Communications System is capable of operating from either an AC or DC power source. An optional RF-3200TBP Transportable Battery Pack with integral dual-rate charger is available.

### 2.1 DC Operation

DC operation requires a battery or regulated power supply with an output of  $13.6 \pm 20\%$  VDC, capable of delivering 25 amp peak. A 30 amp fuse should be installed in the DC fuseholder. The average current consumption is 10 amps for voice-duty operation.

#### CAUTION

Use a power source whose output does not exceed 16.3 VDC. The RF-3200T overvoltage protection will blow the 30-amp fuse if a higher voltage is used.

### 2.2 AC Operation

Either a  $115 \pm 15\%$  VAC or  $230 \pm 15\%$  VAC power source may be used for AC operation. The housing lid of the AC power connector must be lifted (use the flat-blade screwdriver provided) to change the voltage selector wheel and fuse.

#### CAUTION

Select the proper voltage using the selector wheel and install the proper fuse (6 amps for 115 VAC operation, 3 amps for 230 VAC operation).

#### CAUTION

When operating the RF-3200T from a generator, the power switch must be in the OFF position during generator startup. Many generators are unregulated and may exceed normal line voltages during the startup period.

The RF-3200T HF-SSB Transceiver and the internal AC power supply are thermally protected. Both will gradually cut back the output power of the transceiver if internal temperatures approach the maximum levels for the components. Operation at reduced power levels will not damage either the transceiver or internal power supply. Normal voice-duty operation should not cause power cutback, but operation at greater than voice duty and at elevated ambient temperatures may result in reduced power output. In addition, the internal AC power supply is equipped with a failsafe temperature shutdown circuit. If the gradual cutback does not reduce the internal temperature of the AC power supply sufficiently, the power supply will shut down. The front panel power switch must be turned off for at least 5 minutes to restore power. A failsafe power shutdown indicates a failure in the protection circuitry. If this type of shutdown occurs, the unit may still be used but should be serviced as soon as possible.

### 3. ANTENNA DEPLOYMENT

#### WARNING

**ALWAYS USE EXTREME CARE WHEN DEPLOYING ANTENNAS!** Care should be taken to deploy the antenna away from electrical wires, electrical machinery, or other potential sources of electrical shock. Antennas should not be deployed in areas where people or animals may contact them.

Refer to the Reference Information section of this user's guide, Propagation and Antenna Considerations section. References for more specific information on HF propagation and antenna considerations are listed in section 4 of this supplement. Because HF propagation is dependent upon time of day, weather conditions, time of the year, and sun spot activity, this data is published periodically by radio amateur magazines. In general, lower frequencies are not useable during daylight hours and higher frequencies are not useable at night. During periods of sunspot activity, maximum useable frequencies will have to be determined by the operator.

The most critical factors in determining the performance of an HF communications system, are the deployment of the antenna and the effectiveness of the ground system. Since the RF-3200T System is designed for quick deployment in emergency, disaster, and other portable applications, a well-designed and planned antenna site will seldom be possible. However, use of the guidelines in this manual will allow the user to set up the best antenna system for the given circumstances, providing the user with a possible communications range of up to several thousand miles.

The RF-3200T HF-SSB Transportable Communications System can operate effectively using many different antenna configurations. Three common types of antenna systems include: resonant, center-fed dipoles; end-fed antennas such as whips and long wires; and broad band antennas such as log periodics (directional) and broadband dipoles. The transceiver is designed to operate without an antenna coupler into a 50-ohm antenna system with all three types of antennas provided they present a VSWR of less than 2:1 at the operating frequency. At VSWRs greater than 2:1 the transceiver will operate at a reduced power level. If a 50-ohm antenna is not available, the RF-3281T Voice Duty Automatic Antenna coupler is provided for matching purposes. This antenna coupler will tune most antenna configurations in less than 1 second.

In addition to safety considerations, the location of all antenna systems should be chosen to be clear of obstructions and electromagnetic noise sources such as high-tension lines or electrical machinery. The optional noise blanker will provide noise reduction in situations where deployment near noise sources is unavoidable.

#### 3.1 Center-Fed Antennas (Dipoles)

The center-fed, resonant dipole or half-wavelength dipole is probably the most effective antenna system for HF communications. This antenna configuration consists of two one-quarter wavelength antenna legs which are center fed with 50-ohm coaxial cable. For best performance the 50-ohm coaxial feedline should run perpendicular to each antenna leg. The length of each leg of the dipole antenna is determined by the following formula:

$$L = \lambda/4 = 234/\text{Frequency (MHz) feet}$$

or

$$L = \lambda/4 = 71.3/\text{Frequency (MHz) meters}$$

Where  $\lambda$  = one wavelength

For example, for an operating frequency of 22.365 MHz, the length (L) of each leg of the resonant dipole is:

$$L = \lambda/4 = 234/22.365 = 10.5 \text{ feet}$$

or

$$L = \lambda/4 = 71.3/22.365 = 3.2 \text{ meters}$$

The half-wave dipole can be deployed in several ways. The most common is shown in figure 2. Note that for a half-wavelength dipole, maximum radiation occurs at right angles (perpendicular) to the length of the antenna. Minimum radiation occurs at the ends of the antenna. The height (H) at which the dipole should be deployed is determined by practical limitations and the particular application. Half-wave dipoles have a more vertical radiation pattern the closer they are to ground plane. Conversely, they have an increasingly horizontal radiation pattern when H is increased. As a rule of thumb, a dipole one-quarter wavelength above the ground will have a nearly vertical radiation pattern, and a dipole one-half wavelength above the ground will have a 30 degree radiation pattern relative to the horizontal ground plane. At lower frequencies it may be difficult to deploy the antenna at these heights.

For example; for an operating frequency of 1.6 MHz, the minimum height (H) would be::

$$H = \lambda/4 = 234/1.6 = 146.25 \text{ feet}$$

In this case the antenna should be deployed as high as possible.

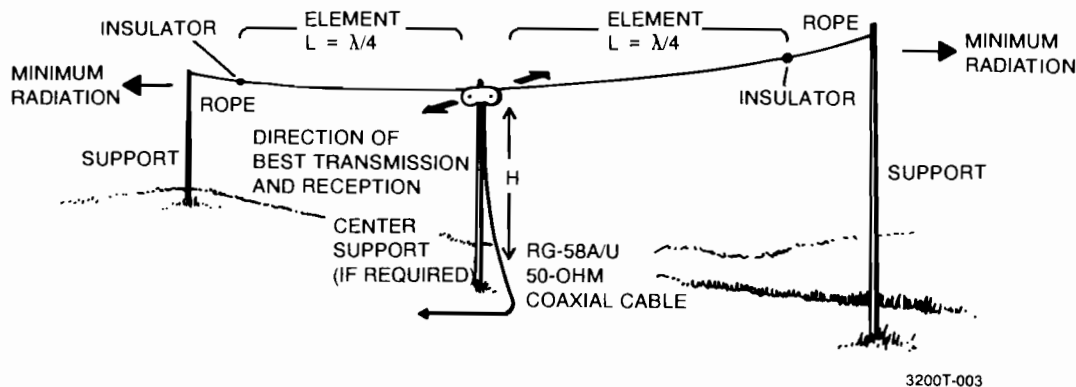

**Figure 2. Half-Wavelength Dipole Antenna Deployment**

As a general rule, position the dipole perpendicular to the direction of desired communications. For short-distance communications, the dipole should be placed approximately one-half wavelength above the ground. For long-distance communications, the dipole should be placed approximately one-quarter wavelength above the ground.

When only a single upright support is available, two variations of the dipole may be utilized, as shown in figures 3 and 4. The configuration shown in figure 3 has a fairly low radiation angle and has maximum radiation directivity as shown.

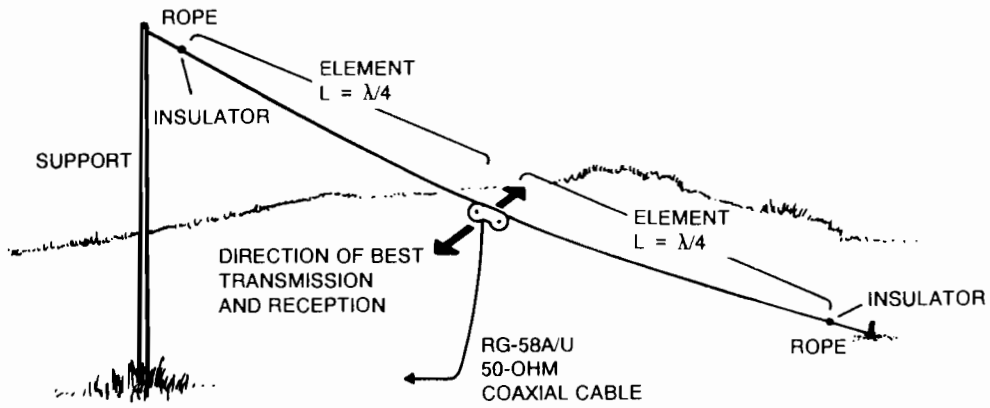

3200T-005

Figure 3. Slant-Wire Doublet Deployment

The configuration shown in figure 4 is commonly referred to as the inverted V. The inverted V has the advantage of being nondirectional, exhibiting a nearly omnidirectional radiation pattern. Whenever possible, the center-fed point should be at least one-quarter wavelength above the ground and the angle between the two legs should be 90 to 120 degrees.

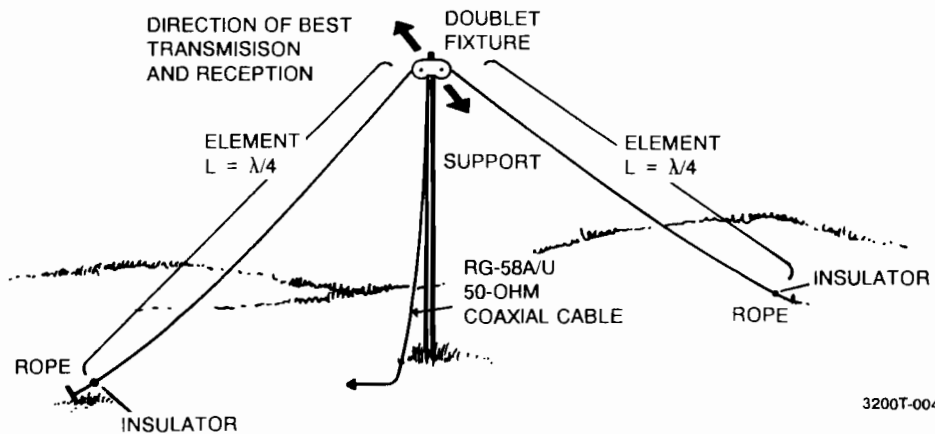

3200T-004

Figure 4. Inverted V Doublet Antenna Deployment

### 3.1.1 Deployment of Dipole Antennas

Deployment of the antenna system provided as a dipole is relatively simple. Refer to figure 5. The parts required to deploy the antenna system as a dipole are:

- 2 long-wires on spool/insulators with cord and weight
- Dipole adaptor
- 30 feet of coaxial cable terminated with one UHF connector and one BNC connector
- Ground Strap

The coupler is not needed for this type of installation because the antenna is deployed to be resonant at the operation frequency. If operation with a coupler is desired, the coupler should be placed at the junction of the two antenna legs, or an open-wire feeder (not included) should be used. If operating at more than one frequency is desired, set up the dipole for the primary or lowest operation frequency. Follow the guidelines listed previously for deployment and refer to figure 5. Connect each of the long wires to the dipole adaptor and unroll the antenna to the frequency indicated on the wire labels. Secure the long wires in the notches at either end of the spools. Connect the coax cable provided from the transceiver ANTENNA/COUPLER connector to the dipole adaptor. Use the strain reliefs on the dipole adaptor on the long wires and the coax cables to prevent stressing the connectors. Secure the cords connected to the spools to the antenna supports and raise the antenna into place. Connect the ground strap to the GROUND connector on the transceiver and clip the other end to a good ground such as, a cold-water pipe, a metal rod driven into the ground, or the metallic body of a vehicle. The system is ready to support communications needs.

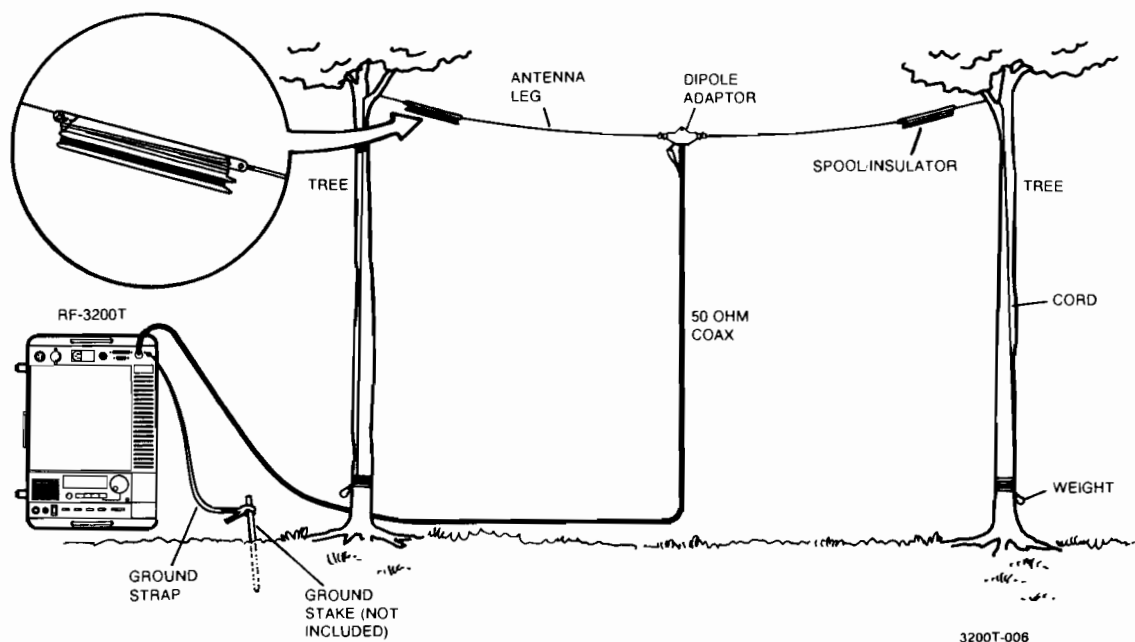

Figure 5. Dipole Deployment of the RF-3200T Antenna System



### 3.2 End-Fed Antennas (Whips and Long-wires)

End-fed antennas such as whips and long-wires are the quickest and easiest antenna systems to deploy. However, their performance is dependent on the effectiveness of the ground system. Long-wire antennas differ from whip antennas primarily in their electrical length in wave lengths. In general, longer end-fed antennas exhibit greater gain. A long-wire antenna is resonant if its length is a multiple of the one-quarter wavelength of the operating frequency.

#### CAUTION

For safety reasons, even numbered multiples of quarter wavelengths should be avoided to minimize voltages at the ends of the long wire. If the antenna is much less than a quarter wavelength, its effectiveness is greatly reduced. Also, because dissipation in the automatic antenna tuner is greater for whips at low frequencies, it is not recommended that whip antennas or very short long-wire antennas be used with the system, particularly at greater-than-voice-duty cycles.

#### 3.2.1 Deployment of End-Fed Antennas

Deployment of the antenna system provided as a long-wire is very simple. Refer to figure 6. The items required for this type of deployment are listed below:

- 1 long-wire on spool/insulator, with cord and weight
- 30 feet of coaxial cable terminated with one UHF connector and one BNC connector
- RF-3281T Voice-Duty Automatic Antenna Coupler
- Ground strap

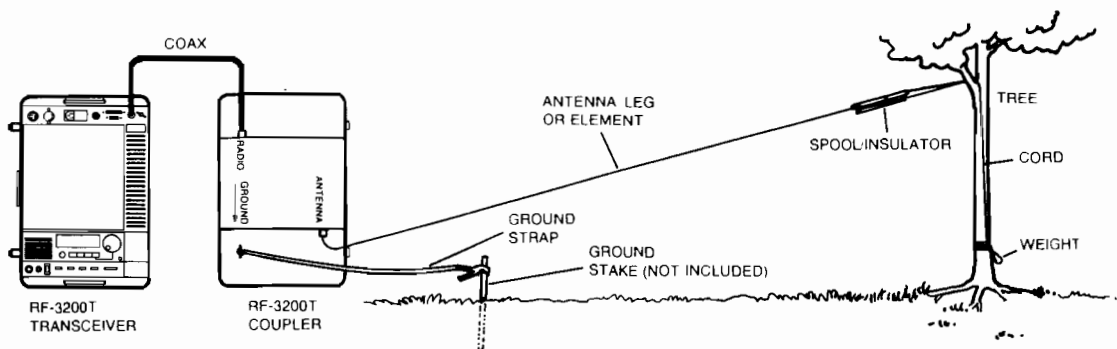

Figure 6. Long-wire Antenna Deployment of the RF-3200T Antenna System

It is not necessary to construct a resonant long-wire with the system. A long-wire of random length (maximum length is best) should be deployed as high as possible. The automatic antenna coupler will tune to the antenna in about 1 second. For safety and convenience, the coupler may be separated from the transceiver by some distance. (The system's cover can be removed by grasping it and moving it to the right.) Connect the ground strap to the GROUND connector on the unit's lid and the other end to a good ground such as a cold-water pipe, a metal rod pressed into the ground, or the metallic body of a vehicle. Connect the RADIO connector on the coupler to the ANTENNA/COUPLER connector on the transceiver using the cable provided. Key the transceiver to tune the coupler and the system is ready. If a "No tunE" message appears in the display, change the length or position of the long-wire slightly and retune.

A good ground is imperative for effective and safe HF communications with end-fed antenna systems. Often a good ground may not be available. In these situations a counterpoise may be used instead of a ground. Refer to figure 7.

### WARNING

The transceiver must now be grounded to avoid RF voltages being induced on the chassis.

The optimum length for the counterpoise is one-quarter wavelength, as shown in figure 7. If operating at more than one frequency, or if a quarter-wavelength counterpoise is impractical, set up the counterpoise to the primary frequency (using the formula given or the marking tags on the line) or at the greatest length possible.

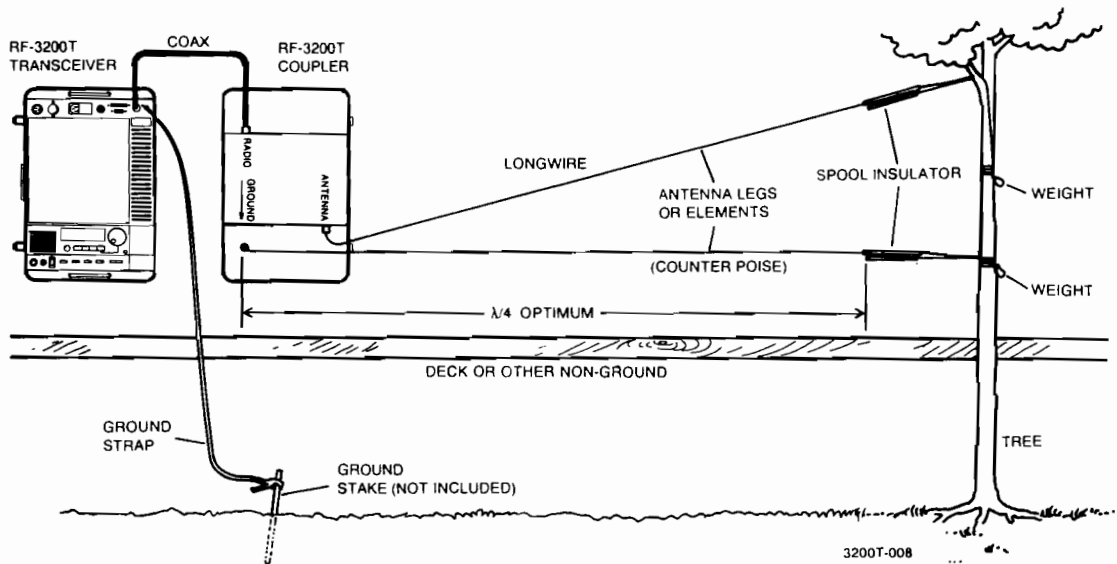

Figure 7. Long-wire with Counterpoise Deployment of the RF-3200T Antenna System

### 3.3 Broad band Antennas

There are many commercially available broad band antennas. Most should work at full power with the RF-3200T system, provided they are 50-ohm antenna systems and their VSWRs are less than 2.0:1.

#### 4. REFERENCES FOR ADDITIONAL INFORMATION ON HF PROPAGATION AND ANTENNA CONSIDERATIONS

The following listings refer to the leading sources of additional reference information on HF propagation and antennas.

Field Antenna Handbook, consulting report prepared by James A. Kuch for the Department of Defense, Electromagnetic Compatibility Analysis Center, Annapolis, Maryland 21402; Report number ECAC-CR-83-200

The Radio Amateur's Handbook, American Radio Relay League: Newington, CT 06111; ISBN: 0-87259-160-3

The ARRL Antenna Book, American Radio Relay League: Newington, CT 06111; ISBN: 0-87259-414-9

Reference Data for Radio Engineers, Howard W. Sams & Co, Inc., Indianapolis, Indiana 46268; ISBN: 0-672-21218-8

Basic Radio Propagation Predictions, CRPL-D, published monthly, US Government Printing Office, Washington, DC 20402

## SPECIFICATIONS

## GENERAL

<b>Operating Levels:</b>	Programmable; full frequency access, receive only frequency access, or channelized.
<b>Frequency Range:</b>	1.6 to 30 MHz transmit, 0.5 to 30 MHz receive.
<b>Frequency Resolution:</b>	10 Hz steps, digitally synthesized.
<b>Number of Channels:</b>	200 preprogrammed (factory set); 121 user programmable; all channels simplex or half-duplex; non-volatile memory (battery back-up).
<b>Automatic Channel Scan:</b>	9 user programmable groups, 135 channels.
<b>Channel Programming:</b>	Front panel programmable. Protection against unauthorized frequency change is provided by Security Access Code (std.) and removal of internal coding device.
<b>Frequency Stability:</b>	$\pm 5$ parts in $10^7$ ( $\pm 15$ Hz).
<b>Emission Mode:</b>	<ul style="list-style-type: none"> <li>• J3E-suppressed carrier (USB/LSB)</li> <li>• H3E-full carrier (AME)</li> <li>• R3E-reduced carrier (SSB)</li> <li>• J2A-CW (optional narrowband filter available)</li> <li>• J2B-FSK/TTY (optional filter available)*</li> </ul>
<b>Display:</b>	8-digit vacuum fluorescent display, LED status indicator.
<b>Power Input:</b>	115/230 VAC $\pm 15\%$ , 50/60 Hz, 13.6 VDC $\pm 20\%$ , 2.5 Amps, Receive.
<b>Meter:</b>	Front panel: Tx (watts), Reflected Power (watts), Rx (s-units).
<b>Diagnostic Detection Fault:</b>	Monitor and indication of Tx Fwd/Reflected power, VSWR, temperature, and antenna coupler fault conditions.
<b>Programming:</b>	Front panel; hardware and software security.
<b>Size:</b>	8.0H x 21L x 13W in. (20.3H x 53.3L x 33.0W cm). Meets FAA and ATA under-seat size requirements.
<b>Weight:</b>	47 lbs. (21.3 kg) complete package.

*\*Full power in FSK mode is possible with a dipole when operated from 13.6 VDC and will be maintained for five minutes. In long-term single-tone FSK operation, power automatically cuts back approximately 3 dB.*

*Because Harris engineers are continually striving to improve all aspects of our equipment, published specifications are subject to change without notice.*

## SPECIFICATIONS (Cont.)

## TRANSMITTER

<b>Power Output:</b>	SSB: 125 watt PEP/Average from 13.6 VDC.
<b>Overload Protection:</b>	PA fully protected from mismatch including open or shorted antenna and thermal overload.
<b>Carrier Suppression:</b>	55 dB below PEP.
<b>Intermodulation Distortion:</b>	32 dB below PEP.
<b>Undesired Sideband Suppression:</b>	55 dB at 1 kHz.
<b>Harmonic Suppression:</b>	65 dB below PEP.
<b>Spurious Suppression:</b>	65 dB below PEP.
<b>Audio Input:</b>	Dynamic microphone. 600 ohm auxiliary input.
<b>Residual Noise Level:</b>	50 dB below PEP.
<b>Audio Bandwidth:</b>	2.4 kHz (standard), others optionally available.
<b>Speech Processing:</b>	Automatic level control with companded voice processing.

## RECEIVER

<b>Sensitivity:</b>	SSB: 0.5 $\mu$ V for 10 dB SINAD; AM: 3 $\mu$ V for 10 dB SINAD.
<b>Audio Output:</b>	5 watts with less than 5% distortion. 600 ohm auxiliary output.
<b>AGC Characteristics:</b>	Audio output varies less than 2 dB for signals 10 $\mu$ V to 1 volt. Automatically selected dual time-constant AGC for voice or FSK/CW operation (standard).
<b>Selectivity:</b>	SSB: 300 to 2700 Hz at 6 dB (standard). Others optionally available. AM: 6 kHz at 6 dB (standard).
<b>Image Rejection:</b>	-70 dB.
<b>IF Rejection Intermodulation:</b>	-80 dB.
<b>Distortion:</b>	-80 dB.
<b>Desensitization:</b>	-100 dB (100 kHz separation).
<b>Spurious Response:</b>	-70 dB.
<b>Squelch:</b>	Syllabic, voice controlled, with noise immunity.
<b>Clarifier:</b>	Digital $\pm$ 250 Hz (10 Hz steps).
<b>Overload Protection:</b>	30 Vrms.
<b>Noise Blanker:</b>	Impulse noise protection (optional).

## SPECIFICATIONS (Cont.)

**ANTENNA COUPLER**

<b>Frequency Range:</b>	1.6 to 30 MHz.
<b>Tuning Capability:</b>	1.6 to 30 MHz: long-wire, dipole, and 24 to 35 foot whip antennas; 2.0 to 30 MHz: 16 foot whip antennas; 4.0 to 30 MHz: 9 foot whip antennas.
<b>RF Input Power:</b>	125 watts PEP, (30 watts average).
<b>Input Impedance:</b>	50 ohms.
<b>Tuning Accuracy:</b>	VSWR less than 1.2:1 typical, 1.5:1 maximum.
<b>Tuning Mode:</b>	Fully automatic.
<b>Tuning Time:</b>	30 msec tune from memory, 1 second typical in learn mode.
<b>Tune Memory:</b>	321 channels, half-duplex or simplex; 16 random tune frequencies (group F).
<b>RF Tune Power:</b>	10 to 20 watts forward throughout tune cycle.
<b>Diagnostics/Protection:</b>	Automatic cutback or bypass; over-temperature, over-voltage, excessive VSWR.
<b>Coupler Control:</b>	All control and DC power is multiplexed on the coaxial cable.
<b>Remote Capability:</b>	30 foot (9m) RG-58 Coax provided. Up to 150 foot (46m) separation between transceiver and coupler with RG-213U Coax Cable.
<b>Primary Power Requirements:</b>	13.6 VDC $\pm$ 20%. Power supplied by RF-3200 Transceiver.
<b>Connections:</b>	Input (Transceiver): Type N (watertight), surge protection; Output (Antenna): Ceramic, high-voltage insulator, surge protection; Ground: ground lug.

**ENVIRONMENTAL**

<b>Temperature:</b>	-30 °C to +60 °C.
<b>Shock, Vibration:</b>	MIL-STD-810D.
<b>Humidity:</b>	MIL-STD-810D.



**NOTES:**

1  
2  
3  
4  
5  
6  
7  
8  
9  
10  
11  
12  
13  
14  
15  
16  
17  
18  
19  
20  
21  
22  
23  
24  
25  
26  
27  
28  
29  
30  
31  
32  
33  
34  
35  
36  
37  
38  
39  
40  
41  
42  
43  
44  
45  
46  
47  
48  
49  
50  
51  
52  
53  
54  
55  
56  
57  
58  
59  
60  
61  
62  
63  
64  
65  
66  
67  
68  
69  
70  
71  
72  
73  
74  
75  
76  
77  
78  
79  
80  
81  
82  
83  
84  
85  
86  
87  
88  
89  
90  
91  
92  
93  
94  
95  
96  
97  
98  
99  
100

# ADDENDUM

<b>ADDENDUM NO:</b> L794	<b>APPLIES TO (RF Model or Product Name):</b> RF-3200 User's Guide	<b>DATE:</b> April 1992
<b>ADDENDUM TO (Publication Number/Revision):</b> 10212-0050D		<b>FOR (Specific Application):</b> All Manuals

Programming for the RF-3200 has been made easier by the addition of a new feature. This new feature includes the capability to scroll through the various parameters when configuring the radio. Since this addition is only a software change, a simple pen-and-ink change is required to add the feature to your manual.

Make the following pen-and-ink change to the manual, and insert this addendum inside the front cover.

## PROGRAMMING AND CONFIGURATION SECTION

- Page 3-13, step 3 - at the end of the sentence, add "or use the tuning knob to scroll through the selections."
- Add the following note at the bottom of the page:

### NOTE

The direction of scrolling may differ among some versions of the software.





**HARRIS CORPORATION** • RF Communications Group • 1680 University Avenue • Rochester, N.Y. 14610 • U.S.A.  
716/244-5830 • Fax: 716-244-2917, 716-325-1572 • Tele: 240313 RFCOM UR

©1990 Harris Corporation  
Printed in U.S.A.

Pub. No. 102-2-0050 REV D  
9/90, MR 430