



## INSTRUCTION MANUAL

UHF TRANSCEIVER

# IC-450



Icom Inc.

---

## IMPORTANT

---

**READ ALL INSTRUCTIONS** carefully before using the **IC-450 UHF TRANSCEIVER**.

**KEEP THIS INSTRUCTION MANUAL**, as it contains important operating information that may be useful in the future.

---

## EXPLICIT DEFINITIONS

---

WORD	DEFINITION
<b>⚠ DANGER!</b>	Personal death, serious injury or an explosion may occur.
<b>⚠ WARNING!</b>	Personal injury, fire hazard or electric shock may occur.
<b>CAUTION</b>	Equipment damage may occur.
<b>NOTE</b>	If disregarded, inconvenience only. No risk of personal injury, fire or electric shock.

Icom, Icom Inc. and Icom logo are registered trademarks of Icom Incorporated (Japan) in Japan, the United States, the United Kingdom, Germany, France, Spain, Russia, Australia, New Zealand, and/or other countries.

---

## OPERATIONAL NOTES

---

- i. The use of the citizen band radio service is licenced in Australia by the ACMA Radiocommunications (Citizens Band Radio Stations) Class Licence and in New Zealand by the Ministry of Economic Development (MED) General User Radio Licence for Citizen Band Radio and operation is subject to conditions contained within these licences.
- ii. Always listen on a channel (or observe the channel busy indicator) to ensure it is not already being used before transmitting.
- iii. In Australia, channel 11 is the customary calling channel for establishing communication. Channel 40 is the customary road vehicle channel.
- iv. In Australia, except in an emergency, a CB transmitter shall not be operated on UHF emergency channels 5 and 35.
- v. No voice transmissions are permitted on data channels 22 and 23 (voice operation is inhibited on these channels).
- vi. The user of this UHF CB communications device shall not transmit Selcall tones for longer than 3 seconds during any 60 second period.

---

## OPERATIONAL NOTES

---

- vii. UHF CB repeaters extend the operational range of your radio. Repeaters operate utilising two channels (repeater input/repeater output). It is important to avoid operation on locally used repeater input channels (in the channel range of 31 to 38 and 71 to 78) or locally used repeater output channels (in the channel range of 1 to 8 and 41 to 48), unless long distance communication via the repeater is specifically required. See the section on repeater operation for more information.
  
- viii. Please be aware that the UHF CB network may experience possible operational issues during the changeover to narrowband. This transceiver operates on 12.5 kHz channel spacing. During the changeover period from 25 kHz to 12.5 kHz spacing, there may be some loss of quality when 12.5 kHz (narrowband, 2.5 kHz deviation) transmissions are received on 25 kHz (wide band, 5.0 kHz deviation) equipment, and vice-versa. There may also be interference due to older equipment being operated on channels adjacent to new narrowband channels, as the channel setting on these may cause some 'overlap'. A list of currently authorised channels can be found on the ACMA website (Australia) and on the MED website in New Zealand.

---

## PRECAUTIONS

---

**⚠ WARNING! NEVER** connect the radio to an AC outlet. This may pose a fire hazard or result in an electric shock.

**CAUTION: NEVER** operate or touch the radio and microphone with wet hands. This may result in an electric shock or damage the radio and microphone.

**CAUTION: NEVER** connect the radio to a power source of more than 27.6 V DC. This will damage the radio.

**CAUTION: NEVER** connect the radio to a power source using reverse polarity. This will damage the radio.

**CAUTION: NEVER** cut the DC power cable between the DC plug and fuse holder. If an incorrect connection is made after cutting, the radio may be damaged.

**CAUTION: NEVER** expose the radio and microphone to rain, snow or any liquids. The radio and microphone may be damaged.

**CAUTION: NEVER** place the radio where normal operation of the vehicle may be hindered or where it could cause bodily injury.

**DO NOT** push the PTT when not actually intending to transmit.

**DO NOT** allow children to play with any radio equipment containing a transmitter.

---

## PRECAUTIONS (Continued)

---

**DO NOT** operate the radio near unshielded electrical blasting caps or in an explosive atmosphere.

**DO NOT** operate the radio for extended periods without running the vehicle's engine. The radio's power consumption may soon exhaust the vehicle's battery.

**DO NOT** set the radio in a place without adequate ventilation. Heat dissipation may be affected, and the radio may be damaged.

**DO NOT** use harsh solvents such as benzene or alcohol to clean the radio, as they will damage the radio's surfaces. If the radio becomes dusty or dirty, wipe it clean with a soft, dry cloth.

**USE** Icom microphones only (supplied or optional). Other manufacturer's microphones have different pin assignments and may damage the radio if attached.

**DO NOT** modify the radio. The radio warranty does not cover any problems caused by unauthorized modification.

**DO NOT** use or place the radio in direct sunlight or in areas with temperatures below  $-10^{\circ}\text{C}$  or above  $+60^{\circ}\text{C}$ . The basic operations, transmission and reception of the radio are guaranteed within the specified operating temperature range. However, the LCD display may not operate correctly, or show an indication in the case of long hours of operation, or after being placed in extremely hot or cold areas.

**BE CAREFUL!** The radio will become hot when operating it continuously for long periods of time.

**MAKE SURE** to turn OFF the radio power before connecting any supplied/optional equipment.



This device complies with Standard Australia Specification No. AS/NZS 4365-2011.

---

# TABLE OF CONTENTS

---

IMPORTANT .....	i	<b>4 SET MODE .....</b>	<b>16–19</b>
EXPLICIT DEFINITIONS .....	i	■ Set mode .....	16
OPERATIONAL NOTES .....	i	■ SET mode items .....	17
PRECAUTIONS .....	ii	<b>5 REPEATER OPERATION .....</b>	<b>20</b>
TABLE OF CONTENTS .....	iv	■ Repeater operation .....	20
<b>1 ACCESSORIES AND INSTALLATION .....</b>	<b>1–5</b>	<b>6 SCAN .....</b>	<b>21–25</b>
■ Supplied accessories .....	1	■ Scan types .....	21
■ Installation and Connection .....	1	■ Scanning preparation .....	22
<b>2 UNIT DESCRIPTION .....</b>	<b>6–9</b>	■ Open scan .....	23
■ Front and rear panels .....	6	■ Group scan and priority scan .....	24
■ HM-212 Description .....	7	■ Repeater search scan .....	25
■ Display .....	8	<b>7 TONE SQUELCH AND POCKET BEEP .....</b>	<b>26–27</b>
<b>3 BASIC OPERATION .....</b>	<b>10–15</b>	■ Tone squelch .....	26
■ Turning power ON .....	10	■ Pocket beep .....	27
■ Adjusting the volume .....	10	<b>8 SELCALL (Selective Calling) .....</b>	<b>28–31</b>
■ Selecting a channel .....	10	■ Calling .....	28
■ Receiving and transmitting .....	11	■ Receiving .....	30
■ Priority channel .....	13	■ Quiet mode .....	31
■ Monitor .....	14	■ Stun .....	31
■ Lock .....	14		
■ Adjusting the squelch level .....	14		
■ Backlight .....	15		
■ Voice recorder .....	15		

---

## TABLE OF CONTENTS (Continued)

---

<b>9 OTHER FUNCTIONS.....</b>	<b>32–34</b>
■ Smart Ring and ATS .....	32
■ RX frequency (for only RX channels).....	33
■ Data cloning .....	34
■ All reset .....	34
<b>10 SPECIFICATIONS AND OPTIONS .....</b>	<b>35–36</b>
■ Specifications .....	35
■ Options.....	36
<b>11 MAINTENANCE .....</b>	<b>37–38</b>
■ Troubleshooting.....	37
■ Fuse replacement .....	38
<b>12 WARRANTY AND REGISTRATION.....</b>	<b>39</b>
<b>INDEX.....</b>	<b>47–49</b>

## ■ Supplied accessories

- ① DC power cable (3 m) ..... 1
- ② Mounting bracket ..... 1
- ③ Microphone (HM-212) ..... 1
- ④ Fuse (FGB 10 A) ..... 1
- ⑤ Mounting screws, nuts and washers ..... 1 set
- ⑥ Microphone hanger set ..... 1
- ⑦ Microphone hanger cable ..... 1
- ⑧ Extension cable (2.5 m) ..... 1

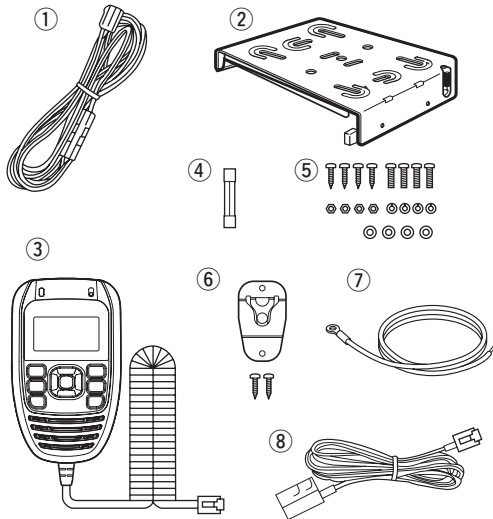

## ■ Installation and Connection

### ◇ Location

Select a location which can support the weight of the radio and does not interfere with driving. We recommend the locations shown in the diagram on page 2.

**NEVER** place the radio or microphone where normal operation of the vehicle may be hindered or where it could cause bodily injury.

**NEVER** place the radio or microphone where air bag deployment may be obstructed.

**DO NOT** place the radio or microphone where hot or cold air blows directly onto it.

**DO NOT** place the radio or microphone in direct sun light.

# 1 ACCESSORIES AND INSTALLATION

## ■ Installation and Connection (Continued)

### ◇ Installation methods

<Sample 1: IC-450 is installed under the driver's seat.>

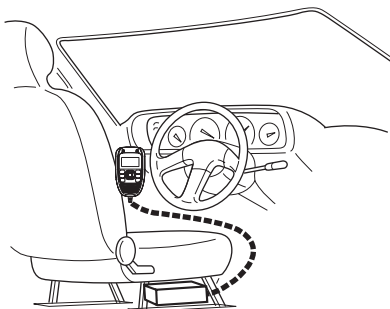

<Sample 2: IC-450 is installed under the glove compartment or on the center console.>

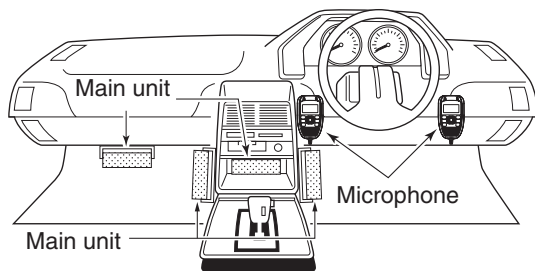

### ◇ Using the mounting bracket

- ① Drill 3 holes where you want to install the mounting bracket.
  - Approximately 5.5~6 mm when using nuts;  
approximately 2~3 mm when using self-tapping screws.
- ② Use the supplied screws, nuts and washers to attach the mounting bracket, and tighten them firmly.
- ③ Insert the mounting bracket's rail to the transceiver's slot, then slide the transceiver to attach to the mounting bracket.

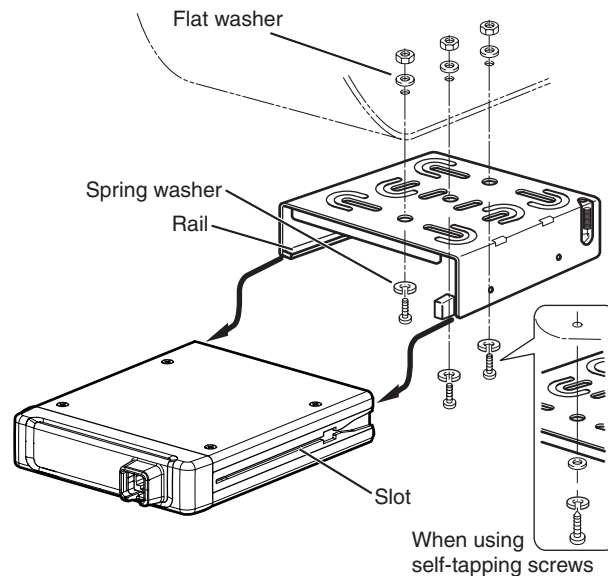

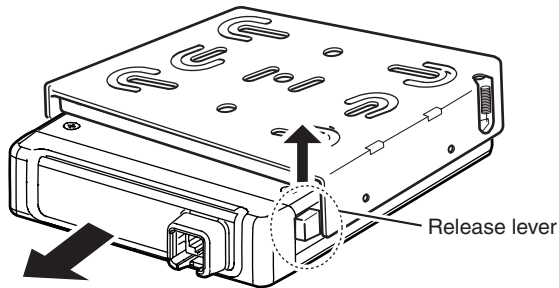

**NOTE**

- When detaching the transceiver from the mounting bracket, push up and hold the release lever, then pull the transceiver to the direction of the arrow.
- The mounting bracket can be attached even upside down. When detaching the transceiver from the bracket in this case, hold down the release lever, then pull the transceiver to the front.

### ◆ Microphone

Connect the supplied microphone as illustrated below.

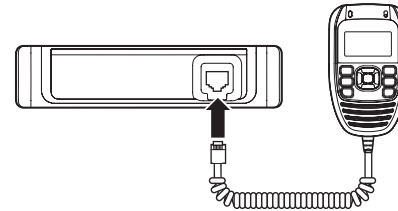

### ◆ Microphone hanger

Attach the supplied microphone hanger as illustrated below.

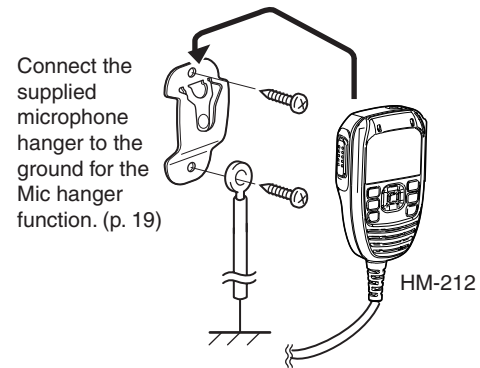

# 1 ACCESSORIES AND INSTALLATION

## ◇ Battery

⚠ **WARNING! NEVER** remove the fuse holders from the DC power cable.

**DO NOT** use the cigarette lighter socket for the power connection (See page 6 for details.) Attach a rubber grommet when passing the DC power cable through a metal plate to prevent a short circuit.

- Connecting to a DC power source

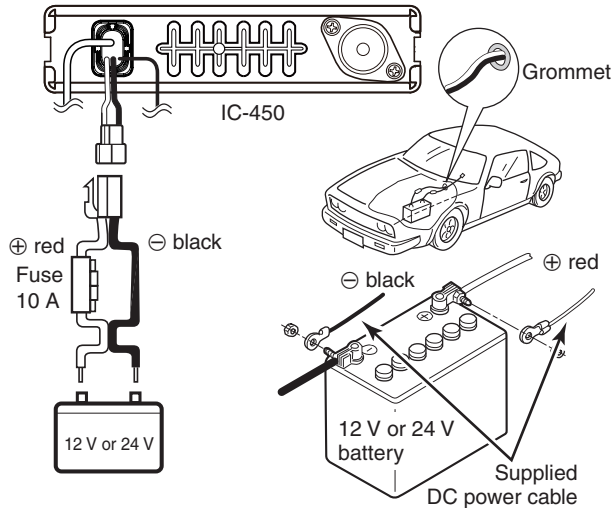

### NOTE:

Use terminals for the cable connections.



## ◇ DC Power supply

⚠ **WARNING! NEVER** remove the fuse holders from the DC power cable.

Use a 13.8 V or 27.6 V DC power supply with at least 3 A capacity. Make sure the ground terminal of the DC power supply is grounded.

- Connecting to a DC power supply

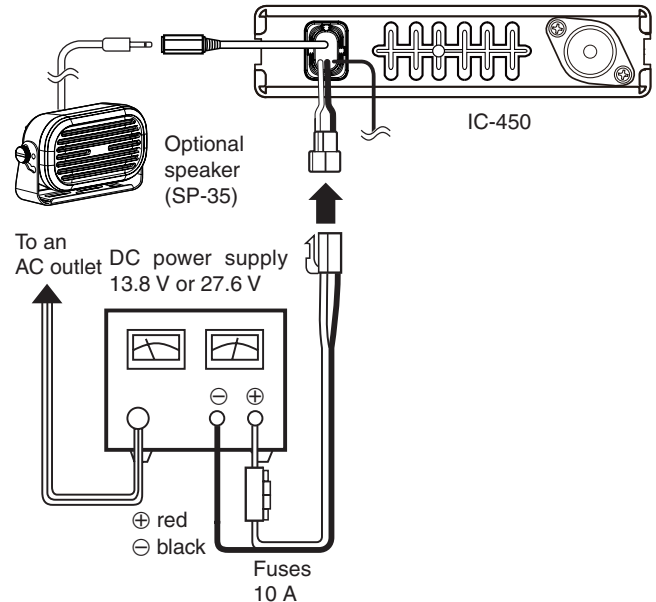

## ◇ Antenna

### Antenna location

To obtain the transceiver's maximum performance, select a high-quality antenna and mount it in a good location. A non-radial antenna should be used when using a magnetic mount.

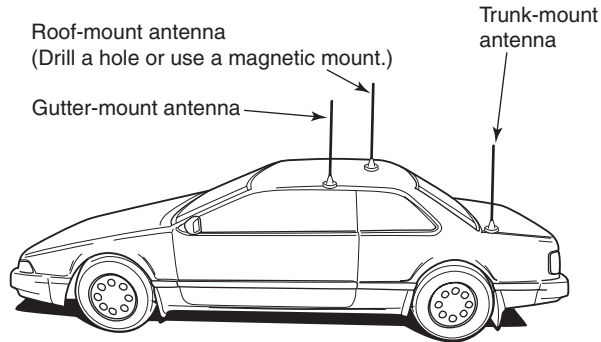

### • Antenna connector

The antenna with a PL-259 connector.

### NOTE:

There are many publications concerning proper antennas and their installation. Check with your local dealer for more information and recommendations.

## ■ Front and rear panels

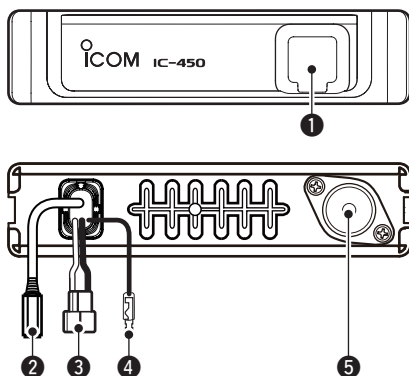

### 1 MICROPHONE CONNECTOR

Connects the supplied microphone or cloning cable (OPC-1122U.)

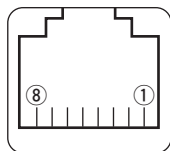

Front panel view

- ① DC output (same voltage as connected battery or DC power supply)
- ② TX line
- ③ GND
- ④ PTT
- ⑤ GND (microphone ground)
- ⑥ AF line
- ⑦ POWER
- ⑧ RX line

### 2 EXTERNAL SPEAKER JACK [SP]

Connects a 4  $\Omega$  speaker. (p. 4)  
 • Audio output power is typically 5 W.

### 3 POWER RECEPTACLE

Accepts 13.8 V or 27.6 V DC with the supplied DC power cable.

- ⊕ red
- ⊖ black

**NOTE: DO NOT** use a cigarette lighter socket as a power source when operating in a vehicle. The plug may cause voltage drops and ignition noise may be superimposed onto transmit or receive audio.

### 4 IGNITION LEAD

Connects to an ignition line.  
 ⚠ **DO NOT** put a pressure to this lead.

### 5 ANTENNA CONNECTOR

Connects a 50  $\Omega$  antenna with a PL-259 connector and a 50  $\Omega$  coaxial cable.

### ANTENNA INFORMATION

For radio communications, the antenna is of critical importance, to maximize your output power and receiver sensitivity. The transceiver accepts a 50  $\Omega$  antenna and a less than 1:1.5 Voltage Standing Wave Ratio (VSWR). High SWR values not only may damage the transceiver, but also lead to TVI or BCI problems.

## ■ HM-212 Description

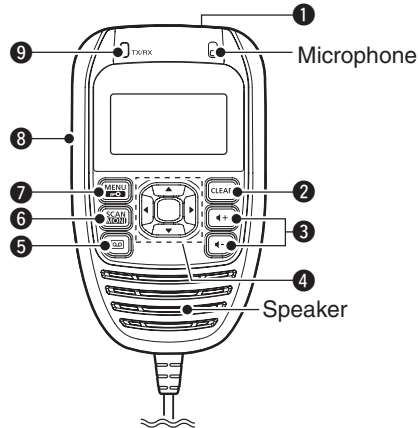

### 1 POWER KEY (p. 10)

Hold down for 2 seconds to turn the power ON or OFF.







### 2 CLEAR KEY (pp. 14, 16)

Push to cancel a setting or to return to the previous menu.

### 3 VOLUME CONTROL KEYS

- Push to adjust the audio level (from 0 to 32).
- “” appears when the audio level is set to 0 (silent mode).

### 4 D-PAD KEYS []/[]/[]/[]/[]

- Push []/[] to select an operating channel, menu setting and so on. (pp. 10, 16)
- Push []/[] to select a digit to edit. (pp. 29, 33)
- Push [] to select an item or setting in the menu. (pp. 29, 33)
- Push [] to select the Priority CH in the standby mode.
- Hold down [] for 2 seconds to set the displayed channel as a Priority channel. (p. 13)
  - Hold down again to unset the Priority channel.

### 5 REC DATA/REC PAUSE KEY (p. 15)

- Push to display the recorded audio menu.
- Hold down for 2 seconds to start and stop recording.

### 6 SCAN/MONI KEY (pp. 14, 23)

- Push to start or stop the scan. (pp. 23, 24, 25)
- Hold down for 2 seconds to turn the Monitor function ON or OFF. (p. 14)

### 7 MENU/KEY LOCK KEY

- Push to enter the menu mode. (p. 16)
- Hold down for 2 seconds to turn the Key Lock function ON or OFF.

### 8 PTT SWITCH [PTT] (p. 12)

Hold down to transmit, release to receive.

### 9 TX/RX INDICATOR (p. 12)

The indicator lights or blinks when you transmit and receive.

**Information:** You can disable the keys, or each key function can be reassigned to the keys using the optional CS-450 CLONING SOFTWARE. (p. 34)

## 2 UNIT DESCRIPTION

### ■ Display

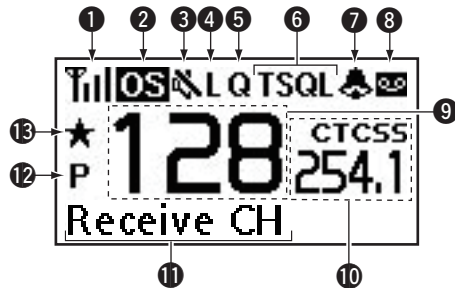

#### 1 SIGNAL STRENGTH ICON

Shows relative receive signal strength level.  
• “Ψ” blinks when the ATS function is in use. (p. 32)

#### 2 OPEN SCAN ICON (pp. 22, 23)

Appears when ‘Open scan’ is selected.

#### PS PRIORITY SCAN ICON (p. 24)

Appears when the ‘Priority scan’ is selected.

#### GS GROUP SCAN ICON (p. 24)

Appears when the ‘Group scan’ is selected.

#### RS REPEATER SCAN ICON (p. 25)

Appears when the ‘Repeater scan’ is selected.

#### 3 INTERNAL SPEAKER MUTE ICON (pp. 10, 18)

Appears when the volume level is set to 0 (the audio is muted).

#### 4 LOW POWER ICON (p. 12)

Appears when low output power is selected.

#### 5 QUIET ICON (p. 31)

Appears when the Quiet function is ON. (Selcall mute is activated)

#### 6 TONE ICON (p. 26)

➤ “T” appears while the Subaudible tone encoder is used.  
➤ “T SQL” appears while the Tone squelch/DTCS squelch function is used.

#### 7 BELL ICON

➤ Appears when the Pocket beep function is used. (p. 27)  
➤ Blinks when the specified Selcall or Smart Ring call is received. (pp. 30, 32)

#### 8 VOICE RECORDER ICON (p. 15)

Appears when the Voice Recorder function is turned ON.

#### 9 CHANNEL READOUT

The operating channel number is displayed.

#### 10 CTCSS/DTCS READOUT (p. 26)

➤ The CTCSS tone frequency or DTCS code is displayed.  
➤ Appears when the Tone squelch is set to ON or the Pocket beep function is selected.

#### 11 NAME DISPLAY

The operating channel name and channel type are displayed.

**12 PRIORITY CHANNEL ICON** (p. 13)

Appears when the Priority channel is set.

**13 TAG CHANNEL ICON** (p. 22)

Appears when a Tag channel is selected.

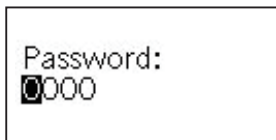

## ■ Turning power ON

- ① Hold down  for 2 seconds to turn the power ON.
- ② If the transceiver is programmed with a start-up password, the screen as described below is displayed.
  - ➔ Enter the password digits using [▲] and [▼].
  - ➔ To select the digit to edit, push [◀] and [▶].
  - ➔ When the password is entered, push [■].



- ➔ If the “Password” screen does not clear after entering the digits, the numbers may be incorrect.

## ■ Adjusting the volume

Push  or  to adjust the audio level. (0 to 32)

- “” appears when the audio level is set to 0 (silent mode).

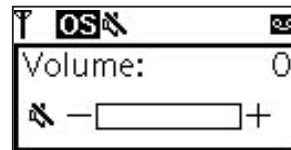

## ■ Selecting a channel



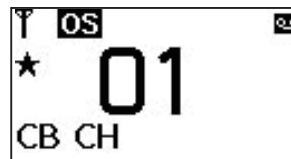



- ➔ Push [▲] or [▼] to select the desired channel.
  - Holding down [▲] or [▼] continuously changes the displayed channel until channel 1 is selected.
  - When channel 1 is selected, beeps sound.
  - “CB CH” is displayed when a CB channel is selected, “Repeater CH” is displayed when a repeater channel is selected, and “Receive CH” is displayed when a receive channel is selected.





### ◇ Zone selection

(Selectable only when more than two zones are set.)

- ① Push  to enter the menu mode.
- ② Push  or  to select "Zone," and then push  to enter the zone selecting screen.
- ③ Push  or  to select the desired zone, and then push  to set.

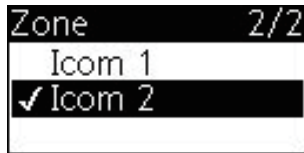







- ④ Push  to exit the menu mode.

### NOTE:

- 'CB 05,' 'RPT05' and 'CB 35' channels are used for emergency.
- No voice transmissions are permitted on 'CB 22' and 'CB 23' (voice operation is inhibited on these channels.)

## ■ Receiving and transmitting

### Receiving:

- ① Hold down  for 2 seconds to turn ON the power.
  - If "TSQL" is displayed on the screen, push  to enter the setting menu, and then select "Tone SQL" to enter the tone squelch menu and select "Off" to cancel the tone squelch or pocket beep. (pp. 26, 27)  
Push  to exit the menu mode.
- ② Push  or  to select the desired operating channel (p. 10).
  - When receiving a signal, the TX/RX indicator lights green, and audio is heard from the speaker.
  - Further adjustment of volume level may be necessary at this point. (p. 10)
  - Hold down  for 2 seconds to turn the Monitor function ON or OFF.

### 3 BASIC OPERATION

#### ■ Receiving and transmitting (Continued)

##### **Transmitting:**

Wait for the channel to become clear to avoid interference.

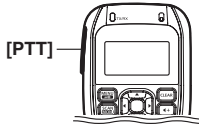

- ① Hold down [PTT] and speak at your normal voice level.
  - When transmitting, the TX/RX indicator lights red.
  - See page 18 for the PTT Hold function details.
- ② Release [PTT] to receive.
- ③ Select the output power if necessary.
  - “L” appears on the screen when low power is selected.



##### **IMPORTANT:**

- To maximize the readability of your signal;
1. Pause briefly after pushing [PTT]. This will ensure the first part of your message is not cut off.
  2. Hold the microphone 5 to 10 cm from your mouth.

##### ◇ **Setting the output power level**

- ① Push [▲] or [▼] to select the desired channel.
- ② Push  to enter the menu mode.
- ③ Push [▲] or [▼] to select “RF Power,” and then push [▶].
  - Enters the output power level selection screen.
- ④ Push [▲] or [▼] to select “Low” or “High,” and then push  to set.
- ⑤ Push  to exit the power level selecting screen.

##### ◇ **Transmitting notes**

###### • **Transmit inhibit function**

The transceiver has several inhibit functions that restrict transmissions under the following conditions:

- The channel is busy or a unmatched CTCSS/DTCS is received. (Depending on the transmission lockout function setting.)
- The selected channel is a “receive only” channel.

###### • **Time-out timer**

After a continuous transmission (example: continuously holding down [PTT]), a time-out timer will be activated, causing the transceiver to stop transmitting and automatically revert to receive.

## ■ Priority channel

The Priority channel is simply recalled by momentarily pushing [■] in the operating mode. It is also automatically monitored during a Group scan or Priority scan.

You can set only one channel as the Priority, and “P” is displayed when it is set.

### ◇ Setting the Priority channel

- ① Select the desired channel. (p. 10)
- ② Hold down [■] for 2 seconds to set the displayed channel as the Priority channel.
  - “P” appears on the screen.

“P” appears

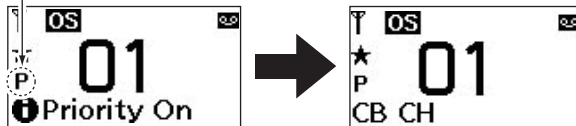

The selected channel is set to the Priority channel.

### ◇ Canceling the Priority channel

- ① Push [■] to select the Priority channel.
- ② Hold down [■] for 2 seconds to cancel the Priority channel setting.
  - “P” disappears.

“P” disappears

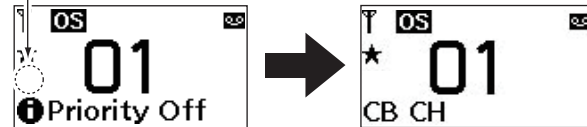

The Priority channel is canceled.

### 3 BASIC OPERATION





#### ■ Monitor

This function is used to listen to weak signals, or to manually open the tone squelch.

- ➔ Hold down  for 2 seconds to turn the Monitor function ON or OFF.
  - The “TX/RX” indicator blinks while the function is ON.



#### ■ Lock







This function electronically locks all keys except for [PTT], , , , and  (holding down for 2 seconds) to prevent accidental changes and function access.

- ➔ Hold down  for 2 seconds to set the Lock function ON or OFF.



#### ■ Adjusting the squelch level

Adjust the noise squelch level between 0 and 9. In order to receive signals properly, as well as for the scan to function effectively, the squelch must be adjusted to the proper level.







- ① Push  to enter the menu mode.
- ② Push [>] or [>] to select “SQL,” and then push [>] to enter the squelch adjusting mode.
- ③ Push [>] or [>] to adjust the squelch level between 0 and 9, and then push [>] to set.



- ④ Push  to exit the menu mode.

## ■ Backlight

The transceiver has backlight modes for night-time and low-light operations.

- ① Push  to enter the menu mode, and then select “Settings.”
- ② Push  or  to select “Backlight,” and then push  to enter the display backlight selecting mode.
- ③ Push  or  to select the desired display backlight mode, and then push  to set.
  - **Off:** No Backlight.
  - **Auto:** Lights for 5 seconds when any key except [PTT] is pushed, or when a Selcall signal is transmitted or received.
  - **Auto2:** Lights for 5 seconds when any key except [PTT] is pushed, when a Selcall signal is transmitted, or when the displayed is changed.
  - **On:** Backlight is continuously lit.





Push  to select “On.”

- ④ Push  to exit the backlight setting mode.

## ■ Voice recorder

The transceiver has a voice recorder function for recording messages. You can turn the function ON in the set mode. The received message is automatically recorded and saved. (p. 19)

### ◇ Recording a message





- ➔ Hold down  for 2 seconds to standby for recording.
  - The recording starts when a signal is received.
- ➔ Hold down for 2 seconds  again to stop recording.
  - The recorded message is saved in the “Rec Data” menu.
  - You can access the “Rec Data” menu by pushing .



← Displayed when the Voice Recorder function is turned ON and there are recorded messages.

- “●” blinks while recording and “||” is displayed while recording is paused.

### ◇ Playing the recorded message

- ① Push  to access the “Rec Data” menu.
- ② Push  or  to select the message to play between the 10 latest messages.
- ③ Push  to play the message.

**NOTE:** The transceiver can record up to 10 latest messages. If the number exceeds, the oldest message is automatically deleted.



## ■ Set mode

In the Set mode, you can change various common settings for the transceiver, or individual settings for the operating channel. Essentially, you can customise the transceiver to suit your preference and operating style.

The functions you can use may differ, depending on the presetting set with the CS-450 CLONING SOFTWARE.

**NOTE:** You can access the Set mode by pushing , and then selecting the “Settings” item.

### ◇ Set mode operation

- ① Push  to enter the menu mode.
- ② Push [▲] or [▼] to select “Settings,” and then push [▶].
- ③ Push [▲] or [▼] to select the desired item, and then push [▶].
- ④ Push [▲] or [▼] to select the desired value of the item, and then push [■] to set.
- ⑤ Push  to exit the menu mode.

### ◇ Set mode list

Item	Default	Ref.
• CTCSS/DTCS	01:67.0 (CTCSS)	p. 17
• Mic Gain	3	
• Roger Beep	OFF	
• Beep	ON	
• Beep Level	High	
• Scan Resume	5sec No Signal	
• Scan Restart	OFF	
• Lockout	OFF	
• Power Timer	OFF	
• Internal SP	ON	
• Voice Guidance	ON	p. 18
• Signal Indication	OFF	
• PTT Hold	OFF	
• Contrast	5	
• Backlight	ON	
• Brightness	4	p. 19
• Voice Recorder	ON	
• Clear Rec Data	No	
• Noise Cancel	OFF	
• Reset	No	
• Mic Hanger	OFF	

## ■ SET mode items

### ◇ CTCSS/DTCS

Select the desired CTCSS tone frequency or DTCS code.

- The selected CTCSS tone frequency or DTCS code is displayed on the operating screen when the tone squelch is set to ON or Pocket Beep is selected.

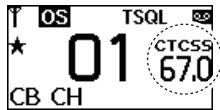

CTCSS tone frequency mode (default)

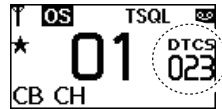

DTCS code mode

### ◇ Mic Gain

Set the microphone gain level between 1 (Minimum) and 5 (Maximum). (Default: 3)

### ◇ Roger Beep

This function transmits a beep to inform that the transmission is completed.

You can turn the function ON or OFF. (Default: OFF)

### ◇ Beep

This function emits a beep when a key is pushed or held down. You can turn the function ON or OFF. (Default: ON)

### ◇ Beep Level

Set the beep output level to High or Low. (Default: High)

### ◇ Scan Resume

The Scan Resume can be set as a pause (5sec No Signal) or timer scan (5sec/10sec/15sec). When signal disappears, scan resumes after the set period of time. (Default: 5sec No Signal)

- 5sec/10sec/15sec: Scan pauses for 5, 10, or 15 seconds when a signal is detected, and then resumes.
- 5sec No Signal: Scan pauses until the signal disappears, and then resumes after 5 seconds (Recommended setting).

### ◇ Scan Restart

This function starts the scan after transmitting during a scan after 10 seconds. You can turn the function ON or OFF.

- Except for the Repeater search scan.

(Default: OFF)

### ◇ Lockout

Select the transmission Lockout (temporary inhibits transmission) function. (Default: OFF)

Repeater: You can transmit only while receiving a matched CTCSS tone, or receiving no signal.

Busy: Transmission is inhibited while receiving a signal.

OFF: No restriction for receiving a signal.

## 4 SET MODE

### ◇ Power Timer

This function turns OFF the transceiver when this set period of time has passed without a key operation.

Set the desired time to turn OFF the transceiver to between 0.5 and 4.0 hours, or OFF. (Default: OFF)

### ◇ Internal SP

The internal speaker function is set, if audio is heard from the HM-212 or an external speaker (if connected.)

(Default: ON)

ON: The audio from the HM-212 is heard, even when an external speaker is connected.

Auto: The audio from the HM-212 is muted, and then “” appears on the function display.

(The audio comes from the HM-212 when the external speaker is not connected.)

### ◇ Voice Guidance

This function announces the channel type and number when you select a channel. Turn the function ON or OFF.

(Default: ON)

### ◇ Signal Indication

The signal indication changes the transceiver’s display when a Selcall code or roger beep is transmitted. “Roger Beep” is displayed while transmitting a roger beep, and “Selcall” is displayed while transmitting a Selcall code. (Default: OFF)

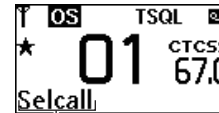

Displayed when a Selcall code is transmitted.

### ◇ PTT Hold

You can use the PTT switch as a one-touch PTT switch (each push toggles between transmit and receive). You can transmit without holding down the PTT switch using this function. The transmission automatically stops after 3 minutes. (Default: OFF)

### ◇ Contrast

You can adjust the display contrast level between 0 (the lowest) and 7 (the highest). (Default: 5)



### ◇ Backlight

You can change the backlight modes for night-time and low-light operations. Select the desired mode. (Default: ON)

- **Off:** No Backlight.
- **Auto:** Lights for 5 seconds when any key except [PTT] is pushed, or when a Selcall signal is transmitted or received.
- **Auto2:** Lights for 5 seconds when any key except [PTT] is pushed, when Selcall signal is transmitted, or when the display is changed.
- **On:** Backlight is continuously lit.

### ◇ Brightness

Adjust the backlight brightness level between 0 (Minimum) and 7 (Maximum). (Default: 4)

### ◇ Voice Recorder

This function records a message. Turn the function ON or OFF. (Default: ON)

### ◇ Clear Rec Data

You can clear the recorded audio by selecting “Yes” in this menu item. (Default: No)

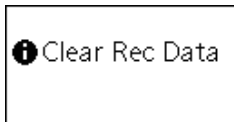

This message is displayed while clearing the recorded data.

### ◇ Noise Cancel

This function allows clear communication by reducing the surrounding noise, especially the low frequency noise received by the microphone. Turn the function ON or OFF. (Default: OFF)

### ◇ Reset

You can reset the transceiver's settings to the factory defaults by selecting “Yes” in this menu item. (Default: No)

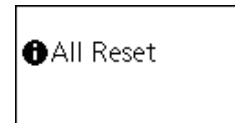

This message is displayed while resetting to the factory defaults.

### ◇ Mic Hanger

You can activate the AF Mute and the Volume Control functions. Turn the function ON or OFF. (Default: OFF)

## ■ Repeater operation

Repeaters extend the operational range of the transceiver by retransmitting the received signals. They are usually located on the top of a building or a mountain, as the elevation increases their effectiveness, allowing the user to transmit and receive over greater distances. During a standard operation, or simplex, transceivers transmit and receive on the same frequency. When operating in the Duplex mode (example: accessing a repeater), the transceiver will transmit and receive on different frequencies. It automatically does this when one of the repeater channels is selected.

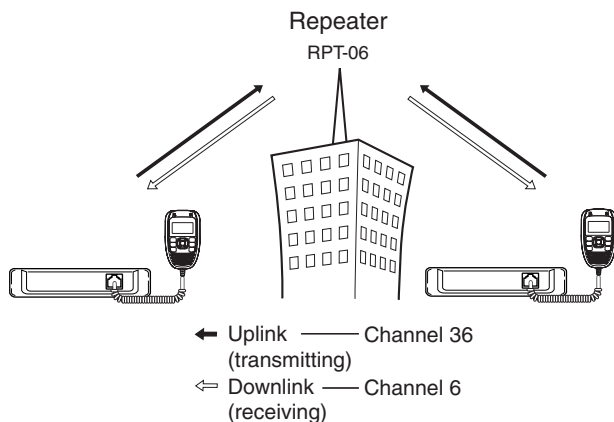

### ◇ Accessing a repeater

A repeater amplifies received signals, and retransmits them on a different frequency, allowing you to communicate over greater distances with improved reliability. To use a repeater, a repeater channel must be selected (Repeater CH 1 to 8, and 41 to 48).

You can search the accessible repeater in your local area using the Repeater search scan function. (p. 25)

- ① Select the desired repeater channel (Repeater CH 1 to 8, and 41 to 48).(p. 10)



- ② Hold down [PTT] and speak at your normal voice level.
  - The TX/RX indicator lights red.
- ③ Release [PTT] to receive.

#### NOTE:

Repeater channel 5 is only for emergency.

## Scan types

The transceiver has 4 scan types, a Tag function and 4 Resume options, for scanning versatility.

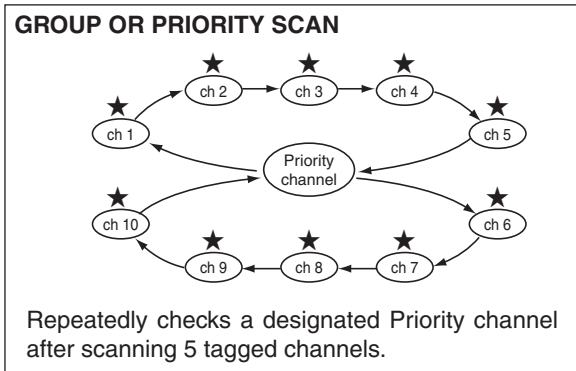
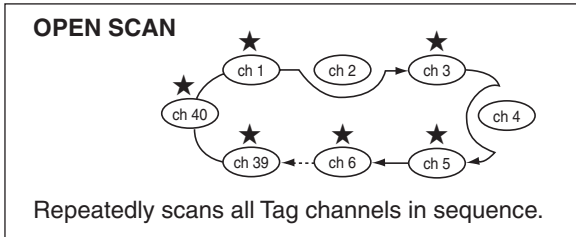

Tag channels are independently set for Open, Group and Priority scans. All channels may be preset as tag channels for all scans.

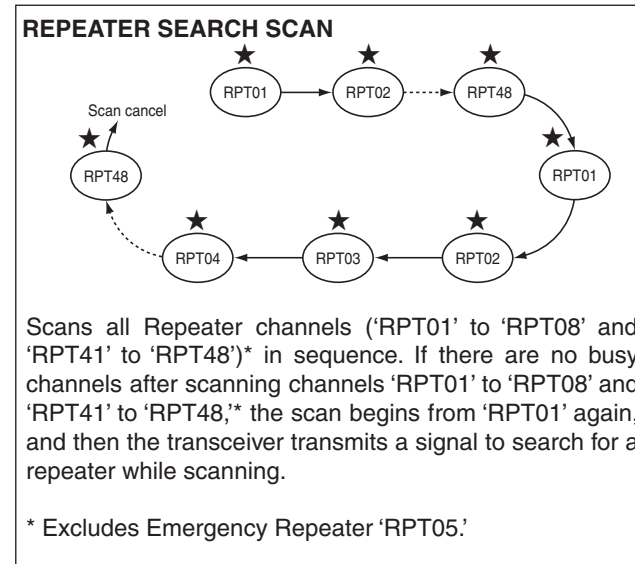







## 6 SCAN

### ■ Scanning preparation

The IC-450 scans all tagged channels when a scan is activated. When the IC-450 finds a busy channel, it can be set to pause, or to resume after a pause. (Except for the Repeater search scan).

- See pages 17 and 23 for the details on the Scan Resume function. (Default: 5sec No Signal)

#### ◇ Selecting the scan mode



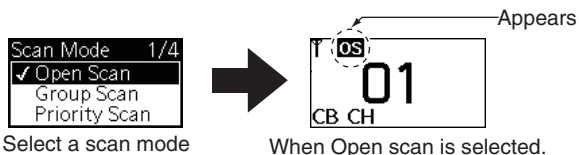



- ① Push  to enter the menu mode.
- ② Push  or  to select “Scan Mode.” (“Scan” > “Scan Mode”)
- ③ Push  or  to select the desired scan mode, and then push  to set.
  - “OS (Open Scan),” “GS (Group Scan),” “PS (Priority Scan),” or “RS (Repeater Scan)” is displayed on the standby mode screen.



- ④ Push  to exit the menu mode.

#### ◇ Tag channel setting

Before setting the tag channels, you must select the desired scan mode, as described in the left column.

- ① Push  to enter the menu mode.
- ② Push  or  to select “Tag.” (“Scan” > “Tag”)
- ③ Push  or  to select a channel, and then select ON or OFF to set it as a Tag channel, and then push Push  to set it.
  - “★” appears when the tag setting is ON (The channel is set as a scan channel).

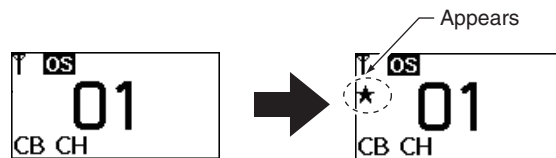







Example:

When channel 01 is set as a tag channel for open scan.

#### /// To speed up the scan:

- For an Open scan, cancel the Tags to skip undesired channels such as busy channels.
- For Group scan, set only often-used channels as tag channels.
- All memory channels may be set as tag channels by default.

### ◇ Scan resume mode

- ① Push  to enter the menu mode.
- ② Push  or  to select “Scan Resume.”  
 (“Settings” > “Scan Resume”)
- ③ Push  or  to select the desired scan resume mode, and then push  to set.
  - 5sec: Scan pauses for 5 seconds, and then resumes.
  - 10sec: Scan pauses for 10 seconds, and then resumes.
  - 15sec: Scan pauses for 15 seconds, and then resumes.
  - 5sec No Signal: Scan pauses until the signal disappears, and then resumes 5 seconds after the signal has disappeared.

5sec No Signal is recommended for normal use, and is set as the default.

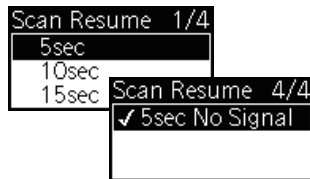

- ④ Push  to exit the menu mode.

## ■ Open scan

An Open scan automatically searches for transmitted signals and enables you to locate new stations for communication or listening.

### /// IMPORTANT!

An Open scan can transmit on a start channel or busy channel.

- ① Select “Open Scan” in the “Scan Mode” menu. (p. 22)
  - “OS” appears on the operating screen.

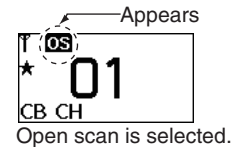

- ② Push  to start the Open scan.

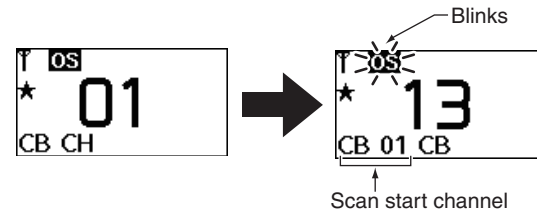

- ③ When receiving a signal, the scan pauses and resumes, according to the selected Scan resume mode (see to the left.)
- ④ Push  to cancel the scan.

## ■ Group scan and priority scan

Group and priority scans repeatedly look for a signal on the priority channel while scanning the specified channels. This is useful when waiting for a call on the priority channel or several specified channels.

The Group and Priority scans are performed differently when transmitting. The Group scan can transmit on a priority channel or on a busy channel, and the Priority scan can transmit only on a priority channel.

- ① Select “Group Scan” or “Priority Scan” in the “Scan Mode” menu. (p. 22)
  - “GS” appears when a Group scan is selected, and “PS” appears when a Priority scan is selected.

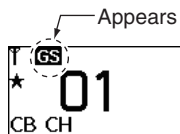

Group scan is selected.

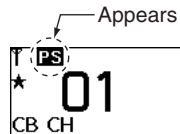

Priority scan is selected.

- ② When the priority scan type is selected in step ①, set the Priority channel, if desired. (p. 13)
  - If the priority channel is not set, the scan start channel is monitored during a Priority scan.

- ③ Push  to start the scan.

Group scan

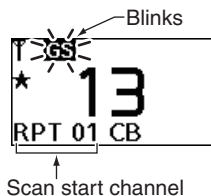

Priority scan

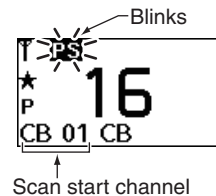

- ④ When receiving a signal, the scan pauses and resume, according to the selected scan resume mode. (pp. 17, 23)
- ⑤ Push  to cancel the scan.

## ■ Repeater search scan

The Repeater search scan is used not only to search for a signal on the repeater channels, but also to access a repeater by automatically transmitting in sequence. The Repeater search function detects repeaters that can be accessed in the area, even if the repeater is not used.

▨ The Repeater search scan detects signals only on the Channels 1 to 8\* and 41 to 48. Therefore, the repeater cannot be guaranteed even though the Repeater scan is stopped, because the scan will stop if any activity is detected. (The scan is cancelled while receiving a signal, such as stations communicating in Simplex operation on a repeater output channel.)

\*Does not include the emergency repeater 'RPT05.'

- ① Select the desired repeater channel (1 to 8, and 41 to 48), and then push  to start the Repeater search scan.
  - See the flow to the right for details.

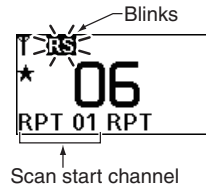

- ② When a signal is received on a repeater channel, the scan stops.
  - During the second cycle scanning, 3 high beeps sound when a signal is received, and 3 low beeps sound when no signal is received.
- ③ Push  to cancel the scan.
  - While transmitting, the Repeater scan cannot be cancelled.

## ◇ Repeater search scan

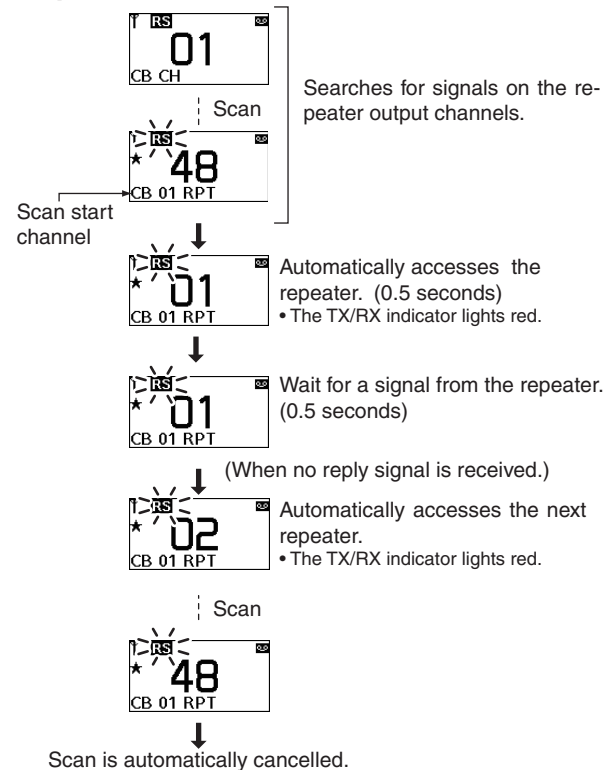







**NOTE:** Excludes the emergency repeater 'RPT05.'

## ■ Tone squelch

The transceiver is equipped with 51 CTCSS tone frequencies, and 104 DTCS codes. CTCSS/DTCS operation enables you to communicate in the silent standby mode, since you will only receive calls from group members using the same CTCSS tone frequency or DTCS code.

**NOTE:** Channels 5 and 35 are used for the emergency channels, and the CTCSS/DTCS function is not selectable on those channels.

### ◇ Setting CTCSS tone frequency/ DTCS code

- ① Push  to enter the menu mode.
- ② Push  or  to select “CTCSS/DTCS.” (“Settings” > “CTCSS/DTCS”)
- ③ Select between “CTCSS” and “DTCS” to enter the setting mode.
- ④ Push  or  to set the desired CTCSS tone frequency or DTCS code, and then push  to set.

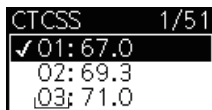

List number (grey line)  
CTCSS setting mode.

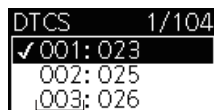

List number (grey line)  
DTCS setting mode.

- ⑤ Push  to exit the menu mode.

#### • CTCSS tone



CTCSS tone frequency

#### • DTCS code

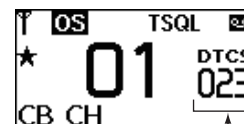

DTCS code

- The selected CTCSS tone frequency or DTCS code is displayed on the operating screen, when the tone squelch is set to ON or Pocket Beep is selected.

#### **NOTE:**

- The selectable CTCSS tone frequencies and DTCS codes are listed on the next page.
- The transceiver has 51 tone frequencies and consequently their spacing is narrow, compared to units having 38 tones. Therefore, some tone frequencies may receive interference from adjacent tone frequencies.



• Selectable CTCSS tone frequency list (Hz)

No.	Freq.	No.	Freq.	No.	Freq.	No.	Freq.	No.	Freq.
01	67.0	12	94.8	23	136.5	34	177.3	45	218.1
02	69.3	13	97.4	24	141.3	35	179.9	46	225.7
03	71.0	14	100.0	25	146.2	36	183.5	47	229.1
04	71.9	15	103.5	26	151.4	37	186.2	48	233.6
05	74.4	16	107.2	27	156.7	38	189.9	49	241.8
06	77.0	17	110.9	28	159.8	39	192.8	50	250.3
07	79.7	18	114.8	29	162.2	40	196.6	51	254.1
08	82.5	19	118.8	30	165.5	41	199.5		
09	85.4	20	123.0	31	167.9	42	203.5		
10	88.5	21	127.3	32	171.3	43	206.5		
11	91.5	22	131.8	33	173.8	44	210.7		







• Selectable DTCS code list

No.	Code	No.	Code	No.	Code	No.	Code	No.	Code
01	023	22	131	43	251	64	371	85	532
02	025	23	132	44	252	65	411	86	546
03	026	24	134	45	255	66	412	87	565
04	031	25	143	46	261	67	413	88	606
05	032	26	145	47	263	68	423	89	612
06	036	27	152	48	265	69	431	90	624
07	043	28	155	49	266	70	432	91	627
08	047	29	156	50	271	71	445	92	631
09	051	30	162	51	274	72	446	93	632
10	053	31	165	52	306	73	452	94	654
11	054	32	172	53	311	74	454	95	662
12	065	33	174	54	315	75	455	96	664
13	071	34	205	55	325	76	462	97	703
14	072	35	212	56	331	77	464	98	712
15	073	36	223	57	332	78	465	99	723
16	074	37	225	58	343	79	466	100	731
17	114	38	226	59	346	80	503	101	732
18	115	39	243	60	351	81	506	102	734
19	116	40	244	61	356	82	516	103	743
20	122	41	245	62	364	83	523	104	754
21	125	42	246	63	365	84	526		

## ■ Pocket beep

This function uses the CTCSS (subaudible) tone and the DTCS code for calling, and you can use it as a “common pager” to inform you that someone has called while you were away from the transceiver.

### ◇ Waiting for a call from a specific station

- ① Select a desired channel (except for channels 5 and 35).
- ② Push  to enter the menu mode.
- ③ Push  or  to select “Tone SQL” in the menu mode, and then push  to select “Pocket Beep.”
- ④ Push  several times to exit the menu mode.
  - “TSQL ” appears.
- ⑤ When the received signal includes a matching tone or code, the transceiver sounds a beep every 10 seconds and “” blinks.

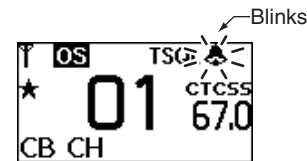

- ⑥ Push  to answer and to stop the blinking.
  - Tone squelch is automatically selected.

# 8

## SELCALL (Selective Calling)

In addition to the tone squelch function for silent standby, you can use the Selcall (Selective Calling) function. For the tone squelch function (Group mode), there are 51 tone/code options when making a call. Selcall has 100,000 options when using 5 tone.

Other options in Selcall are for calling another unit or Group operation on the same channel, as well as station code and name information, status messages, the answer back function and auto scan start. These, and many more, can be set using the optional CS-450 CLONING SOFTWARE.

### NOTE:

- Channels 5 and 35 are the emergency channels, and Selcall cannot be used on these channels.
- A Selcall transmission is restricted to a total of 3 seconds per minute.

## ■ Calling

### ◇ TX code channel selection

TX code is a Selcall code that you can transmit. A maximum of 32 TX code channels can be entered into the IC-450, using the optional CS-450 CLONING SOFTWARE.

### ◇ To select a TX code channel

- ① Select the desired CB channel except for channels 5 and 35.
- ② Push  to enter the menu mode.
- ③ Push [▲] or [▼] to select "Tx Code" to enter the TX code channel selection mode.  
("Selcall" > "Tx Code")
  - If the channel name is entered, the channel name is displayed instead of the TX code.
- ④ Push [▲] or [▼] to select the desired TX code channel, and then push [■] to set.

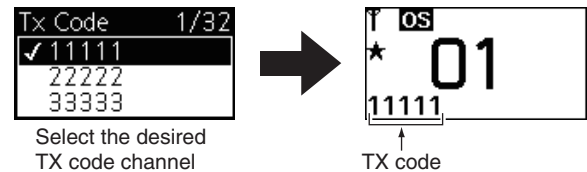





- ⑤ Push [PTT] to transmit on the selected TX code channel.
  - The TX/RX indicator lights red while transmitting.

### ✓ CONVENIENT!

A TX code channel name can be assigned to all the 32 TX code channels using the CS-450 CLONING SOFTWARE. The TX code channel name allows you to select the channel easier or to find the channel user.

◇ **TX code edit**

You can change the TX code contents within the allowed digits. The Group call function enables you to edit a special 'Group code' of the Selcall ID code.

- ① Select the desired CB channel except for channels 5 and 35.
- ② Push  to enter the menu mode.
- ③ Push  or  to select "Edit Code" to enter the code edit mode.  
("Selcall" > "Edit Code")
- ④ Select a code to start the TX code edit.
- ⑤ Push  or  to select the digit to edit.

The editable digit is selected

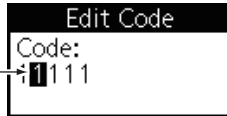

- ⑥ Push  or  to select the desired number.



- ⑦ Repeat steps ⑤ and ⑥ to edit other digits.
- ⑧ Push  to set the edited code.
  - The edited code is displayed on the TX code channel selection mode.

**NOTE:** The TX code's editable digits can only be set, or changed using the CS-450 CLONING SOFTWARE.

✓ **CONVENIENT!**

You can also transmit on the selected channel's TX code by selecting "Transmit" in the "Selcall" menu item.



Select to transmit

## 8 SELCALL (Selective Calling)

### ■ Receiving

#### ◇ Receiving an individual call

- ① When receiving an RX code (default setting):
  - Beeps sound.
  - The received code channel name is displayed, if entered.
  - “🔔” blinks and the channel name is displayed, and the Selcall mute is released if the Quiet mode is activated.
  - “🔔” blinks and the channel number is displayed when the channel name is not entered.
- ② While holding down [PTT], speak into the microphone at your normal voice level.

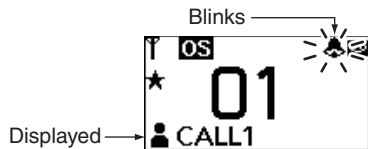

/// **NOTE:** If the ID decode function “ID Dec” is turned ON, the received ID code is displayed instead of the channel name, and memorised into the transceiver. This function can be turned ON using the CS-450 CLONING SOFTWARE.

- RX code displays the Receiving Selcall code. A maximum of 8 individual call channels can be entered into the transceiver, using the CS-450.
- You can set the transceiver’s mode when receiving an individual call using the CS-450. See the Help file for setting details.

#### ◇ Recalling a memorised received ID code

- ① Push  to enter the menu mode.
- ② Push [▲] or [▼] to select “History” to display the memorised received ID.  
 (“Selcall” > “History”)
- ③ Push [▲] or [▼] to select the desired received ID code, and then push [■] to set.
- ④ Push [PTT] to transmit the code on the selected channel.

#### ◇ Receiving a Group call



- ① When receiving a Group call (default setting):
  - Beeps sound.
  - “🔔” blinks and “GROUP” is displayed, and the Selcall mute is released if the Quiet mode is activated.
- ② While holding down [PTT], speak into the microphone at your normal voice level.



/// You can set the transceiver’s mode when receiving a Group call with the CS-450. See the Help file for more information.

## ■ Quiet mode

When the Quiet mode is turned ON, the Selcall mute is activated and allows Silent operation until receiving a Selcall.

- ① Push  to enter the menu mode.
- ② Push  or  to select “Quiet Mode,” and then select “On” to turn ON the Quiet mode.
  - “Q” appears when the Quiet mode is used.

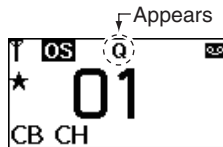

### To monitor the channel:

- Hold down  for 2 seconds to release the mute (audio is heard).
  - The TX/RX indicator blinks when the Monitor function is used.



### To enable Selcall mute:

While the TX/RX indicator blinks, hold down  for 2 seconds to mute the channel.

The TX/RX indicator stops blinking.



**NOTE:** The Unmute mode may automatically return to the Mute mode after a specified time period, depending on the presetting.

## ■ Stun





If the transceiver is in the Stun mode, it will request a password when you turn ON the power. This password is the same as the Power ON function password. Once the password has been entered, the transceiver will not prompt to enter it again.

Cloning and transceiver operations are disabled after a kill ID is received. By activating the clone write mode, you can use the transceiver again. (The internal data cannot be accessed using the clone read mode.)

## Smart Ring and ATS (Automatic Transponder System)

These functions have an answer back feature and confirmation function for when a call has reached the called station, even if the user is temporarily away from the transceiver. Smart Ring is a manual confirmation, and ATS is automatic.

### Smart Ring

- Set the same CTCSS tone frequency to all Group transceivers, and then turn ON the tone squelch. (p. 26)
- Push  to enter the menu mode.
- Push  or  to select “Transponder” in the menu mode.
- Select “Smart Ring” to transmit a Smart Ring call.
  - The TX/RX indicator lights red.
  - When a member of the group answers the call, “” blinks, and “Found” is displayed, and then the TX/RX indicator lights green and turns OFF.
  - If no answer is received, the transceiver will sound short faint beep tones and “Not Found” is displayed.









- Push [PTT] to answer and stop the blinking.

 **NOTE:** This function is available only if the called station has the same CTCSS tone frequency and is operating on the same channel.

### NOTE:

- The setting to the left is for only the calling station. A called station automatically sends an answer back signal without any presetting. All the IC-450s set to the same operating channel within the communication area, will send an answer back call.

### ATS

- Push  to enter the menu mode.
- Push  or  to select “Transponder” in the menu mode.
- Select “ATS,” and then select “On” to turn ON the ATS function.
  - When an RX channel is selected, an error beep sounds.
  - The transceiver starts to send searching signals every 60 seconds.
  - The TX/RX indicator lights red and “” starts blinking.
  - When the transceiver receives an answer back signal, “” stays ON until the next search.
  - If no reply is received, “” blinks until the next search.

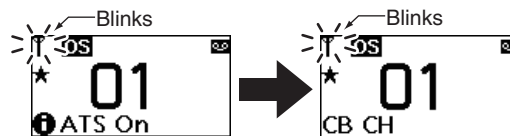



- Select “Off” to turn OFF the ATS function.

## ■ RX frequency (for RX only channels)



The RX channel frequency can be set to between 450 and 520 MHz.

### ◇ RX channel setting

The RX channels are set to “Disable,” and they are not displayed on the screen as the default setting. The RX channels need be set to “Enable” in order to set the RX frequency.

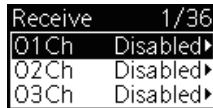
- While holding down  and , hold down  to turn ON the transceiver power.
  - The RX channel list screen is displayed as shown below.



- Push  or  to select the desired RX channel, and then select “Enable.”

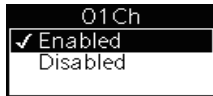





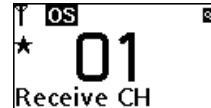

- Hold down  to turn OFF the transceiver power, and then turn ON again for the operating mode.



### ◇ RX frequency setting

- Push  or  to select the desired RX channel.



- Push  to enter the menu mode.
- Push  or  to select “RX VFO” to enter the RX frequency editing mode.
- Push  or  to select the digit to edit, and then push  or  to change the selected digit.
  - You can enter between 450 and 520 MHz. (12.5 kHz steps)



- Repeat step ④ to enter the desired frequency.
- Push  to set the RX frequency.
  - Two beeps sound.
- Push  several times to return to the operating mode.

## 9 OTHER FUNCTIONS

### ■ Data cloning

Data cloning enables you to transfer the data quickly and easily from a PC to your transceiver, using the optional CS-450 CLONING SOFTWARE.

Data cloning can be done to or from a PC, using the CS-450 CLONING SOFTWARE and the optional OPC-1122U (USB type) cloning cable.

- Refer to the CS-450 CLONING SOFTWARE's Help file for details.

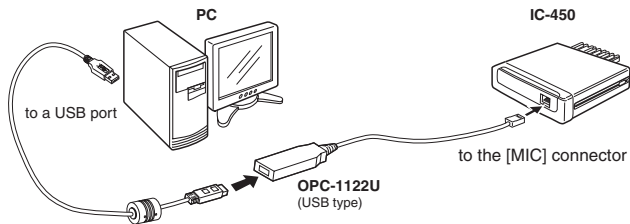

### ■ All reset

The function display may occasionally display erroneous information. This may be caused externally by static electricity or by other factors. If this problem occurs, turn OFF the power, and then after a few seconds, turn ON the power again. If the problem persists, perform the following procedure.

#### /// IMPORTANT!:

Resetting the transceiver sets all values to their defaults.

- ➔ While holding down **[MENU]**, **[←]**, and **[CLEAR]**, hold down **[POWER]** for 2 seconds to turn ON the transceiver power.
  - Resets the CPU.
  - "All Reset" appears on the function display.

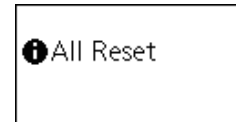



## ■ Specifications

### ◇ General

- Frequency coverage
  - CB: 476.425–477.4125 MHz
  - RX: 450.000–520.000 MHz (RX only)
- Mode: 8K50F3E
- Number of channels: Max 128ch/8 banks
- Antenna impedance: 50 Ω
- Input impedance: 600 Ω
- Output impedance: 4 Ω
- Intermediate frequency: 1st 46.35 MHz, 2nd 450 kHz
- Operating temperature range: –10°C to +60°C
- Power supply voltage: 13.8 or 27.6 V DC nominal (Negative ground)
- Current drain with HM-212 (approximately)
  - DC 13.8 V:
    - RX stand-by 500 mA
    - RX Maximum audio 1500 mA
    - TX (5 W) 2000 mA
  - DC 27.6 V:
    - RX stand-by 300 mA
    - RX Maximum audio 1000 mA
    - TX (5 W) 1300 mA
- Dimensions: 125 (W) × 29 (H) × 180 (D) mm (Projections not included)
- Weight (approximately): 1011 g (with HM-212)

### ◇ Transmitter

- Output power: 5 W/1 W (selectable)
- Modulation system: Variable reactance frequency modulation
- Max. frequency deviation: ±2.5 kHz
- Frequency error: ±2.5 ppm
- Spurious emissions: Less than –30 dBm
- Adjacent channel power: Less than –16 dBm
- Audio harmonic distortion: 1% typical (60% deviation)
- Residual modulation: 40 dB typical
- Limiting characteristic of modulator: 70 to 100% of maximum deviation

### ◇ Receiver

#### [CB (476.425–477.4125 MHz)]

- Sensitivity (12 dB SINAD): 0.22 μV typical
- Squelch sensitivity: 0.2 μV typical (Threshold)
- Hum and noise: 48 dB typical
- Intermodulation rejection ratio: 72 dB typical
- Spurious response rejection ratio: 80 dB typical
- Adjacent channel selectivity: 68 dB typical
- Conducted spurious radiation: Less than –57 dBm (9 kHz–1.0 GHz)  
Less than –47dBm (1.0 GHz–4.0 GHz)
- Audio output power: 5.0 W typical at 10% distortion with a 4 Ω load
- Audio frequency response: +2 dB to –8 dB of 6 dB/octave from 300 Hz to 2550 Hz (at the 1 kHz reference)

---

# 10 SPECIFICATIONS AND OPTIONS

## ■ Specifications

### ◇ Receiver (Continued)

**[RX (450.000–520.000 MHz)] (Except CB (476.425–477.4125 MHz))**

- Sensitivity (12 dB SINAD): 0.25  $\mu$ V typical
- Hum and noise: 45 dB typical
- Conducted spurious radiation: Less than  $-57$  dBm  
(9 kHz–1.0 GHz)  
Less than  $-47$  dBm  
(1.0 GHz–4.0 GHz)
- Audio frequency response: +2 dB to  $-8$  dB of 6 dB/octave from  
300 Hz to 2550 Hz  
(at the 1 kHz reference)

**All stated specifications are subject to change without notice or obligation.**

## ■ Options

### ◇ Microphone

- **HM-212** HAND MICROPHONE  
Wired remote control microphone with key backlight. The same microphone that is supplied with the transceiver.
- **OPC-2355** EXTENSION CABLE  
2.5 m microphone extension cable. Same cable as supplied with the transceiver.

### ◇ Speaker





- **SP-22/SP-35** EXTERNAL SPEAKER  
Compact and easy to install.

### ◇ Cloning software

- **CS-450** CLONING SOFTWARE + **OPC-1122U** USB CLONING CABLE  
Provides quick and easy entry for items, such as set mode contents, zone type, and so on using the PC's USB terminal.

## ■ Troubleshooting

If your transceiver seems to be malfunctioning, please check the following points before sending it to a service center.

PROBLEM	POSSIBLE CAUSE	SOLUTION	REF.
The transceiver's power will not turn ON.	<ul style="list-style-type: none"> <li>• Power connector has poor contact.</li> <li>• Polarity of the power connection is reversed.</li> <li>• Blown fuse.</li> </ul>	<ul style="list-style-type: none"> <li>• Check the connector pins.</li> <li>• Reconnect the power cable observing the proper polarity.</li> <li>• Repair the cause, then replace the fuse.</li> </ul>	<p>—</p> <p>p. 4</p> <p>p. 38</p>
No sound is heard from the speaker.	<ul style="list-style-type: none"> <li>• Volume is too low.</li> <li>• The volume level is set to 0 (audio muting).</li> <li>• Squelch is set too high.</li> <li>• A selective call or squelch function is activated such as pocket beep or tone squelch.</li> </ul>	<ul style="list-style-type: none"> <li>• Push .</li> <li>• Push .</li> <li>• Set the squelch level to the threshold.</li> <li>• Turn OFF the appropriate function.</li> </ul>	<p>p. 10</p> <p>p. 10</p> <p>p. 14</p> <p>pp. 26–27</p>
Sensitivity is low and only strong signals can be heard.	<ul style="list-style-type: none"> <li>• Antenna feedline or the antenna connector has poor contact or is shorted.</li> </ul>	<ul style="list-style-type: none"> <li>• Check, and if necessary, replace the feedline or solder the antenna connector again.</li> </ul>	p. 5
No contact possible with another station.	<ul style="list-style-type: none"> <li>• The other station is using tone squelch.</li> </ul>	<ul style="list-style-type: none"> <li>• Turn ON the Tone Squelch function.</li> </ul>	p. 26
Cannot change the operating channel.	<ul style="list-style-type: none"> <li>• The lock function is activated.</li> <li>• Priority scan is paused on the watching frequency.</li> </ul>	<ul style="list-style-type: none"> <li>• Hold down  for 2 seconds to turn OFF the Lock function.</li> <li>• Push  to cancel the scan.</li> </ul>	<p>p. 14</p> <p>p. 24</p>
Scan does not start.	<ul style="list-style-type: none"> <li>• The squelch is open.</li> <li>• Priority scan is activated.</li> </ul>	<ul style="list-style-type: none"> <li>• Set the squelch to the threshold point.</li> <li>• Cancel the scan.</li> </ul>	<p>p. 14</p> <p>p. 24</p>

# 11 MAINTENANCE

## ■ Troubleshooting (Continued)

PROBLEM	POSSIBLE CAUSE	SOLUTION	REF.
Transmission continues even when the PTT is released.	<ul style="list-style-type: none"><li>• PTT Hold function is activated.</li></ul>	<ul style="list-style-type: none"><li>• Turn OFF the function.</li></ul>	p. 18
The function display shows erroneous information.	<ul style="list-style-type: none"><li>• The CPU is malfunctioning.</li></ul>	<ul style="list-style-type: none"><li>• Reset the CPU.</li></ul>	p. 34

## ■ Fuse replacement

If the fuse blows or the transceiver stops functioning, find the source of the problem, fix it if possible, and then replace the damaged fuse with a new one, rated at (FGB 10 A) as shown to the right.

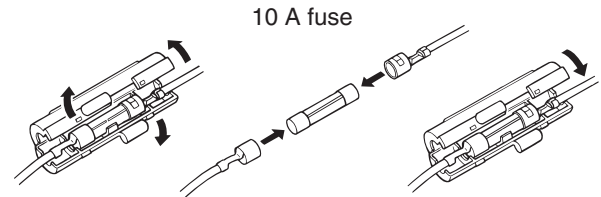

## ICOM LIMITED WARRANTY

Icom Incorporated is proud of its advanced technology and the high quality of workmanship and components included in the production of every product. Our goods come with guarantees that cannot be excluded under the Australian Consumer Law. You are entitled to a replacement or refund for a major failure and for compensation for any other reasonably foreseeable loss or damage. You are also entitled to have the goods repaired or replaced if the goods fail to be of acceptable quality and the failure does not amount to a major failure. Icom (Australia) Pty. Ltd., the authorised Icom Distributor, warrants this Icom product within Australia to be free from defects in material or workmanship for the applicable period indicated below:

- **Radios:**

**Three (3) years** from the date of purchase, (excluding accessories), when purchased from an Australian authorised Icom Dealer.

- **Accessories:**

**One (1) year** from the date of purchase, when purchased from an Australian authorised Icom Dealer.

(i.e. battery, antenna, battery chargers etc)

Icom (Australia) Pty. Ltd. will, at its discretion, and subject to the terms and conditions stated below, repair or replace any goods or component parts which after examination are found to be defective.

Unless otherwise expressly provided, any fault arising from defective workmanship or material shall be rectified by Icom where the equipment is returned freight prepaid to Icom (Australia) Attn: Service Dept. Unit 1/103 Garden Rd, Clayton, VIC, 3168. Telephone (03) 9549 7500, Fax: (03) 9549 7505. Email [service@icom.net.au](mailto:service@icom.net.au).

### This warranty shall not apply:

- (a) To an Icom Product which has failed due to improper installation, misuse, accident, alteration or unauthorised repair or modification.
- (b) If any serial number or identification plate attached to the goods has been altered, rendered illegible, or removed
- (c) If the goods have been damaged by corrosion, deterioration or the like contributed to abnormal temperatures; the influence of foreign matter or energy or physical or chemical properties of water, steam or chemical compounds.

- (d) To any Icom product not originally supplied by Icom (Australia) Pty Ltd to an authorised Dealer of Icom (Australia) Pty. Ltd.

**Please check with us if you feel an Icom product is being offered for sale that has been sourced from other than Icom (Australia) Pty Ltd.**

## WARRANTY SERVICE INSTRUCTIONS

If you are experiencing difficulty with your Icom equipment:

1. For warranty claims, complete a repair order form located at: [http://www.icom-australia.com/files/Repair\\_Order\\_Form.pdf](http://www.icom-australia.com/files/Repair_Order_Form.pdf) and send with goods to Icom (Australia) with a brief explanation of the issue.
2. If the fault is related to the use of a particular accessory or accessories, please include these for inspection with the radio, and list these on the repair order form. Icom (Australia) Pty. Ltd. shall assume no liability for the loss or safe return of an accessory item that is not listed.
3. Please contact Icom (Australia) regarding any compensation that may be payable for reasonable expenses incurred in making a warranty claim.
4. If the requested repairs or services are within the terms of warranty, your equipment will be returned after repair (prepaid) to any designated address within Australia.
5. If the requested repairs of service are not within the terms of warranty, or if you fail to provide acceptable evidence of the date of purchase, return freight will be charged.

This warranty is in addition to and does not limit, exclude or restrict your right under the Competition and Consumer Act 2010 or any other protection laws that may apply.

## PRODUCT REGISTRATION

Please log on to [www.icom.net.au](http://www.icom.net.au) to register your Icom product, or complete & return the registration reply page.



Please fold and tape closed

# icom

## REGISTRATION CARD

PLACE  
POSTAGE  
HERE

---

---

---

**Icom (Australia) Pty. Ltd.**

**Unit 1/103 Garden Road  
Clayton VIC 3168**

Cut here

## Purchaser's Details:

Model No: \_\_\_\_\_ Serial No: \_\_\_\_\_ Date of Purchase: \_\_\_\_\_

Dealers Name: \_\_\_\_\_ Receipt No.: \_\_\_\_\_

Purchasers Name: \_\_\_\_\_ P/Code : \_\_\_\_\_

Purchasers Address: \_\_\_\_\_

Email: \_\_\_\_\_ Phone No: \_\_\_\_\_ Occupation: \_\_\_\_\_

## Answering the following question will help us to meet your future needs:

In what media have you seen Icom products advertised?

Newspaper  Magazine  TV  Radio  Website Other: \_\_\_\_\_

Magazines you regularly purchase from the Newsagent: \_\_\_\_\_

I would like more information on the following:

Air Band  Amateur  Commercial Radios  Marine  Receiver  UHF CB

Other Radio Communications Equipment you use: \_\_\_\_\_

Comments: \_\_\_\_\_

\_\_\_\_\_

\_\_\_\_\_

Thank you for completing this Registration, we feel confident you will enjoy the many years of superior performance your Icom equipment provides.











– A –

Accessing a repeater.....20  
 Adjusting the squelch level ..... 14  
 Adjusting the volume ..... 10  
 All reset.....34  
 Antenna .....5  
 ATS .....32

– B –

Backlight ..... 15, 19  
 Battery ..... 4  
 Beep ..... 17  
 Beep Level.....17  
 Brightness ..... 19

– C –

Calling .....28  
 Canceling the Priority channel..... 13  
 Clear Rec Data..... 19  
 Contrast..... 18  
 CTCSS/DTCS..... 17, 26

– D –

Data cloning.....34  
 DC Power supply ..... 4  
 Display ..... 8

– F –

Front and rear panels ..... 6  
 Fuse replacement..... 38

– G –

Group scan and priority scan .....24

– H –

HM-212 Description.....7

– I –

IMPORTANT ..... i  
 Installation and Connection ..... 1  
 Installation methods.....2  
 Internal SP..... 18

– L –

Location ..... 1  
 Lock ..... 14  
 Lockout ..... 17

– M –

Mic Gain ..... 17  
 Mic Hanger ..... 19  
 Microphone.....3  
 Monitor..... 14

– N –

Noise Cancel ..... 19



# INDEX

## – O –

Open scan .....	23
OPERATIONAL NOTES .....	i
Options .....	36

## – P –

Playing the recorded message .....	15
Pocket beep .....	27
Power Timer .....	18
PRECAUTIONS .....	ii
Priority channel .....	13
PTT Hold .....	18

## – Q –

Quiet mode .....	31
------------------	----

## – R –

Recalling a memorised received ID code .....	30
Receiving .....	30
Receiving a Group call .....	30
Receiving and transmitting .....	11
Receiving an individual call .....	30
Recording a message .....	15
Repeater operation .....	20
Repeater search scan .....	25
Reset .....	19
Roger Beep .....	17
RX channel setting .....	33
RX frequency (for RX only channels) .....	33
RX frequency setting .....	33

## – S –

Scanning preparation .....	22
Scan Restart .....	17
Scan Resume .....	17
Scan resume mode .....	23
Scan types .....	21
Selecting a channel .....	10
Selecting the scan mode .....	22
Set mode .....	16
SET mode items .....	17
Set mode list .....	16
Set mode operation .....	16
Setting CTCSS tone frequency/DTCS code .....	26
Setting the output power level .....	12
Setting the Priority channel .....	13
Signal Indication .....	18
Smart Ring .....	32
Specifications .....	35
Stun .....	31
Supplied accessories .....	1

## – T –

TABLE OF CONTENTS .....	iv
Tag channel setting .....	22
Tone squelch .....	26
To select a TX code channel .....	28
Transmitting notes .....	12
Troubleshooting .....	37
Turning power ON .....	10
TX code channel selection .....	28
TX code edit .....	29

– U –

Using the mounting bracket.....2

– V –

Voice Guidance ..... 18

Voice Recorder ..... 15, 19

– W –

Waiting for a call from a specific station .....27

– Z –

Zone selection ..... 11

1
2
3
4
5
6
7
8
9
10
11
12

**Count on us!**

A-7218D-1AU  
Printed in Japan  
© 2015 Icom Inc.

Printed on recycled paper with soy ink.

**Icom Inc.**

1-1-32 Kamiminami, Hirano-ku, Osaka 547-0003, Japan