



SERVICE MANUAL

HF TRANSCEIVER

IC-F8100
IC-F8101

S-15005XZ-C1
August 2013

Icom Inc.

INTRODUCTION

This service manual describes the latest technical information for the **IC-F8101/F8100** HF TRANSCEIVER, at the time of publication.

MODEL	VERSION	VERSION NUMBER	TX POWER	ACCESSORIE
IC-F8101	EXP-01	#01	125W	-
	AUS-01	#02	100W	
	USA-01	#03	125W	
IC-F8100	UN-01	#04	125W	
IC-F8101	EXP-02	#11	125W	RMK-6
	AUS-02	#12	100W	RMK-6
	USA-02	#13	125W	RMK-6
IC-F8100	UN-02	#14	125W	RMK-6
IC-F8101	EXP-03	#21	125W	HM-192
	AUS-03	#22	100W	HM-192
	USA-03	#23	125W	HM-192
IC-F8100	UN-03	#24	125W	HM-192

CAUTION

NEVER connect the transceiver to an AC outlet or to a DC power supply that uses more than the specified voltage. This will ruin the transceiver.

DO NOT expose the transceiver to rain, snow or liquids.

DO NOT reverse the polarities of the power supply when connecting the transceiver.

DO NOT apply an RF signal of more than 20 dBm (100 mW) to the antenna connector. This could damage the transceiver's front-end.

To upgrade quality, any electrical or mechanical parts and internal circuits are subject to change without notice or obligation.



(IC-F8101 [EXP-02])

ORDERING PARTS

Be sure to include the following four points when ordering replacement parts:

1. 10-digit Icom part number
2. Component name
3. Equipment model name and unit name
4. Quantity required

<ORDER EXAMPLE>

1110003491 S.IC TA31136FNG IC-F8101 MAIN UNIT 5 pieces
8820001210 Screw 2438 screw IC-F8101 Top cover 10 pieces

Addresses are provided on the inside back cover for your convenience.

REPAIR NOTES

1. Make sure that the problem is internal before dis-assembling the transceiver.
2. **DO NOT** open the transceiver until the transceiver is disconnected from its power source.
3. **DO NOT** force any of the variable components. Turn them slowly and smoothly.
4. **DO NOT** short any circuits or electronic parts. An insulated tuning tool **MUST** be used for all adjustments.
5. **DO NOT** keep power ON for a long time when the transceiver is defective.
6. **DO NOT** transmit power into a Standard Signal Generator or a Sweep Generator.
7. **ALWAYS** connect a 40/60 dB attenuator between the transceiver and a Deviation Meter or Spectrum Analyzer, when using such test equipment.
8. **READ** the instructions of the test equipment thoroughly before connecting it to the transceiver.

TABLE OF CONTENTS

SECTION 1	SPECIFICATIONS	
SECTION 2	INSIDE VIEWS	
SECTION 3	DISASSEMBLY INSTRUCTION	
SECTION 4	CIRCUIT DESCRIPITON	
4-1	RECEIVER CIRCUITS.....	4-1
4-2	TRANSMITTER CIRCUITS.....	4-2
4-3	FREQUENCY SYNTHESIZER CIRCUITS	4-4
4-4	VOLTAGE BLOCK DIAGRAM	4-4
4-5	PORT ALLOCATIONS	4-5
SECTION 5	ADJUSTMENT PROCEDURES	
5-1	PREPARATION	5-1
5-2	FREQUENCY ADJUSTMENT	5-3
5-3	TRANSMIT ADJUSTMENT	5-4
5-4	RECEIVE ADJUSTMENT	5-5
SECTION 6	PARTS LIST	
SECTION 7	MECHANICAL PARTS	
SECTION 8	BOARD LAYOUTS	
SECTION 9	GENERAL WIRING	
SECTION 10	BLOCK DIAGRAM	
SECTION 11	VOLTAGE DIAGRAM	

General

- Frequency coverage:

Receive	0.5–29.9999 MHz
Transmit	1.6–29.9999 MHz
- Mode:

AUS versions	J3E (USB), A3E (AM; RX only)
Other versions	J3E (USB/LSB), A3E (AM; RX only) A1A (CW), F1B (FSK), J2B (D1, D2, D3)
- No. of memory Ch.: 500 channels (maximum)
- Usable temp. range: –30°C to +60°C;
–22°F to +140°F
- Frequency stability: ±0.3 ppm
(–30°C to +60°C; –22°F to +140°F)
- Antenna impedance: 50 Ω
- Power supply: 13.8 V DC (negative ground)

AUS versions	10.8–15.6 V DC
Other versions	11.73–15.87 V DC
- Current drain:

Transmit	Less than 28 A (at maximum power)
Receive	Less than 3.0 A (at maximum audio)
- Dimensions (projections are not included):

Main/Front package	62(H)×174(W)×259(D) mm 2.4(H)×6.9(W)×10.2(D) in
--------------------	--
- Weight (approximately):

Main/Front package	3.9 kg, 8.6 lb
--------------------	----------------

Transmitter

- Output power (typical):

AUS versions	
J3E	HIGH 100 W p-p MID 50 W p-p LOW 10 W p-p
Other versions	
J3E/A1A	HIGH 125 W p-p MID 50 W p-p LOW 10 W p-p
A3E	HIGH 30 W Carrier MID 12.5 W Carrier LOW 3 W Carrier
F1B/J2B	HIGH 75 W p-p MID 50 W p-p LOW 10 W p-p
- Spurious emission:

USA versions	64 dB below peak output power
Other versions	64 dB (typical) below peak output power
- Carrier suppression: 50 dB
below peak output power
- Unwanted sideband suppression:

400 Hz	55 dB below peak output power
1 kHz	65 dB below peak output power
- Duty cycle:

Normal conversation	100% (–30°C to +60°C; –22°F to +140°F)
Continuous Data mode	25% (–30°C to +30°C; –22°F to +86°F)
All mode with Fan (CFU-F8100) is active	100% (–30°C to +45°C; –22°F to +113°F)

Receiver

- Sensitivity:

J3E (Pre Amp ON)	
(0.5–1.5999 MHz)	14 dBμV (10 dB S/N)
(1.6–29.9999 MHz)	–14 dBμV (10 dB S/N)
A3E	
(0.5–1.5999 MHz)	22 dBμV (10 dB S/N)
(1.6–29.9999 MHz)	6 dBμV (10 dB S/N)
- Spurious response rejection ratio: More than 70 dB
- AF output power (at 13.8 V DC): More than 4.0 W at 10% distortion with a 4 Ω load
- Clarifier range: ±200 Hz

All stated specifications are typical and subject to change without notice or obligation.

• DISPLAY UNIT

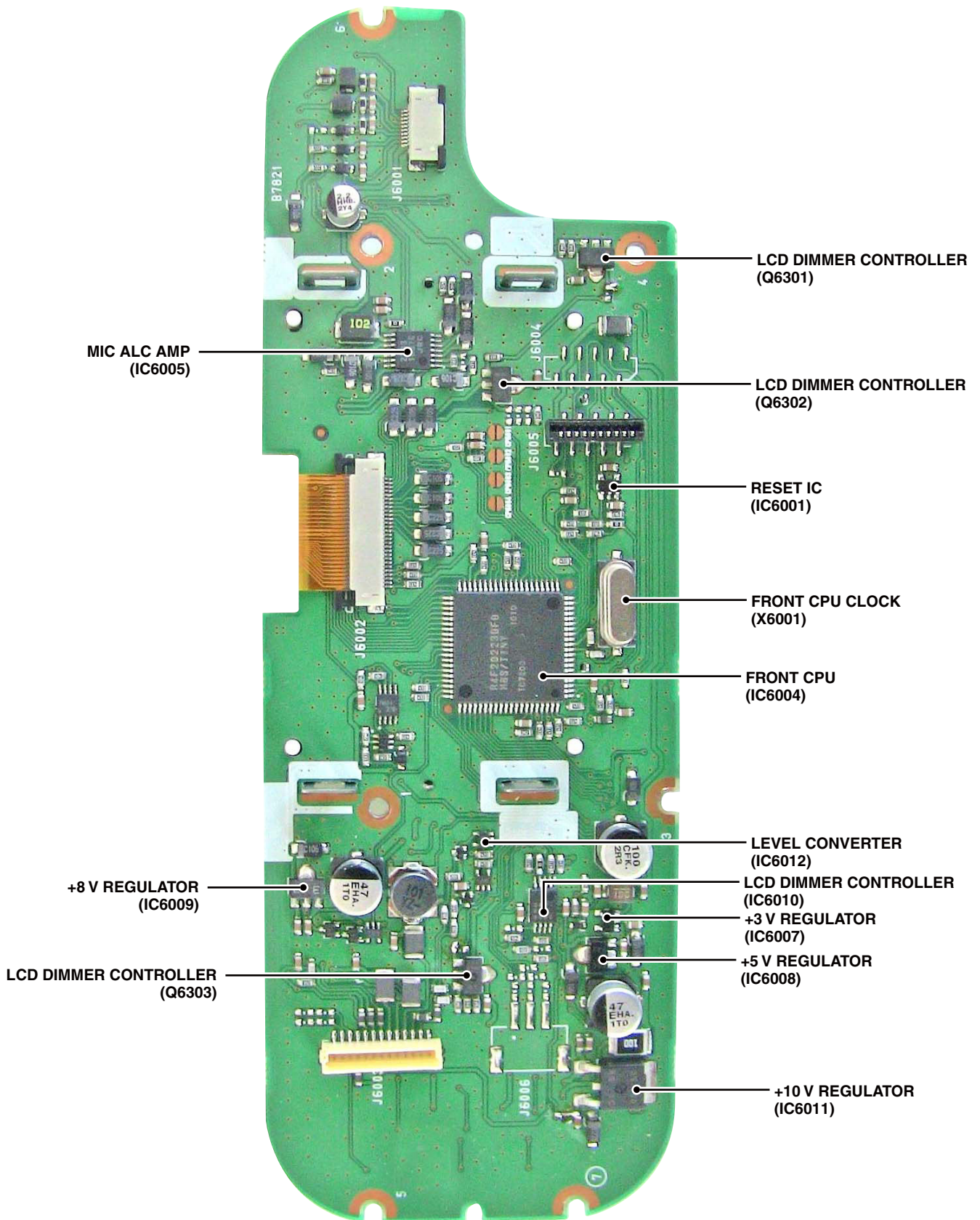

• MAIN UNIT

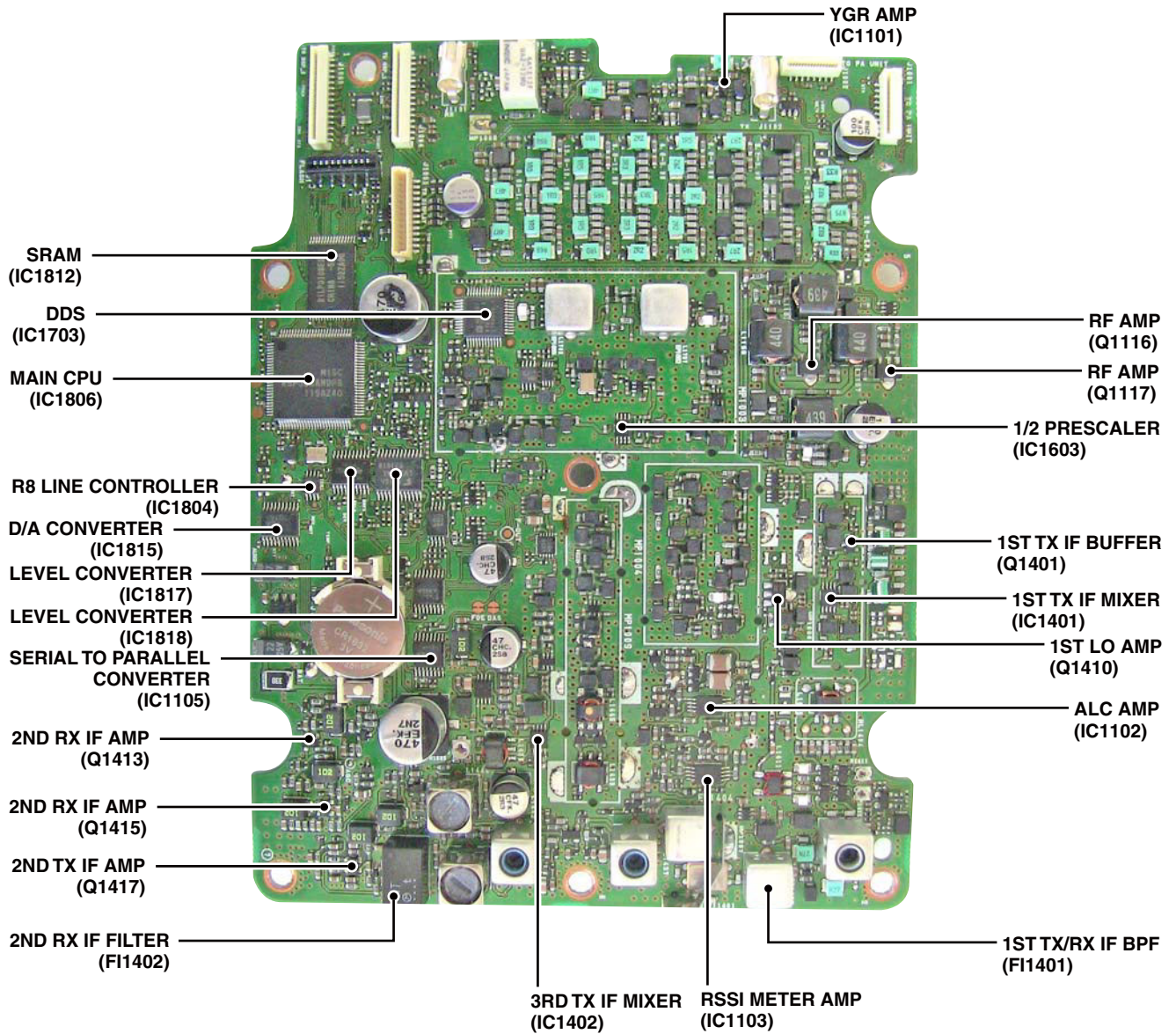

• PA UNIT

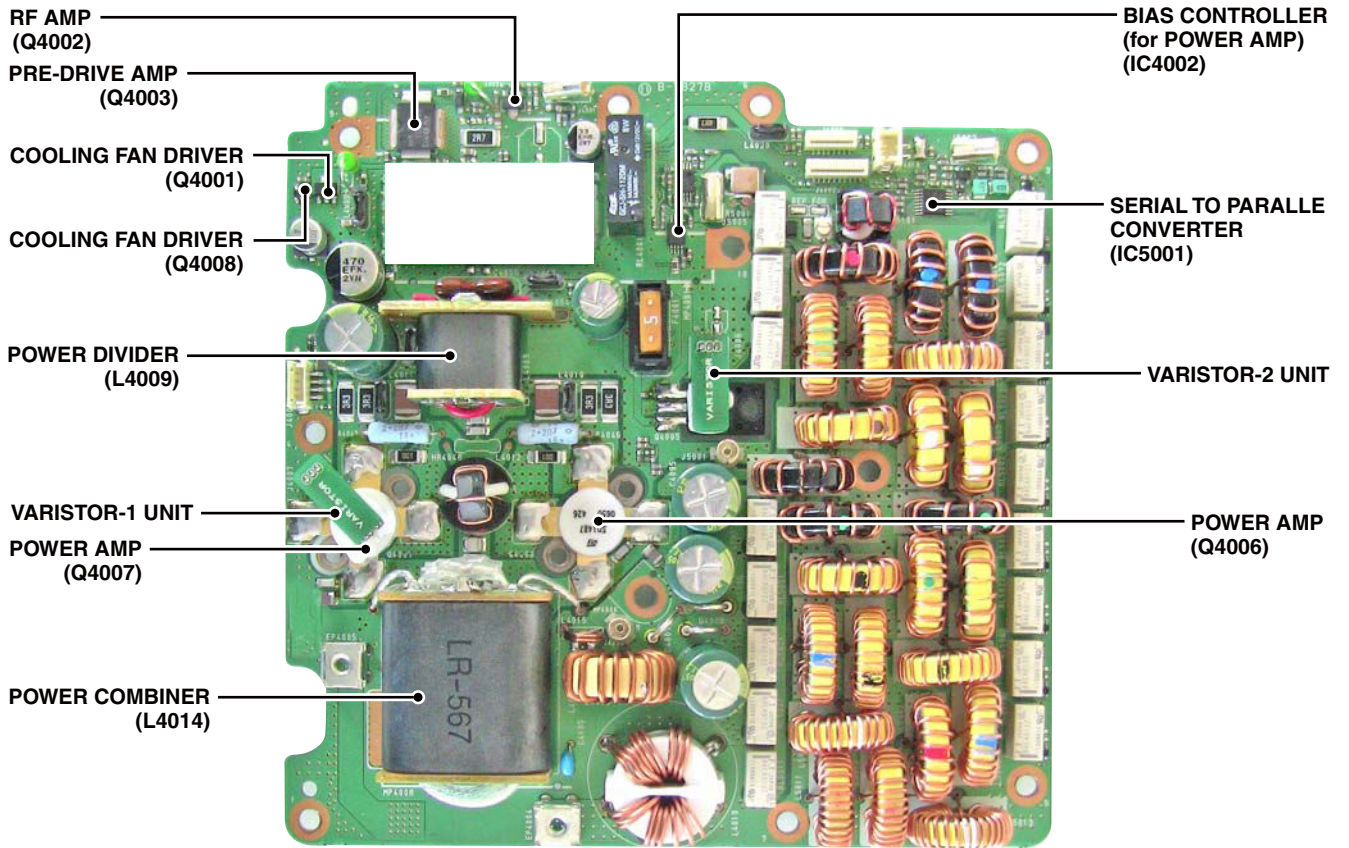

• DSP-1 UNIT

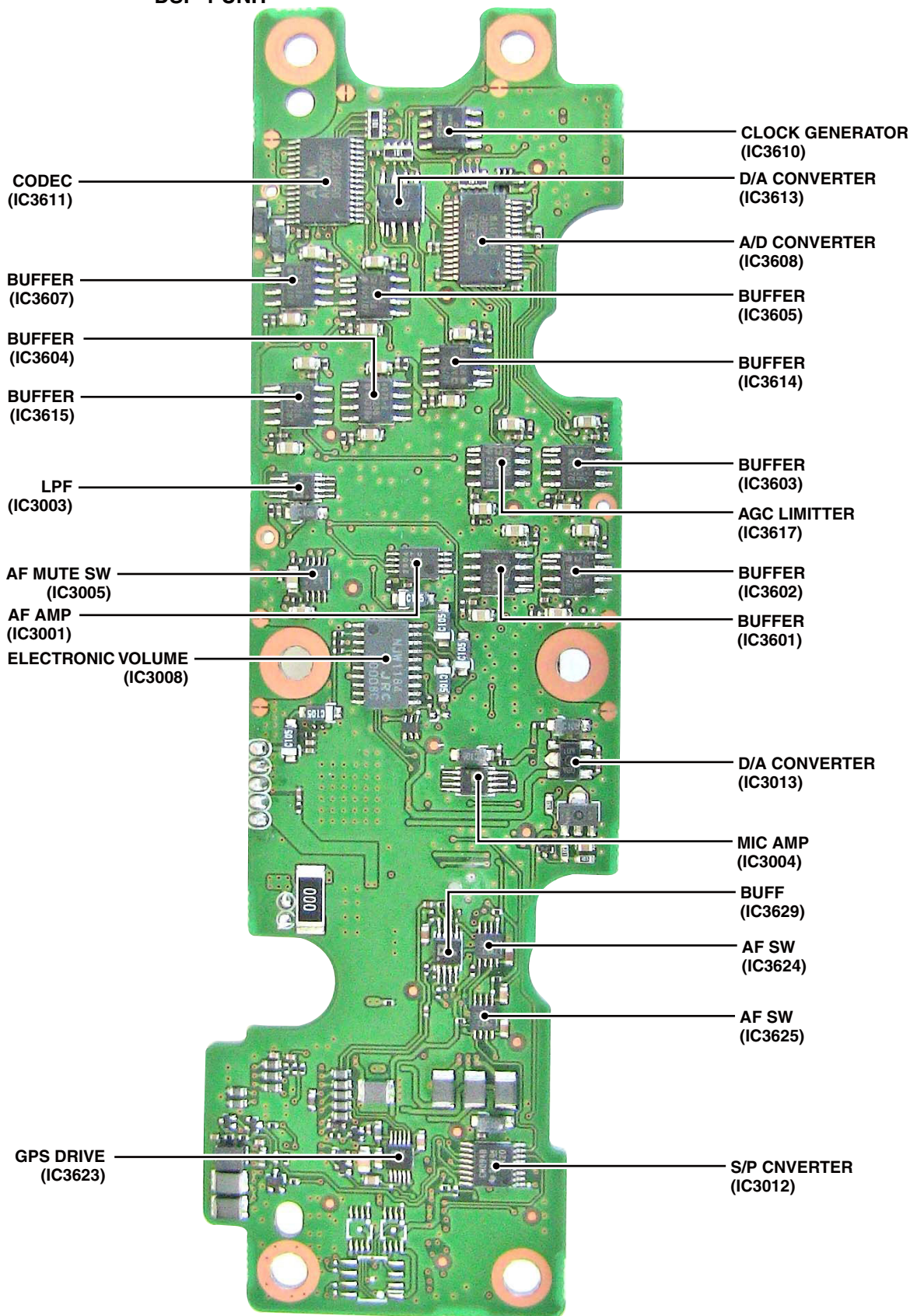

• DSP-2 UNIT

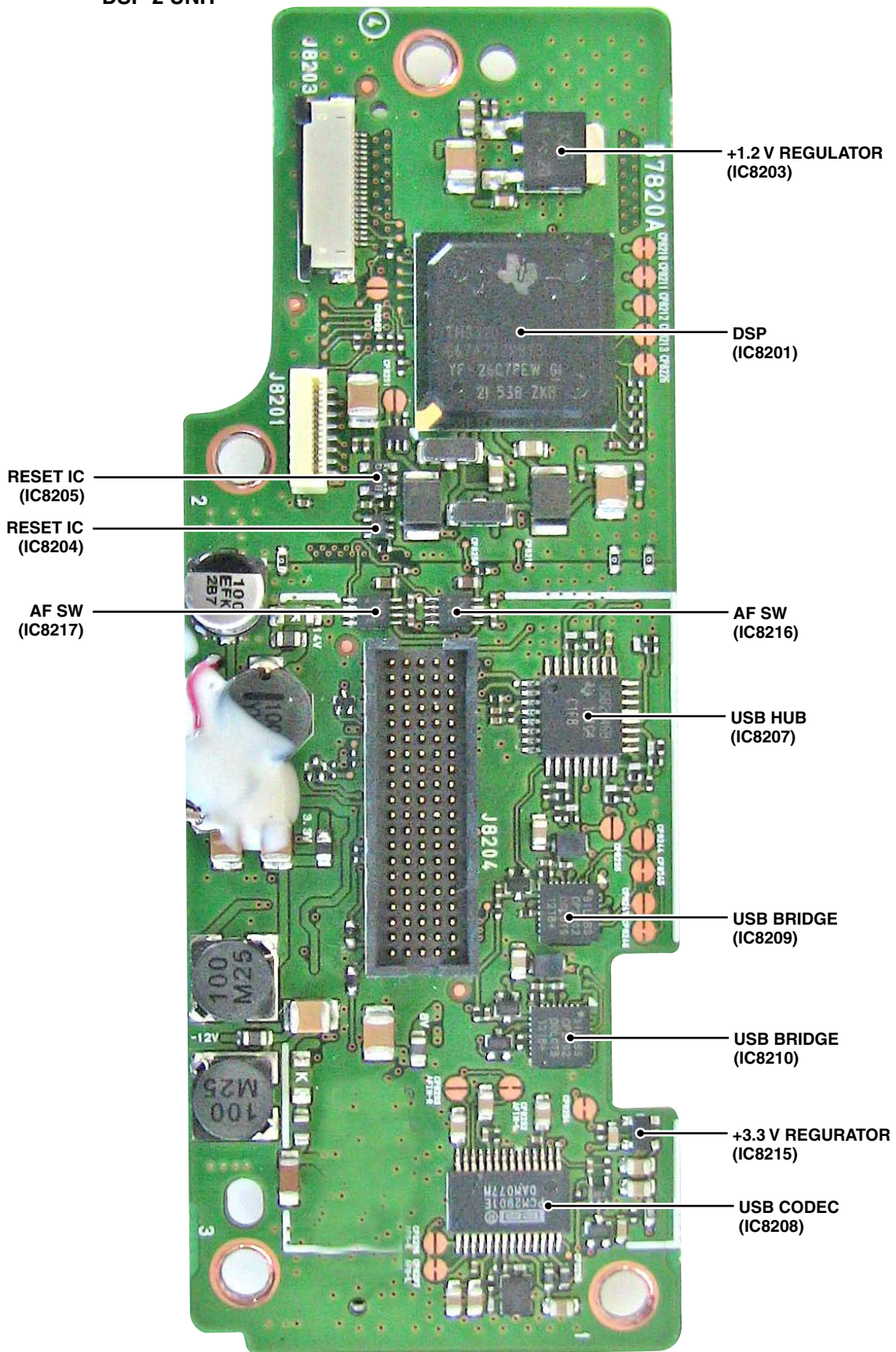

SECTION 3 DISASSEMBLY INSTRUCTION

1. Removing the DISPLAY UNIT

- 1) Remove 4 hex socket screws from the FRONT PANEL, and then separate it from the CHASSIS.
- 2) Disconnect the inline cable, and then remove the FRONT PANEL from the CHASSIS in the direction of the arrow.

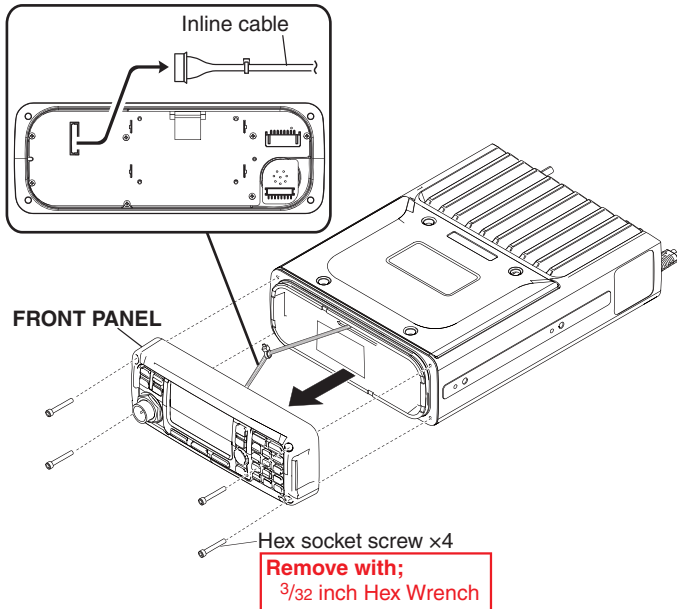

- 3) Disconnect the flat cable and 2 inline cables from the DISPLAY UNIT.
- 4) Remove 7 screws from the DISPLAY UNIT.
- 5) Remove the DISPLAY UNIT from the FRONT PANEL.

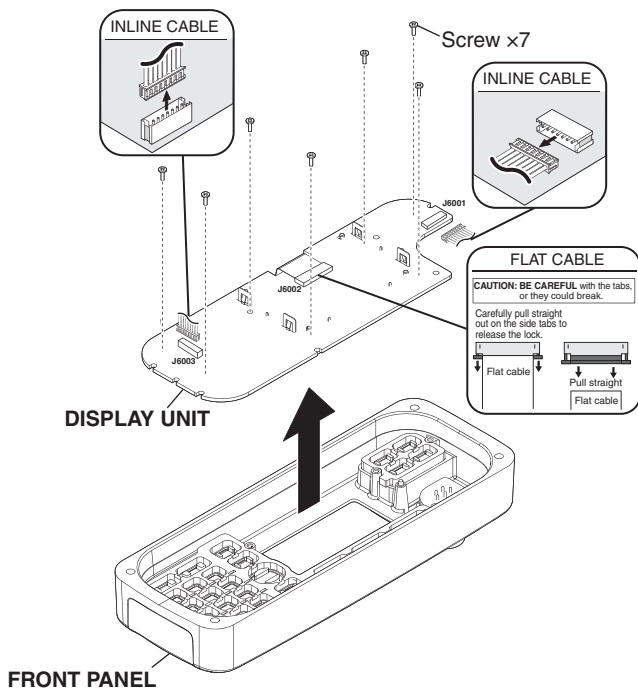

2. Removing the MAIN UNIT

- 1) Remove 4 screws from the top cover, and then remove it.

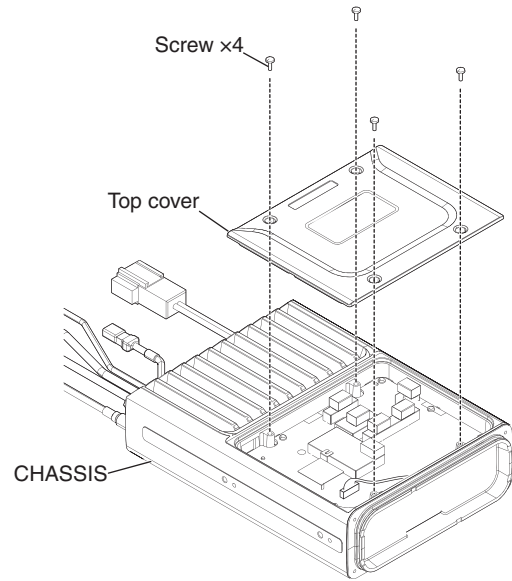

- 2) Disconnect the inline cable, 4 flat cables and 2 coaxial cables from the MAIN UNIT.

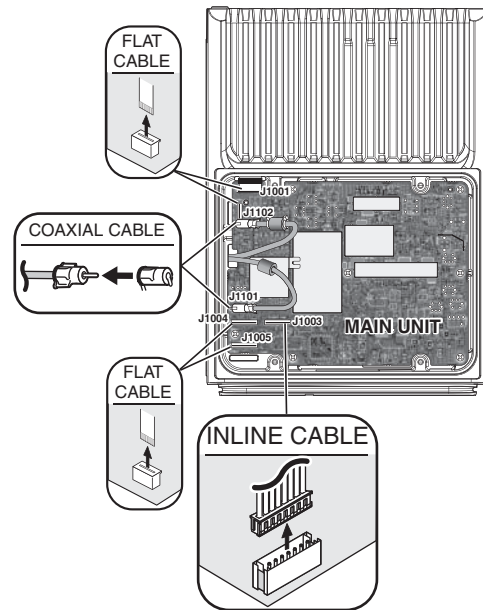

- 3) Remove 7 screws from the MAIN UNIT.
- 4) Remove the MAIN UNIT from the CHASSIS in the direction of the arrow.

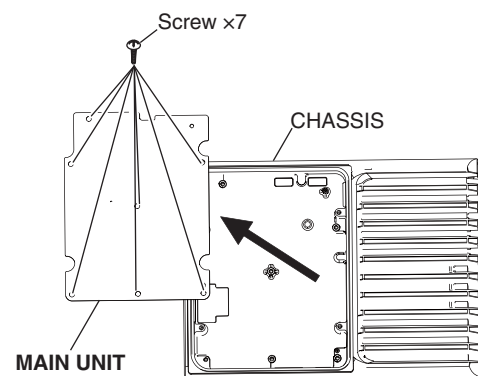

3. Removing the DSP-1 and DSP-2 UNITS

1) Remove the 4 screws from the bottom cover, and then remove it.

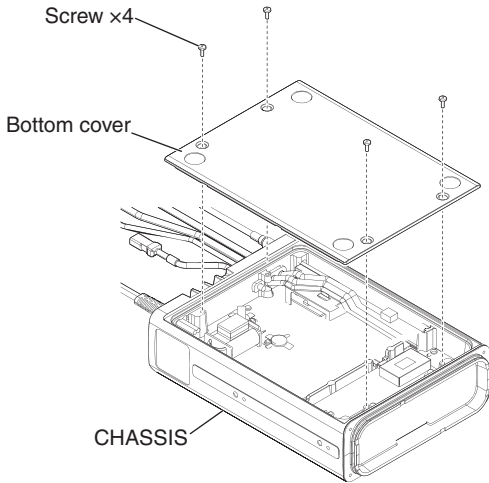

2) Disconnect the 2 flat cables from the DSP-2 UNIT.

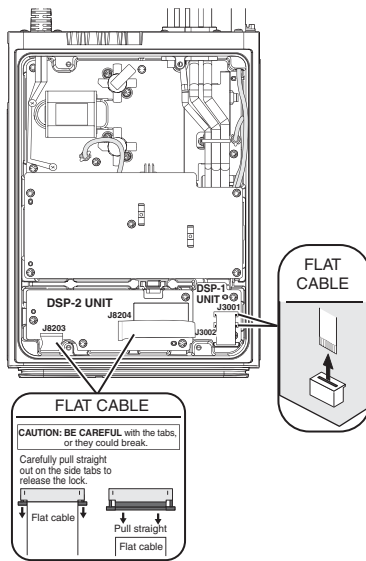

- 3) Remove the 4 screws from the DSP-2 UNIT, and then remove it from the CHASSIS.
- 4) Remove the clip and 6 screws from the DSP-1 UNIT.
- 5) Disconnect the 2 inline cables, 2 flat cables and speaker cable.
- 6) Remove the DSP-1 UNIT from the CHASSIS.

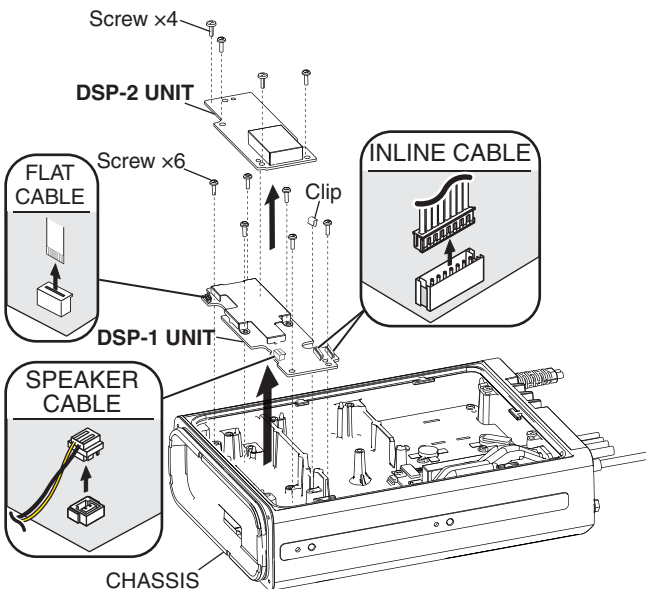

4. Removing the DRIVER UNIT

1) Cut the cable tie and remove it.

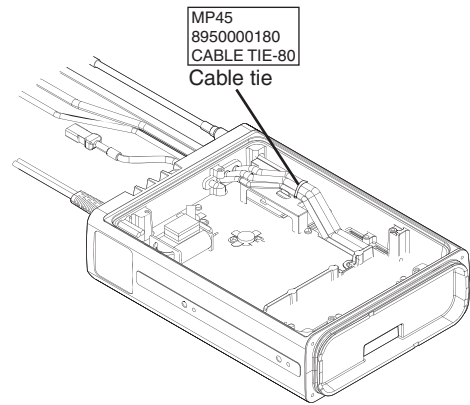

2) Remove 3 screws, and then remove the PA case.

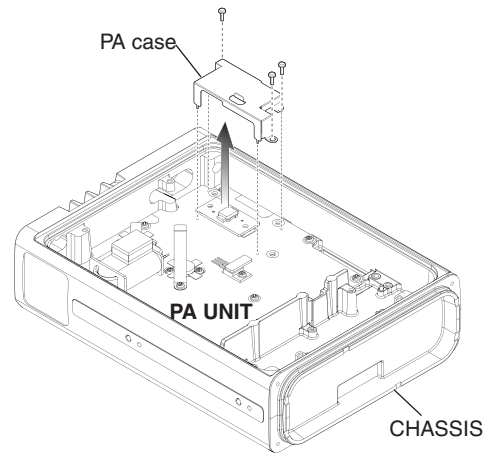

- 3) Unsolder total of 8 points.
- 4) Remove 2 screws from the DRIVER UNIT.
- 5) Remove the DRIVER UNIT from the CHASSIS.

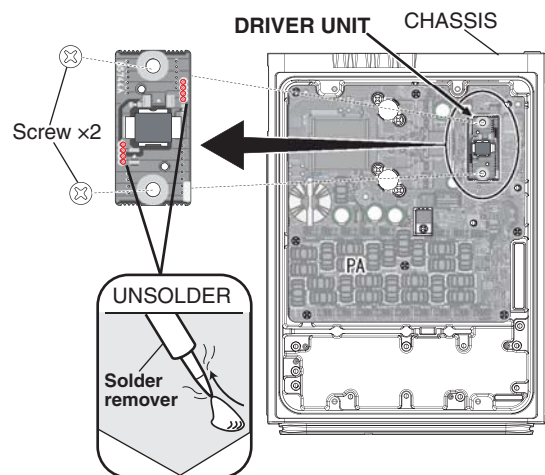

5. Removing the PA UNIT

- 1) Remove the 15 screws from the PA UNIT.
- 2) Disconnect the 2 flat cables and 2 coaxial cables from the PA UNIT.
- 3) Remove the PA UNIT from the CHASSIS in the direction of the arrow.

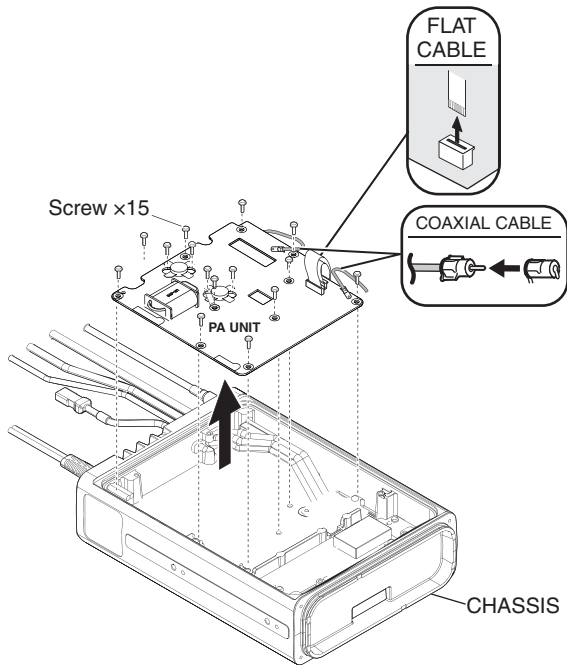

4-1 RECEIVER CIRCUITS

RF CIRCUIT (PA AND MAIN UNITS)

The RX signal from the antenna is passed through the SWR detect circuit (PA UNIT; D5001, D5002), TX/RX line SW (PA UNIT; RL5001) and LPF (PA UNIT; L5001, L5002, C5101–C5105), and then applied to the MAIN UNIT.

The RX signal from the PA UNIT is passed through or bypassed the attenuator circuit (MAIN UNIT; R1103, R1106, R1108), RX mute SW (MAIN UNIT; Q1101, D1107), TX/RX line SW (MAIN UNIT; D1108), and then applied to the filter circuits.

The RX signal is passed through an LPF or one of BPFs, depending on the operating frequency, to remove unwanted out-of-band signals. The filtered RX signal is applied to or bypassed the preamplifier circuit.

The RX signal from the filter circuits is applied to or bypassed the preamplifier.

When the Preamplifier function is activated, the RX signal is amplified by the preamplifier (MAIN UNIT; Q1116, Q1117). The amplified or bypassed RX signal is applied to the 1st RX IF circuits.

• RF CIRCUIT

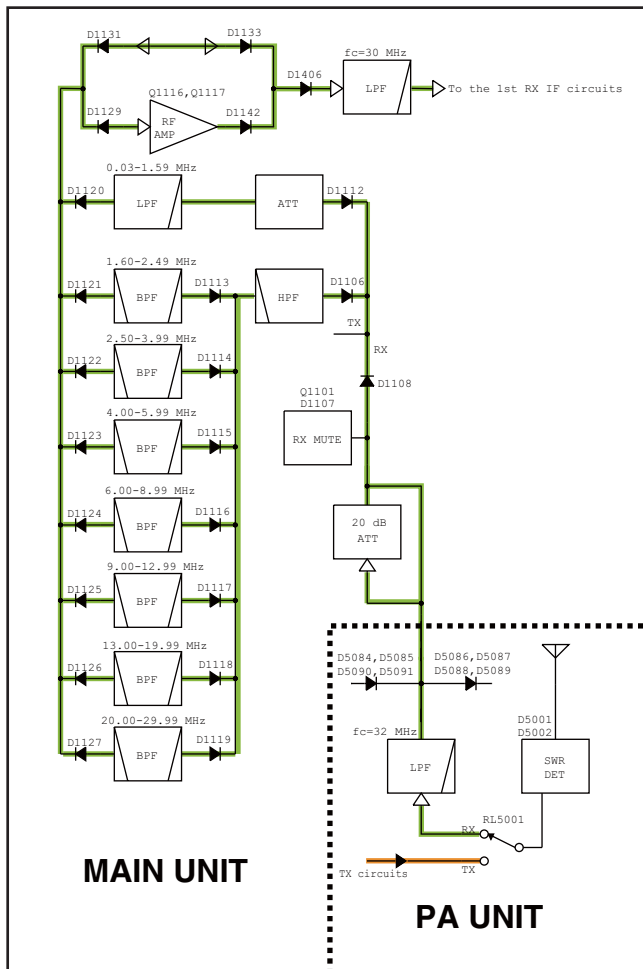

1ST RX IF CIRCUIT (MAIN UNIT)

The RX signal from the preamplifier circuit is applied to the 1st RX IF mixer (Q1404–Q1407) to be mixed with the 1st RX LO signal, resulting in the 64.455 MHz 1st RX IF signal. The 1st RX IF signal is amplified by the 1st RX IF AMP (Q1810) and passed through the 1st RX IF filter (F11401).

The filtered 1st RX IF signal is amplified by another 1st RX IF AMP (Q1414), and then applied to the 2nd RX IF circuits.

• 1ST RX IF CIRCUIT

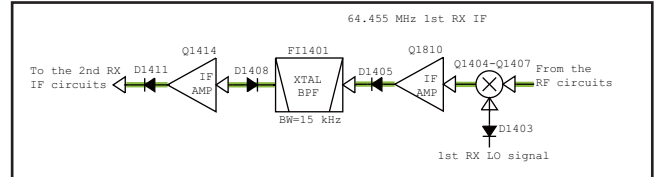

2ND RX IF CIRCUIT (MAIN UNIT)

The 1st RX IF signal from the 1st RX IF circuits is applied to the 2nd RX IF mixer (D1812, D1813) to be mixed with the 2nd RX LO signal, resulting in the 455 kHz 2nd RX IF signal. The 2nd RX IF signal is passed through the transformer-coupled filter (L1446) and 2nd RX IF filter (F11402), and amplified by the 2nd RX IF AMPs (Q1415, Q1412 and Q1413), and then applied to the 3rd RX IF circuits, through the buffer (Q1411).

• 2ND RX IF CIRCUIT

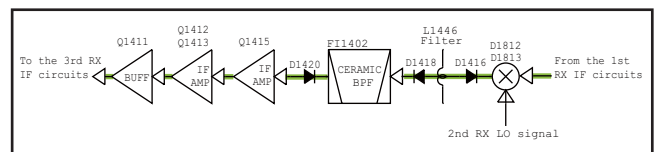

3RD RX IF CIRCUIT (MAIN UNIT)

The 2nd RX IF signal from the 2nd RX IF circuits is applied to the 3rd RX IF mixer (IC1402) to be mixed with the 3rd RX LO signal, resulting in the 36 kHz 3rd RX IF signal.

The 3rd RX IF signal is passed through the 3rd IF SW (IC1403) and LPF (L1454, C1550, C1553), and then applied to the demodulator circuits on the DSP-1 UNIT.

• 3RD IF CIRCUIT

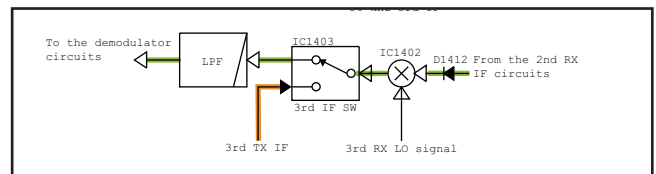

DEMODULATOR CIRCUIT (DSP-1 UNIT)

The 3rd RX IF signal from the 3rd RX IF circuits is passed through the buffer (IC3602, IC3603), and then applied to the A/D converter to be converted into digital audio signal.

The converted digital audio signal is applied to the DSP (IC8201) on the DSP-2 UNIT, and demodulated and processed.

The demodulated signal is applied to the CODEC (IC3611) to be converted into analog AF signal. The AF signal is passed through the buffer (IC3615), LPF (IC3003) and AF mute SW (IC3005), and then applied to the electronic volume (IC3008), which adjusts the AF output signal in level.

The level-adjusted AF signal is amplified by the AF power AMP (IC3011), and then output from the connected speaker, through the speaker SW (RL3001) and speaker connector (J3006).

• DEMODULATOR AND RX AF CIRCUIT

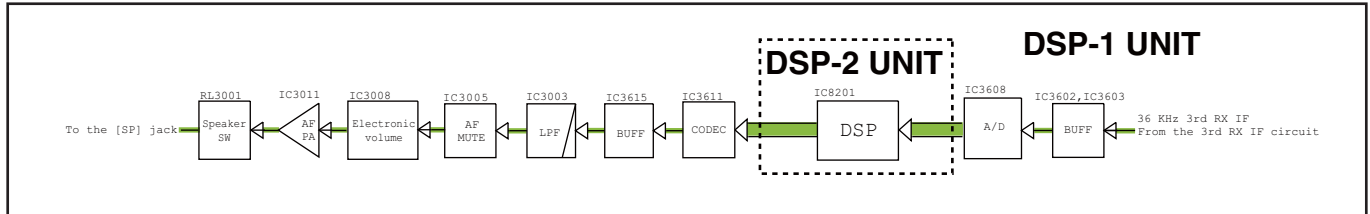

4-2 TRANSMITTER CIRCUITS

TX AF CIRCUIT (DISPLAY and DSP-1 UNITS)

The audio signal from the microphone (MIC signal) is applied to the DISPLAY UNIT, through the MICROPHONE CONNECTOR (MIC UNIT; J6902), and then applied to the MIC AMP with ALC circuit (IC6005). The amplified MIC signal is applied to the DSP-1 UNIT.

The MIC signal from the DISPLAY UNIT is amplified by the AF AMP (IC3004), and then applied to the electronic volume (IC3008), which adjust the MIC signal in level.

The level-adjusted MIC signal is applied to the modulation circuits.

3RD TX IF CIRCUIT (MAIN UNIT)

The 3rd TX IF signal from the modulation circuits is applied to the 3rd TX IF mixer (IC1402), through the 3rd IF SW (IC1403), to be mixed with the 3rd TX LO signal, resulting in the 455 kHz 2nd TX IF signal.

The 2nd TX IF signal is amplified by the 2nd TX IF AMP (Q1417), passed through the 2nd TX IF filter (F1402), and then applied to another 2nd TX IF AMP (Q1416).

The amplified 2nd TX IF signal is applied to the 2nd TX IF circuits.

• TX AF CIRCUIT

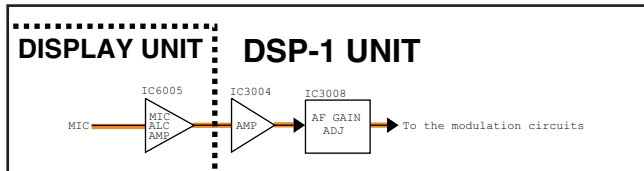

• 3RD TX IF CIRCUIT

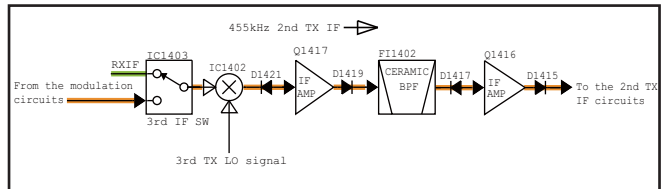

MODULATION CIRCUIT (DSP-1 UNIT)

The MIC signal from the TX AF circuits is applied to the CODEC (IC3611), through the Balance-Unbalance converter (IC3604 and IC3607), to be converted into digital audio signal.

The converted digital audio signal is applied to the DSP (IC8201) on the DSP-2 UNIT, and processed and modulated.

The processed signal is applied to the DSP-1 UNIT again, and converted into analog audio signal by the CODEC (IC3611), and then applied to the 3rd TX IF circuits on the MAIN UNIT, through the buffer (IC3615), as the 3rd TX IF signal.

• MODULATION CIRCUIT

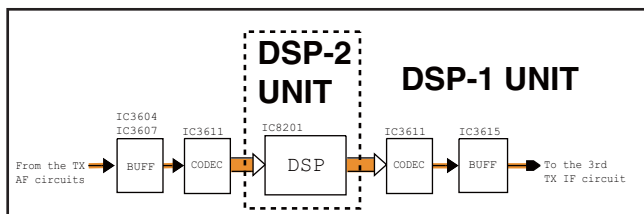

2ND TX IF CIRCUIT (MAIN UNIT)

The 2nd TX IF signal from the 3rd TX IF circuits is applied to the 2nd TX IF mixer (D1812, D1813), to be mixed with the 2nd TX LO signal, resulting in the 64.455 MHz 1st TX IF signal.

The 1st TX IF signal is passed through the 1st TX IF filter (FI1401), amplified by the 1st TX IF AMP (Q1409), and then applied to the 1st TX IF circuits.

1ST TX IF CIRCUIT (MAIN UNIT)

The 1st TX IF signal from the 2nd TX IF circuits is applied to the 1st TX IF mixer (IC1401), to be mixed with the 1st TX LO signal, resulting in the TX signal (TX frequency itself).

The converted TX signal is applied to the filter circuits, through the buffer (Q1401).

FILTER CIRCUIT (MAIN UNIT)

The TX signal from the 1st TX IF circuits is passed through the one of BPFs, depending on the operating frequency, to remove unwanted signals contained in the TX signal.

The filtered TX signal is amplified by the YGR AMP (IC1101), and then applied to the PA UNIT.

TX AMPLIFIER CIRCUIT (PA UNIT)

The TX signal from the MAIN UNIT is applied to the RF AMP (Q4002), through the LPF (L4002, C4008, C4014). The amplified TX signal is sequentially amplified by the pre-drive AMP (Q4003), drive AMP (Q6851), and power AMP (Q4006, Q4007).

The amplified TX signal is applied to the PA UNIT.

LPF CIRCUIT (PA UNIT)

The amplified TX signal from the power AMP (Q4006, Q4007) is passed through one of LPFs, depending on the transmitting frequency, to remove harmonic components contained in the TX signal.

The filtered TX signal is applied to the antenna, through the TX/RX line SW (RL5001) and SWR detect circuit (D5001, D5002).

• 2ND AND 1ST TX IF CIRCUIT

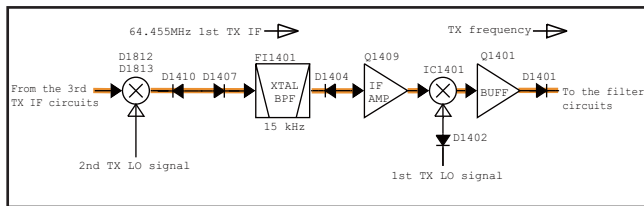

• FILTER, TX AMPLIFIER AND LPF CIRCUITS

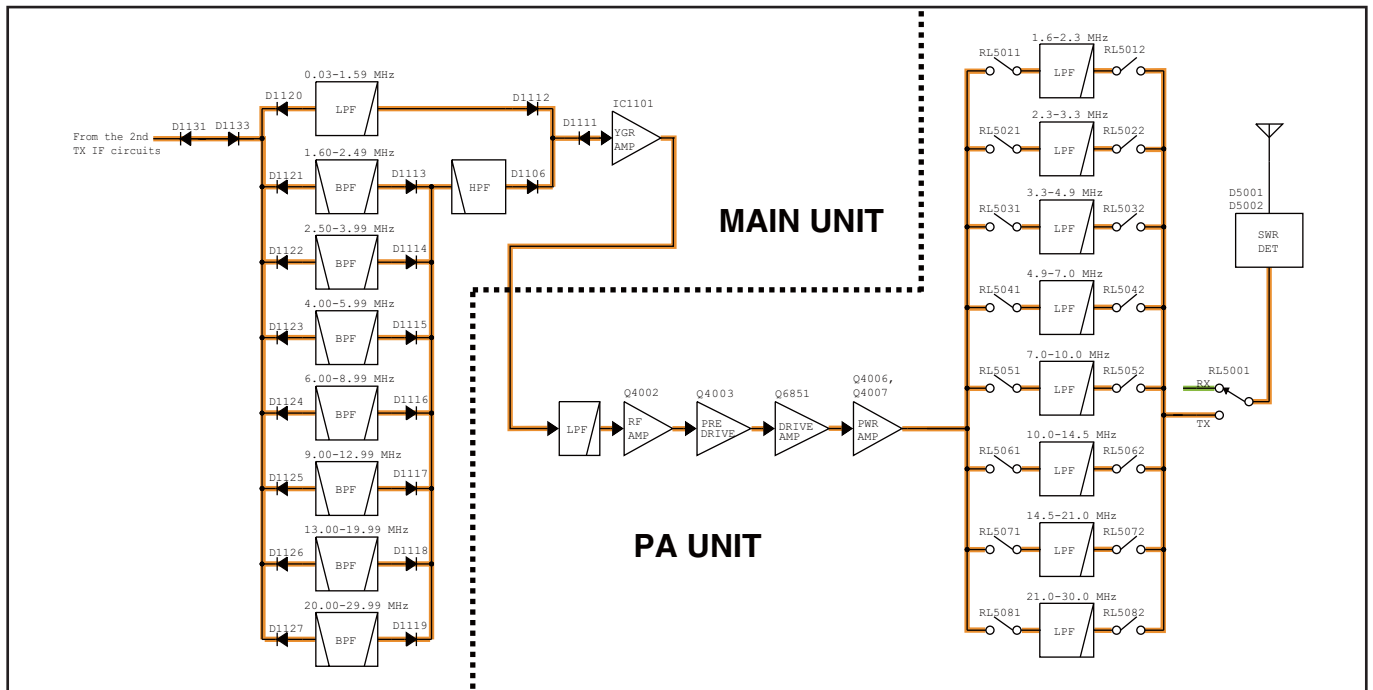

4-3 FREQUENCY SYNTHESIZER CIRCUITS

The 3rd TX/RX LO signal (MAIN UNIT)

The 32 MHz reference frequency signal, which is generated by X1601, is amplified by the buffer (Q1601) and two AMPs (IC1604 and IC1605), and then applied to the divider (IC1603). The divided reference frequency signal is applied to the DDS IC (IC1601).

Using the applied DDS master clock signal as the reference, the DDS IC generates the 419 kHz 3rd RX/TX LO signal. The generated 3rd RX/TX LO signal is passed through the LPF (L1601, L1603, C1601, C1604, C1605, C1608), and amplified by the AMP (IC1404), and then applied to the 1st TX/RX IF mixer (IC1402).

The 2nd TX/RX LO signal (MAIN UNIT)

The 32 MHz reference frequency signal, which is generated by X1601, is amplified by the buffer (Q1601) and AMP (IC1604), and then doubled by the doubler (L1617, L1620, L1622–L1624, C1642, C1644, C1647, C1650, C1653, C1655, C1658, C1659, C1661–C1664), resulting in the 64 MHz 2nd TX/RX LO signal.

The 2nd TX/RX LO signal is amplified by the LO AMP (IC1602), and then applied to the 2nd TX/RX IF mixer (D1812, D1813), through the LPF (L1602, L1604, C1602, C1603, C1606, C1607, C1609).

The 1st TX/RX LO signal

The 32 MHz reference frequency signal, which is generated by X1601, is amplified by the buffer (Q1601) and AMP (IC1604), and then applied to the BPF (L1608, L1612–L1615, L1618, L1626, C1666, C1620, C1623, C1625, C1629, C1631, C1634, C1636, C1638, C1640, C1641, C1643, C1646, C1649, C1652, C1654), resulting in the 256 MHz DDS master clock signal.

The clock signal is amplified by the AMP (IC1606), and then applied to the DDS IC, through the HPF (L1627, L1628, L1701, C1667, C1668, C1702, C1703).

Using the applied DDS master clock signal as the reference, the DDS IC generates the 32.2425–47.2275 MHz signal. The generated signal is passed through the LPF (L1704, L1706, C1711, C1713, C1718, C1720, C1722, C1723), and doubled by the doubler (D1702, D1703), resulting in the 64.485–94.455 MHz 1st TX/RX LO signal.

The 1st TX/RX LO signal is passed through the BPF (L1709–L1711, C1729, C1731–C1734, C1736), amplified by the AMP (IC1705), passed through another BPF (See the table below for the detail), and then applied to the LO AMP (Q1410).





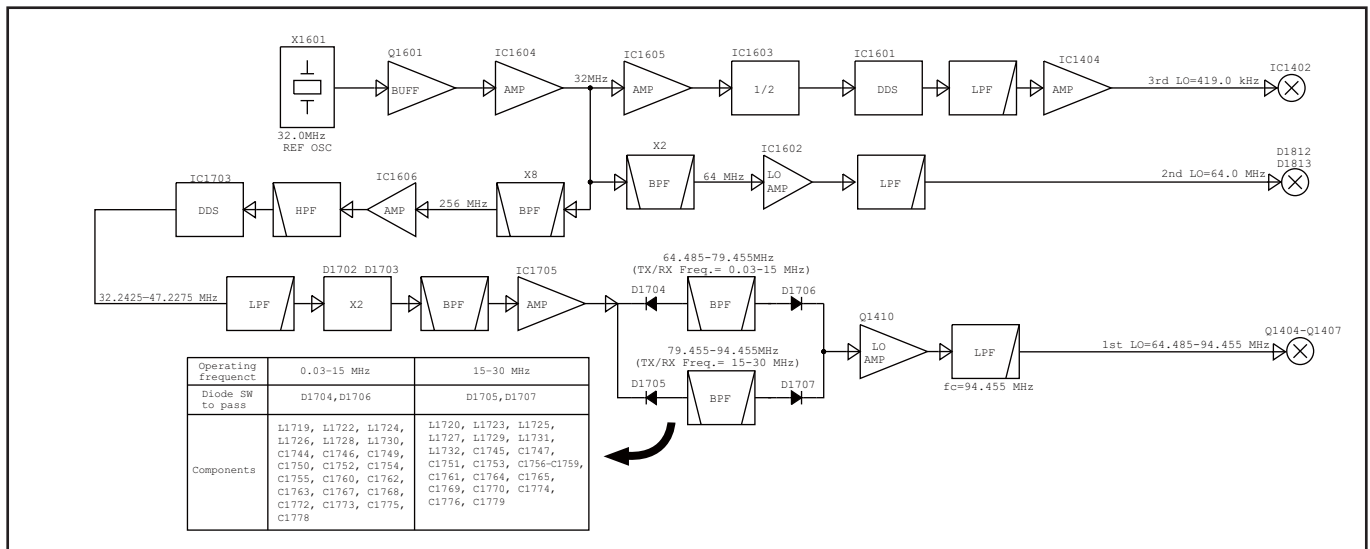









The amplified 1st TX/RX LO signal applied to the 1st TX/RX IF mixer (IC1401/Q1404–Q1407), through the LPF (L1419, L1422, C1437, C1444, C1445, C1448).

• FREQUENCY SYNTHESIZER CIRCUIT



4-4 PORT ALLOCATIONS

• FRONT CPU (DISPLAY UNIT: IC6004)

Pin No.	Line Name	Description	I/O
2	LEDC	LCD dimmer control.	O
7	RESET	CPU reset. L=The CPU is reset.	I
17	TXD	L-bus communication line to the MAIN CPU.	O
18	RXD	L-bus communication line to the MAIN CPU.	I
19	LRES	LCD driver reset. L=The driver is reset.	I
27	RXD	L-bus wakeup line. L=Wakeup.	I
28	IOK	[] input. L=Pushed.	I
29	P3K	[] input. L=Pushed.	I
30	P2K	[] input. L=Pushed.	I
31	P1K	[] input. L=Pushed.	I
32	DNK	[] input. L=Pushed.	I
33	UPK	[] input. L=Pushed.	I
34	EMGK	[] input. L=Pushed.	I
35	MENK	[] input. L=Pushed.	I
36	CALK	[] input. L=Pushed.	I
41	LCS	LCD driver control. L=Enabled.	O
42-49	DB0-DB7	LCD driver control. (Parallel data bus)	O
51	LWR	LCD driver control. L=Data write status.	O
52	LA0	LCD driver control. H=In the address select mode.	O
55	LRD	LCD driver control. L=Data read status.	O
56	FPWRS	8V power supply line control. H=While the transceiver's power is ON.	O
57	MGAIN	MIC gain control. H=The gain increases +20 dB.	O
58	T5K	[5 JKL] input. L=Pushed.	I
59	T6K	[6 MNO] input. L=Pushed.	I
60	T7K	[7 PRS/CLAR] input. L=Pushed.	I
61	T8K	[8 TUV/CTALK] input. L=Pushed.	I
62	T1K	[1 QZ] input. L=Pushed.	I
63	T2K	[2 ABC] input. L=Pushed.	I
64	T3K	[3 DEF/MODE] input. L=Pushed.	I
65	T4K	[4 GHI] input. L=Pushed.	I
66	TLK	[] input. L=Pushed.	I
67	TRK	[] input. L=Pushed.	I
68	CHDK	[] input. L=Pushed.	I
69	CHUK	[] input. L=Pushed.	I
70	T9K	[9 WXY/TUNER] input. L=Pushed.	I
71	T0K	[0 _] input. L=Pushed.	I
72	MUTK	[] input. L=Pushed.	I

Pin No.	Line Name	Description	I/O
73	SCNK	[# A/a /MNGR] input. L=Pushed.	I
75	TEMP	LCD temperature sensing voltage.	I
76	MICL	MIC input level sensing voltage.	I

• MAIN CPU (MAIN UNIT: IC1806)

Pin No.	Line Name	Description	I/O
2	BEEP	Beep audio.	O
3	TCOM	Tuner Scan control signal to the automatic antenna tuner.	O
4	TSTART	Motor lock control signal to the automatic antenna tuner.	O
10	RESET	CPU reset signal. L=The CPU is reset.	I
16	TXD	L-bus wakeup signal from the FRONT CPU. L=Wakeup.	I
17	CWK	CW/FSK keying input. L=Key down.	I
18	PTT	PTT input. L=Pushed.	I
20	DRXD	RX data from the DSP.	I
21	DCLK	Serial clock to the DSP.	O
22	DTXD	TX serial data to the DSP.	O
23	HSK0	Hand shake signal to the DSP. L=When the command is not granted.	I
25	FULL	ALE/SELCALL data full detect. H=Data full.	I
26	VSQL	Voice squelch detection. L=Voice detected. (Squelch open)	I
27	GPRXD	GPS data (4800 bps).	I
29	EXTXD	External data output.	O
30	EXRXD	External data input.	I
32	BPST	Beep status detection. H=Detected.	I
33	RXD	Data to the front CPU.	O
34	TXD	Data from the front CPU.	I
35	CK	Serial clock to the DDS IC.	O
36	DT	Serial data to/from the DDS IC.	I/O
42	RD	SRAM data read control.	O
44	WR	SRAM data write control.	O
46	CWST	CW status detection. L=While transmitting in the CW mode.	I
47	TUMB	Band switching control. H=When the operating frequency is 13.3 MHz and higher.	O
48	CS0	SRAM chip select control. L=Enabled.	O
52-70	A16-A0	SRAM control parallel bus.	O
71	PWS	Power supply line "14V" control. H=During the transceiver's power is ON.	O
73	DSKY	Keying output.	O
74	SEND	TX mute. H=Mute.	O
75	MDA	Serial data to the D/A converter, shift register and electronic volume.	O
76	MCK	Serial clock to the D/A converter, shift register and electronic volume.	O
77	ECK	EEPROM serial clock.	O
78	ESIO	EEPROM serial data.	I/O
79-86	D7-D0	SRAM control parallel bus.	I/O
87	RXS	RX power supply line control. H=While receiving.	O
88	TXS	TX power supply line control. H=While transmitting.	O
90	DCV	External power source detect.	I
91	TEMP	TX power AMP temperature sensing voltage.	I
92	KEYS	External tuner key control.	I
93	REF	Reflected wave sensing voltage.	I

4-4 PORT ALLOCATIONS (Continued)

• MAIN CPU (MAIN UNIT: IC1806)

Pin No.	Line Name	Description	I/O
98	STBSEL_D	Binary to decimal converter control. H=Enabled.	O
99	STBSEL_C	Binary to decimal converter control. H=Enabled.	O
100	STBSEL_B	Binary to decimal converter control. H=Enabled.	O

4-5 VOLTAGE DIAGRAMS

Voltage from the power supply is routed throughout the transponder via regulators and switches.

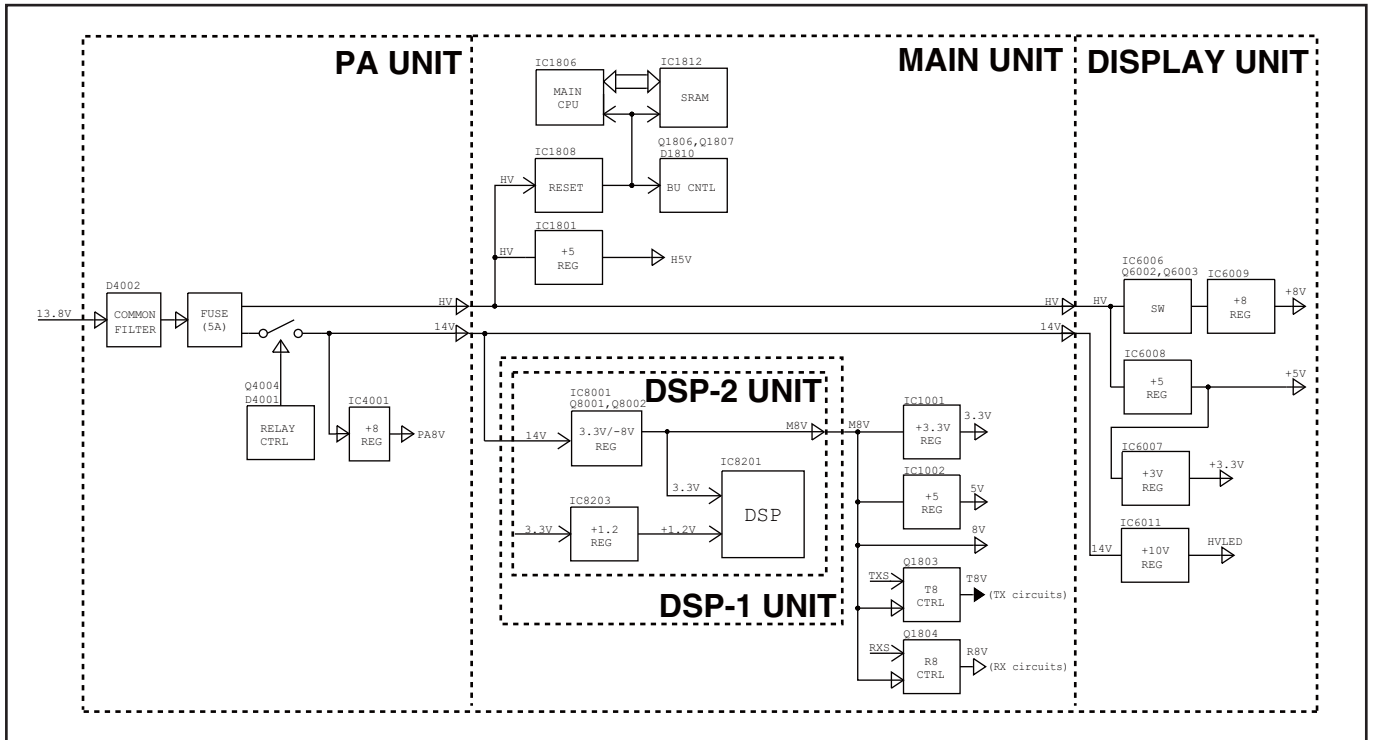

SECTION 5 ADJUSTMENT PROCEDURE

5-1 PREPARATION

REQUIRED EQUIPMENTS

EQUIPMENT	GRADE AND RANGE	EQUIPMENT	GRADE AND RANGE
Cloning software	CS-F8100 CLONING SOFTWARE (Revision 1.0 or later)	Standard signal generator (SSG)	Frequency range : 0.1–50 MHz Output level : –20 dB μ to 90 dB μ (–127 to –17 dBm)
RF power meter (50 Ω terminated)	Measuring range : 0.1–300 W Frequency range : 0.1–50 MHz SWR : Less than 1.2 : 1	Frequency counter	Frequency range : 0.1–50 MHz Frequency accuracy : \pm 1 ppm or better Input level : Less than 1 mW
AC millivoltmeter	Measuring range : 10 mV to 10 V	Dummy load	Input impedance : 50 Ω Capacity : More than 300 W
Audio generator (AG)	Frequency range : 300–3000 Hz Output level : 1–500 mV	External speaker	SP-25
DC power supply	Voltage : 13.8 V Capacity : More than 40 A	Voltmeter	Measuring range : 0.1–10 V
		Ammeter	Measuring range : 0.1–40 A

GENERAL CONNECTION

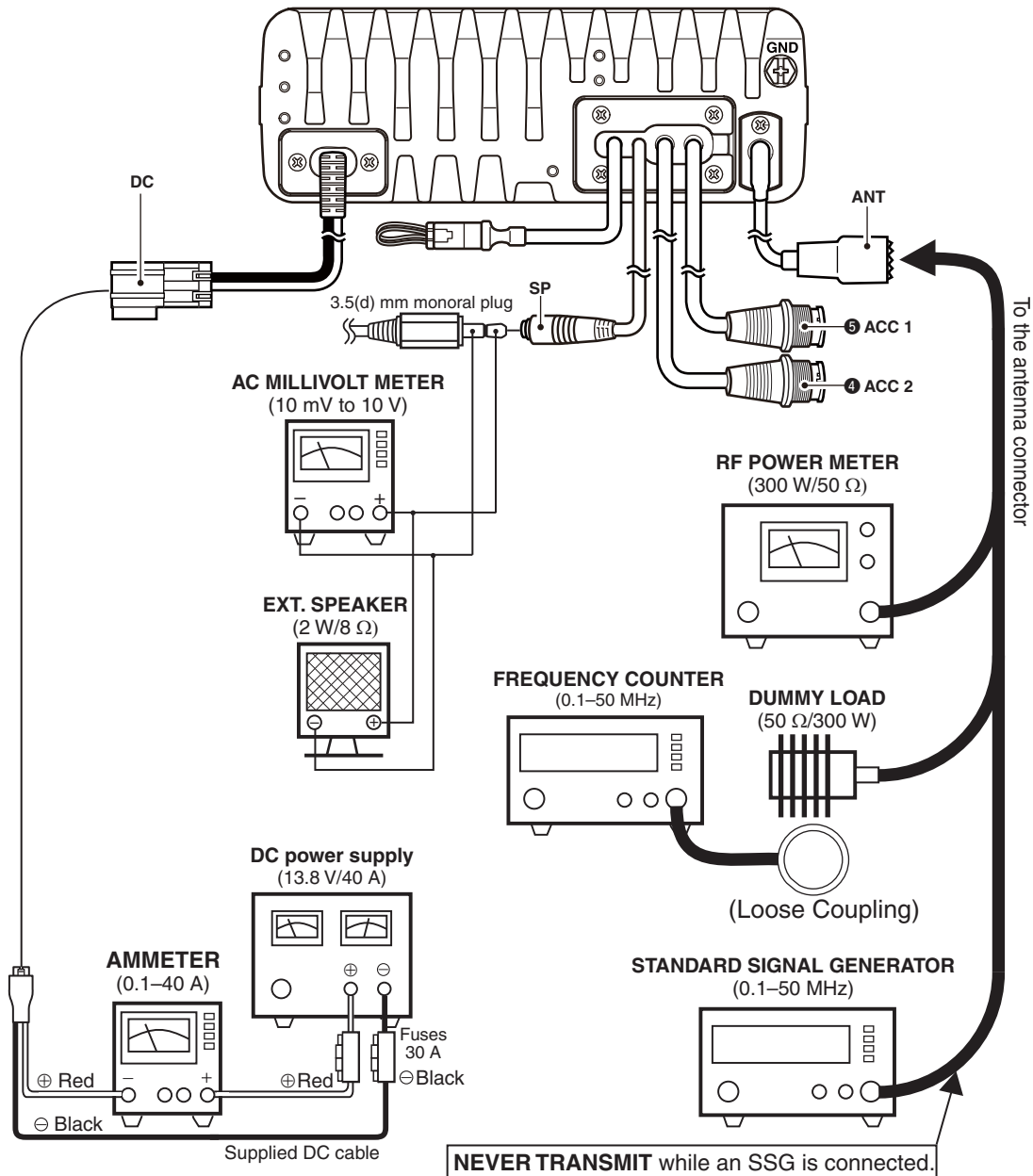

■ ADJUSTMENT CHANNELS

Before starting the adjustments, use the cloning software to create the same cloning file as shown below, then upload it into the transceiver.

CH	Name	Frequency (kHz)		Mode
		RX	TX	
1	RX Preset	12 900.000	<-	USB
2	RX 1st Mixer	1 610.000	<-	USB
3	RX IF	12 900.000	<-	USB
4	RF Gain	12 900.000	<-	USB
5	S-Meter	12 900.000	<-	USB
6	Ref.Freq.	29 000.000	<-	CW
7	Idling	12 900.000	<-	USB
8	CM Coupler	12 900.000	<-	CW
9	TX IF	12 900.000	<-	USB
10	TX IF GAIN	12 900.000	<-	USB
11	ALC Current	16 500.000	<-	CW
12	TX Power(CW)	12 900.000	<-	CW
13	TX Power (AM)	12 900.000	<-	AM
14	TX Power(DATA)	12 900.000	<-	RTTY
15	TX Sensitivity	12 900.000	<-	USB

CONVENIENT: The cloning data file for the adjustment, as described in this service manual, is attached. Right click the clip icon, and select "Save Embedded File to Disk."

ENTERING ADJUSTMENT MODE

- 1) Turn OFF the transceiver power, if the transceiver is powered ON.
- 2) While holding down [#], [SCAN], [] and [⏻], push [⏻] to turn ON the transceiver power.
 - The login screen appears as below.
- 3) Enter "SX-3500," and then push [✓].

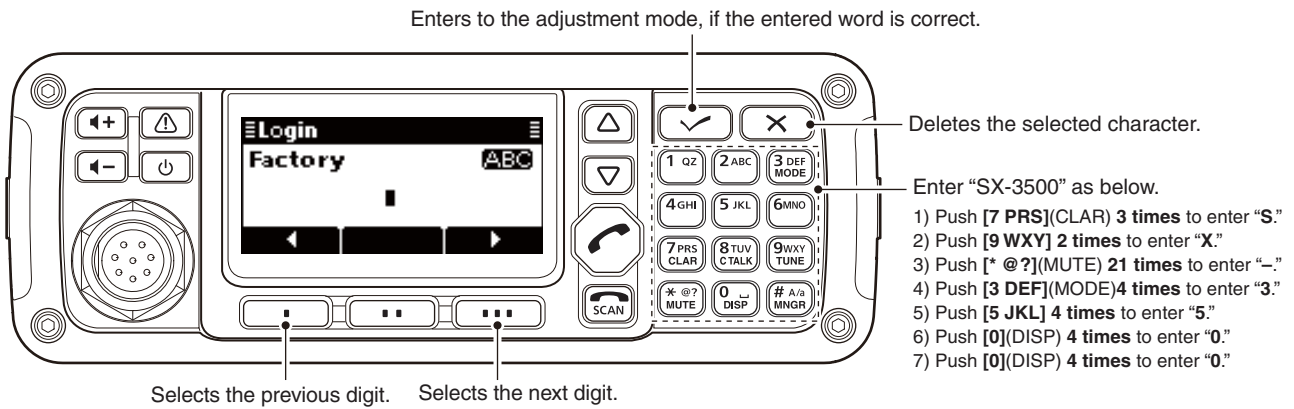

- 4) Hold down [SCAN] for 1 second to enter the Main Menu.
 - Select "Factory Menu" for adjustment.
 - Select "User Menu" for setting transceiver's condition. (For example; TX power, Squelch level, and so on.)

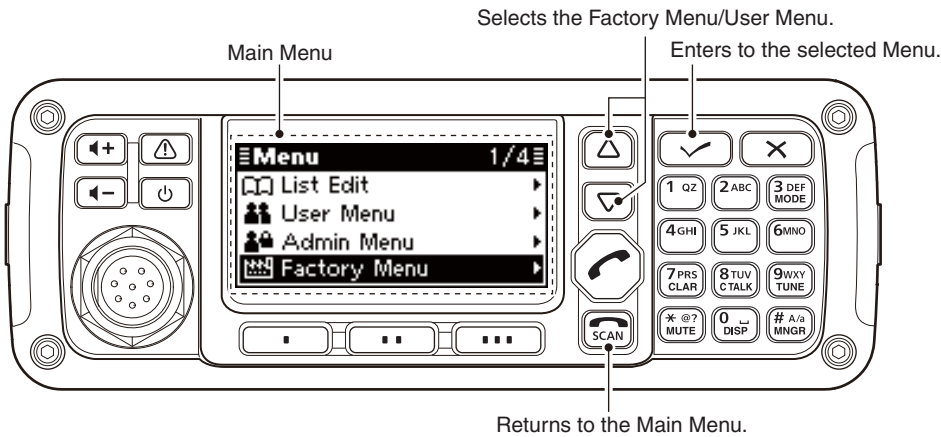

FACTORY MENU DESCRIPTION

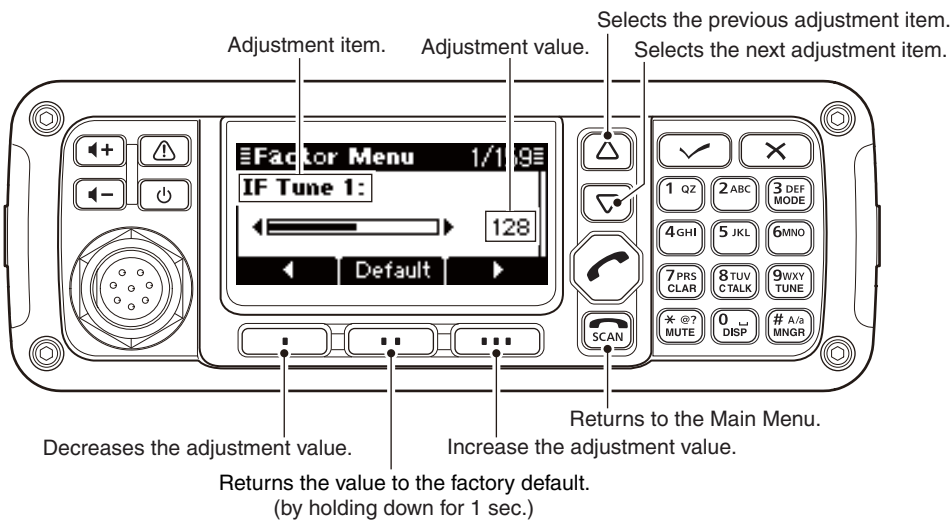

QUITTING ADJUSTMENT MODE

- 1) Turn OFF the transceiver power, if the transceiver is powered ON.
- 2) While holding down [SCAN], push [⏻] to turn ON the transceiver power.

5-2 RECIEVE ADJUSTMENTS

• Select the item using [△]/[▽], and then set or modify the value as specified, using [▪]/[▪▪▪].

ADJUSTMENT	TRANSCEIVER'S CONDITION	OPERATION	ADJUSTMENT ITEM	VALUE	
RX ADJUSTMENT PRESET	1 • Channel: 1 • Receiving	• Set the preset values.	S-26, S-27 (Factory Menu)	"SSB SQL" "0"	
				"AM SQL" "0"	
			(Rear panel)	External speaker Noise sound is heard.	
	2	• Connect an external speaker.			
	3	• Set the values.	S-26, S-27 (Factory Menu)	"SSB SQL" "18" "AM SQL" "18"	
RX 1ST MIXER	1 • Channel: 2 • Mode: USB • Receiving	• Connect an AC millivoltmeter to [SP].	(MAIN UNIT)	R1411, R1412 12 o'clock position. (Preset) 	
				R1411, R1412 (Repeatedly) Minimum AF output level.	
RX IF	1 • Channel: 3 • Mode: USB • Receiving	• Connect an AC millivoltmeter and [SP]. 1) Connect an SSG to the antenna connector, and then set it as; Frequency : 12.9 MHz 2) Set the SSG's output level so that the 1 kHz tone audio is heard.	(Connected SSG)	SSG's setting 1 kHz tone audio is heard.	
					2
					3
	4	• Connect an AC millivoltmeter to [SP].	(MAIN UNIT)	L1417, L1437, L1442, L1446 Maximum AF output level.	

• ADJUSTMENT POINTS ON THE MAIN UNIT

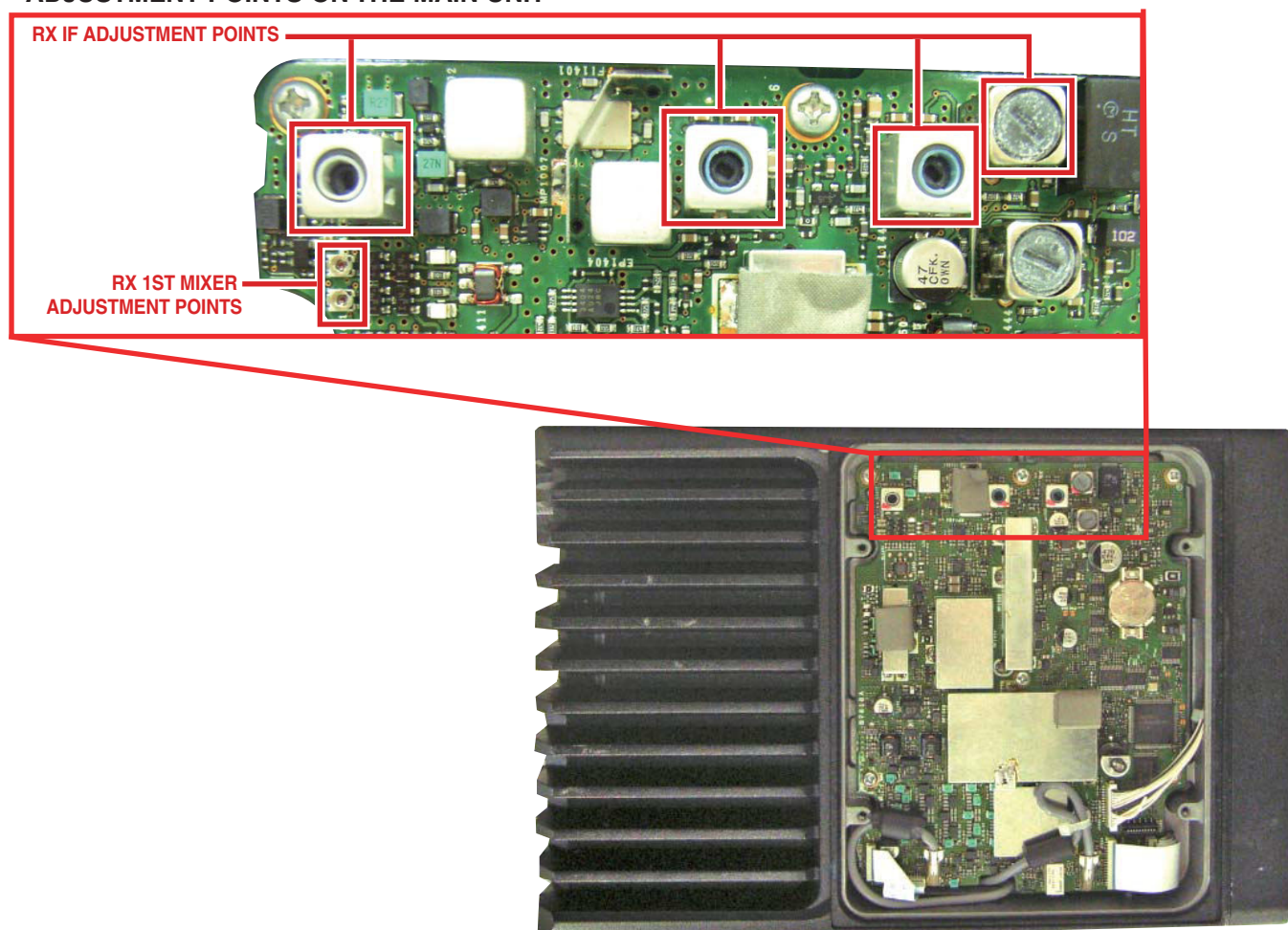

5-2 RECIEVE ADJUSTMENTS (Continued)

- Select the item using [Δ]/[∇], and then set or modify the value as specified, using [\square]/[\blacksquare].

ADJUSTMENT	TRANSCEIVER'S CONDITION	OPERATION	ADJUSTMENT ITEM		VALUE
RF GAIN	1	<ul style="list-style-type: none"> • Channel: 4 • Mode: USB • PRE AMP: OFF • Receiving 1) Connect an SSG to the antenna connector, and then set it as; Frequency : 12.9 MHz Level [†] : 60 dB μ (-47 dBm) 2) Connect an AC millivoltmeter to [SP].	-	-	Set this AF output level to "0 dB," as the reference.
	2		<ul style="list-style-type: none"> • Set the SSG as; Level[†] : OFF 	S-29 (Factory Menu)	"RX Total Gain"
S-METER	1	<ul style="list-style-type: none"> • Channel: 5 • Mode: USB <ul style="list-style-type: none"> • Connect an SSG to the antenna connector, and then set it as; Frequency : 12.9 MHz Level[†] : 84 dBμ (-23 dBm) 	-	-	Note the RSSI value on the right bottom of the LCD as the reference.
	2			S-30 (Factory Menu)	"S-METER FULL Set"

[†]; The output level of the standard signal generator (SSG) is indicated as the SSG's terminated circuit (emf).

• RSSI VALUE DISPLAY

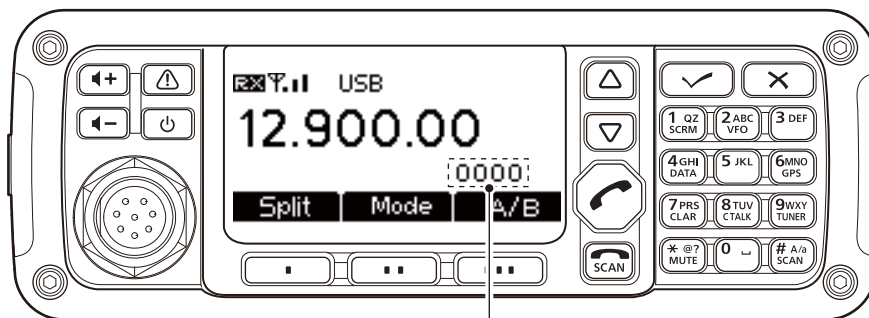

The RSSI value is displayed here.

5-3 TRANSMIT ADJUSTMENTS

• Select the item using [△]/[▽], and then set or modify the value as specified, using [▪]/[▪▪▪].

ADJUSTMENT	TRANSCIVER'S CONDITION	OPERATION	ADJUSTMENT ITEM	VALUE		
REFERENCE FREQUENCY	NOTE: Start this adjustment after the transceiver is cooled.					
	1	• Channel: 6 • Mode: CW • Transmitting	1) Connect a dummy load to the antenna connector. 2) Loosely couple a frequency counter to the dummy load.	S-25 (Factory Menu)	"REF Freq." 29.000000 MHz (±2 Hz)	
IDLING	1	• Channel: 7 • Mode: USB • Receiving	• Connect an ammeter to the DC power cable.	S-2 (Factory Menu)	"ID3V 6" "0"	
	2			S-7 to S-20 (Factory Menu)	"ID4V 1" to "ID4V 8"	"0"
	3					
	4					
	5	• Transmitting (Input no audio.)	–	–	Note the current value as the reference.	
	6	• Transmitting	S-2 (Factory Menu)	"ID3V 6"	1.5 A	
	7		S-1, S-3 to S-6 (Factory Menu)	"ID3V 1– 5" "ID3V 7" "ID3V 8"	The same value as adjustment "ID3V 6."	
	8		S-7 (Factory Menu)	"ID4V 1"	0.8 A more than the value shown in "Step 6."	
	9		S-8 (Factory Menu)	"ID4V 2"	0.7 A more than the value shown in "Step 6."	
	10		S-9 (Factory Menu)	"ID4V 3"	0.7 A more than the value shown in "Step 6."	
	11		S-10 (Factory Menu)	"ID4V 4 1"	0.3 A more than the value shown in "Step 6."	
	12		S-11 (Factory Menu)	"ID4V 4 2"	0.3 A more than the value shown in "Step 6."	
	13		S-12 (Factory Menu)	"ID4V 5"	0.3 A more than the value shown in "Step 6."	
	14		S-14 (Factory Menu)	"ID4V 6 2"	0.3 A more than the value shown in "Step 6."	
	15		S-16 (Factory Menu)	"ID4V 7 2"	0.2 A more than the value shown in "Step 6."	
	16		S-17 (Factory Menu)	"ID4V 7 3"	0.2 A more than the value shown in "Step 6."	
	17		S-18 (Factory Menu)	"ID4V 8 1"	0.2 A more than the value shown in "Step 6."	
	18		S-19 (Factory Menu)	"ID4V 8 2"	0.2 A more than the value shown in "Step 6."	
	19	S-20 (Factory Menu)	"ID4V 8 3"	0.2 A more than the value shown in "Step 6."		
	20	• Receiving	S-13, S-15 (Factory Menu)	"ID4V 6 1" "ID4V 7 1"	The same value as in "Step 14."	

5-3 TRANSMIT ADJUSTMENTS (Continued)

• Select the item using [△]/[▽], and then set or modify the value as specified, using [▪]/[•••].

ADJUSTMENT	TRANSCIVER'S CONDITION	OPERATION	ADJUSTMENT ITEM		VALUE
CM COUPLER	1 • Channel: 8 • Mode: CW • Receiving	• Connect an RF power meter to the antenna connector.	(CONFIG Menu)*	"RF Power"	"MID"
	2 • Transmitting		S-23 (Factory Menu)	"TX Middle Power"	30 W
	3	• Connect a digital voltmeter to "REF" on the PA UNIT.	(PA UNIT)	C5110	Minimum voltage

*: Enter the CONFIG Menu as shown below.

- 1) Push [X] to return to the Main Menu.
- 2) Select "SETMODE" and push [✓] to enter, and then select "CONFIG" using [△]/[▽].
- 3) Select "RF POWER," and then set the TX power.
- 4) Return to the Factory Menu to continue the adjustment.

• ADJUSTMENT POINT ON THE PA UNIT

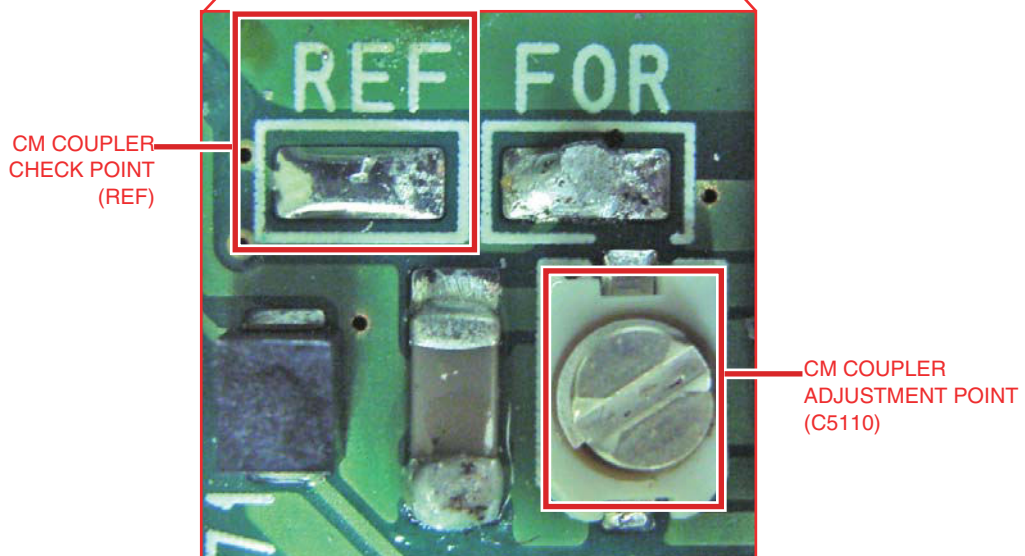
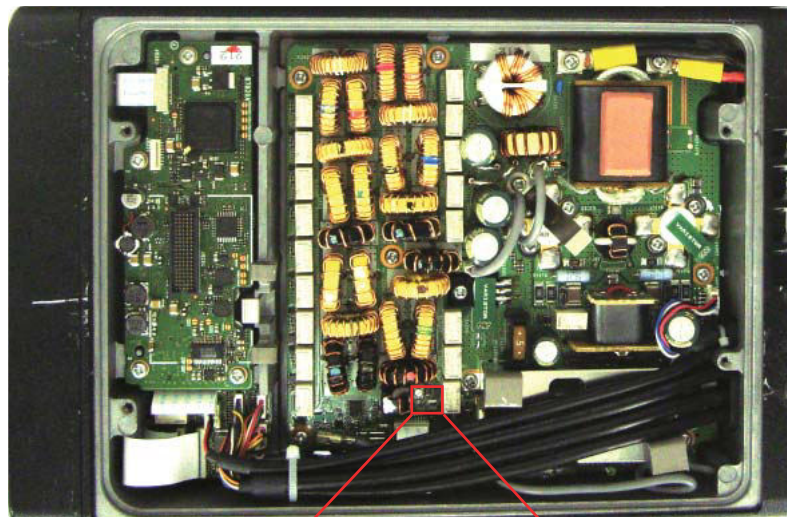

5-3 TRANSMIT ADJUSTMENTS (Continued)

• Select the item using [△]/[▽], and then set or modify the value as specified, using [•]/[***].

ADJUSTMENT	TRANSCIVER'S CONDITION	OPERATION	ADJUSTMENT ITEM		VALUE
TX IF	1 • Channel: 9 • Mode: USB • Receiving	1) Connect an RF power meter to the antenna connector. 2) Connect an AG and AC millivoltmeter to [MIC] (See the illust below.), and then set it as; Level : 1 mV	(CONFIG Menu)*	"RF Power"	"HIGH"
	2 • Transmitting		(MAIN UNIT)	L1444	Maximum TX power
TX IF GAIN	1 • Channel: 10 • Receiving	—	(MAIN UNIT)	R1535	Center position

*; Enter the CONFIG Menu as shown below.

- 1) Push [X] to return to the Main Menu.
- 2) Select "SETMODE" and push [✓] to enter, and then select "CONFIG" using [△]/[▽].
- 3) Select "RF POWER," and then set the TX power.
- 4) Return to the Factory Menu to continue the adjustment.

• ADJUSTMENT POINT ON THE MAIN UNIT

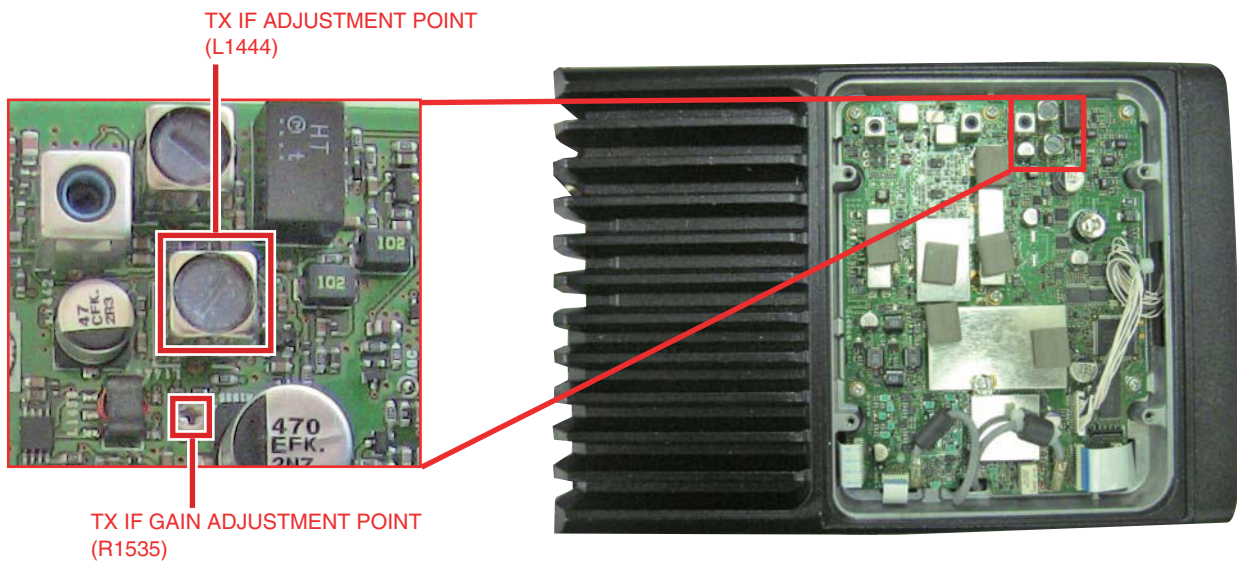

• CONNECTION FOR THE TX IF ADJUSTMENT

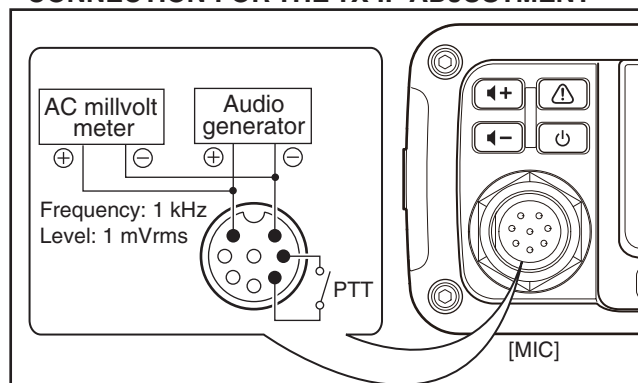

5-3 TRANSMIT ADJUSTMENTS (Continued)

- Select the item using [Δ]/[▽], and then set or modify the value as specified, using [▪]/[•••].

ADJUSTMENT	TRANSCIVER'S CONDITION	OPERATION	ADJUSTMENT ITEM	VALUE	
ALC CURRENT	1	1) Connect an RF power meter to the antenna connector. 2) Connect check point "FOR" on the PA UNIT to the ground.	(CONFIG Menu)*	"RF Power"	"HIGH"
	2		S-21 (Factory Menu)	"ICCV"	"0"
	3		S-24 (Factory Menu)	"TX High Power"	"255"
	4	• Transmitting	S-21 (Factory Menu)	"ICCV"	27.5 A
	5		S-24 (Factory Menu)	"TX High Power"	"0"

*; Enter the CONFIG Menu as shown below.

- 1) Push [X] to return to the Main Menu.
- 2) Select "SETMODE" and push [✓] to enter, and then select "CONFIG" using [Δ]/[▽].
- 3) Select "RF POWER," and then set the TX power.
- 4) Return to the Factory Menu to continue the adjustment.

• ADJUSTMENT POINT ON THE PA UNIT

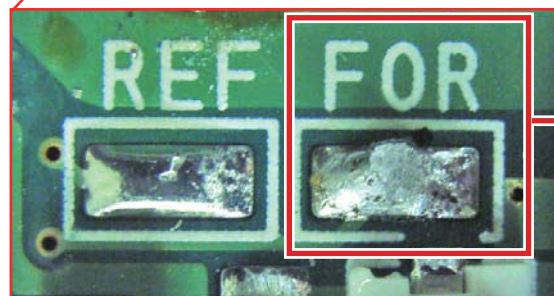
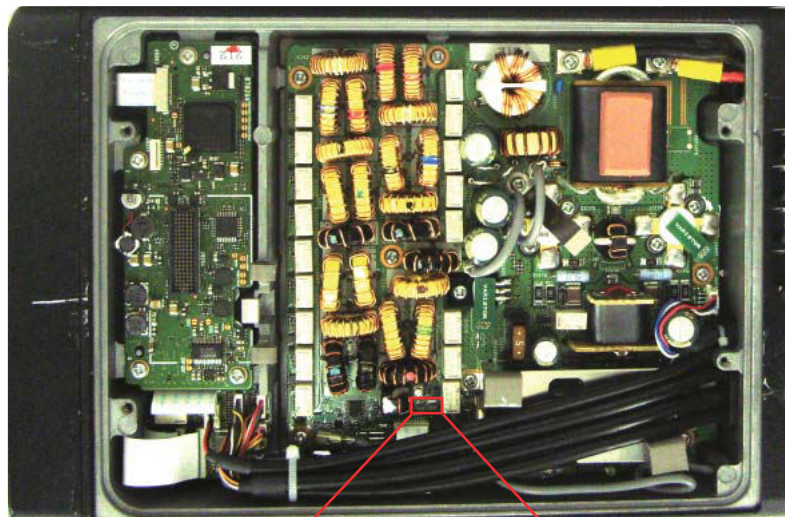

ALC CURRENT CHECK POINT (FOR)

5-3 TRANSMIT ADJUSTMENTS (Continued)

• Select the item using [△]/[▽], and then set or modify the value as specified, using [■]/[***].

ADJUSTMENT	TRANSCIVER'S CONDITION	OPERATION	ADJUSTMENT ITEM		VALUE	
TX POWER (CW mode)	1	• Channel: 12 • Mode: CW • Receiving	• Connect an RF power meter to the antenna connector.	(CONFIG Menu)*	"RF Power"	"LOW"
	2	• Transmitting		S-22 (Factory Menu)	"TX Low Power"	10 W
	3	• Receiving		(CONFIG Menu)*	"RF Power"	"MID"
	4	• Transmitting		S-23 (Factory Menu)	"TX Middle Power"	50 W
	5	• Receiving		(CONFIG Menu)*	"RF Power"	"HIGH"
	6	• Transmitting		S-24 (Factory Menu)	"TX High Power"	125 W 100 W*
TX POWER (AM mode)	1	• Channel: 13 • Mode: AM • Receiving	• Connect an RF power meter to the antenna connector.	(CONFIG Menu)*	"RF Power"	"HIGH"
	2	• Transmitting		(Factory Menu>Detail-41)	"AM Power Ratio"	30 W
TX POWER (DATA)	1	• Channel: 14 • Mode: RTTY • Receiving	• Connect an RF power meter to the antenna connector.	(CONFIG Menu)*	"RF Power"	"HIGH"
	2	• Transmitting		(Factory Menu>Detail-42)	"DATA Power Ratio"	75 W
PO METER*	3			(Factory Menu>Design-73)	"Power Meter"	140
TX SENSITIVITY	1	• Channel: 15 • Receiving	1) Connect an RF power meter to the antenna connector. 2) Connect an AG and AC millivoltmeter to [MIC], and then set it as; Level : 2 mV	(CONFIG Menu)*	"RF Power H"	"HIGH"
	2	• Mode: USB • Transmitting		(MAIN UNIT)	R1535	70 W

†; Set the transceiver's condition as shown below.

*; For only [AUS].

- 1) Push [SCAN] to return to the Main Menu.
- 2) Select the User Menu and push [✓] to enter, and then select the item using [△]/[▽], and set the value as specified using [■]/[***].
- 3) Return to the Factory Menu to continue the adjustment.

• ADJUSTMENT POINT ON THE MAIN UNIT

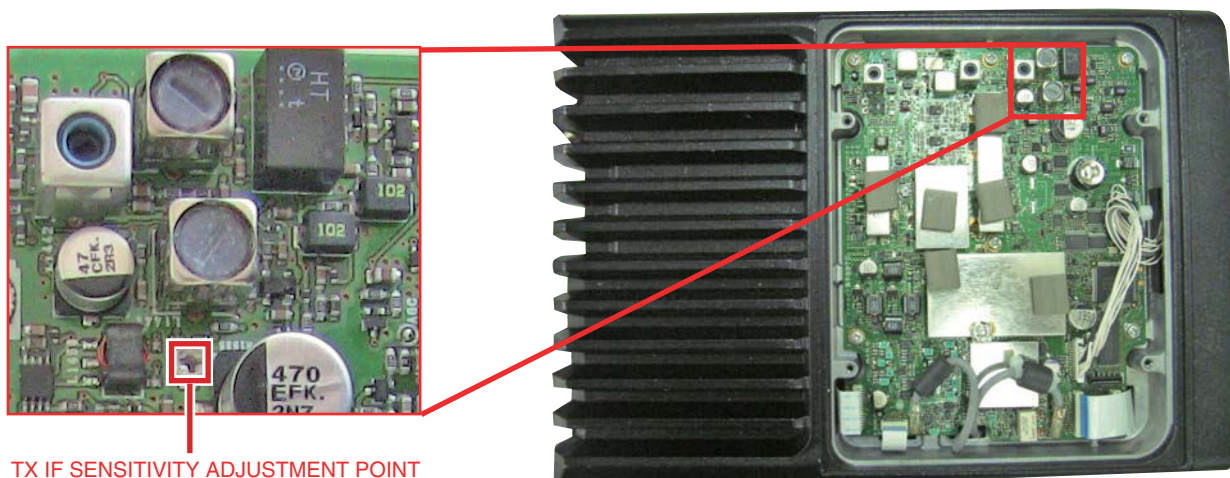

TX IF SENSITIVITY ADJUSTMENT POINT (R1535)

SECTION 6

PARTS LIST

[MAIN UNIT]

REF NO.	PARTS NO.	DESCRIPTION	M.	H/V LOCATION
IC1102	1110004050	S.IC NJM3404AV-TE1-#FMZB	T	112.7/78.5
IC1103	1110004050	S.IC NJM3404AV-TE1-#FMZB	T	124.4/78.4
IC1104	1130011760	S.IC CD4094BPWR	T	94.0/31.4
IC1105	1130011760	S.IC CD4094BPWR	T	104.7/31.4
IC1401	1110005461	S.IC TA4107F(TE12LF)	T	94.6/98.3
IC1402	1130014270	S.IC TSSA2053DCTR	T	118.7/50.0
IC1403	1130008511	S.IC TC7W53FU(TE12LF)	T	110.3/40.6
IC1404	1130014260	S.IC SN74LVC2GU04DCKR	T	105.6/51.4
IC1601	1190003440	S.IC AD9837BCPZ-RL7 <FE>	T	86.1/51.2
IC1602	1110006870	S.IC UPC2709TB-E3	T	96.6/59.1
IC1603	1130013440	S.IC SN74LVC2G74DCTR	T	66.6/63.8
IC1604	1110006870	S.IC UPC2709TB-E3	T	59.7/66.5
IC1605	1130012610	S.IC SN74AHC1GU04DCKR	T	66.7/67.1
IC1606	1110006870	S.IC UPC2709TB-E3	T	63.3/39.2
IC1701	1130010111	S.IC TC7WH04FU(TE12LF)	T	57.8/48.1
IC1702	1130012850	S.IC SN74LVC3G34DCUR	T	57.6/51.3
IC1703	1190002101	S.IC AD9951YSVZ <FE>	T	48.0/40.6
IC1704	1180003200	S.REG UPD120N18TA-E1-AT	T	57.3/35.3
IC1705	1110006990	S.IC UPC2710TB-E3	T	61.3/79.5
IC1801	1110005761	S.IC S-812C50AUA-C3E-G	T	97.1/6.4
IC1802	1130003831	S.IC TC7S04F(TE85RF)	T	55.9/29.4
IC1804	1130007111	S.IC TC7W04FU(TE12LF)	T	76.2/11.4
IC1805	1130013520	S.IC CD4028BNSR	B	61.8/17.2
IC1806	1140016595	S.IC R5F36CAMDFB (SX-3500A-5)	T	58.2/11.8
IC1807	1130006441	S.IC TC7S08F(TE85RF)	T	61.5/30.2
IC1808	1110006271	S.IC S-80842CNMC-B83-T2G	T	61.5/26.7
IC1810	1130015080	S.IC R1EX24512ASAS0A	B	56.7/7.7
IC1812	1130016140	S.IC RL1P1018ESA-5SI	T	41.1/14.6
IC1814	1110003800	S.IC NJM2904V-TE1-#FMZB	T	82.6/32.9
IC1815	1130016460	S.IC R2A20169SA	T	82.8/5.9
IC1817	1130010560	S.IC SN74AHC244PWR	T	74.0/18.1
IC1818	1130013540	S.IC TC74LVX4245FS(ELF)	T	74.4/26.4
IC1819	1190003280	S.IC RX-8571SA B	B	71.1/45.2
IC1820	1130006441	S.IC TC7S08F(TE85RF)	B	83.2/51.2
Q1101	1530003091	S.TRA 2SC4213-B(TE85RF)	T	6.8/50.9
Q1102	1590002420	S.TRA UMD3N TR	T	3.5/56.0
Q1103	1590004420	S.TRA IMD3AT108	B	32.2/99.7
Q1104	1590004420	S.TRA IMD3AT108	B	24.9/93.0
Q1105	1590004420	S.TRA IMD3AT108	B	24.9/88.4
Q1106	1590004420	S.TRA IMD3AT108	B	24.9/81.7
Q1107	1590004420	S.TRA IMD3AT108	B	24.9/68.9
Q1108	1590004420	S.TRA IMD3AT108	B	24.9/61.0
Q1109	1590004420	S.TRA IMD3AT108	B	24.9/53.9
Q1110	1590004420	S.TRA IMD3AT108	B	24.9/48.0
Q1111	1590002420	S.TRA UMD3N TR	T	65.6/109.0
Q1112	1590002420	S.TRA UMD3N TR	T	46.1/108.3
Q1113	1590000720	S.TRA DTA144EUA T106	T	107.0/76.2
Q1114	1590001050	S.TRA DTC114TUA T106	T	109.5/76.2
Q1115	1590000680	S.TRA DTC114EUA T106	B	118.4/83.3
Q1116	1530003852	S.TRA 2SC5551A-F-TD-E	T	56.3/95.0
Q1117	1530003852	S.TRA 2SC5551A-F-TD-E	T	56.8/108.1
Q1118	1510000510	S.TRA 2SA1576A T106R	T	118.0/77.8
Q1119	1530003091	S.TRA 2SC4213-B(TE85RF)	T	104.9/69.3
Q1401	1530002371	S.FET 2SC2714-O(TE85RF)	T	85.6/101.8
Q1404	1560000641	S.FET 2SK1740-4/5-TB-E	T	127.8/101.1
Q1405	1560000641	S.FET 2SK1740-4/5-TB-E	T	124.4/98.1
Q1406	1560000641	S.FET 2SK1740-4/5-TB-E	T	124.4/101.1
Q1407	1560000641	S.FET 2SK1740-4/5-TB-E	T	127.8/98.1
Q1408	1590002420	S.TRA UMD3N TR	T	131.3/84.9
Q1409	1580000820	S.FET 3SK264-5-TG-E	T	129.1/108.3
Q1410	1530002680	S.TRA 2SC3357-T1	T	94.1/89.9
Q1411	1530002060	S.TRA 2SC4081 T106 R	T	118.5/20.2
Q1412	1530002060	S.TRA 2SC4081 T106 R	T	124.6/20.6
Q1413	1580000820	S.FET 3SK264-5-TG-E	T	120.0/11.0
Q1414	1580000820	S.FET 3SK264-5-TG-E	T	135.0/55.4
Q1415	1580000820	S.FET 3SK264-5-TG-E	T	131.3/13.2
Q1416	1580000820	S.FET 3SK264-5-TG-E	T	127.4/29.1
Q1417	1580000820	S.FET 3SK264-5-TG-E	T	141.3/17.9
Q1601	1530002371	S.TRA 2SC2714-O(TE85RF)	T	58.8/61.3
Q1701	1590002420	S.TRA UMD3N TR	T	75.0/89.1
Q1702	1590002420	S.TRA UMD3N TR	T	77.7/89.1
Q1801	1530002691	S.TRA 2SC4116-GR(TE85RF)	T	33.7/20.1
Q1803	1590004400	S.TRA DMG564010R	T	78.3/38.7
Q1804	1590004400	S.TRA DMG564010R	T	84.2/39.0
Q1805	1530002691	S.TRA 2SC4116-GR(TE85RF)	T	67.3/27.2
Q1806	1590000680	S.TRA DTC114EUA T106	T	92.0/26.9
Q1808	1530002371	S.TRA 2SC2714-O(TE85RF)	T	72.8/48.5
Q1809	1590002420	S.TRA UMD3N TR	T	30.6/23.7
Q1810	1530003340	S.TRA 2SC3357-T1 RF	B	143.8/93.1
Q1811	1510000771	S.TRA 2SA1586-GR(TE85LF)	T	89.3/26.9
Q1812	1590004420	S.TRA IMD3AT108	T	12.1/91.7
Q1814	1590004420	S.TRA IMD3AT108	B	95.8/100.5
D1106	1790001621	S.DIO 1SV308(TPL3F)	T	11.8/68.9
D1107	1790001621	S.DIO 1SV308(TPL3F)	T	9.6/51.5
D1108	1790001621	S.DIO 1SV308(TPL3F)	T	12.2/50.3
D1109	1750001810	S.DIO L1SS400T1G <SLVJ>	T	9.4/77.0
D1110	1750001810	S.DIO L1SS400T1G <SLVJ>	T	7.4/79.0
D1111	1790001621	S.DIO 1SV308(TPL3F)	T	9.3/72.0
D1112	1790001621	S.DIO 1SV308(TPL3F)	T	14.3/69.7
D1113	1790001621	S.DIO 1SV308(TPL3F)	T	18.4/87.5
D1114	1790001621	S.DIO 1SV308(TPL3F)	T	18.4/79.8
D1115	1790001621	S.DIO 1SV308(TPL3F)	T	18.4/63.6
D1116	1790001621	S.DIO 1SV308(TPL3F)	T	18.4/71.7
D1117	1790001621	S.DIO 1SV308(TPL3F)	T	18.4/55.8

[MAIN UNIT]

REF NO.	PARTS NO.	DESCRIPTION	M.	H/V LOCATION
D1118	1790001621	S.DIO 1SV308(TPL3F)	T	18.3/47.8
D1119	1790001621	S.DIO 1SV308(TPL3F)	T	23.8/95.8
D1120	1790001621	S.DIO 1SV308(TPL3F)	T	36.5/42.2
D1121	1790001621	S.DIO 1SV308(TPL3F)	T	37.4/87.5
D1122	1790001621	S.DIO 1SV308(TPL3F)	T	37.2/79.8
D1123	1790001621	S.DIO 1SV308(TPL3F)	T	37.2/63.6
D1124	1790001621	S.DIO 1SV308(TPL3F)	T	37.2/71.7
D1125	1790001621	S.DIO 1SV308(TPL3F)	T	37.2/55.8
D1126	1790001621	S.DIO 1SV308(TPL3F)	T	37.1/47.8
D1127	1790001621	S.DIO 1SV308(TPL3F)	T	37.2/95.8
D1128	1790000491	S.DIO HSM88ASTR-E	T	113.9/69.8
D1129	1790001621	S.DIO 1SV308(TPL3F)	T	43.5/88.4
D1130	1790000491	S.DIO HSM88ASTR-E	B	117.6/77.5
D1131	1790001621	S.DIO 1SV308(TPL3F)	T	43.5/84.1
D1132	1790000491	S.DIO HSM88ASTR-E	B	112.0/76.9
D1133	1790001621	S.DIO 1SV308(TPL3F)	T	70.1/84.1
D1134	1750001810	S.DIO L1SS400T1G <SLVJ>	T	10.9/72.2
D1135	1750001810	S.DIO L1SS400T1G <SLVJ>	T	120.7/70.8
D1136	1750001950	S.ZEN HZU3.6B1TRF-E	T	118.5/71.8
D1137	1750001810	S.DIO L1SS400T1G <SLVJ>	T	116.9/71.6
D1138	1750001810	S.DIO L1SS400T1G <SLVJ>	T	109.7/84.7
D1139	1750001810	S.DIO L1SS400T1G <SLVJ>	T	120.3/74.3
D1141	1750001810	S.DIO L1SS400T1G <SLVJ>	T	103.8/72.1
D1142	1790001621	S.DIO 1SV308(TPL3F)	T	70.9/92.0
D1143	1750001810	S.DIO L1SS400T1G <SLVJ>	T	124.9/69.5
D1401	1750001790	S.DIO 1SS390 TE61	T	80.4/101.2
D1402	1750001790	S.DIO 1SS390 TE61	T	107.3/91.7
D1403	1750001790	S.DIO 1SS390 TE61	T	108.1/89.1
D1404	1750001790	S.DIO 1SS390 TE61	T	134.7/106.5
D1405	1750001790	S.DIO 1SS390 TE61	T	141.4/95.4
D1406	1750001790	S.DIO 1SS390 TE61	T	80.4/105.2
D1407	1750001790	S.DIO 1SS390 TE61	T	129.4/66.6
D1408	1750001790	S.DIO 1SS390 TE61	T	130.8/66.6
D1409	1720000811	S.VAR HVC358BTRF-E	T	38.3/58.0
D1410	1750001790	S.DIO 1SS390 TE61	T	130.2/64.8
D1411	1750001790	S.DIO 1SS390 TE61	T	131.1/61.6
D1412	1750001790	S.DIO 1SS390 TE61	T	113.7/10.0
D1414	1720000811	S.VAR HVC358BTRF-E	T	138.2/52.9
D1415	1750001790	S.DIO 1SS390 TE61	B	126.4/42.7
D1416	1750001790	S.DIO 1SS390 TE61	B	129.5/43.6
D1417	1750001790	S.DIO 1SS390 TE61	B	134.7/32.3
D1418	1750001790	S.DIO 1SS390 TE61	B	134.7/34.0
D1419	1750001790	S.DIO 1SS390 TE61	T	142.5/21.9
D1420	1750001790	S.DIO 1SS390 TE61	T	130.2/17.0
D1421	1750001790	S.DIO 1SS390 TE61	T	137.4/12.6
D1701	1790001621	S.DIO 1SV308(TPL3F)	T	49.9/62.8
D1702	1750001080	S.DIO RB886G T2R	T	48.5/75.4
D1703	1750001080	S.DIO RB886G T2R	T	46.0/75.4
D1704	1790001621	S.DIO 1SV308(TPL3F)	T	75.6/72.8
D1705	1790001621	S.DIO 1SV308(TPL3F)	T	75.3/81.5
D1706	1790001621	S.DIO 1SV308(TPL3F)	T	97.3/77.2
D1707	1790001621	S.DIO 1SV308(TPL3F)	T	97.3/78.6
D1802	1750001180	S.DIO KDS122 RTK/P	T	65.7/22.7
D1803	1750001180	S.DIO KDS122 RTK/P	T	72.6/2.9
D1804	1750001180	S.DIO KDS122 RTK/P	T	58.4/23.4
D1806	1750001180	S.DIO KDS122 RTK/P	T	76.7/2.9
D1807	1750001810	S.DIO L1SS400T1G <SLVJ>	T	61.0/22.0
D1809	1750001810	S.DIO L1SS400T1G <SLVJ>	T	65.6/29.2
D1812	1750001210	S.DIO HSB88ASTR-E	T	118.7/60.1
D1813	1750001210	S.DIO HSB88ASTR-E	T	117.6/50.9
D1814	1750001810	S.DIO L1SS400T1G <SLVJ>	T	103.6/9.9
F11401	2030000800	S.MON MFT64.4R 64.455 MHz (FL-434)	T	142.0/78.5
F11402	2020001330	CER CFWLA455KHFA-B0 (CFWS455HT)		
X1601	6050013110	S.XTA CR-905 TTS18VSH 32 MHz	T	59.1/57.8
X1802	6050013120	S.XTA CR-917 TAS-3225J 16.000 MHz	T	71.1/12.1
L1002	6200002041	S.COI NLV25T-101J	B	5.1/104.4
L1101	6200005011	S.COI NLV25T-100J	T	9.3/83.3
L1102	6200005491	S.COI NLV32T-331J	T	14.3/74.7
L1103	6200005491	S.COI NLV32T-331J	T	13.0/66.6
L1104	6200002041	S.COI NLV25T-101J	T	12.3/52.4
L1105	6200005491	S.COI NLV32T-331J	T	13.2/61.9
L1106	6200001851	S.COI NLV32T-5R6J	T	13.2/56.7
L1107	6200005011	S.COI NLV25T-100J	T	12.6/79.2
L1108	6200010800	S.COI C2520C-4R7G-A	T	9.7/58.7
L1109	6200002041	S.COI NLV25T-101J	T	9.2/66.7
L1110	6200002041	S.COI NLV25T-101J	T	11.0/75.1
L1111	6200001851	S.COI NLV32T-5R6J	T	18.6/90.4
L1112	6200010820	S.COI C2520C-2R7G-A	T	18.4/82.3
L1113	6200010810	S.COI C2520C-2R2G-A	T	18.4/66.2
L1114	6200010950	S.COI C2520C-1R5G-A (1.5U)	T	18.4/74.3
L1115	6200010780	S.COI C2520C-1R0G-A	T	18.4/58.4
L1116	6200010770	S.COI C2520C-R68G-A	T	18.3/50.4
L1117	6200010870	S.COI C2520C-R33G-A (0.33U)	T	23.7/98.4
L1118	6200009060	S.COI LQH32CN101K23L	T	21.0/43.3
L1119	6200003121	S.COI NLV32T-8R2J	T	22.7/88.3
L1121	6200010830	S.COI C2520C-3R3G-A	T	22.7/64.4
L1122	6200010810	S.COI C2520C-2R2G-A	T	22.7/72.5
L1123	6200010950	S.COI C2520C-1R5G-A (1.5U)	T	22.8/56.6
L1124	6200010			

[MAIN UNIT]

REF NO.	PARTS NO.	DESCRIPTION	M.	H/V LOCATION
L1127	6200003121	S.COI NLV32T-8R2J	T	27.9/91.8
L1129	6200010830	S.COI C2520C-3R3G-A	T	27.8/67.4
L1130	6200010810	S.COI C2520C-2R2G-A	T	27.8/75.5
L1131	6200010950	S.COI C2520C-1R5G-A (1.5U)	T	27.8/59.6
L1132	6200010780	S.COI C2520C-1R0G-A	T	27.7/51.6
L1133	6200010520	S.COI C2520C-R75G-A (0.75U)	T	30.5/99.8
L1134	6200003121	S.COI NLV32T-8R2J	T	33.1/88.3
L1135	6200001851	S.COI NLV32T-5R6J	T	27.8/83.7
L1136	6200010830	S.COI C2520C-3R3G-A	T	32.9/64.4
L1137	6200010810	S.COI C2520C-2R2G-A	T	32.9/72.5
L1138	6200010950	S.COI C2520C-1R5G-A (1.5U)	T	32.9/56.6
L1139	6200010780	S.COI C2520C-1R0G-A	T	32.6/48.6
L1140	6200010450	S.COI C2520C-R82G-A (0.82U)	T	33.8/96.6
L1141	6200010800	S.COI C2520C-4R7G-A	T	33.7/43.4
L1142	6200001851	S.COI NLV32T-5R6J	T	37.3/90.4
L1143	6200010820	S.COI C2520C-2R7G-A	T	37.2/82.3
L1144	6200010810	S.COI C2520C-2R2G-A	T	37.2/66.2
L1145	6200010950	S.COI C2520C-1R5G-A (1.5U)	T	37.2/74.3
L1146	6200010780	S.COI C2520C-1R0G-A	T	37.2/58.4
L1147	6200010770	S.COI C2520C-R68G-A	T	37.1/50.4
L1148	6200010870	S.COI C2520C-R33G-A (0.33U)	T	37.2/98.5
L1149	6200005491	S.COI NLV32T-331J	T	34.7/39.6
L1150	6200002041	S.COI NLV25T-101J	T	41.1/89.3
L1151	6200002041	S.COI NLV25T-101J	T	43.9/100.9
L1152	6140003800	COI LR-439		
L1153	6200002041	S.COI NLV25T-101J	T	47.2/85.9
L1154	6200002041	S.COI NLV25T-101J	T	46.8/101.7
L1155	6200002041	S.COI NLV25T-101J	T	68.0/86.5
L1156	6140003810	COI LR-440		
L1157	6140003810	COI LR-440		
L1158	6140003800	COI LR-439		
L1159	6200009060	S.COI LQH32CN101K23L	T	62.2/86.3
L1160	6200002041	S.COI NLV25T-101J	T	70.4/99.1
L1161	6200002041	S.COI NLV25T-101J	T	70.5/89.0
L1162	6200007780	S.COI LQW2BHN1R2J03L	T	70.4/94.4
L1163	6200002041	S.COI NLV25T-101J	T	118.0/67.6
L1164	6200010830	S.COI C2520C-3R3G-A	T	4.7/80.3
L1401	6200003261	S.COI NLV32T-101J	T	80.9/98.6
L1403	6200003261	S.COI NLV32T-101J	T	84.6/98.8
L1406	6200002041	S.COI NLV25T-101J	T	93.5/101.5
L1407	6200002041	S.COI NLV25T-101J	T	90.9/101.1
L1409	6200007780	S.COI LQW2BHN1R2J03L	T	128.8/94.4
L1410	6200013000	S.COI 0.25-1.9-13TL 135N <COMO>	T	93.4/107.3
L1411	6130002961	S.COI #617DB-1327=P3	T	126.1/89.4
L1412	6200007780	S.COI LQW2BHN1R2J03L	T	123.4/94.4
L1413	6200002041	S.COI NLV25T-101J	T	99.8/101.9
L1414	6200013080	S.COI 0.25-1.9-10TL 97.0N <COMO>	T	88.4/106.5
L1415	6200003261	S.COI NLV32T-101J	T	132.1/94.5
L1416	6200002631	S.COI NLV25T-R10J	T	99.6/98.2
L1417	6150005320	COI LS-546 7K7		
L1418	6200012470	S.COI 0.30-1.7-7TL 45.3N <COMO>	T	84.4/107.3
L1419	6200002421	S.COI NLV25T-068J	T	105.4/92.0
L1422	6200002601	S.COI NLV25T-047J	T	102.7/92.0
L1423	6200009861	S.COI NLV25T-1R5J	B	127.6/106.3
L1424	6200003281	S.COI NLV25T-2R2J	T	144.9/96.1
L1425	6200003261	S.COI NLV32T-101J	T	80.4/109.2
L1426	6200010760	S.COI C2520C-27NG-A	T	137.9/94.8
L1427	6200012350	S.COI C2520C-R62G-A	T	141.9/90.2
L1428	6200012350	S.COI C2520C-R62G-A	T	141.9/87.0
L1429	6200003261	S.COI NLV32T-101J	T	134.0/88.3
L1430	6200002631	S.COI NLV25T-R10J	T	98.2/90.9
L1431	6200003281	S.COI NLV25T-2R2J	T	92.1/93.7
L1432	6200005011	S.COI NLV25T-100J	T	79.8/93.9
L1433	6200003261	S.COI NLV32T-101J	T	132.9/111.4
L1435	6200012350	S.COI C2520C-R62G-A	T	132.3/74.9
L1436	6200012350	S.COI C2520C-R62G-A	T	135.5/74.9
L1437	6150004280	COI LS-484B (C-14927)		
L1438	6200003520	S.COI ELJFB 102K-F	T	116.0/15.3
L1439	6140004680	S.COI LR-528 4KBL	T	124.3/58.5
L1440	6200009861	S.COI NLV25T-1R5J	B	128.5/50.9
L1441	6200009861	S.COI NLV25T-1R5J	B	124.7/48.3
L1442	6150004280	COI LS-484B (C-14927)		
L1443	6200003520	S.COI ELJFB 102K-F	T	131.2/8.2
L1444	6150005420	COI LS-554 7QM		
L1445	6140002810	S.COI LR-317	T	113.5/58.5
L1446	6150005410	COI LS-553 7QM		
L1447	6200003520	S.COI ELJFB 102K-F	T	132.0/24.8
L1448	6200003520	S.COI ELJFB 102K-F	T	124.8/13.8
L1449	6200003261	S.COI NLV32T-101J	T	113.2/49.2
L1450	6140004680	S.COI LR-528 4KBL	T	120.5/42.6
L1451	6200003520	S.COI ELJFB 102K-F	T	135.1/19.9
L1452	6200005521	S.COI NLV25T-470J	T	109.3/48.9
L1453	6200003261	S.COI NLV32T-101J	T	113.1/37.3
L1454	6200003520	S.COI ELJFB 102K-F	T	102.3/36.9
L1455	6200002041	S.COI NLV25T-101J	T	77.3/106.7
L1456	6200005140	S.COI MLF1608D R33K-T	B	133.3/107.6
L1601	6200005521	S.COI NLV25T-470J	T	95.5/50.9
L1602	6200002631	S.COI NLV25T-R10J	T	108.5/58.3
L1603	6200005031	S.COI NLV25T-180J	T	92.5/52.0
L1604	6200002181	S.COI NLV25T-R12J	T	104.3/58.1
L1605	6200005011	S.COI NLV25T-100J	T	55.9/57.6
L1606	6200009861	S.COI NLV25T-1R5J	T	99.4/58.8
L1607	6200005011	S.COI NLV25T-100J	T	74.9/45.5
L1608	6200002581	S.COI NLV25T-033J	T	68.0/51.9
L1609	6200005011	S.COI NLV25T-100J	T	79.2/49.0
L1610	6200005011	S.COI NLV25T-100J	T	55.9/62.1
L1612	6200003891	S.COI NLV25T-027J	T	67.5/48.9
L1613	6200003891	S.COI NLV25T-027J	T	68.0/45.9
L1614	6200003891	S.COI NLV25T-027J	T	66.0/42.8
L1615	6200003891	S.COI NLV25T-027J	T	67.0/40.1
L1616	6200005011	S.COI NLV25T-100J	T	55.9/65.6
L1617	6200002631	S.COI NLV25T-R10J	T	93.3/61.4
L1618	6200002581	S.COI NLV25T-033J	T	68.1/37.1
L1619	6200005011	S.COI NLV25T-100J	T	66.5/69.8
L1620	6200002631	S.COI NLV25T-R10J	T	92.2/57.6

Eqv.= This component is equivalent to the REF No. component listed above, and may be substituted on parts orders and repairs.

[MAIN UNIT]

REF NO.	PARTS NO.	DESCRIPTION	M.	H/V LOCATION
L1621	6200005011	S.COI NLV25T-100J	T	56.6/68.4
L1622	6200002431	S.COI NLV25T-082J	T	88.2/59.3
L1623	6200002431	S.COI NLV25T-082J	T	85.2/59.9
L1624	6200002631	S.COI NLV25T-R10J	T	84.5/57.0
L1625	6200002611	S.COI NLV25T-R47J	T	60.7/40.0
L1626	6200002581	S.COI NLV25T-033J	T	65.8/54.4
L1627	6200002581	S.COI NLV25T-033J	T	60.0/42.9
L1628	6200002581	S.COI NLV25T-033J	T	57.3/43.3
L1701	6200002431	S.COI NLV25T-082J	T	57.2/38.6
L1702	6140002810	S.COI LR-317	T	47.2/55.0
L1703	6200005011	S.COI NLV25T-100J	T	61.5/51.0
L1704	6200009571	S.COI ELJRE R12GFA	T	45.1/61.8
L1705	6200007790	S.COI LQW2BHN1R15J03L	T	47.2/47.0
L1706	6200009571	S.COI ELJRE R12GFA	T	45.1/64.7
L1707	6140002810	S.COI LR-317	T	47.2/70.5
L1708	6200002001	S.COI NLV25T-3R3J	T	45.5/78.3
L1709	6200007790	S.COI LQW2BHN1R15J03L	T	48.6/77.8
L1710	6200002431	S.COI NLV25T-082J	T	52.4/80.4
L1711	6200002431	S.COI NLV25T-082J	T	55.3/79.4
L1712	6200009861	S.COI NLV25T-1R5J	T	64.0/79.2
L1713	6200002421	S.COI NLV25T-068J	T	66.8/76.3
L1714	6200002411	S.COI NLV25T-056J	T	68.5/79.4
L1715	6200002181	S.COI NLV25T-R12J	T	75.8/69.7
L1716	6200002611	S.COI NLV25T-R47J	T	79.3/69.7
L1717	6200002611	S.COI NLV25T-R47J	T	76.4/75.2
L1718	6200002611	S.COI NLV25T-R47J	T	75.0/84.1
L1719	6200002631	S.COI NLV25T-R10J	T	79.2/76.8
L1720	6200002421	S.COI NLV25T-068J	T	77.3/80.8
L1722	6200002431	S.COI NLV25T-082J	T	82.1/76.1
L1723	6200002421	S.COI NLV25T-068J	T	80.2/81.4
L1724	6200002181	S.COI NLV25T-R12J	T	83.8/72.9
L1725	6200002631	S.COI NLV25T-R10J	T	83.2/80.8
L1726	6200002431	S.COI NLV25T-082J	T	86.2/75.5
L1727	6200002421	S.COI NLV25T-068J	T	87.3/84.1
L1728	6200002631	S.COI NLV25T-R10J	T	87.8/71.9
L1729	6200002431	S.COI NLV25T-082J	T	90.6/83.1
L1730	6200002631	S.COI NLV25T-R10J	T	90.2/74.7
L1731	6200002431	S.COI NLV25T-082J	T	91.6/80.2
L1732	6200007790	S.COI LQW2BHN1R15J03L	T	94.6/79.7
L1733	6200002611	S.COI NLV25T-R47J	T	96.5/74.9
L1734	6200002611	S.COI NLV25T-R47J	T	99.7/81.7
L1735	6200002181	S.COI NLV25T-R12J	T	97.1/69.7
L1736	6200002611	S.COI NLV25T-R47J	T	93.6/69.7
L1737	6200002411	S.COI NLV25T-056J	T	99.5/73.3
L1802	6200003950	S.COI HF50ACC 322513-T	T	12.4/19.8
L1804	6200005011	S.COI NLV25T-100J	T	71.0/8.0
L1805	6140004680	S.COI LR-528 4KBL	T	112.4/98.3
L1806	6200002631	S.COI NLV25T-R10J	T	81.4/58.7
L1807	6200002631	S.COI NLV25T-R10J	T	107.9/61.3
L1808	6200005011	S.COI NLV25T-100J	B	138.5/90.9
L1809	6200010740	S.COI C2520C-R27G-A	T	143.9/100.0
L1810	6200005011	S.COI NLV25T-100J	B	143.3/98.3
L1811	6200005011	S.COI NLV25T-100J	T	97.5/93.7
L1812	6200010830	S.COI C2520C-3R3G-A	T	41.0/101.5
L1814	6200001851	S.COI NLV32T-5R6J	T	22.7/80.4
L1815	6200001851	S.COI NLV32T-5R6J	T	32.9/80.4
L1816	6200002911	S.COI NLV25T-R27J	B	85.5/94.7
L1817	6200002911	S.COI NLV25T-R27J	B	88.1/99.8
L1818	6200002041	S.COI NLV25T-101J	B	66.4/39.0
L1819	6200010830	S.COI C2520C-3R3G-A	T	20.1/97.1
L1820	6200011140	S.COI C1608CB-39NG-A	T	102.6/101.9
L1821	6200010730	S.COI C2520C-68NG-A	T	115.0/89.6
L1822	6200011410	S.COI C2520C-82NG-A	T	118.5/90.6
L1823	6200010730	S.COI C2520C-68NG-A	T	122.0/89.6
R1001	7030003320	S.RES ERJ3GEYJ 101 V (100)	B	9.1/108.0
R1100	7030008280	S.RES ERJ2GEJ 271 X (270)	T	4.5/84.9
R1101	7030008280	S.RES ERJ2GEJ 271 X (270)	T	4.5/83.8
R1102	7030010090	S.RES ERJ2GEJ 180 X (18)	T	5.7/84.3
R1103	7030005570	S.RES ERJ2GEJ 820 X (82)	T	14.0/43.5
R1105	7030007270	S.RES ERJ2GEJ 151 X (150)	T	3.5/53.5
R1106	7030003320	S.RES ERJ3GEYJ 101 V (100)	T	13.8/45.7
R1107	7030003380	S.RES ERJ3GEYJ 331 V (330)	T	14.4/72.1
R1108	7030005570	S.RES ERJ2GEJ 820 X (82)	T	13.8/48.3
R1110	7030005090	S.RES ERJ2GEJ 104 X (100K)	T	13.9/68.6
R1111	7030008180	S.RES ERJ12YJ331U (330)	B	7.4/52.8
R1112	7030003560	S.RES ERJ3GEYJ 103 V (10K)	T	9.5/52.8
R1113	7030003560	S.RES ERJ3GEYJ 103 V (10K)	T	6.4/55.2
R1114	7030003440	S.RES ERJ3GEYJ 102 V (1K)	T	9.5/54.0
R1115	7030003390	S.RES ERJ3GEYJ 391 V (390)	T	12.9/77.3
R1116	703000			

[MAIN UNIT]

REF NO.	PARTS NO.	DESCRIPTION	M.	H/V LOCATION
R1140	7030003320	S.RES ERJ3GEYJ 101 V (100)	T	36.6/77.0
R1141	7030003320	S.RES ERJ3GEYJ 101 V (100)	T	36.4/61.1
R1142	7030003320	S.RES ERJ3GEYJ 101 V (100)	T	36.3/53.1
R1143	7030003320	S.RES ERJ3GEYJ 101 V (100)	T	37.1/101.1
R1144	7030003400	S.RES ERJ3GEYJ 471 V (470)	T	37.3/40.4
R1145	7030003380	S.RES ERJ3GEYJ 331 V (330)	T	41.1/86.1
R1146	7030005220	S.RES ERJ2GEJ 223 X (22K)	T	112.6/85.9
R1147	7030003320	S.RES ERJ3GEYJ 101 V (100)	T	105.8/83.9
R1148	7030003280	S.RES ERJ3GEYJ 470 V (47)	T	45.5/89.2
R1149	7030003640	S.RES ERJ3GEYJ 473 V (47K)	T	113.7/72.2
R1150	7030003560	S.RES ERJ3GEYJ 103 V (10K)	T	115.0/85.8
R1152	7030003640	S.RES ERJ3GEYJ 473 V (47K)	T	115.4/75.2
R1153	7030003560	S.RES ERJ3GEYJ 103 V (10K)	T	64.8/89.5
R1154	7030003320	S.RES ERJ3GEYJ 101 V (100)	T	121.7/80.6
R1155	7030005310	S.RES ERJ2GEJ 124 X (120K)	T	113.7/73.4
R1156	7030003720	S.RES ERJ3GEYJ 224 V (220K)	T	115.0/84.5
R1157	7030005120	S.RES ERJ2GEJ 102 X (1K)	T	115.4/81.0
R1158	7030005090	S.RES ERJ2GEJ 104 X (100K)	T	123.7/72.4
R1159	7030003720	S.RES ERJ3GEYJ 224 V (220K)	T	126.4/72.0
R1160	7030005220	S.RES ERJ2GEJ 223 X (22K)	T	120.9/72.4
R1161	7030003370	S.RES ERJ3GEYJ 271 V (270)	T	66.1/86.6
R1162	7030003280	S.RES ERJ3GEYJ 470 V (47)	T	44.2/85.9
R1163	7030003280	S.RES ERJ3GEYJ 470 V (47)	T	45.8/104.0
R1164	7030003220	S.RES ERJ3GEYJ 150 V (15)	T	48.0/88.4
R1165	7030003220	S.RES ERJ3GEYJ 150 V (15)	T	47.9/104.0
R1166	7030003740	S.RES ERJ3GEYJ 334 V (330K)	T	116.8/80.7
R1167	7030003400	S.RES ERJ3GEYJ 471 V (470)	T	111.0/73.4
R1168	7030005050	S.RES ERJ2GEJ 103 X (10K)	T	125.7/73.5
R1169	7030003840	S.RES ERJ3GEYJ 225 V (2.2M)	T	112.3/83.3
R1170	7030003840	S.RES ERJ3GEYJ 225 V (2.2M)	T	123.7/73.6
R1171	7030003440	S.RES ERJ3GEYJ 102 V (1K)	T	49.4/94.3
R1172	7030003440	S.RES ERJ3GEYJ 102 V (1K)	T	49.7/107.5
R1173	7030003280	S.RES ERJ3GEYJ 470 V (47)	T	57.3/90.4
R1174	7030003490	S.RES ERJ3GEYJ 272 V (2.7K)	T	51.0/96.5
R1175	7030003280	S.RES ERJ3GEYJ 470 V (47)	T	57.4/104.1
R1176	7030003490	S.RES ERJ3GEYJ 272 V (2.7K)	T	51.7/109.6
R1177	7030003860	S.RES ERJ3GE JPW V	T	110.1/70.1
R1178	7030003380	S.RES ERJ3GEYJ 331 V (330)	T	109.6/83.3
R1179	7030003400	S.RES ERJ3GEYJ 471 V (470)	T	121.6/74.4
R1180	7030003440	S.RES ERJ3GEYJ 102 V (1K)	T	106.2/72.2
R1181	7030003440	S.RES ERJ3GEYJ 102 V (1K)	T	118.5/75.0
R1182	7030005090	S.RES ERJ2GEJ 104 X (100K)	T	116.9/74.0
R1183	7030003560	S.RES ERJ3GEYJ 103 V (10K)	T	105.0/72.2
R1185	7030003280	S.RES ERJ3GEYJ 470 V (47)	T	69.4/96.6
R1186	7030003560	S.RES ERJ3GEYJ 103 V (10K)	T	120.4/77.7
R1187	7030003380	S.RES ERJ3GEYJ 331 V (330)	T	70.5/85.9
R1188	7030008310	S.RES ERJ2GEJ 564 X (560K)	T	127.2/77.5
R1189	7030005170	S.RES ERJ2GEJ 474 X (470K)	T	127.2/80.3
R1190	7030003840	S.RES ERJ3GEYJ 225 V (2.2M)	T	124.4/83.1
R1191	7030003500	S.RES ERJ3GEYJ 332 V (3.3K)	T	121.7/83.1
R1192	7030003520	S.RES ERJ3GEYJ 472 V (4.7K)	T	121.7/84.4
R1193	7030003740	S.RES ERJ3GEYJ 334 V (330K)	T	126.4/70.8
R1194	7030003750	S.RES ERJ3GEYJ 394 V (390K)	T	123.7/70.8
R1197	7030004980	S.RES ERJ2GEJ 101 X (100)	T	110.0/29.6
R1198	7030004980	S.RES ERJ2GEJ 101 X (100)	T	100.4/31.2
R1199	7030004980	S.RES ERJ2GEJ 101 X (100)	T	109.1/32.0
R1200	7030004980	S.RES ERJ2GEJ 101 X (100)	T	98.4/30.3
R1201	7030003860	S.RES ERJ3GE JPW V	T	108.1/73.9
R1401	7030005120	S.RES ERJ2GEJ 102 X (1K)	T	81.0/102.3
R1402	7030005000	S.RES ERJ2GEJ 471 X (470)	T	82.8/102.8
R1403	7030007300	S.RES ERJ2GEJ 332 X (3.3K)	T	87.1/99.0
R1404	7030005040	S.RES ERJ2GEJ 472 X (4.7K)	T	88.0/97.8
R1405	7030003400	S.RES ERJ3GEYJ 471 V (470)	T	120.0/100.7
R1406	7030003400	S.RES ERJ3GEYJ 471 V (470)	T	120.0/93.5
R1407	7030003400	S.RES ERJ3GEYJ 471 V (470)	T	120.0/101.9
R1408	7030003400	S.RES ERJ3GEYJ 471 V (470)	T	120.0/97.1
R1409	7030005120	S.RES ERJ2GEJ 102 X (1K)	T	88.9/97.8
R1410	7030007270	S.RES ERJ2GEJ 151 X (150)	T	95.2/102.6
R1411	7310004650	S.TRI EVM-2WSX80 B53 (502)	T	124.4/104.5
R1412	7310004650	S.TRI EVM-2WSX80 B53 (502)	T	127.8/104.5
R1413	7030003360	S.RES ERJ3GEYJ 221 V (220)	T	89.0/101.1
R1414	7030003360	S.RES ERJ3GEYJ 221 V (220)	T	126.9/94.6
R1416	7030003360	S.RES ERJ3GEYJ 221 V (220)	T	125.2/94.6
R1417	7030010040	S.RES ERJ2GEJ-JPW	T	111.6/89.1
R1418	7030010040	S.RES ERJ2GEJ-JPW	T	112.8/88.6
R1419	7030003440	S.RES ERJ3GEYJ 102 V (1K)	T	112.8/90.8
R1420	7030005120	S.RES ERJ2GEJ 102 X (1K)	T	104.4/98.8
R1422	7030009270	S.RES ERJ2GEJ 821 X (820)	T	102.7/98.1
R1423	7030005580	S.RES ERJ2GEJ 560 X (56)	T	102.2/96.9
R1424	7030005120	S.RES ERJ2GEJ 102 X (1K)	T	106.4/88.6
R1426	7030003440	S.RES ERJ3GEYJ 102 V (1K)	T	142.6/95.4
R1427	7030003280	S.RES ERJ3GEYJ 470 V (47)	T	80.5/106.4
R1428	7030004980	S.RES ERJ2GEJ 101 X (100)	T	128.0/112.3
R1429	7030007290	S.RES ERJ2GEJ 222 X (2.2K)	T	126.5/107.6
R1430	7030003280	S.RES ERJ3GEYJ 470 V (47)	T	140.2/95.4
R1431	7030003280	S.RES ERJ3GEYJ 470 V (47)	T	136.2/88.9
R1432	7030004040	S.RES ERJ3GEYJ 471 V (4.7)	T	98.4/88.7
R1433	7030007260	S.RES ERJ2GEJ 330 X (33)	T	131.4/105.7
R1434	7030010040	S.RES ERJ2GEJ-JPW	T	97.1/87.6
R1435	7030005580	S.RES ERJ2GEJ 560 X (56)	T	103.1/96.9
R1436	7030005220	S.RES ERJ2GEJ 223 X (22K)	T	130.0/110.9
R1437	7030005050	S.RES ERJ2GEJ 103 X (10K)	T	132.3/105.7
R1438	7030005010	S.RES ERJ2GEJ 681 X (680)	T	91.5/91.9
R1439	7510001541	S.THE NTCG16 4BH 332JT	B	131.3/108.0
R1440	7030005120	S.RES ERJ2GEJ 102 X (1K)	T	131.7/107.6
R1441	7030007270	S.RES ERJ2GEJ 151 X (150)	T	128.6/111.4
R1442	7030007300	S.RES ERJ2GEJ 332 X (3.3K)	T	128.6/110.5
R1443	7030007280	S.RES ERJ2GEJ 331 X (330)	T	90.1/89.0
R1444	7030007570	S.RES ERJ2GEJ 122 X (1.2K)	T	91.0/90.7
R1445	7030005000	S.RES ERJ2GEJ 471 X (470)	T	134.3/109.4
R1447	7030003860	S.RES ERJ3GE JPW V	T	121.1/18.0
R1448	7030003440	S.RES ERJ3GEYJ 102 V (1K)	T	141.8/68.1
R1449	7030003280	S.RES ERJ3GEYJ 470 V (47)	T	115.3/21.3
R1450	7030003400	S.RES ERJ3GEYJ 471 V (470)	T	121.1/19.3
R1451	7030003610	S.RES ERJ3GEYJ 273 V (27K)	T	116.6/21.3

Eqv.= This component is equivalent to the REF No. component listed above, and may be substituted on parts orders and repairs.

[MAIN UNIT]

REF NO.	PARTS NO.	DESCRIPTION	M.	H/V LOCATION
R1452	7030003640	S.RES ERJ3GEYJ 473 V (47K)	T	115.8/19.3
R1453	7030003440	S.RES ERJ3GEYJ 102 V (10K)	T	129.0/69.2
R1454	7030003530	S.RES ERJ3GEYJ 562 V (5.6K)	T	141.8/64.0
R1455	7030003320	S.RES ERJ3GEYJ 101 V (100)	T	114.9/12.0
R1456	7030003400	S.RES ERJ3GEYJ 471 V (470)	T	112.4/42.0
R1457	7030005090	S.RES ERJ2GEJ 104 X (100K)	T	135.8/60.0
R1458	7030003860	S.RES ERJ3GE JPW V	T	132.6/57.3
R1459	7030003440	S.RES ERJ3GEYJ 102 V (1K)	T	128.2/66.6
R1460	7030003560	S.RES ERJ3GEYJ 103 V (10K)	T	126.2/18.7
R1461	7030007260	S.RES ERJ2GEJ 330 X (33)	T	117.1/8.9
R1462	7030003640	S.RES ERJ3GEYJ 473 V (47K)	T	133.9/52.2
R1463	7030007290	S.RES ERJ2GEJ 222 X (2.2K)	T	131.4/57.3
R1464	7030005040	S.RES ERJ2GEJ 472 X (4.7K)	T	116.8/12.7
R1465	7030005120	S.RES ERJ2GEJ 102 X (1K)	T	128.7/56.5
R1466	7030003560	S.RES ERJ3GEYJ 103 V (10K)	T	127.0/20.7
R1467	7030007260	S.RES ERJ2GEJ 330 X (33)	T	138.0/56.3
R1468	7030003400	S.RES ERJ3GEYJ 471 V (470)	T	121.0/14.2
R1469	7030005090	S.RES ERJ2GEJ 104 X (100K)	T	140.8/52.3
R1470	7030003520	S.RES ERJ3GEYJ 562 V (5.6K)	T	122.3/17.0
R1471	7510001541	S.THE NTCG16 4BH 332JT	T	126.8/6.2
R1472	7510001541	S.THE NTCG16 4BH 332JT	T	123.9/8.7
R1473	7030007290	S.RES ERJ2GEJ 222 X (2.2K)	T	123.9/7.5
R1474	7030003280	S.RES ERJ3GEYJ 470 V (47)	B	128.4/52.9
R1475	7030003560	S.RES ERJ3GEYJ 103 V (10K)	T	138.3/51.4
R1476	7030003320	S.RES ERJ3GEYJ 101 V (100)	T	126.8/7.5
R1477	7030007290	S.RES ERJ2GEJ 222 X (2.2K)	T	123.9/10.0
R1478	7030003440	S.RES ERJ3GEYJ 102 V (1K)	T	130.2/41.0
R1479	7030003320	S.RES ERJ3GEYJ 101 V (100)	T	142.1/48.1
R1480	7030003280	S.RES ERJ3GEYJ 470 V (47)	T	127.5/10.2
R1481	7510001541	S.THE NTCG16 4BH 332JT	T	134.3/9.8
R1482	7030003520	S.RES ERJ3GEYJ 472 V (4.7K)	T	134.3/7.3
R1483	7030003320	S.RES ERJ3GEYJ 101 V (100)	T	134.3/11.0
R1484	7030003440	S.RES ERJ3GEYJ 102 V (1K)	T	142.1/45.1
R1485	7030003320	S.RES ERJ3GEYJ 101 V (100)	T	123.8/33.8
R1486	7030003520	S.RES ERJ3GEYJ 472 V (4.7K)	T	128.1/14.3
R1487	7030003670	S.RES ERJ3GEYJ 823 V (82K)	T	134.3/15.7
R1488	7030003440	S.RES ERJ3GEYJ 102 V (1K)	B	130.2/45.8
R1489	7030003620	S.RES ERJ3GEYJ 333 V (33K)	T	134.3/14.3
R1490	7030003440	S.RES ERJ3GEYJ 102 V (1K)	T	135.5/38.3
R1491	7030004990	S.RES ERJ2GEJ 221 X (220)	T	123.6/28.7
R1492	7030003520	S.RES ERJ3GEYJ 472 V (4.7K)	T	116.7/46.9
R1493	7030003520	S.RES ERJ3GEYJ 472 V (4.7K)	T	115.9/44.6
R1494	7030005070	S.RES ERJ2GEJ 683 X (68K)	T	126.7/26.6
R1495	7030003520	S.RES ERJ3GEYJ 472 V (4.7K)	T	135.5/35.6
R1496	7030003610	S.RES ERJ3GEYJ 273 V (27K)	T	124.3/26.6
R1497	7030003520	S.RES ERJ3GEYJ 472 V (4.7K)	T	140.5/32.3
R1498	7030007290	S.RES ERJ2GEJ 222 X (2.2K)	T	132.6/29.5
R1499	7030003560	S.RES ERJ3GEYJ 103 V (10K)	T	130.6/30.0
R1500	7030003520	S.RES ERJ3GEYJ 472 V (4.7K)	T	125.8/25.4
R1501	7510001671	S.THR NTCG16 4BH 103JT	T	125.8/21.2
R1502	7030007290	S.RES ERJ2GEJ 222 X (2.2K)	T	122.8/48.4
R1503	7030008400	S.RES ERJ2GEJ 182 X (1.8K)	T	128.5/24.2
R1504	7030003520	S.RES ERJ3GEYJ 472 V (4.7K)	T	141.0/23.3
R1505	7030003520	S.RES ERJ3GEYJ 472 V (4.7K)	T	145.4/21.9
R1506	7030003520	S.RES ERJ3GEYJ 472 V (4.7K)	T	128.6/15.7
R1507	7030003520	S.RES ERJ3GEYJ 472 V (4.7K)	T	143.9/20.7
R1508	7030007290	S.RES ERJ2GEJ 222 X (2.2K)	T	116.6/41.6
R1509	7030003280	S.RES ERJ3GEYJ 470 V (47)	T	134.7/24.4
R1510	7030003560	S.RES ERJ3GEYJ 103 V (10K)	T	138.3/20.7
R1511	7030003400	S.RES ERJ3GEYJ 471 V (470)	T	138.9/18.2
R1512	7030003440	S.RES ERJ3GEYJ 471 V (470)	B	121.1/38.7
R1513	7030003600	S.RES ERJ3GEYJ 473 V (47K)	T	139.1/14.7
R1514	7030005220	S.RES ERJ2GEJ 223 X (22K)	T	136.7/15.0
R1515	7030007340	S.RES ERJ2GEJ 153 X (15K)	T	114.2/43.9
R1516	7030003560	S.RES ERJ3GEYJ 103 V (10K)	T	113.1/44.2
R1517	7030003860	S.RES ERJ3GE JPW V	T	140.3/14.7
R1518	7030003560	S.RES ERJ3GEYJ 103 V (10K)	T	145.0/17.6
R1519	7030005090	S.RES ERJ2GEJ 104 X (100K)	T	102.8/51.3
R1520	7030003400	S.RES ERJ3GEYJ 471 V (470)	T	142.2/14.7
R1521				

[MAIN UNIT]

REF NO.	PARTS NO.	DESCRIPTION	M.	H/V LOCATION
R1702	7030005120	S.RES ERJ2GEJ 102 X (1K)	T	99.5/32.1
R1705	7030005120	S.RES ERJ2GEJ 102 X (1K)	T	73.6/13.8
R1707	7030005240	S.RES ERJ2GEJ 473 X (47K)	T	54.3/48.4
R1708	7030005240	S.RES ERJ2GEJ 473 X (47K)	T	54.3/47.5
R1709	7030005710	S.RES ERJ2GEJ 121 X (120)	T	48.9/50.3
R1710	7030005710	S.RES ERJ2GEJ 121 X (120)	T	45.7/50.3
R1712	7030007250	S.RES ERJ2GEJ 220 X (22)	T	54.7/51.0
R1713	7030007250	S.RES ERJ2GEJ 220 X (22)	T	53.8/51.0
R1714	7030003370	S.RES ERJ3GEYJ 271 V (270)	T	49.8/60.9
R1716	7030003400	S.RES ERJ3GEYJ 471 V (470)	T	48.6/64.3
R1717	7030005120	S.RES ERJ2GEJ 102 X (1K)	T	47.6/34.5
R1718	7030005120	S.RES ERJ2GEJ 102 X (1K)	T	46.7/34.5
R1719	7030005120	S.RES ERJ2GEJ 102 X (1K)	T	45.8/34.5
R1720	7030008400	S.RES ERJ2GEJ 182 X (1.8K)	T	43.9/45.7
R1721	7030008400	S.RES ERJ2GEJ 182 X (1.8K)	T	43.9/46.8
R1722	7030005120	S.RES ERJ2GEJ 102 X (1K)	T	42.0/36.3
R1723	7030005050	S.RES ERJ2GEJ 103 X (10K)	T	42.0/38.0
R1724	7030003220	S.RES ERJ3GEYJ 150 V (15)	T	58.0/77.0
R1725	7030003380	S.RES ERJ3GEYJ 331 V (330)	T	57.2/79.0
R1726	7030003380	S.RES ERJ3GEYJ 331 V (330)	T	58.7/79.0
R1730	7030003390	S.RES ERJ3GEYJ 391 V (390)	T	82.4/69.7
R1731	7030003390	S.RES ERJ3GEYJ 391 V (390)	T	74.5/75.5
R1732	7030003390	S.RES ERJ3GEYJ 391 V (390)	T	74.0/81.5
R1733	7030003860	S.RES ERJ3GE JPW V	T	93.8/76.0
R1735	7030003860	S.RES ERJ3GE JPW V	T	97.0/82.8
R1739	7030003390	S.RES ERJ3GEYJ 391 V (390)	T	95.8/71.9
R1740	7030003390	S.RES ERJ3GEYJ 391 V (390)	T	100.4/79.2
R1741	7030003390	S.RES ERJ3GEYJ 391 V (390)	T	90.5/69.7
R1742	7030005090	S.RES ERJ2GEJ 104 X (100K)	T	74.8/92.8
R1743	7030005090	S.RES ERJ2GEJ 104 X (100K)	T	77.4/92.8
R1801	7030005950	S.RES RR0510P-123-D (12K)	T	15.8/19.4
R1802	7030006010	S.RES RR0510P-472-D (4.7K)	T	15.4/18.2
R1803	7030005040	S.RES ERJ2GEJ 472 X (4.7K)	T	25.3/21.5
R1805	7030007290	S.RES ERJ2GEJ 222 X (2.2K)	T	27.2/21.9
R1806	7030005120	S.RES ERJ2GEJ 102 X (1K)	T	63.2/24.3
R1807	7030005120	S.RES ERJ2GEJ 102 X (1K)	T	34.6/23.4
R1808	7030005240	S.RES ERJ2GEJ 473 X (47K)	T	19.9/20.3
R1809	7030005120	S.RES ERJ2GEJ 102 X (1K)	T	7.3/29.4
R1811	7030005120	S.RES ERJ2GEJ 102 X (1K)	T	8.3/29.4
R1812	7030005120	S.RES ERJ2GEJ 102 X (1K)	T	8.7/23.4
R1813	7030005120	S.RES ERJ2GEJ 102 X (1K)	T	7.8/23.4
R1814	7030005240	S.RES ERJ2GEJ 473 X (47K)	T	29.0/20.9
R1815	7030008190	S.RES ERJ12YJ330U (33)	T	109.3/5.2
R1817	7030005050	S.RES ERJ2GEJ 103 X (10K)	T	25.3/22.4
R1818	7030005090	S.RES ERJ2GEJ 104 X (100K)	T	25.3/10.9
R1819	7030005240	S.RES ERJ2GEJ 473 X (47K)	T	10.9/17.8
R1820	7030005240	S.RES ERJ2GEJ 473 X (47K)	T	9.5/21.6
R1821	7030007340	S.RES ERJ2GEJ 153 X (15K)	T	29.9/20.0
R1822	7030005040	S.RES ERJ2GEJ 472 X (4.7K)	T	19.9/22.5
R1823	7030005120	S.RES ERJ2GEJ 102 X (1K)	T	67.0/30.8
R1824	7030004990	S.RES ERJ2GEJ 221 X (220)	T	12.1/31.7
R1825	7030010040	S.RES ERJ2GEJ-JPW	T	82.1/40.6
R1826	7030010040	S.RES ERJ2GEJ-JPW	T	76.2/40.5
R1827	7030010040	S.RES ERJ2GEJ-JPW	T	66.1/47.7
R1830	7030005120	S.RES ERJ2GEJ 102 X (1K)	T	14.6/99.1
R1831	7030005120	S.RES ERJ2GEJ 102 X (1K)	T	15.5/97.1
R1832	7030005120	S.RES ERJ2GEJ 102 X (1K)	T	15.2/21.2
R1834	7030005120	S.RES ERJ2GEJ 102 X (1K)	T	89.4/14.3
R1836	7030005120	S.RES ERJ2GEJ 102 X (1K)	T	4.3/29.6
R1837	7030005220	S.RES ERJ2GEJ 223 X (22K)	T	28.1/21.9
R1838	7030005240	S.RES ERJ2GEJ 473 X (47K)	T	59.2/21.4
R1840	7030005240	S.RES ERJ2GEJ 473 X (47K)	T	67.5/23.7
R1841	7030005240	S.RES ERJ2GEJ 473 X (47K)	T	68.7/30.0
R1847	7030005160	S.RES ERJ2GEJ 105 X (1M)	T	67.7/6.3
R1848	7030005240	S.RES ERJ2GEJ 473 X (47K)	T	53.6/29.4
R1849	7030005090	S.RES ERJ2GEJ 104 X (100K)	T	57.4/31.6
R1850	7030005240	S.RES ERJ2GEJ 473 X (47K)	T	76.2/38.7
R1851	7030005120	S.RES ERJ2GEJ 102 X (1K)	T	72.8/34.3
R1852	7030005240	S.RES ERJ2GEJ 473 X (47K)	T	82.1/38.8
R1853	7030005050	S.RES ERJ2GEJ 103 X (10K)	T	68.9/29.1
R1856	7030005720	S.RES ERJ2GEJ 563 X (56K)	T	58.6/27.4
R1857	7030005720	S.RES ERJ2GEJ 563 X (56K)	T	58.2/26.2
R1858	7030005090	S.RES ERJ2GEJ 104 X (100K)	T	59.2/30.7
R1863	7030005090	S.RES ERJ2GEJ 104 X (100K)	T	63.7/28.4
R1864	7030005120	S.RES ERJ2GEJ 102 X (1K)	T	64.6/28.7
R1866	7030005170	S.RES ERJ2GEJ 474 X (470K)	T	64.2/25.5
R1867	7030005110	S.RES ERJ2GEJ 224 X (220K)	T	65.5/25.5
R1868	7030005110	S.RES ERJ2GEJ 224 X (220K)	T	67.1/25.1
R1869	7030005240	S.RES ERJ2GEJ 473 X (47K)	T	57.4/21.6
R1870	7030005050	S.RES ERJ2GEJ 103 X (10K)	T	52.8/2.4
R1871	7030005050	S.RES ERJ2GEJ 103 X (10K)	T	54.4/2.7
R1872	7030007290	S.RES ERJ2GEJ 222 X (2.2K)	T	90.3/13.8
R1875	7030003720	S.RES ERJ3GEYJ 224 V (220K)	B	24.2/12.6
R1876	7030003720	S.RES ERJ3GEYJ 224 V (220K)	B	32.3/10.9
R1877	7030003720	S.RES ERJ3GEYJ 224 V (220K)	B	24.2/14.4
R1878	7030003720	S.RES ERJ3GEYJ 224 V (220K)	B	31.1/12.8
R1879	7030003720	S.RES ERJ3GEYJ 224 V (220K)	B	24.2/16.2
R1880	7030003720	S.RES ERJ3GEYJ 224 V (220K)	B	31.1/14.4
R1881	7030003720	S.RES ERJ3GEYJ 224 V (220K)	B	24.2/18.5
R1882	7030003720	S.RES ERJ3GEYJ 224 V (220K)	B	30.7/21.8
R1883	7030003720	S.RES ERJ3GEYJ 224 V (220K)	B	52.9/23.7
R1884	7030003720	S.RES ERJ3GEYJ 224 V (220K)	B	52.9/25.3
R1885	7030003720	S.RES ERJ3GEYJ 224 V (220K)	B	44.0/22.4
R1886	7030003720	S.RES ERJ3GEYJ 224 V (220K)	B	51.1/12.4
R1887	7030003720	S.RES ERJ3GEYJ 224 V (220K)	B	44.0/14.4
R1888	7030003720	S.RES ERJ3GEYJ 224 V (220K)	B	44.0/16.2
R1889	7030003720	S.RES ERJ3GEYJ 224 V (220K)	B	51.1/10.8
R1890	7030003720	S.RES ERJ3GEYJ 224 V (220K)	B	51.1/13.9
R1891	7030003720	S.RES ERJ3GEYJ 224 V (220K)	B	44.0/10.8
R1892	7030003720	S.RES ERJ3GEYJ 224 V (220K)	B	24.2/10.9
R1893	7030003720	S.RES ERJ3GEYJ 224 V (220K)	B	48.9/8.9
R1894	7030003720	S.RES ERJ3GEYJ 224 V (220K)	B	44.0/12.6
R1895	7030003720	S.RES ERJ3GEYJ 224 V (220K)	B	44.0/18.0
R1896	7030003720	S.RES ERJ3GEYJ 224 V (220K)	B	51.1/15.5
R1897	7030003720	S.RES ERJ3GEYJ 224 V (220K)	B	44.0/19.8

Eqv.= This component is equivalent to the REF No. component listed above, and may be substituted on parts orders and repairs.

[MAIN UNIT]

REF NO.	PARTS NO.	DESCRIPTION	M.	H/V LOCATION
R1898	7030003720	S.RES ERJ3GEYJ 224 V (220K)	B	49.6/20.1
R1899	7030003720	S.RES ERJ3GEYJ 224 V (220K)	B	30.7/20.1
R1900	7030003720	S.RES ERJ3GEYJ 224 V (220K)	B	31.1/17.9
R1901	7030003720	S.RES ERJ3GEYJ 224 V (220K)	B	24.5/20.3
R1905	7030003640	S.RES ERJ3GEYJ 473 V (47K)	B	54.3/20.3
R1906	7030003640	S.RES ERJ3GEYJ 473 V (47K)	B	54.9/17.3
R1908	7030005240	S.RES ERJ2GEJ 473 X (47K)	T	54.2/24.3
R1909	7030005070	S.RES ERJ2GEJ 683 X (68K)	T	87.1/33.7
R1910	7030005070	S.RES ERJ2GEJ 683 X (68K)	T	88.0/33.7
R1911	7030005050	S.RES ERJ2GEJ 103 X (10K)	T	77.8/32.9
R1912	7030005050	S.RES ERJ2GEJ 103 X (10K)	T	77.8/33.9
R1913	7030008010	S.RES ERJ2GEJ 123 X (12K)	T	88.0/32.0
R1914	7030005090	S.RES ERJ2GEJ 104 X (100K)	T	87.1/32.0
R1915	7030004990	S.RES ERJ2GEJ 221 X (220)	T	80.2/23.7
R1917	7030004990	S.RES ERJ2GEJ 221 X (220)	T	80.4/22.6
R1918	7030004990	S.RES ERJ2GEJ 221 X (220)	T	84.0/26.5
R1919	7030004990	S.RES ERJ2GEJ 221 X (220)	T	80.2/25.6
R1920	7030004990	S.RES ERJ2GEJ 221 X (220)	T	80.2/24.6
R1921	7030004990	S.RES ERJ2GEJ 221 X (220)	T	80.2/27.0
R1922	7030005240	S.RES ERJ2GEJ 473 X (47K)	T	78.7/17.0
R1923	7030008310	S.RES ERJ2GEJ 564 X (560K)	T	77.8/35.0
R1924	7030005240	S.RES ERJ2GEJ 473 X (47K)	T	80.4/29.5
R1925	7030008310	S.RES ERJ2GEJ 564 X (560K)	T	79.6/36.5
R1926	7030005000	S.RES ERJ2GEJ 471 X (470)	T	88.9/32.0
R1927	7030005240	S.RES ERJ2GEJ 473 X (47K)	T	74.5/34.9
R1928	7030005240	S.RES ERJ2GEJ 473 X (47K)	T	55.1/24.3
R1929	7030005240	S.RES ERJ2GEJ 473 X (47K)	T	70.6/21.9
R1930	7030005240	S.RES ERJ2GEJ 473 X (47K)	T	84.0/27.2
R1931	7030005040	S.RES ERJ2GEJ 472 X (4.7K)	T	82.0/35.5
R1932	7030003860	S.RES ERJ3GE JPW V	T	84.9/35.8
R1934	7030005240	S.RES ERJ2GEJ 473 X (47K)	T	82.3/25.6
R1935	7030005240	S.RES ERJ2GEJ 473 X (47K)	T	82.3/24.6
R1936	7030005240	S.RES ERJ2GEJ 473 X (47K)	T	82.3/27.2
R1939	7030005240	S.RES ERJ2GEJ 473 X (47K)	T	81.3/29.5
R1940	7030005240	S.RES ERJ2GEJ 473 X (47K)	T	57.0/2.7
R1941	7030005240	S.RES ERJ2GEJ 473 X (47K)	T	60.9/1.8
R1942	7030005240	S.RES ERJ2GEJ 473 X (47K)	T	78.4/14.8
R1943	7030004990	S.RES ERJ2GEJ 221 X (220)	T	1.3/11.8
R1944	7030005240	S.RES ERJ2GEJ 473 X (47K)	T	6.4/31.7
R1947	7030005240	S.RES ERJ2GEJ 473 X (47K)	T	51.0/2.4
R1949	7030003860	S.RES ERJ3GE JPW V	T	73.9/32.0
R1950	7030005240	S.RES ERJ2GEJ 473 X (47K)	T	82.3/23.7
R1957	7030005000	S.RES ERJ2GEJ 471 X (470)	T	72.5/44.9
R1958	7030007290	S.RES ERJ2GEJ 222 X (2.2K)	T	74.9/50.2
R1959	7030005040	S.RES ERJ2GEJ 472 X (4.7K)	T	73.7/51.1
R1963	7030003280	S.RES ERJ3GEYJ 470 V (47K)	B	27.8/101.0
R1964	7030003300	S.RES ERJ3GEYJ 680 V (68K)	T	23.9/40.9
R1966	7030005240	S.RES ERJ2GEJ 473 X (47K)	T	16.2/21.9
R1968	7030005120	S.RES ERJ2GEJ 102 X (1K)	T	69.0/21.9
R1969	7030005240	S.RES ERJ2GEJ 473 X (47K)	T	19.2/19.1
R1971	7030004980	S.RES ERJ2GEJ 101 X (100)	T	46.1/76.6
R1972	7030005240	S.RES ERJ2GEJ 473 X (47K)	T	26.6/18.9
R1973	7030003220	S.RES ERJ3GEYJ 150 V (15)	B	140.6/95.5
R1974	7030003250	S.RES ERJ3GEYJ 270 V (27)	B	140.6/92.9
R1975	7030003200	S.RES ERJ3GEYJ 100 V (10)	B	141.5/88.3
R1976	7030003420	S.RES ERJ3GEYJ 681 V (680)	B	146.9/90.7
R1977	7030003480	S.RES ERJ3GEYJ 222 V (2.2K)	B	146.9/93.4
R1978	7030003400	S.RES ERJ3GEYJ 471 V (470)	B	146.0/102.5
R1979	7030003860	S.RES ERJ3GE JPW V	B	144.0/103.2
R1981	7030005090	S.RES ERJ2GEJ 104 X (100K)	T	5.9/38.6
R1982	7030005050	S.RES ERJ2GEJ 103 X (10K)	T	2.9/38.6
R1983	7030003380	S.RES ERJ3GEYJ 331 V (330)	T	14.4/70.9
R1984	7030003400	S.RES ERJ3GEYJ 471 V (470)	T	38.5/40.4
R1985	7030005050	S.RES ERJ2GEJ 103 X (10K)	T	4.3/38.3
R1991	7030005110	S.RES ERJ2GEJ 224 X (220K)	T	26.4/17.6
R1993	7030003860	S.RES ERJ3GE JPW V	B	131.2/102.9
R1995	7030010040	S.RES ERJ2GEJ-JPW	T	63.2/21.3
R1997	7030005010	S.RES ERJ2GEJ 681 X (680)	T	9.3/69.6
R1998	7030003560	S.RES ERJ3GEYJ 103 V (10K)	B	65.0/10.2
R2002	7030003560	S.RES ERJ3GEYJ 103 V (10K)	B	71.3/51.6
R2003	7030003860	S.RES ERJ3GE JPW V	B	64.9/45.1
R2004	7030003640	S.RES ERJ3GEYJ 473 V (47K)	B	64.9/47.0
R2019	7030005050			

[MAIN UNIT]

REF NO.	PARTS NO.	DESCRIPTION	M.	H/V LOCATION
C1103	4030018980	S.CER C1608 JB 1H 104K-T	T	3.4/50.3
C1104	4030018980	S.CER C1608 JB 1H 104K-T	T	7.0/82.1
C1105	4030018980	S.CER C1608 JB 1H 104K-T	T	12.4/81.4
C1106	4030018980	S.CER C1608 JB 1H 104K-T	T	9.6/50.3
C1107	4030018600	S.CER C1608 CH 1H 152J-T	T	8.6/63.9
C1108	4030018590	S.CER C1608 CH 1H 122J-T	T	9.8/63.9
C1109	4030006880	S.CER C1608 JB 1H 472K-T	T	6.4/54.0
C1110	4030018980	S.CER C1608 JB 1H 104K-T	T	13.3/64.5
C1111	4030018980	S.CER C1608 JB 1H 104K-T	T	1.4/37.8
C1112	4030007130	S.CER C1608 CH 1H 101J-T	T	12.4/83.0
C1113	4030019990	S.CER C1005 JB 1C 104K-T	T	8.1/61.6
C1114	4030018980	S.CER C1608 JB 1H 104K-T	T	9.4/78.2
C1115	4030006880	S.CER C1608 JB 1H 472K-T	T	6.4/52.8
C1116	4030018980	S.CER C1608 JB 1H 104K-T	T	13.3/59.3
C1117	4030017760	S.CER C1005 JB 1H 222K-T	T	9.0/61.6
C1118	4030017760	S.CER C1005 JB 1H 222K-T	T	9.9/61.6
C1119	4030018600	S.CER C1608 CH 1H 152J-T	T	11.0/62.3
C1120	4030007130	S.CER C1608 CH 1H 101J-T	T	8.6/75.1
C1121	4030018980	S.CER C1608 JB 1H 104K-T	T	12.1/72.5
C1122	4030018980	S.CER C1608 JB 1H 104K-T	T	9.3/70.7
C1123	4030018980	S.CER C1608 JB 1H 104K-T	T	9.4/73.2
C1124	4510009700	S.ELE EEEFK1C101P	T	17.2/102.3
C1125	4030018980	S.CER C1608 JB 1H 104K-T	T	22.1/93.0
C1126	4030018980	S.CER C1608 JB 1H 104K-T	T	22.1/85.0
C1127	4030018980	S.CER C1608 JB 1H 104K-T	T	21.6/68.9
C1128	4030018980	S.CER C1608 JB 1H 104K-T	T	21.6/77.0
C1129	4030018980	S.CER C1608 JB 1H 104K-T	T	21.8/61.1
C1130	4030018980	S.CER C1608 JB 1H 104K-T	T	21.5/53.1
C1131	4030018980	S.CER C1608 JB 1H 104K-T	T	24.5/101.8
C1132	4030018980	S.CER C1608 JB 1H 104K-T	T	18.9/45.4
C1133	4030017810	S.CER C1608 CH 1H 102J-T	T	20.7/91.1
C1134	4030018580	S.CER C1608 CH 1H 821J-T	T	20.7/83.1
C1135	4030010760	S.CER C1608 CH 1H 331J-T	T	21.9/67.0
C1136	4030011280	S.CER C1608 CH 1H 271J-T	T	20.7/75.1
C1137	4030007160	S.CER C1608 CH 1H 181J-T	T	20.7/59.2
C1138	4030007130	S.CER C1608 CH 1H 101J-T	T	20.6/51.2
C1139	4030007130	S.CER C1608 CH 1H 101J-T	T	26.0/99.2
C1140	4030007170	S.CER C1608 CH 1H 221J-T	T	22.0/91.1
C1142	4030007150	S.CER C1608 CH 1H 151J-T	T	20.7/67.0
C1143	4030007110	S.CER C1608 CH 1H 680J-T	T	21.9/75.1
C1144	4030007090	S.CER C1608 CH 1H 470J-T	T	21.9/59.2
C1145	4030007090	S.CER C1608 CH 1H 470J-T	T	21.8/51.2
C1146	4030008560	S.CER C1608 CH 1H 300J-T	T	27.2/99.2
C1147	4030018980	S.CER C1608 JB 1H 104K-T	T	21.7/39.7
C1148	4030010760	S.CER C1608 CH 1H 331J-T	T	23.2/91.1
C1150	4030007150	S.CER C1608 CH 1H 151J-T	T	23.1/67.0
C1151	4030007130	S.CER C1608 CH 1H 101J-T	T	23.1/75.1
C1152	4030007110	S.CER C1608 CH 1H 680J-T	T	23.1/59.2
C1153	4030007070	S.CER C1608 CH 1H 330J-T	T	24.2/51.2
C1154	4030007050	S.CER C1608 CH 1H 220J-T	T	25.8/101.8
C1155	4030007150	S.CER C1608 CH 1H 151J-T	T	24.5/91.1
C1157	4030007060	S.CER C1608 CH 1H 270J-T	T	24.3/67.0
C1158	4030007010	S.CER C1608 CH 1H 100D-T	T	24.3/75.1
C1159	4030007030	S.CER C1608 CH 1H 150J-T	T	24.3/59.2
C1160	4030007050	S.CER C1608 CH 1H 220J-T	T	23.0/51.2
C1161	4030007020	S.CER C1608 CH 1H 120J-T	T	27.0/101.8
C1162	4030007170	S.CER C1608 CH 1H 221J-T	T	26.5/88.9
C1163	4030007170	S.CER C1608 CH 1H 221J-T	T	26.5/87.6
C1166	4030007140	S.CER C1608 CH 1H 121J-T	T	26.5/64.7
C1167	4030007060	S.CER C1608 CH 1H 270J-T	T	26.5/63.5
C1168	4030007110	S.CER C1608 CH 1H 680J-T	T	26.5/72.8
C1169	4030007090	S.CER C1608 CH 1H 470J-T	T	26.5/71.6
C1170	4030007110	S.CER C1608 CH 1H 680J-T	T	26.6/56.9
C1171	4030006980	S.CER C1608 CH 1H 070D-T	T	26.6/55.7
C1172	4030007080	S.CER C1608 CH 1H 390J-T	T	26.5/47.7
C1173	4030006940	S.CER C1608 CH 1H 030C-T	T	26.5/48.9
C1174	4030007050	S.CER C1608 CH 1H 220J-T	T	29.9/96.4
C1175	4030018600	S.CER C1608 CH 1H 152J-T	T	24.4/44.1
C1176	4030010760	S.CER C1608 CH 1H 331J-T	T	25.7/91.1
C1178	4030007150	S.CER C1608 CH 1H 151J-T	T	25.5/67.0
C1179	4030007130	S.CER C1608 CH 1H 101J-T	T	25.5/75.1
C1180	4030007110	S.CER C1608 CH 1H 680J-T	T	25.5/59.2
C1181	4030007050	S.CER C1608 CH 1H 220J-T	T	25.4/51.2
C1182	4030007050	S.CER C1608 CH 1H 220J-T	T	29.2/102.5
C1183	4030018610	S.CER C1608 CH 1H 182J-T	T	23.2/44.1
C1184	4030007140	S.CER C1608 CH 1H 121J-T	T	30.0/91.1
C1186	4030007010	S.CER C1608 CH 1H 100D-T	T	30.1/67.0
C1187	4030007010	S.CER C1608 CH 1H 100D-T	T	30.1/75.1
C1188	4030006980	S.CER C1608 CH 1H 070D-T	T	30.1/59.2
C1189	4030007050	S.CER C1608 CH 1H 220J-T	T	30.0/51.2
C1190	4030007020	S.CER C1608 CH 1H 120J-T	T	31.8/102.5
C1191	4030018610	S.CER C1608 CH 1H 182J-T	T	31.4/43.4
C1192	4030007170	S.CER C1608 CH 1H 221J-T	T	29.2/88.9
C1195	4030007140	S.CER C1608 CH 1H 121J-T	T	29.1/63.5
C1196	4030007060	S.CER C1608 CH 1H 270J-T	T	29.1/64.7
C1197	4030007110	S.CER C1608 CH 1H 680J-T	T	29.1/72.8
C1198	4030007090	S.CER C1608 CH 1H 470J-T	T	29.1/71.6
C1199	4030007110	S.CER C1608 CH 1H 680J-T	T	29.2/56.9
C1200	4030006980	S.CER C1608 CH 1H 070D-T	T	29.2/55.7
C1201	4030007080	S.CER C1608 CH 1H 390J-T	T	29.1/47.7
C1202	4030006940	S.CER C1608 CH 1H 030C-T	T	29.1/48.9
C1203	4030007050	S.CER C1608 CH 1H 220J-T	T	31.1/96.4
C1204	4030007170	S.CER C1608 CH 1H 221J-T	T	29.2/87.6
C1205	4030018600	S.CER C1608 CH 1H 152J-T	T	29.0/43.4
C1206	4030010760	S.CER C1608 CH 1H 331J-T	T	32.6/91.1
C1208	4030007150	S.CER C1608 CH 1H 151J-T	T	31.3/67.0
C1209	4030007130	S.CER C1608 CH 1H 101J-T	T	31.3/75.1
C1210	4030007110	S.CER C1608 CH 1H 680J-T	T	31.3/59.2
C1211	4030007070	S.CER C1608 CH 1H 330J-T	T	31.2/51.2
C1212	4030007050	S.CER C1608 CH 1H 220J-T	T	33.9/101.8
C1213	4030007150	S.CER C1608 CH 1H 151J-T	T	31.3/91.1
C1215	4030007060	S.CER C1608 CH 1H 270J-T	T	32.5/67.0
C1216	4030007010	S.CER C1608 CH 1H 100D-T	T	32.5/75.1
C1217	4030007030	S.CER C1608 CH 1H 150J-T	T	32.5/59.2
C1218	4030007050	S.CER C1608 CH 1H 220J-T	T	32.4/51.2

Eqv.= This component is equivalent to the REF No. component listed above, and may be substituted on parts orders and repairs.

[MAIN UNIT]

REF NO.	PARTS NO.	DESCRIPTION	M.	H/V LOCATION
C1219	4030007020	S.CER C1608 CH 1H 120J-T	T	35.1/101.8
C1220	4030018600	S.CER C1608 CH 1H 152J-T	T	30.2/43.4
C1221	4030017810	S.CER C1608 CH 1H 102J-T	T	35.1/91.1
C1223	4030010760	S.CER C1608 CH 1H 331J-T	T	33.7/67.0
C1224	4030011280	S.CER C1608 CH 1H 271J-T	T	33.7/75.1
C1225	4030007160	S.CER C1608 CH 1H 181J-T	T	33.7/59.2
C1226	4030007130	S.CER C1608 CH 1H 101J-T	T	34.8/51.2
C1227	4030007130	S.CER C1608 CH 1H 101J-T	T	33.7/99.2
C1228	4030017760	S.CER C1005 JB 1H 222K-T	T	36.0/44.1
C1229	4030007170	S.CER C1608 CH 1H 221J-T	T	33.8/91.1
C1230	4030007130	S.CER C1608 CH 1H 101J-T	T	35.0/83.1
C1231	4030007150	S.CER C1608 CH 1H 151J-T	T	34.9/67.0
C1232	4030007110	S.CER C1608 CH 1H 680J-T	T	34.9/75.1
C1233	4030007090	S.CER C1608 CH 1H 470J-T	T	34.9/59.2
C1234	4030007090	S.CER C1608 CH 1H 470J-T	T	33.6/51.2
C1235	4030008560	S.CER C1608 CH 1H 300J-T	T	34.9/99.2
C1236	4030018610	S.CER C1608 CH 1H 182J-T	T	37.2/44.3
C1237	4030018980	S.CER C1608 JB 1H 104K-T	T	33.8/93.0
C1238	4030018980	S.CER C1608 JB 1H 104K-T	T	33.8/85.0
C1239	4030018980	S.CER C1608 JB 1H 104K-T	T	34.0/68.9
C1240	4030018980	S.CER C1608 JB 1H 104K-T	T	34.0/77.0
C1241	4030018980	S.CER C1608 JB 1H 104K-T	T	33.8/61.1
C1242	4030018980	S.CER C1608 JB 1H 104K-T	T	33.6/53.1
C1243	4030018980	S.CER C1608 JB 1H 104K-T	T	37.1/102.3
C1244	4030018980	S.CER C1608 JB 1H 104K-T	T	40.9/84.1
C1245	4030018980	S.CER C1608 JB 1H 104K-T	T	107.0/83.9
C1246	4030018980	S.CER C1608 JB 1H 104K-T	T	48.9/109.6
C1247	4030019320	S.CER C1608 X7R 1C 105K-T	T	43.6/89.9
C1248	4030018980	S.CER C1608 JB 1H 104K-T	T	120.4/80.6
C1249	4030019320	S.CER C1608 X7R 1C 105K-T	T	46.8/88.0
C1250	4030019320	S.CER C1608 X7R 1C 105K-T	T	47.1/99.4
C1251	4030016790	S.CER C1005 JB 1E 103K-T	T	115.4/78.2
C1252	4030006880	S.CER C1608 JB 1H 472K-T	T	115.0/83.3
C1253	4030018970	S.CER C3225 JB 1C 226MT-N	T	108.4/80.0
C1254	4030018970	S.CER C3225 JB 1C 226MT-N	T	105.4/80.0
C1255	4030018980	S.CER C1608 JB 1H 104K-T	T	68.0/89.5
C1256	4030019320	S.CER C1608 X7R 1C 105K-T	T	50.6/94.3
C1257	4030019320	S.CER C1608 X7R 1C 105K-T	T	51.1/107.5
C1258	4030018560	S.CER C2012 JB 1A 475K-T	T	66.5/89.6
C1259	4030017810	S.CER C1608 CH 1H 102J-T	T	51.8/94.3
C1260	4030017810	S.CER C1608 CH 1H 102J-T	T	52.4/107.5
C1261	4030019320	S.CER C1608 X7R 1C 105K-T	T	60.4/91.2
C1262	4030017340	S.CER C1005 CH 1H 010B-T	T	53.0/96.1
C1263	4030017340	S.CER C1005 CH 1H 010B-T	T	53.6/108.7
C1264	4030019320	S.CER C1608 X7R 1C 105K-T	T	60.4/98.8
C1265	4030018520	S.CER C1608 JB 0J 225M-T	T	111.4/70.1
C1266	4030017810	S.CER C1608 CH 1H 102J-T	T	56.9/98.9
C1267	4030017810	S.CER C1608 CH 1H 102J-T	T	56.9/86.4
C1268	4030019320	S.CER C1608 X7R 1C 105K-T	T	58.2/98.9
C1269	4030019320	S.CER C1608 X7R 1C 105K-T	T	58.2/86.4
C1270	4030019460	S.CER C1608 JB 0J 106M-T	T	108.1/71.2
C1271	4030019460	S.CER C1608 JB 0J 106M-T	T	108.1/69.9
C1272	4030007010	S.CER C1608 CH 1H 100D-T	T	60.4/95.0
C1275	4030019320	S.CER C1608 X7R 1C 105K-T	T	69.4/92.1
C1276	4030018980	S.CER C1608 JB 1H 104K-T	T	105.0/74.8
C1277	4030007110	S.CER C1608 CH 1H 680J-T	T	70.7/96.6
C1278	4030018980	S.CER C1608 JB 1H 104K-T	T	70.7/101.0
C1279	4030007110	S.CER C1608 CH 1H 680J-T	T	72.1/96.6
C1280	4030011600	S.CER C1608 JB 1E 104K-T	B	103.3/30.1
C1281	4030019990	S.CER C1005 JB 1C 104K-T	T	87.5/30.7
C1282	4030006900	S.CER C1608 JB 1H 103K-T	T	71.4/103.8
C1283	4030006880	S.CER C1608 JB 1H 472K-T	T	117.7/69.5
C1285	4030018980	S.CER C1608 JB 1H 104K-T	T	72.2/92.0
C1288	4030017780	S.CER C1005 JB 1H 472K-T	T	14.4/81.1
C1289	4030006880	S.CER C1608 JB 1H 472K-T	T	120.8/69.5
C1290	4030006880	S.CER C1608 JB 1H 472K-T	T	112.3/84.6
C1296	4030017420	S.CER C1005 CH 1H 470J-T	T	110.

[MAIN UNIT]

REF NO.	PARTS NO.	DESCRIPTION	M.	H/V LOCATION
C1432	4030007090	S.CER C1608 CH 1H 470J-T	T	90.5/106.7
C1433	4030017650	S.CER C1005 CH 1H 270J-T	T	101.3/97.5
C1434	4030007080	S.CER C1608 CH 1H 390J-T	T	85.6/110.0
C1435	4030007070	S.CER C1608 CH 1H 330J-T	T	86.8/110.0
C1436	4030007140	S.CER C1608 CH 1H 121J-T	T	85.6/105.2
C1437	4030017400	S.CER C1005 CH 1H 220J-T	T	105.4/89.4
C1439	4030007050	S.CER C1608 CH 1H 220J-T	T	83.9/110.0
C1440	4030006880	S.CER C1608 JB 1H 472K-T	T	140.7/98.0
C1442	4030007030	S.CER C1608 CH 1H 150J-T	T	140.7/103.2
C1443	4030018980	S.CER C1608 JB 1H 104K-T	T	83.0/105.2
C1444	4030017420	S.CER C1005 CH 1H 470J-T	T	102.4/89.7
C1445	4030017390	S.CER C1005 CH 1H 180J-T	T	102.7/93.7
C1446	4030018980	S.CER C1608 JB 1H 104K-T	T	82.5/110.0
C1447	4030006880	S.CER C1608 JB 1H 472K-T	T	141.2/93.4
C1448	4030017650	S.CER C1005 CH 1H 270J-T	T	100.4/90.8
C1450	4030017780	S.CER C1005 JB 1H 472K-T	T	126.5/106.7
C1451	4030017500	S.CER C1005 CH 1H 560J-T	T	100.2/92.0
C1452	4030013960	S.CER C1005 JB 1C 473K-T	T	129.6/112.3
C1453	4030006880	S.CER C1608 JB 1H 472K-T	T	131.3/90.7
C1454	4030017780	S.CER C1005 JB 1H 472K-T	T	95.4/93.9
C1455	4030007170	S.CER C1608 CH 1H 221J-T	T	135.6/94.7
C1456	4030006880	S.CER C1608 JB 1H 472K-T	T	136.4/92.1
C1457	4030017500	S.CER C1005 CH 1H 560J-T	T	96.2/92.0
C1459	4030017780	S.CER C1005 JB 1H 472K-T	T	130.5/105.7
C1460	4030019990	S.CER C1005 JB 1C 104K-T	T	94.5/93.9
C1461	4030007030	S.CER C1608 CH 1H 150J-T	T	142.5/83.8
C1462	4030006880	S.CER C1608 JB 1H 472K-T	T	131.3/87.8
C1463	4030006880	S.CER C1608 JB 1H 472K-T	T	129.0/84.4
C1464	4030017780	S.CER C1005 JB 1H 472K-T	T	81.9/93.5
C1465	4030017780	S.CER C1005 JB 1H 472K-T	T	129.6/105.7
C1466	4030006970	S.CER C1608 CH 1H 060D-T	T	146.2/79.3
C1467	4030017600	S.CER C1005 CH 1H 080C-T	T	133.2/105.7
C1468	4030016790	S.CER C1005 JB 1E 103K-T	T	90.1/90.7
C1469	4030017780	S.CER C1005 JB 1H 472K-T	T	133.4/107.6
C1470	4030017780	S.CER C1005 JB 1H 472K-T	T	132.6/109.4
C1471	4030016790	S.CER C1005 JB 1E 103K-T	T	91.0/89.0
C1472	4030018980	S.CER C1608 JB 1H 104K-T	T	113.9/20.0
C1473	4030018980	S.CER C1608 JB 1H 104K-T	T	121.1/16.7
C1474	4030007030	S.CER C1608 CH 1H 150J-T	T	141.5/73.5
C1475	4030006880	S.CER C1608 JB 1H 472K-T	T	143.0/68.1
C1476	4030017780	S.CER C1005 JB 1H 472K-T	T	74.9/93.8
C1477	4030019490	S.CER C2012 JB 1A 106K-T	T	138.5/60.8
C1478	4030006880	S.CER C1608 JB 1H 472K-T	T	130.8/69.2
C1479	4030006880	S.CER C1608 JB 1H 472K-T	T	138.2/59.2
C1480	4030017810	S.CER C1608 CH 1H 102J-T	T	117.1/18.0
C1481	4030006880	S.CER C1608 JB 1H 472K-T	T	143.0/64.0
C1482	4030006880	S.CER C1608 JB 1H 472K-T	T	126.6/68.3
C1483	4030018980	S.CER C1608 JB 1H 104K-T	T	112.0/14.5
C1484	4030007130	S.CER C1608 CH 1H 101J-T	T	135.0/58.0
C1485	4030017810	S.CER C1608 CH 1H 102J-T	T	132.7/53.7
C1486	4030007140	S.CER C1608 CH 1H 121J-T	T	116.8/11.5
C1487	4030019090	S.CER C2012 JB 1C 225M-T	T	128.6/19.7
C1488	4030018980	S.CER C1608 JB 1H 104K-T	T	116.8/10.1
C1489	4030017780	S.CER C1005 JB 1H 472K-T	T	127.4/56.0
C1490	4030006880	S.CER C1608 JB 1H 472K-T	T	138.3/55.0
C1491	4030019490	S.CER C2012 JB 1A 106K-T	T	144.1/50.7
C1492	4030006880	S.CER C1608 JB 1H 472K-T	T	143.9/52.3
C1493	4030019990	S.CER C1005 JB 1C 104K-T	T	119.8/13.9
C1494	4030007150	S.CER C1608 CH 1H 151J-T	B	125.4/52.9
C1495	4030007130	S.CER C1608 CH 1H 101J-T	T	136.0/52.2
C1496	4030007150	S.CER C1608 CH 1H 151J-T	B	125.4/50.9
C1497	4030018980	S.CER C1608 JB 1H 104K-T	T	127.5/8.8
C1498	4030007150	S.CER C1608 CH 1H 151J-T	B	127.0/47.2
C1499	4030018980	S.CER C1608 JB 1H 104K-T	T	126.9/41.0
C1500	4030006880	S.CER C1608 JB 1H 472K-T	T	143.3/48.1
C1501	4030007150	S.CER C1608 CH 1H 151J-T	B	127.0/45.0
C1502	4030018980	S.CER C1608 JB 1H 104K-T	T	134.3/6.0
C1503	4030007140	S.CER C1608 CH 1H 121J-T	T	134.3/8.5
C1504	4030007130	S.CER C1608 CH 1H 101J-T	T	127.1/31.5
C1505	4030018980	S.CER C1608 JB 1H 104K-T	B	124.7/44.3
C1506	4030006880	S.CER C1608 JB 1H 472K-T	T	143.3/45.1
C1507	4030018980	S.CER C1608 JB 1H 104K-T	T	130.8/31.4
C1508	4030018980	S.CER C1608 JB 1H 104K-T	T	134.3/12.2
C1509	4510009820	S.ELE EEEFK1C470P	T	127.8/48.3
C1510	4030019990	S.CER C1005 JB 1C 104K-T	T	128.9/12.6
C1511	4030018980	S.CER C1608 JB 1H 104K-T	T	135.5/41.0
C1512	4030018980	S.CER C1608 JB 1H 104K-T	T	131.5/15.7
C1513	4030018980	S.CER C1608 JB 1H 104K-T	T	124.9/29.0
C1514	4030019460	S.CER C1608 JB 0J 106M-T	T	115.9/43.4
C1515	4030018980	S.CER C1608 JB 1H 104K-T	T	137.8/32.3
C1516	4030017490	S.CER C1608 JB 1A 105K-T	T	115.3/41.5
C1517	4030018980	S.CER C1608 JB 1H 104K-T	T	135.4/33.7
C1518	4030007090	S.CER C1608 CH 1H 470J-T	T	144.2/33.1
C1519	4030006880	S.CER C1608 JB 1H 472K-T	T	130.6/28.7
C1520	4030006880	S.CER C1608 JB 1H 472K-T	T	128.5/25.4
C1521	4030018980	S.CER C1608 JB 1H 104K-T	T	134.3/41.0
C1522	4030019460	S.CER C1608 JB 0J 106M-T	T	122.0/50.1
C1523	4030018980	S.CER C1608 JB 1H 104K-T	T	143.8/23.3
C1524	4030017490	S.CER C1608 JB 1A 105K-T	T	123.2/50.1
C1525	4030018980	S.CER C1608 JB 1H 104K-T	T	134.0/28.7
C1526	4030019460	S.CER C1608 JB 0J 106M-T	T	115.4/46.9
C1527	4030017490	S.CER C1608 JB 1A 105K-T	T	111.9/46.6
C1528	4030018980	S.CER C1608 JB 1H 104K-T	T	146.7/23.3
C1529	4030018980	S.CER C1608 JB 1H 104K-T	T	141.1/20.7
C1530	4030018980	S.CER C1608 JB 1H 104K-T	T	127.3/12.3
C1531	4030016790	S.CER C1005 JB 1E 103K-T	T	110.2/50.9
C1532	4030018980	S.CER C1608 JB 1H 104K-T	T	137.7/18.2
C1533	4030018980	S.CER C1608 JB 1H 104K-T	T	109.0/36.4
C1534	4030019490	S.CER C2012 JB 1A 106K-T	T	109.3/38.0
C1535	4030017790	S.CER C1005 JB 1H 682K-T	T	108.2/50.9
C1536	4030018980	S.CER C1608 JB 1H 104K-T	T	137.9/22.7
C1537	4030018980	S.CER C1608 JB 1H 104K-T	B	121.1/37.5
C1538	4030016790	S.CER C1005 JB 1E 103K-T	T	109.2/50.9
C1539	4030018980	S.CER C1608 JB 1H 104K-T	T	116.5/38.8
C1540	4030017490	S.CER C1608 JB 1A 105K-T	T	105.6/49.4

Eqv.= This component is equivalent to the REF No. component listed above, and may be substituted on parts orders and repairs.

[MAIN UNIT]

REF NO.	PARTS NO.	DESCRIPTION	M.	H/V LOCATION
C1541	4030019460	S.CER C1608 JB 0J 106M-T	T	143.7/17.6
C1543	4030018980	S.CER C1608 JB 1H 104K-T	T	110.6/44.2
C1545	4030018980	S.CER C1608 JB 1H 104K-T	T	137.9/14.7
C1546	4030017490	S.CER C1608 JB 1A 105K-T	T	105.9/38.8
C1547	4030006880	S.CER C1608 JB 1H 472K-T	T	108.9/46.1
C1548	4030018980	S.CER C1608 JB 1H 104K-T	T	143.7/14.7
C1550	4030006880	S.CER C1608 JB 1H 472K-T	T	105.9/35.9
C1551	4030016790	S.CER C1005 JB 1E 103K-T	T	100.3/51.3
C1553	4030006880	S.CER C1608 JB 1H 472K-T	T	98.7/37.0
C1555	4030018980	S.CER C1608 JB 1H 104K-T	T	102.5/49.2
C1556	4030006900	S.CER C1608 JB 1H 103K-T	B	91.8/47.8
C1557	4030006900	S.CER C1608 JB 1H 103K-T	B	80.1/47.8
C1558	4030006900	S.CER C1608 JB 1H 103K-T	B	83.4/47.8
C1601	4030017760	S.CER C1005 JB 1H 222K-T	T	95.1/48.6
C1602	4030017640	S.CER C1005 CH 1H 150J-T	T	105.8/60.3
C1603	4030017590	S.CER C1005 CH 1H 070C-T	T	106.7/59.0
C1604	4030017990	S.CER C1005 JB 1H 682K-T	T	93.8/49.8
C1605	4030017570	S.CER C1005 CH 1H 040B-T	T	92.5/50.2
C1606	4030017510	S.CER C1005 CH 1H 680J-T	T	106.7/57.4
C1607	4030017360	S.CER C1005 CH 1H 030B-T	T	103.7/59.9
C1608	4030017790	S.CER C1005 JB 1H 682K-T	T	91.3/49.8
C1609	4030017600	S.CER C1005 CH 1H 390J-T	T	103.7/56.3
C1610	4030017780	S.CER C1005 JB 1H 472K-T	T	78.6/47.2
C1611	4030019990	S.CER C1005 JB 1C 104K-T	T	89.8/52.6
C1612	4030017660	S.CER C1005 CH 1H 330J-T	T	57.4/55.5
C1613	4030017460	S.CER C1005 JB 1H 102K-T	T	54.1/59.1
C1614	4030017460	S.CER C1005 JB 1H 102K-T	T	101.2/59.5
C1615	4030017460	S.CER C1005 JB 1H 102K-T	T	97.2/57.2
C1616	4030017780	S.CER C1005 JB 1H 472K-T	T	61.9/59.4
C1617	4030017780	S.CER C1005 JB 1H 472K-T	T	83.0/51.7
C1618	4030019990	S.CER C1005 JB 1C 104K-T	T	83.4/49.6
C1619	4030017780	S.CER C1005 JB 1H 472K-T	T	75.3/48.5
C1620	4030017580	S.CER C1005 CH 1H 060C-T	T	64.8/51.5
C1621	4030019490	S.CER C2012 JB 1A 106K-T	T	81.9/49.0
C1622	4030017780	S.CER C1005 JB 1H 472K-T	T	72.5/44.0
C1623	4030017700	S.CER C1005 CH 1H 151J-T	T	65.7/51.5
C1624	4030019990	S.CER C1005 JB 1C 104K-T	T	80.2/47.2
C1625	4030017570	S.CER C1005 CH 1H 040B-T	T	64.8/48.9
C1626	4030017780	S.CER C1005 JB 1H 472K-T	T	55.9/59.8
C1628	4030019490	S.CER C2012 JB 1A 106K-T	T	79.2/51.1
C1629	4030017680	S.CER C1005 CH 1H 820J-T	T	65.7/48.9
C1631	4030017380	S.CER C1005 CH 1H 050B-T	T	64.8/46.6
C1632	4030017460	S.CER C1005 JB 1H 102K-T	T	94.3/58.4
C1633	4030017780	S.CER C1005 JB 1H 472K-T	T	69.4/67.8
C1634	4030017670	S.CER C1005 CH 1H 390J-T	T	65.7/46.6
C1636	4030017590	S.CER C1005 CH 1H 070C-T	T	65.2/45.0
C1637	4030017430	S.CER C1005 CH 1H 101J-T	T	97.5/61.2
C1638	4030017400	S.CER C1005 CH 1H 220J-T	T	69.0/43.9
C1639	4030017780	S.CER C1005 JB 1H 472K-T	T	60.3/64.4
C1640	4030017360	S.CER C1005 CH 1H 030B-T	T	67.7/43.0
C1641	4030017660	S.CER C1005 CH 1H 330J-T	T	69.0/43.0
C1642	4030017680	S.CER C1005 CH 1H 820J-T	T	94.0/57.2
C1643	4030017340	S.CER C1005 CH 1H 010B-T	T	68.2/41.9
C1644	4030017580	S.CER C1005 CH 1H 060C-T	T	93.7/59.6
C1645	4030017650	S.CER C1005 CH 1H 270J-T	T	68.6/66.4
C1646	4030017670	S.CER C1005 CH 1H 390J-T	T	69.5/41.7
C1647	4030017700	S.CER C1005 CH 1H 151J-T	T	90.9/60.5
C1648	4030019990	S.CER C1005 JB 1C 104K-T	T	68.6/69.2
C1649	4030017530	S.CER C1005 CH 1H 0R5B-T	T	66.3/38.1
C1650	4030017630	S.CER C1005 CH 1H 120J-T	T	90.4/58.4
C1651	4030017460	S.CER C1005 JB 1H 102K-T	T	61.7/67.0
C1652	4030017390	S.CER C1005 CH 1H 180J-T	T	66.0/35.9
C1653	4030017700	S.CER C1005 CH 1H 151J-T	T	90.1/56.7
C1654	4030017580	S.CER C1005 CH 1H 060C-T	T	66.0/35.0
C1655	4030017390	S.CER C1005 CH 1H 180J-T	T	88.1/57.5
C1656	4030017780	S.CER C1005 JB 1H 472K-T		

[MAIN UNIT]

REF NO.	PARTS NO.	DESCRIPTION	M.	H/V LOCATION
C1726	4030017780	S.CER C1005 JB 1H 472K-T	T	42.0/39.6
C1727	4030019990	S.CER C1005 JB 1C 104K-T	T	64.4/35.9
C1729	4030017500	S.CER C1005 CH 1H 560J-T	T	46.5/80.1
C1730	4030017460	S.CER C1005 JB 1H 102K-T	T	59.9/77.4
C1731	4030020010	S.CER C1005 CH 1H 271J-T	T	48.2/80.1
C1732	4030017500	S.CER C1005 CH 1H 560J-T	T	48.2/81.0
C1733	4030017390	S.CER C1005 CH 1H 180J-T	T	49.7/80.6
C1734	4030017670	S.CER C1005 CH 1H 390J-T	T	53.0/78.6
C1735	4030017460	S.CER C1005 JB 1H 102K-T	T	61.7/77.8
C1736	4030017400	S.CER C1005 CH 1H 220J-T	T	54.9/77.0
C1737	4030019990	S.CER C1005 JB 1C 104K-T	T	61.7/76.9
C1738	4030017460	S.CER C1005 JB 1H 102K-T	T	65.7/80.2
C1739	4030020040	S.CER C1005 CH 1H 200J-T	T	66.2/74.6
C1741	4030017360	S.CER C1005 CH 1H 030B-T	T	66.2/78.1
C1742	4030017530	S.CER C1005 CH 1H 0R5B-T	T	66.2/79.0
C1743	4030017660	S.CER C1005 CH 1H 330J-T	T	68.0/74.6
C1744	4030010000	S.CER C1608 CH 1H 510J-T	T	77.4/71.6
C1745	4030017420	S.CER C1005 CH 1H 470J-T	T	77.8/84.1
C1746	4030017740	S.CER C1005 JB 1H 821K-T	T	78.6/75.0
C1747	4030018820	S.CER C1005 JB 1H 561K-T	T	77.8/83.2
C1749	4030017360	S.CER C1005 CH 1H 030B-T	T	78.6/74.1
C1750	4030017650	S.CER C1005 CH 1H 270J-T	T	78.6/73.2
C1751	4030017650	S.CER C1005 CH 1H 270J-T	T	79.9/84.1
C1752	4030017730	S.CER C1005 JB 1H 471K-T	T	80.2/74.6
C1753	4030017720	S.CER C1005 JB 1H 331K-T	T	80.8/83.2
C1754	4030017360	S.CER C1005 CH 1H 030B-T	T	81.1/72.8
C1755	4030017660	S.CER C1005 CH 1H 330J-T	T	81.1/71.8
C1756	4030017360	S.CER C1005 CH 1H 030B-T	T	82.7/84.1
C1757	4030017650	S.CER C1005 CH 1H 270J-T	T	82.7/83.2
C1758	4030017700	S.CER C1005 CH 1H 151J-T	T	84.1/83.7
C1759	4030017780	S.CER C1005 JB 1H 472K-T	T	85.0/83.7
C1760	4030017780	S.CER C1005 JB 1H 472K-T	T	85.6/72.3
C1761	4030010000	S.CER C1608 CH 1H 510J-T	T	85.9/81.6
C1762	4030017420	S.CER C1005 CH 1H 470J-T	T	84.5/77.3
C1763	4030017590	S.CER C1005 CH 1H 070C-T	T	86.1/77.3
C1764	4030017590	S.CER C1005 CH 1H 070C-T	T	87.3/82.3
C1765	4030018020	S.CER C1608 CH 1H 910J-T	T	88.7/81.6
C1766	4510009950	S.ELE EEEHC1C470P	T	88.9/42.1
C1767	4030017430	S.CER C1005 CH 1H 101J-T	T	87.8/77.3
C1768	4030017380	S.CER C1005 CH 1H 050B-T	T	88.0/73.7
C1769	4030017360	S.CER C1005 CH 1H 030B-T	T	92.3/83.7
C1770	4030018020	S.CER C1608 CH 1H 910J-T	T	88.3/79.6
C1771	4030017460	S.CER C1005 JB 1H 102K-T	T	73.1/88.6
C1772	4030017680	S.CER C1005 CH 1H 820J-T	T	90.7/72.5
C1773	4030017530	S.CER C1005 CH 1H 0R5B-T	T	88.5/75.3
C1774	4030017530	S.CER C1005 CH 1H 0R5B-T	T	92.8/82.0
C1775	4030017650	S.CER C1005 CH 1H 270J-T	T	92.0/73.9
C1776	4030017510	S.CER C1005 CH 1H 680J-T	T	92.2/78.4
C1777	4030017460	S.CER C1005 JB 1H 102K-T	T	74.8/91.0
C1778	4030017510	S.CER C1005 CH 1H 680J-T	T	92.0/75.6
C1779	4030017670	S.CER C1005 CH 1H 390J-T	T	94.5/82.0
C1780	4030017780	S.CER C1005 JB 1H 472K-T	T	95.0/77.2
C1781	4030017780	S.CER C1005 JB 1H 472K-T	T	98.2/83.9
C1782	4030017460	S.CER C1005 JB 1H 102K-T	T	77.4/91.0
C1783	4030017780	S.CER C1005 JB 1H 472K-T	T	98.4/75.5
C1784	4030017400	S.CER C1005 CH 1H 220J-T	T	99.6/76.4
C1785	4030017590	S.CER C1005 CH 1H 070C-T	T	100.1/75.0
C1786	4030017400	S.CER C1005 CH 1H 220J-T	T	100.5/76.4
C1787	4030017780	S.CER C1005 JB 1H 472K-T	T	74.8/91.9
C1788	4030017780	S.CER C1005 JB 1H 472K-T	T	77.4/91.9
C1789	4550007480	S.TAN F930J106MAABMA	T	62.4/35.3
C1790	4030019990	S.CER C1005 JB 1C 104K-T	T	59.0/37.9
C1791	4550007480	S.TAN F930J106MAABMA	T	60.3/35.3
C1803	4030017430	S.CER C1005 CH 1H 101J-T	T	19.2/17.7
C1804	4030019990	S.CER C1005 JB 1C 104K-T	T	10.2/31.7
C1805	4030017780	S.CER C1005 JB 1H 472K-T	T	28.1/20.0
C1806	4030019990	S.CER C1005 JB 1C 104K-T	T	3.3/29.6
C1807	4550008450	S.TAN F931E226MCC	T	103.8/4.8
C1808	4030018980	S.CER C1608 JB 1H 104K-T	T	98.8/3.2
C1810	4030017780	S.CER C1005 JB 1H 472K-T	T	74.7/3.4
C1812	4030017780	S.CER C1005 JB 1H 472K-T	T	82.9/22.4
C1814	4030018980	S.CER C1608 JB 1H 104K-T	T	95.2/3.2
C1815	4030017780	S.CER C1005 JB 1H 472K-T	T	88.5/14.3
C1816	4550007220	S.TAN F931A476MCMBMA	T	90.9/5.0
C1819	4030016790	S.CER C1005 JB 1E 103K-T	T	53.6/31.0
C1820	4030017760	S.CER C1005 JB 1H 222K-T	T	67.7/7.2
C1821	4030017780	S.CER C1005 JB 1H 472K-T	T	67.0/29.9
C1822	4030017460	S.CER C1005 JB 1H 102K-T	T	66.1/3.8
C1823	4030017780	S.CER C1005 JB 1H 472K-T	T	55.7/31.6
C1826	4030017630	S.CER C1005 CH 1H 120J-T	T	69.1/10.6
C1827	4030017630	S.CER C1005 CH 1H 120J-T	T	68.9/12.8
C1829	4030017780	S.CER C1005 JB 1H 472K-T	T	78.8/40.7
C1830	4030019990	S.CER C1005 JB 1C 104K-T	T	84.6/40.8
C1831	4030019990	S.CER C1005 JB 1C 104K-T	T	71.1/31.1
C1832	4030017460	S.CER C1005 JB 1H 102K-T	T	76.2/39.6
C1833	4030017460	S.CER C1005 JB 1H 102K-T	T	82.1/39.7
C1834	4030019990	S.CER C1005 JB 1C 104K-T	T	69.3/31.2
C1835	4030017460	S.CER C1005 JB 1H 102K-T	T	82.1/37.9
C1836	4030019990	S.CER C1005 JB 1C 104K-T	T	87.1/24.7
C1837	4030019990	S.CER C1005 JB 1C 104K-T	T	59.1/26.2
C1838	4030017780	S.CER C1005 JB 1H 472K-T	T	64.1/31.2
C1839	4030019990	S.CER C1005 JB 1C 104K-T	T	65.2/27.1
C1840	4030019990	S.CER C1005 JB 1C 104K-T	T	64.3/27.1
C1841	4030019990	S.CER C1005 JB 1C 104K-T	T	48.8/2.4
C1842	4030019990	S.CER C1005 JB 1C 104K-T	T	69.0/6.0
C1843	4030017780	S.CER C1005 JB 1H 472K-T	T	69.6/6.0
C1845	4510009950	S.ELE EEEHC1C470P	T	102.8/43.8
C1846	4030019990	S.CER C1005 JB 1C 104K-T	T	70.2/3.7
C1848	4030018980	S.CER C1608 JB 1H 104K-T	B	93.0/21.3
C1850	4030019990	S.CER C1005 JB 1C 104K-T	T	86.2/2.1
C1851	4030017760	S.CER C1005 JB 1H 222K-T	T	79.6/35.5
C1852	4030019990	S.CER C1005 JB 1C 104K-T	T	79.6/16.1
C1853	4030019990	S.CER C1005 JB 1C 104K-T	T	82.2/29.5
C1854	4030019990	S.CER C1005 JB 1C 104K-T	T	79.5/29.5
C1855	4030017780	S.CER C1005 JB 1H 472K-T	T	70.2/2.6

Eqv.= This component is equivalent to the REF No. component listed above, and may be substituted on parts orders and repairs.

[MAIN UNIT]

REF NO.	PARTS NO.	DESCRIPTION	M.	H/V LOCATION
C1856	4030019990	S.CER C1005 JB 1C 104K-T	T	46.1/5.2
C1857	4550007220	S.TAN F931A476MCMBMA	B	58.9/25.6
C1858	4550007220	S.TAN F931A476MCMBMA	B	72.5/5.0
C1859	4030018980	S.CER C1608 JB 1H 104K-T	B	70.5/10.9
C1861	4030017420	S.CER C1005 CH 1H 470J-T	T	54.3/46.5
C1862	4510010120	S.ELE EEEFK1E101XP	T	65.7/103.8
C1863	4030018980	S.CER C1608 JB 1H 104K-T	T	18.9/42.7
C1864	4030019990	S.CER C1005 JB 1C 104K-T	T	62.2/2.3
C1865	4030017650	S.CER C1005 CH 1H 270J-T	T	81.5/56.4
C1866	4030017650	S.CER C1005 CH 1H 270J-T	T	110.1/61.8
C1867	4030017600	S.CER C1005 CH 1H 080C-T	T	66.7/60.8
C1869	4030006900	S.CER C1608 JB 1H 103K-T	B	140.0/98.1
C1870	4030006960	S.CER C1608 CH 1H 050C-T	B	141.1/86.2
C1871	4030011600	S.CER C1608 JB 1E 104K-T	B	143.2/88.3
C1872	4030006900	S.CER C1608 JB 1H 103K-T	B	146.7/100.5
C1874	4030011600	S.CER C1608 JB 1E 104K-T	B	146.7/98.3
C1876	4030018980	S.CER C1608 JB 1H 104K-T	T	8.0/42.5
C1877	4030019990	S.CER C1005 JB 1C 104K-T	T	2.7/37.7
C1878	4030016790	S.CER C1005 JB 1E 103K-T	T	99.9/93.3
C1879	4030017460	S.CER C1005 JB 1H 102K-T	T	104.4/97.9
C1880	4030006860	S.CER C1608 JB 1H 102K-T	B	127.7/109.3
C1882	4030019990	S.CER C1005 JB 1C 104K-T	T	105.6/105.1
C1883	4030017460	S.CER C1005 JB 1H 102K-T	T	31.7/20.1
C1884	4030017580	S.CER C1005 CH 1H 060C-T	T	38.7/103.3
C1886	4030007130	S.CER C1608 CH 1H 101J-T	T	21.9/83.1
C1887	4030007170	S.CER C1608 CH 1H 221J-T	T	23.2/83.1
C1888	4030007070	S.CER C1608 CH 1H 330J-T	T	24.4/83.1
C1889	4030006990	S.CER C1608 CH 1H 080D-T	T	26.5/81.0
C1890	4030011280	S.CER C1608 CH 1H 271J-T	T	25.7/83.1
C1891	4030007060	S.CER C1608 CH 1H 270J-T	T	30.0/83.1
C1892	4030007160	S.CER C1608 CH 1H 181J-T	T	29.1/79.8
C1893	4030006990	S.CER C1608 CH 1H 080D-T	T	29.1/81.0
C1894	4030007170	S.CER C1608 CH 1H 221J-T	T	31.2/83.1
C1895	4030007070	S.CER C1608 CH 1H 330J-T	T	32.4/83.1
C1896	4030018580	S.CER C1608 CH 1H 821J-T	T	33.7/83.1
C1897	4030009990	S.CER C1608 CH 1H 200J-T	B	86.3/97.8
C1898	4030006990	S.CER C1608 CH 1H 070D-T	B	89.2/97.5
C1899	4030018020	S.CER C1608 CH 1H 910J-T	B	83.5/97.8
C1900	4030007160	S.CER C1608 CH 1H 181J-T	B	88.5/95.1
C1901	4030007130	S.CER C1608 CH 1H 101J-T	B	89.1/102.1
C1902	4030011600	S.CER C1608 JB 1E 104K-T	B	61.9/39.0
C1903	4030017580	S.CER C1005 CH 1H 060C-T	T	21.6/100.2
C1904	4030006970	S.CER C1608 CH 1H 060D-T	B	143.6/100.7
C1905	4030017700	S.CER C1005 CH 1H 151J-T	T	102.3/100.7
C1907	4030011600	S.CER C1608 JB 1E 104K-T	B	81.3/53.7
C1908	4030006910	S.CER C1608 CH 1H 0R5C-T	B	80.3/51.0
C1909	4030017420	S.CER C1005 CH 1H 470J-T	T	50.4/4.5
C1910	4030017580	S.CER C1005 CH 1H 0R5B-T	T	10.2/38.4
C1911	4030017600	S.CER C1005 CH 1H 080C-T	T	117.2/88.0
C1912	4030017380	S.CER C1005 CH 1H 050B-T	T	118.5/88.4
C1913	4030017350	S.CER C1005 CH 1H 020B-T	T	119.9/88.0
C1914	4030017510	S.CER C1005 CH 1H 680J-T	T	116.7/86.8
C1915	4030017680	S.CER C1005 CH 1H 820J-T	T	118.1/87.1
C1916	4030017430	S.CER C1005 CH 1H 101J-T	T	119.0/87.1
C1917	4030017510	S.CER C1005 CH 1H 680J-T	T	120.3/86.8
RL1101	6330001860	REL UA2-12NU		
J1001	6510023092	S.CON 20FLT-SM2-TB(LF)(SN)(M)	T	12.4/108.2
J1002	6510027580	S.CON 16FLT-SM2-TB(LF)(SN)(M)	T	5.6/95.1
J1003	6510027950	S.CON BM13B-SRSS-TBT(LF)(SN)	T	30.7/26.9
J1004	6510021722	S.CON 30FLT-SM2-TB(LF)(SN)(M)	T	10.5/26.4
J1005	6510021722	S.CON 30FLT-SM2-TB(LF)(SN)(M)	T	10.5/12.3
J1101	6510018450	CON TMP-S01X-B1		
J1102	6510018450	CON TMP-S01X-B1		
J1801	6510022621	S.CON 10FMN-BMTRR-A-TBT(LF)(SN)	T	22.8/16.8
J1802	6510028400	CON HU-1632-T		
BT1001	3020000400	LIT CR1632/BK		
EP1001	6910012350	S.BEA MMZ1608Y 102BT	B	22.3/105.2
EP1003	6910012350	S.BEA MMZ1608Y 102BT	B	17.8/108.9
EP1004	6910012350	S.BEA MMZ1608Y 102BT	B	15.3/107.4
EP1005	69100			

[MAIN UNIT]

REF NO.	PARTS NO.	DESCRIPTION	M.	H/V LOCATION
EP1706	6910012350	S.BEA MMZ1608Y 102BT	T	55.0/35.6
EP1707	6910012350	S.BEA MMZ1608Y 102BT	T	64.8/33.5
EP1708	6910012350	S.BEA MMZ1608Y 102BT	T	62.9/75.8
EP1801	6910013310	S.BEA MMZ1608D121B	T	94.5/11.7
EP1802	6910002161	CAS CASE-BM7H-LF		
EP1803	6910002161	CAS CASE-BM7H-LF		
EP1804	6910012350	S.BEA MMZ1608Y 102BT	B	146.4/96.5

[PA UNIT]

REF NO.	PARTS NO.	DESCRIPTION	M.	H/V LOCATION
IC4001	1180001252	S.IC TA7808F(TE16L1NQ)	B	52.5/135.6
IC4002	1110003800	S.IC NJM2904V-TE1-#FMZB	T	75.8/118.5
IC4003	1110003800	S.IC NJM2904V-TE1-#FMZB	T	77.5/128.7
IC5001	1130011760	S.IC CD4094BPWR	T	125.5/124.9
IC5002	1130003761	S.IC TC4S81F(TE85RF)	T	131.1/130.1
Q4001	1540000770	S.TRA 2SD1664L-Q-AB3-R <SLVJ>	T	7.9/127.3
Q4002	1560001351	S.FET 2SK2973A-T113	T	44.1/143.9
Q4003	1590003051	S.FET PD55003-E	T	25.5/139.0
Q4004	1590000680	S.TRA DTC114EUA T106	B	64.5/125.4
Q4005	1590004930	TRA KTC2026-Y-U/PF		
Q4006	1590003040	TRA SD1487 <AMSC>		
Q4007	1590003040	TRA SD1487 <AMSC>		
Q4008	1590004420	S.TRA IMD3AT108	T	3.2/126.4
Q5001	1590000680	S.TRA DTC114EUA T106	T	143.8/127.8
Q5011	1590002420	S.TRA UMD3N TR	T	146.8/18.4
Q5012	1590002420	S.TRA UMD3N TR	T	146.8/42.6
Q5013	1590002420	S.TRA UMD3N TR	T	146.8/91.1
Q5014	1590002420	S.TRA UMD3N TR	T	146.8/30.5
Q5015	1590002420	S.TRA UMD3N TR	T	146.8/54.7
Q5016	1590002420	S.TRA UMD3N TR	T	146.8/78.9
Q5017	1590002420	S.TRA UMD3N TR	T	146.8/104.1
Q5018	1590002420	S.TRA UMD3N TR	T	146.8/66.8
Q5019	1530003960	S.TRA KTC2875-B-RTK/P	B	123.2/129.9
D4003	1730000821	S.ZEN RD8.2M-T1B-A	B	6.5/119.4
D4004	1730000930	S.ZEN RD13M-T1B-A	B	6.5/115.8
D4005	1750001810	S.DIO L1SS400T1G <SLVJ>	T	4.8/96.6
D4006	1790000700	DIO DSA3A1		
D4007	1790000700	DIO DSA3A1		
D4008	1790000700	DIO DSA3A1		
D5001	1790000491	S.DIO HSM88ASTR-E	B	105.5/119.5
D5002	1790000491	S.DIO HSM88ASTR-E	B	105.5/123.4
D5003	1750001810	S.DIO L1SS400T1G <SLVJ>	B	139.3/115.6
D5004	1750001850	S.DIO LDAN222T1G <SLVJ>	T	130.6/127.2
D5011	1750001810	S.DIO L1SS400T1G <SLVJ>	B	142.5/20.4
D5021	1750001810	S.DIO L1SS400T1G <SLVJ>	B	142.4/44.6
D5031	1750001810	S.DIO L1SS400T1G <SLVJ>	B	142.4/93.1
D5041	1750001810	S.DIO L1SS400T1G <SLVJ>	B	142.4/32.5
D5051	1750001810	S.DIO L1SS400T1G <SLVJ>	B	142.4/56.7
D5061	1750001810	S.DIO L1SS400T1G <SLVJ>	B	142.4/80.9
D5071	1750001810	S.DIO L1SS400T1G <SLVJ>	B	142.4/105.5
D5081	1750001810	S.DIO L1SS400T1G <SLVJ>	B	142.4/68.8
D5082	1750002700	S.DIO MMBV3700 <KMC>	B	123.2/133.5
D5083	1750002700	S.DIO MMBV3700 <KMC>	B	126.9/133.5
D5084	1750002770	S.DIO 1SS403(TPH3F)	B	129.7/138.3
D5085	1750002770	S.DIO 1SS403(TPH3F)	B	133.2/138.3
D5086	1750002770	S.DIO 1SS403(TPH3F)	B	122.2/138.3
D5087	1750002770	S.DIO 1SS403(TPH3F)	B	125.7/138.3
D5088	1750002770	S.DIO 1SS403(TPH3F)	B	122.2/136.5
D5089	1750002770	S.DIO 1SS403(TPH3F)	B	125.7/136.5
D5090	1750002770	S.DIO 1SS403(TPH3F)	B	129.7/136.5
D5091	1750002770	S.DIO 1SS403(TPH3F)	B	133.2/136.5
L4002	6200003840	S.COI MLF2012D R22K-T	T	52.0/143.0
L4003	6180003960	COI AL04 TB 101K <TRIA>		
L4004	6180004000	COI AL04 TB 820K <TRIA>		
L4005	2040000490	COI EXC-ELDR25C		
L4006	2040000490	COI EXC-ELDR25C		
L4007	2040000490	COI EXC-ELDR25C		
L4009	6140005250	COI LR-582 <KN>		
L4010	2040000490	COI EXC-ELDR25C		
L4011	2040000490	COI EXC-ELDR25C		
L4012	6140005300	COI LR-580 (TRB10X5X5 6DB)		
L4013	6140002030	COI LR-230 (SK-10M-15Y 120)		
L4014	6140005110	COI LR-567		
L4015	6110001730	COI LA-262		
L4016	6200003950	S.COI HF50ACC 322513-T	T	8.3/97.1
L4017	6200003950	S.COI HF50ACC 322513-T	T	8.0/93.5
L4019	6140003440	COI LR-386 (FK-100E-5003H)		
L4020	2040000490	COI EXC-ELDR25C		
L5001	6200010870	S.COI C2520C-R33G-A (0.33U)	T	138.1/127.8
L5002	6200010740	S.COI C2520C-R27G-A	T	134.3/127.6
L5003	6200002041	S.COI NLV25T-101J	B	142.4/114.3
L5004	6200002041	S.COI NLV25T-101J	B	98.4/120.6
L5005	6200002041	S.COI NLV25T-101J	B	98.4/124.9
L5006	6200009861	S.COI NLV25T-1R5J	T	146.8/114.2
L5011	6140005140	COI LR-571 (T68-6)		
L5012	6140005140	COI LR-571 (T68-6)		
L5013	6140005130	COI LR-570 (T68-6)		
L5021	6140005240	COI LR-581 (T68-6)		
L5022	6140005220	COI LR-579 (T68-6)		
L5023	6140005220	COI LR-579 (T68-6)		
L5031	6140005160	COI LR-573 (T68-6)		
L5032	6140005170	COI LR-574 (T68-6)		
L5033	6140005180	COI LR-575 (T68-6)		
L5041	6140005190	COI LR-576 (T68-6)		
L5042	6140005200	COI LR-577 (T68-6)		
L5043	6140005210	COI LR-578 (T68-6)		
L5051	6140004970	COI LR-549 T68-6		
L5052	6140004980	COI LR-550 T68-6		
L5053	6140004990	COI LR-551 T68-6		
L5061	6140005000	COI LR-552 T68-6		
L5062	6140005010	COI LR-553 T68-6		
L5063	6140005010	COI LR-553 T68-6		
L5071	6140005020	COI LR-554 T68-10		
L5072	6140005030	COI LR-555 T68-10		
L5073	6140005030	COI LR-555 T68-10		
L5081	6140005040	COI LR-556 T68-10		
L5082	6140005050	COI LR-557 T68-10		
L5083	6140005050	COI LR-557 T68-10		
L5101	6140003490	COI LR-391 (TR10X5X5 3A6)		

Eqv.= This component is equivalent to the REF No. component listed above, and may be substituted on parts orders and repairs.

M.=Mounted side (T: Mounted on the Top side, B: Mounted on the Bottom side) S.=Surface mount

[PA UNIT]

REF NO.	PARTS NO.	DESCRIPTION	M.	H/V LOCATION
L5111	6200005051	S.COI NLV25T-330J	B	92.1/20.4
L5112	6200005051	S.COI NLV25T-330J	B	142.5/17.1
L5121	6200005051	S.COI NLV25T-330J	B	92.1/44.3
L5122	6200005051	S.COI NLV25T-330J	B	142.5/41.3
L5131	6200005051	S.COI NLV25T-330J	B	93.1/114.1
L5132	6200005051	S.COI NLV25T-330J	B	142.5/89.8
L5133	6200005011	S.COI NLV25T-100J	T	146.8/100.5
L5141	6200005051	S.COI NLV25T-330J	B	92.1/32.4
L5142	6200005051	S.COI NLV25T-330J	B	142.5/29.2
L5151	6200005051	S.COI NLV25T-330J	B	92.2/56.1
L5152	6200005051	S.COI NLV25T-330J	B	142.5/53.4
L5161	6200005051	S.COI NLV25T-330J	B	93.0/102.2
L5162	6200005051	S.COI NLV25T-330J	B	142.5/77.6
L5171	6200005011	S.COI NLV25T-100J	T	98.0/119.4
L5172	6200005011	S.COI NLV25T-100J	B	142.4/102.2
L5181	6200005011	S.COI NLV25T-100J	B	89.6/68.0
L5182	6200005011	S.COI NLV25T-100J	B	142.5/65.5
R4001	7030003370	S.RES ERJ3GEYJ 271 V (270)	T	55.7/140.8
R4002	7030003230	S.RES ERJ3GEYJ 180 V (18)	T	55.0/143.0
R4003	7030003370	S.RES ERJ3GEYJ 271 V (270)	T	54.2/140.8
R4004	7030003360	S.RES ERJ3GEYJ 221 V (220)	B	13.9/108.9
R4005	7030003300	S.RES ERJ3GEYJ 680 V (68)	T	47.3/146.7
R4006	7030003320	S.RES ERJ3GEYJ 101 V (100)	B	96.2/132.9
R4007	7030003320	S.RES ERJ3GEYJ 101 V (100)	T	97.9/132.2
R4008	7030003320	S.RES ERJ3GEYJ 101 V (100)	B	96.2/131.1
R4009	7030003530	S.RES ERJ3GEYJ 562 V (5.6K)	B	44.8/144.9
R4010	7030003520	S.RES ERJ3GEYJ 472 V (4.7K)	B	48.8/144.2
R4011	7030003370	S.RES ERJ3GEYJ 271 V (270)	T	42.8/147.4
R4012	7030003450	S.RES ERJ3GEYJ 122 V (1.2K)	T	72.1/73.6
R4013	7510001551	S.THE NTCG16 4LH 333JT	T	69.4/75.0
R4014	7030003400	S.RES ERJ3GEYJ 471 V (470)	T	40.9/145.2
R4016	7030000210	S.RES MCR10EZJH 39 (390)	B	42.0/135.5
R4017	7030000210	S.RES MCR10EZJH 39 (390)	B	46.0/135.5
R4018	7030000210	S.RES MCR10EZJH 39 (390)	B	44.0/135.5
R4019	7030000250	S.RES MCR10EZJH 82 (820)	T	30.8/146.1
R4020	7030003550	S.RES ERJ3GEYJ 822 V (8.2K)	T	37.3/143.7
R4021	7030004050	S.RES ERJ3GEYJ 1R0 V (1)	T	21.5/146.5
R4022	7030003410	S.RES ERJ3GEYJ 561 V (560)	T	21.2/132.5
R4023	7030003490	S.RES ERJ3GEYJ 272 V (2.7K)	B	37.3/144.5
R4025	7030003440	S.RES ERJ3GEYJ 102 V (1K)	T	71.5/120.5
R4026	7030010800	S.RES ERJ1TYJ 2R7U (2.7)	T	37.8/137.2
R4027	7030003610	S.RES ERJ3GEYJ 273 V (27K)	T	76.8/122.9
R4028	7030003680	S.RES ERJ3GEYJ 104 V (100K)	T	73.1/123.1
R4029	7030003680	S.RES ERJ3GEYJ 104 V (100K)	T	73.1/120.5
R4031	7030000340	S.RES MCR10EZJH 470 (471)	T	15.2/128.8
R4032	7030003240	S.RES ERJ3GEYJ 220 V (22)	T	77.1/113.2
R4033	7030006450	S.RES MCR50JZHJ 4.7 (4R7)	T	81.8/140.0
R4034	7030000260	S.RES MCR10EZJH 100 (101)	T	40.6/131.4
R4035	7030003570	S.RES ERJ3GEYJ 123 V (12K)	T	41.7/133.5
R4036	7030003440	S.RES ERJ3GEYJ 102 V (1K)	T	43.6/131.4
R4037	7030000320	S.RES MCR10EZJH 330 (331)	T	75.5/112.4
R4038	7030010260	S.RES ERJ1TYJ 3R3 U	B	59.0/86.5
R4039	7030010260	S.RES ERJ1TYJ 3R3 U	T	63.0/86.0
R4040	7030010260	S.RES ERJ1TYJ 3R3 U	T	59.0/86.0
R4041	7030010260	S.RES ERJ1TYJ 3R3 U	B	16.0/86.5
R4042	7030010260	S.RES ERJ1TYJ 3R3 U	T	16.0/86.0
R4043	7030010260	S.RES ERJ1TYJ 3R3 U	T	12.0/86.0
R4044	7030001010	S.RES MCR50JZHJ 10 (100)	T	50.9/75.4
R4045	7030001010	S.RES MCR50JZHJ 10 (100)	T	24.0/75.5
R4046	7070000371	RES ERX2SJ 2R2 (2.2)		
R4047	7070000371	RES ERX2SJ 2R2 (2.2)		
R4049	7030005971	S.RES ERA3YKD 683V (68K)	B	85.6/64.3
R4050	7030005971	S.RES ERA3YKD 683V (68K)	B	80.1/52.6
R4051	7030007661	S.RES ERA3YED 331V (330)	B	82.4/65.2
R4052	7030005981	S.RES ERA3YED 333V (33K)	B	79.3/49.3
R4053	7030005981	S.RES ERA3YED 333V (33K)	B	80.6/65.2
R4054	7030011240	S.RES LRF3W-LF-01-R020F	B	73.9/28.1
R4057	7030011240	S.RES LRF3W-LF-01-R020F	B	73.9/35.1
R4058	7030003440	S.RES ERJ3GEYJ 102 V (1K)	T	78.5/120.8
R4059	7030003360	S.RES ERJ3GEYJ 221 V (220)	B	7.5/123.1
R4060	7030003520	S.RES ERJ3GEYJ 472 V (4.7K)	T	5.6/98.6
R4065	7030010910	S.RES ERJ1TYJ 150U (15)	B	61.1/33.5
R4066	7030010910	S.RES ERJ1TYJ 150U (15)	B	57.4/33.5
R4067	7030010910	S.RES ERJ1TYJ 150U (15)	B	53.7/33.5
R4068	7030003680	S.RES ERJ3GEYJ 104 V (100K)	T	82.4/134.5
R4069	7030003650	S.RES ERJ3GEYJ 563 V (56K)	T	78.5/134.5
R4071	7030003860	S.RES ERJ3GE JPW V	T	79.4/132.4
R4073	7030003680	S.RES ERJ3GEYJ 104 V (100K)	T	74.2/131.0
R4074	7030003650	S.RES ERJ3GEYJ 563 V (56K)	T	73.2/129.0
R4075	7030003680	S.RES ERJ3GEYJ 104 V (100K)	T	75.6/124.9
R4076	7030003650	S.RES ERJ3GEYJ 563 V (56K)	T	77.6/124.2
R4078	7030003400	S.RES ERJ3GEYJ 471 V (470)	T	79.5/124.9
R4079	7030003320	S.RES ERJ3GEYJ 101 V (100)	T	74.4/126.4
R4080	7030010550	S.RES ERJ1TYJ 820U (82)	B	37.5/81.4
R4081	7030010550	S.RES ERJ1TYJ 820U (82)	B	37.6/89.4
R4083	7030003860	S.RES ERJ3GE JPW V	T	111.4/136.6
R5001	7540000250	ABS SA05C 401N		
R5002	7030010650	S.RES ERJ12YJ823U (82K)	B	87.8/129.8
R5003	7030008190	S.RES ERJ12YJ330U (33)	B	112.4/121.4
R5004	7030003560	S.RES ERJ3GEYJ 103 V (10K)	B	103.7/117.6
R5005	7030003860	S.RES ERJ3GE JPW V	B	101.0/117.6
R5006	7030003640	S.RES ERJ3GEYJ 473 V (47K)	B	100.3/119.9
R5007	7030003560	S.RES ERJ3GEYJ 103 V (10K)	B	103.7/125.3
R5008	7030003860	S.RES ERJ3GE JPW V	B	101.0/125.3
R5009	7030003640	S.RES ERJ3GEYJ 473 V (47K)	B	100.3/123.0
R5091	7030003860	S.RES ERJ3GE JPW V	T	146.2/117.2
R5101	7030003320	S.RES ERJ3GEYJ 101 V (100)	T	118.7/125.6
R5102	7030003320	S.RES ERJ3GEYJ 101 V (100)	T	119.3/126.8
R5103	7030003320	S.RES ERJ3GEYJ 101 V (100)	T	122.8/128.4
R5104	7030003320	S.RES ERJ3GEYJ 101 V (100)	T	128.2/130.0
R5105	7030003680	S.RES ERJ3GEYJ 104 V (100K)	T	122.8/130.8
R5106	7030003680	S.RES ERJ3GEYJ 104 V (100K)	T	119.3/129.2
R5107	7030003680	S.RES ERJ3GEYJ 104 V (100K)	T	118.7/123.2

Eqv.= This component is equivalent to the REF No. component listed above, and may be substituted on parts orders and repairs.

[PA UNIT]

REF NO.	PARTS NO.	DESCRIPTION	M.	H/V LOCATION
R5108	7030003480	S.RES ERJ3GEYJ 222 V (2.2K)	T	127.4/132.6
R5109	7030003390	S.RES ERJ3GEYJ 391 V (390)	T	127.1/133.8
R5110	7030003390	S.RES ERJ3GEYJ 391 V (390)	B	120.6/130.5
R5111	7030003520	S.RES ERJ3GEYJ 472 V (4.7K)	B	120.6/134.2
R5112	7030003390	S.RES ERJ3GEYJ 391 V (390)	B	114.9/136.8
R5113	7030003430	S.RES ERJ3GEYJ 821 V (820)	B	117.0/133.5
R5114	7030003520	S.RES ERJ3GEYJ 472 V (4.7K)	B	119.0/133.5
C4001	4030006880	S.CER C1608 JB 1H 472K-T	B	11.3/103.3
C4002	4030006880	S.CER C1608 JB 1H 472K-T	B	103.1/130.2
C4003	4030006880	S.CER C1608 JB 1H 472K-T	B	107.4/136.0
C4004	4030018980	S.CER C1608 JB 1H 104K-T	T	99.5/138.0
C4006	4030006880	S.CER C1608 JB 1H 472K-T	B	11.0/108.9
C4008	4030007120	S.CER C1608 CH 1H 820J-T	T	53.0/140.8
C4009	4030006880	S.CER C1608 JB 1H 472K-T	B	109.0/135.2
C4010	4510008240	S.ELE 100 CE 10 FS	T	5.1/117.4
C4011	4030006880	S.CER C1608 JB 1H 472K-T	B	110.6/130.9
C4012	4030018980	S.CER C1608 JB 1H 104K-T	B	11.4/112.9
C4013	4030006860	S.CER C1608 JB 1H 102K-T	T	8.8/89.2
C4014	4030007120	S.CER C1608 CH 1H 820J-T	T	48.6/144.1
C4015	4030018980	S.CER C1608 JB 1H 104K-T	B	104.6/130.9
C4016	4030018980	S.CER C1608 JB 1H 104K-T	T	48.6/146.7
C4017	4030018980	S.CER C1608 JB 1H 104K-T	B	103.8/136.0
C4018	4030018980	S.CER C1608 JB 1H 104K-T	B	106.1/130.1
C4019	4030006900	S.CER C1608 JB 1H 103K-T	T	47.3/143.1
C4020	4030018980	S.CER C1608 JB 1H 104K-T	B	105.8/135.3
C4021	4030008920	S.CER C1608 JB 1H 473K-T	B	101.6/130.9
C4022	4030018980	S.CER C1608 JB 1H 104K-T	B	46.4/143.3
C4023	4030018980	S.CER C1608 JB 1H 104K-T	T	45.4/147.4
C4024	4030006880	S.CER C1608 JB 1H 472K-T	T	72.1/72.4
C4025	4030018980	S.CER C1608 JB 1H 104K-T	B	46.4/141.7
C4026	4510009190	S.ELE EEEHB1E330P	T	58.1/135.9
C4028	4030018980	S.CER C1608 JB 1H 104K-T	B	59.7/137.1
C4029	4030005110	S.CER C2012 JB 1E 473K-T	T	41.2/140.6
C4030	4030018980	S.CER C1608 JB 1H 104K-T	T	33.6/147.7
C4031	4030018980	S.CER C1608 JB 1H 104K-T	B	59.7/134.2
C4032	4030008920	S.CER C1608 JB 1H 473K-T	T	69.4/77.6
C4033	4030018960	S.CER C3216 JB 1C 106MT-N	B	61.7/134.4
C4034	4030006880	S.CER C1608 JB 1H 472K-T	T	69.4/78.8
C4035	4030006900	S.CER C1608 JB 1H 103K-T	T	37.3/142.5
C4036	4030018980	S.CER C1608 JB 1H 104K-T	T	19.7/133.5
C4037	4030018980	S.CER C1608 JB 1H 104K-T	T	97.6/135.2
C4038	4030004750	S.CER C2012 JB 1H 103K-T	T	35.5/134.5
C4040	4030018980	S.CER C1608 JB 1H 104K-T	B	63.8/128.8
C4042	4030008700	S.CER GRM21BB11H473KA01L (GRM40 B)	B	15.1/128.5
C4043	4030008920	S.CER C1608 JB 1H 473K-T	B	66.2/123.5
C4044	4030008960	S.CER C2012 JB 1C 104K-T	T	30.2/132.5
C4045	4030018980	S.CER C1608 JB 1H 104K-T	T	78.3/114.6
C4046	4030008700	S.CER GRM21BB11H473KA01L (GRM40 B)	T	12.2/120.7
C4047	4030018980	S.CER C1608 JB 1H 104K-T	B	66.2/127.3
C4048	4030006900	S.CER C1608 JB 1H 103K-T	T	42.9/133.5
C4049	4030021380	S.CER C5750 JB 2E 684MT	B	28.7/110.4
C4050	4510009680	S.ELE EEEFK1E471P	T	14.4/110.4
C4052	4030018980	S.CER C1608 JB 1H 104K-T	T	27.3/94.9
C4053	4510007250	ELE 25 ME 1000 AX		
C4054	4510008470	ELE 10 ME 1000 CX		
C4055	4320000220	DIP DM19C 681J5		
C4056	4030008920	S.CER C1608 JB 1H 473K-T	T	56.8/107.9
C4059	4030006880	S.CER C1608 JB 1H 472K-T	T	70.2/87.4
C4061	4030018350	S.CER GRM31A5C2J151JW01D	T	37.5/80.4
C4062	4030011760	S.CER GRM55R1X2D682JV01L (GRM44-1)	T	51.0/86.5
C4065	4030011760	S.CER GRM55R1X2D682JV01L (GRM44-1)	T	24.0/86.5
C4067	4030018980	S.CER C1608 JB 1H 104K-T	T	82.9/98.1
C4068	4030018980	S.CER C1608 JB 1H 104K-T	T	8.3/70.2
C4071	4030020730	S.CER GRM31A5C2J471JW01D	T	65.4/57.1
C4072	4030018370	S.CER ERF22X 6C1H 102J D01L	T	37.0/58.5
C4073	4030020730	S.CER GRM31A5C2J471JW01D	T	8.5/51.0
C4074	4030006880	S.CER C1608 JB 1H 472K-T	B	80.1/51.2
C4075	4030011740	S.CER GRM32N2C2H201JV01L (GRM42-2)	T	71.6/56.5
C4076	4030018230	S.CER ERF22X 6C2D 221JD	T	37.0/55.2
C4077	4030011740	S.CER GRM32N2C2H201JV01L (GRM42-2)	T	8.5/48.0
C4078	4030018230	S.CER ERF22X 6C2D 221JD	T	37.0/51.9
C4080	4030020730	S.CER GRM31A5C2J471JW01D	T	37.5

[PA UNIT]

REF NO.	PARTS NO.	DESCRIPTION	M.	H/V LOCATION
C4124	4030006900	S.CER C1608 JB 1H 103K-T	T	122.4/134.6
C5001	4030021380	S.CER C5750 JB 2E 684MT	T	89.0/128.6
C5011	4030011600	S.CER C1608 JB 1E 104K-T	B	89.0/17.5
C5012	4030011600	S.CER C1608 JB 1E 104K-T	T	146.2/24.5
C5013	4030008920	S.CER C1608 JB 1H 473K-T	T	146.2/21.8
C5021	4030011600	S.CER C1608 JB 1E 104K-T	B	89.0/41.3
C5022	4030011600	S.CER C1608 JB 1E 104K-T	T	146.2/48.7
C5023	4030008920	S.CER C1608 JB 1H 473K-T	T	146.2/46.0
C5031	4030006880	S.CER C1608 JB 1H 472K-T	B	89.8/111.2
C5032	4030006880	S.CER C1608 JB 1H 472K-T	T	146.2/97.4
C5033	4030006880	S.CER C1608 JB 1H 472K-T	T	146.2/94.7
C5041	4030006880	S.CER C1608 JB 1H 472K-T	B	89.0/29.4
C5042	4030006880	S.CER C1608 JB 1H 472K-T	T	146.2/36.6
C5043	4030006880	S.CER C1608 JB 1H 472K-T	T	146.2/33.9
C5051	4030006880	S.CER C1608 JB 1H 472K-T	B	89.0/53.2
C5052	4030006880	S.CER C1608 JB 1H 472K-T	T	146.2/60.8
C5053	4030006880	S.CER C1608 JB 1H 472K-T	T	146.2/58.1
C5061	4030006880	S.CER C1608 JB 1H 472K-T	B	89.8/99.3
C5062	4030006880	S.CER C1608 JB 1H 472K-T	T	146.2/85.1
C5063	4030006880	S.CER C1608 JB 1H 472K-T	T	146.2/82.4
C5071	4030006880	S.CER C1608 JB 1H 472K-T	B	93.3/122.4
C5072	4030006880	S.CER C1608 JB 1H 472K-T	T	146.2/109.6
C5073	4030006880	S.CER C1608 JB 1H 472K-T	T	146.2/107.0
C5081	4030006880	S.CER C1608 JB 1H 472K-T	B	89.0/65.1
C5082	4030006880	S.CER C1608 JB 1H 472K-T	T	146.2/73.0
C5083	4030006880	S.CER C1608 JB 1H 472K-T	T	146.2/70.3
C5101	4030007120	S.CER C1608 CH 1H 820J-T	T	138.6/131.3
C5102	4030006990	S.CER C1608 CH 1H 080D-T	T	138.6/130.1
C5103	4030007150	S.CER C1608 CH 1H 151J-T	T	136.6/130.7
C5104	4030009990	S.CER C1608 CH 1H 200J-T	T	134.7/130.3
C5105	4030007110	S.CER C1608 CH 1H 680J-T	T	134.7/131.5
C5106	4030006880	S.CER C1608 JB 1H 472K-T	B	138.1/115.6
C5107	4030006880	S.CER C1608 JB 1H 472K-T	T	140.1/117.9
C5108	4030006880	S.CER C1608 JB 1H 472K-T	T	143.6/129.7
C5109	4030006880	S.CER C1608 JB 1H 472K-T	T	147.4/117.2
C5110	4610001590	S.TRI TZC3R100A110R00 (TZC03R100A110)	T	104.1/119.5
C5111	4030018480	S.CER GRM31A5C2J221JW01D	T	101.0/119.4
C5112	4030006870	S.CER C1608 JB 1H 222K-T	B	109.0/119.9
C5113	4030006870	S.CER C1608 JB 1H 222K-T	B	109.0/123.0
C5114	4030011340	S.CER C1608 CH 1H 471J-T	B	102.7/119.9
C5115	4030011340	S.CER C1608 CH 1H 471J-T	B	102.7/123.0
C5116	4030011600	S.CER C1608 JB 1E 104K-T	T	131.5/125.5
C5125	4030007090	S.CER C1608 CH 1H 470J-T	T	122.8/129.6
C5126	4030007090	S.CER C1608 CH 1H 470J-T	T	119.3/128.0
C5127	4030007090	S.CER C1608 CH 1H 470J-T	T	118.7/124.4
C5129	4030006860	S.CER C1608 JB 1H 102K-T	T	128.2/128.4
C5140	4030011600	S.CER C1608 JB 1E 104K-T	T	125.6/128.4
C5201	4030021220	S.CER GRM31B5C2J681JW01L	B	97.1/13.6
C5202	4030018480	S.CER GRM31A5C2J221JW01D	B	99.3/13.6
C5203	4030018480	S.CER GRM31A5C2J221JW01D	B	101.5/13.6
C5204	4030020730	S.CER GRM31A5C2J471JW01D	B	105.5/11.7
C5205	4030021020	S.CER GRM31A5C2J101JW01D	B	105.5/9.4
C5206	4030021230	S.CER GRM31B5C2J102JW01L	B	106.9/15.3
C5207	4030021220	S.CER GRM31B5C2J681JW01L	B	109.1/15.3
C5208	4030021020	S.CER GRM31A5C2J101JW01D	B	111.3/15.3
C5209	4030021220	S.CER GRM31B5C2J681JW01L	B	115.2/11.6
C5210	4030021020	S.CER GRM31A5C2J101JW01D	B	115.2/9.4
C5211	4030021230	S.CER GRM31B5C2J102JW01L	B	116.7/15.3
C5212	4030021220	S.CER GRM31B5C2J681JW01L	B	119.7/13.6
C5213	4030020820	S.CER GRM31A5C2J121JW01D	B	129.9/5.8
C5214	4030021010	S.CER GRM31A5C2J390JW01D	B	127.7/5.8
C5215	4030021230	S.CER GRM31B5C2J102JW01L	B	125.5/11.6
C5216	4030020820	S.CER GRM31A5C2J121JW01D	B	127.7/11.6
C5217	4030018480	S.CER GRM31A5C2J221JW01D	B	130.5/13.9
C5218	4030020820	S.CER GRM31A5C2J121JW01D	B	113.5/15.3
C5219	4030018480	S.CER GRM31A5C2J221JW01D	B	122.0/12.8
C5221	4030021220	S.CER GRM31B5C2J681JW01L	B	96.2/41.7
C5222	4030020820	S.CER GRM31A5C2J121JW01D	B	98.6/42.9
C5224	4030021020	S.CER GRM31A5C2J101JW01D	B	102.4/40.8
C5225	4030021200	S.CER GRM31A5C2J120JW01D	B	102.4/38.6
C5226	4030021230	S.CER GRM31B5C2J102JW01L	B	103.9/44.5
C5227	4030018480	S.CER GRM31A5C2J221JW01D	B	106.1/42.8
C5228	4030018480	S.CER GRM31A5C2J221JW01D	B	108.3/42.8
C5229	4030018340	S.CER GRM31A5C2J331JW01D	B	112.3/43.0
C5230	4030018480	S.CER GRM31A5C2J221JW01D	B	112.3/40.8
C5231	4030021230	S.CER GRM31B5C2J102JW01L	B	118.6/37.8
C5232	4030020820	S.CER GRM31A5C2J121JW01D	B	120.8/37.8
C5233	4030020780	S.CER GRM31A5C2J470JW01D	B	123.0/37.8
C5234	4030018340	S.CER GRM31A5C2J331JW01D	B	127.7/36.3
C5236	4030020730	S.CER GRM31A5C2J471JW01D	B	129.9/41.8
C5241	4030020730	S.CER GRM31A5C2J471JW01D	B	99.1/101.7
C5242	4030018480	S.CER GRM31A5C2J221JW01D	B	101.3/101.7
C5243	4030020800	S.CER GRM31A5C2J680JW01D	B	102.9/95.8
C5245	4030020730	S.CER GRM31A5C2J471JW01D	B	106.7/100.0
C5246	4030020730	S.CER GRM31A5C2J471JW01D	B	108.9/100.0
C5247	4030018340	S.CER GRM31A5C2J331JW01D	B	112.7/95.8
C5249	4030021220	S.CER GRM31B5C2J681JW01L	B	118.7/96.0
C5250	4030018480	S.CER GRM31A5C2J221JW01D	B	120.9/99.0
C5251	4030020810	S.CER GRM31A5C2J820JW01D	B	123.1/94.3
C5252	4030018480	S.CER GRM31A5C2J221JW01D	B	127.8/93.5
C5253	4030011290	S.CER GRM31M2C2H240JV01L (GRM42-6)	B	125.6/93.5
C5254	4030018340	S.CER GRM31A5C2J331JW01D	B	129.9/98.1
C5255	4030020820	S.CER GRM31A5C2J121JW01D	B	132.1/98.1
C5261	4030020730	S.CER GRM31A5C2J471JW01D	B	102.5/30.2
C5262	4030020740	S.CER GRM31A5C2J180JW01D	B	104.7/30.2
C5263	4030020780	S.CER GRM31A5C2J470JW01D	B	107.4/24.5
C5265	4030018340	S.CER GRM31A5C2J331JW01D	B	113.6/24.5
C5266	4030018480	S.CER GRM31A5C2J221JW01D	B	119.9/24.3
C5267	4030021020	S.CER GRM31A5C2J101JW01D	B	123.9/22.3
C5268	4030021020	S.CER GRM31A5C2J101JW01D	B	123.9/20.1
C5269	4030020730	S.CER GRM31A5C2J471JW01D	B	125.5/26.0
C5270	4030020800	S.CER GRM31A5C2J680JW01D	B	127.7/26.0
C5271	4030020770	S.CER GRM31A5C2J330JW01D	B	130.0/27.6

Eqv.= This component is equivalent to the REF No. component listed above, and may be substituted on parts orders and repairs.

[PA UNIT]

REF NO.	PARTS NO.	DESCRIPTION	M.	H/V LOCATION
C5272	4030020820	S.CER GRM31A5C2J121JW01D	B	132.8/23.9
C5274	4030020800	S.CER GRM31A5C2J680JW01D	B	133.8/27.6
C5275	4030018480	S.CER GRM31A5C2J221JW01D	B	136.0/27.6
C5281	4030018480	S.CER GRM31A5C2J221JW01D	B	112.3/59.0
C5282	4030018350	S.CER GRM31A5C2J151JW01D	B	112.3/56.8
C5283	4030011200	S.CER GRM31M2C2H300JV01L (GRM42-6)	B	107.1/53.1
C5285	4030020770	S.CER GRM31A5C2J471JW01D	B	116.0/52.4
C5286	4030020730	S.CER GRM31A5C2J330JW01D	B	113.8/52.4
C5287	4030020820	S.CER GRM31A5C2J121JW01D	B	122.5/50.8
C5288	4030011200	S.CER GRM31M2C2H300JV01L (GRM42-6)	B	122.5/48.5
C5289	4030021230	S.CER GRM31A5C2J471JW01D	B	126.4/54.5
C5291	4030021020	S.CER GRM31A5C2J101JW01D	B	132.7/50.7
C5292	4030021000	S.CER GRM31A5C2J100JW01D	B	132.7/48.5
C5293	4030018480	S.CER GRM31A5C2J221JW01D	B	132.7/55.8
C5294	4030021210	S.CER GRM31A5C2J150JW01D	B	132.7/58.0
C5301	4030020820	S.CER GRM31A5C2J121JW01D	B	108.4/87.0
C5302	4030020810	S.CER GRM31A5C2J820JW01D	B	108.9/84.8
C5303	4030020750	S.CER GRM31A5C2J220JW01D	B	105.1/81.1
C5305	4030018340	S.CER GRM31A5C2J331JW01D	B	116.2/82.2
C5307	4030021020	S.CER GRM31A5C2J101JW01D	B	122.3/79.5
C5309	4030018480	S.CER GRM31A5C2J221JW01D	B	126.4/83.2
C5310	4030020810	S.CER GRM31A5C2J820JW01D	B	128.6/83.2
C5311	4030020780	S.CER GRM31A5C2J470JW01D	B	132.4/79.5
C5312	4030020770	S.CER GRM31A5C2J330JW01D	B	132.4/77.3
C5313	4030020810	S.CER GRM31A5C2J820JW01D	B	135.3/84.2
C5314	4030020810	S.CER GRM31A5C2J820JW01D	B	137.5/84.2
C5321	4030020820	S.CER GRM31A5C2J121JW01D	B	97.0/111.8
C5323	4030011110	S.CER GRM31M2C2H9R0DV01L (GRM42-6)	B	107.5/110.8
C5325	4030021020	S.CER GRM31A5C2J101JW01D	B	113.0/110.8
C5326	4030021210	S.CER GRM31A5C2J150JW01D	B	115.2/109.3
C5327	4030021010	S.CER GRM31A5C2J390JW01D	B	122.3/107.8
C5328	4030021010	S.CER GRM31A5C2J390JW01D	B	122.3/105.6
C5329	4030021020	S.CER GRM31A5C2J101JW01D	B	125.0/111.4
C5330	4030021210	S.CER GRM31A5C2J150JW01D	B	127.4/111.4
C5331	4030021200	S.CER GRM31A5C2J120JW01D	B	132.3/105.8
C5332	4030021000	S.CER GRM31A5C2J100JW01D	B	132.3/108.0
C5333	4030021020	S.CER GRM31A5C2J101JW01D	B	135.9/111.3
C5334	4030021200	S.CER GRM31A5C2J120JW01D	B	138.5/110.2
C5341	4030020780	S.CER GRM31A5C2J470JW01D	B	86.7/61.8
C5343	4030021210	S.CER GRM31A5C2J150JW01D	B	97.9/70.8
C5345	4030020780	S.CER GRM31A5C2J470JW01D	B	105.1/70.7
C5346	4030020750	S.CER GRM31A5C2J220JW01D	B	107.7/69.3
C5347	4030020760	S.CER GRM31A5C2J270JW01D	B	107.3/63.0
C5348	4030020760	S.CER GRM31A5C2J270JW01D	B	105.1/63.0
C5349	4030020780	S.CER GRM31A5C2J470JW01D	B	120.2/64.9
C5350	4030020760	S.CER GRM31A5C2J270JW01D	B	122.4/64.9
C5351	4030020740	S.CER GRM31A5C2J180JW01D	B	127.6/64.9
C5352	4030021210	S.CER GRM31A5C2J150JW01D	B	125.4/65.0
C5353	4030020780	S.CER GRM31A5C2J470JW01D	B	123.2/68.9
C5355	4030021020	S.CER GRM31A5C2J101JW01D	B	111.1/101.6
C5356	4030020760	S.CER GRM31A5C2J270JW01D	B	112.3/38.6
C5357	4030011600	S.CER C1608 JB 1E 104K-T	T	128.2/131.4
C5358	4030011600	S.CER C1608 JB 1E 104K-T	B	119.0/129.8
C5359	4030011600	S.CER C1608 JB 1E 104K-T	B	117.0/136.8
C5360	4030011600	S.CER C1608 JB 1E 104K-T	B	130.4/131.5
RL4001	6330001960	REL ETR-GCJ-SH-112DMZ <SLVJ>		
RL5001	6330001750	REL FTR-B4CA012Z		
RL5011	6330001750	REL FTR-B4CA012Z		
RL5012	6330001750	REL FTR-B4CA012Z		
RL5021	6330001750	REL FTR-B4CA012Z		
RL5022	6330001750	REL FTR-B4CA012Z		
RL5031	6330001750	REL FTR-B4CA012Z		
RL5032	6330001750	REL FTR-B4CA012Z		
RL5041	6330001750	REL FTR-B4CA012Z		
RL5042	6330001750	REL FTR-B4CA012Z		
RL5051	633000			

[PA UNIT]

REF NO.	PARTS NO.	DESCRIPTION	M.	H/V LOCATION
EP4005	6910020710	E.O OT-047 M3		
EP5002	6910018930	S.BEA MPZ2012S601A	T	125.3/130.7

[DRIVER UNIT]

REF NO.	PARTS NO.	DESCRIPTION	M.	H/V LOCATION
Q6851	1590003061	S.FET PD55015-E	T	9.7/20.0
R6851	7030010480	S.RES ERJ1TYJ 181U (180)	T	8.2/13.1
R6852	7030000020	S.RES MCR10EZHZ 1 (010)	T	2.0/15.4
C6851	4030004750	S.CER C2012 JB 1H 103K-T	T	14.1/14.1

Eqv.= This component is equivalent to the REF No. component listed above, and may be substituted on parts orders and repairs.

M.=Mounted side (T: Mounted on the Top side, B: Mounted on the Bottom side)
S.=Surface mount

[VARISTOR-1 UNIT]

REF NO.	PARTS NO.	DESCRIPTION	M.	H/V LOCATION
D6431	1750000940	S.DIO 1SS400 TE61	T	3.5/13.4
C6431	4030008920	S.CER C1608 JB 1H 473K-T	T	3.7/11.7

[VARISTOR-2 UNIT]

REF NO.	PARTS NO.	DESCRIPTION	M.	H/V LOCATION
D6431	1750000940	S.DIO 1SS400 TE61	T	3.5/13.4
C6431	4030008920	S.CER C1608 JB 1H 473K-T	T	3.7/11.7

Eqv.= This component is equivalent to the REF No. component listed above, and may be substituted on parts orders and repairs.

M.=Mounted side (T: Mounted on the Top side, B: Mounted on the Bottom side)
S.=Surface mount

[DSP-1 UNIT]

REF NO.	PARTS NO.	DESCRIPTION	M.	H/V LOCATION
IC3001	1110003800	S.IC NJM2904V-TE1-#FMZB	B	63.0/22.7
IC3003	1110008270	S.IC AD8692ARMZ-R7 <FE>	B	54.6/35.9
IC3004	1110008270	S.IC AD8692ARMZ-R7 <FE>	B	87.3/16.3
IC3005	1130008511	S.IC TC7W53FU(TE12LF)	B	64.9/34.2
IC3008	1110007690	S.IC NJW1184M-TE1-#ZZZB	B	74.3/26.2
IC3011	1110003091	IC LA4425A-E		
IC3012	1130011760	S.IC CD4094BPPWR	B	130.6/14.0
IC3013	1180003750	S.REG NJM2370U1-09-TE1-#ZZZB	B	84.8/5.7
IC3601	1110008250	S.IC ADA4075-2ARZ-R7 <FE>	B	64.1/13.9
IC3602	1110008250	S.IC ADA4075-2ARZ-R7 <FE>	B	64.1/5.1
IC3603	1110008250	S.IC ADA4075-2ARZ-R7 <FE>	B	52.3/5.1
IC3604	1110008250	S.IC ADA4075-2ARZ-R7 <FE>	B	45.0/27.6
IC3605	1110008250	S.IC ADA4075-2ARZ-R7 <FE>	B	33.2/27.9
IC3607	1110008250	S.IC ADA4075-2ARZ-R7 <FE>	B	32.0/36.8
IC3608	1110007000	S.IC PCM4202DBR	B	26.9/15.8
IC3610	1130015150	S.IC CY22381FXC(SX-3073G)	B	14.4/19.5
IC3611	1190002650	S.IC AK4620BVPF-E2/P	B	20.1/33.5
IC3612	1130011930	S.IC SN74LVC1604DCKR	T	12.1/16.4
IC3613	1110004770	S.IC BU9480F-E2	B	22.7/25.1
IC3614	1110008250	S.IC ADA4075-2ARZ-R7 <FE>	B	41.2/18.6
IC3615	1110008250	S.IC ADA4075-2ARZ-R7 <FE>	B	45.4/36.4
IC3616	1130015440	S.IC TC7S07FU(TE85LF)	B	20.2/13.4
IC3617	1110008000	S.IC AD8599ARZ-REEL7 <FE>	B	52.3/13.9
IC3623	1130016700	S.IC ADM101EARMZ-REEL7 <FE>	B	130.0/24.4
IC3624	1130008511	S.IC TC7W53FU(TE12LF)	B	105.7/14.7
IC3625	1130008511	S.IC TC7W53FU(TE12LF)	B	113.8/15.1
IC3629	1110008270	S.IC AD8692ARMZ-R7 <FE>	B	106.4/19.2
Q3009	1590002420	S.TRA UMD3N TR	B	81.4/23.5
Q3011	1590000680	S.TRA DTC114EUA T106	B	133.1/38.5
Q3012	1590003770	S.TRA KRA302E-RTK/P	B	94.7/8.5
Q3013	1590002310	S.TRA DTC114EE TL	B	131.4/30.9
Q3014	1530004210	S.TRA DSC7004SOL	B	90.8/4.8
D3004	1750001810	S.DIO L1SS400T1G <SLVJ>	T	65.4/32.8
D3008	1750001810	S.DIO L1SS400T1G <SLVJ>	B	129.8/31.1
D3009	1750001320	S.DIO KDS4148U RTK/P	T	130.4/11.0
D3601	1750001320	S.DIO KDS4148U RTK/P	T	60.8/15.2
D3602	1750001320	S.DIO KDS4148U RTK/P	T	63.4/15.0
D3603	1750002210	S.DIO DA2S00100L	T	50.4/14.7
D3604	1750002210	S.DIO DA2S00100L	T	48.2/16.1
D3606	1750000370	S.DIO DA221 TL	B	126.7/41.1
D3607	1750000370	S.DIO DA221 TL	B	126.5/44.1
D3608	1750000370	S.DIO DA221 TL	B	127.5/29.5
D3609	1750001810	S.DIO L1SS400T1G <SLVJ>	B	126.6/31.6
L3002	6200003950	S.COI HF50ACC 322513-T	B	122.1/16.0
L3003	6200003950	S.COI HF50ACC 322513-T	B	122.1/19.6
L3004	6200002041	S.COI NLV25T-101J	T	65.0/36.8
L3005	6140002220	COI LR-270 (TR6X3X2 3A9)		
L3006	6200003950	S.COI HF50ACC 322513-T	B	122.1/12.6
L3601	6200001831	S.COI NLV32T-100J	T	22.9/21.3
L3602	6200001831	S.COI NLV32T-100J	T	19.9/15.3
L3603	6200001831	S.COI NLV32T-100J	T	22.9/37.2
L3604	6200001831	S.COI NLV32T-100J	T	25.7/32.8
L3605	6200001831	S.COI NLV32T-100J	T	22.5/27.0
L3606	6200001831	S.COI NLV32T-100J	T	18.7/21.3
L3607	6200003261	S.COI NLV32T-101J	B	130.3/43.8
L3608	6200003950	S.COI HF50ACC 322513-T	B	133.3/43.8
L3609	6200008820	S.COI HF70ACC 635050-T	T	134.9/29.7
L3610	6200003950	S.COI HF50ACC 322513-T	B	122.5/27.2
L3611	6200003950	S.COI HF50ACC 322513-T	B	136.3/43.8
R3004	7030010040	S.RES ERJ2GGEJ-JPW	T	92.4/18.7
R3005	7030005050	S.RES ERJ2GGEJ 103 X (10K)	T	91.9/17.5
R3007	7030005040	S.RES ERJ2GGEJ 472 X (4.7K)	T	63.2/20.0
R3009	7030005050	S.RES ERJ2GGEJ 103 X (10K)	T	64.2/21.8
R3011	7030005240	S.RES ERJ2GGEJ 473 X (47K)	T	62.7/22.2
R3012	7030005240	S.RES ERJ2GGEJ 473 X (47K)	T	63.8/23.1
R3013	7030005240	S.RES ERJ2GGEJ 473 X (47K)	T	61.8/22.2
R3014	7030005040	S.RES ERJ2GGEJ 472 X (4.7K)	B	126.7/38.9
R3015	7030005120	S.RES ERJ2GGEJ 102 X (1K)	B	133.1/36.4
R3016	7030005240	S.RES ERJ2GGEJ 473 X (47K)	T	52.1/34.1
R3017	7030005060	S.RES ERJ2GGEJ 333 X (33K)	T	52.5/35.3
R3018	7030004980	S.RES ERJ2GGEJ 101 X (10K)	T	54.6/38.5
R3019	7030005050	S.RES ERJ2GGEJ 103 X (10K)	T	53.1/32.9
R3021	7030005090	S.RES ERJ2GGEJ 104 X (100K)	T	53.7/34.1
R3023	7030010040	S.RES ERJ2GGEJ-JPW	T	91.9/15.8
R3024	7030007350	S.RES ERJ2GGEJ 393 X (39K)	T	91.5/13.3
R3025	7030004980	S.RES ERJ2GGEJ 101 X (10K)	B	62.8/36.4
R3026	7030005060	S.RES ERJ2GGEJ 333 X (33K)	T	55.3/33.5
R3027	7030005040	S.RES ERJ2GGEJ 472 X (4.7K)	T	52.9/36.7
R3029	7030005160	S.RES ERJ2GGEJ 105 X (1M)	T	63.7/32.7
R3031	7030005120	S.RES ERJ2GGEJ 102 X (1K)	T	56.7/34.5
R3032	7030005040	S.RES ERJ2GGEJ 472 X (4.7K)	T	52.1/37.6
R3033	7030005120	S.RES ERJ2GGEJ 102 X (1K)	T	88.3/19.3
R3034	7030005240	S.RES ERJ2GGEJ 473 X (47K)	B	87.8/12.8
R3035	7030005060	S.RES ERJ2GGEJ 333 X (33K)	T	91.0/14.9
R3037	7030009290	S.RES ERJ2GGEJ 562 X (5.6K)	T	91.0/16.5
R3038	7030005050	S.RES ERJ2GGEJ 103 X (10K)	T	62.9/35.9
R3040	7030005240	S.RES ERJ2GGEJ 473 X (47K)	T	51.6/38.8
R3041	7030005090	S.RES ERJ2GGEJ 104 X (100K)	T	86.5/16.1
R3042	7030005050	S.RES ERJ2GGEJ 103 X (10K)	T	60.9/36.6
R3043	7030004970	S.RES ERJ2GGEJ 470 X (47)	T	62.8/34.3
R3044	7030004980	S.RES ERJ2GGEJ 101 X (10K)	B	57.2/39.3
R3045	7030005240	S.RES ERJ2GGEJ 473 X (47K)	T	51.6/36.3
R3047	7030005050	S.RES ERJ2GGEJ 103 X (10K)	T	67.5/35.9
R3049	7030004980	S.RES ERJ2GGEJ 101 X (10K)	B	85.2/13.1
R3051	7030005040	S.RES ERJ2GGEJ 472 X (4.7K)	T	67.5/36.8
R3052	7030005040	S.RES ERJ2GGEJ 472 X (4.7K)	B	67.2/36.3
R3053	7030007300	S.RES ERJ2GGEJ 332 X (3.3K)	T	67.5/35.0

Eqv.= This component is equivalent to the REF No. component listed above, and may be substituted on parts orders and repairs.

[DSP-1 UNIT]

REF NO.	PARTS NO.	DESCRIPTION	M.	H/V LOCATION
R3056	7030005120	S.RES ERJ2GGEJ 102 X (1K)	T	66.6/31.6
R3057	7030010040	S.RES ERJ2GGEJ-JPW	T	85.0/19.0
R3066	7030005040	S.RES ERJ2GGEJ 472 X (4.7K)	B	71.0/31.7
R3067	7030005120	S.RES ERJ2GGEJ 102 X (1K)	B	82.3/34.8
R3070	7030005040	S.RES ERJ2GGEJ 472 X (4.7K)	B	72.9/31.7
R3074	7030010250	S.RES ERJ1TYJ 0R00U	B	100.9/34.7
R3075	7030010040	S.RES ERJ2GGEJ-JPW	T	96.6/25.6
R3077	7030005000	S.RES ERJ2GGEJ 471 X (4.7K)	B	112.4/25.8
R3078	7030009320	S.RES ERJ2GGEJ 4R7 X (4.7)	B	90.5/36.0
R3081	7030005090	S.RES ERJ2GGEJ 104 X (100K)	T	87.9/17.6
R3082	7030004980	S.RES ERJ2GGEJ 101 X (10K)	B	65.6/26.1
R3083	7030010040	S.RES ERJ2GGEJ-JPW	T	76.7/30.1
R3084	7030004980	S.RES ERJ2GGEJ 101 X (10K)	B	81.0/9.3
R3086	7030005040	S.RES ERJ2GGEJ 472 X (4.7K)	T	61.9/25.1
R3087	7030005240	S.RES ERJ2GGEJ 473 X (47K)	T	60.6/24.0
R3088	7030007340	S.RES ERJ2GGEJ 153 X (15K)	T	63.8/25.1
R3090	7030010040	S.RES ERJ2GGEJ-JPW	B	133.4/19.3
R3091	7030004980	S.RES ERJ2GGEJ 101 X (10K)	B	133.8/18.1
R3095	7540000380	S.ABS EZAEG2A50AX	T	123.5/32.1
R3100	7540000380	S.ABS EZAEG2A50AX	T	119.7/40.1
R3101	7540000380	S.ABS EZAEG2A50AX	T	121.4/40.1
R3102	7540000380	S.ABS EZAEG2A50AX	T	123.1/40.1
R3106	7540000380	S.ABS EZAEG2A50AX	T	128.8/32.1
R3108	7540000380	S.ABS EZAEG2A50AX	T	126.3/32.1
R3110	7540000380	S.ABS EZAEG2A50AX	T	124.5/32.1
R3111	7540000380	S.ABS EZAEG2A50AX	T	122.0/32.1
R3112	7540000380	S.ABS EZAEG2A50AX	T	121.0/32.1
R3113	7540000380	S.ABS EZAEG2A50AX	T	120.0/32.1
R3601	7030005321	S.RES ERA3YED 103V (10K)	T	65.5/6.6
R3602	7030009591	S.RES ERA3YED 472V (4.7K)	T	65.5/8.2
R3603	7030004980	S.RES ERJ2GGEJ 101 X (10K)	B	60.6/2.1
R3604	7030004980	S.RES ERJ2GGEJ 101 X (10K)	B	68.6/9.7
R3605	7030009140	S.RES ERJ2GGEJ 272 X (2.7K)	T	65.8/4.5
R3606	7030010040	S.RES ERJ2GGEJ-JPW	T	85.0/18.1
R3607	7030005120	S.RES ERJ2GGEJ 102 X (1K)	T	62.5/27.8
R3608	7030003700	S.RES ERJ3GGEY154 V (150K)	T	62.8/7.7
R3609	7030009140	S.RES ERJ2GGEJ 272 X (2.7K)	T	64.2/4.5
R3610	7030004980	S.RES ERJ2GGEJ 101 X (10K)	B	67.8/17.8
R3611	7030004980	S.RES ERJ2GGEJ 101 X (10K)	B	60.3/9.7
R3612	7030005321	S.RES ERA3YED 103V (10K)	T	62.9/13.5
R3613	7030009591	S.RES ERA3YED 472V (4.7K)	T	62.7/11.1
R3615	7030005321	S.RES ERA3YED 103V (10K)	T	65.5/13.4
R3616	7030004980	S.RES ERJ2GGEJ 101 X (10K)	B	48.1/2.0
R3617	7030004980	S.RES ERJ2GGEJ 101 X (10K)	B	56.0/8.4
R3618	7030006601	S.RES ERA3YED 272V (2.7K)	T	56.8/3.9
R3619	7030005120	S.RES ERJ2GGEJ 102 X (1K)	T	55.1/4.8
R3620	7030006601	S.RES ERA3YED 272V (2.7K)	T	53.6/8.1
R3621	7030005120	S.RES ERJ2GGEJ 102 X (1K)	T	55.1/6.4
R3622	7030005120	S.RES ERJ2GGEJ 102 X (1K)	T	60.7/13.0
R3623	7030005120	S.RES ERJ2GGEJ 102 X (1K)	T	65.8/14.2
R3624	7030005090	S.RES ERJ2GGEJ 104 X (100K)	T	56.1/28.1
R3625	7030005120	S.RES ERJ2GGEJ 102 X (1K)	T	52.5/4.5
R3626	7030005120	S.RES ERJ2GGEJ 102 X (1K)	T	51.2/5.8
R3627	7030005240	S.RES ERJ2GGEJ 473 X (47K)	T	63.4/17.3
R3630	7030004980	S.RES ERJ2GGEJ 101 X (10K)	T	50.7/4.0
R3631	7030004980	S.RES ERJ2GGEJ 101 X (10K)	T	49.3/7.6
R3632	7030004980	S.RES ERJ2GGEJ 101 X (10K)	B	40.8/24.3
R3633	7030004980	S.RES ERJ2GGEJ 101 X (10K)	B	49.1/31.2
R3636	7030005120	S.RES ERJ2GGEJ 102 X (1K)	T	65.8/15.8
R3637	7030008280	S.RES ERJ2GGEJ 271 X (27K)	T	53.8/17.0
R3638	7030005090	S.RES ERJ2GGEJ 104 X (100K)	T	52.6/17.5
R3639	7030005040	S.RES ERJ2GGEJ 472 X (4.7K)	T	54.0/15.8
R3640	7030004980	S.RES ERJ2GGEJ 101 X (10K)	B	29.7/24.6
R3641	7030004980	S.RES ERJ2GGEJ 101 X (10K)	B	36.7/31.4
R3643	7030005290	S.RES ERJ2GGEJ 682 X (6.8K)	T	50.7/13.6
R3644	7030004980	S.RES ERJ2GGEJ 101 X (10K)	T	50.7/12.7
R3646	7030004980	S.RES ERJ2GGEJ 101 X (10K)	B	29.6/31.9
R3647	7030004980	S.RES ERJ2GGEJ 101 X (10K)	B	35.8/40.0
R3648	7030007290	S.RES ERJ2GGEJ 222 X (2.2K)	T	49.7/25.8
R3649	7030005050	S.RES ERJ2GGEJ 103 X (10K)	T	50.7/11.2
R3650	7030010040	S.RES ERJ2GGEJ-JPW	T	49.7/24.9
R3651	7030008300	S.RES ERJ2GGEJ 184 X (180K)	T	51.0/17.5
R3652	7030007280	S.RES ERJ2GGEJ 331 X (33K)	T	49.7/17.0
R3653	7030006601	S.RES ERA3YED 272V (2.7K)	T	47.6/24.9
R3654	7030006601	S.RES ERA3YED 272V (2.7K)	T	46.4/28.5
R3655	7030005240	S.RES ERJ2GGEJ 473 X (47K)	B	23.3/10.7
R3656	7030006601	S.RES ERA3YED 272V (2.7K)	T	45.0/24.9
R3657	7030006601	S.RES ERA3YED 272V (2.7K)	T	43.6/29.2
R3658	7030009591	S.RES ERA3YED 472V (4.7K)	T	38.0/26.9
R3659	7030005321	S.RES ERA3YED 103V (10K)	T	33.3/30.8
R3660	7030005321	S.RES ERA3YED 103V (10K)	T	34.2/24.9
R3661	7030009591	S.RES ERA3YED 472V (4.		

[DSP-1 UNIT]

REF NO.	PARTS NO.	DESCRIPTION	M.	H/V LOCATION
R3685	7030009591	S.RES ERA3YED 472V (4.7K)	T	37.7/37.2
R3686	7030009591	S.RES ERA3YED 472V (4.7K)	T	37.7/39.0
R3687	7030009591	S.RES ERA3YED 472V (4.7K)	T	48.3/39.2
R3688	7030005341	S.RES ERA3YED 332V (3.3K)	T	40.4/35.4
R3689	7030005341	S.RES ERA3YED 332V (3.3K)	T	40.4/33.6
R3690	7030005341	S.RES ERA3YED 332V (3.3K)	T	49.4/33.5
R3691	7030004980	S.RES ERJ2GEJ 101 X (100K)	B	40.8/33.3
R3692	7030004980	S.RES ERJ2GEJ 101 X (100)	B	49.2/39.4
R3693	7030005050	S.RES ERJ2GEJ 103 X (10K)	T	36.7/19.2
R3694	7030009140	S.RES ERJ2GEJ 272 X (2.7K)	T	37.8/15.9
R3695	7030007290	S.RES ERJ2GEJ 222 X (2.2K)	T	39.0/16.3
R3696	7030005090	S.RES ERJ2GEJ 104 X (100K)	T	41.3/15.9
R3697	7030005030	S.RES ERJ2GEJ 152 X (1.5K)	T	37.1/20.4
R3698	7030009591	S.RES ERA3YED 472V (4.7K)	T	41.5/38.0
R3699	7030009961	S.RES ERA3YED 221V (220)	T	43.7/39.0
R3700	7030009961	S.RES ERA3YED 221V (220)	T	47.1/39.2
R3701	7030005341	S.RES ERA3YED 332V (3.3K)	T	43.2/34.6
R3702	7030009861	S.RES ERA3YED 471V (470)	T	45.4/33.6
R3703	7030009861	S.RES ERA3YED 471V (470)	T	47.3/33.5
R3704	7030008400	S.RES ERJ2GEJ 182 X (1.8K)	T	38.3/20.0
R3705	7030007300	S.RES ERJ2GEJ 332 X (3.3K)	T	40.5/18.9
R3706	7030007290	S.RES ERJ2GEJ 222 X (2.2K)	T	41.7/19.3
R3708	7030005720	S.RES ERJ2GEJ 563 X (56K)	T	43.1/16.0
R3709	7030007270	S.RES ERJ2GEJ 151 X (150K)	T	43.9/17.9
R3710	7030003860	S.RES ERJ3GE JPW V	T	24.0/19.1
R3711	7030003860	S.RES ERJ3GE JPW V	T	28.2/9.0
R3712	7030003860	S.RES ERJ3GE JPW V	T	17.5/34.6
R3713	7030003860	S.RES ERJ3GE JPW V	T	18.1/29.1
R3714	7030003860	S.RES ERJ3GE JPW V	T	130.4/23.5
R3715	7030005240	S.RES ERJ2GEJ 473 X (47K)	B	20.8/11.5
R3716	7030004980	S.RES ERJ2GEJ 101 X (100)	B	48.5/10.4
R3717	7030004980	S.RES ERJ2GEJ 101 X (100)	B	58.4/16.2
R3718	7030003860	S.RES ERJ3GE JPW V	B	26.6/9.6
R3719	7030003860	S.RES ERJ3GE JPW V	T	17.8/37.6
R3720	7030010040	S.RES ERJ2GEJ-JPW	B	78.5/21.4
R3721	7540000380	S.ABS EZAEG2A50AX	T	130.3/39.9
R3722	7540000380	S.ABS EZAEG2A50AX	T	131.3/39.9
R3724	7030005120	S.RES ERJ2GEJ 102 X (1K)	B	130.4/38.5
R3725	7030005160	S.RES ERJ2GEJ 105 X (1M)	B	130.6/37.3
R3726	7030005120	S.RES ERJ2GEJ 102 X (1K)	B	120.2/37.4
R3727	7030005240	S.RES ERJ2GEJ 473 X (47K)	B	120.2/36.3
R3728	7030005080	S.RES ERJ2GEJ 823 X (82K)	B	120.2/35.5
R3731	7030004980	S.RES ERJ2GEJ 101 X (100)	B	108.6/16.4
R3732	7030004980	S.RES ERJ2GEJ 101 X (100)	B	114.3/17.7
R3733	7030005050	S.RES ERJ2GEJ 103 X (10K)	B	101.9/13.7
R3734	7030005050	S.RES ERJ2GEJ 103 X (10K)	B	109.5/13.7
R3736	7030005120	S.RES ERJ2GEJ 102 X (1K)	B	128.2/43.8
R3737	7030005240	S.RES ERJ2GEJ 473 X (47K)	B	128.2/42.2
R3738	7030005240	S.RES ERJ2GEJ 473 X (47K)	B	112.0/31.7
R3739	7030010040	S.RES ERJ2GEJ-JPW	B	71.2/20.2
R3740	7030005050	S.RES ERJ2GEJ 103 X (10K)	B	108.6/21.6
R3741	7030010040	S.RES ERJ2GEJ-JPW	B	101.2/19.8
R3743	7030004980	S.RES ERJ2GEJ 101 X (100)	B	102.5/21.0
R3746	7030005120	S.RES ERJ2GEJ 102 X (1K)	B	127.7/31.4
R3747	7540000380	S.ABS EZAEG2A50AX	T	129.8/32.1
R3748	7540000380	S.ABS EZAEG2A50AX	T	127.2/32.1
R3749	7030003560	S.RES ERJ3GEVJ 103 V (10K)	B	95.9/4.0
R3750	7030003360	S.RES ERJ3GEVJ 221 V (220)	B	95.1/6.3
R3751	7030003460	S.RES ERJ3GEVJ 152 V (1.5K)	B	89.8/8.0
R3752	7540000380	S.ABS EZAEG2A50AX	T	125.4/32.1
R3753	7030010040	S.RES ERJ2GEJ-JPW	B	140.7/27.2
R3754	7030010040	S.RES ERJ2GEJ-JPW	B	140.7/28.8
C3004	4030017490	S.CER C1608 JB 1A 105K-T	T	89.7/18.2
C3006	4030017490	S.CER C1608 JB 1A 105K-T	T	60.7/21.9
C3007	4030019990	S.CER C1005 JB 1C 104K-T	T	53.4/35.3
C3008	4030019560	S.CER GRM21BB31C106KE15L	T	59.5/34.9
C3009	4030019560	S.CER GRM21BB31C106KE15L	B	64.9/36.8
C3010	4030016790	S.CER C1005 JB 1E 103K-T	T	54.5/36.2
C3011	4030019990	S.CER C1005 JB 1C 104K-T	B	64.6/38.2
C3012	4030019560	S.CER GRM21BB31C106KE15L	T	89.6/13.2
C3013	4030017490	S.CER C1608 JB 1A 105K-T	T	89.4/13.3
C3014	4030016790	S.CER C1005 JB 1E 103K-T	T	53.0/38.5
C3015	4030017460	S.CER C1005 JB 1H 102K-T	T	62.8/32.7
C3017	4030007130	S.CER C1608 CH 1H 101J-T	T	55.6/35.8
C3018	4030019560	S.CER GRM21BB31C106KE15L	T	64.9/34.4
C3019	4030011340	S.CER C1608 CH 1H 471J-T	T	86.8/13.3
C3020	4030019990	S.CER C1005 JB 1C 104K-T	B	57.2/38.4
C3022	4030019560	S.CER GRM21BB31C106KE15L	B	68.6/35.8
C3024	4550007670	S.TAN F931C105MAABMA	T	83.0/14.5
C3025	4030019990	S.CER C1005 JB 1C 104K-T	B	83.9/13.6
C3026	4550007670	S.TAN F931C105MAABMA	T	68.2/32.1
C3027	4030017490	S.CER C1608 JB 1A 105K-T	T	72.9/27.7
C3028	4030017490	S.CER C1608 JB 1A 105K-T	T	75.7/27.7
C3029	4550008220	S.TAN F931C106MAA	T	76.2/20.7
C3031	4030019990	S.CER C1005 JB 1C 104K-T	T	80.3/23.4
C3032	4030017490	S.CER C1608 JB 1A 105K-T	T	75.7/25.1
C3033	4550007670	S.TAN F931C105MAABMA	B	70.0/19.9
C3034	4030017490	S.CER C1608 JB 1A 105K-T	T	72.9/25.1
C3035	4550007670	S.TAN F931C105MAABMA	B	76.1/19.9
C3036	4550007670	S.TAN F931C105MAABMA	T	75.8/22.8
C3037	4550007670	S.TAN F931C105MAABMA	B	73.2/17.7
C3038	4550007670	S.TAN F931C105MAABMA	B	79.8/33.7
C3039	4030016950	S.CER C1005 JB 1A 473K-T	B	83.2/34.8
C3041	4550007670	S.TAN F931C105MAABMA	B	83.0/37.0
C3042	4030016790	S.CER C1005 JB 1E 103K-T	T	84.1/34.8
C3044	4030019990	S.CER C1005 JB 1C 104K-T	T	87.8/38.6
C3045	4510009860	S.ELE 25 CE 330 BS	T	96.3/34.9
C3046	4510008650	S.ELE EEFK1C221P	T	105.8/18.6
C3047	4510010120	S.ELE EEFK1E101XP	T	103.8/33.8
C3048	4030019990	S.CER C1005 JB 1C 104K-T	B	88.9/36.0
C3050	4550008220	S.TAN F931C106MAA	B	57.5/35.4
C3051	4550008220	S.TAN F931C106MAA	B	84.4/16.6
C3052	4550007670	S.TAN F931C105MAABMA	B	67.1/23.3

Eqv.= This component is equivalent to the REF No. component listed above, and may be substituted on parts orders and repairs.

[DSP-1 UNIT]

REF NO.	PARTS NO.	DESCRIPTION	M.	H/V LOCATION
C3053	4030019990	S.CER C1005 JB 1C 104K-T	B	65.5/23.9
C3054	4030019990	S.CER C1005 JB 1C 104K-T	B	85.6/2.6
C3055	4030019990	S.CER C1005 JB 1C 104K-T	B	84.0/2.6
C3056	4550008220	S.TAN F931C106MAA	B	81.0/5.9
C3057	4030019990	S.CER C1005 JB 1C 104K-T	B	127.3/15.2
C3058	4550008220	S.TAN F931C106MAA	B	125.7/14.0
C3060	4030019560	S.CER GRM21BB31C106KE15L	T	58.1/37.3
C3061	4550007670	S.TAN F931C105MAABMA	T	48.7/37.1
C3062	4030018980	S.CER C1608 JB 1H 104K-T	T	132.0/10.7
C3063	4030017460	S.CER C1005 JB 1H 102K-T	T	128.2/22.8
C3601	4030019990	S.CER C1005 JB 1C 104K-T	T	67.0/4.0
C3602	4030019990	S.CER C1005 JB 1C 104K-T	B	60.8/3.5
C3603	4030019990	S.CER C1005 JB 1C 104K-T	B	67.1/8.7
C3604	4030019560	S.CER GRM21BB31C106KE15L	B	59.4/4.2
C3605	4030019560	S.CER GRM21BB31C106KE15L	B	68.6/7.2
C3606	4550007480	S.TAN F930J106MAABMA	T	81.2/18.1
C3607	4550007480	S.TAN F930J106MAABMA	T	59.2/27.8
C3608	4030019990	S.CER C1005 JB 1C 104K-T	B	67.4/16.6
C3609	4030019990	S.CER C1005 JB 1C 104K-T	B	60.8/11.1
C3610	4030019560	S.CER GRM21BB31C106KE15L	B	68.8/15.7
C3611	4030019560	S.CER GRM21BB31C106KE15L	B	59.4/12.0
C3612	4030019990	S.CER C1005 JB 1C 104K-T	T	62.3/4.0
C3613	4030019990	S.CER C1005 JB 1C 104K-T	B	49.0/3.2
C3614	4030019990	S.CER C1005 JB 1C 104K-T	B	55.6/7.1
C3615	4030019560	S.CER GRM21BB31C106KE15L	B	47.3/4.1
C3616	4030019560	S.CER GRM21BB31C106KE15L	B	57.0/6.3
C3617	4030019990	S.CER C1005 JB 1C 104K-T	T	54.2/4.8
C3618	4030019990	S.CER C1005 JB 1C 104K-T	T	54.2/6.4
C3619	4030017760	S.CER C1005 JB 1H 222K-T	T	63.4/16.4
C3620	4030017870	S.CER C1608 CH 1H 681J-T	T	52.3/2.3
C3621	4030017870	S.CER C1608 CH 1H 681J-T	T	51.0/8.1
C3624	4030019990	S.CER C1005 JB 1C 104K-T	B	40.8/25.2
C3625	4030019990	S.CER C1005 JB 1C 104K-T	B	49.1/30.3
C3626	4030019560	S.CER GRM21BB31C106KE15L	B	41.3/27.3
C3627	4030019560	S.CER GRM21BB31C106KE15L	B	48.7/28.2
C3628	4030019990	S.CER C1005 JB 1C 104K-T	T	54.0/14.9
C3632	4030019990	S.CER C1005 JB 1C 104K-T	B	29.7/25.7
C3633	4030019990	S.CER C1005 JB 1C 104K-T	B	36.7/30.5
C3634	4030017670	S.CER C1005 CH 1H 390J-T	T	51.0/16.5
C3635	4030019560	S.CER GRM21BB31C106KE15L	B	29.4/27.8
C3636	4030019560	S.CER GRM21BB31C106KE15L	B	36.9/28.4
C3637	4030017760	S.CER C1005 JB 1H 222K-T	T	49.3/5.8
C3638	4030019990	S.CER C1005 JB 1C 104K-T	B	28.7/32.8
C3639	4030019990	S.CER C1005 JB 1C 104K-T	B	35.8/39.2
C3640	4030017490	S.CER C1608 JB 1A 105K-T	T	27.9/23.5
C3642	4030019560	S.CER GRM21BB31C106KE15L	B	28.3/34.9
C3643	4030019560	S.CER GRM21BB31C106KE15L	B	35.7/37.1
C3644	4030016790	S.CER C1005 JB 1E 103K-T	B	27.7/21.7
C3645	4030017420	S.CER C1005 CH 1H 470J-T	T	52.3/13.3
C3646	4030017760	S.CER C1005 JB 1H 222K-T	T	46.9/14.1
C3647	4030019990	S.CER C1005 JB 1C 104K-T	T	30.7/9.8
C3648	4030019990	S.CER C1005 JB 1C 104K-T	B	32.3/12.1
C3649	4030019990	S.CER C1005 JB 1C 104K-T	T	54.2/13.6
C3650	4550007470	S.TAN F931A107MNMBA	T	33.4/15.4
C3651	4550007480	S.TAN F930J106MAABMA	T	36.3/28.1
C3652	4550007470	S.TAN F931A107MNMBA	T	40.7/13.0
C3653	4030019990	S.CER C1005 JB 1C 104K-T	B	30.7/20.8
C3654	4550007480	S.TAN F930J106MAABMA	T	42.1/26.8
C3655	4550007480	S.TAN F930J106MAABMA	T	42.1/23.6
C3656	4550007480	S.TAN F930J106MAABMA	T	46.4/30.7
C3657	4550007480	S.TAN F930J106MAABMA	T	40.0/30.5
C3659	4030019990	S.CER C1005 JB 1C 104K-T	T	34.4/27.4
C3660	4030019990	S.CER C1005 JB 1C 104K-T	T	34.4/28.3
C3661	4030019990	S.CER C1005 JB 1C 104K-T	T	32.6/37.1
C3662	4030019990	S.CER C1005 JB 1C 104K-T	T	34.0/35.6
C3663	4550007470	S.TAN F931A107MNMBA	T	28.6/17.8
C3664	4030017460	S.CER C1005 JB 1H 102K-T	T	31.2/30.8
C3665	4030017460	S.CER C1005 JB 1H 102K-T	T	32.3/24.8
C3666	4030017730	S.CER C1005 JB 1H 471K-T	T	30.6/39.3
C3667	4030017730	S.CER C1005 JB 1H 471K-T	T	31.8/33.7
C3668	4030019990	S.CER C1005 JB 1C 104K-T	B	27.7/20.8
C3669	4030019990	S.CER C1005 JB 1C 104K-T	B	25.5/10.7
C3670	4550007470	S.TAN F931A107MNMBA	T	23.8/13.7
C3671	4030017760	S.CER C1005 JB 1H 222K-T	T	29.5/27.1
C3672				

[DSP-1 UNIT]

REF NO.	PARTS NO.	DESCRIPTION	M.	H/V LOCATION
C3702	4030019560	S.CER GRM21BB31C106KE15L	B	50.2/37.3
C3703	4030018580	S.CER C1608 CH 1H 821J-T	T	39.5/18.4
C3704	4030018580	S.CER C1608 CH 1H 821J-T	T	39.2/21.5
C3705	4030017760	S.CER C1005 JB 1H 222K-T	T	43.9/37.1
C3706	4030017760	S.CER C1005 JB 1H 222K-T	T	46.0/38.8
C3707	4030011340	S.CER C1608 CH 1H 471J-T	T	45.1/35.8
C3708	4030011340	S.CER C1608 CH 1H 471J-T	T	48.1/35.4
C3709	4030017420	S.CER C1005 CH 1H 470J-T	T	42.3/17.9
C3710	4030019990	S.CER C1005 JB 1C 104K-T	B	49.0/11.7
C3711	4030019990	S.CER C1005 JB 1C 104K-T	B	55.6/16.5
C3712	4030019560	S.CER GRM21BB31C106KE15L	B	47.6/12.5
C3713	4030019560	S.CER GRM21BB31C106KE15L	B	57.0/15.6
C3715	4030017380	S.CER C1005 CH 1H 050B-T	T	18.7/18.7
C3716	4030019990	S.CER C1005 JB 1C 104K-T	T	43.3/19.8
C3718	4030016790	S.CER C1005 JB 1E 103K-T	B	128.2/45.5
C3719	4030016790	S.CER C1005 JB 1E 103K-T	B	128.7/40.4
C3720	4030018980	S.CER C1608 JB 1H 104K-T	B	132.6/27.6
C3721	4030018980	S.CER C1608 JB 1H 104K-T	B	128.1/22.0
C3723	4030018980	S.CER C1608 JB 1H 104K-T	B	130.2/26.8
C3725	4030019490	S.CER C2012 JB 1A 106K-T	B	130.4/28.4
C3726	4030019990	S.CER C1005 JB 1C 104K-T	B	126.8/27.9
C3727	4030017420	S.CER C1005 CH 1H 470J-T	T	119.7/39.2
C3728	4030017420	S.CER C1005 CH 1H 470J-T	T	121.4/39.2
C3729	4030017420	S.CER C1005 CH 1H 470J-T	T	123.1/39.2
C3730	4030017780	S.CER C1005 JB 1H 472K-T	B	118.7/38.7
C3731	4030016790	S.CER C1005 JB 1E 103K-T	B	118.8/36.8
C3732	4030019460	S.CER C1608 JB 0J 106M-T	B	106.8/12.3
C3733	4030019460	S.CER C1608 JB 0J 106M-T	B	115.0/12.8
C3734	4030021240	S.CER C1005 JB 1C 105K-T	B	101.2/21.4
C3735	4030017490	S.CER C1608 JB 1A 105K-T	B	111.2/12.9
C3736	4030021240	S.CER C1005 JB 1C 105K-T	B	113.3/21.6
C3737	4550007670	S.TAN F931C105MAABMA	T	70.0/26.4
C3741	4510008650	S.ELE EEEFK1C21P	T	105.8/27.4
C3742	4030019460	S.CER C1608 JB 0J 106M-T	B	104.6/21.7
C3743	4030006880	S.CER C1608 JB 1H 472K-T	B	94.5/4.0
RL3001	6310000110	S.REL AGQ200S12	T	124.6/13.8
J3001	6510021722	S.CON 30FLT-SM2-TB(LF)(SN)(M)	T	138.6/23.5
J3002	6510021722	S.CON 30FLT-SM2-TB(LF)(SN)(M)	T	138.6/16.7
J3006	6510018961	S.CON B2B-PH-SM4-TB(LF)(SN)	T	125.5/27.5
J3007	6510026650	S.CON BM12B-SRSS-TBT(LF)(SN)	T	125.5/36.5
J3303	6510023092	S.CON 20FLT-SM2-TB(LF)(SN)(M)	T	16.4/4.5
J3305	6510024751	S.CON (G)BM07B-SRSS-TB(LF)(SN)	T	133.3/44.1
J3306	6510025990	S.CON (G)BM05B-SRSS-TB(LF)(SN)	T	122.1/44.1
J3307	6510022472	S.CON 40FLT-SM2-TB(LF)(SN)(M)	T	116.0/19.6
J3308	6510018961	S.CON B2B-PH-SM4-TB(LF)(SN)	T	143.9/30.8
EP3005	6910012350	S.BEA MMZ1608Y 102BT	B	120.6/31.1
EP3006	6910012350	S.BEA MMZ1608Y 102BT	B	121.8/31.1
EP3007	6910012350	S.BEA MMZ1608Y 102BT	B	123.7/34.4
EP3011	6910012350	S.BEA MMZ1608Y 102BT	B	125.4/31.1
EP3012	6910012350	S.BEA MMZ1608Y 102BT	B	130.5/40.0
EP3021	6910012350	S.BEA MMZ1608Y 102BT	T	127.3/21.4
EP3023	6910012350	S.BEA MMZ1608Y 102BT	B	127.1/26.9
EP3024	6910015970	S.BEA MMZ1608B 301CT-AS	B	123.0/43.0
EP3025	6910015970	S.BEA MMZ1608B 301CT-AS	B	121.0/39.0
EP3026	6910015970	S.BEA MMZ1608B 301CT-AS	B	122.4/39.0
EP3027	6910015970	S.BEA MMZ1608B 301CT-AS	B	119.7/39.0
EP3028	6910012350	S.BEA MMZ1608Y 102BT	B	123.0/31.1
EP3029	6910012350	S.BEA MMZ1608Y 102BT	B	124.2/31.1
EP3030	6910015970	S.BEA MMZ1608B 301CT-AS	B	124.3/43.0
EP3031	6910012350	S.BEA MMZ1608Y 102BT	T	134.0/36.5
EP3032	6910012350	S.BEA MMZ1608Y 102BT	T	118.8/31.8

Eqv.= This component is equivalent to the REF No. component listed above, and may be substituted on parts orders and repairs.

[DSP-2 UNIT]

REF NO.	PARTS NO.	DESCRIPTION	M.	H/V LOCATION
IC8001	1180004180	S.REG ADP2323ACPZ-R7 <FE>	B	74.7/11.8
IC8003	1130012850	S.IC SN74LVC3G34DCUR	B	78.8/17.8
IC8201	1140015432	S.IC TMS320C6747DZKBT3	T	28.5/28.3
IC8202	1130017091	S.IC EN29LV040A-70SCP (SX-3500C-1)	B	15.4/27.6
IC8203	1180003410	S.REG BD12KA5FF-E2	T	13.1/30.1
IC8204	1130006551	S.IC TC7S08FU(TE85RF)	T	45.2/16.7
IC8205	1110005851	S.IC S-80830CNMC-B8P-T2G	T	41.1/16.7
IC8206	1180004190	S.REG LT8582IDKD#TRPBF	B	95.3/14.6
IC8207	1190002911	S.IC TUSB2046BIVFRG4	T	61.3/33.6
IC8208	1190002240	S.IC PCM2901E/2K	T	102.1/27.3
IC8209	1190002730	S.IC CP2102-GMR <MAC>	T	77.8/32.5
IC8210	1190002730	S.IC CP2102-GMR <MAC>	T	88.2/31.7
IC8211	1130007111	S.IC TC7W04FU(TE12LF)	B	68.0/23.5
IC8212	1130007111	S.IC TC7W04FU(TE12LF)	B	76.3/23.5
IC8213	1130013010	S.IC SN74AHC1G08DCK3	T	101.5/34.9
IC8214	1180003480	S.REG NJU7772F33-TE1-#ZZZB	B	65.4/34.9
IC8215	1180003480	S.REG NJU7772F33-TE1-#ZZZB	T	96.5/38.5
IC8216	1130008511	S.IC TC7W53FU(TE12LF)	T	52.3/23.0
IC8217	1130008511	S.IC TC7W53FU(TE12LF)	T	52.3/16.1
IC8218	1130007111	S.IC TC7W04FU(TE12LF)	B	91.9/24.3
Q8001	1560001980	S.FET SSM3K131TU(TE85L)	B	72.7/6.7
Q8002	1560001980	S.FET SSM3K131TU(TE85L)	B	76.8/6.7
Q8003	1550000230	S.FET SSM3J117TU(TE85L)	B	87.5/17.8
Q8004	1590003680	S.TRA KRC402 RTK/P	T	75.4/28.3
Q8005	1590003680	S.TRA KRC402 RTK/P	T	85.8/27.3
Q8006	1590004390	S.TRA DMG504010R	B	68.0/26.5
Q8007	1590004390	S.TRA DMG504010R	B	76.3/26.5
Q8008	1590003680	S.TRA KRC402 RTK/P	T	104.8/34.9
Q8009	1590003680	S.TRA KRC402 RTK/P	T	88.8/26.6
Q8010	1590002310	S.TRA DTC114EE TL	B	60.2/13.2
Q8011	1590003930	S.TRA UMD22N TR	T	37.3/18.3
Q8013	1590004390	S.TRA DMG504010R	B	91.9/27.4
D8001	1790001450	S.DIO RB160L-40 TE-25	B	107.4/13.2
D8002	1750000540	S.DIO RB060L-40 TE-25	B	86.8/13.5
D8003	1750001180	S.DIO KDS122 RTK/P	B	61.4/26.9
D8004	1750001180	S.DIO KDS122 RTK/P	B	61.4/29.4
D8005	1750002210	S.DIO DA2S00100L	B	68.8/28.4
D8006	1750002210	S.DIO DA2S00100L	B	77.0/28.4
D8007	1750002210	S.DIO DA2S00100L	B	91.9/29.3
FI8201	2040000790	S.LC EXCCET103U	T	44.2/25.2
FI8202	2040000790	S.LC EXCCET103U	T	38.9/22.7
X1	6050012970	S.XTA CR-890 TSS-2 6 MHz	B	52.7/39.0
X2	6050012770	S.XTA CR-870 DSX321G 12 MHz<KDS>	T	110.1/27.9
L8001	6190002070	S.COI 7E08L-100M-RA-0231	T	57.1/9.5
L8002	6200009491	S.COI CDRH6D28NP-100NCI	B	85.2/6.3
L8003	6200009491	S.COI CDRH6D28NP-100NCI	B	93.9/6.3
L8004	6200009491	S.COI CDRH6D28NP-100NCI	T	93.1/4.3
L8005	6200009491	S.COI CDRH6D28NP-100NCI	T	83.1/4.3
L8006	6200009491	S.COI CDRH6D28NP-100NCI	B	63.2/7.1
L8201	6200011900	S.COI LQH43CN100K03L	T	43.0/30.1
L8202	6200011900	S.COI LQH43CN100K03L	T	43.4/21.3
L8203	6200003281	S.COI NLV25T-2R2J	B	22.1/18.1
L8204	6200005011	S.COI NLV25T-100J	T	72.0/32.6
L8205	6200005011	S.COI NLV25T-100J	T	82.2/30.7
L8206	6200009491	S.COI CDRH6D28NP-100NCI	T	66.4/5.3
R8001	7030005090	S.RES ERJ2GEJ 104 X (100K)	B	74.7/16.2
R8002	7030005240	S.RES ERJ2GEJ 473 X (47K)	B	73.0/18.0
R8003	7030005240	S.RES ERJ2GEJ 473 X (47K)	B	76.6/15.1
R8004	7030005030	S.RES ERJ2GEJ 152 X (1.5K)	B	70.7/14.0
R8005	7030005220	S.RES ERJ2GEJ 223 X (22K)	B	69.8/14.0
R8006	7030005530	S.RES ERJ2GEJ 100 X (10)	B	79.0/15.1
R8007	7030007340	S.RES ERJ2GEJ 153 X (15K)	B	70.2/12.8
R8008	7030005030	S.RES ERJ2GEJ 152 X (1.5K)	B	70.3/15.3
R8009	7030005240	S.RES ERJ2GEJ 473 X (47K)	B	68.6/12.8
R8010	7030010040	S.RES ERJ2GEJ-JPW	B	79.1/12.6
R8011	7030005080	S.RES ERJ2GEJ 823 X (82K)	B	80.7/12.6
R8012	7030007290	S.RES ERJ2GEJ 222 X (2.2K)	B	78.2/13.8
R8013	7030005050	S.RES ERJ2GEJ 103 X (10K)	B	79.1/13.8
R8014	7030005090	S.RES ERJ2GEJ 104 X (100K)	B	73.0/16.2
R8015	7030005290	S.RES ERJ2GEJ 682 X (6.8K)	B	88.9/15.8
R8016	7030004980	S.RES ERJ2GEJ 101 X (10K)	B	90.5/17.2
R8017	7030005080	S.RES ERJ2GEJ 823 X (82K)	B	83.6/17.8
R8018	7030010040	S.RES ERJ2GEJ-JPW	B	85.2/17.8
R8019	7030005110	S.RES ERJ2GEJ 224 X (220K)	B	91.9/16.3
R8020	7030005110	S.RES ERJ2GEJ 224 X (220K)	B	91.0/11.3
R8021	7030005090	S.RES ERJ2GEJ 104 X (100K)	B	99.3/18.3
R8022	7030005090	S.RES ERJ2GEJ 104 X (100K)	B	98.4/12.6
R8023	7030005090	S.RES ERJ2GEJ 104 X (100K)	B	90.3/14.0
R8024	7030005240	S.RES ERJ2GEJ 473 X (47K)	B	102.8/15.2
R8025	7030005090	S.RES ERJ2GEJ 104 X (100K)	B	104.5/15.2
R8201	7030005040	S.RES ERJ2GEJ 472 X (4.7K)	B	34.5/29.8
R8202	7030005040	S.RES ERJ2GEJ 472 X (4.7K)	B	34.5/28.9
R8203	7030010040	S.RES ERJ2GEJ-JPW	B	35.5/27.7
R8204	7030007260	S.RES ERJ2GEJ 330 X (33)	B	33.4/23.8
R8205	7030005240	S.RES ERJ2GEJ 473 X (47K)	T	38.3/38.5
R8206	7030005240	S.RES ERJ2GEJ 473 X (47K)	T	36.9/38.5
R8207	7030005240	S.RES ERJ2GEJ 473 X (47K)	T	34.3/38.5
R8208	7030010040	S.RES ERJ2GEJ-JPW	T	35.6/38.5
R8209	7030010040	S.RES ERJ2GEJ-JPW	B	33.4/24.9
R8210	7030010040	S.RES ERJ2GEJ-JPW	B	33.4/20.9
R8211	7030010040	S.RES ERJ2GEJ-JPW	B	33.4/21.8
R8212	7030005240	S.RES ERJ2GEJ 473 X (47K)	B	24.7/18.5

M.=Mounted side (T: Mounted on the Top side, B: Mounted on the Bottom side) S.=Surface mount

[DSP-2 UNIT]

REF NO.	PARTS NO.	DESCRIPTION	M.	H/V LOCATION
R8213	7030005240	S.RES ERJ2GEJ 473 X (47K)	B	25.6/18.5
R8214	7030005240	S.RES ERJ2GEJ 473 X (47K)	B	34.5/30.8
R8215	7030007260	S.RES ERJ2GEJ 330 X (33)	B	18.5/12.6
R8216	7030007260	S.RES ERJ2GEJ 330 X (33)	B	18.5/11.7
R8217	7030007260	S.RES ERJ2GEJ 330 X (33)	B	18.5/14.4
R8218	7030007260	S.RES ERJ2GEJ 330 X (33)	B	18.5/13.5
R8219	7030007260	S.RES ERJ2GEJ 330 X (33)	B	17.8/37.7
R8220	7030007260	S.RES ERJ2GEJ 330 X (33)	B	17.2/36.2
R8221	7030007260	S.RES ERJ2GEJ 330 X (33)	B	16.6/37.7
R8222	7030007260	S.RES ERJ2GEJ 330 X (33)	B	16.0/36.2
R8223	7030007260	S.RES ERJ2GEJ 330 X (33)	B	15.4/37.7
R8224	7030007260	S.RES ERJ2GEJ 330 X (33)	B	14.8/36.2
R8225	7030007260	S.RES ERJ2GEJ 330 X (33)	B	14.2/37.7
R8226	7030007260	S.RES ERJ2GEJ 330 X (33)	B	13.6/36.2
R8227	7030007260	S.RES ERJ2GEJ 330 X (33)	B	17.2/19.0
R8228	7030007260	S.RES ERJ2GEJ 330 X (33)	B	17.8/17.5
R8229	7030007260	S.RES ERJ2GEJ 330 X (33)	B	13.6/19.0
R8230	7030007260	S.RES ERJ2GEJ 330 X (33)	B	19.6/19.0
R8231	7030007260	S.RES ERJ2GEJ 330 X (33)	B	19.0/37.7
R8232	7030007260	S.RES ERJ2GEJ 330 X (33)	B	19.0/17.5
R8233	7030007260	S.RES ERJ2GEJ 330 X (33)	B	18.4/19.0
R8234	7030007260	S.RES ERJ2GEJ 330 X (33)	B	18.0/17.5
R8235	7030007260	S.RES ERJ2GEJ 330 X (33)	B	12.4/19.0
R8236	7030007260	S.RES ERJ2GEJ 330 X (33)	B	11.8/17.5
R8237	7030007260	S.RES ERJ2GEJ 330 X (33)	B	11.2/19.0
R8238	7030007260	S.RES ERJ2GEJ 330 X (33)	B	11.2/36.2
R8239	7030007260	S.RES ERJ2GEJ 330 X (33)	B	11.8/37.7
R8240	7030007260	S.RES ERJ2GEJ 330 X (33)	B	12.4/36.2
R8241	7030007260	S.RES ERJ2GEJ 330 X (33)	B	13.0/37.7
R8242	7030007260	S.RES ERJ2GEJ 330 X (33)	B	18.4/36.2
R8243	7030007260	S.RES ERJ2GEJ 330 X (33)	B	16.0/19.0
R8244	7030007260	S.RES ERJ2GEJ 330 X (33)	B	19.6/36.2
R8245	7030007260	S.RES ERJ2GEJ 330 X (33)	B	15.4/17.5
R8246	7030007260	S.RES ERJ2GEJ 330 X (33)	B	16.6/17.5
R8247	7030007260	S.RES ERJ2GEJ 330 X (33)	B	14.8/19.0
R8248	7030007260	S.RES ERJ2GEJ 330 X (33)	B	14.2/17.5
R8249	7030007260	S.RES ERJ2GEJ 330 X (33)	B	20.9/25.4
R8250	7030007260	S.RES ERJ2GEJ 330 X (33)	B	28.8/17.0
R8251	7030007260	S.RES ERJ2GEJ 330 X (33)	B	27.4/18.5
R8252	7030007260	S.RES ERJ2GEJ 330 X (33)	B	26.5/18.5
R8253	7030007260	S.RES ERJ2GEJ 330 X (33)	B	29.4/18.5
R8254	7030007260	S.RES ERJ2GEJ 330 X (33)	B	29.9/17.0
R8255	7030007260	S.RES ERJ2GEJ 330 X (33)	B	28.3/18.5
R8256	7030007260	S.RES ERJ2GEJ 330 X (33)	B	30.5/18.5
R8257	7030007260	S.RES ERJ2GEJ 330 X (33)	B	31.0/17.0
R8258	7030007260	S.RES ERJ2GEJ 330 X (33)	B	31.6/18.5
R8259	7030007260	S.RES ERJ2GEJ 330 X (33)	B	32.5/18.5
R8260	7030005050	S.RES ERJ2GEJ 103 X (10K)	T	43.3/17.4
R8261	7030005240	S.RES ERJ2GEJ 473 X (47K)	T	29.4/16.8
R8262	7030005240	S.RES ERJ2GEJ 473 X (47K)	T	29.4/16.8
R8263	7030005240	S.RES ERJ2GEJ 473 X (47K)	T	29.4/14.9
R8264	7030005240	S.RES ERJ2GEJ 473 X (47K)	T	29.4/17.7
R8265	7030010040	S.RES ERJ2GEJ-JPW	T	21.5/17.7
R8266	7030005240	S.RES ERJ2GEJ 473 X (47K)	B	20.5/32.5
R8267	7030005050	S.RES ERJ2GEJ 103 X (10K)	T	40.7/17.1
R8271	7030003860	S.RES ERJ3GE JPW V	T	48.0/8.3
R8272	7030003860	S.RES ERJ3GE JPW V	T	48.0/39.5
R8273	7030003860	S.RES ERJ3GE JPW V	T	48.0/36.6
R8275	7030005310	S.RES ERJ2GEJ 124 X (120K)	B	90.3/16.3
R8276	7030007340	S.RES ERJ2GEJ 153 X (15K)	B	90.3/15.1
R8277	7030005310	S.RES ERJ2GEJ 124 X (120K)	B	91.0/12.2
R8278	7030007340	S.RES ERJ2GEJ 153 X (15K)	B	89.7/12.6
R8279	7030008400	S.RES ERJ2GEJ 182 X (1.8K)	B	99.5/16.5
R8280	7030005040	S.RES ERJ2GEJ 472 X (4.7K)	B	101.2/16.5
R8281	7030008010	S.RES ERJ2GEJ 123 X (12K)	B	99.6/14.5
R8282	7030009140	S.RES ERJ2GEJ 272 X (2.7K)	B	101.2/14.5
R8283	7030005090	S.RES ERJ2GEJ 104 X (100K)	B	75.7/17.3
R8284	7030005030	S.RES ERJ2GEJ 152 X (1.5K)	T	55.4/34.5
R8285	7030005160	S.RES ERJ2GEJ 105 X (1M)	T	55.4/32.8
R8286	7030005090	S.RES ERJ2GEJ 104 X (100K)	T	61.1/27.7
R8287	7030005030	S.RES ERJ2GEJ 152 X (1.5K)	T	59.7/26.4
R8288	7030009530	S.RES ERJ2GEJ 270 X (27)	T	68.0/32.0
R8289	7030009530	S.RES ERJ2GEJ 270 X (27)	T	68.3/36.1
R8290	7030009530	S.RES ERJ2GEJ 270 X (27)	T	69.9/32.8
R8291	7030009530	S.RES ERJ2GEJ 270 X (27)	T	66.4/38.1
R8292	7030007340	S.RES ERJ2GEJ 153 X (15K)	T	67.6/30.6
R8293	7030007340	S.RES ERJ2GEJ 153 X (15K)	T	69.4/31.6
R8294	7030007340	S.RES ERJ2GEJ 153 X (15K)	T	67.8/37.4
R8295	7030007340	S.RES ERJ2GEJ 153 X (15K)	T	66.9/39.4
R8296	7030007340	S.RES ERJ2GEJ 153 X (15K)	T	54.8/39.6
R8297	7030007340	S.RES ERJ2GEJ 153 X (15K)	T	65.2/39.9
R8298	7030009530	S.RES ERJ2GEJ 270 X (27)	T	55.7/39.6
R8299	7030009530	S.RES ERJ2GEJ 270 X (27)	T	63.9/40.4
R8301	7030005160	S.RES ERJ2GEJ 105 X (1M)	T	107.7/26.6
R8302	7030009140	S.RES ERJ2GEJ 272 X (2.7K)	T	109.1/25.8
R8303	7030005160	S.RES ERJ2GEJ 105 X (1M)	T	97.0/26.8
R8304	7030005050	S.RES ERJ2GEJ 103 X (10K)	T	77.8/28.9
R8305	7030005040	S.RES ERJ2GEJ 472 X (4.7K)	T	74.5/30.6
R8306	7030005050	S.RES ERJ2GEJ 103 X (10K)	T	77.6/26.5
R8307	7030005050	S.RES ERJ2GEJ 103 X (10K)	T	88.6/28.3
R8308	7030005040	S.RES ERJ2GEJ 472 X (4.7K)	T	84.8/29.8
R8309	7030005050	S.RES ERJ2GEJ 103 X (10K)	T	86.2/24.7
R8310	7030008290	S.RES ERJ2GEJ 183 X (18K)	B	64.7/23.6
R8311	7030008290	S.RES ERJ2GEJ 183 X (18K)	B	71.0/26.8
R8312	7030008290	S.RES ERJ2GEJ 183 X (18K)	B	72.9/23.6
R8313	7030008290	S.RES ERJ2GEJ 183 X (18K)	B	79.3/26.8
R8314	7030005240	S.RES ERJ2GEJ 473 X (47K)	B	65.7/26.1
R8315	7030005240	S.RES ERJ2GEJ 473 X (47K)	B	65.7/27.7
R8316	7030005240	S.RES ERJ2GEJ 473 X (47K)	B	73.9/27.7
R8317	7030005240	S.RES ERJ2GEJ 473 X (47K)	B	73.9/26.1
R8318	7030005090	S.RES ERJ2GEJ 104 X (100K)	B	70.1/26.8
R8319	7030005090	S.RES ERJ2GEJ 104 X (100K)	B	78.4/26.8
R8320	7030005030	S.RES ERJ2GEJ 152 X (1.5K)	T	99.2/35.7
R8321	7030005050	S.RES ERJ2GEJ 103 X (10K)	T	103.4/37.9
R8322	7030004980	S.RES ERJ2GEJ 101 X (10K)	T	102.0/33.2

Eqv.= This component is equivalent to the REF No. component listed above, and may be substituted on parts orders and repairs.

[DSP-2 UNIT]

REF NO.	PARTS NO.	DESCRIPTION	M.	H/V LOCATION
R8325	7030004980	S.RES ERJ2GEJ 101 X (10K)	B	67.7/36.5
R8326	7030003200	S.RES ERJ3GEJ 100 V (10)	B	61.1/35.3
R8327	7030003200	S.RES ERJ3GEJ 100 V (10)	T	103.2/39.2
R8328	7030004980	S.RES ERJ2GEJ 101 X (10K)	T	96.4/35.1
R8329	7030005240	S.RES ERJ2GEJ 473 X (47K)	B	24.7/21.5
R8330	7030005240	S.RES ERJ2GEJ 473 X (47K)	T	31.6/18.6
R8331	7030004980	S.RES ERJ2GEJ 101 X (10K)	T	48.9/25.4
R8332	7030004980	S.RES ERJ2GEJ 101 X (10K)	T	48.9/18.5
R8333	7030005240	S.RES ERJ2GEJ 473 X (47K)	B	73.0/17.1
R8334	7030010040	S.RES ERJ2GEJ-JPW	B	63.7/23.6
R8335	7030010040	S.RES ERJ2GEJ-JPW	B	72.0/23.6
R8338	7030005050	S.RES ERJ2GEJ 103 X (10K)	B	76.7/29.6
R8339	7030010040	S.RES ERJ2GEJ-JPW	B	35.9/33.5
R8342	7030005240	S.RES ERJ2GEJ 473 X (47K)	B	89.5/26.9
R8343	7030005240	S.RES ERJ2GEJ 473 X (47K)	B	89.5/28.1
R8344	7030008290	S.RES ERJ2GEJ 183 X (18K)	B	94.7/27.7
R8345	7030008290	S.RES ERJ2GEJ 183 X (18K)	B	93.8/27.7
R8346	7030010040	S.RES ERJ2GEJ-JPW	B	89.5/22.5
R8347	7030008290	S.RES ERJ2GEJ 183 X (18K)	B	88.6/26.9
R8350	7030005090	S.RES ERJ2GEJ 104 X (100K)	B	96.5/26.0
R8351	7030005290	S.RES ERJ2GEJ 682 X (6.8K)	B	40.9/27.3
R8352	7030005290	S.RES ERJ2GEJ 682 X (6.8K)	B	40.3/22.0
R8353	7030005050	S.RES ERJ2GEJ 103 X (10K)	B	38.7/27.3
R8354	7030005050	S.RES ERJ2GEJ 103 X (10K)	B	38.7/22.0
C8004	4510010120	S.ELE EEEFK1E101XP	T	51.1/3.9
C8005	4030020980	S.CER C1005 CH 1H 821JT	B	68.6/11.9
C8006	4030018980	S.CER C1608 JB 1H 104K-T	B	67.0/14.4
C8007	4030016970	S.CER C1005 JB 1E 223K-T	B	70.2/11.9
C8008	4030018840	S.CER C3216 JF 1E 4752-T	B	70.1/9.0
C8009	4030018840	S.CER C3216 JF 1E 4752-T	B	79.4/8.3
C8010	4030017740	S.CER C1005 JB 1H 821K-T	B	80.7/11.7
C8011	4030019990	S.CER C1005 JB 1C 104K-T	B	79.0/16.1
C8012	4030016970	S.CER C1005 JB 1E 223K-T	B	79.1/11.7
C8013	4030020000	S.CER C1005 JB 1A 105K-T	B	74.7/8.3
C8015	4030020190	S.CER GRM32EB31C476KE15L	T	74.3/9.4
C8016	4030020190	S.CER GRM32EB31C476KE15L	T	73.2/3.8
C8018	4550007500	S.TAN F931D106MBABMA	B	83.4/13.7
C8020	4030019990	S.CER C1005 JB 1C 104K-T	B	77.0/8.4
C8021	4030020190	S.CER GRM32EB31C476KE15L	B	77.4/3.9
C8022	4030020190	S.CER GRM32EB31C476KE15L	B	72.0/3.9
C8023	4030018840	S.CER C3216 JF 1E 4752-T	T	100.0/9.9
C8024	4030018840	S.CER C3216 JF 1E 4752-T	B	103.1/18.0
C8025	4030019260	S.CER C3225 JB 1H 335MT	B	102.3/11.5
C8026	4030020000	S.CER C1005 JB 1A 105K-T	B	76.6/16.1
C8029	4030019990	S.CER C1005 JB 1C 104K-T	B	72.8/8.4
C8030	4030019990	S.CER C1005 JB 1C 104K-T	B	91.9/15.1
C8031	4030019990	S.CER C1005 JB 1C 104K-T	B	91.0/13.1
C8201	4030019560	S.CER GRM21BB31C106KE15L	T	38.7/29.5
C8202	4030019990	S.CER C1005 JB 1C 104K-T	T	43.1/10.4
C8203	4030019990	S.CER C1005 JB 1C 104K-T	T	41.2/27.9
C8204	4030019990	S.CER C1005 JB 1C 104K-T	B	35.5/26.8
C8205	4030019560	S.CER GRM21BB31C106KE15L	T	40.7/26.5
C8208	4030019990	S.CER C1005 JB 1C 104K-T	B	20.5/35.4
C8209	4030019990	S.CER C1005 JB 1C 104K-T	T	38.3/36.7
C8210	4030019990	S.CER C1005 JB 1C 104K-T	B	25.5/31.5
C8211	4030019990	S.CER C1005 JB 1C 104K-T	B	27.5/31.7
C8212	4030019990	S.CER C1005 JB 1C 104K-T	B	29.5/31.7
C8213	4030019990	S.CER C1005 JB 1C 104K-T	B	31.5/31.8
C8214	4030019990	S.CER C1005 JB 1C 104K-T	B	25.5/30.6
C8215	4030019990	S.CER C1005 JB 1C 104K-T	B	25.5/29.7
C8216	4030019990	S.CER C1005 JB 1C 104K-T	B	31.5/30.8
C8217	4030019990	S.CER C1005 JB 1C 104K-T	B	25.5/28.8
C8218	4030019990	S.CER C1005 JB 1C 104K-T	B	31.5/29.8
C8219	4030019990	S.CER C1005 JB 1C 104K-T	B	25.5/26.8
C8220	4030019990	S.CER C1005 JB 1C 104K-T	B	33.4/26.8
C8221	4030019990	S.CER C1005 JB 1C 104K-T	B	25.5/25.8
C8222	4030019990	S.CER C1005 JB 1C 104K-T	B	25.5/24.8
C8223	4030019990	S.CER C1005 JB 1C 104K-T	B	33.4/25.9
C8224	4030019990	S.CER C1005 JB 1C 104K-T	B	25.5/23.9
C8225	4030019990	S.CER C1005 JB 1C 104K-T	B	27.5/23.9
C8226	4030019990	S.CER C1005 JB 1C 104K-T	B	29.5/23.9
C8227	4030019990	S.CER C1005 JB 1C 104K-T	B	31.5/24.8
C8228	4030019990			

[DSP-2 UNIT]

REF NO.	PARTS NO.	DESCRIPTION	M.	H/V LOCATION
C8259	4030019990	S.CER C1005 JB 1C 104K-T	T	9.1/26.7
C8260	4030019990	S.CER C1005 JB 1C 104K-T	T	43.3/15.7
C8261	4030019990	S.CER C1005 JB 1C 104K-T	T	38.1/15.6
C8262	4030019990	S.CER C1005 JB 1C 104K-T	B	35.5/22.3
C8263	4030019990	S.CER C1005 JB 1C 104K-T	B	35.5/23.2
C8264	4030019990	S.CER C1005 JB 1C 104K-T	B	35.0/25.4
C8265	4030019990	S.CER C1005 JB 1C 104K-T	B	31.5/34.0
C8269	4030017430	S.CER C1005 CH 1H 101J-T	B	35.0/21.4
C8270	4030017780	S.CER C1005 JB 1H 472K-T	B	101.2/15.6
C8271	4030017760	S.CER C1005 JB 1H 222K-T	B	101.2/13.6
C8272	4030017420	S.CER C1005 CH 1H 470J-T	B	99.5/15.6
C8273	4030017420	S.CER C1005 CH 1H 470J-T	B	99.6/13.6
C8274	4030019490	S.CER C2012 JB 1A 106K-T	B	69.6/17.7
C8275	4030019990	S.CER C1005 JB 1C 104K-T	B	67.7/16.2
C8276	4030019990	S.CER C1005 JB 1C 104K-T	B	62.8/16.2
C8277	4030019490	S.CER C2012 JB 1A 106K-T	B	62.2/17.7
C8278	4030019990	S.CER C1005 JB 1C 104K-T	B	65.7/16.2
C8279	4030017650	S.CER C1005 CH 1H 270J-T	T	54.4/34.5
C8280	4030017650	S.CER C1005 CH 1H 270J-T	T	54.4/32.8
C8281	4030016930	S.CER C1005 JB 1A 104K-T	T	54.8/36.0
C8282	4030016930	S.CER C1005 JB 1A 104K-T	T	61.6/26.4
C8283	4030016930	S.CER C1005 JB 1A 104K-T	T	60.7/26.4
C8284	4030017400	S.CER C1005 CH 1H 220J-T	T	67.1/32.0
C8285	4030017400	S.CER C1005 CH 1H 220J-T	T	69.0/32.8
C8286	4030017400	S.CER C1005 CH 1H 220J-T	T	67.3/36.1
C8287	4030017400	S.CER C1005 CH 1H 220J-T	T	65.5/38.1
C8288	4030017400	S.CER C1005 CH 1H 220J-T	T	55.2/38.4
C8289	4030017400	S.CER C1005 CH 1H 220J-T	T	63.9/39.5
C8294	4030016930	S.CER C1005 JB 1A 104K-T	T	96.5/25.4
C8295	4030019560	S.CER GRM21BB31C106KE15L	T	95.7/23.1
C8296	4030019560	S.CER GRM21BB31C106KE15L	T	93.8/25.4
C8297	4030016930	S.CER C1005 JB 1A 104K-T	T	107.6/24.4
C8298	4030019560	S.CER GRM21BB31C106KE15L	T	110.3/24.4
C8299	4030019560	S.CER GRM21BB31C106KE15L	T	111.1/31.7
C8300	4030019560	S.CER GRM21BB31C106KE15L	T	110.3/22.6
C8301	4030017650	S.CER C1005 CH 1H 270J-T	T	110.9/25.8
C8302	4030017650	S.CER C1005 CH 1H 270J-T	T	107.7/28.2
C8303	4030019990	S.CER C1005 JB 1C 104K-T	T	96.9/29.7
C8304	4030019560	S.CER GRM21BB31C106KE15L	T	94.7/30.2
C8305	4030019560	S.CER GRM21BB31C106KE15L	T	71.0/30.0
C8306	4030020000	S.CER C1005 JB 1A 105K-T	T	73.6/30.6
C8307	4030020000	S.CER C1005 JB 1A 105K-T	T	75.9/26.5
C8308	4030019990	S.CER C1005 JB 1C 104K-T	T	73.8/32.2
C8309	4030019560	S.CER GRM21BB31C106KE15L	T	81.9/28.2
C8310	4030020000	S.CER C1005 JB 1A 105K-T	T	83.9/29.8
C8311	4030020000	S.CER C1005 JB 1A 105K-T	T	86.2/25.6
C8312	4030019990	S.CER C1005 JB 1C 104K-T	T	83.9/31.5
C8313	4030019990	S.CER C1005 JB 1C 104K-T	B	70.5/21.6
C8314	4030019990	S.CER C1005 JB 1C 104K-T	B	79.6/22.4
C8315	4030019990	S.CER C1005 JB 1C 104K-T	T	99.2/34.2
C8316	4030019120	S.CER GRM188B31E105KA75D	T	104.6/36.8
C8318	4030019560	S.CER GRM21BB31C106KE15L	B	58.0/35.5
C8319	4030019560	S.CER GRM21BB31C106KE15L	B	62.7/35.1
C8320	4030019560	S.CER GRM21BB31C106KE15L	B	65.4/37.8
C8321	4030019120	S.CER GRM188B31E105KA75D	B	65.2/32.3
C8322	4030019120	S.CER GRM188B31E105KA75D	T	96.7/36.1
C8323	4030019560	S.CER GRM21BB31C106KE15L	T	99.2/38.2
C8324	4030019560	S.CER GRM21BB31C106KE15L	T	101.1/38.2
C8325	4030019510	S.CER GRM32EB31E226KE15L	T	87.8/16.4
C8326	4030019510	S.CER GRM32EB31E226KE15L	T	86.3/10.8
C8327	4030019460	S.CER C1608 JB 0J 106M-T	T	50.0/24.2
C8328	4030019460	S.CER C1608 JB 0J 106M-T	T	50.0/17.3
C8329	4030020000	S.CER C1005 JB 1A 105K-T	T	53.1/19.3
C8330	4030020000	S.CER C1005 JB 1A 105K-T	T	51.5/19.3
C8331	4030020000	S.CER C1005 JB 1A 105K-T	T	51.5/26.3
C8332	4030020000	S.CER C1005 JB 1A 105K-T	T	53.1/26.3
C8333	4030019990	S.CER C1005 JB 1C 104K-T	B	95.4/23.4
J8201	6510027580	S.CON 16FLT-SM2-TB(LF)(SN)(M)	T	37.3/11.1
J8202	6510022201	S.CON 40FLZ-SM2-R-TB(LF)(SN)	B	45.1/19.6
J8203	6510023921	S.CON 20FLZ-SM2-TB(LF)(SN)	T	16.2/12.5
J8204	6510028090	S.CON ASP-153805-01	T	68.9/20.1
F8001	5210001150	S.FUS 046601.5NR	T	91.5/9.9
F8002	5210001150	S.FUS 046601.5NR	T	51.1/12.5
EP8001	6910014730	S.BEA MPZ2012S331A-T	T	50.9/8.9
EP8003	6910014730	S.BEA MPZ2012S331A-T	T	88.2/6.0
EP8005	6910014730	S.BEA MPZ2012S331A-T	T	89.2/19.8
EP8201	6910014690	S.BEA MPZ1608S221A-T	T	40.9/38.7
EP8202	6910014690	S.BEA MPZ1608S221A-T	B	40.6/15.6
EP8204	6910014730	S.BEA MPZ2012S331A-T	T	72.3/12.0
EP8205	6910014730	S.BEA MPZ2012S331A-T	T	95.7/9.9
EP8206	6910014730	S.BEA MPZ2012S331A-T	B	66.2/17.7
EP8207	6910014730	S.BEA MPZ2012S331A-T	B	64.2/14.8
EP8212	6910012350	S.BEA MMZ1608Y 102BT	B	62.3/32.3
EP8213	6910012350	S.BEA MMZ1608Y 102BT	T	108.6/32.0
EP8214	6910012350	S.BEA MMZ1608Y 102BT	T	108.6/30.7
EP8217	6910014680	S.BEA MMZ1608Y 121BT	B	72.7/21.7
EP8218	6910014680	S.BEA MMZ1608Y 121BT	B	81.1/23.3
EP8219	6910012350	S.BEA MMZ1608Y 102BT	T	79.6/14.2
EP8220	6910012350	S.BEA MMZ1608Y 102BT	T	83.4/14.2
EP8221	6910014680	S.BEA MMZ1608Y 121BT	B	91.8/22.0

Eqv.= This component is equivalent to the REF No. component listed above, and may be substituted on parts orders and repairs.

[DISPLAY UNIT]

REF NO.	PARTS NO.	DESCRIPTION	M.	H/V LOCATION
IC6001	1110005771	S.IC S-80942CNMC-G9CT2G	B	62.4/9.1
IC6002	1130007111	S.IC TC7W04FU(TE12LF)	B	89.9/37.1
IC6004	1140016600	S.IC R4F20223DFD (SX-3500B)	B	82.7/21.9
IC6005	1110007630	S.IC NJM2783V-TE1-#ZZZH	B	45.3/34.0
IC6006	1130006551	S.IC TC7S08FU(TE85RF)	B	118.9/39.0
IC6007	1180002690	S.REG S-812C36AMC-C2Q-T2G	B	117.7/9.2
IC6008	1110005761	S.IC S-812C50AUA-C3E-G	B	122.1/10.5
IC6009	1180001541	S.IC TA78L08F(TE12LF)	B	113.1/47.4
IC6010	1110003800	S.IC NJM2904V-TE1-#FMZB	B	115.5/17.5
IC6011	1180003640	S.REG NJM2835DL1-10-TE1-#ZZZB	B	139.0/8.8
IC6012	1130015440	S.IC TC7SZ07FU(TE85LF)	B	107.0/25.1
IC6013	1130015440	S.IC TC7SZ07FU(TE85LF)	B	112.2/25.1
IC6014	1110003800	S.IC NJM2904V-TE1-#FMZB	T	66.8/29.2
Q6001	1590002490	S.TRA UMZ2N TR	B	94.6/37.7
Q6002	1590001330	S.TRA DTA114EUA T106	B	118.4/44.5
Q6003	1590000680	S.TRA DTC114EUA T106	B	119.1/41.6
Q6301	1530004210	S.TRA DSC7004SOL	B	33.2/10.6
Q6302	1530004210	S.TRA DSC7004SOL	B	49.6/22.8
Q6303	1530004210	S.TRA DSC7004SOL	B	124.4/26.4
Q6304	1540000680	S.TRA 2SD1802S/T-TL-E	T	75.1/29.2
D6001	1750002870	S.DIO 1SS355 <MID>	B	21.8/43.0
D6002	1750002870	S.DIO 1SS355 <MID>	B	19.3/43.0
D6003	1750002870	S.DIO 1SS355 <MID>	B	16.8/43.0
D6004	1750002870	S.DIO 1SS355 <MID>	B	96.6/35.4
D6005	1750000370	S.DIO DA221 TL	B	108.7/28.1
D6006	1750000370	S.DIO DA221 TL	B	114.7/27.1
D6007	1750001810	S.DIO L1SS400T1G <SLV>	B	118.3/13.0
X6001	6050010501	S.XTA CR-636A SMD-49 14.7456 MHz <KDS>	B	77.2/8.1
L6001	6200005011	S.COI NLV25T-100J	B	13.7/43.0
L6002	6200005011	S.COI NLV25T-100J	B	10.2/42.4
L6003	6200009300	S.COI ELJPA 100KF 10U	B	113.7/7.7
L6004	6200003950	S.COI HF50ACC 322513-T	B	41.9/8.2
L6005	6200003520	S.COI ELJFB 102K-F	B	42.7/41.0
L6006	6200005160	S.COI 7A06L-101K-A	B	113.7/34.0
L6007	6200003950	S.COI HF50ACC 322513-T	B	125.7/37.5
L6008	6200003950	S.COI HF50ACC 322513-T	B	120.1/33.8
L6009	6200003950	S.COI HF50ACC 322513-T	B	126.4/34.2
R6001	7030003480	S.RES ERJ3GEYJ 222 V (2.2K)	B	21.8/46.2
R6003	7030003480	S.RES ERJ3GEYJ 222 V (2.2K)	B	19.3/46.2
R6004	7030003650	S.RES ERJ3GEYJ 563 V (56K)	B	68.4/10.9
R6005	7030003650	S.RES ERJ3GEYJ 563 V (56K)	B	66.0/8.3
R6006	7030003560	S.RES ERJ3GEYJ 103 V (10K)	B	67.2/10.9
R6007	7030003440	S.RES ERJ3GEYJ 102 V (1K)	B	57.6/26.5
R6008	7030003440	S.RES ERJ3GEYJ 102 V (1K)	B	59.0/23.9
R6009	7030003620	S.RES ERJ3GEYJ 333 V (33K)	B	96.5/39.9
R6010	7030003540	S.RES ERJ3GEYJ 682 V (6.8K)	B	93.9/39.9
R6011	7030003590	S.RES ERJ3GEYJ 183 V (18K)	B	96.5/37.8
R6012	7030003640	S.RES ERJ3GEYJ 473 V (47K)	B	93.9/34.9
R6013	7030003640	S.RES ERJ3GEYJ 473 V (47K)	B	86.7/77.1
R6014	7030003860	S.RES ERJ3GE JPW V	B	67.2/8.3
R6015	7030003640	S.RES ERJ3GEYJ 473 V (47K)	B	68.5/14.2
R6016	7030003560	S.RES ERJ3GEYJ 103 V (10K)	B	65.8/12.6
R6019	7030003640	S.RES ERJ3GEYJ 473 V (47K)	B	63.0/14.1
R6020	7030003680	S.RES ERJ3GEYJ 104 V (100K)	B	86.3/38.4
R6021	7030003680	S.RES ERJ3GEYJ 104 V (100K)	B	86.8/40.5
R6022	7030003640	S.RES ERJ3GEYJ 473 V (47K)	B	67.2/14.2
R6026	7510001671	S.THR NTCG16 4BH 103JT	B	91.9/9.9
R6029	7030003640	S.RES ERJ3GEYJ 473 V (47K)	B	71.9/15.1
R6031	7030003510	S.RES ERJ3GEYJ 392 V (3.9K)	B	93.5/19.9
R6032	7030003640	S.RES ERJ3GEYJ 473 V (47K)	B	90.2/13.4
R6033	7030003640	S.RES ERJ3GEYJ 473 V (47K)	B	93.3/18.0
R6035	7030003640	S.RES ERJ3GEYJ 473 V (47K)	B	92.1/13.7
R6036	7030003640	S.RES ERJ3GEYJ 473 V (47K)	B	93.3/16.8
R6038	7030003640	S.RES ERJ3GEYJ 473 V (47K)	B	92.9/15.6
R6041	7030003860	S.RES ERJ3GE JPW V	B	41.9/36.3
R6046	7030003400	S.RES ERJ3GEYJ 471 V (47K)	B	47.1/26.4
R6047	7030003540	S.RES ERJ3GEYJ 682 V (6.8K)	B	37.0/29.0
R6048	7030003620	S.RES ERJ3GEYJ 333 V (33K)	B	46.7/28.8
R6049	7030003520	S.RES ERJ3GEYJ 472 V (4.7K)	B	37.0/30.2
R6051	7030003640	S.RES ERJ3GEYJ 473 V (47K)	B	71.0/26.4
R6052	7030003640	S.RES ERJ3GEYJ 473 V (47K)	B	89.0/33.0
R6053	7030003660	S.RES ERJ3GEYJ 683 V (68K)	B	48.0/44.3
R6054	7030003500	S.RES ERJ3GEYJ 332 V (3.3K)	B	125.2/47.5
R6055	7030003640	S.RES ERJ3GEYJ 473 V (47K)	B	87.8/32.9
R6056	7030003640	S.RES ERJ3GEYJ 473 V (47K)	B	90.0/9.1
R6057	7030003640	S.RES ERJ3GEYJ 473 V (47K)	B	90.0/10.3
R6059	7030006060	S.RES ERJ12YJ100U (10)	B	133.6/6.0
R6060	7030003640	S.RES ERJ3GEYJ 473 V (47K)	B	110.2/19.3
R6061	7030003440	S.RES ERJ3GEYJ 102 V (1K)	B	111.7/28.8
R6063	7030003640	S.RES ERJ3GEYJ 473 V (47K)	B	115.8/28.8
R6064	7030003860	S.RES ERJ3GE JPW V	B	110.2/18.0
R6065	7030003440	S.RES ERJ3GEYJ 102 V (1K)	B	116.7/30.0
R6066	7030003440	S.RES ERJ3GEYJ 102 V (1K)	B	118.4/28.8
R6068	7030003580	S.RES ERJ3GEYJ 153 V (15K)	B	120.0/17.5
R6069	7030003740	S.RES ERJ3GEYJ 334 V (330K)	B	119.7/21.2
R6071				

[DISPLAY UNIT]

REF NO.	PARTS NO.	DESCRIPTION	M.	H/V LOCATION
R6311	7030003640	S.RES ERJ3GEYJ 473 V (47K)	B	71.8/20.9
R6326	7030003560	S.RES ERJ3GEYJ 103 V (10K)	B	37.6/9.1
R6327	7030003270	S.RES ERJ3GEYJ 390 V (39)	B	31.9/13.8
R6328	7030003270	S.RES ERJ3GEYJ 390 V (39)	B	31.9/15.0
R6329	7030003590	S.RES ERJ3GEYJ 183 V (18K)	B	46.1/23.8
R6330	7030003510	S.RES ERJ3GEYJ 392 V (3.9K)	B	121.2/28.0
R6331	7030003270	S.RES ERJ3GEYJ 390 V (39)	B	53.5/18.2
R6332	7030003270	S.RES ERJ3GEYJ 390 V (39)	B	128.2/28.3
R6334	7030003270	S.RES ERJ3GEYJ 390 V (39)	B	128.2/27.1
R6336	7030003270	S.RES ERJ3GEYJ 390 V (39)	B	128.2/25.9
R6338	7030003640	S.RES ERJ3GEYJ 473 V (47K)	B	74.8/34.0
R6339	7030003640	S.RES ERJ3GEYJ 473 V (47K)	B	73.6/34.0
R6340	7030003640	S.RES ERJ3GEYJ 473 V (47K)	B	72.4/34.0
R6342	7030003560	S.RES ERJ3GEYJ 103 V (10K)	B	116.0/13.4
R6343	7030003800	S.RES ERJ3GEYJ 105 V (1M)	B	112.9/12.1
R6344	7030003440	S.RES ERJ3GEYJ 102 V (1K)	B	121.2/20.1
R6345	7030003440	S.RES ERJ3GEYJ 102 V (1K)	T	64.8/25.0
R6346	7030010410	S.RES ERJ1TYJ 220U (22)	T	81.6/28.3
R6347	7510001671	S.THR NTCG16 4BH 103JT	T	62.9/29.1
R6348	7030003480	S.RES ERJ3GEYJ 222 V (2.2K)	T	64.1/29.1
R6349	7030003560	S.RES ERJ3GEYJ 103 V (10K)	T	63.6/25.0
R6350	7030003720	S.RES ERJ3GEYJ 224 V (220K)	T	67.0/24.6
R6352	7030003640	S.RES ERJ3GEYJ 473 V (47K)	B	72.5/25.1
R6353	7030003420	S.RES ERJ3GEYJ 681 V (680)	B	10.3/45.2
R6354	7540000390	S.ABS EZAEG3A50AV	B	10.5/40.4
C6001	4030006880	S.CER C1608 JB 1H 472K-T	B	16.1/39.2
C6002	4030006860	S.CER C1608 JB 1H 102K-T	B	22.3/40.4
C6003	4030006880	S.CER C1608 JB 1H 472K-T	B	13.3/39.2
C6004	4030006860	S.CER C1608 JB 1H 102K-T	B	19.3/40.4
C6005	4030006880	S.CER C1608 JB 1H 472K-T	B	10.5/39.2
C6006	4550008220	S.TAN F931C106MAA	B	27.6/48.9
C6007	4030006880	S.CER C1608 JB 1H 472K-T	B	9.1/45.2
C6008	4030018980	S.CER C1608 JB 1H 104K-T	B	64.8/8.3
C6009	4030006880	S.CER C1608 JB 1H 472K-T	B	56.1/23.9
C6010	4510009700	S.ELE EEEFK1C101P	B	108.2/7.6
C6011	4030008880	S.CER C1608 JB 1H 223K-T	B	60.0/9.1
C6012	4030018980	S.CER C1608 JB 1H 104K-T	B	113.7/10.6
C6013	4030007020	S.CER C1608 CH 1H 120J-T	B	83.6/10.9
C6014	4030007020	S.CER C1608 CH 1H 120J-T	B	81.5/11.6
C6015	4030006880	S.CER C1608 JB 1H 472K-T	B	57.3/23.9
C6016	4030006900	S.CER C1608 JB 1H 103K-T	B	89.4/40.5
C6017	4030017480	S.CER C1608 JB 1A 474K-T	B	64.2/14.1
C6018	4030006900	S.CER C1608 JB 1H 103K-T	B	87.3/11.2
C6019	4550007390	S.TAN F931C225MAABMA	B	53.8/36.3
C6021	4550008220	S.TAN F931C106MAA	B	49.2/29.2
C6023	4550007260	S.TAN F931C475MAABMA	B	37.6/27.2
C6025	4550007670	S.TAN F931C105MAABMA	B	42.7/27.2
C6026	4550007670	S.TAN F931C105MAABMA	B	40.9/29.4
C6027	4550007390	S.TAN F931C225MAABMA	B	68.5/31.8
C6028	4550007670	S.TAN F931C105MAABMA	B	64.0/31.8
C6029	4550007260	S.TAN F931C475MAABMA	B	49.2/35.4
C6033	4550008220	S.TAN F931C106MAA	B	47.7/41.8
C6034	4510009300	S.ELE EEEHB1H2R2R	B	27.8/42.7
C6035	4550007670	S.TAN F931C105MAABMA	B	48.2/39.6
C6036	4550008220	S.TAN F931C106MAA	B	46.0/45.5
C6037	4030006880	S.CER C1608 JB 1H 472K-T	B	40.2/37.9
C6038	4550007520	S.TAN F931A106MAABMA	B	125.5/13.9
C6039	4030018980	S.CER C1608 JB 1H 104K-T	B	91.0/7.2
C6041	4030018980	S.CER C1608 JB 1H 104K-T	B	121.3/7.1
C6042	4030006880	S.CER C1608 JB 1H 472K-T	B	39.0/37.9
C6043	4030018980	S.CER C1608 JB 1H 104K-T	B	125.6/4.2
C6044	4510009330	S.ELE EEEHA1E470WP	B	128.2/8.5
C6045	4550008220	S.TAN F931C106MAA	B	108.1/46.9
C6046	4030018980	S.CER C1608 JB 1H 104K-T	B	118.2/5.7
C6047	4030018980	S.CER C1608 JB 1H 104K-T	B	113.8/4.6
C6048	4030018980	S.CER C1608 JB 1H 104K-T	B	117.9/48.5
C6049	4550007520	S.TAN F931A106MAABMA	B	121.3/5.4
C6050	4550007520	S.TAN F931A106MAABMA	B	100.6/6.1
C6052	4030018980	S.CER C1608 JB 1H 104K-T	B	112.9/28.0
C6053	4030018980	S.CER C1608 JB 1H 104K-T	B	117.9/47.2
C6054	4510009330	S.ELE EEEHA1E470WP	B	112.5/41.0
C6055	4030007090	S.CER C1608 CH 1H 470J-T	B	127.5/30.2
C6056	4030007090	S.CER C1608 CH 1H 470J-T	B	126.1/30.6
C6058	4030006880	S.CER C1608 JB 1H 472K-T	B	120.0/36.4
C6059	4030006880	S.CER C1608 JB 1H 472K-T	B	122.7/41.2
C6060	4030006880	S.CER C1608 JB 1H 472K-T	B	122.6/48.5
C6061	4030007130	S.CER C1608 CH 1H 101J-T	B	123.4/46.8
C6062	4030019550	S.CER C1608 JB 1E 334K-T	B	133.6/12.7
C6063	4030018980	S.CER C1608 JB 1H 104K-T	B	116.0/14.6
C6064	4550008140	S.TAN F931E225MAA	B	145.1/10.8
C6065	4550007670	S.TAN F931C105MAABMA	B	53.8/34.1
C6066	4550007670	S.TAN F931C105MAABMA	B	53.8/31.9
C6067	4550007670	S.TAN F931C105MAABMA	B	61.6/31.8
C6068	4550007390	S.TAN F931C225MAABMA	B	66.4/31.8
C6071	4030018980	S.CER C1608 JB 1H 104K-T	B	133.6/11.5
C6072	4030018980	S.CER C1608 JB 1H 104K-T	B	143.8/12.8
C6073	4550007390	S.TAN F931C225MAABMA	B	70.6/31.8
C6074	4030018980	S.CER C1608 JB 1H 104K-T	B	92.3/19.9
C6301	4030018980	S.CER C1608 JB 1H 104K-T	B	69.5/25.1
C6302	4030018980	S.CER C1608 JB 1H 104K-T	B	36.1/13.1
C6303	4030018980	S.CER C1608 JB 1H 104K-T	B	48.9/18.2
C6304	4030018980	S.CER C1608 JB 1H 104K-T	B	128.2/24.6
C6305	4030018980	S.CER C1608 JB 1H 104K-T	B	116.0/12.2
C6308	4030006900	S.CER C1608 JB 1H 103K-T	B	116.5/20.4
C6309	4030018980	S.CER C1608 JB 1H 104K-T	T	78.5/25.2
C6310	4030006900	S.CER C1608 JB 1H 103K-T	T	63.6/31.1
C6311	4030006900	S.CER C1608 JB 1H 103K-T	T	84.1/29.7
J6001	6510029490	S.CON 10FLZ-SM2-TB(LF)(SN)	B	16.5/32.3
J6002	6510028030	S.CON 28FLZ-SM2-GB-TB(LF)(SN)	B	68.4/39.8
J6003	6510027950	S.CON BM13B-SRSS-TBT(LF)(SN)	B	134.2/38.0
J6005	6510022621	S.CON 10FMN-BMTTR-A-TBT(LF)(SN)	B	55.8/11.3

Eqv.= This component is equivalent to the REF No. component listed above, and may be substituted on parts orders and repairs.

[DISPLAY UNIT]

REF NO.	PARTS NO.	DESCRIPTION	M.	H/V LOCATION
DS1	5030003450	LCD CMF2P2007-E<SKD>		
DS6301	5040002930	S.LED SML-512MW T86	T	23.2/39.2
DS6302	5040002930	S.LED SML-512MW T86	T	10.2/39.2
DS6303	5040002930	S.LED SML-512MW T86	T	57.7/5.4
DS6304	5040002930	S.LED SML-512MW T86	T	79.0/5.4
DS6309	5040002930	S.LED SML-512MW T86	T	111.8/28.0
DS6310	5040002930	S.LED SML-512MW T86	T	111.8/12.4
DS6313	5040002930	S.LED SML-512MW T86	T	137.3/43.6
DS6314	5040002930	S.LED SML-512MW T86	T	111.8/38.3
DS6319	5040002930	S.LED SML-512MW T86	T	142.8/30.4
DS6320	5040002930	S.LED SML-512MW T86	T	131.9/30.4
DS6323	5040002930	S.LED SML-512MW T86	T	142.8/12.8
DS6324	5040002930	S.LED SML-512MW T86	T	131.9/12.8
S6301	2230001110	S.SWI SKRSPACE010	T	23.2/34.8
S6302	2230001110	S.SWI SKRSPACE010	T	23.2/43.6
S6303	2230001110	S.SWI SKRSPACE010	T	10.2/43.6
S6304	2230001110	S.SWI SKRSPACE010	T	10.2/34.8
S6305	2230001110	S.SWI SKRSPACE010	T	47.1/5.4
S6306	2230001110	S.SWI SKRSPACE010	T	68.4/5.4
S6307	2230001110	S.SWI SKRSPACE010	T	89.7/5.4
S6308	2230001110	S.SWI SKRSPACE010	T	126.4/34.8
S6309	2230001110	S.SWI SKRSPACE010	T	137.3/34.8
S6310	2230001110	S.SWI SKRSPACE010	T	148.2/34.8
S6311	2230001110	S.SWI SKRSPACE010	T	126.4/26.0
S6312	2230001110	S.SWI SKRSPACE010	T	137.3/26.0
S6313	2230001110	S.SWI SKRSPACE010	T	148.2/26.0
S6314	2230001110	S.SWI SKRSPACE010	T	126.4/17.2
S6315	2230001110	S.SWI SKRSPACE010	T	137.3/17.2
S6316	2230001110	S.SWI SKRSPACE010	T	148.2/17.2
S6317	2230001110	S.SWI SKRSPACE010	T	126.2/8.4
S6318	2230001110	S.SWI SKRSPACE010	T	137.2/8.4
S6319	2230001110	S.SWI SKRSPACE010	T	148.2/8.4
S6320	2230001110	S.SWI SKRSPACE010	T	129.1/43.6
S6321	2230001110	S.SWI SKRSPACE010	T	145.5/43.6
S6322	2230001110	S.SWI SKRSPACE010	T	111.8/43.5
S6323	2230001110	S.SWI SKRSPACE010	T	111.8/33.2
S6324	2230001110	S.SWI SKRSPACE010	T	111.8/20.2
S6325	2230001110	S.SWI SKRSPACE010	T	111.8/7.3
EP6001	6910012350	S.BEA MMZ1608Y 102BT	B	129.9/40.5
EP6002	6910012350	S.BEA MMZ1608Y 102BT	B	129.8/38.1
EP6003	6910012350	S.BEA MMZ1608Y 102BT	B	129.7/32.8
EP6004	6910012350	S.BEA MMZ1608Y 102BT	B	129.8/39.3
EP6005	6910012350	S.BEA MMZ1608Y 102BT	B	129.4/30.9
EP6009	6910012350	S.BEA MMZ1608Y 102BT	B	137.7/41.0

M.=Mounted side (T: Mounted on the Top side, B: Mounted on the Bottom side) S.=Surface mount

[MIC UNIT]

REF NO.	PARTS NO.	DESCRIPTION	M.	H/V LOCATION
C6901	4030006860	S.CER C1608 JB 1H 102K-T	B	8.5/8.6
J6901 J6902	6510025142 6510022440	S.CON 10FLT-SM2-TB(LF)(SN)(M) CON LTW-8MP-C NUTGASKET <LIA>	B	10.0/5.0

Eqv.= This component is equivalent to the REF No. component listed above, and may be substituted on parts orders and repairs.

M.=Mounted side (T: Mounted on the Top side, B: Mounted on the Bottom side)
S.=Surface mount

SECTION 7

MECHANICAL PARTS

[CHASSIS PARTS]

REF NO.	ORDER NO.	DESCRIPTION	QTY.
W101**	8920000170	CAB-1017	1
W102**	8920000550	CAB-1058	1 [EXP-01]
	8920000550	CAB-1058	1 [AUS-01]
	8920000580	CAB-1065	1 [USA-01]
	8920000550	CAB-1058	1 [UN-01]
	8920000550	CAB-1058	1 [EXP-02]
	8920000550	CAB-1058	1 [AUS-02]
	8920000580	CAB-1065	1 [USA-02]
	8920000550	CAB-1058	1 [UN-02]
	8920000550	CAB-1058	1 [EXP-03]
	8920000550	CAB-1058	1 [AUS-03]
	8920000580	CAB-1065	1 [USA-03]
	8920000550	CAB-1058	1 [UN-03]
W103**	8970024762	1.5DCOAXIAL130MM-2 C31/C31	1
W107**	8900019690	OPC-2117 MJ0.4JC1.5/58AU	1
W108**	8900016110	OPC-1680 (P0.5N30L100)	1
W109**	8900016110	OPC-1680 (P0.5N30L100)	1
W110**	8900014871	OPC-1332A-1 (P0.5N40L100) TJM	1
W111**	8900019630	OPC-2067	1
W113**	8900020281	OPC-2083B <PHL>	1
W114**	8900019700	OPC-2128	1
W115**	8900018760	OPC-1969 (P0.5N20L60)	1
W116**	8900017660	OPC-1877 (P0.5N20L100)	1
W117**	8900020020	OPC-2139	1
W118**	8900020200	OPC-2146	1
W119	8920000490	CAB-1056	1
MP1	8820000872	1705 CAP SCREW-2	4 [EXP-01]
	8820000872	1705 CAP SCREW-2	4 [AUS-01]
	8820000872	1705 CAP SCREW-2	4 [USA-01]
	8820000872	1705 CAP SCREW-2	4 [UN-01]
	8820000872	1705 CAP SCREW-2	8 [EXP-02]
	8820000872	1705 CAP SCREW-2	8 [AUS-02]
	8820000872	1705 CAP SCREW-2	8 [USA-02]
	8820000872	1705 CAP SCREW-2	8 [UN-02]
	8820000872	1705 CAP SCREW-2	8 [EXP-03]
	8820000872	1705 CAP SCREW-2	4 [AUS-03]
	8820000872	1705 CAP SCREW-2	4 [USA-03]
	8820000872	1705 CAP SCREW-2	4 [UN-03]
MP2	8930070860	O-RING (BM) (TOT)	1
MP4	8820000530	FLANGE BOLT M4 X 8 NI	1
MP5	8810008661	PHBT M3 X 8 NI-ZC3	30
MP6	8810004301	PH M3 X10 ZK3	6
MP7	8810005771	BIND M3 X 8 ZK3BLACK	8
MP9	8930048550	2177 CLIP	1
MP10	8810003171	SET SCREWA M3 X 8 ZC3	5
MP11	8810007231	SET SCREWH M3 X 8 ZC3	2
MP16	8010021983	3296 CHASSIS-3	1
MP17	8110009990	3296 U-COVER	1
MP18	8110010000	3296 L-COVER	1
MP22	8930082010	3296 U-SEAL (TOT)	1
MP23	8930082020	3296 L-SEAL (TOT)	1
MP24	8930082030	3296 BUSH PLATE	1
MP25	8930082040	3296 A-BUSH PLATE	1
MP37	8810003161	SET SCREWA M3 X 6 ZC3	2
MP42	8930069580	THERMAL SHEET (BA) TC-600HS-1.4 (14.5	1
MP43	8930068820	THERMAL SHEET (AX)TC-600HS-1.4 (9.7)	4
MP44	8930053472	THERMAL SHEET (R)-2 TC200HS (10X10)	1
MP45	8950000180	CABLE TIE-80 (DENNISON DS-80)	4
MP46	6950000040	M-TYPE CAP (BLACK)	1
MP48	8930083200	MS-F SD460X610-T0 (50X50)	2
MP51	8930056211	SHIELD SPONGE (G)-1	1
MP52	8930056211	SHIELD SPONGE (G)-1	1
MP53	8930069680	FERRITE SHEET (P)	1
MP55	8930084360	HEXAGON SPACER (AH)	4
MP56**	8930007500	THERMAL SHEET J	1

[MAIN UNIT]

REF NO.	ORDER NO.	DESCRIPTION	QTY.
J1001*	6510023092	20FLT-SM2-TB (LF) (SN) (M)	1
J1002*	6510027580	16FLT-SM2-TB (LF) (SN) (M)	1
J1003*	6510027950	BM13B-SRSS-TBT (LF) (SN)	1
J1004*	6510021722	30FLT-SM2-TB (LF) (SN) (M)	1
J1005*	6510021722	30FLT-SM2-TB (LF) (SN) (M)	1
J1101*	6510018450	TMP-S01X-B1 0	1
J1102*	6510018450	TMP-S01X-B1 0	1
J1801*	6510022621	10FMN-BMTTR-A-TBT (LF) (SN)	1
J1802*	6510028400	HU-1632-T	1
BT1001*	3020000400	CR1632/BK	1
EP1402*	6910002161	CASE-BM7H-LF	1
EP1404*	6910002161	CASE-BM7H-LF	1
EP1802*	6910002161	CASE-BM7H-LF	1
EP1803*	6910002161	CASE-BM7H-LF	1
MP1001*	8930065741	2590 D-EARTH SPRING-1	1
MP1003*	8510020070	3296 C-SHIELD CASE Y1218	1
MP1004*	8510020080	3296 D-SHIELD CASE Y1219	1
MP1005*	8510020190	3296 A-SHIELD PLATE Y1231	1
MP1006*	8510020140	3296 A-MAIN CASE Y1229	1
MP1007*	8510020150	3296 SHIELD PLATE Y1230	1
MP1009*	8510020130	3296 MAIN CASE Y1228	1
MP1010	8930065741	2590 D-EARTH SPRING-1	1
MP1012*	8930058840	SHIELD SPONGE (T)	1
MP1015*	8930058840	SHIELD SPONGE (T)	1
MP1016*	8930058840	SHIELD SPONGE (T)	1
MP1017*	8930065741	2590 D-EARTH SPRING-1	1

[PA UNIT]

REF NO.	ORDER NO.	DESCRIPTION	QTY.
J4001*	6510018450	TMP-S01X-B1	1
J4002*	6510023092	20FLT-SM2-TB (LF) (SN) (M)	1
J4003*	6510015541	B4B-ZR-SM4-TF (LF) (SN)	1
J4004*	6510021531	IMSA-9230B-1-04Z024-PT1	1
J4005*	6510021531	IMSA-9230B-1-04Z024-PT1	1
J4006*	6510021391	IMSA-9230B-1-03Z024-PT1	1
J4007*	6510021391	IMSA-9230B-1-03Z024-PT1	1
J4008*	6510028210	SJ050010 (TMP-J01X-V6)	1
J4009*	6510027580	16FLT-SM2-TB (LF) (SN) (M)	1
J4010*	6510018961	B2B-PH-SM4-TB (LF) (SN)	1
J5001*	6510028210	SJ050010 (TMP-J01X-V6)	1
J5002*	6510018450	TMP-S01X-B1	1
J5005*	6510018450	TMP-S01X-B1	1
F4001*	5220000400	FHA010-01F	1
F4002*	5210000940	1205	1
S4001*	2260003250	DECASMD050F/60-2 <UDX>	1
EP4004*	6910020710	OT-047 M3	1
EP4005*	6910020710	OT-047 M3	1
MP4001*	8510020760	3500 PA CASE	1
MP4002*	8930076670	THERMAL SHEET (BM)TC700HS1.4 (15X22)	2
MP4004	8930065741	2590 D-EARTH SPRING-1	1
MP4006	8930077680	3015 PA EARTH SPRING	1
MP4007*	8930065741	2590 D-EARTH SPRING-1	1
MP4008*	8510021040	3500 SHIELD PLATE	1 [USA-01]
	8510021040	3500 SHIELD PLATE	1 [USA-02]
	8510021040	3500 SHIELD PLATE	1 [USA-03]
MP4009*	8930086691	2427 EARTH SPRING (A)-1	1 [USA-01]
	8930086691	2427 EARTH SPRING (A)-1	1 [USA-02]
	8930086691	2427 EARTH SPRING (A)-1	1 [USA-03]
MP4010	8930079760	SHIELD SPONGE (CO)	1
MP4011	8930079760	SHIELD SPONGE (CO)	1
MP4012*	8930059330	SHIELD SPONGE (W)	1 [USA-01]
	8930059330	SHIELD SPONGE (W)	1 [USA-02]
	8930059330	SHIELD SPONGE (W)	1 [USA-03]
MP4013*	8930059330	SHIELD SPONGE (W)	1 [USA-01]
	8930059330	SHIELD SPONGE (W)	1 [USA-02]
	8930059330	SHIELD SPONGE (W)	1 [USA-03]
MP5004*	8930065741	2590 D-EARTH SPRING-1	1
MP5005*	8930065741	2590 D-EARTH SPRING-1	1
MP5006*	8930065741	2590 D-EARTH SPRING-1	1
MP5007*	8930065741	2590 D-EARTH SPRING-1	1

*: Refer to "BOARD LAYOUTS" for the location.

** : Refer to "GENERAL WIRING" for the connection

Screw abbreviations A, B0, BT: Self-tapping PH: Pan head ZK: Black NI-ZU: Nickel-Zinc SUS: Stainless

[DRIVER UNIT]

REF NO.	ORDER NO.	DESCRIPTION	QTY.
MP6851*	8410002480	2429 PA HEATSINK	1

[DSP-1 UNIT]

REF NO.	ORDER NO.	DESCRIPTION	QTY.
J3001*	6510021722	30FLT-SM2-TB (LF) (SN) (M)	1
J3002*	6510021722	30FLT-SM2-TB (LF) (SN) (M)	1
J3006*	6510018961	B2B-PH-SM4-TB (LF) (SN)	1
J3007*	6510026650	BM12B-SRSS-TBT (LF) (SN)	1
J3303*	6510023092	20FLT-SM2-TB (LF) (SN) (M)	1
J3305*	6510024751	(G)BM07B-SRSS-TB (LF) (SN)	1
J3306*	6510025990	(G)BM05B-SRSS-TB (LF) (SN)	1
J3307*	6510022472	40FLT-SM2-TB (LF) (SN) (M)	1
J3308*	6510018961	B2B-PH-SM4-TB (LF) (SN)	1
MP3001	8510020040	3296 SHIELD CASE	1

[DSP-2 UNIT]

REF NO.	ORDER NO.	DESCRIPTION	QTY.
J8201*	6510027580	16FLT-SM2-TB (LF) (SN) (M)	1
J8202*	6510022201	40FLZ-SM2-R-TB (LF) (SN)	1
J8203*	6510023921	20FLZ-SM2-TB (LF) (SN)	1
J8204*	6510028090	ASP-153805-01	1
F8001*	5210001150	046601.5NR	1
F8002*	5210001150	046601.5NR	1
MP8001	8510020750	3500 SHIELD CASE	1

[FRONT UNIT]

REF NO.	ORDER NO.	DESCRIPTION	QTY.
W1	8900020400	OPC-2216	1
MP1	8810009181	BT M2 X 5 NI-ZC3	7
MP2	8210026640	3296 FRONT PANEL	1
MP3	8930081610	3296 4-KEY <YAM>	1
MP4	8930087200	3296 KEYBOARD (A) <YAM>	1
MP5	8310077300	3296 WINDOW PLATE	1
MP6	8930082090	3296 WINDOW SHEET	1

[DISPLAY UNIT]

REF NO.	ORDER NO.	DESCRIPTION	QTY.
J6001*	6510029490	10FLZ-SM2-TB (LF) (SN)	1
J6002*	6510028030	28FLZ-SM2-GB-TB (LF) (SN)	1
J6003*	6510027950	BM13B-SRSS-TBT (LF) (SN)	1
J6005*	6510022621	10FMN-BMTTR-A-TBT (LF) (SN)	1
DS1	5030003450	CMF2P2007-E <SKD>	1
S6301*	2230001110	SKRPACE010	1
S6302*	2230001110	SKRPACE010	1
S6303*	2230001110	SKRPACE010	1
S6304*	2230001110	SKRPACE010	1
S6305*	2230001110	SKRPACE010	1
S6306*	2230001110	SKRPACE010	1
S6307*	2230001110	SKRPACE010	1
S6308*	2230001110	SKRPACE010	1
S6309*	2230001110	SKRPACE010	1
S6310*	2230001110	SKRPACE010	1
S6311*	2230001110	SKRPACE010	1
S6312*	2230001110	SKRPACE010	1
S6313*	2230001110	SKRPACE010	1
S6314*	2230001110	SKRPACE010	1
S6315*	2230001110	SKRPACE010	1
S6316*	2230001110	SKRPACE010	1
S6317*	2230001110	SKRPACE010	1
S6318*	2230001110	SKRPACE010	1
S6319*	2230001110	SKRPACE010	1
S6320*	2230001110	SKRPACE010	1
S6321*	2230001110	SKRPACE010	1
S6322*	2230001110	SKRPACE010	1
S6323*	2230001110	SKRPACE010	1
S6324*	2230001110	SKRPACE010	1
S6325*	2230001110	SKRPACE010	1
MP6001	8930082070	SPONGE (KY)	2
MP6002	8930061640	RUBBER SHEET (BH) (SHJ)	2
MP6003	8930068080	THERMAL SHEET (AU)TC400HS-1.4 (12X34)	1

[MIC UNIT]

REF NO.	ORDER NO.	DESCRIPTION	QTY.
J6901*	6510025142	10FLT-SM2-TB (LF) (SN) (M)	1
J6902	6510022440	LTW-8MP-C NUTGASKET <LIA>	1

*: Refer to "BOARD LAYOUTS" for the location.

** : Refer to "GENERAL WIRING" for the connection

Screw abbreviations A, B0, BT: Self-tapping PH: Pan head ZK: Black NI-ZU: Nickel-Zinc SUS: Stainless

[ACCESSORIES]

REF NO.	ORDER NO.	DESCRIPTION	QTY.
F1	521000840	ATC-30	2
MC1	(Optional)	HM-193	[EXP-01] 1
	(Optional)	HM-193	[AUS-01] 1
	(Optional)	HM-193	[USA-01] 1
	(Optional)	HM-193	[UN-01] 1
	(Optional)	HM-193	[EXP-02] 1
	(Optional)	HM-193	[AUS-02] 1
	(Optional)	HM-193	[USA-02] 1
	(Optional)	HM-193	[UN-02] 1
	(Optional)	HM-192	[EXP-03] 1
	(Optional)	HM-192	[AUS-03] 1
	(Optional)	HM-192	[USA-03] 1
(Optional)	HM-192	[UN-03] 1	
SP1	(Optional)	SP-35L	1
W1	8900021370	OPC-2310	1
EP1	(Optional)	RMK-6	[EXP-02] 1
	(Optional)	RMK-6	[AUS-02] 1
	(Optional)	RMK-6	[USA-02] 1
	(Optional)	RMK-6	[UN-02] 1
MP1	8930083980	SJ5027 BLA (X4)	1
MP2	8930078980	2783 A-MIC HANGER ASSEMBLYY1156	[EXP-01] 1
	8930078980	2783 A-MIC HANGER ASSEMBLYY1156	[AUS-01] 1
	8930078980	2783 A-MIC HANGER ASSEMBLYY1156	[USA-01] 1
	8930078980	2783 A-MIC HANGER ASSEMBLYY1156	[UN-01] 1
	8930078980	2783 A-MIC HANGER ASSEMBLYY1156	[EXP-02] 1
	8930078980	2783 A-MIC HANGER ASSEMBLYY1156	[AUS-02] 1
	8930078980	2783 A-MIC HANGER ASSEMBLYY1156	[USA-02] 1
	8930078980	2783 A-MIC HANGER ASSEMBLYY1156	[UN-02] 1
MP4	8810010880	SCREW BT A0 4X16 SUS	[EXP-01] 2
	8810010880	SCREW BT A0 4X16 SUS	[AUS-01] 2
	8810010880	SCREW BT A0 4X16 SUS	[USA-01] 2
	8810010880	SCREW BT A0 4X16 SUS	[UN-01] 2
	8810010880	SCREW BT A0 4X16 SUS	[EXP-02] 2
	8810010880	SCREW BT A0 4X16 SUS	[AUS-02] 2
	8810010880	SCREW BT A0 4X16 SUS	[USA-02] 2
	8810010880	SCREW BT A0 4X16 SUS	[UN-02] 2
MP5	8810000471	PH M5 X12 (+-) ZC3	[EXP-02] 4
	8810000471	PH M5 X12 (+-) ZC3	[AUS-02] 4
	8810000471	PH M5 X12 (+-) ZC3	[USA-02] 4
	8810000471	PH M5 X12 (+-) ZC3	[UN-02] 4
MP6	8810000951	PHA M5 X16 ZC3	[EXP-02] 4
	8810000951	PHA M5 X16 ZC3	[AUS-02] 4
	8810000951	PHA M5 X16 ZC3	[UN-02] 4
MP7	8850000180	FLAT WASHER M 5 SUS	[EXP-02] 4
	8850000180	FLAT WASHER M 5 SUS	[AUS-02] 4
	8850000180	FLAT WASHER M 5 SUS	[USA-02] 4
	8850000180	FLAT WASHER M 5 SUS	[UN-02] 4
MP8	8850000391	S-WASHER M5 ZC3	[EXP-02] 4
	8850000391	S-WASHER M5 ZC3	[AUS-02] 4
	8850000391	S-WASHER M5 ZC3	[USA-02] 4
	8850000391	S-WASHER M5 ZC3	[UN-02] 4
MP9	8830000121	NUT M 5 ZC3	[EXP-02] 4
	8830000121	NUT M 5 ZC3	[AUS-02] 4
	8830000121	NUT M 5 ZC3	[USA-02] 4
	8830000121	NUT M 5 ZC3	[UN-02] 4
MP10	8810003961	SET SCREWA M2.6X 5 ZC3	[EXP-02] 4
	8810003961	SET SCREWA M2.6X 5 ZC3	[AUS-02] 4
	8810003961	SET SCREWA M2.6X 5 ZC3	[USA-02] 4
	8810003961	SET SCREWA M2.6X 5 ZC3	[UN-02] 4
	8810003961	SET SCREWA M2.6X 5 ZC3	[EXP-03] 4
	8810003961	SET SCREWA M2.6X 5 ZC3	[AUS-03] 4
	8810003961	SET SCREWA M2.6X 5 ZC3	[USA-03] 4
	8810003961	SET SCREWA M2.6X 5 ZC3	[UN-03] 4
MP11	8930082140	3317 CABLE PLATE	[EXP-02] 4
	8930082140	3317 CABLE PLATE	[AUS-02] 4
	8930082140	3317 CABLE PLATE	[USA-02] 4
	8930082140	3317 CABLE PLATE	[UN-02] 4
	8930082140	3317 CABLE PLATE	[EXP-03] 4
	8930082140	3317 CABLE PLATE	[AUS-03] 4
	8930082140	3317 CABLE PLATE	[USA-03] 4
	8930082140	3317 CABLE PLATE	[UN-03] 4
MP12	8810005771	BIND M3 X 8 ZK3BLACK	[EXP-02] 2
	8810005771	BIND M3 X 8 ZK3BLACK	[AUS-02] 2
	8810005771	BIND M3 X 8 ZK3BLACK	[USA-02] 2
	8810005771	BIND M3 X 8 ZK3BLACK	[UN-02] 2
	8810005771	BIND M3 X 8 ZK3BLACK	[EXP-03] 2
	8810005771	BIND M3 X 8 ZK3BLACK	[AUS-03] 2
	8810005771	BIND M3 X 8 ZK3BLACK	[USA-03] 2
	8810005771	BIND M3 X 8 ZK3BLACK	[UN-03] 2
MP14	8930082430	3311 A-MIC ANGLE ASSEMBLY	[EXP-03] 1
	8930082430	3311 A-MIC ANGLE ASSEMBLY	[AUS-03] 1
	8930082430	3311 A-MIC ANGLE ASSEMBLY	[USA-03] 1
	8930082430	3311 A-MIC ANGLE ASSEMBLY	[UN-03] 1

[ACCESSORIES]

REF NO.	ORDER NO.	DESCRIPTION	QTY.
MP15	8930081930	3311 B-MIC ANGLE	[EXP-03] 1
	8930081930	3311 B-MIC ANGLE	[AUS-03] 1
	8930081930	3311 B-MIC ANGLE	[USA-03] 1
	8930081930	3311 B-MIC ANGLE	[UN-03] 1
MP16	8810000660	PH M4 X14 SUS	[EXP-03] 1
	8810000660	PH M4 X14 SUS	[AUS-03] 1
	8810000660	PH M4 X14 SUS	[USA-03] 1
	8810000660	PH M4 X14 SUS	[UN-03] 1
MP18	8810005050	PHA M4 X20 SUS	[EXP-03] 4
	8810005050	PHA M4 X20 SUS	[AUS-03] 4
	8810005050	PHA M4 X20 SUS	[USA-03] 4
	8810005050	PHA M4 X20 SUS	[UN-03] 4
MP19	8930085220	3247 SPONGE	1

• For [EXP-01], [AUS-01], [USA-01], [UN-01]

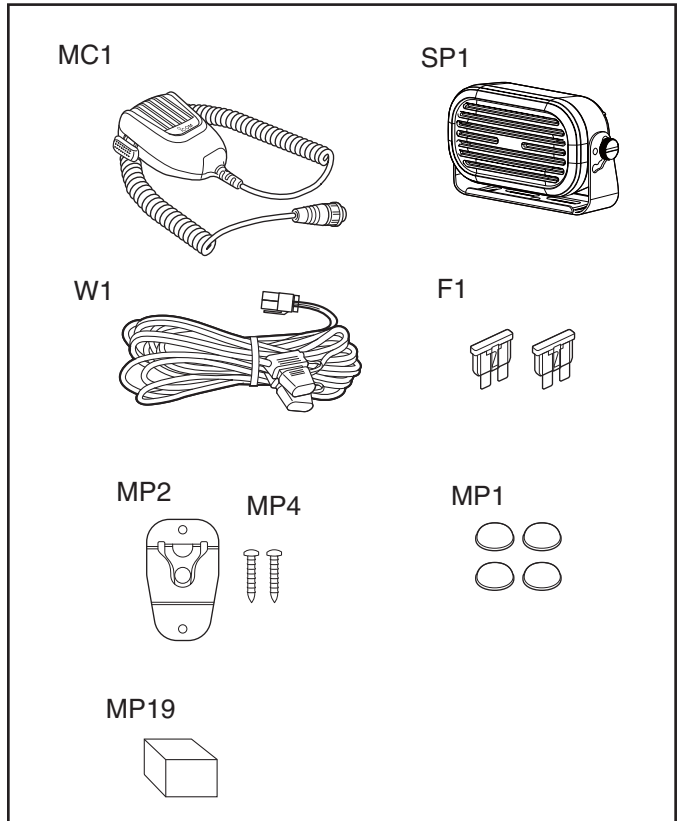

*: Refer to "BOARD LAYOUTS" for the location.

** : Refer to "GENERAL WIRING" for the connection

Screw abbreviations A, B0, BT: Self-tapping PH: Pan head ZK: Black NI-ZU: Nickel-Zinc SUS: Stainless

• For [EXP-02], [AUS-02], [USA-02], [UN-02]

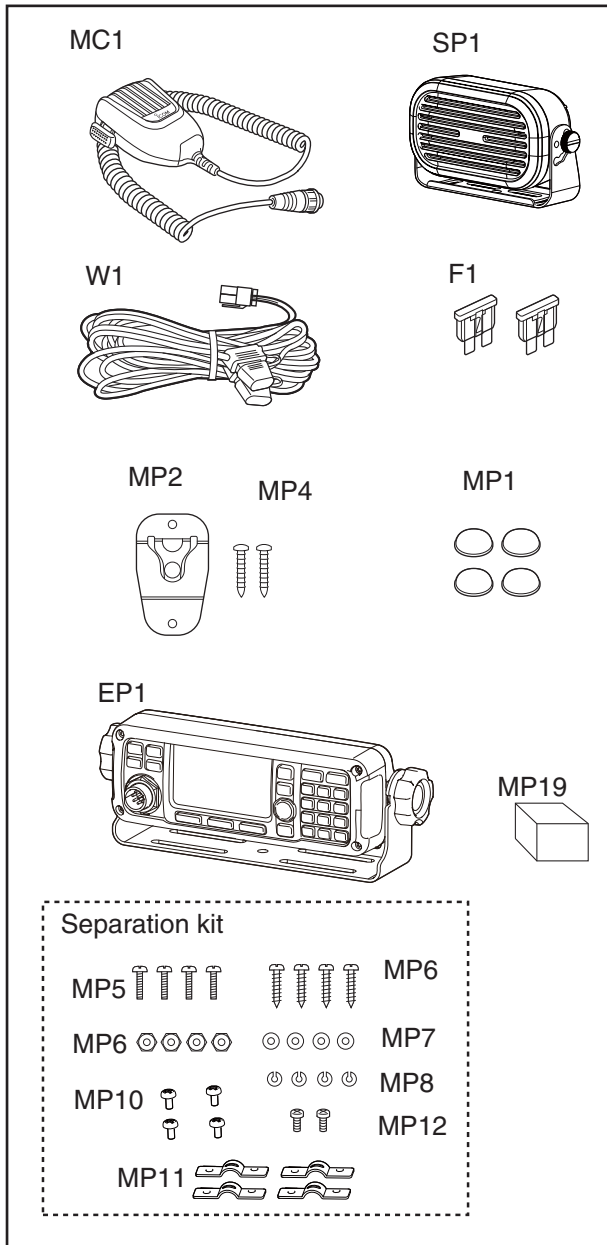

• For [EXP-03], [AUS-03], [USA-03], [UN-03]

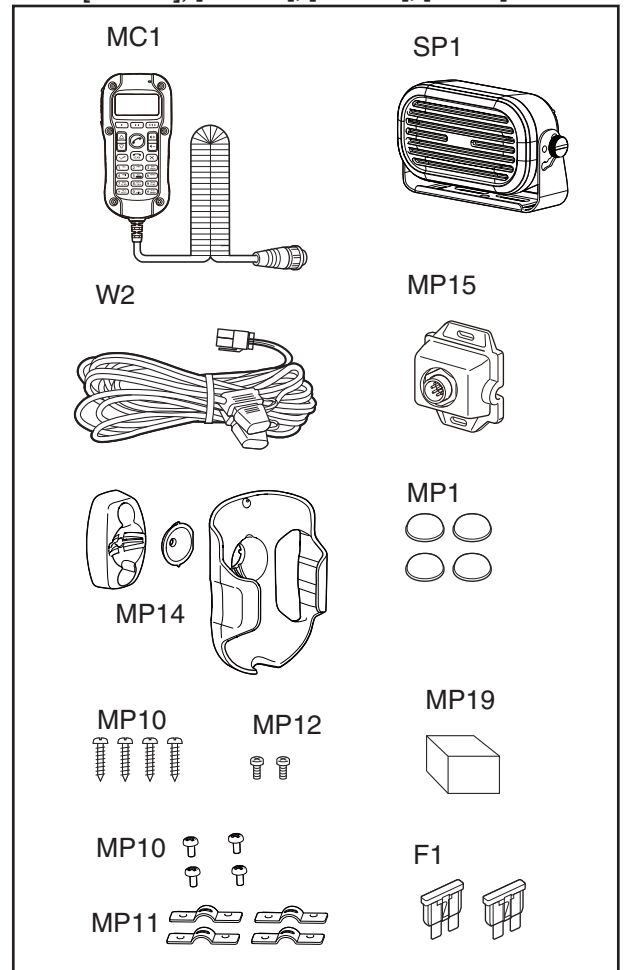

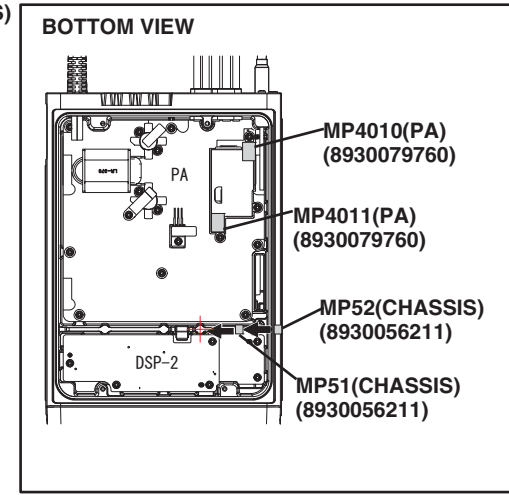
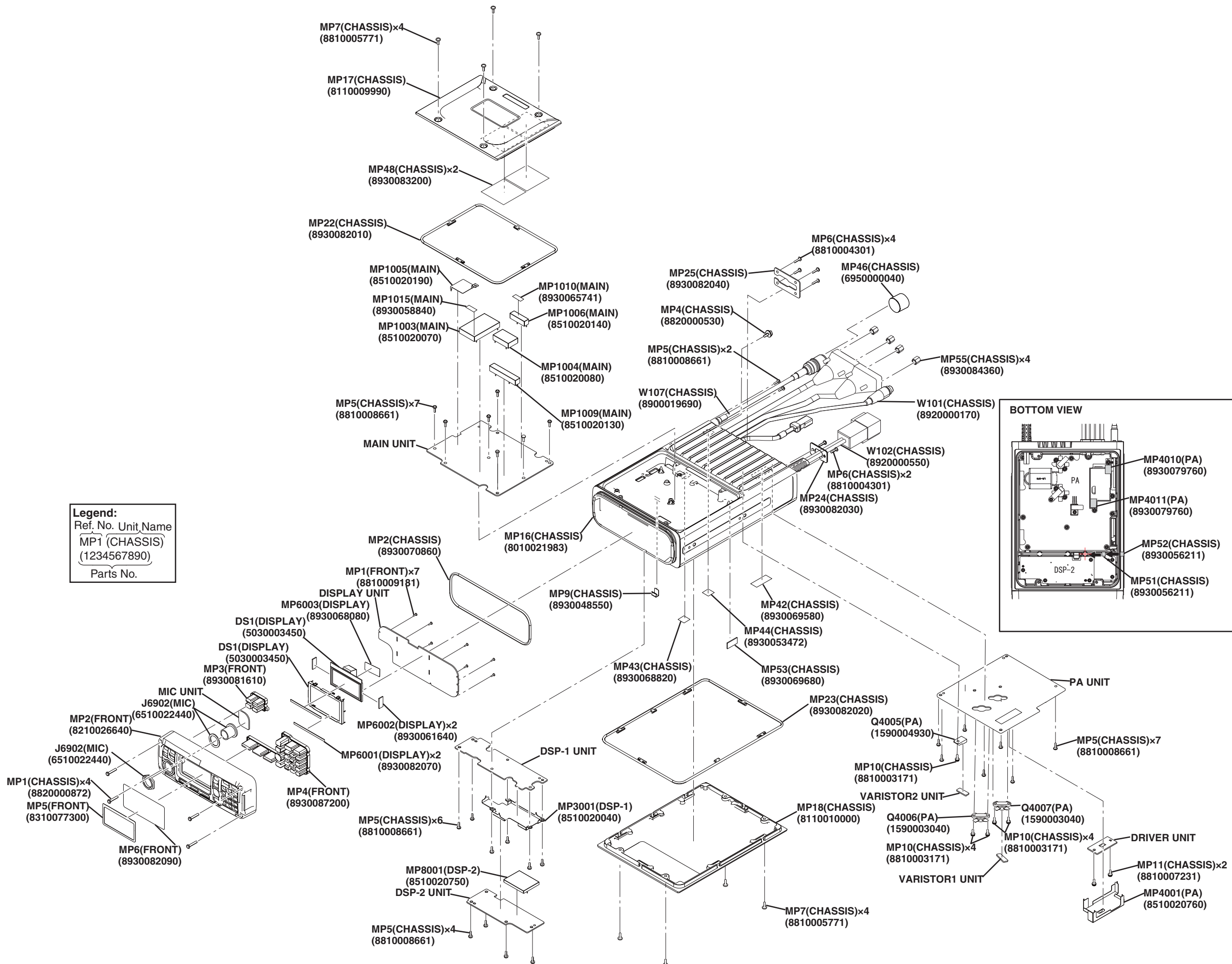

• DISPLAY UNIT B-7821B
(TOP VIEW)

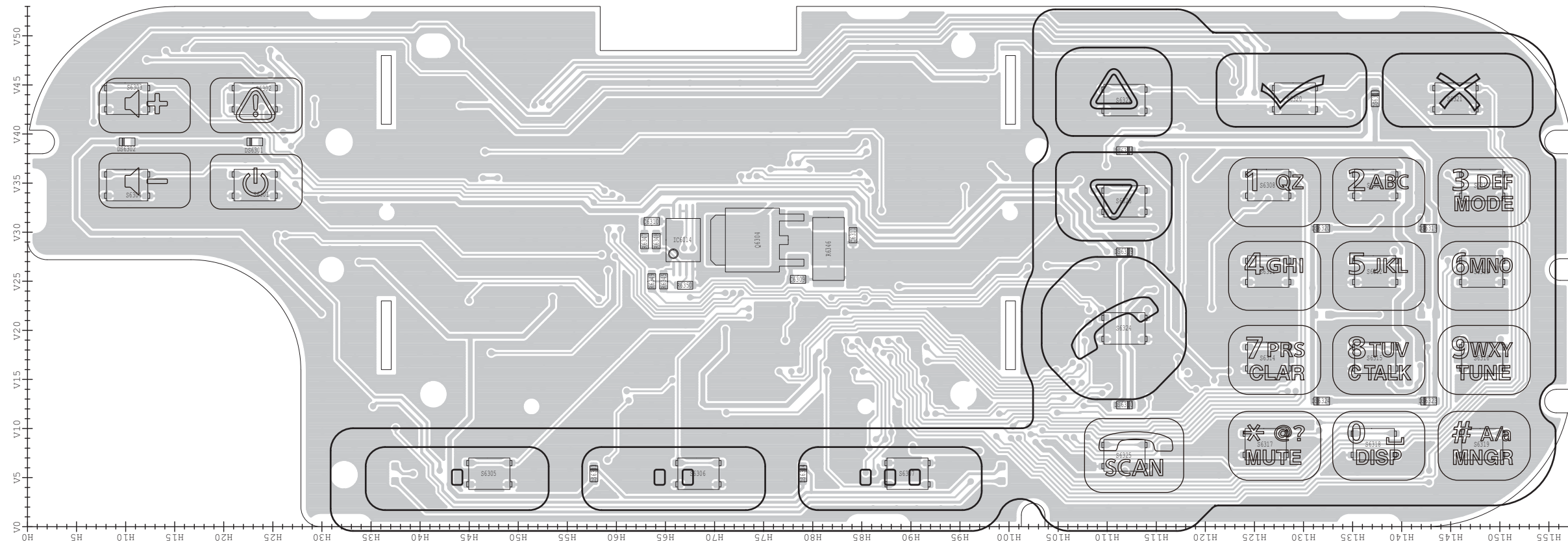

• DRIVER UNIT B-5744A
(TOP VIEW)

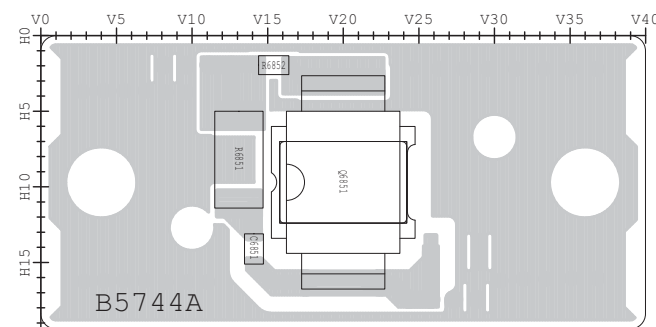

• MIC UNIT B-7822
(TOP VIEW)

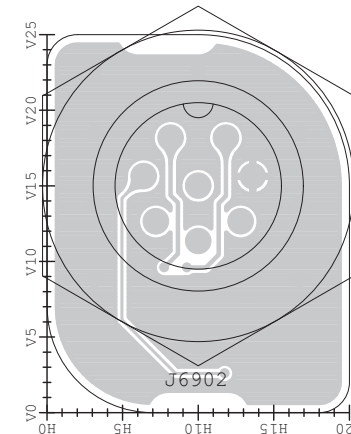

• VARISTOR1 / VARISTOR2 UNIT B-7456A
(TOP VIEW)

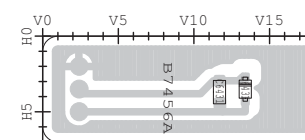

• **DISPLAY UNIT B-7821B
(BOTTOM VIEW)**

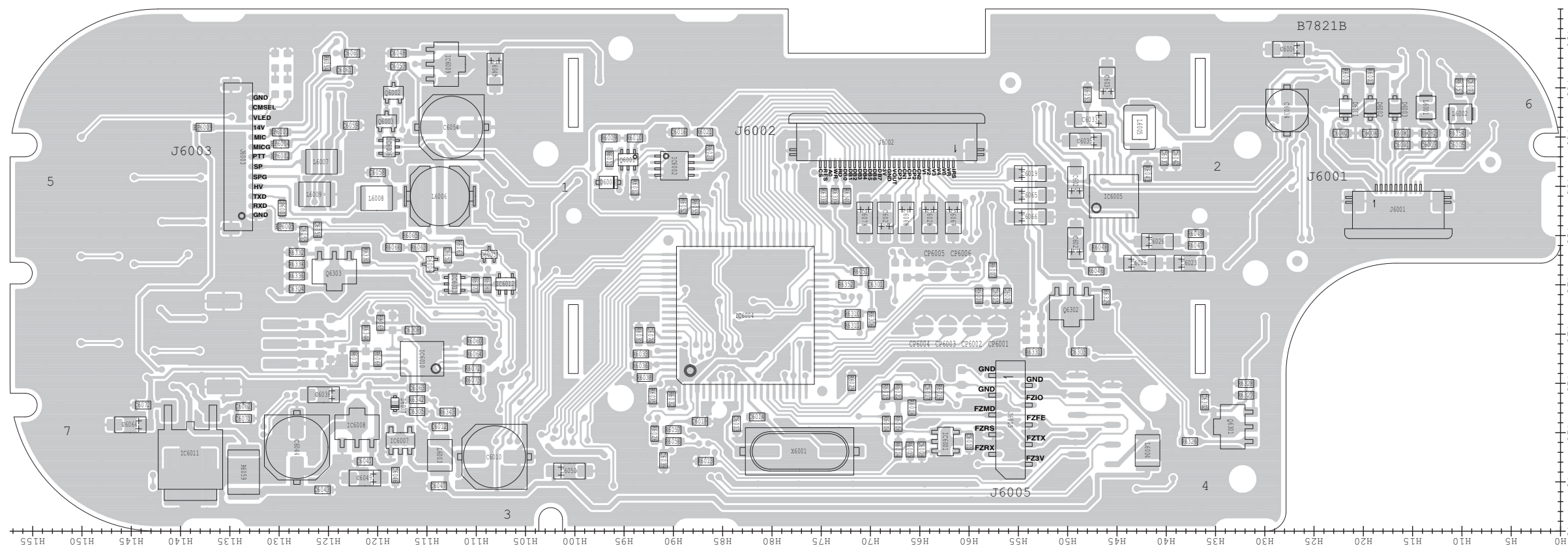

• **MIC UNIT B-7822
(BOTTOM VIEW)**

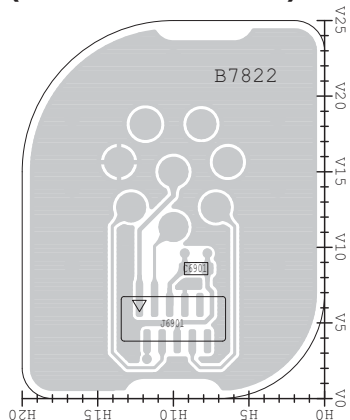

• **DRIVER UNIT B-5744A
(BOTTOM VIEW)**

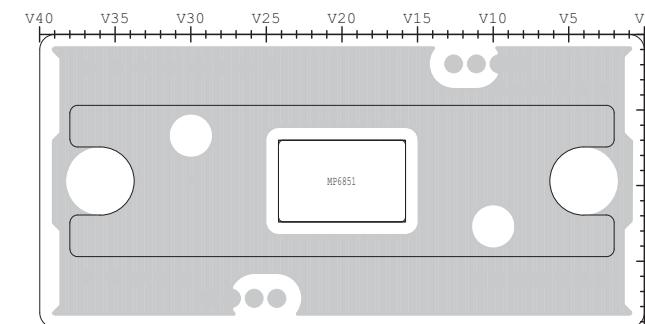

• **VARISTOR1 / VARISTOR2 UNIT B-7456A
(BOTTOM VIEW)**

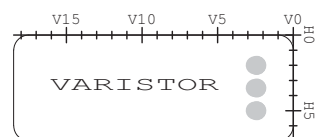

• MAIN UNIT B-7818B
(TOP VIEW)

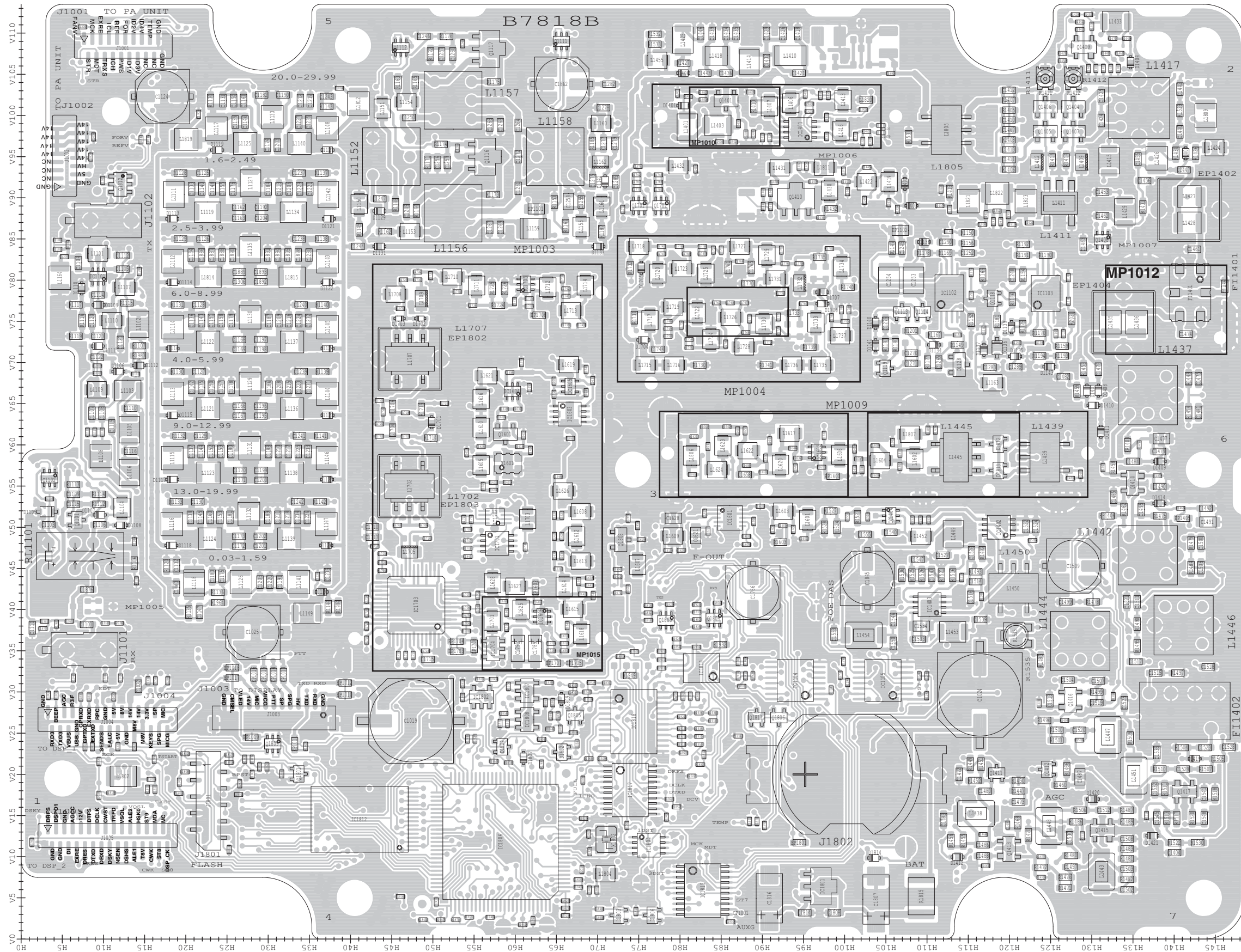

• PA UNIT B-7827C
(TOP VIEW)

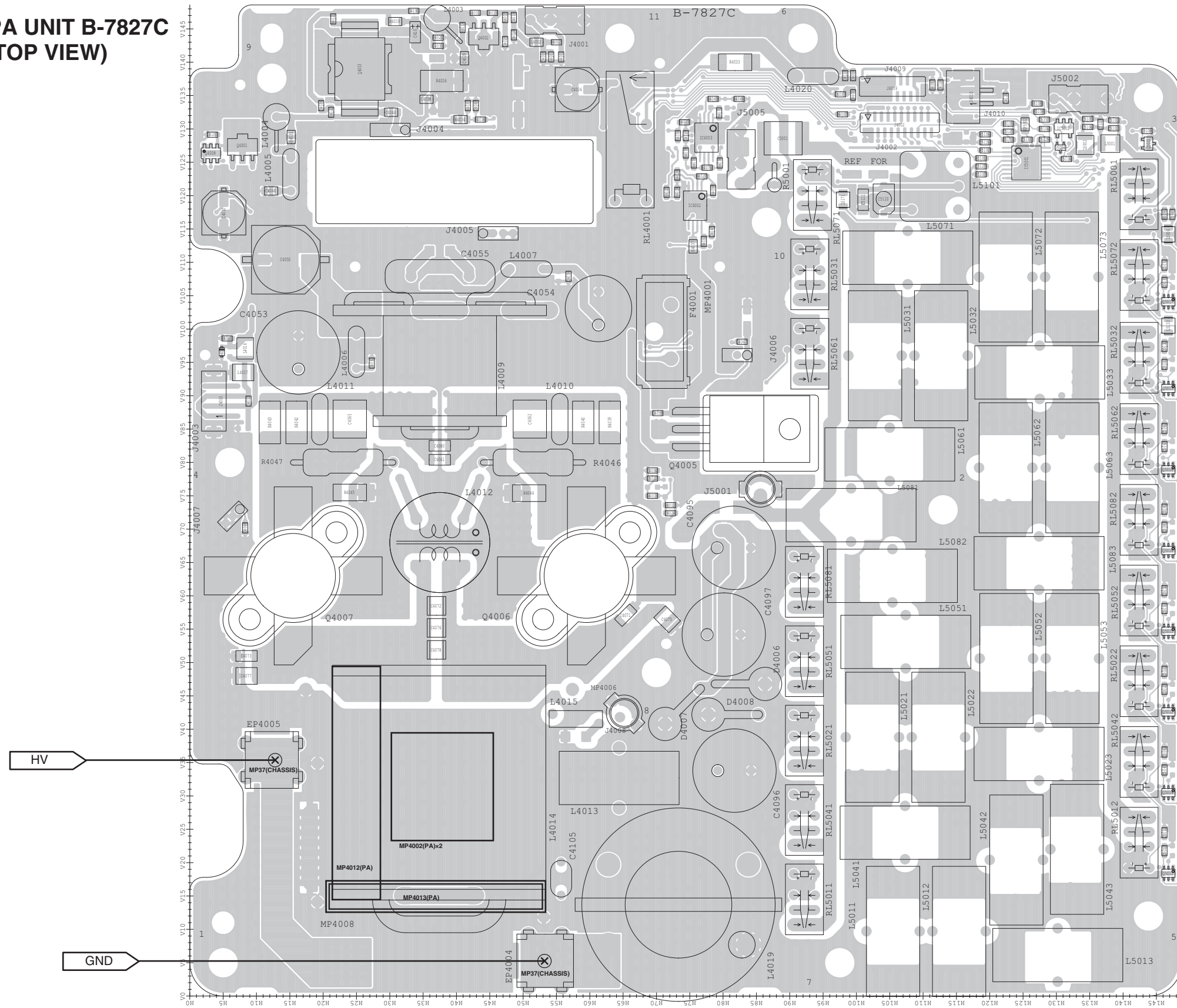

• PA UNIT B-7827C
(BOTTOM VIEW)

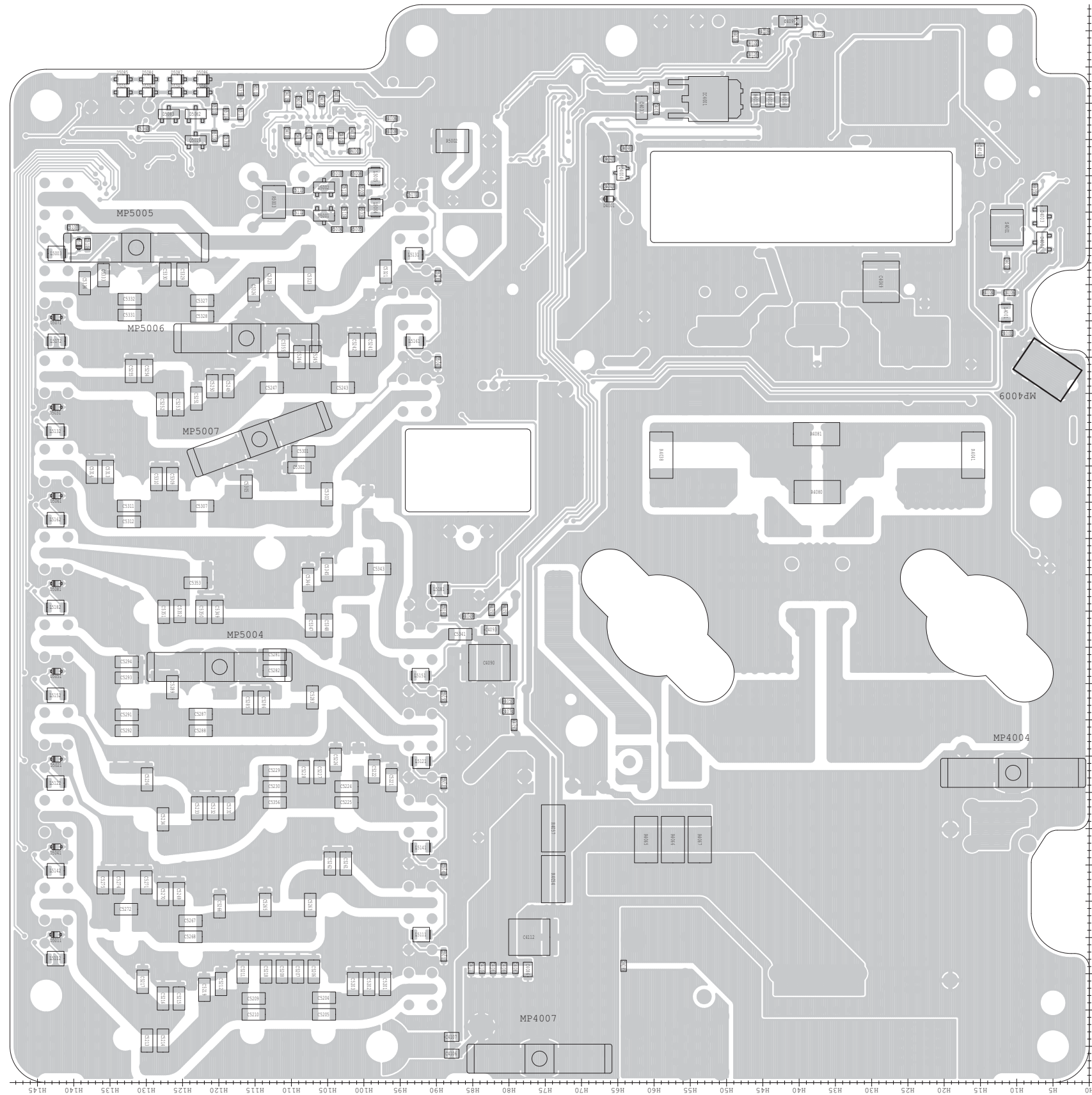

• DSP-1 UNIT B-7819B
(TOP VIEW)

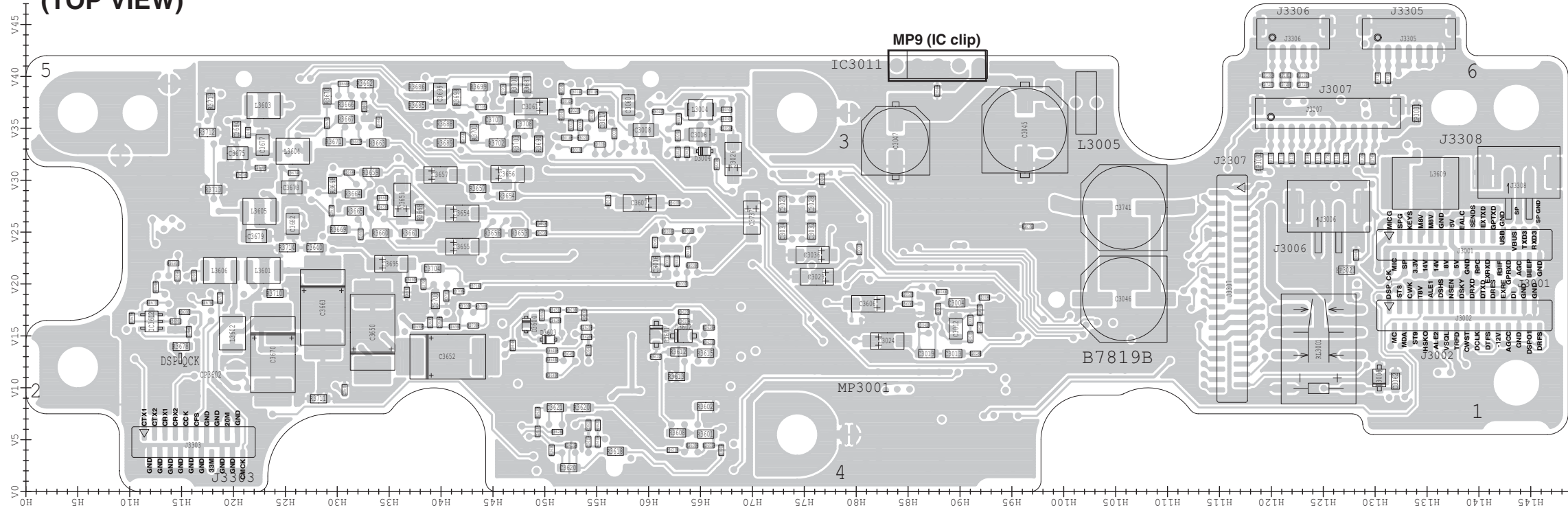

• DSP-2 UNIT B-7820B
(TOP VIEW)

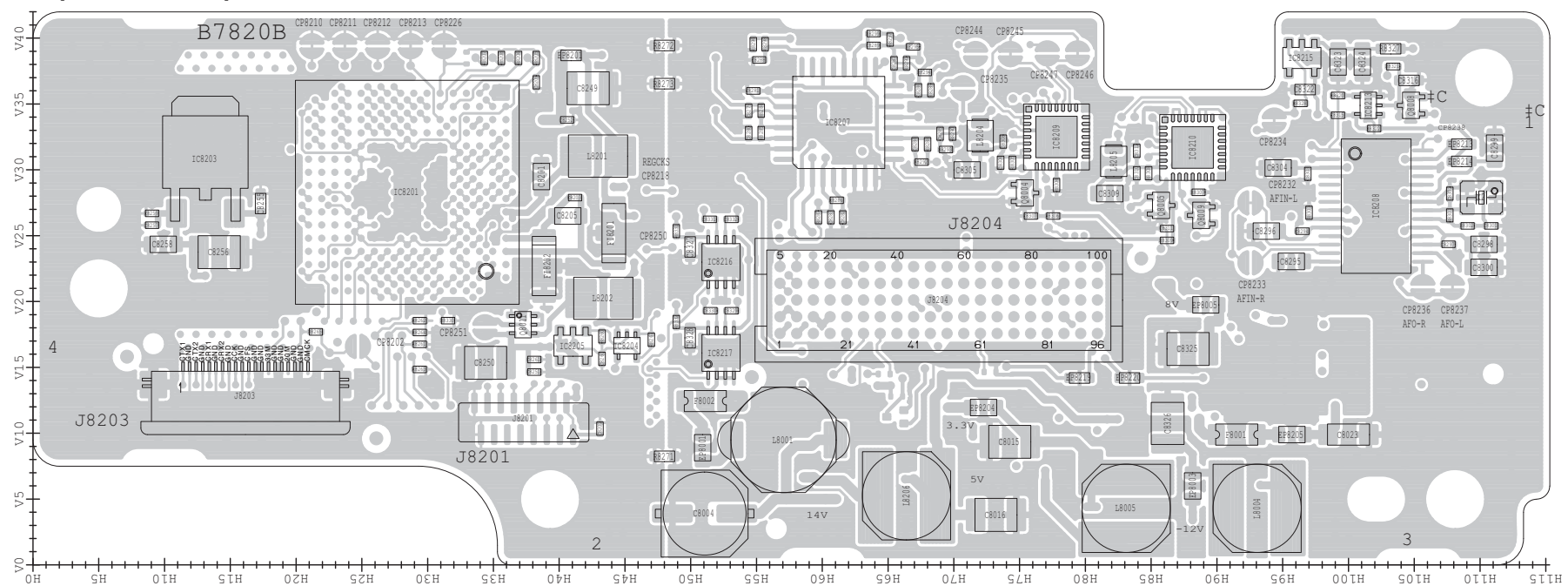

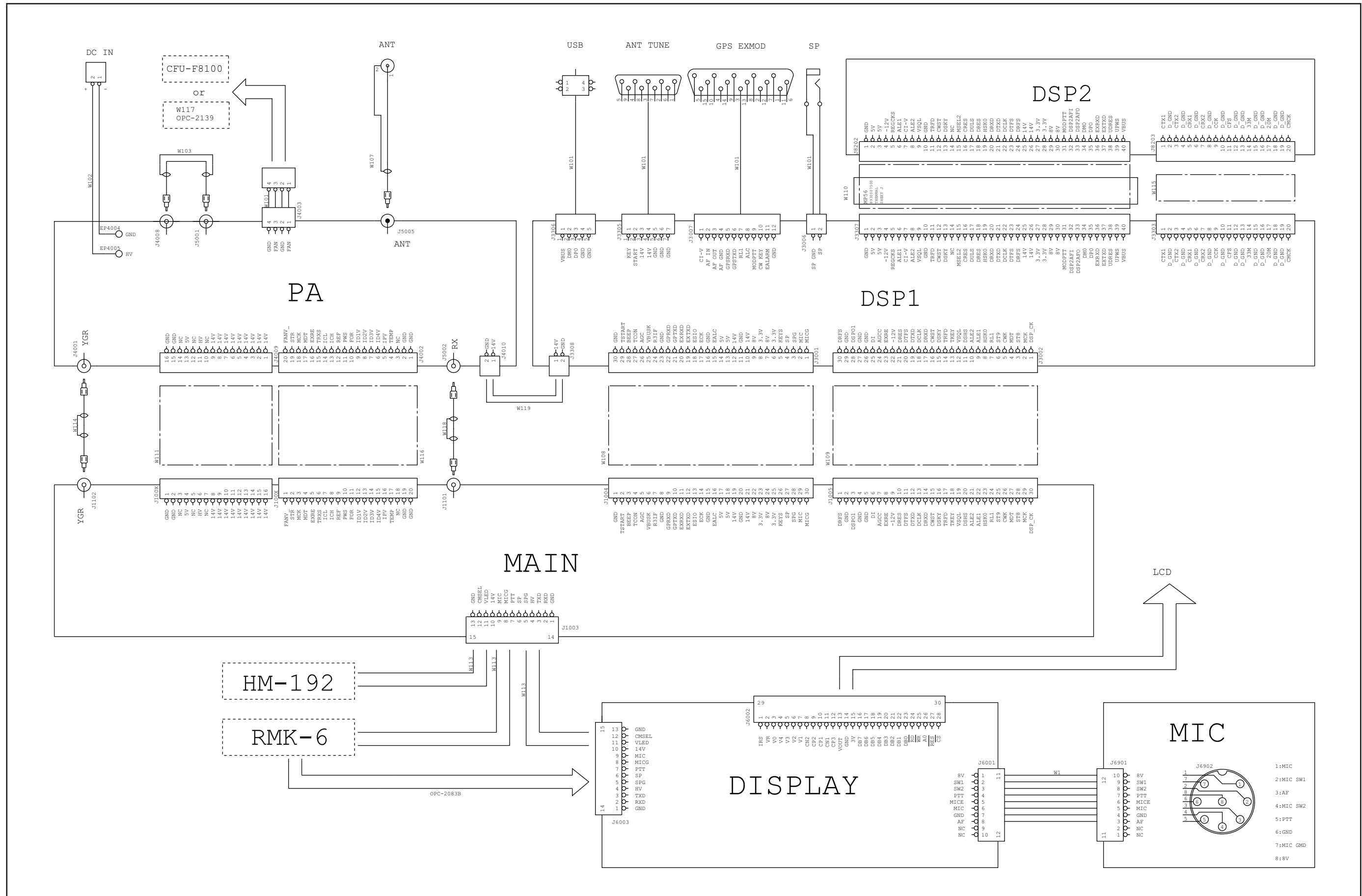

SECTION 10

BLOCK DIAGRAM

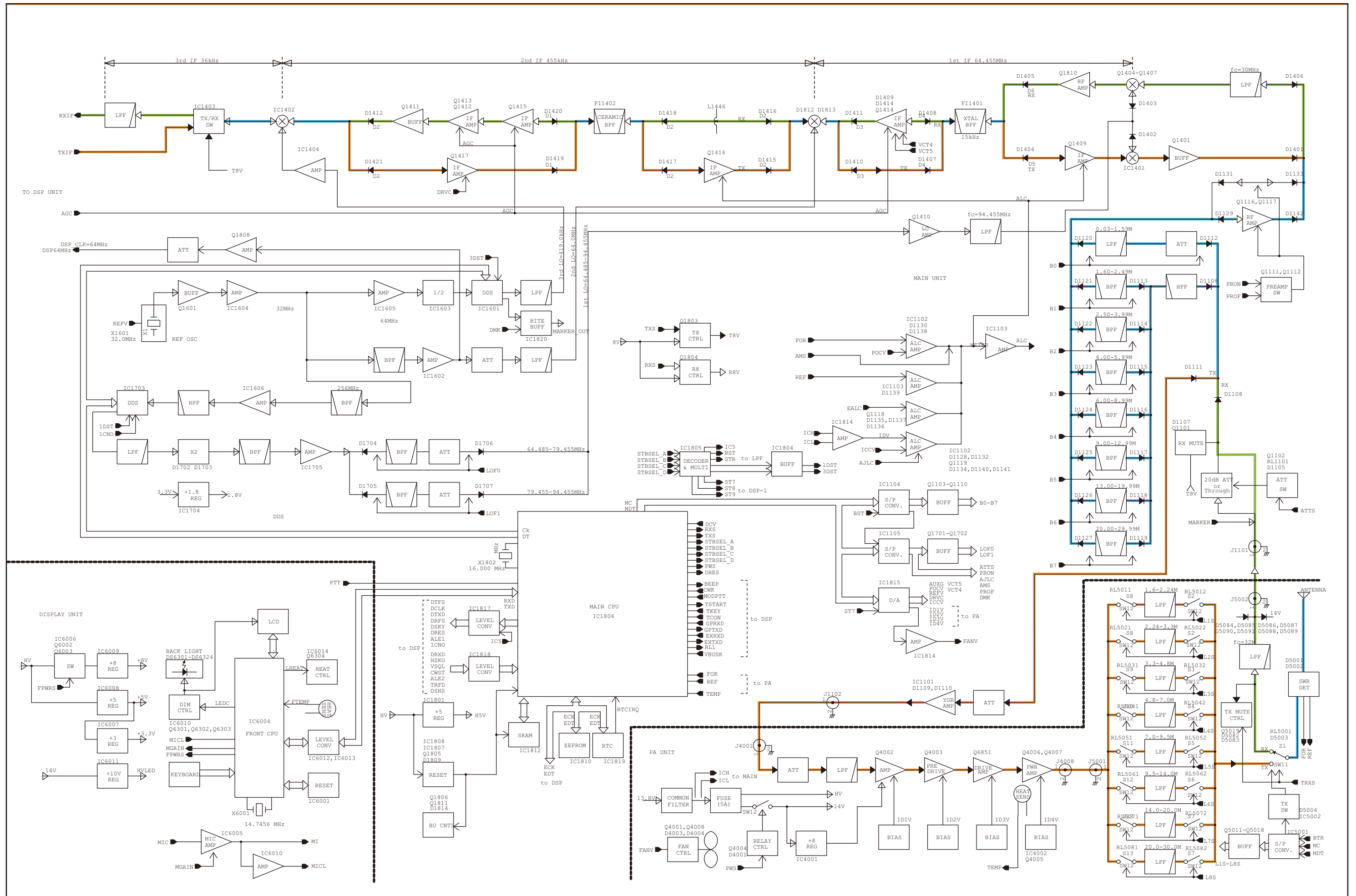

SECTION 11

VOLTAGE DIAGRAM

• DISPLAY UNIT (1/2)

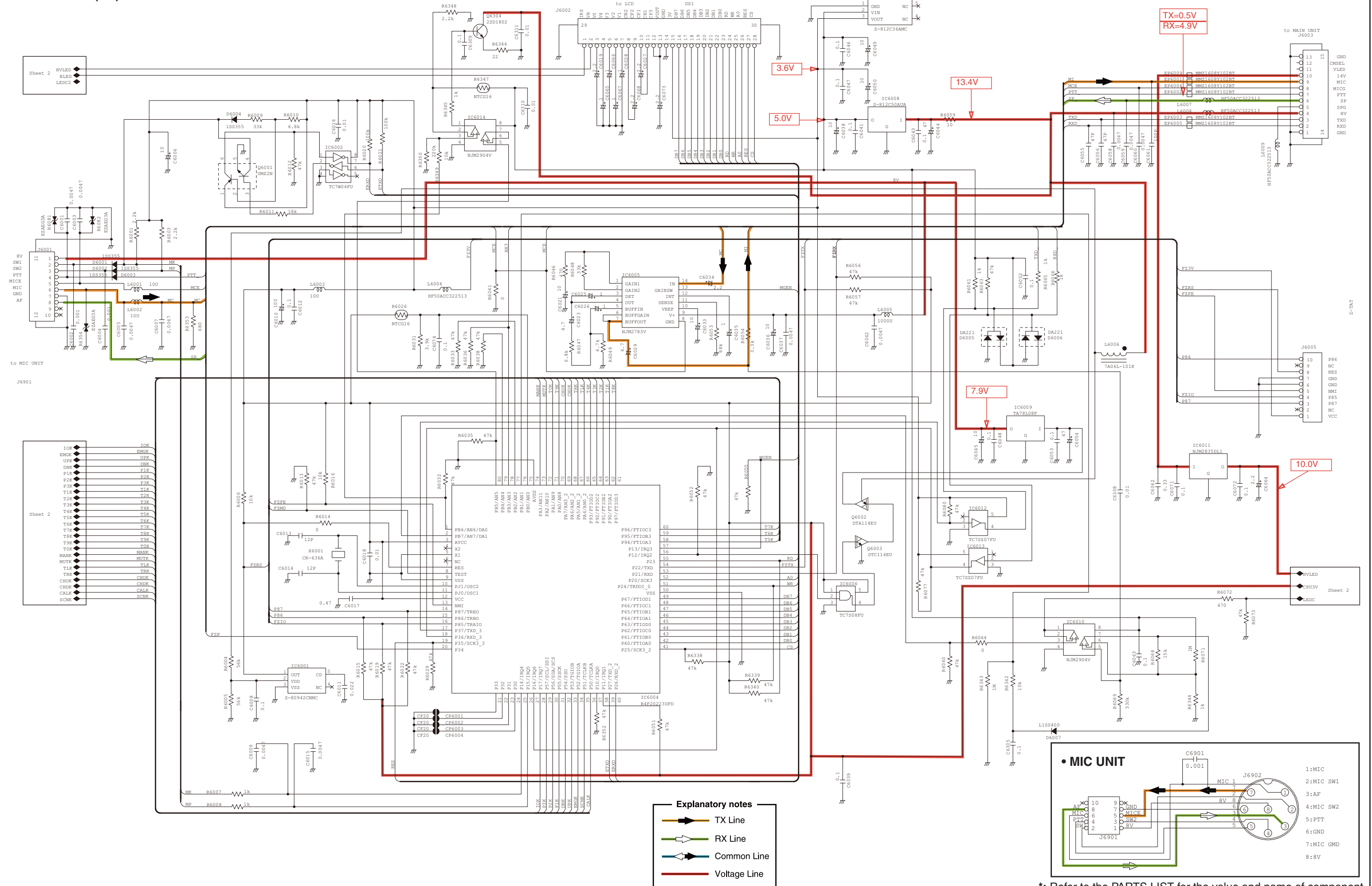

Explanatory notes

- TX Line
- RX Line
- Common Line
- Voltage Line

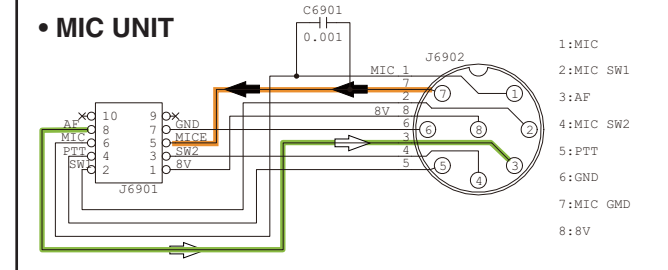

*: Refer to the PARTS LIST for the value and name of component.

• DISPLAY UNIT (2/2)

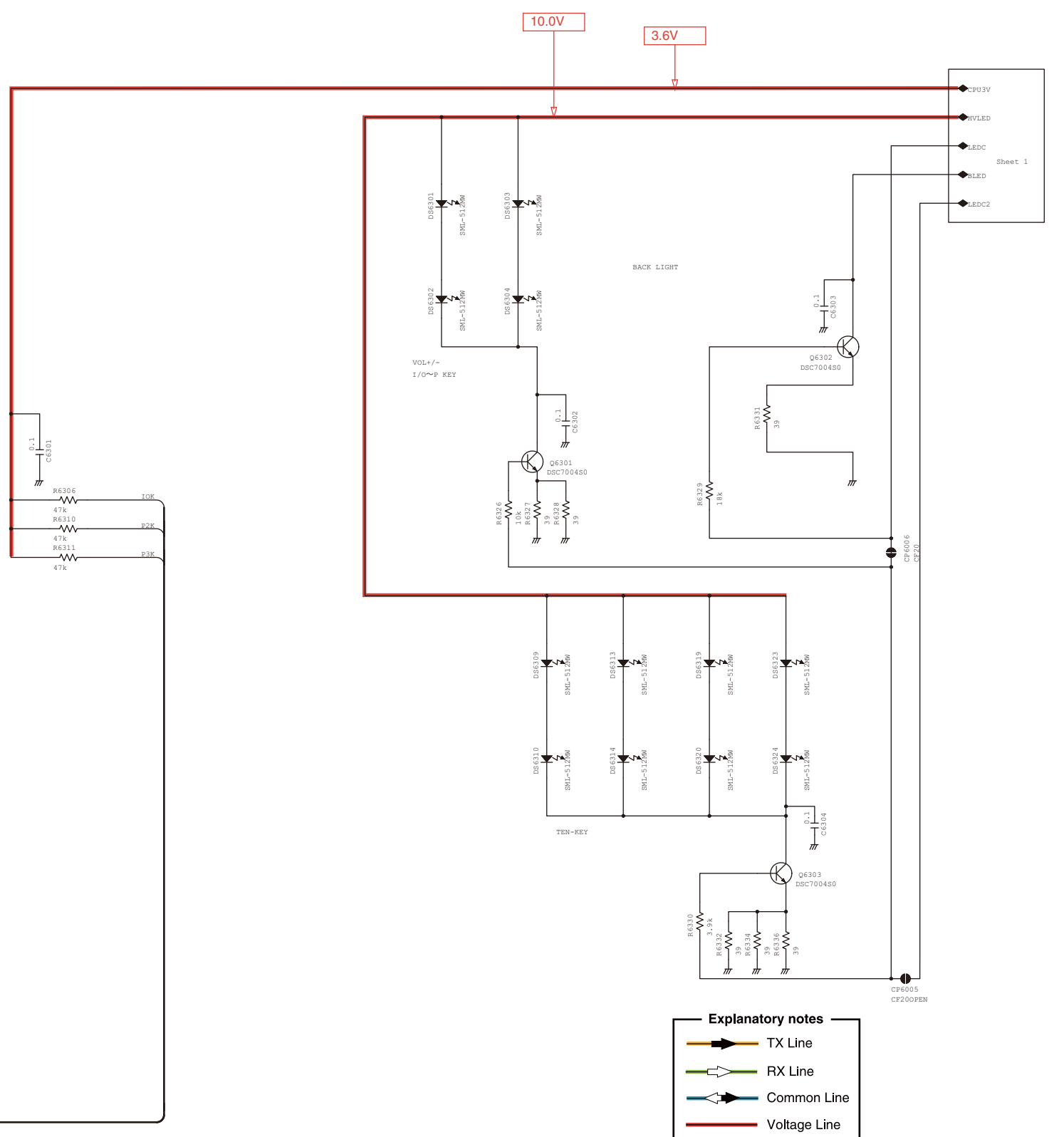
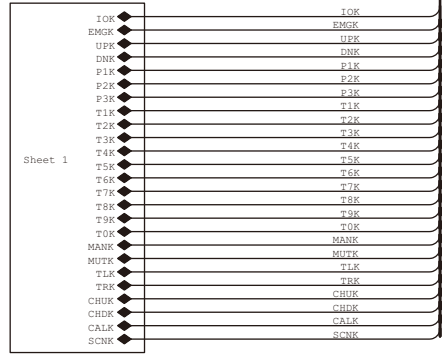
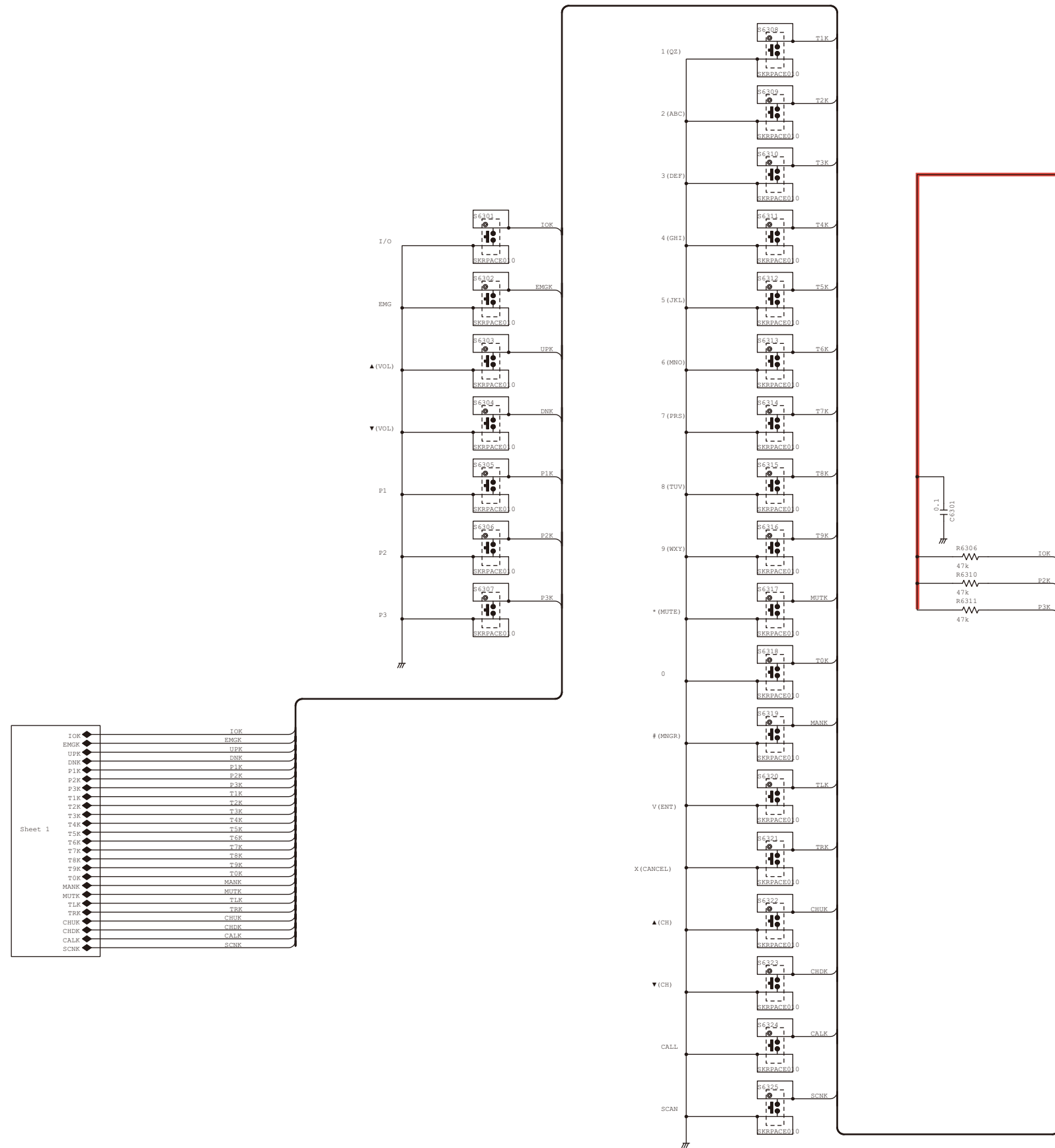

*: Refer to the PARTS LIST for the value and name of component.

• MAIN UNIT (2/6)

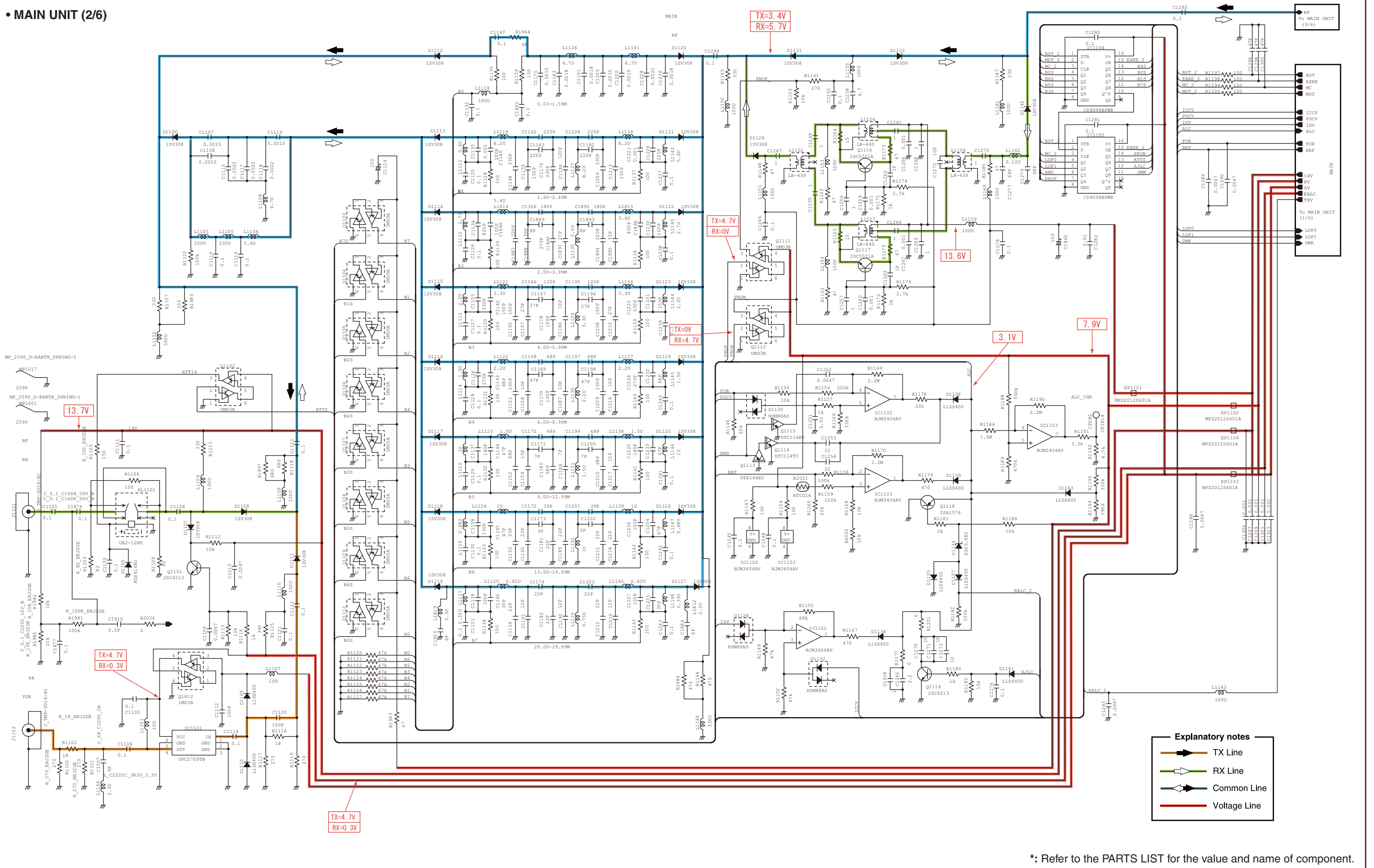

Explanatory notes

- TX Line
- RX Line
- Common Line
- Voltage Line

*: Refer to the PARTS LIST for the value and name of component.

• MAIN UNIT (3/6)

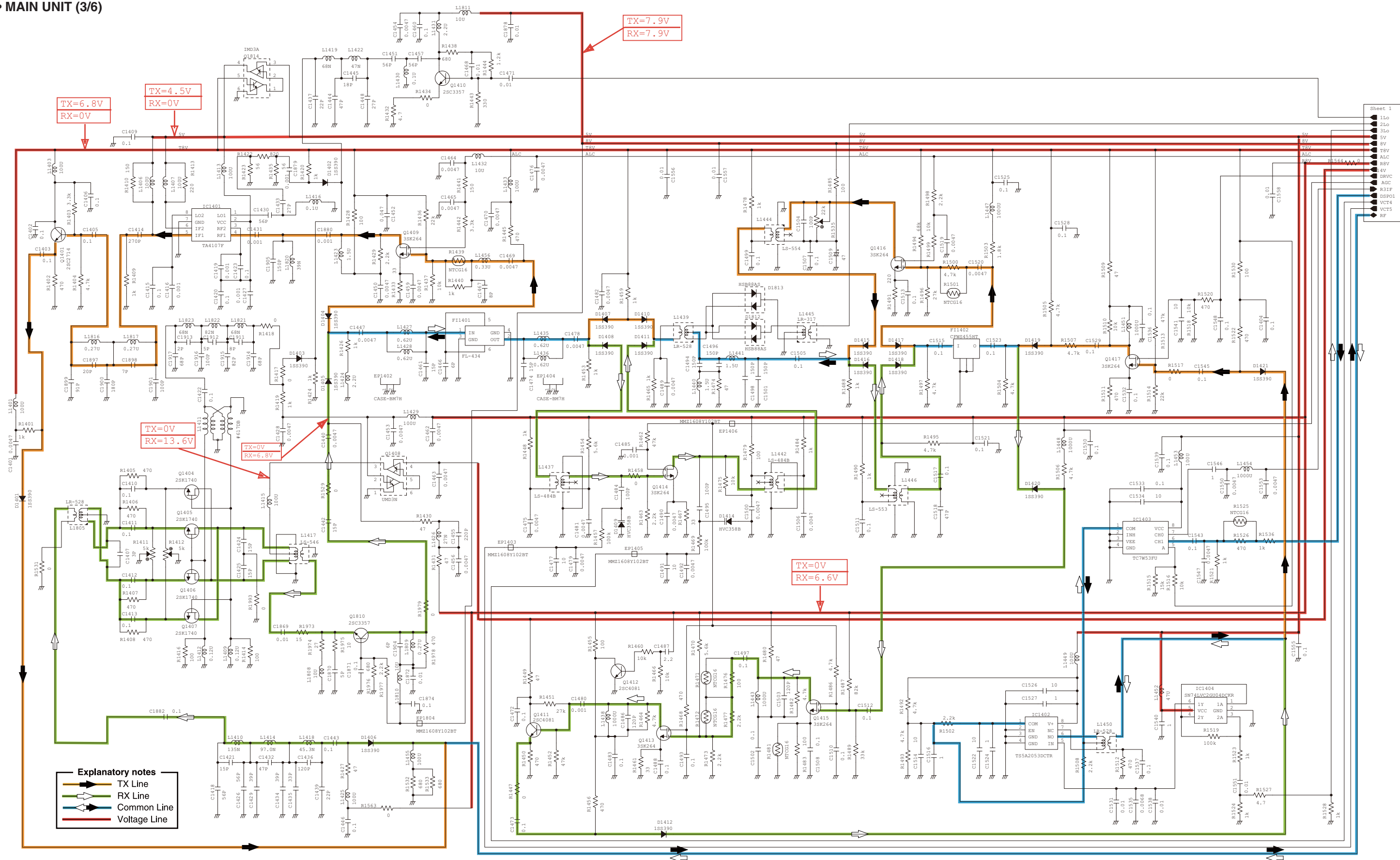

Sheet 1

1Lo
2Lo
3Lo
5V
8V
25V
A1C
REV
4V
DRVC
ASC
R31F
DSPO1
VCT4
VCT5
RF

Explanatory notes

- TX Line
- RX Line
- Common Line
- Voltage Line

*: Refer to the PARTS LIST for the value and name of component.

• MAIN UNIT (4/6)

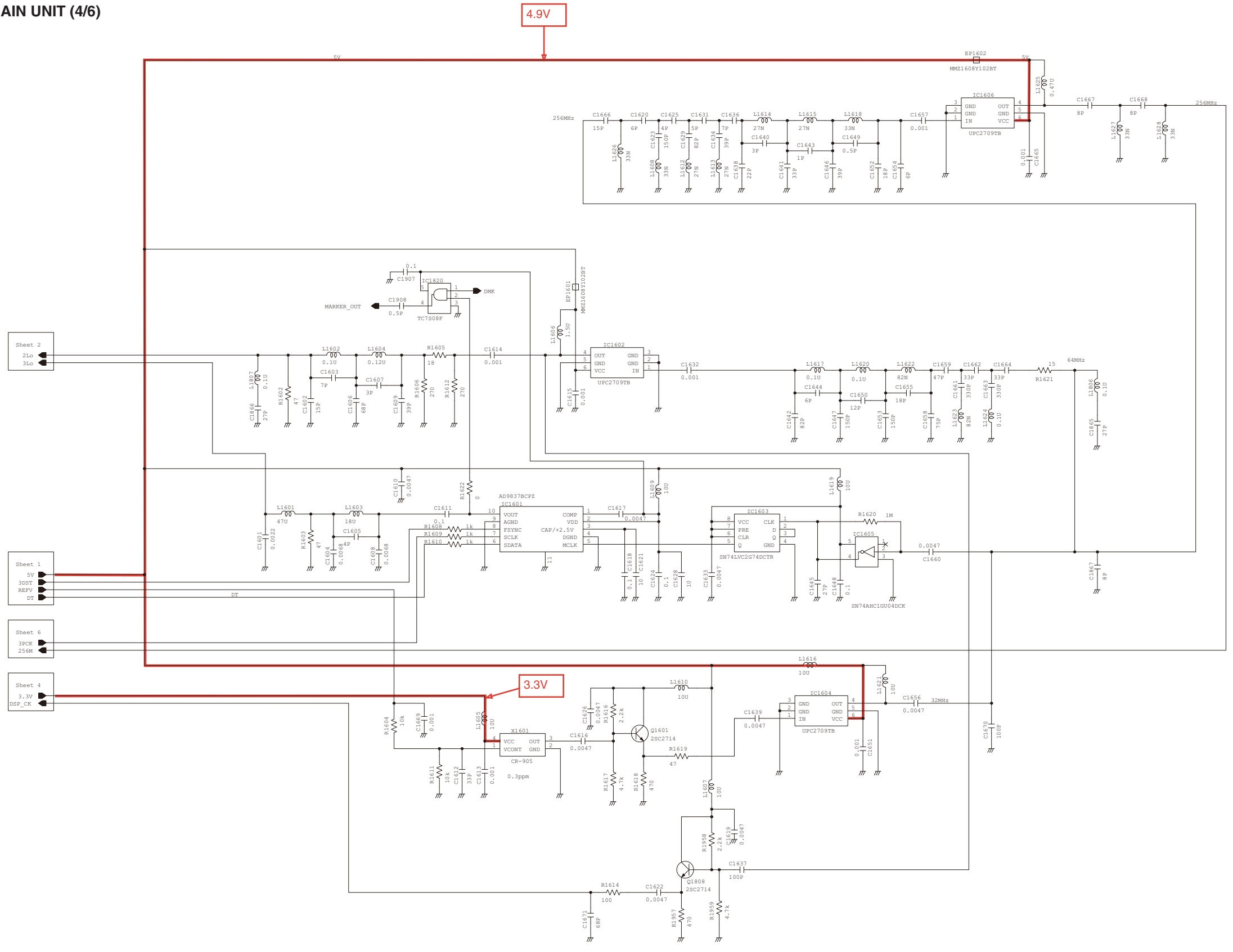

Explanatory notes

- ▶ TX Line
- ▶ RX Line
- ▶ Common Line
- Voltage Line

*: Refer to the PARTS LIST for the value and name of component.

• MAIN UNIT (5/6)

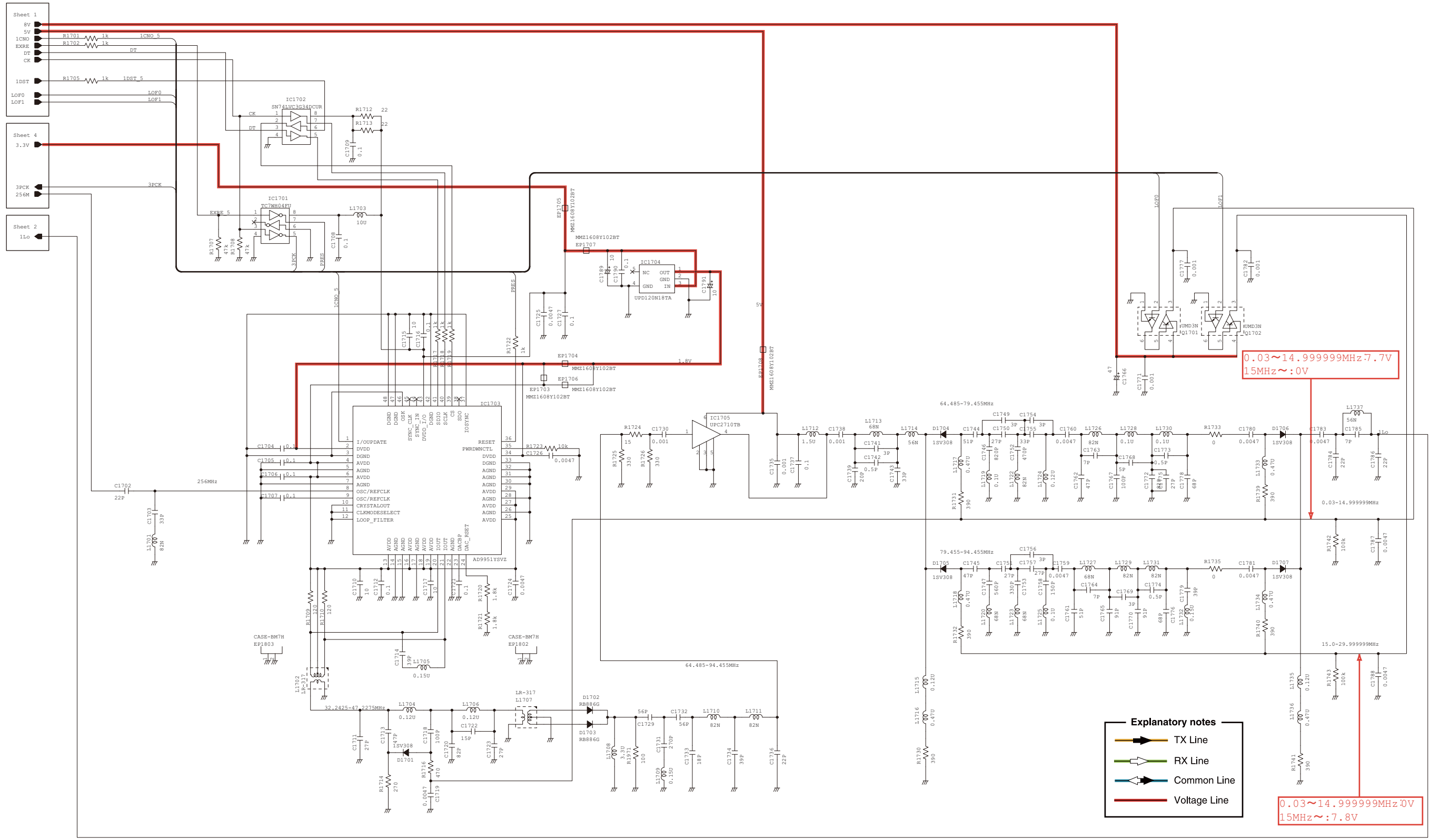

*: Refer to the PARTS LIST for the value and name of component.

• PA UNIT (1/2)

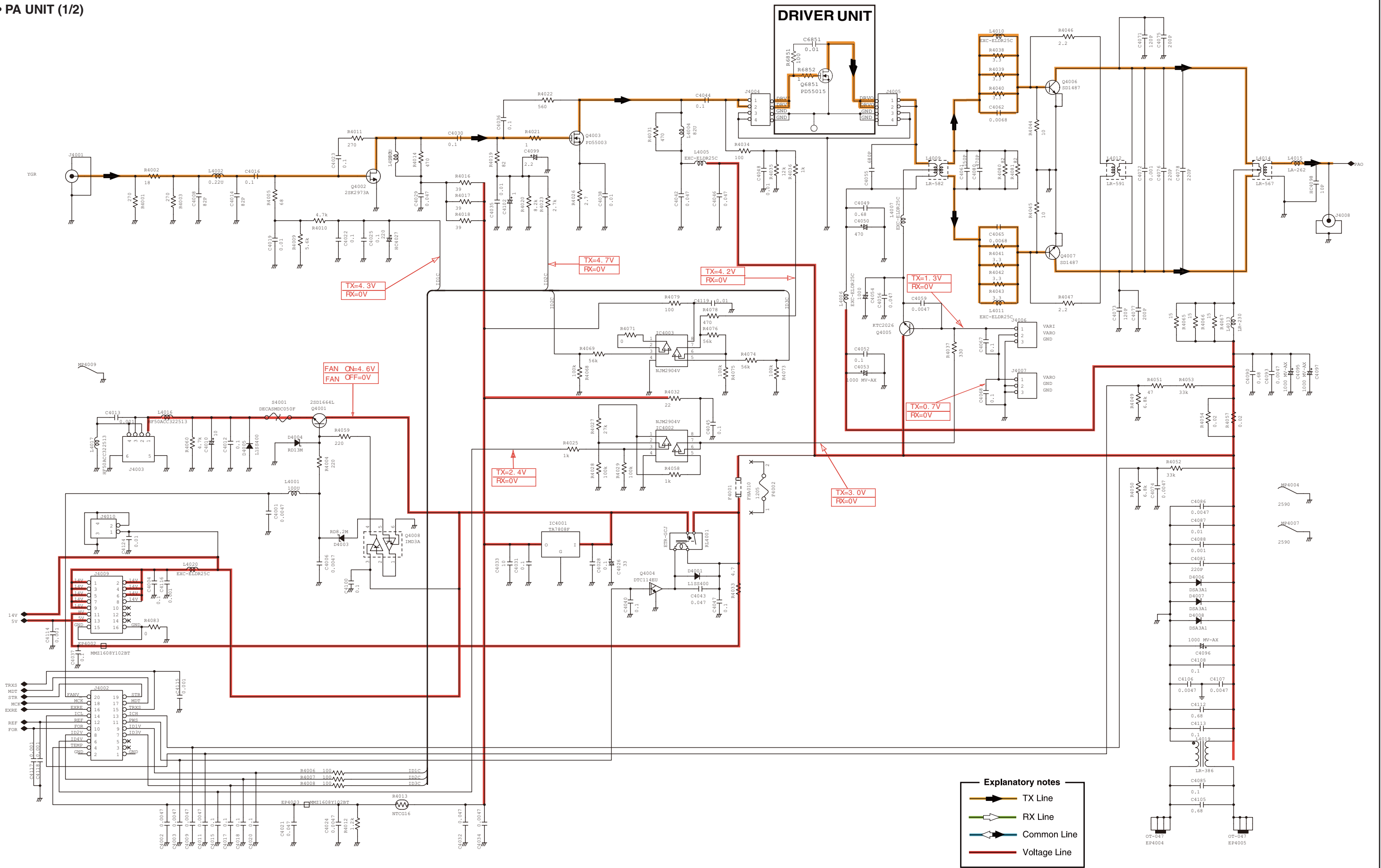

Explanatory notes

- TX Line
- RX Line
- Common Line
- Voltage Line

*: Refer to the PARTS LIST for the value and name of component.

• PA UNIT (2/2)

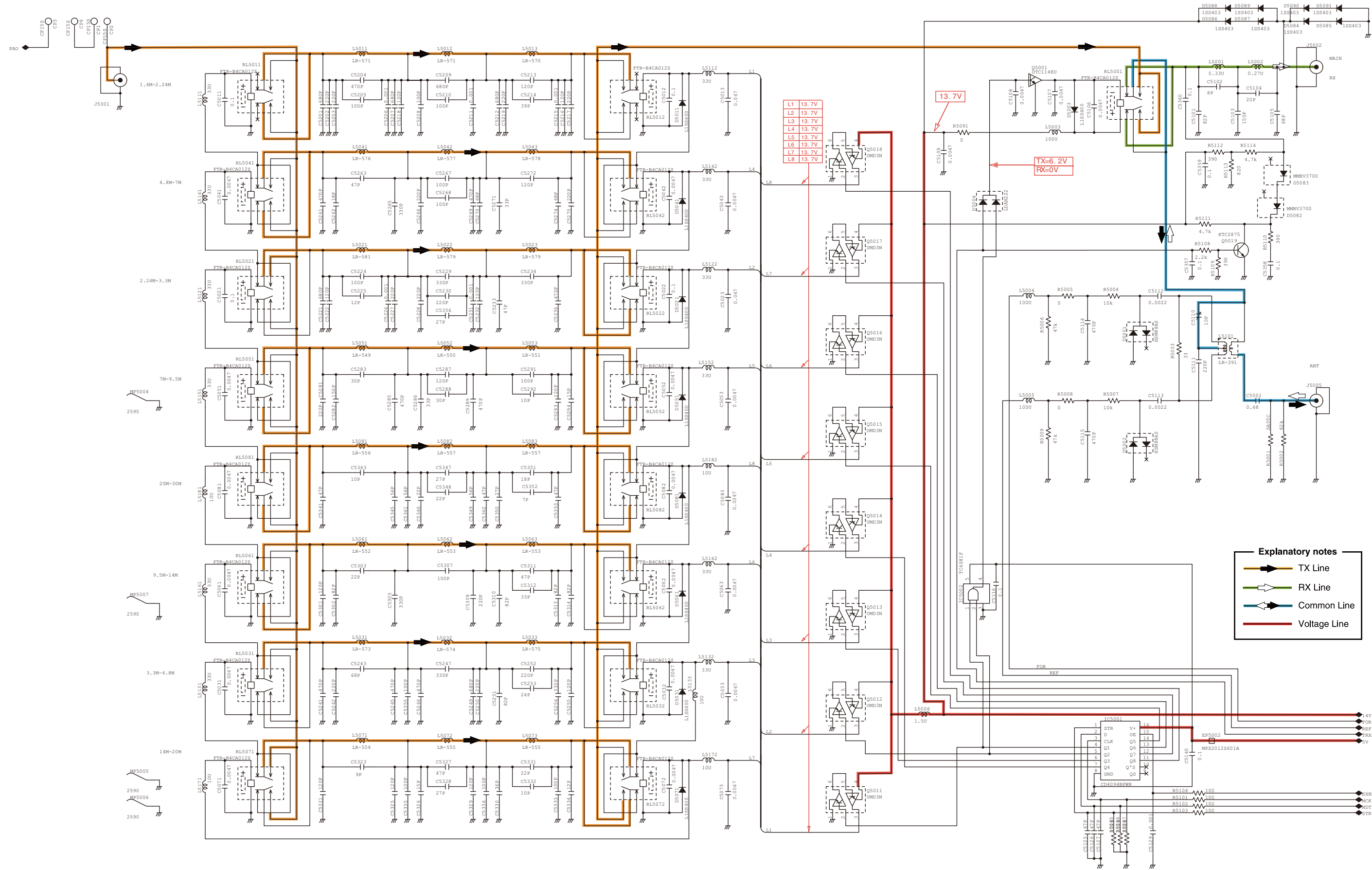

Explanatory notes

- TX Line
- RX Line
- Common Line
- Voltage Line

*: Refer to the PARTS LIST for the value and name of component.

• DSP-1 UNIT (2/2)

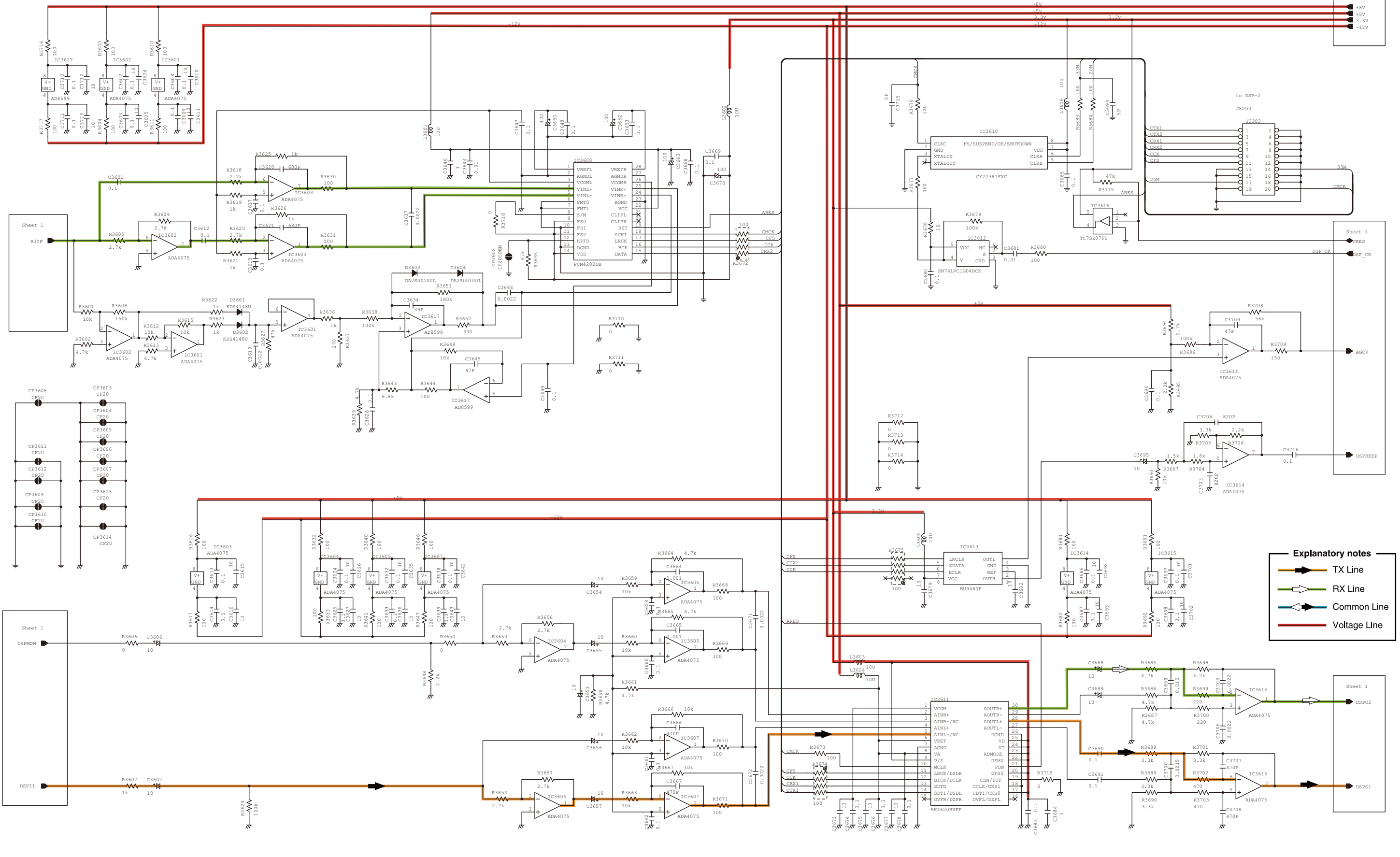

Explanatory notes

- TX Line
- RX Line
- Common Line
- Voltage Line

*: Refer to the PARTS LIST for the value and name of component.

• DSP-2 UNIT (1/3)

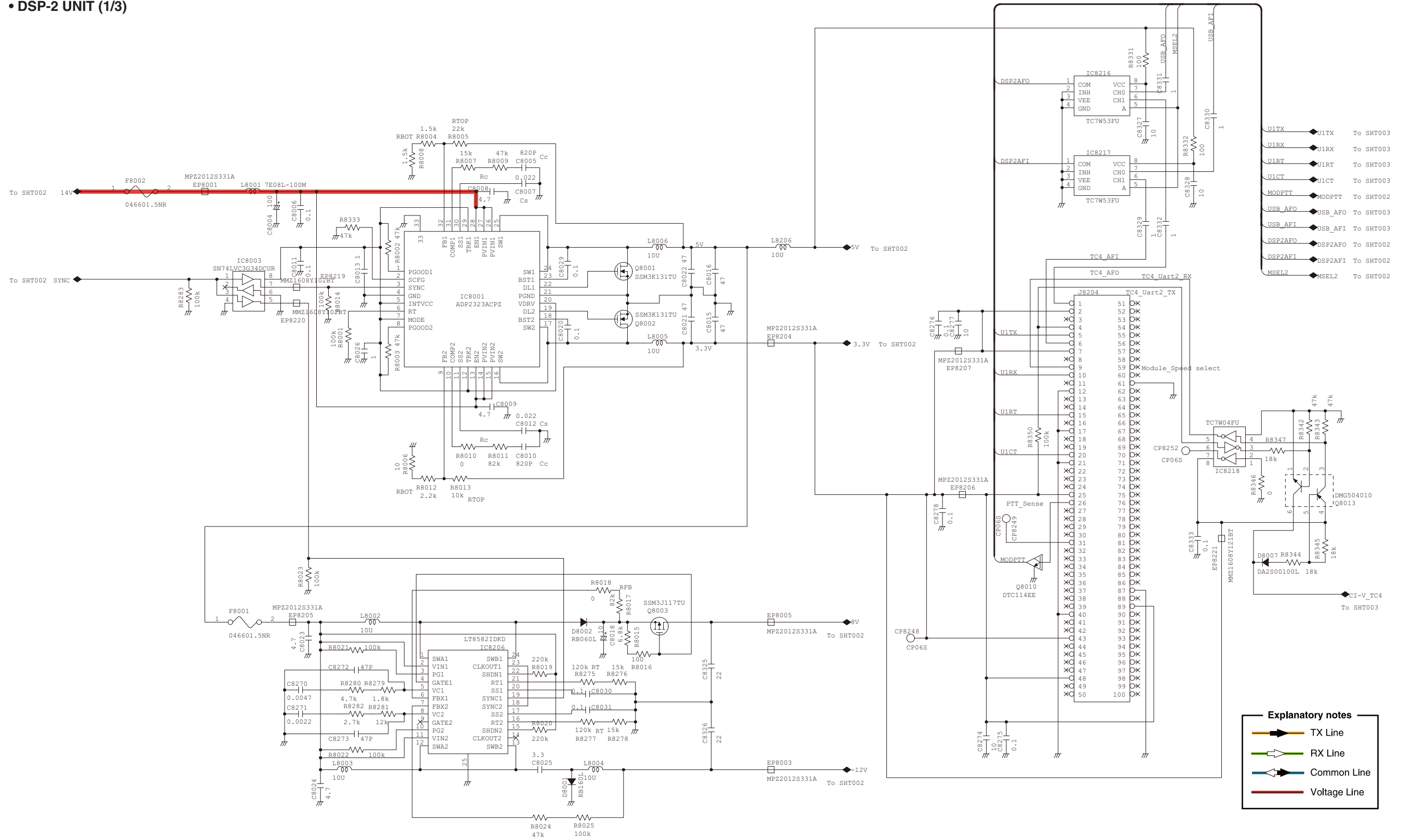

*: Refer to the PARTS LIST for the value and name of component.

• DSP-2 UNIT (2/3)

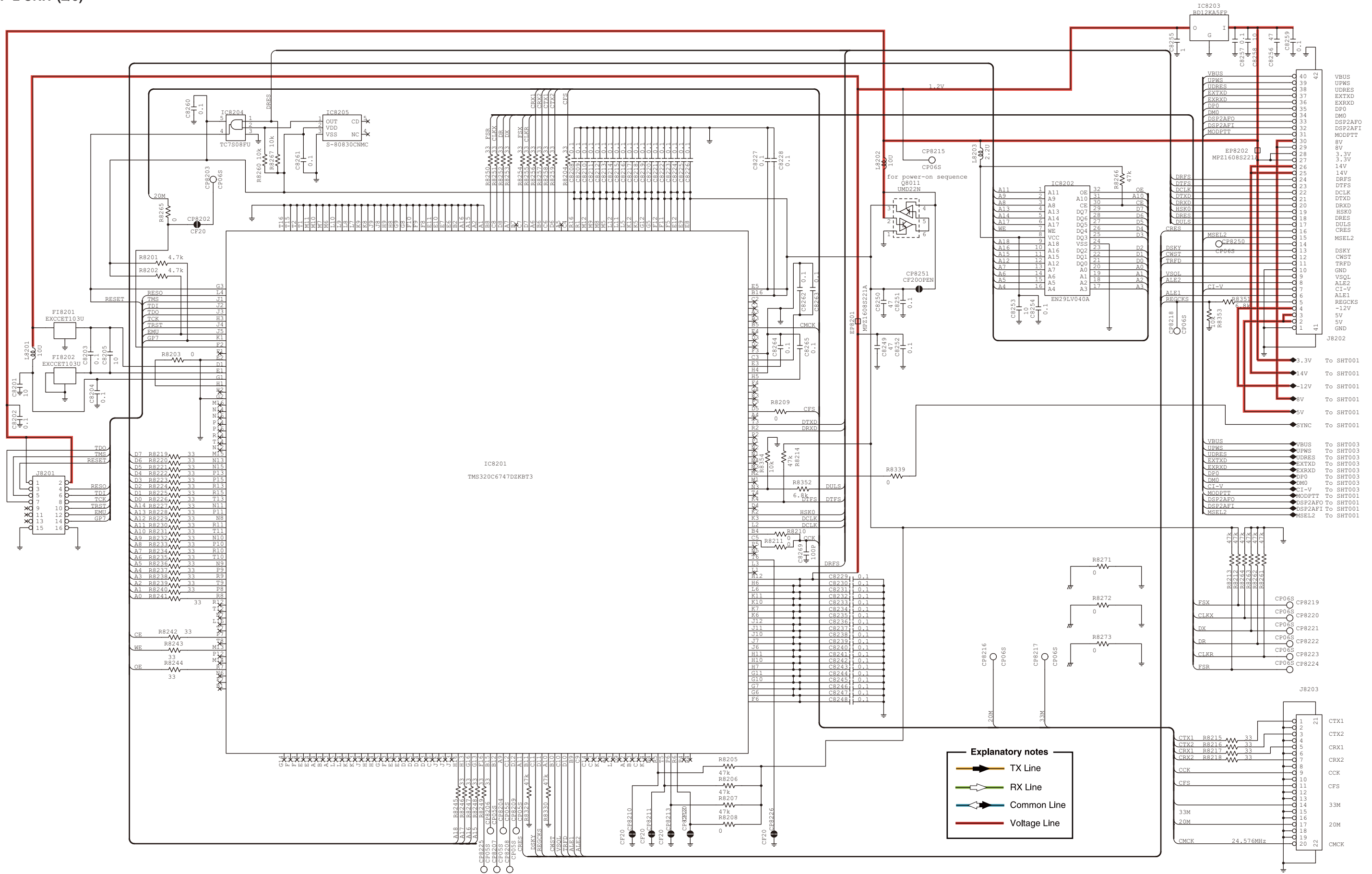

*: Refer to the PARTS LIST for the value and name of component.

• DSP-2 UNIT (3/3)

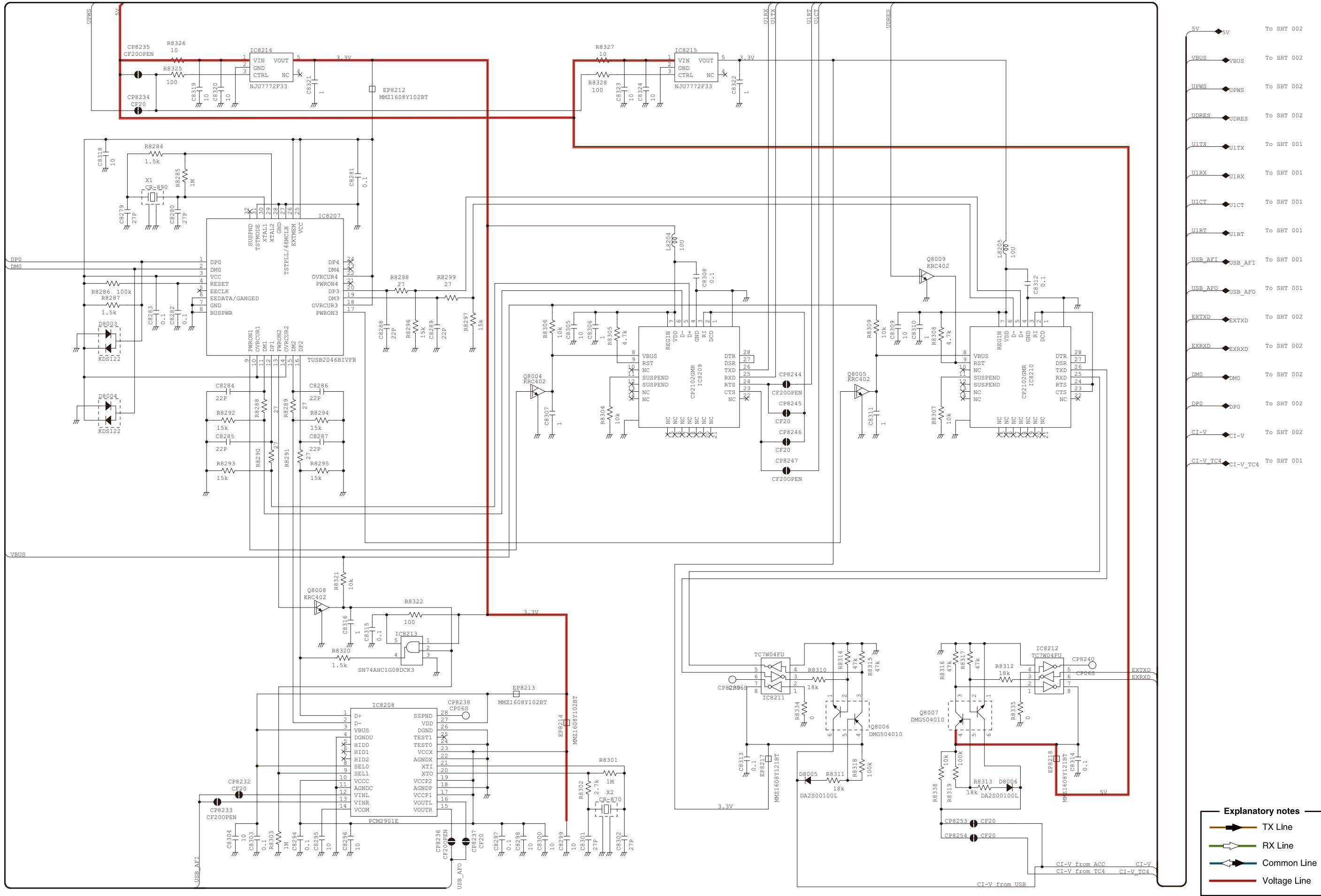

Explanatory notes

- TX Line
- RX Line
- Common Line
- Voltage Line

*: Refer to the PARTS LIST for the value and name of component.

Icom Inc.

1-1-32, Kamiminami, Hirano-ku, Osaka 547-0003, Japan
Phone : +81 (06) 6793 5302
Fax : +81 (06) 6793 0013
URL : <http://www.icom.co.jp/world/index.html>

Icom America Inc.

<Corporate Headquarters>
2380 116th Avenue N.E., Bellevue, WA 98004, U.S.A.
Phone : +1 (425) 454-8155 Fax : +1 (425) 454-1509
URL : <http://www.icomamerica.com>
E-mail : sales@icomamerica.com
<Customer Service>
Phone : +1 (425) 454-7619

Icom Canada

Glenwood Centre #150-6165
Highway 17 Delta, B.C., V4K 5B8, Canada
Phone : +1 (604) 952-4266 Fax : +1 (604) 952-0090
URL : <http://www.icomcanada.com>
E-mail : info@icomcanada.com

Icom (Australia) Pty. Ltd.

Unit 1 / 103 Garden Road, Clayton VIC 3168 Australia
Phone : +61 (03) 9549-7500 Fax : +61 (03) 9549-7505
URL : <http://www.icom.net.au>
E-mail : sales@icom.net.au

Icom New Zealand

146A Harris Road, East Tamaki,
Auckland, New Zealand
Phone : +64 (09) 274 4062 Fax : +64 (09) 274 4708
URL : <http://www.icom.co.nz>
E-mail : inquiries@icom.co.nz

Shanghai Icom Ltd.

No.101, Building 9, Caifuxingyuan Park, No.188 Maoting Road,
Chedun Town, Songjiang District, Shanghai, 201611, China
Phone : +86 (021) 6153 2768
Fax : +86 (021) 5765 9987

Icom Brazil

Rua Itororó, 444 Padre Eustáquio Belo Horizonte MG,
CEP: 30130-150 Brazil
Phone : +55 (31) 3582 8847 Fax : +55 (31) 3582 8987
E-mail : sales@icombrasil.com

Icom (Europe) GmbH

Communication Equipment
Auf der Krautweide 24
65812 Bad Soden am Taunus, Germany
Phone : +49 (6196) 76685-0 Fax : +49 (6196) 76685-50
URL : <http://www.icomeurope.com>
E-mail : info@icomeurope.com

Icom Spain S.L

Ctra. Rubi, No. 88 Bajos A 08174, Sant Cugat del Valles, Barcelona, Spain
Phone : +34 (93) 590 26 70 Fax : +34 (93) 589 04 46
URL : <http://www.icomspain.com>
E-mail : icom@icomspain.com

Icom (UK) Ltd.

Blacksale House, Altira Park, Herne Bay, Kent CT6 6GZ, UK
Phone : +44 (0) 1227 741741 Fax : +44 (0) 1227 741742
URL : <http://www.icomuk.co.uk>
E-mail : info@icomuk.co.uk

Icom France s.a.s.

Zac de la Plaine
1 Rue Brindejonc des Moulinais BP 5804
31505 Toulouse Cedex, France
Phone : +33 (5) 61 36 03 03 Fax : +33 (5) 61 36 03 00
URL : <http://www.icom-france.com>
E-mail : icom@icom-france.com

Asia Icom Inc.

6F No.68, Sec. 1 Cheng-Teh Road, Taipei, Taiwan, R.O.C.
Phone : +886 (02) 2559 1899 Fax : +886 (02) 2559 1874
URL : <http://www.asia-icom.com>
E-mail : sales@asia-icom.com

Icom Polska Sp. Z o.o.

80-286 Gdansk, Jaskowa Dolina St. 75, Poland
Phone : +48 (58) 551 0484 Fax : +48 (58) 551 4720
E-mail : icompolska@icompolska.pl
URL : <http://www.icompolska.pl>

Count on us!

Icom Inc.

1-1-32, Kamiminami, Hirano-ku, Osaka 547-0003, Japan

S-15005XZ-C1
© 2013 Icom Inc.