



INSTRUCTION MANUAL

HF TRANSCEIVER IC-F8101



This device complies with Part 15 of the FCC Rules. Operation is subject to the condition that this device does not cause harmful interference.

FOREWORD

Thank you for purchasing this Icom product. The IC-F8101 HF TRANSCEIVER is designed and built with Icom's state of the art technology and craftsmanship. With proper care, this product should provide you with years of trouble-free operation.

We appreciate you making the IC-F8101 your radio of choice, and hope you agree with Icom's philosophy of "technology first." Many hours of research and development went into the design of your IC-F8101.

◇ FEATURES



- *ALE (Automatic Link Establishment)/Sel-call capability*
- *Digital Signal Processor (DSP) allows flexible filter selection*
- *Full-dot matrix LCD for a variety of information*

IMPORTANT

READ THIS INSTRUCTION MANUAL CAREFULLY before attempting to operate the transceiver.

SAVE THIS INSTRUCTION MANUAL. This manual contains important safety and operating instructions for the IC-F8101.

EXPLICIT DEFINITIONS

WORD	DEFINITION
 DANGER!	Personal death, serious injury or an explosion may occur.
 WARNING!	Personal injury, fire hazard or electric shock may occur.
CAUTION	Equipment damage may occur.
NOTE	Recommended for optimum use. No risk of personal injury, fire or electric shock.

FCC INFORMATION

FOR CLASS A UNINTENTIONAL RADIATORS:

This equipment has been tested and found to comply with the limits for a Class A digital device, pursuant to part 15 of the FCC Rules. These limits are designed to provide reasonable protection against harmful interference when the equipment is operated in a commercial environment. This equipment generates, uses, and can radiate radio frequency energy and, if not installed and used in accordance with the instruction manual, may cause harmful interference to radio communications. Operation of this equipment in a residential area is likely to cause harmful interference in which case the user will be required to correct the interference at his own expense.

CAUTION: Changes or modifications to this transceiver, not expressly approved by Icom Inc., could void your authority to operate this transceiver under FCC regulations.

Icom, Icom Inc. and the Icom logo are registered trademarks of Icom Incorporated (Japan) in Japan, the United States, the United Kingdom, Germany, France, Spain, Russia and/or other countries.
All other products or brands are registered trademarks or trademarks of their respective holders.



N33

Versions of the IC-F8101 which display the "N33" symbol on the serial number seal, comply with Standard Australia Specification No. AS/NZS 4770: 2000.

TABLE OF CONTENTS

FOREWORD	i
IMPORTANT	i
EXPLICIT DEFINITIONS	i
FCC INFORMATION	i
TABLE OF CONTENTS	ii
SAFETY TRAINING INFORMATION	iii
INFORMATION EN MATIÈRE DE SÉCURITÉ	iv
PRECAUTIONS	v
1 PANEL DESCRIPTION	1–6
■ Controller (Front panel or HM-192)	1
■ Rear panel	4
■ LCD screen	5
2 BASIC OPERATION	7–10
■ Power ON	7
■ Selecting the display mode	7
■ Selecting a channel	8
■ Setting audio volume	8
■ Squelch function	8
■ Scan function	9
■ Mode selection	9
■ VFO operation	10
3 RECEIVE AND TRANSMIT	11–17
■ Basic voice transmit/receive	11
■ Functions for transmit	12
■ Functions for receive	14
4 SELCALL/ALE OPERATION	18–32
■ Selcall/ALE	18
5 MENU SCREEN	33–65
■ Manager Menu	33
■ Main Menu	46
■ CPU Reset	65
6 CONNECTION AND INSTALLATION	66–79
■ Supplied accessories	66
■ Connections	68
■ Ground connection	70
■ Power source	71
■ Antenna	71
■ CFU-F8100 (Optional Cooling Fan)	71
■ RMK-6 (Optional Separation kit)	72
■ HM-192 (Optional Remote control microphone)	74
■ Mounting	75
■ Fuse replacement	77
■ Connector information	78
■ Connector information for OPC-2308	79
7 SPECIFICATIONS	80
8 OPTIONS	81



SAFETY TRAINING INFORMATION



Your Icom radio generates RF electromagnetic energy during transmit mode. This radio is designed for and classified as “Occupational Use Only”, meaning it must be used only during the course of employment by individuals aware of the hazards, and the ways to minimize such hazards. This radio is **NOT** intended for use by the “General Population” in an uncontrolled environment.

- For compliance with FCC and IC RF Exposure Requirements, the transmitter antenna installation shall comply with the following two conditions:
 1. The transmitter antenna gain shall not exceed 0 dBi.
 2. The antenna is required to be located outside of a vehicle and kept at a distance of 80 centimeters or more between the transmitting antenna of this device and any persons during operation. For small vehicle as worst case, the antenna shall be located on the roof top at any place on the centre line along the vehicle in order to achieve 80 centimeters separation distance. In order to ensure this distance is met, the installation of the antenna must be mounted at least 80 centimeters away from the nearest edge of the vehicle in order to protect against exposure to bystanders.
 3. Transmit only when people outside the vehicle are at least the recommended minimum distance of 160 centimeters away from the properly installed antenna. This separation distance will ensure that there is sufficient distance from a properly installed externally-mounted antenna to satisfy the RF exposure requirements in the applicable RF exposure compliance standards.



To ensure that your exposure to RF electromagnetic energy is within the FCC and IC allowable limits for occupational use, always adhere to the following guidelines:

- **DO NOT** operate the radio without a proper antenna attached, as this may damage the radio and may also cause you to exceed FCC and IC RF exposure limits. A proper antenna is the antenna supplied with this radio by the manufacturer or an antenna specifically authorized by the manufacturer for use with this radio.
- **DO NOT** transmit for more than 50% of total radio use time (“50% duty cycle”). Transmitting more than 50% of the time can cause FCC and IC RF exposure compliance requirements to be exceeded. The radio is transmitting when the “TX” icon is displayed. You can cause the radio to transmit by pressing the “PTT” switch.

Electromagnetic Interference/Compatibility

During transmissions, your Icom radio generates RF energy that can possibly cause interference with other devices or systems. To avoid such interference, turn OFF the radio in areas where signs are posted to do so. **DO NOT** operate the transmitter in areas that are sensitive to electromagnetic radiation such as hospitals, aircraft, and blasting sites.

INFORMATION EN MATIÈRE DE SÉCURITÉ



Votre radio Icom produit une énergie électromagnétique de radiofréquences (RF), en mode de transmission. Cette radio est conçue pour un «usage professionnel seulement» et classée comme tel, ce qui signifie qu'elle doit être utilisée uniquement dans le cadre d'un travail par des personnes conscientes des dangers et des mesures visant à minimiser ces dangers. Elle **N'EST PAS** conçue pour une «utilisation grand public», dans un environnement non contrôlé.

- Afin de satisfaire aux exigences de la FCC et d'IC en matière d'exposition aux RF, il est nécessaire que l'antenne soit installée conformément aux trois conditions suivantes:
 1. Le gain de l'antenne du radio émetteur ne doit pas dépasser 0 dBi.
 2. Il faut que l'antenne émettrice de cet appareil soit placée à l'extérieur d'un véhicule et tenue éloignée d'au moins 80 centimètres de toute personne pendant le fonctionnement. Dans le pire des cas, pour un petit véhicule, l'antenne doit être placée sur le toit, n'importe où dans l'axe central du véhicule, afin de respecter une distance de 80 cm du bord le plus rapproché du véhicule et ainsi éviter que les personnes présentes soient exposées.
 3. Émettre uniquement lorsque les personnes à l'extérieur du véhicule se trouvent à au moins la distance minimale recommandée de 160 cm de l'antenne correctement installée. Cette distance de sécurité assurera que les personnes soient placées suffisamment loin d'une antenne correctement fixée à l'extérieur pour satisfaire aux exigences en matière d'exposition aux RF, en vertu des normes de conformité applicables.



Afin de vous assurer que votre exposition à une énergie électromagnétique de RF se situe dans les limites permises par la FCC et d'IC pour une utilisation grand public, veuillez en tout temps respecter les directives suivantes:

- **NE PAS** faire fonctionner la radio sans qu'une antenne appropriée y soit fixée, car ceci risque d'endommager la radio et causer une exposition supérieure aux limites établies par la FCC et d'IC. L'antenne appropriée est celle qui est fournie avec cette radio par le fabricant ou une antenne spécialement autorisée par le fabricant pour être utilisée avec cette radio.
- **NE PAS** émettre pendant plus de 50 % du temps total d'utilisation de l'appareil («50 % du facteur d'utilisation»). Émettre pendant plus de 50 % du temps total d'utilisation peut causer une exposition aux RF supérieure aux limites établies par la FCC et d'IC. La radio est en train d'émettre lorsque le témoin du mode de transmission s'affiche sur l'écran ACL. La radio émettra si vous appuyez sur le bouton du microphone.

Interférence électromagnétique et compatibilité

En mode de transmission, votre radio Icom produit de l'énergie de RF qui peut provoquer des interférences avec d'autres appareils ou systèmes. Pour éviter de telles interférences, mettez la radio hors tension dans les secteurs où une signalisation l'exige. **NE PAS** faire fonctionner l'émetteur dans des secteurs sensibles au rayonnement électromagnétique tels que les hôpitaux, les aéronefs et les sites de dynamitage.

PRECAUTIONS

⚠ **DANGER HIGH RF VOLTAGE! NEVER** attach an antenna or internal antenna connector during transmission. This may result in an electrical shock or burn.

⚠ **WARNING! NEVER** operate the transceiver with a headset or other audio accessories at high volume levels. Hearing experts advise against continuous high volume operation. If you experience a ringing in your ears, reduce the volume or discontinue use.

⚠ **WARNING! NEVER** operate or touch the transceiver with wet hands. This may result in an electric shock or damage to the transceiver.

⚠ **WARNING! NEVER** apply AC power to the [DC13.8V] socket on the transceiver rear panel. This could cause a fire or damage the transceiver.

⚠ **WARNING! NEVER** apply more than 16 V DC to the [DC13.8V] socket on the transceiver rear panel, or use reverse polarity. This could cause a fire or damage the transceiver.

⚠ **WARNING! NEVER** let metal, wire or other objects protrude into the transceiver or into connectors on the rear panel. This may result in an electric shock.

⚠ **WARNING! ALWAYS** use the supplied Black and red cables with fuse holders. After connecting the fuse holders, **NEVER** cut the DC power cable between the DC plug and fuse holder. If an incorrect connection is made after cutting, the transceiver might be damaged.

⚠ **WARNING!** Immediately turn OFF the transceiver power and remove the power cable if it emits an abnormal odor, sound or smoke. Contact your Icom dealer or distributor for advice.

CAUTION: NEVER change the internal settings of the transceiver. This may reduce transceiver performance and/or damage to the transceiver.

In particular, incorrect settings for transmitter circuits, such as output power, idling current, and so on, might damage the expensive final devices.

The transceiver warranty does not cover any problems caused by unauthorized internal adjustment.

CAUTION: NEVER install the transceiver in a place without adequate ventilation. Heat dissipation may be reduced, and the transceiver may be damaged.

DO NOT use or place the transceiver in direct sunlight or in areas with temperatures below -30°C (-22°F) or above $+60^{\circ}\text{C}$ ($+140^{\circ}\text{F}$).

The basic operations, transmission and reception of the transceiver are guaranteed within the specified operating temperature range. However, the LCD display may not be operate correctly, or show an indication in the case of long hours of operation, or after being placed in extremely cold areas.

DO NOT use harsh solvents such as benzine or alcohol when cleaning, as they will damage the transceiver surfaces.

DO NOT push the PTT switch when you don't actually desire to transmit.

DO NOT place the transceiver against walls or putting anything on top of the transceiver. This may overheat the transceiver.

Always place unit in a secure place to avoid inadvertent use by children.

BE CAREFUL! If you use a linear amplifier, set the transceiver's RF output power to less than the linear amplifier's maximum input level, otherwise, the linear amplifier will be damaged.

BE CAREFUL! The transceiver will become hot when operating the transceiver continuously for long periods of time.

USE only the specified microphone. Other manufacturers' microphones have different pin assignments, and connection to the IC-F8101 may damage the transceiver or microphone.

During mobile operation, **NEVER** place the transceiver where air bag deployment may be obstructed.

During mobile operation, **DO NOT** place the transceiver where hot or cold air blows directly onto it.

During mobile operation, **DO NOT** operate the transceiver without running the vehicle's engine. When the transceiver's power is ON and your vehicle's engine is OFF, the vehicle's battery will soon become exhausted.

Make sure the transceiver power is OFF before starting the vehicle engine. This will avoid possible damage to the transceiver by ignition voltage spikes.

During maritime mobile operation, keep the transceiver and microphone as far away as possible from the magnetic navigation compass to prevent erroneous indications.

Turn OFF the transceiver's power and/or disconnect the DC power cable when you will not use the transceiver for long period of time.

KEEP the transceiver away from the heavy rain, and Never immerse it in the water. The transceiver meets IP54* requirements for dust-protection and splash resistance.

However, once the transceiver has been dropped, dust-protection and splash resistance cannot be guaranteed due to the fact that the transceiver may be cracked, or the waterproof seal damaged, and so on.

* Only when the supplied microphone is attached.

■ Controller (Front panel or HM-192)

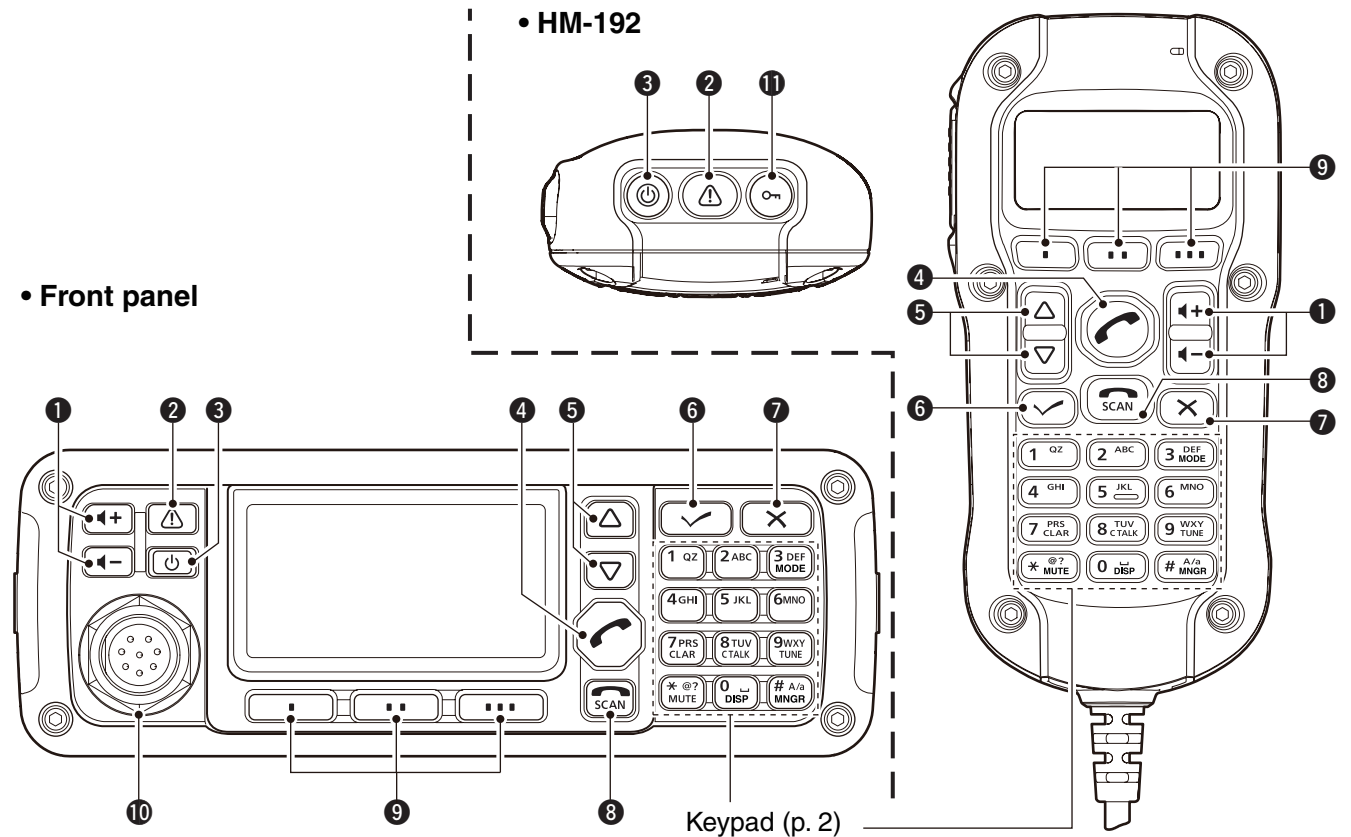

• Common

1 VOLUME KEYS [◀+]/[▶-] (p. 8)
Adjusts the audio output level.

2 EMERGENCY KEY [⚠]

NOTE: While in the VFO mode, the Emergency key cannot be used.

- ➔ Push to enter the Emergency channel list.
 - Push again to return to the normal operating screen.
- ➔ Hold down for 1 second to transmit Selcall and RFDS (Royal Flying Doctor Service) calls to the specified Selcall addresses in sequential order.

NOTE: RFDS calls are available in only the Australian versions.

3 POWER KEY [⏻]

- ➔ When the transceiver's power is OFF:
 - Push to turn ON the transceiver power.
 - First, turn ON the DC power source.
- ➔ When the transceiver's power is ON:
 - Hold down for 2 seconds to turn OFF the power.

4 CALL KEY [☎]

- Push to enter the Call menu.
 - Push again to go to the next screen in the Call menu.

5 UP/DOWN KEYS [▲]/[▼]

Selects the operating channel, the items in the Menu mode, and so on.

6 ENTER KEY [✓]

- ➔ Push to enter and exit the selected Menu in the Menu screen.
- ➔ Hold down for 1 second to enter the programming mode.

7 CLEAR KEY [✕]

- ➔ Push to enter or exit the Main Menu screen.
- ➔ Push to return to the previous screen.

8 CALL END/SCAN [SCAN]

- ➔ Push to hang up or terminate a call.
- ➔ Push to start or stop a scan

9 FUNCTION KEYS [•]/[••]/[•••]

Push to select the function that is displayed above each key on the LCD display.

- The functions vary, depending on the preprogramming and selected menu.

Continued on the next page.

1 PANEL DESCRIPTION

■ Controller (Front panel or HM-192) (Continued)

• Front panel

⑩ MICROPHONE CONNECTOR [MIC]

Connects to only the microphone supplied with the transceiver.

NOTE: NEVER connect the HM-192 or any other microphone here. This could damage the transceiver and/or the microphone.

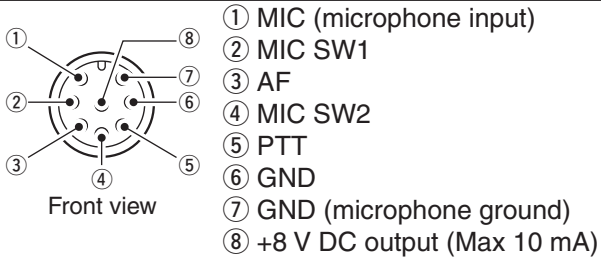

• HM-192

⑪ LOCK KEY [O-]

Hold down for 1 second to set the Key lock function to ALL, NUMERIC KEY or OFF.

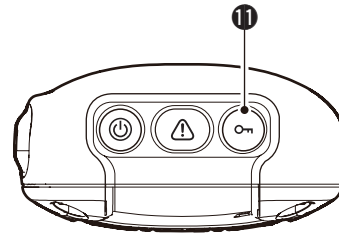

◇ Keypad

➔ Inputs numbers, characters or letters.

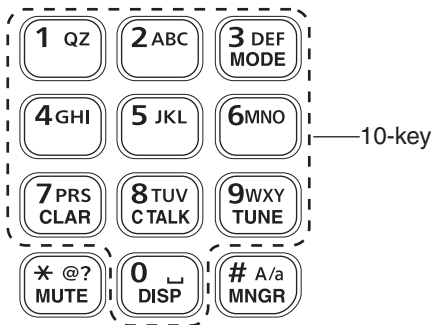

• Selectable characters

KEY	INPUT	KEY	INPUT
1 QZ	1 Q Z q z	8 TUV CTALK	8 T U V t u v
2 ABC	2 A B C a b c	9 WXY TUNE	9 W X Y w x y
3 DEF MODE	3 D E F d e f	0 _ DISP	0 (space)
4 GHI	4 G H I g h i	* @? MUTE	, . ; ? : " ` ' / ! @ # \$ % ^ & * () _ - + = \ ~ < > { } []
5 JKL	5 J K L j k l	# A/a MNGR	Upper/Lower case letters/Numbers
6 MNO	6 M N O m n o		
7 PRS CLAR	7 P R S p r s		

MODE KEY [MODE]

Push to select the operating mode.

NOTE: The selectable operating mode can be programmed in the “Mode” item of “Set-mode.”

(Main Menu > Setmode > Mode) (pp. 56–60)

CLARIFIER KEY [CLAR]

Push to open the Clarifier adjustment window.

- Push [△] or [▽] to adjust the frequency shift.
- Push this key again to close the window.

CLEAR TALK KEY [C TALK]

Push to turn the Clear Talk function ON or OFF.

- The “” icon appears when the function is ON.

TUNER KEY [TUNE]

Push to open the Antenna tune window. (p. 11)

- Push [] to start auto tuning.
- Push this key again to close the window.

DISPLAY KEY [DISP]

Push to select the display information.



- ‘Frequencies,’ ‘Latitude and Longitude,’ ‘Direction and Elevation,’ ‘Antenna SWR and Power source voltage’ and ‘Date and Time’ can be selected. ‘Latitude and Longitude’ and ‘Direction and Elevation’ require data from a GPS unit.

MUTE KEY [MUTE]

Push to select the squelch type. Call squelch, S-meter squelch (level 1 to 50), Voice squelch or squelch OFF are selectable.

- The “” icon appears when the Call squelch function is ON.

NOTE: The Call squelch function cannot be selected in the VFO mode.

- The “” icon appears when the S-meter squelch function is ON.
- The “” icon appears when the Voice squelch function is ON.

MANAGER KEY [MNGR]

Push to enter the Manager Menu screen.

■ Rear panel

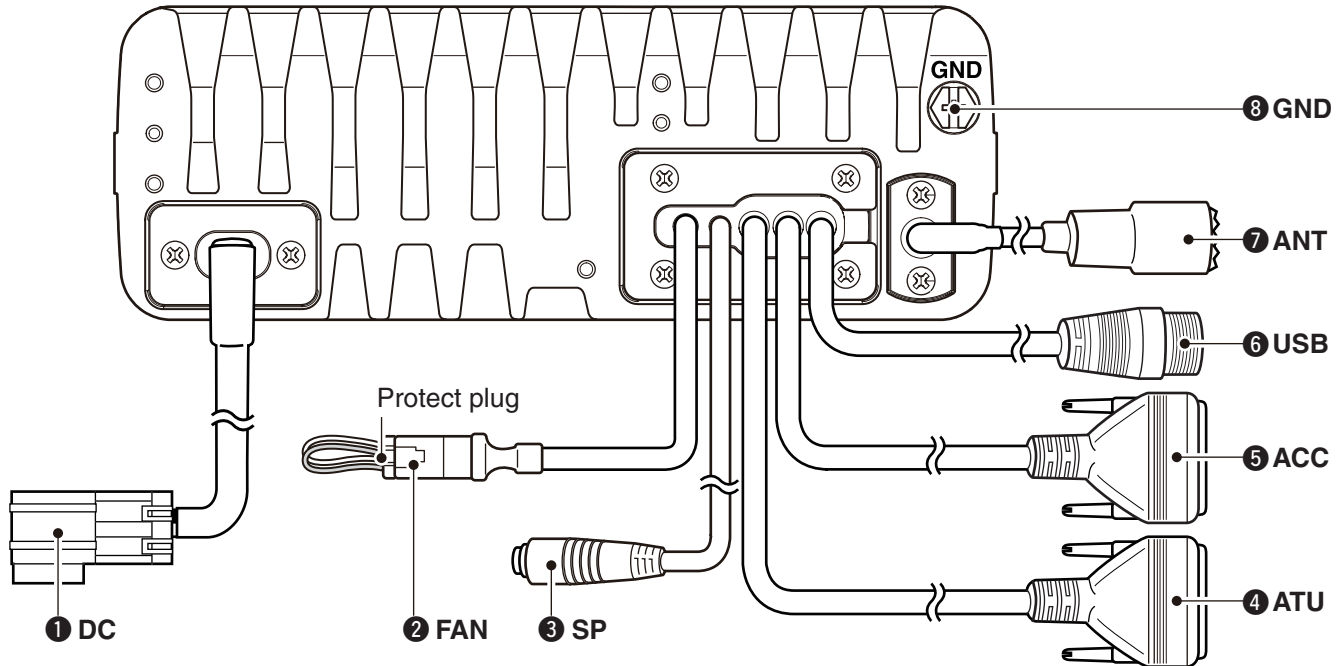

1 DC POWER CONNECTOR [DC]

Accepts 13.8 V DC through a DC power cable.

2 FAN CONNECTOR [FAN]

Connects to the optional CFU-F8100 Cooling Fan.

NOTE: Attach the protect plug when the optional Cooling Fan is not used.

3 SPEAKER JACK [SP]

Connects to an external speaker such as the supplied SP-35/L.

4 ACCESSORY CONNECTOR (9 PIN) [ATU]

Connects to the optional antenna tuner through the OPC-2309 ANTENNA TUNER CABLE.

NOTE: Attach the connector caps when the optional cable is not connected.

5 ACCESSORY CONNECTOR (15 PIN) [ACC]

Connects to a GPS unit or an external modem through the optional OPC-2308 GPS/EXTMOD CONNECTION CABLE.

When connecting a GPS unit, the transceiver sets your position and time data in NMEA0183 version 3.xx format.

NOTE: Attach the connector caps when the optional cable is not connected.

6 USB CONNECTOR [USB]

Connects to a PC through an A-B type USB cable.

7 ANTENNA CONNECTOR

Connects to a 50 Ω HF band antenna.

8 GROUND TERMINAL

IMPORTANT! Connects to a solid ground point.

LCD screen

• Memory Channel Display

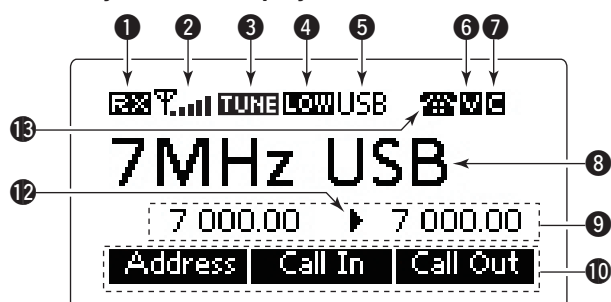

• VFO Display

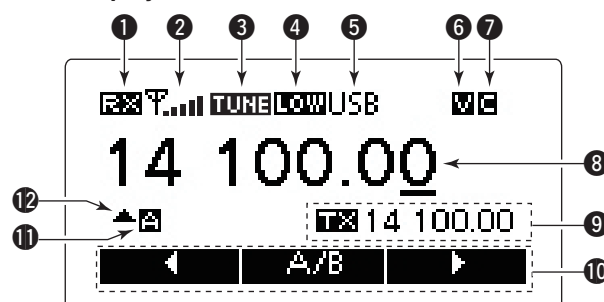

1 RECEIVE/TRANSMIT ICON

- ➔ “RX” appears when signals are received or the squelch is open.
- ➔ “TX” appears when transmitting.

2 S-METER/TX METERS

- ➔ Displays the receive signal strength.
- ➔ Displays the transmit output power.

3 TUNE ICON

Appears after the automatic antenna tuner matches the transceiver and antenna.

NOTE:

Appears only the frequency is set to within 10 Hz of the tuned frequency.

4 OUTPUT POWER ICON

- ➔ “HI” appears when high power is selected.
- ➔ “MID” appears when mid power is selected.
- ➔ “LOW” appears when low power is selected.

5 OPERATING MODE INDICATOR

Displays the selected operating mode.

- “LSB,” “USB,” “CW,” “AM,” RTTY,” “LSBD1,” “USBD1,” “LSBD2,” “USBD2,” “LSBD3” or “USBD3” appears, depending on the operating mode.

Selectable operating modes differ depending on the transceiver version and/or preprogramming.

6 MUTE ICON

- ➔ “S” appears when the Call squelch function is selected.
- ➔ “L” appears when the S-meter squelch is selected.
- ➔ “V” appears when the Voice squelch is selected.

7 CLEAR TALK ICON

Appears when the Clear Talk function is ON.

8 MAIN READOUTS

<Memory Channel display>

Displays the channel name.

<VFO display>

Displays the operating frequency.

9 SUB READOUTS

<Memory Channel display>

Displays the selected information.

- ‘Frequencies,’ ‘Latitude and Longitude,’ ‘Direction and Elevation,’ ‘Antenna SWR and Power source voltage’ and ‘Date and Time’ can be displayed.
- ‘Latitude and Longitude’ and ‘Direction and Elevation’ require data from a GPS unit.
- When the frequencies are displayed, the receive frequency is displayed on the right and the transmit frequency is displayed on the left.
- “▶” appears beside the receive or transmit frequencies, and indicates which one is active.
- “▲” or “▼” appears instead of “▶” to the right of the receive frequency, when the Clarifier function is ON, and it indicates the upper or lower shift.

NOTE: No transmit frequency is displayed when the selected channel is configured as “receive only.”

<VFO display>

Shows the transmit or receive frequency when VFO split is ON.

10 FUNCTION DISPLAY

Displays the function of the [▪], [▪▪] and [▪▪▪] function keys.

11 VFO ICON

<VFO display>

- ➔ “A” appears when VFO A is selected.
- ➔ “B” appears when VFO B is selected.

12 CLARIFIER ICON

<VFO display>

“▲” or “▼” appears when the Clarifier function is ON, and indicates the upper or lower shift.

Continued on the next page.

■ LCD screen (Continued)



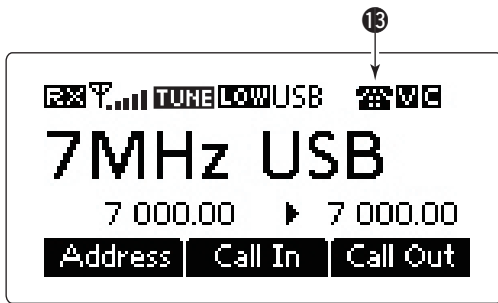





• Memory Channel Display







13 CALL ICON

Displays the Call type icons for Selcall or ALE.

<Selcall>

- The “” icon blinks or appears when a Selective call is transmitted or linked.
- The “” icon blinks or appears when a Phone call is transmitted or linked.
- The “” icon blinks when a Message call is transmitted.
- The “” icon blinks when a Send Position is transmitted.
- The “” icon blinks when a Get Position call is transmitted, or while waiting for its acknowledgement.
- The “” icon blinks when a Get Status call is transmitted, or while waiting for its acknowledgement.
- The “” icon blinks or appears when an Emergency call is transmitted or linked.
- The “” icon blinks when a Channel Test call is transmitted or while waiting for its acknowledgement.
- The “” icon blinks or appears when an RFDS Emergency call is transmitted or linked.

<ALE>

- The “” icon blinks when an Individual call is transmitted or while waiting for its acknowledgement. The icon stays ON when the call is linked.
- The “” icon blinks when a NET call is transmitted or while waiting for its acknowledgement. The icon stays on when the call is linked.
- The “” icon blinks when an AMD call is transmitted or while waiting for its acknowledgement. The icon stays ON when the call is linked.
- The “” icon blinks when a Sounding is transmitted.

Power ON

- Push [P] to turn ON the Power.
 - If the "Built-in Test Display" item of "Setmode" is set to ON, 'Built in Test' appears.
(Main Menu > Setmode > Config)
 - If the "User" item of "Setmode" is programmed, "Login" appears.
(Main Menu > Setmode > Password)

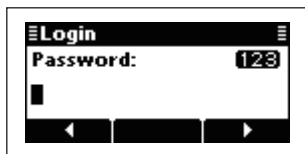

- Push the keypad keys to enter either the User password or Administrator password, and then push [✓].
 - Repeatedly push [A/a](#) to select the character group, ABC (upper case letters), abc (lower case letters) or 123 (numbers).
 - Push [X] to delete a character.
 - Push [◀](*) or [▶](***) to move the cursor.

NOTE:

- If you want to change any settings, you must be in the Administrator mode.
- You can log into the Administrator mode with the "Admin Login" item in the Manager Menu screen (p. 34).

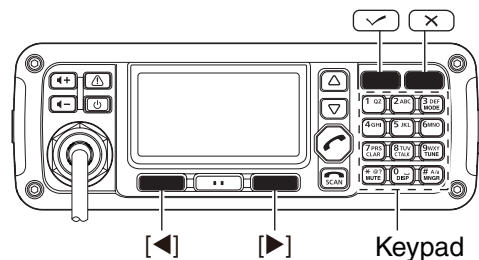
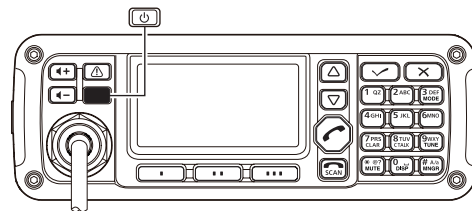

1
2

Selecting the display mode

- Push [X] to enter the Main Menu screen.
- Push [△] or [▽] to select "Channel" or "VFO," and then push [✓].
 - If "Channel" is selected, the Memory Channel display appears.
 - If "VFO" is selected, the VFO display appears.

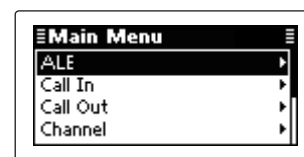
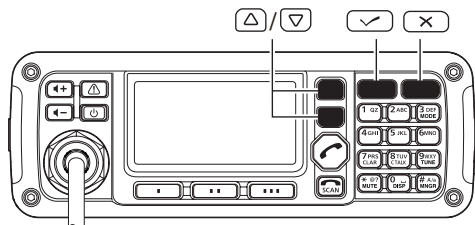

Main Menu screen

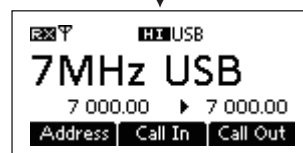

Memory channel display

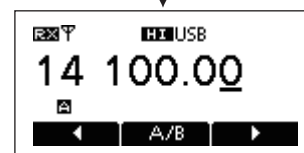

VFO display

■ Selecting a channel

① Select the Memory Channel Display.

- ① Push [X] to enter the Main Menu screen.
- ② Push [Δ] or [∇] to select “Channel,” and then push [✓].

② Push [Δ] or [∇] to select a desired memory channel.

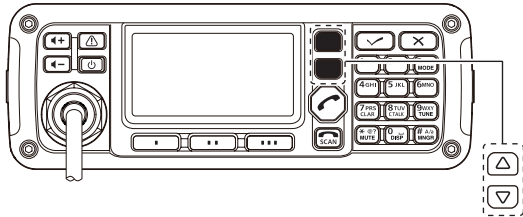

■ Setting audio volume

➔ Push [◀+] or [▶-] to adjust the audio level.

- If the squelch is closed, push [MUTE](*) one or more times to open the squelch.
- The display shows the volume level while adjusting.

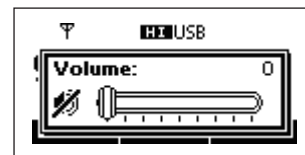
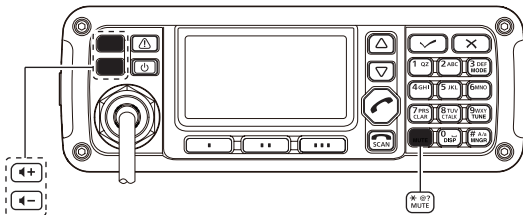

Minimum audio level

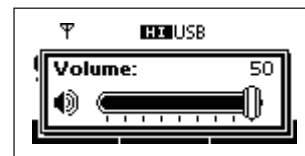

Maximum audio level

■ Squelch function

The squelch function detects signals with voice components and mutes unwanted signals. This provides quiet stand-by.

When you need to receive weak signals, the squelch can be turned OFF.

➔ Push [MUTE](*) one or more times to select a squelch type.

- Selectable types are Call SQL, S-meter SQL (level 0 to 50), Voice SQL and OFF.
- The S-meter squelch level can be adjusted by the “Meter Squelch Level” item of “Setmode.” (Main Menu > Setmode > Config)

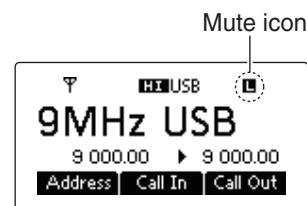
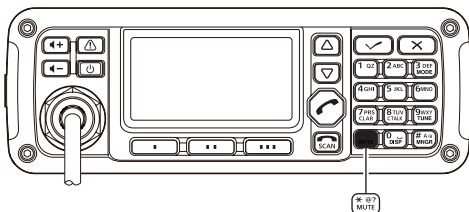

- The Mute icon, “S,” “L” or “V,” appears when the squelch function, Call SQL, S-meter SQL or Voice SQL is turned ON.

NOTE: The Call squelch function cannot be selected in the VFO mode.

Scan function

The scan function repeatedly scans programmed channels. This function is convenient to check for calls on multiple channels.

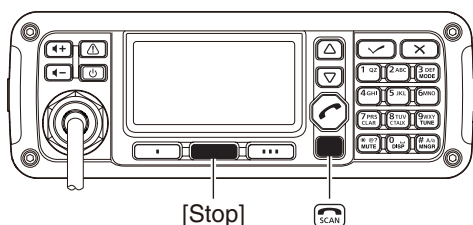

- 1 Push [**SCAN**] to start a scan.
 - “Scanning” and the Scan type are displayed.

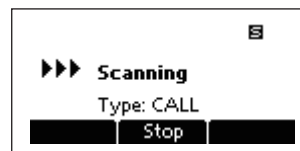

- 2 When a signal is received, the scan pauses on that channel.
- 3 Push [**Stop**](***) to cancel the scan.
 - Pushing [**SCAN**] also cancels the scan.

NOTE: The scan resume setting, the action after receiving a signal, can be changed by the “Voice Scan Resume” item of “Setmode.”
(Main Menu > Setmode > Config)

Mode selection

The following modes are selectable in the IC-F8101: LSB, USB, CW, AM, RTTY, LSB1/2/3 and USB1/2/3.

NOTE: Only the preprogrammed operating modes are selectable.

The selectable operating mode can be changed in the “Mode” item of “Setmode.”

(Main Menu > Setmode)

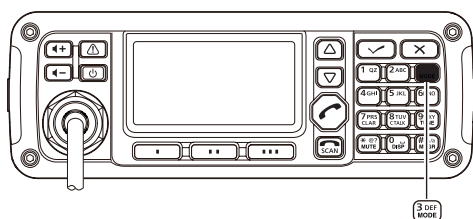

- 1 Select the Display mode.

- 1 Push [**X**] to enter the Main Menu screen.
- 2 Push [**Δ**] or [**∇**] to select “Channel” or “VFO,” and then push [**✓**].



- 2 Push [**Mode**](3) one or more times to select the desired mode.
 - The selected mode icon appears at the top of the display.

NOTE:

- On the Memory Channel display, the selected operating mode can be used only temporarily. When the channel is changed, the transceiver returns to the preprogrammed operating mode.
- Depending on the transceiver version or preprogramming, some operating modes may not be selectable or usable except in receive.

◇ For your reference

Mode	TX/RX offset frequency [Hz]	RX filter band width [Hz]	Modulation input	
			MIC PTT ON	MODEM PTT ON
LSB, USB	1500 (Fixed)	100 to 3000 (100Hz step)	MIC	TC4, ACC, USB
LSBD1, USB1	1500, 1650, 1800			TC4, ACC, USB
LSBD2, USB2	1500 , 1650, 1800			TC4, ACC , USB
LSBD3, USB3	1500, 1650 , 1800			TC4, ACC , USB

Default settings are shown in bold.

VFO operation

In the VFO mode, you can set a desired operating frequency, operating mode or split frequency function.

NOTE:

- The VFO mode operation can be disabled by the “VFO Mode” item of “Setmode.”
(Main Menu > Setmode > Config)
- While in the VFO mode, the Selcall, ALE features, Scan function or the Emergency key cannot be used.

• Entering the VFO mode

- ① Push [X] to enter the Main Menu screen.
- ② Push [Δ] or [∇] to select “VFO,” and then push [✓].

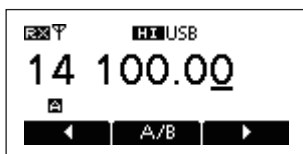

• Frequency setting

- ① Push [A/B](**) to select VFO A or VFO B.
- ② Push [◀](*) or [▶](***) to move the cursor to select the desired digit to be changed.
 - The cursor is displayed below the selected digit.

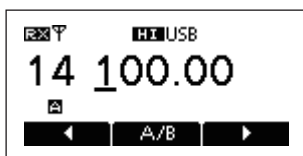

- ③ Push [Δ] or [∇] to change the digit.

• Direct frequency setting

- ① Push [A/B](**) to select VFO A or VFO B.
- ② Hold down [✓] for 1 second to enter the direct frequency input mode.
 - The previously entered frequency blinks.

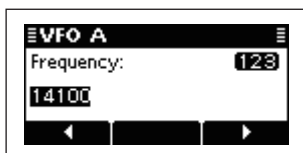

- ③ Push the keypad to enter the desired frequency.
 - Push [*] to enter the decimal point.
 - Push [X] to delete the number.
 - Push [◀](*) or [▶](***) to move the cursor.
- ④ Push [✓] to save the frequency and exit.

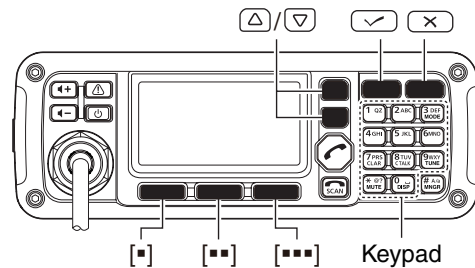

• Turning ON the Split frequency function

- ① Push [X] to enter the Main Menu screen.
- ② Select the “VFO Split” item of “Setmode.”
 - ① Push [Δ] or [∇] to select the item, and then push [✓] to open the screen.
(Setmode > Config)
 - ② Push [Δ] or [∇] to select “VFO Split,” and then hold down [✓] for 1 second.
- ③ Push [Δ] or [∇] to turn ON the function.
 - If desired, hold down [Default](**) for 1 second to return to the default setting.

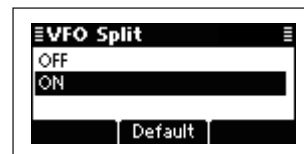

- ④ Push [✓] to save the setting, and return to the previous screen.
- ⑤ Push [X] one or more times to exit the Main Menu screen.
- ⑥ Enter the VFO mode. (See details to the left.)
- ⑦ Push [A/B](**) to select VFO A or VFO B, and separately set the receive and transmit frequencies.
 - The TX frequency appears below the RX frequency.
 - Push [A/B](**) changes the VFOs between transmit and receive.
 - Hold down [A/B](**) for 1 second to equalize the transmit frequency to the receive frequency.

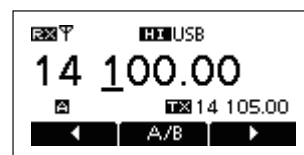

- To turn OFF the Split frequency function, set the “VFO Split” item of “Setmode.” to “OFF.”
(Main Menu > Setmode > Config)

Basic voice transmit/receive

- ① First, check the following.
 - ➔ The microphone and external speaker are connected.
 - ➔ No “**S**,” “**L**” or “**V**” mute icon appears.
 - If “**S**,” “**L**” or “**V**” appears, push [**MUTE**](*) one or more times to turn OFF the mute.

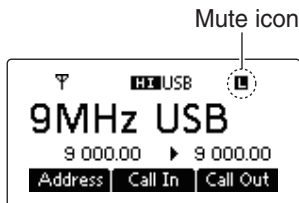

- ② Push [**Δ**] or [**∇**] to select the desired receive channel.

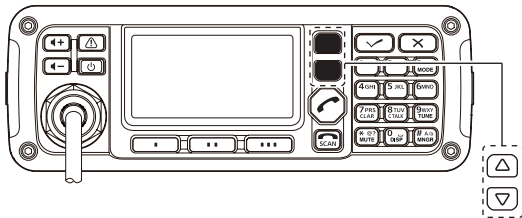

- The S-meter shows the signal strength when a signal is received.

- ③ Push [**◀+**] or [**◀-**] to adjust the desired audio level when receiving a signal.
 - If the bass or treble of the receive audio is too strong, push [**CLAR**](7) to set “Clarifier” to ON, and adjust to obtain clear audio. (See page 14 for the Clarifier function details.)
 - If the audio is distorted, select the suitable operating mode. (See page 9 for the Mode selection details.)

- ④ Push [**TUNE**](9) to enter the antenna tune mode.
 - The “Auto Tune” screen appears.

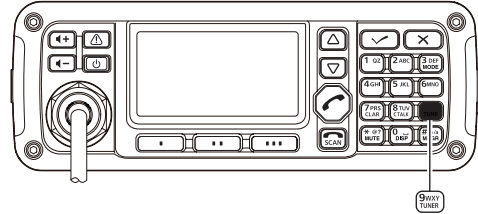

NOTE:
 The antenna tune mode must be set to ON by the “Tuner” item of “Setmode.” (Default: ON)
 (Main Menu > Setmode > Config)

- ⑤ Push [**✓**] to start auto tuning.
 - The display shows the antenna SWR.
 - If the antenna cannot be tuned after 20 seconds, the tuning circuit is automatically bypassed.
 - After tuning is finished, the auto tune automatically stops transmitting.
 - If necessary, push [**X**] to manually stop transmitting.
 - Push [**Through**](***) to turn OFF the antenna tuner.



- ⑥ After tuning is finished, push [**TUNE**](9) again to return to the normal operating screen.
- ⑦ To transmit on the channel, hold down [**PTT**] on the microphone, and speak at a normal voice level.
 - The RF meter shows the output power.
- ⑧ Release [**PTT**] to receive.

■ Functions for transmit

◇ Transmit power selection

The transceiver has three output power levels, HIGH, MID and LOW. High power provides longer distance communications and low power reduces power consumption.

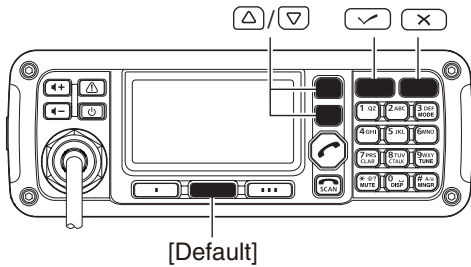

- ① Push [**X**] to enter the Main Menu screen.
- ② Select the “RF Power” item of “Setmode.”
 - ① Push [**△**] or [**▽**] to select the item, and then push [**✓**] to open the screen. (Setmode > Config)
 - ② Push [**△**] or [**▽**] to select “RF power,” and then hold down [**✓**] for 1 second.
- ③ Push [**△**] or [**▽**] to select the desired option, LOW, MID or HIGH.
 - If desired, hold down [**Default**](******) for 1 second to return to the default setting.

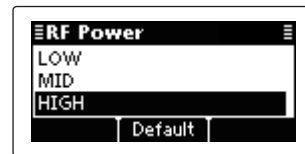

- ④ Push [**✓**] to save the setting, and return to the previous screen.
- ⑤ Push [**X**] one or more times to exit.

◇ Setting Microphone gain

The microphone gain must be properly adjusted so that your signal is not distorted when transmitted.

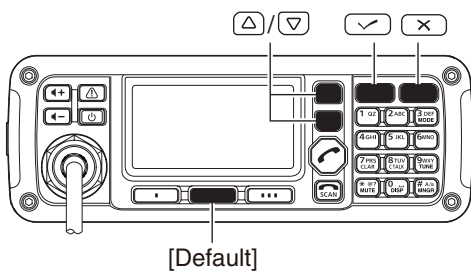

- ① Push [**X**] to enter the Main Menu screen.
- ② Select the “Mic Gain” item of “Setmode.”
 - ① Push [**△**] or [**▽**] to select the item, and then push [**✓**] to open the screen. (Setmode > Config)
 - ② Push [**△**] or [**▽**] to select “Mic Gain,” and then hold down [**✓**] for 1 second.
- ③ Push [**△**] or [**▽**] to adjust the desired setting level to between 0 and 10.
 - If desired, hold down [**Default**](******) for 1 second to return to the default setting.

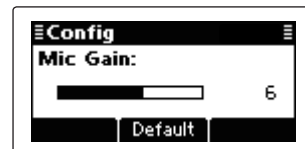

- ④ Push [**✓**] to save the setting, and return to the previous screen.
- ⑤ Push [**X**] one or more times to exit.

◇ Speech Processor

The IC-F8101 has a built-in, low distortion Speech Processor circuit. This circuit increases your average talk power in the SSB mode, and is especially useful when the receiving station is having difficulty hearing your audio.

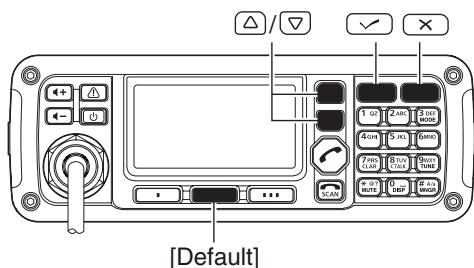

- ① Push [**X**] to enter the Main Menu screen.
- ② Select the "Speech Processor" item of "Setmode."
 - ① Push [**Δ**] or [**∇**] to select the item, and then push [**✓**] to open the screen. (Setmode > Config)
 - ② Push [**Δ**] or [**∇**] to select "Speech Processor," and then hold down [**✓**] for 1 second.
- ③ Push [**Δ**] or [**∇**] to turn ON the function.
 - If desired, hold down [**Default**](***) for 1 second to return to the default setting.

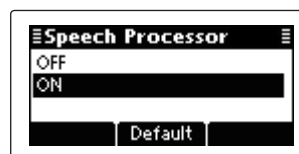

- ④ Push [**✓**] to save the setting, and return to the previous screen.
 - If desired, adjust the Speech Processor Level. See the next topic for details.
- ⑤ Push [**X**] one or more times to exit.
- ⑥ Push [**MODE**](3) one or more times to select the USB or LSB mode.
- ⑦ Hold down [**PTT**] on the microphone, and speak at a normal voice level.

◇ Speech Processor Level

The Speech Processor level must be properly adjusted so that your signal is not distorted when transmitted.

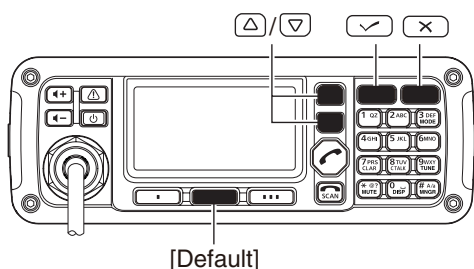

- ① Push [**X**] to enter the Main Menu screen.
- ② Select the "Speech Processor Level" item of "Setmode."
 - ① Push [**Δ**] or [**∇**] to select the item, and then push [**✓**] to open the screen. (Setmode > Config)
 - ② Push [**Δ**] or [**∇**] to select "Speech Processor Level" and then hold down [**✓**] for 1 second.
- ③ Push [**Δ**] or [**∇**] to adjust the desired level to between 0 and 10.
 - If desired, hold down [**Default**](***) for 1 second to return to the default setting.

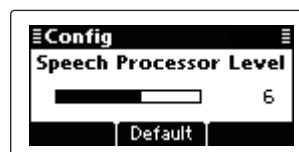

- ④ Push [**✓**] to save the setting, and return to the previous screen.
- ⑤ Push [**X**] one or more times to exit.

■ Functions for receive

◇ Clarifier function

The Clarifier function compensates for off-frequency stations. The function shifts the receive frequency up to ± 200 Hz in 10 Hz steps, without shifting the transmit frequency.

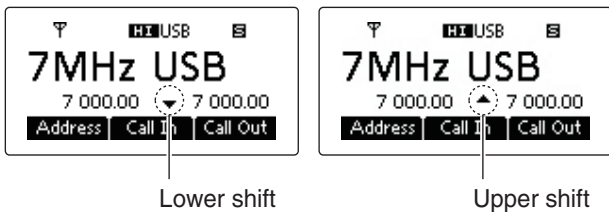
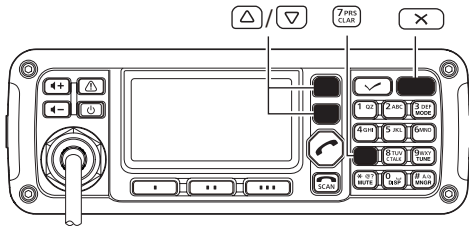

- ① Push **[CLAR]**(7) to open the Clarifier adjustment window.



- ② Push **[Δ]** or **[▽]** to adjust the frequency shift.
 - The transmit frequency is not shifted.
- ③ Push **[CLAR]**(7) to save the setting, and return to the previous screen.
 - If desired, push **[X]** to cancel the setting and exit the window.

When cancelling the Clarifier function, set the frequency shift to 0 Hz in the Clarifier adjustment window.

◇ Preamp and Attenuator

The preamp amplifies received signals in the front end circuit to improve the S/N ratio and sensitivity. Turn ON this function to better receive weak signals.

The attenuator prevents strong undesired signals near the desired frequency or near your location, such as from a broadcast station, from causing distortion or spurious signals.

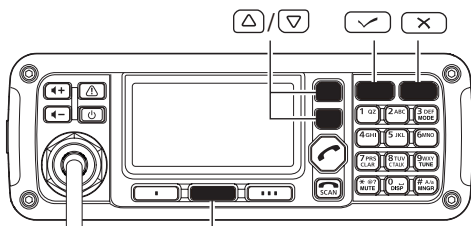

[Default]

- ① Push **[X]** to enter the Main Menu screen.
- ② Select the “Pre Amp” item of “Setmode.”
 - ① Push **[Δ]** or **[▽]** to select the item, and then push **[✓]** to open the screen. (Setmode > Config)
 - ② Push **[Δ]** or **[▽]** to select “Pre Amp,” and then hold down **[✓]** for 1 second.
- ③ Push **[Δ]** or **[▽]** to select the desired option, ON, OFF or ATT ON.
 - If desired, hold down **[Default]**(***) for 1 second to return to the default setting.

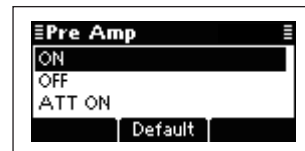

- ④ Push **[✓]** to save the setting, and return to the previous screen.
- ⑤ Push **[X]** one or more times to exit.

◇ **Noise Blanker**

The noise blanker reduces pulse-type noise such as that generated by automobile ignition systems.

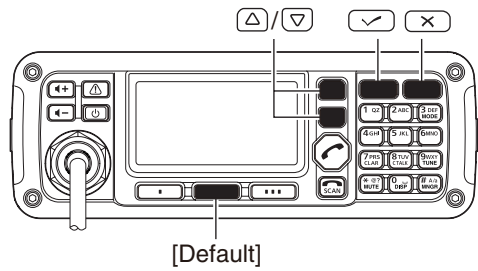

When using the Noise Blanker function, received signals may be distorted if they are excessively strong, or when used on noise other than pulses. In this case, set the Noise Blanker threshold level to a shallow position, or turn OFF the function. (See next topic.)

- ① Push [**X**] to enter the Main Menu screen.
- ② Select the “Noise Blanker” item of “Setmode.”
 - ① Push [**Δ**] or [**∇**] to select the item, and then push [**✓**] to open the screen. (Setmode > Config)
 - ② Push [**Δ**] or [**∇**] to select “Noise Blanker,” and then hold down [**✓**] for 1 second.
- ③ Push [**Δ**] or [**∇**] to turn ON the function.
 - If desired, hold down [**Default**](***) for 1 second to return to the default setting.

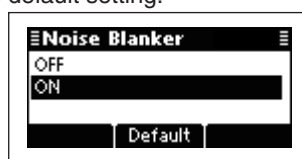

- ④ Push [**✓**] to save the setting, and return to the previous screen.
 - If desired, adjust the Noise Blanker Level or Noise Blanker Depth. See the next topic for details.
- ⑤ Push [**X**] one or more times to exit.

3

◇ **Noise Blanker adjustment**

To deal with various types of noise, the threshold level and attenuation level can be set by the “Noise Blanker Level” and “Noise Blanker Depth” items.

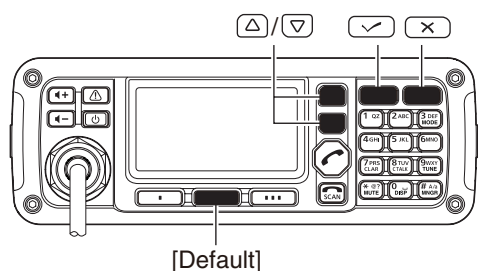

- ① Push [**X**] to enter the Main Menu screen.
- ② Select the “Noise Blanker Level” or “Noise Blanker Depth” item of “Setmode.”
 - ① Push [**Δ**] or [**∇**] to select the item, and then push [**✓**] to open the screen. (Setmode > Config)
 - ② Push [**Δ**] or [**∇**] to select “Noise Blanker Level” or “Noise Blanker Depth,” and then hold down [**✓**] for 1 second.
- ③ Push [**Δ**] or [**∇**] to adjust to the desired level.
 - If desired, hold down [**Default**](***) for 1 second to return to the default setting.
 - **Noise Blanker Level:** Between 0 and 15.
 - **Noise Blanker Depth:** Between 0 and 9.



- ④ Push [**✓**] to save the setting, and return to the previous screen.
- ⑤ Push [**X**] one or more times to exit.

■ Functions for receive (Continued)

◇ **AGC function**

The AGC (automatic gain control) controls receiver gain to produce a constant audio output level, even when the received signal strength varies by fading, and so on.

The transceiver has two AGC characteristics; AUTO and time constants FAST and SLOW.

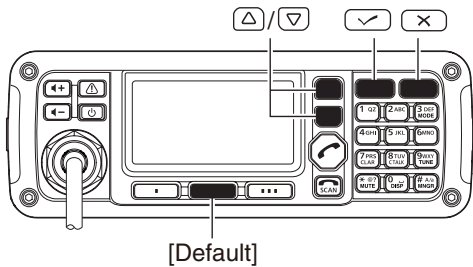

- ① Push [**X**] to enter the Main Menu screen.
- ② Select the “AGC” item of “Setmode.”
 - ① Push [**△**] or [**▽**] to select the item, and then push [**✓**] to open the screen. (Setmode > Config)
 - ② Push [**△**] or [**▽**] to select “AGC,” and then hold down [**✓**] for 1 second.
- ③ Push [**△**] or [**▽**] to select the desired option, FAST, SLOW or AUTO.
 - If desired, hold down [**Default**](***) for 1 second to return to the default setting.

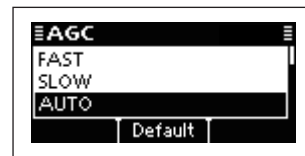

When AUTO is selected, the AGC time constant varies, depending on the operating mode.

- ④ Push [**✓**] to save the setting, and return to the previous screen.
- ⑤ Push [**X**] one or more times to exit.

◇ **AGC OFF function**

When receiving weak signals with adjacent strong signals or noise, the AGC function may reduce the sensitivity. In this situation, the AGC function should be turned OFF.

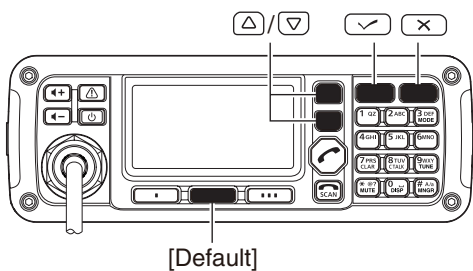

- ① Push [**X**] to enter the Main Menu screen.
- ② Select the “AGC” item of “Setmode.”
 - ① Push [**△**] or [**▽**] to select the item, and then push [**✓**] to open the screen. (Setmode > Config)
 - ② Push [**△**] or [**▽**] to select “AGC,” and then hold down [**✓**] for 1 second.
- ③ Push [**△**] or [**▽**] to turn OFF the function.
 - If desired, hold down [**Default**](***) for 1 second to return to the default setting.

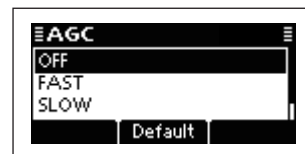

- ④ Push [**✓**] to save the setting, and return to the previous screen.
- ⑤ Push [**X**] one or more times to exit.

◇ Clear Talk function

The Clear Talk function uses the DSP circuit to enhance desired signals in the presence of noise.

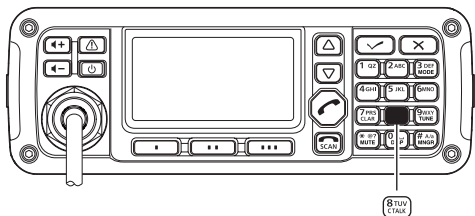

Clear Talk function OFF

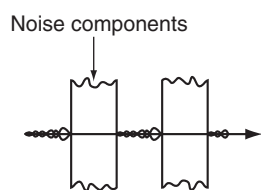

Clear Talk function ON

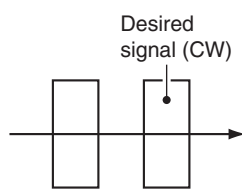

- ➔ Push **[C TALK]**(8) to turn ON the Clear Talk function.
 - “**C**” appears when the Clear Talk function is ON.

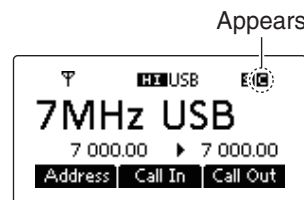

- If desired, adjust the Clear Talk level. See the next topic for details.
- If desired, push **[C TALK]**(8) again to turn OFF the function.

◇ Clear Talk Level

The Clear Talk Level must be adjusted for maximum readability. Setting the “Clear Talk Level” too high results in audio signal masking or distortion.

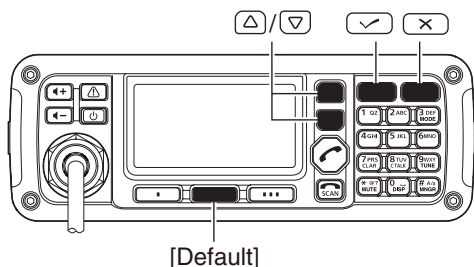

- ① Push **[X]** to enter the Main Menu screen.
- ② Select the “Clear Talk Level” item of “Setmode.”
 - ① Push **[Δ]** or **[∇]** to select the item, and then push **[✓]** to open the screen. (Setmode > Config)
 - ② Push **[Δ]** or **[∇]** to select “Clear Talk Level” and then hold down **[✓]** for 1 second.
- ③ Push **[Δ]** or **[∇]** to adjust the desired level to be between 1 and 15.
 - If desired, hold down **[Default]**(**) for 1 second to return to the default setting.



- ④ Push **[✓]** to save the setting, and return to the previous screen.
- ⑤ Push **[X]** one or more times to exit.

■ Selcall or ALE

Selcall uses a 4 or 6-digit ID address and allows you to make individual or group calls. The ALE (automatic link establishment) is a system which automatically selects an available frequency and establishes a communication link. The IC-F8101 ALE system complies with basic requirements of FED-STD-1045A.

◇ Available calls

• Selective call

Selective call allows you to make individual or group calls using an individual ID (identification) assigned to each transceiver.

• Phone call

Allows you to make a Phone call through a telephone interconnect service provider.

• Message call

Allows you to exchange text messages of up to 64 characters* with the intended ID station.

* Icom Selcall: 64 characters (upper case/Lower case letters)

Open Selcall: 32 characters (Only upper case letter)

• Send Position call

Allows you to send your own position information to the intended ID station.

• Get Position call

The Get Position call allows you to request the intended ID station to send its position information.

• Get Status call (Only Icom Selcall)

Requests to send radio status information including power supply voltage, signal strength, output power, VSWR, and so on.

• Stun call (Only Open Selcall)

The Stun call disables the specified station from either transmitting and receiving.

• RFDS emergency call (Only Australian versions)

The RFDS (Royal Flying Doctor Service) emergency call uses a 2-Tone signal for an emergency call.

• Emergency call

Allows you to send an emergency signal with your own position information.

• The Icom Selcall uses Icom original commands, and may not be compatible with other brands.

• Depending on the preprogramming, you can select the Open Selcall*.

* The Open Selcall is compatible with other transceiver brands. Ask your dealer for details.

• Channel Test call

The Channel Test call allows the user to determine the signal quality between their transceiver and a specific transceiver, before making individual or group calls.

• ALE individual or net call

Automatically establishes a communication link by using the ALE table.

• ALE sounding

Automatically sends a sounding signal at a selectable interval (0.5–11 hours) to check the propagation, and stores the data in a table. Manual soundings can also be sent.

• ALE AMD (Automatic Message Display)

Automatically sends and receives text messages of up to 90 characters.

◇ Selective call

The Selcall function allows you to make individual or group calls. Each transceiver is assigned an individual ID (identification) and can be called using this ID.

• Preparation for a Selective call

Send a Channel Test call on several Selcall channels, and check the propagation on each one to select the channel with the best signal quality. (p. 26)

• Sending a Selective call

- ① Hold down [**↵**] for 1 second to enter the Network selection screen.
- ② Push [**△**] or [**▽**] to select the desired Network, and then push [**↵**].
 - The Networks that belong to the Icom Selcall or Open Selcall systems must be selected.

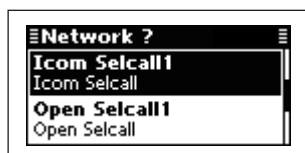

- ③ Push [**△**] or [**▽**] to select the Call Type to “Selective.”
 - “Selective,” “Phone,” “Message,” “Send Position,” “Get Position,” “Get Status,” “Emergency,” “Channel Test” and “Stun” are selectable.
 - ▨ The Get Status call is selectable in the Icom Selcall, and the Stun call is selectable in the Open Selcall.

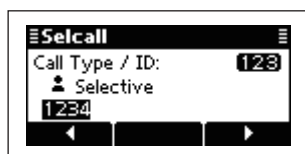

- ④ Push keypad to enter the Call ID, and then push [**↵**].
 - The previously entered Call ID is displayed.
 - Push [**◀**](*) or [**▶**](***) to move the cursor.
 - Push [**✕**] to delete the digit to the left of the cursor.
 - This Call ID is not stored in the Call ID list.
- ⑤ Push [**△**] or [**▽**] to select the Profile, then push [**↵**].

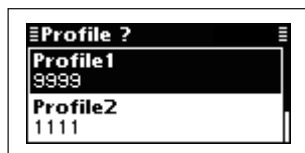

- ⑥ Push [**△**] or [**▽**] to select the Channel.
 - Only the channels that belong to the selected Network in step ②, are displayed.
 - If desired, push [**Tests**](**) to transmit the Channel Test call in this step.



- ⑦ Push [**↵**] to transmit the Selective call. The call is stored in the Call Out memory.
 - While calling, push [**PTT**] to cancel the call.

▨ You can also make a Selective call when the Address screen is displayed. In this case, you can skip several steps, see page 29 for the Simple Selcall operation details.

• Receiving Selective calls

When your transceiver receives a Selective call with your individual ID, it automatically responds by transmitting. The received Selcall is stored in the Call In memory.

- ① Push [**✕**] to enter the Main Menu screen.
- ② Push [**△**] or [**▽**] to select “Call In,” and then push [**↵**].

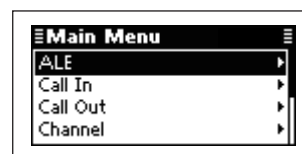

- ③ Push [**△**] or [**▽**] to select the desired Call, and then push [**↵**].



- ④ Push [**△**] or [**▽**] to select the information.

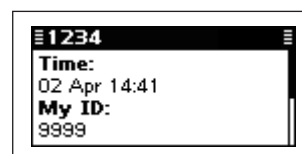

- ⑤ Push [**✕**] twice to return to the normal operating screen.

◇ Phone call

Allows you to make Phone calls through a telephone interconnect service provider.

• Preparation for a Phone call

Send a Channel Test call on several Phone call channels, and check the propagation on each one to select the channel with the best signal quality. (p. 26)

• Sending a Phone call

- ① Hold down [↵] for 1 second to enter the Network selection screen.
- ② Push [△] or [▽] to select the desired Network, and then push [↵].
 - The Networks that belong to the Icom Selcall or Open Selcall systems must be selected.

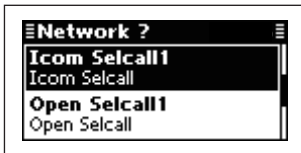

- ③ Push [△] or [▽] to select the Call Type to "Phone."
 - "Selective," "Phone," "Message," "Send Position," "Get Position," "Get Status," "Emergency," "Channel Test" and "Stun" are selectable.
 - ▨ The Get Status call is selectable in the Icom Selcall, and the Stun call is selectable in the Open Selcall.

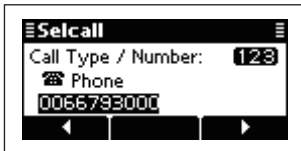

- ④ Push keypad to enter the Number, and then push [↵].
 - The previously entered Number is displayed.
 - Push [←](*) or [→](***) to move the cursor.
 - Push [X] to delete the digit to the left of the cursor.
 - This Number is not stored in the Number list.
- ⑤ Push keypad to enter the Phone Link ID, and then push [↵].
 - The previously entered Link ID is displayed.
 - Push [←](*) or [→](***) to move the cursor.
 - Push [X] to delete the digit to the left of the cursor.
 - This ID is not stored in the Phone Link ID list.

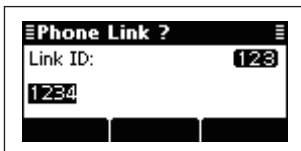

- ⑥ Push [△] or [▽] to select the Profile, then push [↵].

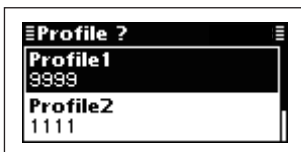

- ⑦ Push [△] or [▽] to select the Channel.
 - Only the channels that belong to the selected Network in step ②, are displayed.
 - If desired, push [Tests](**) to transmit the Channel Test call in this step.

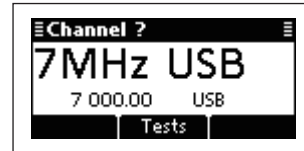

- ⑧ Push [↵] to transmit the Phone call. The call is stored in the Call Out memory.
 - While calling, push [PTT] to cancel the call.

▨ You can also make a Phone call when the Address screen is displayed. In this case, you can skip several steps, see page 29 for the Simple Selcall operation details.

• After a Phone call

- ① When a Phone call is finished, push [SCAN] to transmit the disconnect call.
 - Until the Disconnect call is transmitted, the telephone interconnect service provider continues counting the time for toll charging.
 - If the "Auto Start Type" item of "Setmode" is set to "Scan" or "Termination," the Call automatically disconnects after the Auto Start Wait Time period has past with no operation. (Setmode > Call)

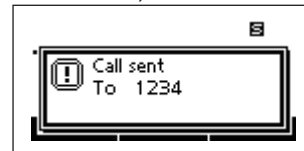

◇ Message call

The Message call allows you to exchange text messages of up to 64 characters,* with the intended ID station, and also leave a message at the station.

* Icom Selcall: 64 characters

(upper case/Lower case letters)

Open Selcall: 32 characters (Only upper case letter)

• Preparation for a Message call

Send a Channel Test call on several Selcall channels, and check the propagation on each one to select the channel with the best signal quality. (p. 26)

• Sending a Message call

① Hold down [↻] for 1 second to enter the Network selection screen.

② Push [△] or [▽] to select the desired Network, and then push [↻].

- The Networks that belong to the Icom Selcall or Open Selcall systems must be selected.

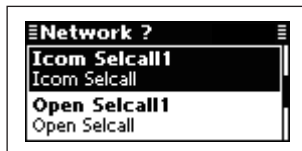

③ Push [△] or [▽] to select the Call Type to “Message.”

- “Selective,” “Phone,” “Message,” “Send Position,” “Get Position,” “Get Status,” “Emergency,” “Channel Test” and “Stun” are selectable.

▨ The Get Status call is selectable in the Icom Selcall, and the Stun call is selectable in the Open Selcall.

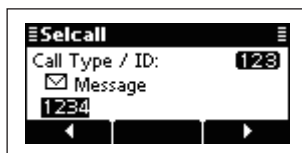

④ Push keypad to enter the Call ID, and then push [↻].

- The previously entered Call ID is displayed.
- Push [◀] or [▶] to move the cursor.
- Push [X] to delete the digit to the left of the cursor.
- This Call ID is not stored in the Call ID list.

⑤ Select the desired Message or edit New message.

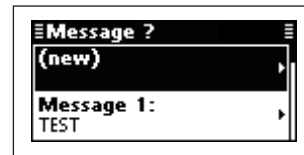

○ Message selection

➔ Push [△] or [▽] select the Message, and then push [↻].

○ New Message input

① Hold down [✓] to enter the input mode.

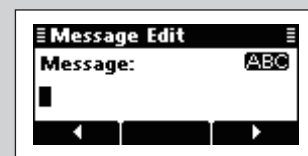

② Push keypad to enter the Message.

- Push [A/a](#) to toggle between the Upper, Lower case letter input modes and Number input mode.
- Push [X] to delete the character, symbol or number to the left of the cursor.
- Push [◀] or [▶] to move the cursor.

③ Push [✓] to save the Message.

- This Message is not stored in the Message list.

⑥ Push [△] or [▽] to select the Profile, then push [↻].



⑦ Push [△] or [▽] to select the Channel.

- Only the channels that belong to the selected Network in step ②, are displayed.
- If desired, push [Tests](**) to transmit the Channel Test call in this step.

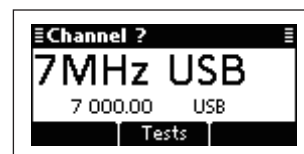

⑧ Push [↻] to transmit the Message call. The call is stored in the Call Out memory.

- While calling, push [PTT] to cancel the call.

▨ You can also make a Message call when the Address screen is displayed. In this case, you can skip several steps, see page 29 for the Simple Selcall operation details.

◆ **Send Position call**

The Send Position call allows you to send your own position and time information to the intended ID station.

• **Preparation for a Send Position call**

Send a Channel Test call on several Selcall channels, and check the propagation on each one to select the channel with the best signal quality. (p. 26)

• **Sending a Send Position call**

- ① Hold down [↵] for 1 second to enter the Network selection screen.
- ② Push [△] or [▽] to select the desired Network, and then push [↵].
 - The Networks that belong to the Icom Selcall or Open Selcall systems must be selected.

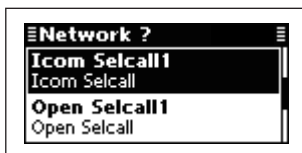

- ③ Push [△] or [▽] to select the Call Type to “Send Position.”
 - “Selective,” “Phone,” “Message,” “Send Position,” “Get Position,” “Get Status,” “Emergency,” “Channel Test” and “Stun” are selectable.
 - ▨ The Get Status call is selectable in the Icom Selcall, and the Stun call is selectable in the Open Selcall.

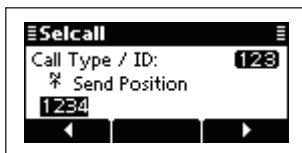

- ④ Push keypad to enter the Call ID, and then push [↵].
 - The previously entered Call ID is displayed.
 - Push [◀] or [▶] to move the cursor.
 - Push [X] to delete the digit to the left of the cursor.
 - This Call ID is not stored in the Call ID list.
- ⑤ Push [△] or [▽] to select the Profile, then push [↵].

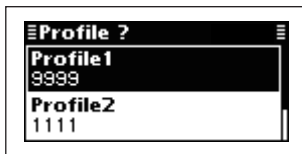

- ⑥ Push [△] or [▽] to select the Channel.
 - Only the channels that belong to the selected Network in step ②, are displayed.
 - If desired, push [Tests] to transmit the Channel Test call in this step.



- ⑦ Push [↵] to transmit the Send Position call. The call is stored in the Call Out memory.
 - While calling, push [PTT] to cancel the call.

▨ You can also make a Send Position call when the Address screen is displayed. In this case, you can skip several steps, see page 29 for the Simple Selcall operation details.

• **Receiving Send Position calls**

When your transceiver receives a Send Position call with your individual ID, it automatically responds by transmitting. The received Selcall is stored in the Call In memory.

- ① Push [X] to enter the Main Menu screen.
- ② Push [△] or [▽] to select “Call In,” and then push [↵].

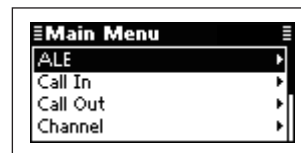

- ③ Push [△] or [▽] to select the desired Call, and then push [↵].

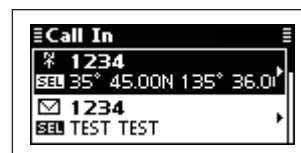

- ④ Push [△] or [▽] to select the information.

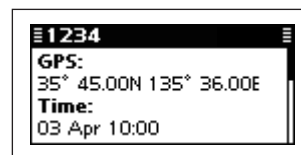

- ⑤ Push [X] twice to return to the normal operating screen.

◇ Get Position call

The Get Position call allows you to request an intended ID station to send its position information.

• Preparation for a Get Position call

Send a Channel Test call on several Selcall channels, and check the propagation on each one to select the channel with the best signal quality. (p. 26)

• Sending a Get Position call

- ① Hold down [↵] for 1 second to enter the Network selection screen.
- ② Push [△] or [▽] to select the desired Network, and then push [↵].
 - The Networks that belong to the Icom Selcall or Open Selcall systems must be selected.

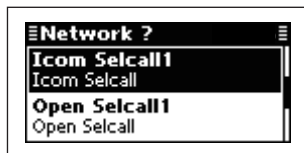

- ③ Push [△] or [▽] to select the Call Type to “Get Position.”
 - “Selective,” “Phone,” “Message,” “Send Position,” “Get Position,” “Get Status,” “Emergency,” “Channel Test” and “Stun” are selectable.
 - ▨ The Get Status call is selectable in the Icom Selcall, and the Stun call is selectable in the Open Selcall.

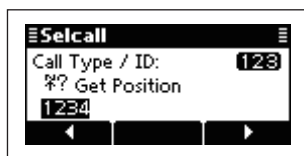

- ④ Push keypad to enter the Call ID, and then push [↵].
 - The previously entered Call ID is displayed.
 - Push [◀](*) or [▶](***) to move the cursor.
 - Push [X] to delete the digit to the left of the cursor.
 - This Call ID is not stored in the Call ID list.
- ⑤ Push [△] or [▽] to select the Profile, then push [↵].

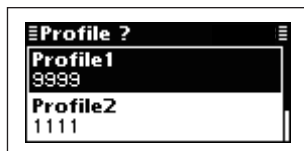

- ⑥ Push [△] or [▽] to select the Channel.
 - Only the channels that belong to the selected Network in step ②, are displayed.
 - If desired, push [Tests](**) to transmit the Channel Test call in this step.



- ⑦ Push [↵] to transmit the Send Position call. The call is stored in the Call Out memory.
 - While calling, push [PTT] to cancel the call.

▨ You can also make a Get Position call when the Address screen is displayed. In this case, you can skip several steps, see page 29 for the Simple Selcall operation details.

• Receiving a Get Position call acknowledgement

- ① After the call is transmitted, your called station sends position and time information as an acknowledgement.



- ② Push any key to return to the normal operating screen.
- ③ Push [X] to enter the Main Menu screen.
- ④ Push [△] or [▽] to select “Call In,” and then push [↵].

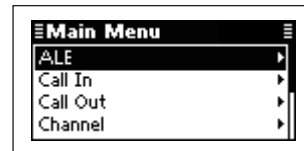

- ⑤ Push [△] or [▽] to select the desired Call, and then push [↵].

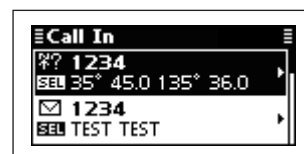

- ⑥ Push [△] or [▽] to select the information.

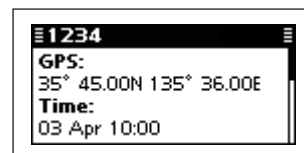

- ⑦ Push [X] twice to return to the normal operating screen.

• Receiving a Get Position call

When your transceiver receives a Get Position call that includes your individual ID, it automatically responds by transmitting.

◇ **Get Status call (Only Icom Selcall)**

The Get Status call requests sending radio status information including power supply voltage, signal strength, output power, VSWR, and so on.

• **Preparation for a Get Status call**

Send a Channel Test call on several Selcall channels, and check the propagation on each one to select the channel with the best signal quality. (p. 26)

• **Sending a Get Status call**

- ① Hold down [↵] for 1 second to enter the Network selection screen.
- ② Push [△] or [▽] to select the desired Network, and then push [↵].
 - The Networks that belong to the Icom Selcall or Open Selcall systems must be selected.

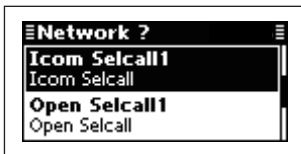

- ③ Push [△] or [▽] to select the Call Type to “Get Status.”
 - “Selective,” “Phone,” “Message,” “Send Position,” “Get Position,” “Get Status,” “Emergency,” “Channel Test” and “Stun” are selectable.
 - ▨ The Get Status call is selectable in the Icom Selcall, and the Stun call is selectable in the Open Selcall.

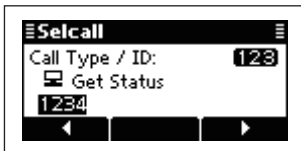

- ④ Push keypad to enter the Call ID, and then push [↵].
 - The previously entered Call ID is displayed.
 - Push [◀](*) or [▶](***) to move the cursor.
 - Push [X] to delete the digit to the left of the cursor.
 - This Call ID is not stored in the Call ID list.
- ⑤ Push [△] or [▽] to select the Profile, then push [↵].

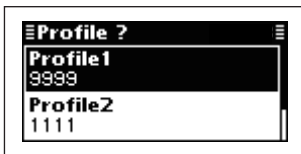

- ⑥ Push [△] or [▽] to select the Channel.
 - Only the channels that belong to the selected Network in step ②, are displayed.
 - If desired, push [Tests](**) to transmit the Channel Test call in this step.



- ⑦ Push [↵] to transmit the Send Position call. The call is stored in the Call Out memory.
 - While calling, push [PTT] to cancel the call.

▨ You can also make a Get Status call when the Address screen is displayed. In this case, you can skip several steps, see page 29 for the Simple Selcall operation details.

• **Receiving a Get Status call acknowledgement**

- ① After the call is transmitted, your called station sends status information as an acknowledgement.

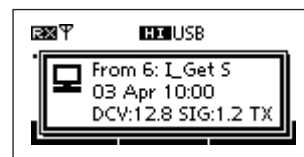

- ② Push any key to return to the normal operating screen.
- ③ Push [X] to enter the Main Menu screen.
- ④ Push [△] or [▽] to select “Call In,” and then push [↵].

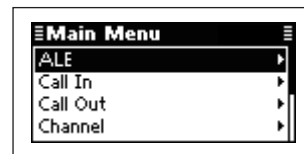

- ⑤ Push [△] or [▽] to select the desired Call, and then push [↵].

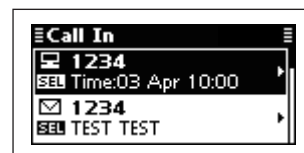

- ⑥ Push [△] or [▽] to select the information.
 - Status information includes the power supply voltage, Signal strength, Transmit power, VSWR, Time, Self ID, Network and Channel/Mode.

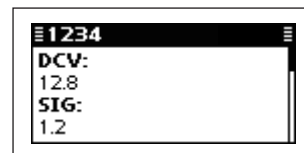

- ⑦ Push [X] twice to return to the normal operating screen.

• **Receiving a Get Status call**

When your transceiver receives a Get Status call that includes your individual ID, it automatically responds by transmitting.

◇ Emergency call

The Emergency call allows you to broadcast an emergency signal with your own position information.

• Sending an Emergency call

- ① Hold down [↵] for 1 second to enter the Network selection screen.
- ② Push [△] or [▽] to select the desired Network, and then push [↵].
 - The Networks that belong to the Icom Selcall or Open Selcall systems must be selected.

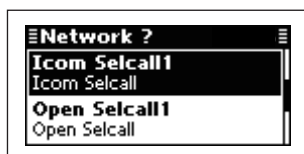

- ③ Push [△] or [▽] to select the Call Type to “Emergency.”
 - “Selective,” “Phone,” “Message,” “Send Position,” “Get Position,” “Get Status,” “Emergency,” “Channel Test” and “Stun” are selectable.
 - ▨ The Get Status call is selectable in the Icom Selcall, and the Stun call is selectable in the Open Selcall.

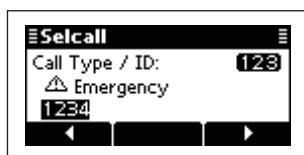

- ④ Push keypad to enter the Call ID, and then push [↵].
 - The previously entered Call ID is displayed.
 - Push [◀](*) or [▶](***) to move the cursor.
 - Push [X] to delete the digit to the left of the cursor.
 - This Call ID is not stored in the Call ID list.
- ⑤ Push [△] or [▽] to select the Profile, then push [↵].

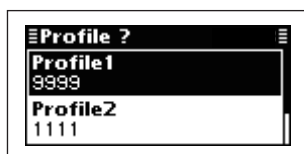

- ⑥ Push [△] or [▽] to select the Channel.
 - Only the channels that belong to the selected Network in step ②, are displayed.
 - If desired, push [Tests](**) to transmit the Channel Test call in this step.



- ⑦ Push [↵] to transmit the Emergency call. The call is stored in the Call Out memory.
 - While calling, push [PTT] to cancel the call.

▨ You can also make an Emergency call when the Address screen is displayed. In this case, you can skip several steps, see page 29 for the Simple Selcall operation details.

• Receiving Emergency calls

When your transceiver receives an Emergency call with your individual ID, it automatically responds by transmitting. The received Selcall is stored in the Call In memory.

- ① After an Emergency call is received, transceiver displays the station's position and its time.

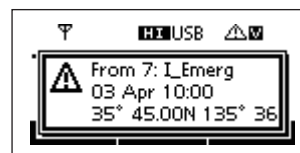

- ② Push any key to return to the normal operating screen.
- ③ Push [X] to enter the Main Menu screen.
- ④ Push [△] or [▽] to select “Call In,” and then push [✓].

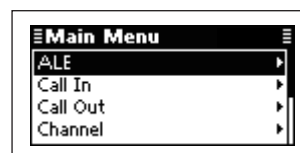

- ⑤ Push [△] or [▽] to select the desired Call, and then push [✓].

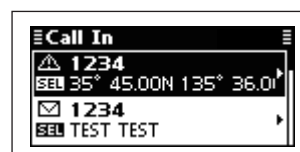

- ⑥ Push [△] or [▽] to select the information.

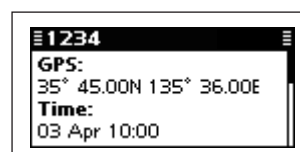

- ⑦ Push [X] twice to return to the normal operating screen.

◇ Channel Test call

The Channel Test call allows the user determine the signal quality between your transceiver and a specific transceiver before an individual or group call. The Channel Test call is also used for checking the channel before sending any other calls.

• Sending a Channel Test call

- ① Hold down [↵] for 1 second to enter the Network selection screen.
- ② Push [▲] or [▼] to select the desired Network, and then push [↵].
 - The Networks that belong to the Icom Selcall or Open Selcall systems must be selected.

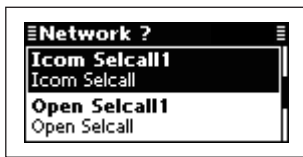

- ③ Push [▲] or [▼] to select the Call Type to “Channel Test.”
 - “Selective,” “Phone,” “Message,” “Send Position,” “Get Position,” “Get Status,” “Emergency,” “Channel Test” and “Stun” are selectable.
 - ▨ The Get Status call is selectable in the Icom Selcall, and the Stun call is selectable in the Open Selcall.

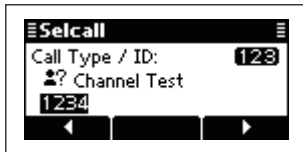

- ④ Push keypad to enter the Call ID, and then push [↵].
 - The previously entered Call ID is displayed.
 - Push [◀] or [▶] to move the cursor.
 - Push [✕] to delete the digit to the left of the cursor.
 - This Call ID is not stored in the Call ID list.

- ⑤ Push [▲] or [▼] to select the Profile, then push [↵].



- ⑥ Push [▲] or [▼] to select the Channel.
 - Only the channels that belong to the selected Network in step ②, are displayed.
 - If desired, push [Tests] to transmit the Channel Test call in this step.

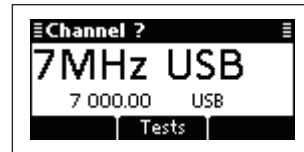

- ⑦ Push [↵] to transmit the Channel Test call. The call is stored in the Call Out memory.
 - While calling, push [PTT] to cancel the call.

▨ You can also make a Channel Test call when the Address screen is displayed. In this case, you can skip several steps, see page 29 for the Simple Selcall operation details.

◇ Stun call (Only Open Selcall)

The Stun call disables the specified station from either transmitting and receiving.

• Sending a Stun call

- ① Hold down [↵] for 1 second to enter the Network selection screen.
- ② Push [△] or [▽] to select the desired Network, and then push [↵].
 - The Networks that belong to the Open Selcall system must be selected.

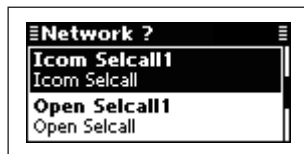

- ③ Push [△] or [▽] to select the Call Type to "Stun."
 - "Selective," "Phone," "Message," "Send Position," "Get Position," "Get Status," "Emergency," "Channel Test" and "Stun" are selectable.
 - ▨ The Get Status call is selectable in the Icom Selcall, and the Stun call is selectable in the Open Selcall.

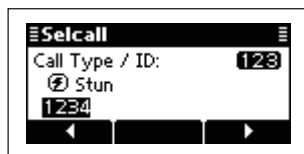

- ④ Push keypad to enter the Call ID, and then push [↵].
 - The previously entered Call ID is displayed.
 - Push [◀] or [▶] to move the cursor.
 - Push [✕] to delete the digit to the left of the cursor.
 - This Call ID is not stored in the Call ID list.
- ⑤ Push keypad to enter the specified station's PIN Code, and then push [↵].
 - Push [◀] or [▶] to move the cursor.
 - Push [✕] to delete the digit to the left of the cursor.

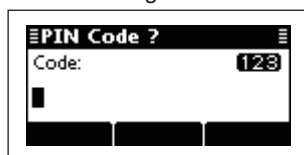

- ⑥ Push [△] or [▽] to select the Profile, then push [↵].



- ⑦ Push [△] or [▽] to select the Channel.
 - Only the channels that belong to the selected Network in step ②, are displayed.
 - If desired, push [Tests] to transmit the Channel Test call in this step.







- ⑧ Push [↵] to transmit the Stun call. The call is stored in the Call Out memory.
 - While calling, push [PTT] to cancel the call.



◇ **RFDS emergency call (only AUS versions)**

The RFDS (Royal Flying Doctor Service) emergency call uses a 2-Tone signal for an emergency call.

• **Sending an RFDS emergency call**

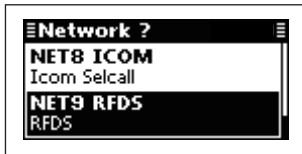
- ① Hold down [] for 1 second to enter the Network selection screen.
- ② Push [] or [] to select the desired Network, and then push [].
 - The Networks that belong to the RFDS systems must be selected.



- ③ Push [] or [] to select the Channel.
 - Only the channels that belong to the selected Network in step ②, are displayed.



- ④ Push [] to transmit the RFDS emergency call. The call is stored in the Call Out memory.
 - While calling, push [**PTT**] to cancel the call.

◇ Simple Selcall operation

The Simple Selcall mode is convenient to transmit the often used Selcalls.

- ① Push [] to enter the Simple Selcall mode.
 - Depending on the Entry, the contents are skipped.
 - ▨ Holding down [] enters the normal Selcall mode.
 - ▨ See pages 19 to 28 for the normal Selcall operation details.
- ② After setting is finished, push [△] or [▽] to select the Channel.
 - Only the channels that belong to the selected Network, are displayed.
 - If desired, push [Tests](***) to transmit the Channel Test call in this step.



- ③ Push [] to transmit the Call.
 - While calling, push [PTT] to cancel the call.

○ Depending on the Entry, following settings are required.

(✓ : Setting is required. — : The contents is skipped.)

Screen (Entry)	Call system/ Network	Call type/ Call ID	Phone Link*4	Message *5	Self ID *3	Channel *6	Note
Address Emergency Link	—*1	—*3	—	—	—	✓	The skipped contents are used from the preprogrammed setting.
Call In Call Out	—*1	—*3	—	—	—	✓	The skipped contents are used from the preprogrammed setting.
Phone Link	—*1	✓	✓	—	—	✓	The Call type is always set to Phone. The skipped contents are used from the preprogrammed setting.
Other screen	—*2	✓	✓	✓	—	✓	The skipped contents are used from the previously transmitted Calls.

*1 When the setting of the Entry is effective (Call is possible), the content is skipped.

*2 Priority Network is used.

*3 When the preprogrammed ID or previously used ID exists in the selected entry, the Call automatically selects the ID and skips the contents.

*4 Only Phone call.

*5 Only Message call.

*6 Only the channels that belong to the Network, are displayed.

◇ **ALE call**

Automatically establish a communication link by using the ALE table.

• **Sending an Individual call**

- ① Hold down [↵] for 1 second to enter the Network selection screen.
- ② Push [△] or [▽] to select the desired Network, and then push [↵].
 - The Networks that belong to the ALE system must be selected.

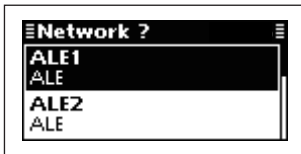

- ③ Push [△] or [▽] to select the Call Type to "Individual."
 - "Individual," "NET Call," "Sounding" and "AMD" are selectable.

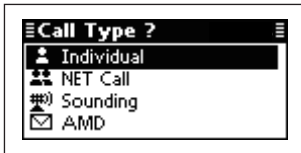

- ④ Push [△] or [▽] to select the Individual ID, and then push [↵].
 - Only the ID that belong to the selected Network in step ②, are displayed.

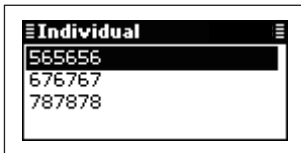

- ⑤ Push [△] or [▽] to select the Self ID, then push [↵].
 - Only the ID that belong to the selected Network in step ②, are displayed.

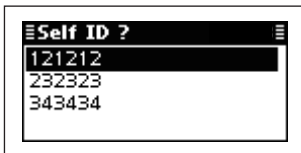

- ⑥ Push [△] or [▽] to select the Channel.
 - Only the channels that belong to the selected Network in step ②, are displayed.
 - If <Auto> is selected, the transceiver sequentially transmits channels that belong to the Network.

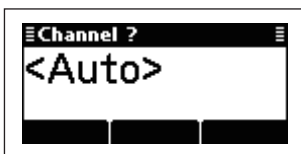

- ⑦ Push [↵] to transmit the Individual call. The call is stored in the Call Out memory.
 - While calling, push [PTT] to cancel the call.

• **After an ALE call**

- ➔ After an ALE call is finished, push [SCAN] to transmit the disconnect call.
 - If the "Auto Start Type" item of "Setmode" is set to "Scan" or "Termination," the Call automatically disconnects after the Auto Start Wait Time period has past with no operation. (Setmode > Call)

• **Sending a Net call**

- ① Hold down [↵] for 1 second to enter the Network selection screen.
- ② Push [△] or [▽] to select the desired Network, and then push [↵].
 - The Networks that belong to the ALE system must be selected.
- ③ Push [△] or [▽] to select the Call Type to "NET Call."
 - "Individual," "NET Call," "Sounding" and "AMD" are selectable.

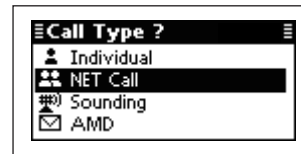

- ④ Push [△] or [▽] to select the NET ID, and then push [↵].
 - Only the ID that belong to the selected Network in step ②, are displayed.

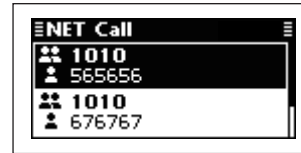

- ⑤ Push [△] or [▽] to select the Self ID, then push [↵].
 - Only the ID that belong to the selected Network in step ②, are displayed.

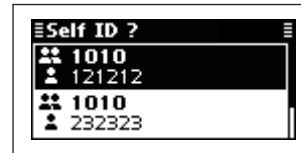

- ⑥ Push [△] or [▽] to select the Channel.
 - Only the channels that belong to the selected Network in step ②, are displayed.
 - If <Auto> is selected, the transceiver sequentially transmits channels that belong to the Network.

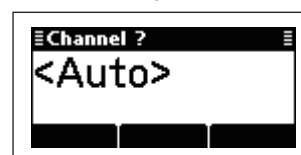

- ⑦ Push [↵] to transmit the NET Call. The call is stored in the Call Out memory.
 - While calling, push [PTT] to cancel the call.

◇ ALE Sounding

Automatically sends a sounding signal at certain intervals (0.5–11 hours) to check the propagation, and then stores the data in a table. Manual soundings can also be made.

• Manual sounding

- ① Hold down [↵] for 1 second to enter the Network selection screen.
- ② Push [△] or [▽] to select the desired Network, and then push [↵].
 - The Networks that belong to the ALE system must be selected.

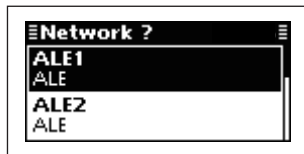

- ③ Push [△] or [▽] to select the Call Type to “Sounding.”
 - “Individual,” “NET Call,” “Sounding” and “AMD” are selectable.

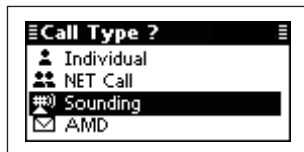

- ④ Push [△] or [▽] to select the Self ID, then push [↵].
 - Only the ID that belong to the selected Network in step ②, are displayed.

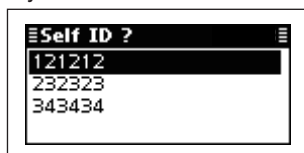

- ⑤ Push [△] or [▽] to select the Channel.
 - Only the channels that belong to the selected Network in step ②, are displayed.



- ⑥ Push [↵] to transmit the Sounding call.
 - While calling, push [PTT] to cancel the call.

◇ **ALE AMD call**

The ALE AMD (Automatic Message Display) sends and receives test messages of up to 90 characters.

• **Sending an AMD call**

- ① Hold down [↵] for 1 second to enter the Network selection screen.
- ② Push [△] or [▽] to select the desired Network, and then push [↵].
 - The Networks that belong to the ALE system must be selected.

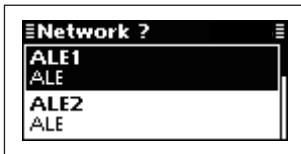

- ③ Push [△] or [▽] to select the Call Type to "AMD."
 - "Individual," "NET Call," "Sounding" and "AMD" are selectable.

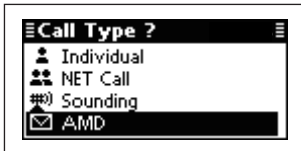

- ④ Push [△] or [▽] to select the Individual ID, and then push [↵].
 - Only the ID that belong to the selected Network in step ②, are displayed.

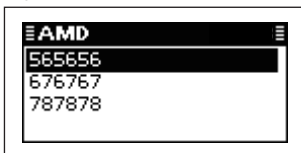

- ⑤ Push [△] or [▽] to select the Self ID, then push [↵].
 - Only the ID that belong to the selected Network in step ②, are displayed.

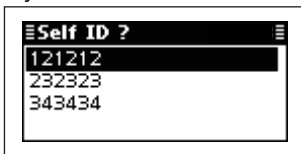

- ⑥ Select the desired Message or edit New message.



○ **Message selection**

➔ Push [△] or [▽] select the Message, and then push [↵].

○ **New Message input**

- ① Hold down [✓] to enter the input mode.



- ② Push keypad to enter the Message.
 - Push [A/a](#) to toggle between the Upper case letter and Number input mode.
 - Push [X] to delete the character, symbol or number to the left of the cursor.
 - Push [◀](*) or [▶](***) to move the cursor.
- ③ Push [✓] to save the Message.
 - This Message is not stored in the Message list.

- ⑥ Push [△] or [▽] to select the Channel.
 - Only the channels that belong to the selected Network in step ②, are displayed.
 - If <Auto> is selected, the transceiver sequentially transmits channels that belong to the Network.

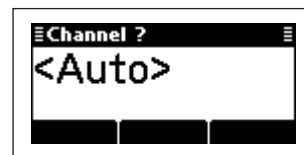

- ⑦ Push [↵] to transmit the Individual call. The call is stored in the Call Out memory.
 - While calling, push [PTT] to cancel the call.

• **After an ALE call**

- ➔ After an ALE call is finished, push [SCAN] to transmit the disconnect call.
- If the "Auto Start Type" item of "Setmode" is set to "Scan" or "Termination," the Call automatically disconnects after the Auto Start Wait Time period has past with no operation. (Setmode > Call)

■ Manager Menu

The Manager Menu is used for logging into the Administrator mode, setting the Access rights, programming memory channel, Selcall address and so on.

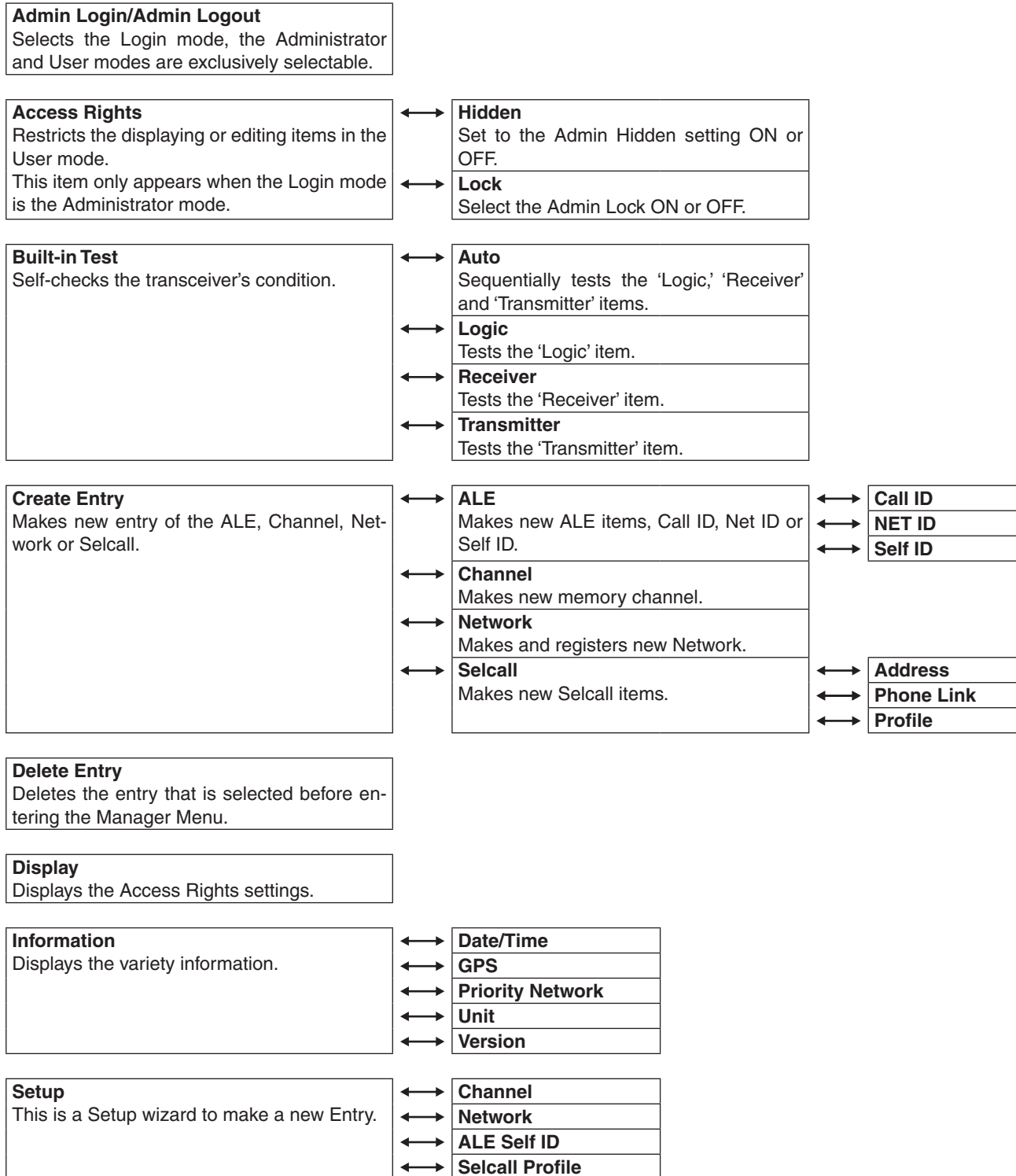

4
5

■ Manager Menu (Continued)

◇ Entering the Administrator mode

When first entering the Administrator mode, a login password may be required, depending on the preprogramming.

- ① Push [MNGR](#) to enter the Manager Menu screen.
 - “Admin Login” is automatically selected. If “Admin Login” is not selected, push [△] to select it.

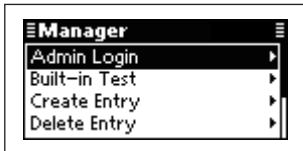

- ② Push [✓] to enter the Administrator mode.
 - Depending on the preprogramming, the “Admin Login” may appear, and then the password is requested.

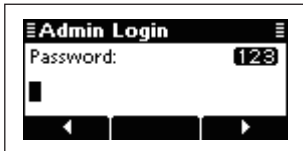

- ③ Push the keypad keys to enter the Administrator password, and then push [✓].
 - Repeatedly push [A/a](#) to select the character group, ABC (upper case letters), abc (lower case letters) or 123 (numbers).
 - Push [X] to delete a character.
 - Push [◀](▪) or [▶](•••) to move the cursor.

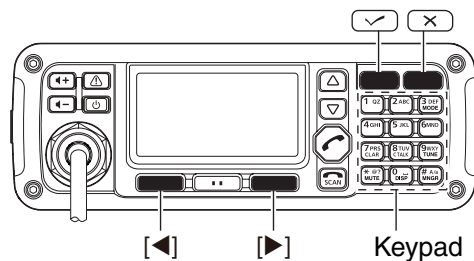
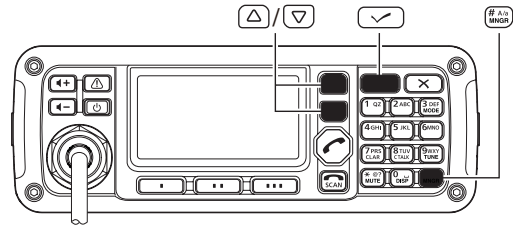

◇ Return to the User mode

- ① Push [MNGR](#) to enter the Manager Menu screen.
 - “Admin Logout” is automatically selected. If “Admin Logout” is not selected, push [△] to select it.

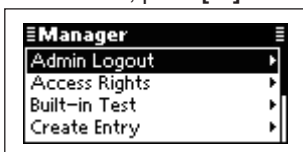

- ② Push [✓] to enter the User mode.
 - “Log out of Administrator” is displayed, and then the transceiver returns to the User mode.

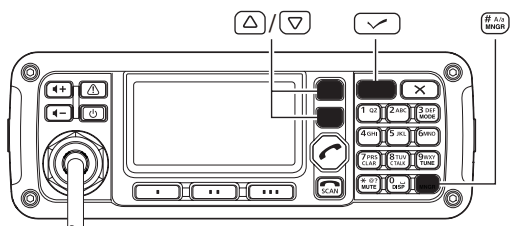

◇ Setting the Access Rights

You can restrict the editing or displaying of a memory channel, Selcall address or any other settings in the User mode.

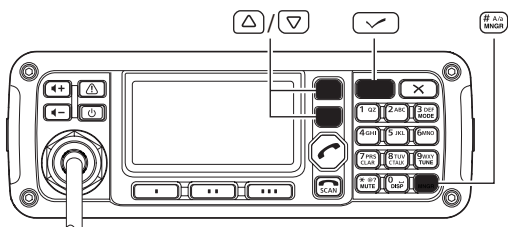

- ① Select a memory channel, Selcall address or other setting.
- ② Push **[MNGR](#)** to enter the Manager Menu screen.
 - “Admin Logout” is automatically selected.

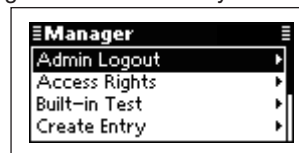

- ③ Push **[Δ]** or **[▽]** to select “Access Rights,” and then push **[✓]**.
- ④ Push **[Δ]** or **[▽]** to select the item, and then hold down **[✓]** for 1 second.

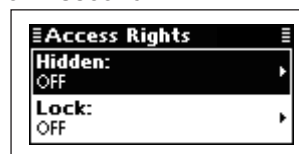

- ⑤ Push **[Δ]** or **[▽]** to select “ON,” and then push **[✓]**.
 - Hidden: Undisplayed in the Use mode.
 - Lock: Locked and editing is restricted in the User mode.
- The setting is effective after the transceiver returns to the User mode.

◇ Setting the Access Rights View

You can confirm the restriction of the memory channel, Selcall address or any other settings.

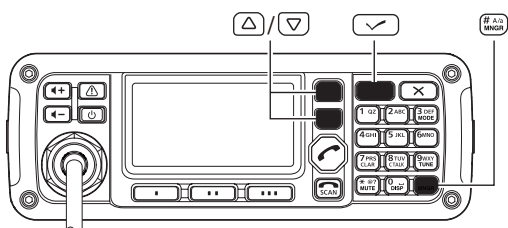

(Display example)



- : Appears when the “Hidden” setting is ON.
- : Appears when the “Lock” setting is ON.
- : Appears when the Factory Lock setting is ON.

This setting cannot be changed in either the Administrator or User mode.

- ① Push **[MNGR](#)** to enter the Manager Menu screen.
 - “Admin Logout” is automatically selected.

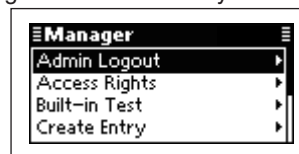

- ② Push **[Δ]** or **[▽]** to select “Display,” and then push **[✓]**.
- ③ Hold down **[✓]** for 1 second.

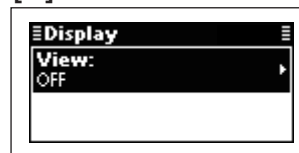

- ④ Push **[Δ]** or **[▽]** to select “ON,” and then push **[✓]**.
- ⑤ Select the desired memory channel, Selcall address or setting that you want to check in the “Access Rights” setting.

■ Manager Menu (Continued)

◇ **Built-in Test**

You can check the transceiver's condition by using the "Built-in Test" item.

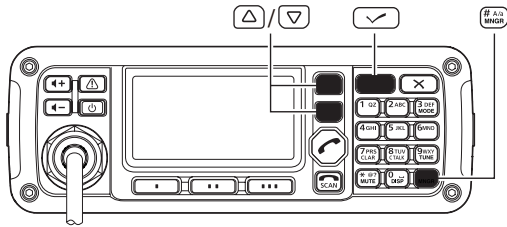

① Push **[MNGR](#)** to enter the Manager Menu screen.

- "Admin Logout" is automatically selected.

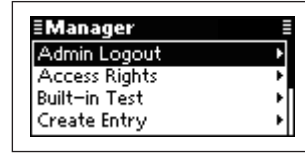

② Push **[△]** or **[▽]** to select "Built-in Test," and then push **[✓]**.

③ Push **[△]** or **[▽]** to select the item, and then push **[✓]** to start testing.

- "Auto," "Logic," "Receiver" and "Transmitter" are selectable.

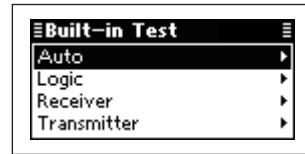

- If any problems are found, "Test failed" appears.
- If no problems are found, "Test passed" appears.

◇ **Information**

You can display a variety of information by using the "Information" item.

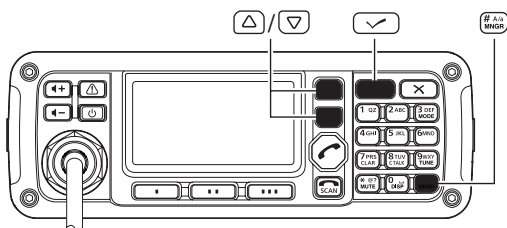

① Push **[MNGR](#)** to enter the Manager Menu screen.

- "Admin Logout" is automatically selected.

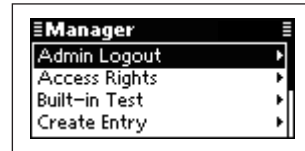

② Push **[△]** or **[▽]** to select "Information," and then push **[✓]**.

③ Push **[△]** or **[▽]** to select the item, and then push **[✓]** to display the information.

- "Date/Time," "GPS," "Priority Network," "Unit" and "Version" are selectable.

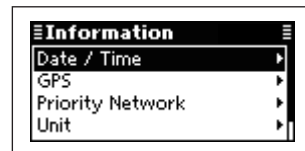

- "GPS" requires data from an external GPS unit.

◇ Create Entry

You can create new entries that are ALE, Channel, Network or Selcall items.

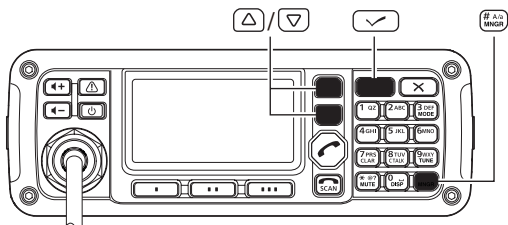

- Push **[MNGR](#)** to enter the Manager Menu screen.
 - “Admin Logout” is automatically selected.

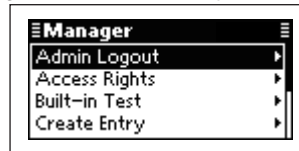

- Push **[△]** or **[▽]** to select “Create Entry,” and then push **[✓]**.
- Create the desired entry as follows.
 - “ALE,” “Channel,” “Network” or “Selcall” can be selected.

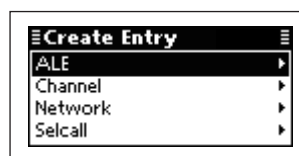

• ALE

A Call ID, NET ID or Self ID can be created.

Making a Call ID or Self ID

- Push **[△]** or **[▽]** to select “ALE,” and then push **[✓]**.

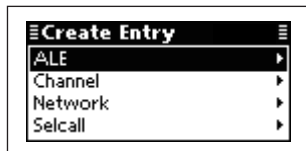

- Push **[△]** or **[▽]** to select a Call ID or Self ID, and then push **[✓]** to enter the input mode.

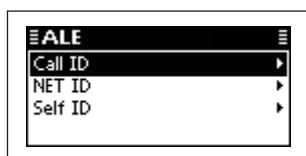

- Push Keypad to enter the desired ID, and then push **[✓]**.
 - Up to 15 characters can be entered.
 - Usable characters are A to Z, 0 to 9, ? and @.
 - Push **[A/a](#)** to toggle between the Alphabet (Upper case letter) input mode and Number input mode.
 - Push **[X]** to delete the character, symbol or number to the left of the cursor.
 - Push **[◀](*)** or **[▶](**)** to move the cursor.

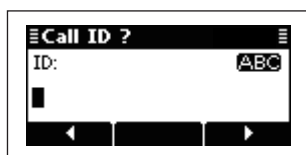

- If the entered ID belongs to the specified NET ID, push **[△]** or **[▽]** to select the ID, and then push **[✓]**.
 - If the entered ID does not belong to any network, select (blank) and push **[✓]**.

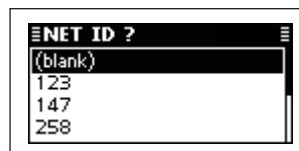

- If the entered ID uses with the specified Network group, push **[△]** or **[▽]** to select the Network, and then push **[✓]**.
 - If the entered ID does not use with any network group, select (blank) and push **[✓]**.

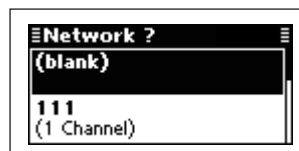

- If any NET ID is selected in step ④, select Slot number.
 - Selectable number are 1 to 20.

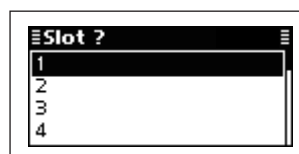

- Push **[✓]** to save the ID and exit.

■ Manager Menu
 ◇ Create Entry (Continued)

• ALE

Making a NET ID

① Push [△] or [▽] to select “ALE,” and then push [✓].

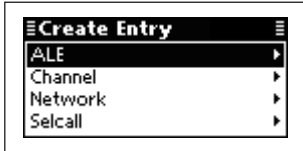

② Push [△] or [▽] to select a NET ID, and then push [✓] to enter the input mode.

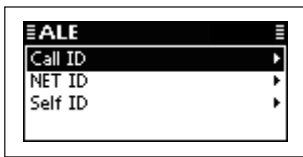

③ Push Keypad to enter the desired ID, and then push [✓].

- Up to 15 characters can be entered.
- Usable characters are A to Z, 0 to 9, ? and @.
- Push [A/a](#) to toggle between the Alphabet (Upper case letter) input mode and Number input mode.
- Push [X] to delete the character, symbol or number to the left of the cursor.
- Push [◀](▪) or [▶](▪▪▪) to move the cursor.

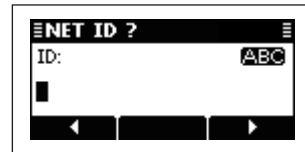

④ Push [✓] to save the ID and exit.

• Channel

A new memory channel can be created.

① Push [△] or [▽] to select “Channel,” and then push [✓] to enter the input mode.

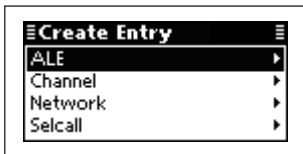

② Push Keypad to enter the Channel name, and then push [✓].

- Up to 20 characters can be entered.
- See page 2 for the usable characters details.
- Push [A/a](#) to toggle between the Upper, Lower case letter input modes and Number input mode.
- Push [X] to delete the character, symbol or number to the left of the cursor.
- Push [◀](▪) or [▶](▪▪▪) to move the cursor.

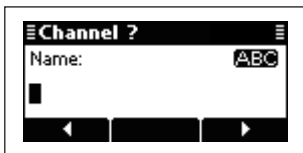

③ Push Keypad to enter the receive frequency, and then push [✓].

- Push [*] to enter the decimal point.
- Push [X] to delete the number.
- Push [◀](▪) or [▶](▪▪▪) to move the cursor.

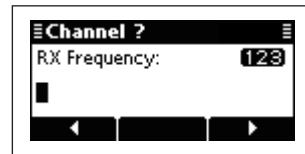

④ Push Keypad to enter the transmit frequency, and then push [✓].

- Push [*] to enter the decimal point.
- Push [X] to delete the number.
- Push [◀](▪) or [▶](▪▪▪) to move the cursor.

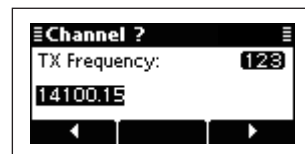

⑤ Push [△] or [▽] to select the operating mode.

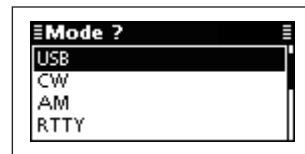

⑥ Push [✓] to save the channel and exit.

• Network

A new network can be created.

- 1 Push [△] or [▽] to select “Network,” and then push [✓] to enter the input mode.

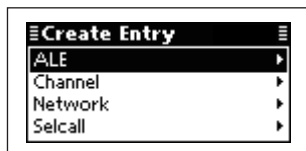

- 2 Push Keypad to enter the Network name, and then push [✓].
 - Up to 20 characters can be entered.
 - See page 2 for the usable characters details.
 - Push [A/a](#) to toggle between the Upper, Lower case letter input modes and Number input mode.
 - Push [X] to delete the character, symbol or number to the left of the cursor.
 - Push [◀](*) or [▶](***) to move the cursor.

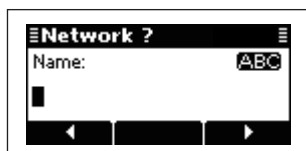

- 3 Push [△] or [▽] to select the Scan type, and then push [✓] to select or deselect.
 - “✓” appears to the left of the selected scan type.
 - If desired, up to three scan types can be selected.

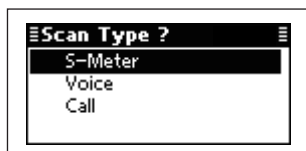

- 4 Hold down [✓] for 1 second to go to the next screen.

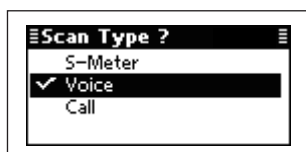

- 5 Push [△] or [▽] to select the Call system, and then push [✓].

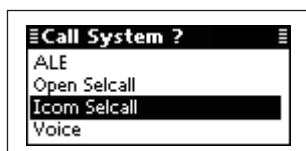

- 6 Push [△] or [▽] to select the Call detect time, and then push [✓].

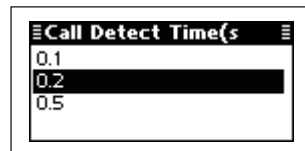

- 7 Push [△] or [▽] to select the Preamble, and then push [✓].
 - Selectable times are 1 to 60 seconds and Auto.

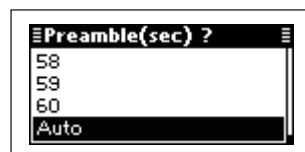

- 8 Push [△] or [▽] to select the Priority setting.
 - Priority setting can be set to only one Network. If this setting is set to ON, the previously selected Priority Network is automatically set to OFF.

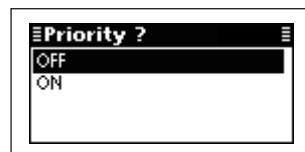

- 9 Push [△] or [▽] to select the memory channels, and then push [✓] to select or deselect.
 - “✓” appears to the left of the selected channel.
 - If desired, several channels can be selected.

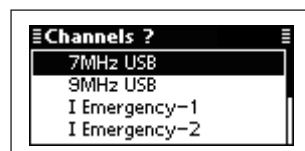

- 10 Hold down [✓] for 1 second to save the network and exit.

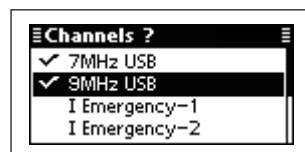

■ Manager Menu
 ◇ Create Entry (Continued)

• Selcall

A new Selcall entry, Address, Phone Link or Profile, can be created.

Making an Address

① Push [△] or [▽] to select “Selcall,” and then push [✓].

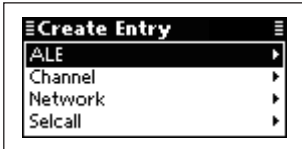

② Push [△] or [▽] to select “Address,” and then push [✓] to enter the input mode.

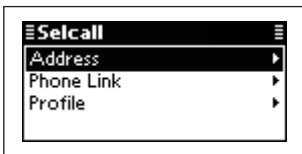

③ Push Keypad to enter the Address name, and then push [✓].

- Up to 20 characters can be entered.
- See page 2 for the usable characters details.
- Push [A/a](#) to toggle between the Upper, Lower case letter input modes and Number input mode.
- Push [X] to delete the character, symbol or number to the left of the cursor.
- Push [◀](▪) or [▶](***) to move the cursor.

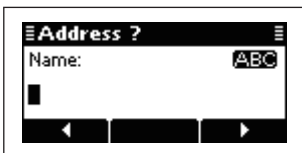

④ Push [△] or [▽] to select the Call type. Then push keypad to enter the ID or number, and push [✓].

- Push [X] to delete the character, symbol or number to the left of the cursor.
- Push [◀](▪) or [▶](***) to move the cursor.

<Call type is other than Phone>

- Up to 6 digits can be entered.

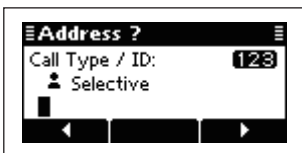

<Call type is Phone>

- Up to 16 digits can be entered.

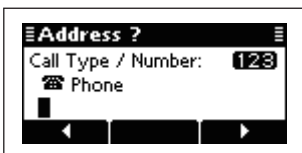

⑤ Push [△] or [▽] to select a network group or Phone Link.

<Call type is other than Phone>



<Call type is Phone>

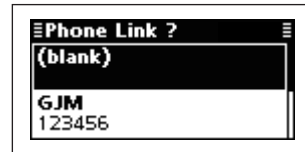

⑥ Push [△] or [▽] to select the Emergency Link ON or OFF.

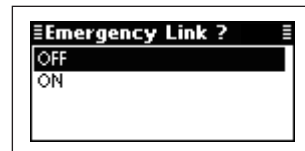

⑦ Push [✓] to save the channel and exit.

• Selcall

Making a Phone Link

① Push [△] or [▽] to select “Selcall,” and then push [✓].

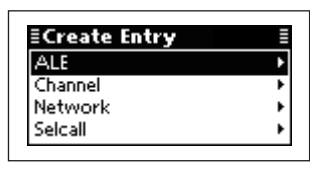

② Push [△] or [▽] to select “Phone Link,” and then push [✓] to enter the input mode.

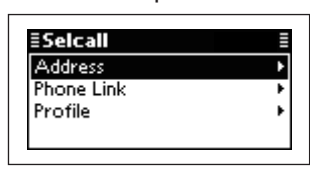

③ Push Keypad to enter the Phone Link name, and then push [✓].

- Up to 20 characters can be entered.
- See page 2 for the usable characters details.
- Push [A/a](#) to toggle between the Upper, Lower case letter input modes and Number input mode.
- Push [✕] to delete the character, symbol or number to the left of the cursor.
- Push [◀](*) or [▶](***) to move the cursor.

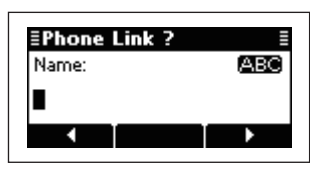

④ Push keypad to enter the ID, and then push [✓].

- Up to 6 digits can be entered.
- Push [✕] to delete the character, symbol or number to the left of the cursor.
- Push [◀](*) or [▶](***) to move the cursor.

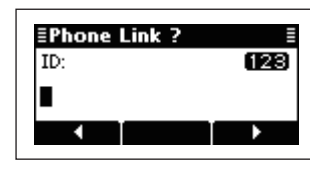

⑤ Push [△] or [▽] to select a network group, and then push [✓].

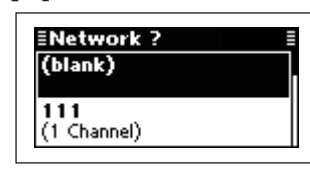

⑥ Push [△] or [▽] to select the memory channels.

- Only the memory channels that belong to the selected network group in step ⑤, are selectable.



⑦ Push [✓] to save the Phone Link and exit.

■ Manager Menu
 ◇ Create Entry (Continued)

• Selcall

Making a Profile

① Push [△] or [▽] to select “Selcall,” and then push [✓].

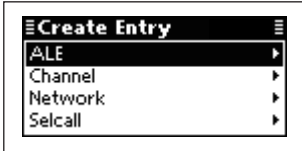

② Push [△] or [▽] to select “Profile,” and then push [✓] to enter the input mode.

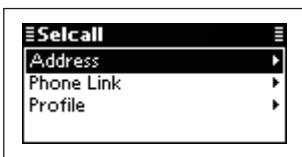

③ Push Keypad to enter the Profile name, and then push [✓].

- Up to 20 characters can be entered.
- See page 2 for the usable characters details.
- Push [A/a](#) to toggle between the Upper, Lower case letter input modes and Number input mode.
- Push [X] to delete the character, symbol or number to the left of the cursor.
- Push [◀](•) or [▶](•••) to move the cursor.

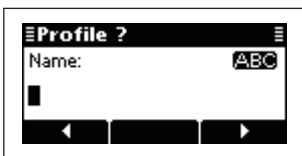

④ Push keypad to enter the ID, and then push [✓].

- Up to 6 digits can be entered.
- Push [X] to delete the character, symbol or number to the left of the cursor.
- Push [◀](•) or [▶](•••) to move the cursor.

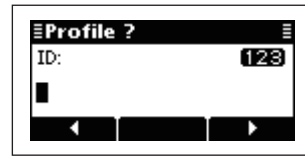

⑤ Push [△] or [▽] to select a network group.

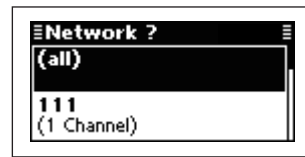

⑥ Push [✓] to save the Profile and exit.

◇ **Delete Entry**

Any no-longer-used entries, such as memory channels or Selcall addresses can be cleared.

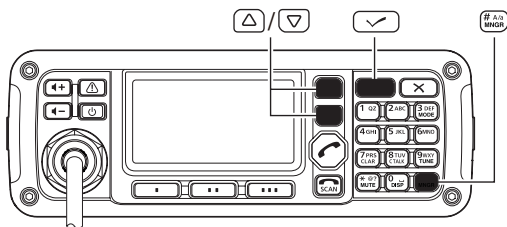

① Select a memory channel, Selcall address or some other setting that you want to clear.

② Push [MNGR](#) to enter the Manager Menu screen.

- “Admin Logout” is automatically selected.

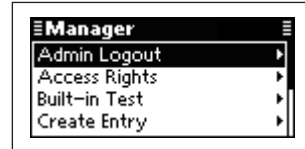

③ Push [△] or [▽] to select “Delete Entry,” and then push [✓].

- The confirmation screen, “Delete Entry?” appears.

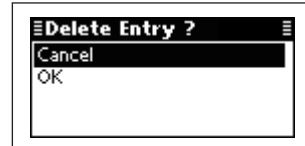

④ Push [▽] to select “OK,” and then push [✓].

◇ Setup

You can make a new entries that are Channel, Network, ALE Self ID or Selcall Profile using the Setup Wizard.

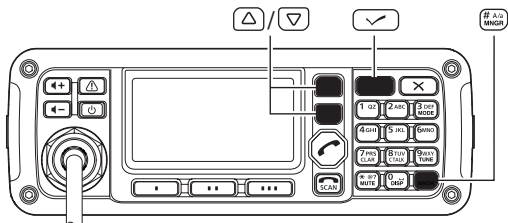

- ① Push **[MNGR](#)** to enter the Manager Menu screen.
 - “Admin Logout” is automatically selected.

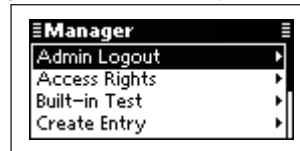

- ② Push **[△]** or **[▽]** to select “Setup,” and then push **[✓]**.
- ③ Create the desired entry as follows.
 - “Channel,” “Network,” “ALE Self ID,” or “Selcall Profile” can be selected.

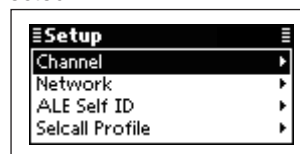

• Channel

A new memory channel can be created.

- ① Push **[△]** or **[▽]** to select “Channel,” and then hold down **[✓]** for 1 second to enter the input mode.

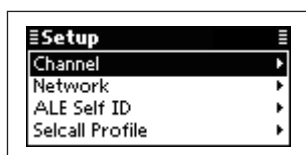

- ② Push Keypad to enter the Channel name, and then push **[✓]**.
 - Up to 20 characters can be entered.
 - See page 2 for the usable characters details.
 - Push **[A/a](#)** to toggle between the Upper, Lower case letter input modes and Number input mode.
 - Push **[X]** to delete the character, symbol or number to the left of the cursor.
 - Push **[←](*)** or **[→](***)** to move the cursor.

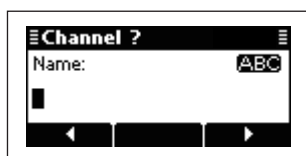

- ③ Push Keypad to enter the receive frequency, and then push **[✓]**.
 - Push **[*]** to enter the decimal point.
 - Push **[X]** to delete the number.
 - Push **[←](*)** or **[→](***)** to move the cursor.

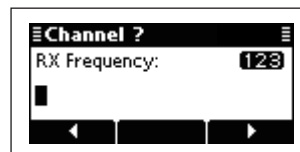

- ④ Push Keypad to enter the transmit frequency, and then push **[✓]**.
 - Push **[*]** to enter the decimal point.
 - Push **[X]** to delete the number.
 - Push **[←](*)** or **[→](***)** to move the cursor.

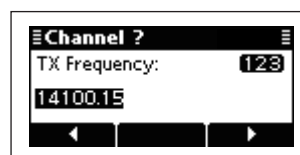

- ⑤ Push **[△]** or **[▽]** to select the operating mode.

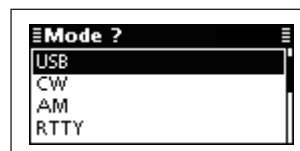

- ⑥ Push **[✓]** to save the channel and exit.

■ Manager Menu
 ◇ Setup (Continued)

• **Network**

A new network can be created.

⚡ **NOTE:** The present Network list is cleared.

- ① Push [△] or [▽] to select “Network,” and then hold down [✓] for 1 second to enter the input mode.

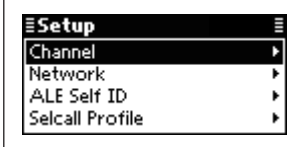

- ② Push [△] or [▽] to select the memory channels, and then push [✓] to select or deselect.
 - “✓” appears to the left of the selected channel.
 - If desired, several channels can be selected.

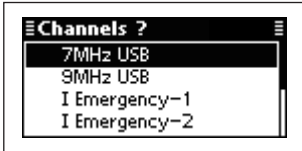

- ③ Hold down [✓] for 1 second to go to the next screen.

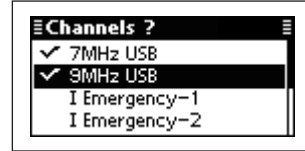

- ④ Push [▽] to select “OK,” and then push [✓].
 - If desired, select “Cancel” and then push [✓].



• **ALE Self ID**

A Self ID can be created.

⚡ **NOTE:** The present Self ID is cleared.

- ① Push [△] or [▽] to select “ALE Self ID,” and then hold down [✓] for 1 second to enter the input mode.

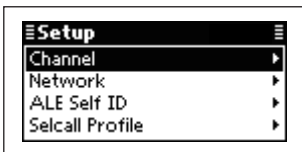

- ② Push Keypad to enter the desired ID, and then push [✓].
 - Usable characters are A to Z, 0 to 9, ? and @.
 - Push [A/a](#) to toggle between the Alphabet (Upper case letter) input mode and Number input mode.
 - Push [X] to delete the character, symbol or number to the left of the cursor.
 - Push [◀](*) or [▶](***) to move the cursor.

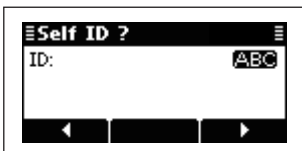

- ③ Push [▽] to select “OK,” and then push [✓].
 - If desired, select “Cancel” and then push [✓].



• **Selcall Profile**

Selcall Profile can be created.

⚡ **NOTE:** The present Selcall Profile is cleared.

- ① Push [△] or [▽] to select “Selcall Profile,” and then hold down [✓] for 1 second to enter the input mode.

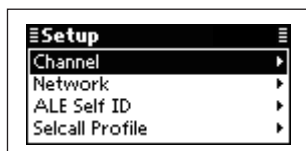

- ② Push Keypad to enter the desired ID, and then push [✓].
 - Up to 6 numbers can be entered.
 - Usable characters are A to Z, 0 to 9, ? and @.
 - Push [X] to delete the number to the left of the cursor.
 - Push [◀](*) or [▶](***) to move the cursor.

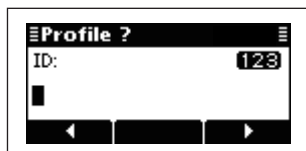

- ③ Push [▽] to select “OK,” and then push [✓].
 - If desired, select “Cancel” and then push [✓].



■ Main Menu

◇ Entering the Main Menu

- ① Push [**X**] to enter the Main Menu screen.
- ② Push [**△**] or [**▽**] to select the item, and then push [**✓**] to open the screen.
 - “ALE,” “Call In,” “Call Out,” “Channel,” “Network,” “Selcall,” “Setmode” or “VFO” can be selected.
 - If desired, push [**X**] to returns to the Memory channel screen.
- ③ Push [**△**] or [**▽**] to select the item, and then push or hold down [**✓**] to display or edit the screen.

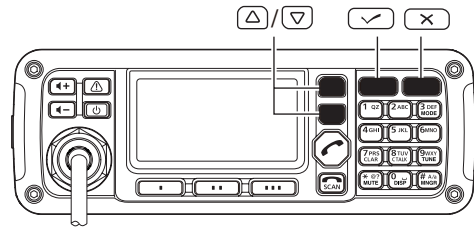

◇ ALE

Displays or edits the Entry of the list that is related to ALE.

While displaying an Entry, hold down [**✓**] for 1 second to enter the programing mode.

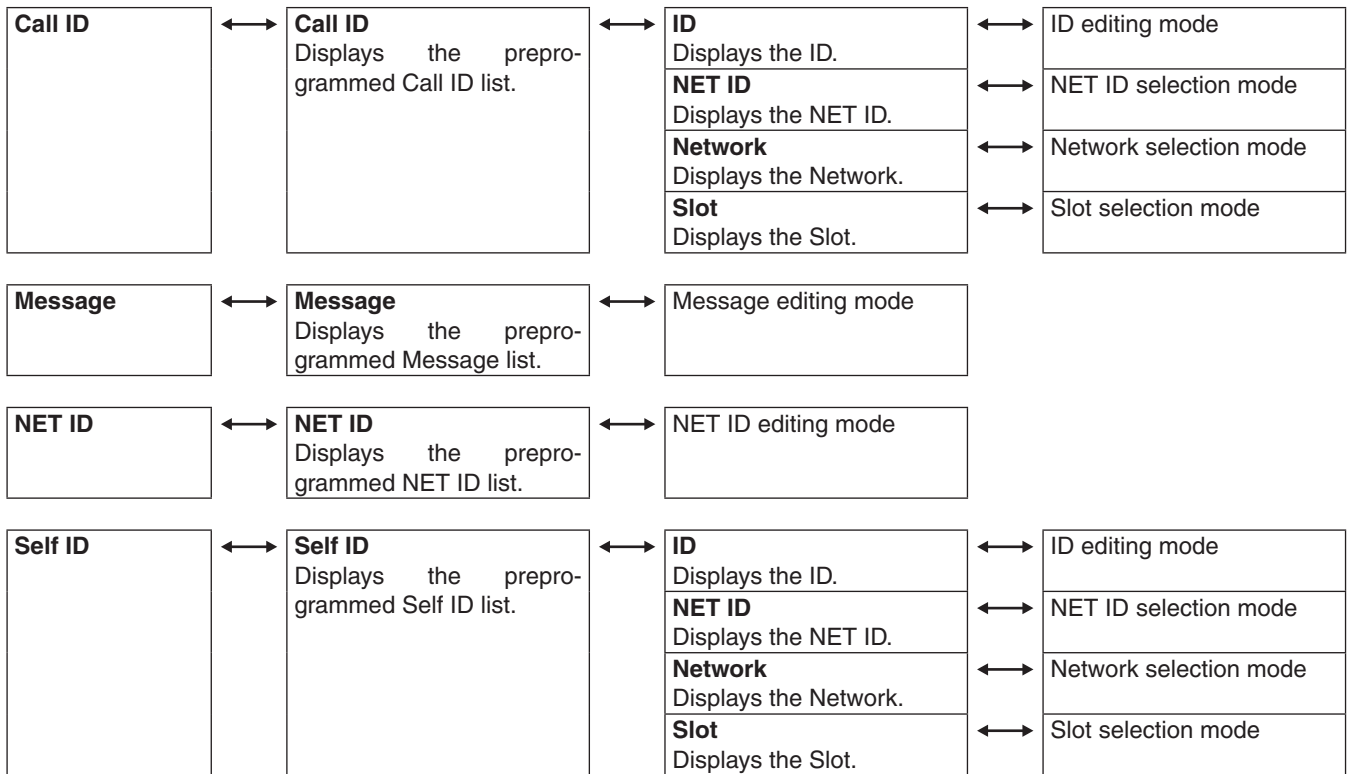

◇ Call In/Call Out

Displays the Entry of the Call In (Received Call) or Call Out (Send Call).

◇ Channel

Displays or edits the Memory channels.

While displaying an Entry of the memory channel, hold down [**✓**] for 1 second to enter the editing mode.

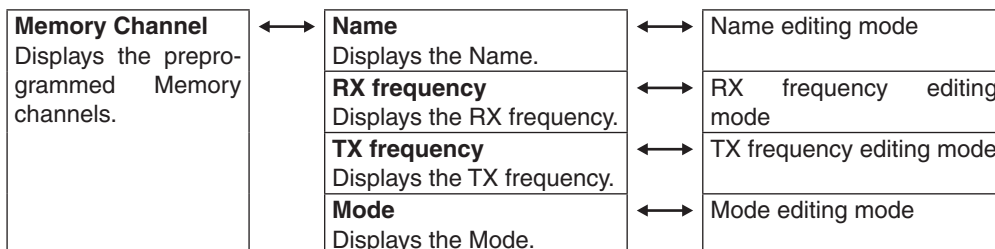

◇ Network

Displays or edits the Entry of the Network list.

While displaying an Entry, hold down [✓] for 1 second to enter the editing mode.

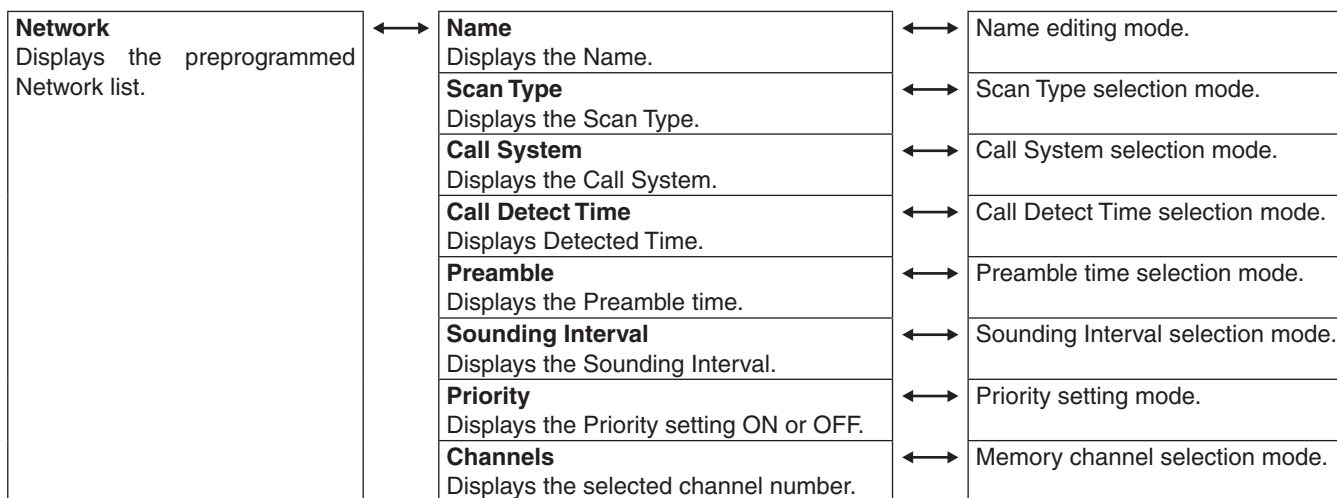

◇ Selcall

Displays or edits the Entry of the list that related to Selcall.

While displaying an Entry, hold down [✓] for 1 second to enter the programing mode.

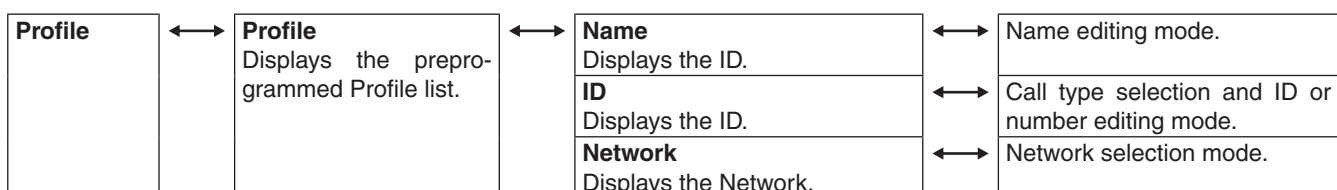
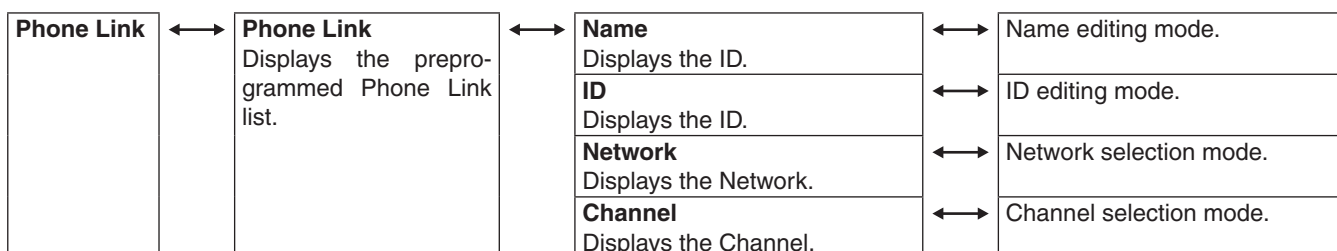
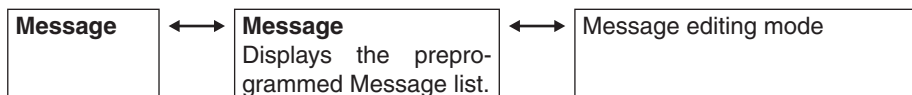
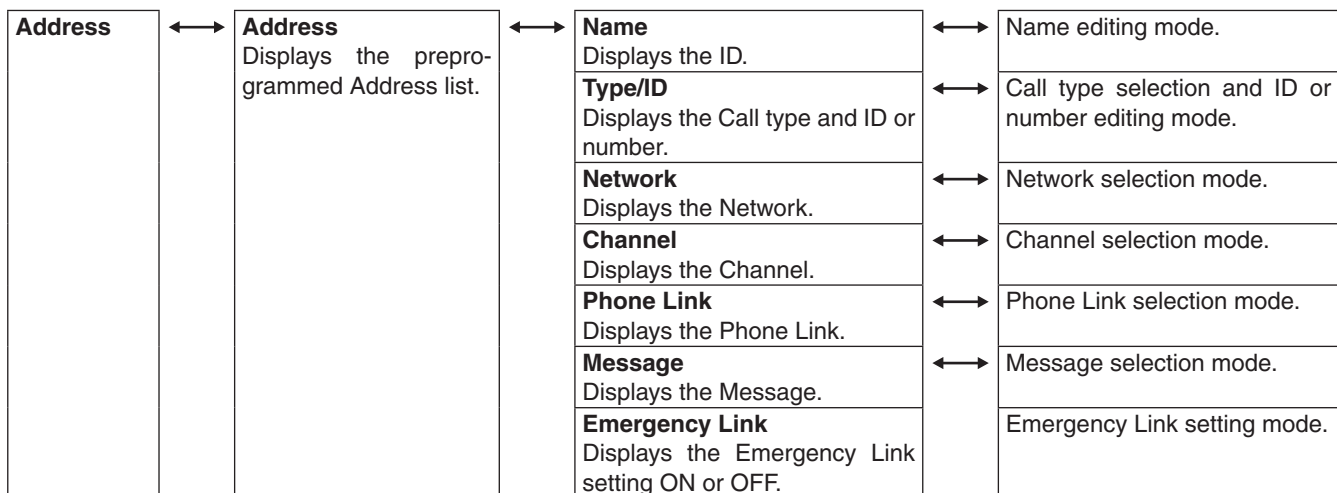

◇ **Setmode**

◆ **ALE Set mode**

Decay Time

(Default: 1 hour)

Set the decay time for the Auto Sounding function to between 1 and 8 hours.

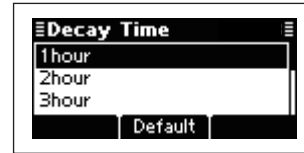

BER Threshold

(Default: 12)

Set the Bit Error Ratio (BER) threshold level to between 0 and 48 bits for ALE communication quality.

One unit consists of 48 bits of data.

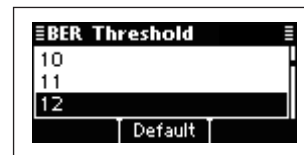

Golay Threshold

(Default: 2)

Set the Golay threshold level to between 0 and 3 bits for ALE communication quality.

The Golay consists of 12 bits of original data and 12 bits of correction data.

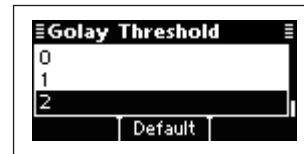

Error Threshold

(Default: 0)

Set the Error threshold level to between 0 and 4 for ALE communication quality.

When errors detected by BER threshold or Golay threshold are over this setting, communication is not possible.

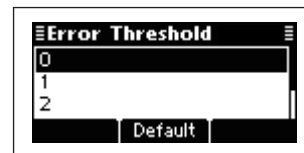

Silent

(Default: OFF)

Set the ALE Silent mode to ON or OFF.

When set to OFF, the transceiver automatically answers back if your station ID is called. When set to ON, the transceiver ignores the call.

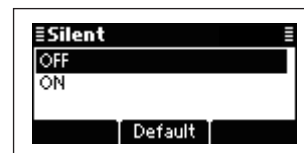

Call Retry

(Default: 1)

Set the retry times to between 0 (OFF) and 10 when the called station does not answer back.

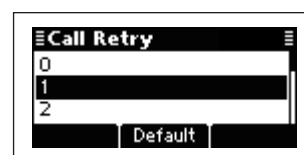

LQA Average

(Default: 8)

Set the adopting number of LQA data for averaging to between 1 and 8.

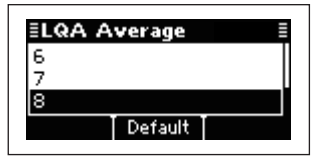

LQA Request

(Default: ON)

Set the LQA request function to ON or OFF.

When set to ON, the transceiver requests the called station to send LQA data with an ALE answer back call.



◆ **BEEP Set mode**

Beep Level

(Default: 30)

Adjust the confirmation beep level to between 0 (OFF) and 50 (Maximum), in 1 digit steps.

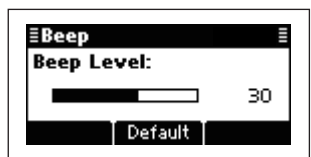

Ringtone Level

(Default: 30)

Adjust the ringtone level to between 0 (OFF) and 50 (Maximum), in 1 digit steps, to sound ringer tones when a signal is received.

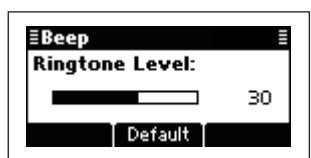

CW Side Tone Level

(Default: 30)

Adjust the CW side tone level to between 0 (OFF) and 50, in 1 digit steps.

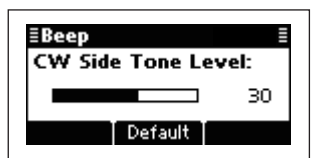

◇ Setmode (Continued)

◆ Call Set mode

Accept Icom Selcall

This item allows the transceiver to receive and make Icom Selcalls.

This setting is permanently set to "ON."

Accept Open Selcall

This item allows the transceiver to receive and make Open Selcalls.

This setting is permanently set to "ON."

Accept ALE

This item allows the transceiver to receive and make ALE (Automatic Link Establishment) calls.

This setting is permanently set to "ON."

Accept RFDS (Only AUS version)

This item allows the transceiver to receive and make RFDS (Royal Fling Doctor Service) emergency calls.

This setting is permanently set to "ON" for the AUS version, or OFF for other versions.

TX Open STUN Call

(Default: OFF)

This item allows the transceiver to make STUN calls.

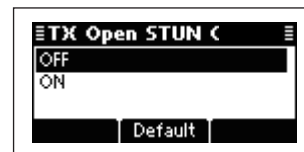

Timeout

(Default: 60sec)

Select the RX Timeout timer between 15 and 300 seconds in 15 seconds steps, or OFF.

After transmitting a Get Position or Get Status command, the transceiver waits for a reply during this set period.

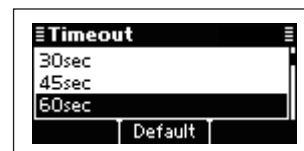

Auto Start Type

(Default: Scan)

Select the Auto Start Type.
If no operation occurs during the Auto Start Wait Time period, the Selected function automatically starts.

- OFF: The Auto Start function is disabled.
- Scan: The transceiver automatically cancels the Handshake status, and then the scan starts.
- Termination: The transceiver automatically cancels the Handshake status.

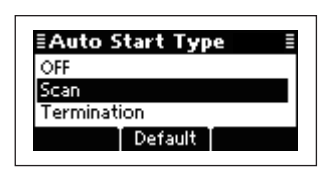

The Auto Start Wait Time is set in the next item.

Auto Start Wait Time

(Default: 2min)

Set the Auto Start Wait timer to between 1 and 20 minutes, in 1 minute steps.
If no operation occurs during this period, the Auto Start function automatically starts.

The Auto Start function is selected in the previous item.



◆ **Comment Set mode**

Customer Name

Enter a customer name of up to 20 characters.

Setting Comment

Enter a comment of up to 20 characters.

Model

This item displays the transceiver's model name.

The Model is permanently set to "IC-F8101."

◇ Setmode (Continued)

◆ **Config Set mode**

Meter Squelch Level

(Default: 10)

Adjust the squelch threshold level to between 0 and 50, in 1 digit steps.

When the S-meter squelch is activated, only signals stronger than this set level are received.



Noise Blanker

(Default: OFF)

Turns the noise blanker function ON or OFF.

The Noise Blanker function eliminates pulse-type noise such as that from car ignitions.

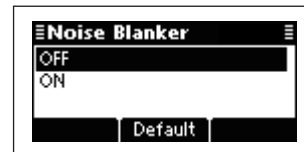

Noise Blanker Level

(Default: 10)

Adjust the Noise blanker level to between 0 and 15, in 1 digit steps.

The set level is effective when the Noise Blanker is activated.



Noise Blanker Depth

(Default: 7)

Adjust the Noise blanker depth to between 0 and 9, in 1 digit steps.

The set level is effective when the Noise Blanker is activated.



Clear Talk Level

(Default: 10)

The Clear Talk function adjusts signals in the presence of noise using the DSP circuit. This item adjusts the Clear Talk Level to between 1 (Minimum) and 15 (Maximum).



Pre Amp

(Default: ON)

Turn ON the Preamplifier function or Attenuator function.

- ON: Turns ON the Preamplifier function, which amplifies received signals in the receiver front end, to improve the S/N ratio and the sensitivity.
- OFF: Turns OFF both functions.
- ATT ON: Turns ON the Attenuator function, which prevents a desired signal from being distorted when very strong signals are near the desired frequency, or when very strong electromagnetic fields, such as from broadcast stations, are near your location.

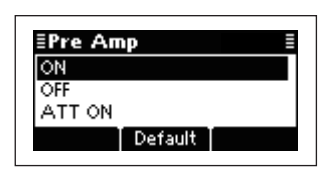

AGC

(Default: AUTO)

Set the Automatic gain control settings to FAST, SLOW, AUTO or OFF.

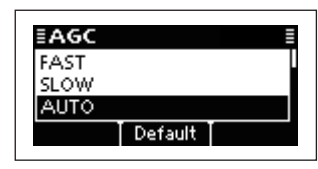

RF Power

(Default: HIGH)

Set the transmit output power to LOW, MID or HIGH.

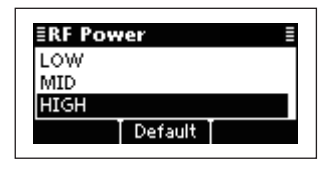

Speech Processor

(Default: OFF)

Turns the Speech Processor function ON or OFF.



Speech Processor Level

(Default: 6)

Adjust the Speech Processor Level to between 0 (Minimum) and 10 (Maximum), in 1 digit steps.

The set level is effective only when the Speech Processor is turned ON.



- ◇ Setmode
- ◆ Config Set mode (Continued)

Mic Gain

(Default: 6)

Adjust the Microphone gain to between 0 (Minimum) and 10 (Maximum), in 1 digit steps.



TX Timeout

(Default: 3min)

Set the Time-Out Timer function time to 1, 3, 5 or 10 minutes, or OFF. If a continuous transmission exceeds the set time period, transmitting will be cut off.

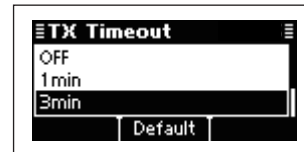

CW Break-in

(Default: 2.0sec)

The CW Break-In function toggles transmit and receive with your CW keying. This allows you to mute receiving the time delay ends after you stop keying. Turn ON the CW Break-In function and set the delay to 0.5, 1, 2 or 3 seconds, or OFF.



Tuner

(Default: ON)

Turns the automatic antenna tuner ON or OFF. If you use an optional AT-140, AH-740 or AH-760, select "ON."

- OFF: The antenna tuner is disabled and is bypassed.
- ON: The automatic antenna tuner can be used when the transceiver enters the antenna tune mode.

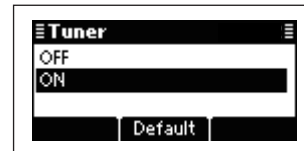

VFO mode

(Default: ON)

Select ON or OFF to activate the VFO mode.

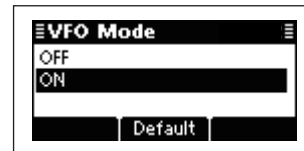

VFO Split

(Default: OFF)

Turns the Split frequency operation in the VFO mode ON or OFF. Split frequency operation allows you to transmit and receive on two different frequencies between VFO A and VFO B.

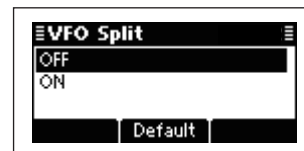

Built-in Test Display (Default: OFF)

Select whether or not to display the device check screen after turning ON power. (Default: OFF)

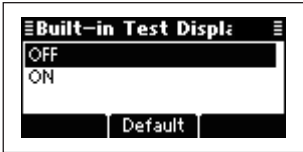

◆ **Emergency Set mode**

Link Interval (Default: 120sec)

Set the Emergency Link interval time period to between 10 and 300 seconds, in 10 seconds steps.

The transceiver will sequentially send Emergency calls to the stations whose “Emergency Link” item is set to ON in Address of the SELCALL.

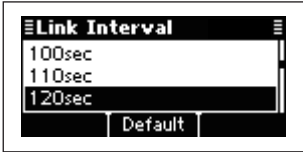

◆ **Key Set mode**

I Key (Default: Address)

The functions listed below can be set to the [I] key.

- Not assign: No function.
- Menu: Push to enter the Main Menu screen.
- Manager: Push to enter the Manager Menu screen.
- Setmode: Push to enter the Setmode screen.
- Address list: Push to display the Selcall address list.
- Call In list: Push to display the RX history screen.
- Call Out list: Push to display the TX history screen.



II Key (Default: Call In list)

The functions listed in the “I Key” item can be set to the [II] key.



III Key (Default: Call Out list)

The functions listed in the “I Key” item can be set to the [III] key.



◇ Setmode (Continued)

◆ Mode Set mode

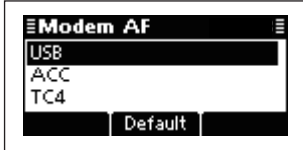
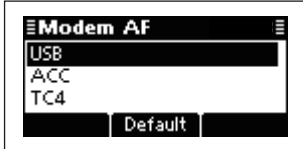
LSB	<p>Accept (Default: Disable for AUS, RX & TX for others)</p> <p>Set the LSB mode to “Disable,” “RX” or “RX & TX.”</p> <p>Disable: Disables the transceiver from both receiving and transmitting calls.</p> <p>RX: Allows the transceiver to receive calls, but disables it from transmitting them.</p> <p>RX & TX: Allows the transceiver to both receive and transmit calls.</p>	
	<p>Band Width</p> <p>Displays the IF filter passband width.</p> <p>The width is permanently set to “3000Hz.”</p>	
	<p>Modem AF (Default: USB)</p> <p>Set the connector for data modulation input when an external unit’s [PTT] is pushed.</p> <p>TC4: Inputs the modulation signals through a RapidM TC4 HF Data Modem Module.</p> <p>ACC: Inputs the modulation signals through the ACC connector.</p> <p>USB: Inputs the modulation signals through a USB port.</p>	
USB	<p>Accept</p> <p>Displays the USB mode permission setting.</p> <p>This setting is permanently set to “RX & TX.”</p>	
	<p>Band Width</p> <p>Displays the IF filter passband width.</p> <p>The width is permanently set to “3000Hz.”</p>	
	<p>Modem AF (Default: USB)</p> <p>Set the connector for data modulation input when an external unit’s [PTT] is pushed.</p> <p>See the “Modem AF” item in “LSB” for details.</p>	

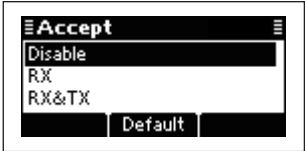
CW	<p>Accept (Default: Disable)</p> <p>Set the CW mode to “Disable,” “RX” or “RX & TX.”</p> <p>See the “Accept” item in “LSB” for details.</p>	
	<p>Band Width</p> <p>Displays the IF filter passband width.</p> <p>The width is permanently set to “500Hz.”</p>	

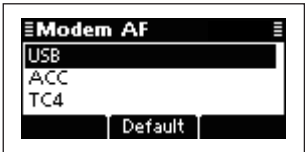
AM	<p>Accept (Default: RX for AUS, Disable for others)</p> <p>Set the AM mode to “Disable,” “RX” or “RX & TX.”</p> <p>See the “Accept” item in “LSB” for details.</p>	
	<p>Band Width</p> <p>Displays the IF filter passband width.</p> <p>The width is permanently set to “8000Hz.”</p>	
	<p>Modem AF (Default: USB)</p> <p>Set the connector for data modulation input when an external unit’s [PTT] is pushed.</p> <p>See the “Modem AF” item in “LSB” for details.</p>	

- ◇ Setmode
- ◆ Mode Set mode (Continued)

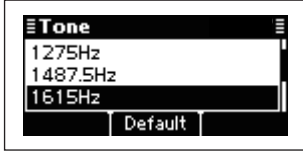
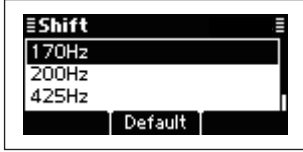
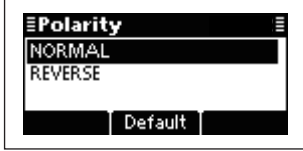
RTTY	<p>Accept (Default: Disable)</p> <p>Set the RTTY mode to “Disable,” “RX” or “RX & TX.”</p> <p>See the “Accept” item in “LSB” for details.</p>	
	<p>Tone (Default: 1615Hz)</p> <p>Set the RTTY mark frequency to 1200, 1275, 1487.5, 1615, 1700, 2100 or 2125 Hz.</p>	
	<p>Shift (Default: 170Hz)</p> <p>Set the RTTY shift frequency to 170, 200, 425 or 850 Hz.</p>	
	<p>Polarity (Default: Normal)</p> <p>Set the keying polarity to Normal or Reverse.</p> <p>When reverse polarity is selected, the mark and space frequencies are reversed.</p> <p>Normal: Key open/close = Mark/Space Reverse: Key open/close = Space/Mark</p>	

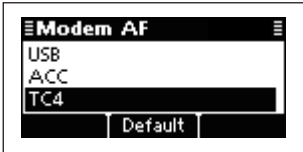
<p>LSBD1</p> <p>USBD1</p>	<p>Accept (Default: Disable)</p> <p>Set the LSBD1 or USBD1 mode to “Disable,” “RX” or “RX & TX.”</p> <p>See the “Accept” item in “LSB” for details.</p>	
	<p>Offset</p> <p>Displays the Offset frequency.</p> <p>The frequency is permanently set to “1800Hz.”</p>	
	<p>Band Width</p> <p>Displays the IF filter passband width.</p> <p>The width is permanently set to “3000Hz.”</p>	
	<p>Modem AF (Default: TC4)</p> <p>Set the connector for data modulation input when an external unit’s [PTT] is pushed.</p> <p>See the “Modem AF” item in “LSB” for details.</p>	

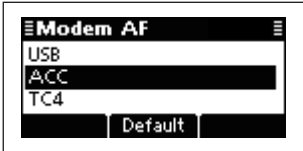
<p>LSBD2</p> <p>USBD2</p>	<p>Accept (Default: Disable)</p> <p>Set the LSBD2 or USBD2 mode to “Disable,” “RX” or “RX & TX.”</p> <p>See the “Accept” item in “LSB” for details.</p>	
	<p>Offset</p> <p>Displays the Offset frequency.</p> <p>The frequency is permanently set to “1500Hz.”</p>	
	<p>Band Width</p> <p>Displays the IF filter passband width.</p> <p>The width is permanently set to “3000Hz.”</p>	
	<p>Modem AF (Default: ACC)</p> <p>Set the connector for data modulation input when an external unit’s [PTT] is pushed.</p> <p>See the “Modem AF” item in “LSB” for details.</p>	

- ◇ Setmode
- ◆ Mode Set mode (Continued)

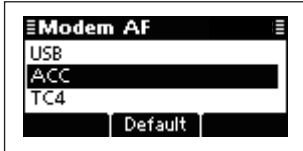
<p>LSBD3</p> <p>USB3</p>	<p>Accept (Default: Disable)</p> <p>Set the LSBD3 or USB3 mode to “Disable,” “RX” or “RX & TX.”</p> <p>See the “Accept” item in “LSB” for details.</p>	
	<p>Offset</p> <p>Displays the Offset frequency.</p> <p>The frequency is permanently set to “1650Hz.”</p>	
	<p>Band Width</p> <p>Displays the IF filter passband width.</p> <p>The width is permanently set to “3000Hz.”</p>	
	<p>Modem AF (Default: ACC)</p> <p>Set the connector for data modulation input when an external unit’s [PTT] is pushed.</p> <p>See the “Modem AF” item in “LSB” for details.</p>	

◆ Password Set mode

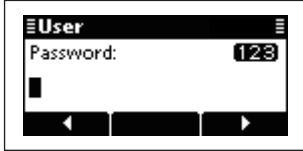
<p>User</p> <p>Enter a Login Password of up to 10 characters to enter the User mode.</p>	
-------------------------------------------------------------------------------------------------	--------------------------------------------------------------------------------------

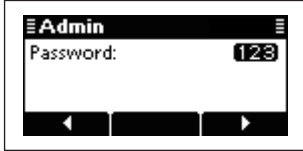
<p>Admin</p> <p>Enter a Login Password of up to 10 characters to enter the Administrator mode.</p>	
-----------------------------------------------------------------------------------------------------------	--------------------------------------------------------------------------------------

◆ PIN Code Set mode

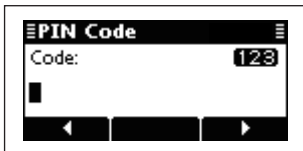
<p>PIN Code</p> <p>Set a PIN code of up to 10 digits. When the matched Selcall ID and PIN Code are received, the stun function is activated.</p>	
---------------------------------------------------------------------------------------------------------------------------------------------------------	--------------------------------------------------------------------------------------

◆ Scan Set mode

Type

(Default: Call)

Set the scan type to "Call," "S-Meter," "Voice" or "All Memory."
(Default: Call)

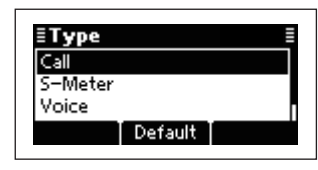

- CALL:** Call Scan. It scans the channels that belong to the network group whose scan type is "Call."
If your station ID is called with a Selcall or ALE call, the scan stops on that channel and the voice squelch control function is activated.
- S-Meter:** S-Meter Scan. It scans the channels that belong to the network group whose scan type is "S-Meter."
If the transceiver detects the signal whose S-meter level is higher than the Meter Squelch Level setting, the scan stops on that channel.
- Voice:** Voice Scan. It scans the channels that belong to the network group whose scan type is "Voice."
If the transceiver detects voice components, the scan stops on that channel.
- All:** All Memory Scan. It scans all memory channels.
If the transceiver detects signal whose S-meter level is higher than the Meter Squelch Level setting, the scan stops on that channel.

Voice Scan Resume

(Default: 10sec)

Set the scan resume function to ON or OFF for an S-Meter, Voice or All Memory scan, and set the pause timer to between 5 seconds and 120 seconds, in 5 second steps.
(Default: 10sec)

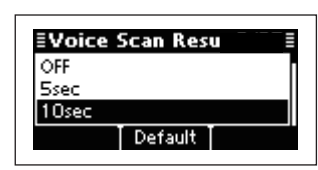

When this setting is ON and a signal is detected, a scan pauses for this set period, then resumes, or resumes 2 seconds after the signal disappears.
If OFF is selected, the scan pauses until the signal disappears.

All Memory Scan Speed

(Default: HIGH)

Set the scan speed for the All Memory scan to LOW, MID or HIGH.
(Default: HIGH)

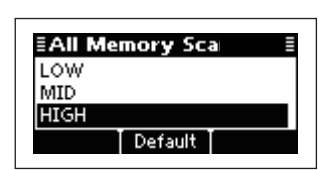

◇ Setmode (Continued)

◆ **Screen Set mode**

Contrast

(Default: 6)

Adjust the contrast of the LCD to between 0 and 10, in 1 digit steps.

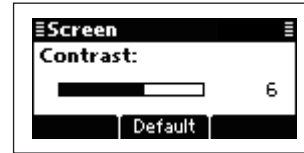

Dimmer

(Default: 5)

Adjust the backlight brightness of the LCD to between 0 (dark) and 10 (bright), in 1 digit steps.

1 to 10: Lights while the transceiver power is ON.
0: Turns OFF the backlight.

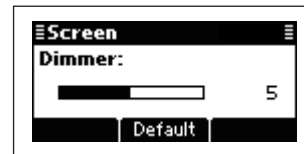

Backlight

(Default: CONTINUOUS)

Set the LCD backlight timer to OFF, Continuous, or to between 5 and 90 seconds, in 5 second steps.

OFF: Never lights.
5 to 90: Lights when an operation is performed, goes out after the specified time period.
CONTINUOUS: Lights continuously while the transceiver power is ON.

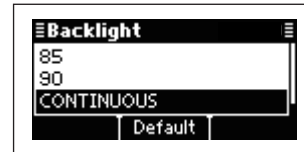

Marquee

(Default: 2 times)

Set the marquee times for the text scroll function.

OFF: Turns OFF the function.
1 time to 7 times: Scrolls the text for the selected number of times.
CONTINUOUS: Continuously scrolls the text.

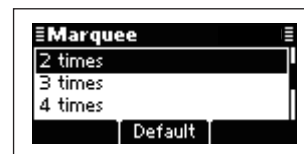

Home

(Default: Channel)

Select the default home display.

Channel: The contents of the Channel sheet is displayed.
VFO: The operating frequency is displayed.

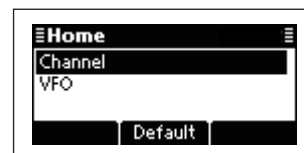

◆ Selcall Set mode

Silent

(Default: OFF)

Set the automatic answer back function for Selcall to ON or OFF.

OFF: The transceiver automatically answers back if your station ID is called.

ON: The transceiver ignores the call even if your station ID is called.

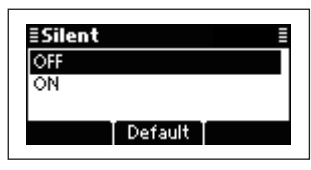

◆ Serial Port Set mode

GPS Baudrate

(Default: 4800)

Set the GPS data transfer speed to 4800 or 9600 bps.

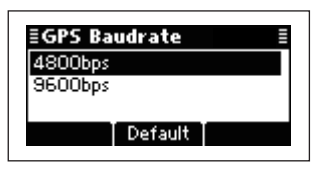

CI-V Baudrate

(Default: AUTO)

Set the CI-V data transfer speed to 300, 1200, 4800, 9600, 19200 or AUTO.

When "AUTO" is selected, the baud rate is automatically set according to the data rate of the controller

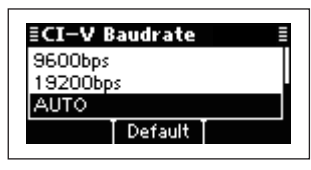

CI-V Address

(Default: 8Ah)

To distinguish equipment, each CI-V transceiver has its own Icom standard address in hexadecimal code.



◇ Setmode (Continued)

◆ Time Set mode

Local

Set the Local time.

/// Before programming this item, the "UTC Offset" item must be set.

- ① Push [△] or [▽] to select this item, and then hold down [✓] to open the programming screen.
- ② Push [△] or [▽] to select the digit.
 - Push [✓] to move the cursor right, push [✕] to move the cursor left.
- ③ After the 'second' digit is programmed, push [✓] to set the time and return to the previous screen.

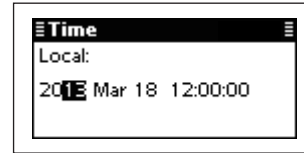

UTC Offset

Select the time difference between UTC (Universal Time Coordinated) and the local time.

-12.0 to + 12.0 (in 0.5* steps)
* 0.5 = 30 minutes

/// This item must be set before programming the "Local" item.

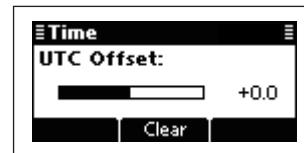

■ CPU Reset

If you want to initialize the operating settings in the Main Menu, without clearing memory channel contents or ID contents, do the following steps.

- ① Turn OFF the transceiver power, if it is powered ON.
- ② While holding down [Δ] and [∇], and push [Power] to turn ON the transceiver power to reset the CPU.

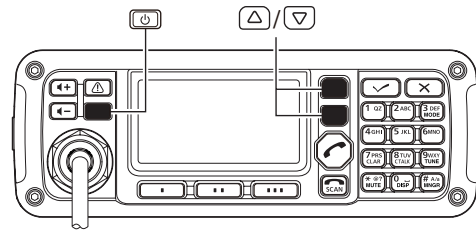

■ Supplied accessories

◇ One package type

The following accessories are supplied with IC-F8101
One package type.

- ① Microphone 1
- ② External speaker 1
- ③ DC power cable..... 1
- ④ Spare fuses (ATC 30 A) 2
- ⑤ Microphone hanger kit 1 set
- ⑥ Rubber feet 4
- ⑦ Sponge..... 1

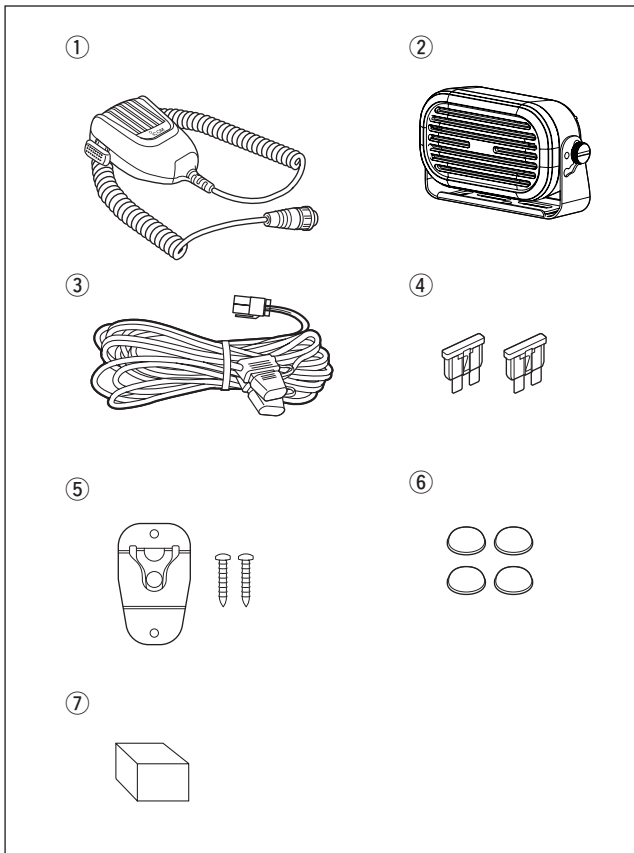

◇ Separated type

The following accessories are supplied with IC-F8101
Separated type.

- ① Microphone 1
- ② External speaker 1
- ③ DC power cable..... 1
- ④ Spare fuses (ATC 30 A) 2
- ⑤ Microphone hanger kit 1 set
- ⑥ Rubber feet 4
- ⑦ Remote controller with mounting bracket..... 1
- ⑧ Separation kit* 1 set
- ⑨ Sponge..... 1

*The separation cable is not supplied, and must be purchased separately according to the cable length.

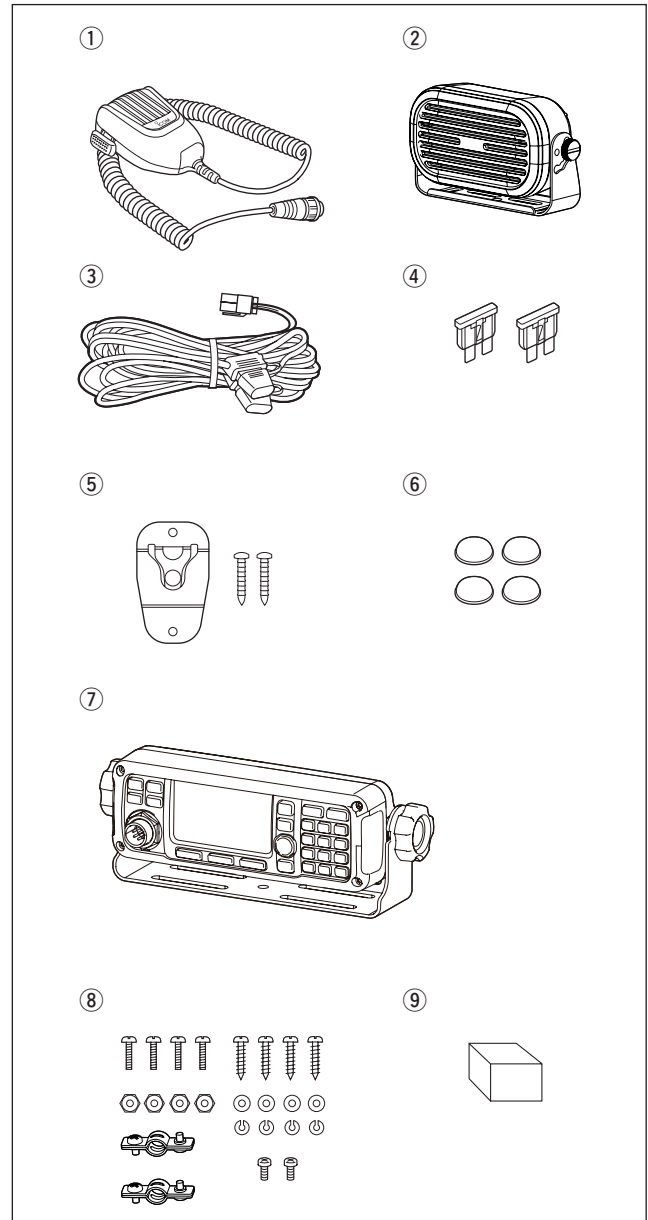

◇ Remote control microphone type

The following accessories are supplied with IC-F8101 Remote control microphone type.

- ① Remote control microphone..... 1
- ② External speaker 1
- ③ DC power cable..... 1
- ④ Spare fuses (ATC 30 A) 2
- ⑤ Microphone hanger kit 1 set
- ⑥ Screw 1
- ⑦ Rubber feet 4
- ⑧ Separation MIC connector 1
- ⑨ Sponge..... 1

*The separation cable is not supplied, and must be purchased separately according to the cable length.

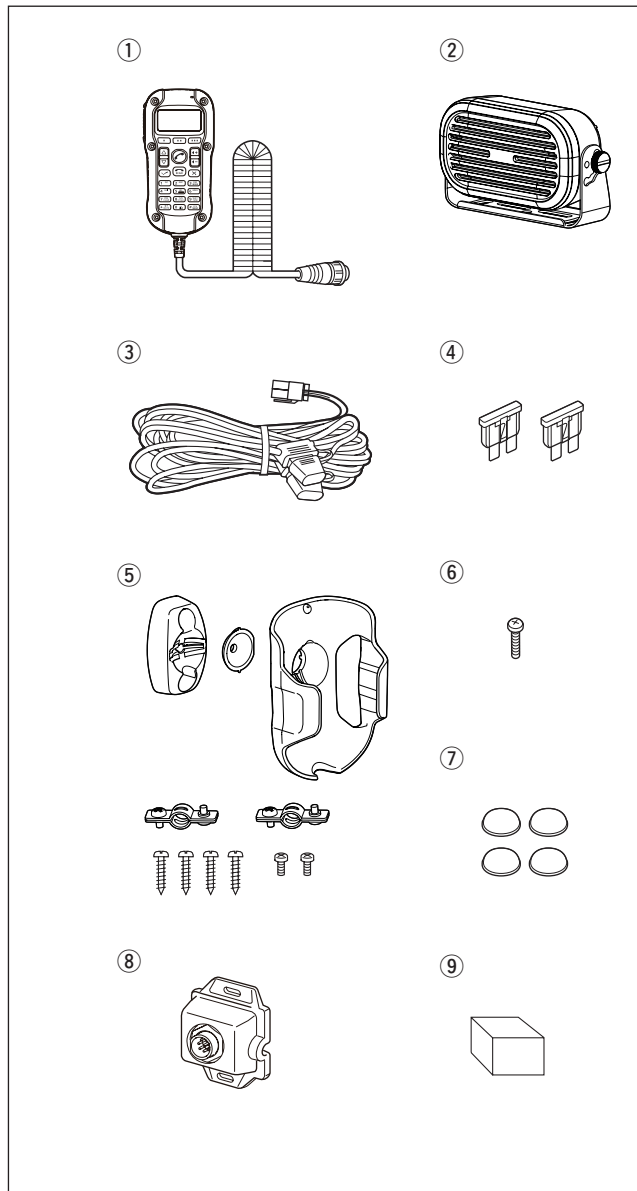

◇ Attaching the rubber feet

- ① Turn the Main unit upside down.
- ② Remove the protective sheets from the rubber feet.
- ③ Stick the rubber feet into the round hollow spots on the bottom cover.

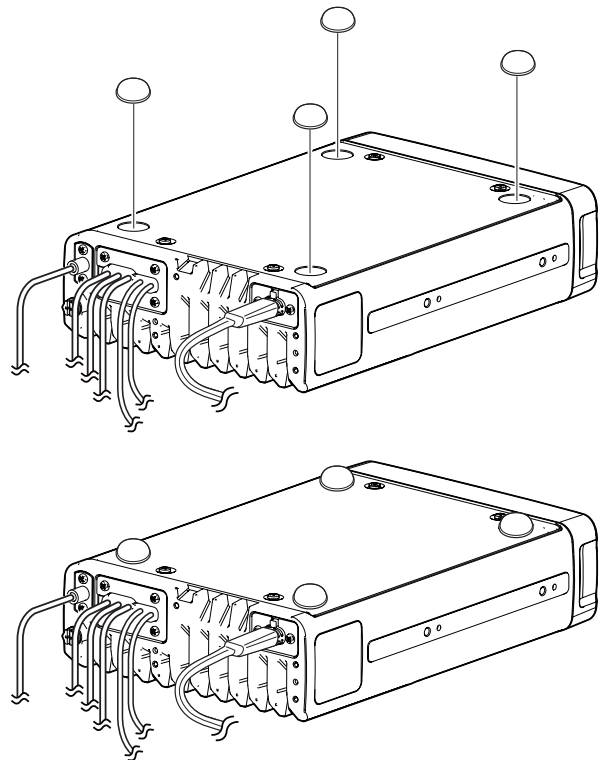

■ Connections

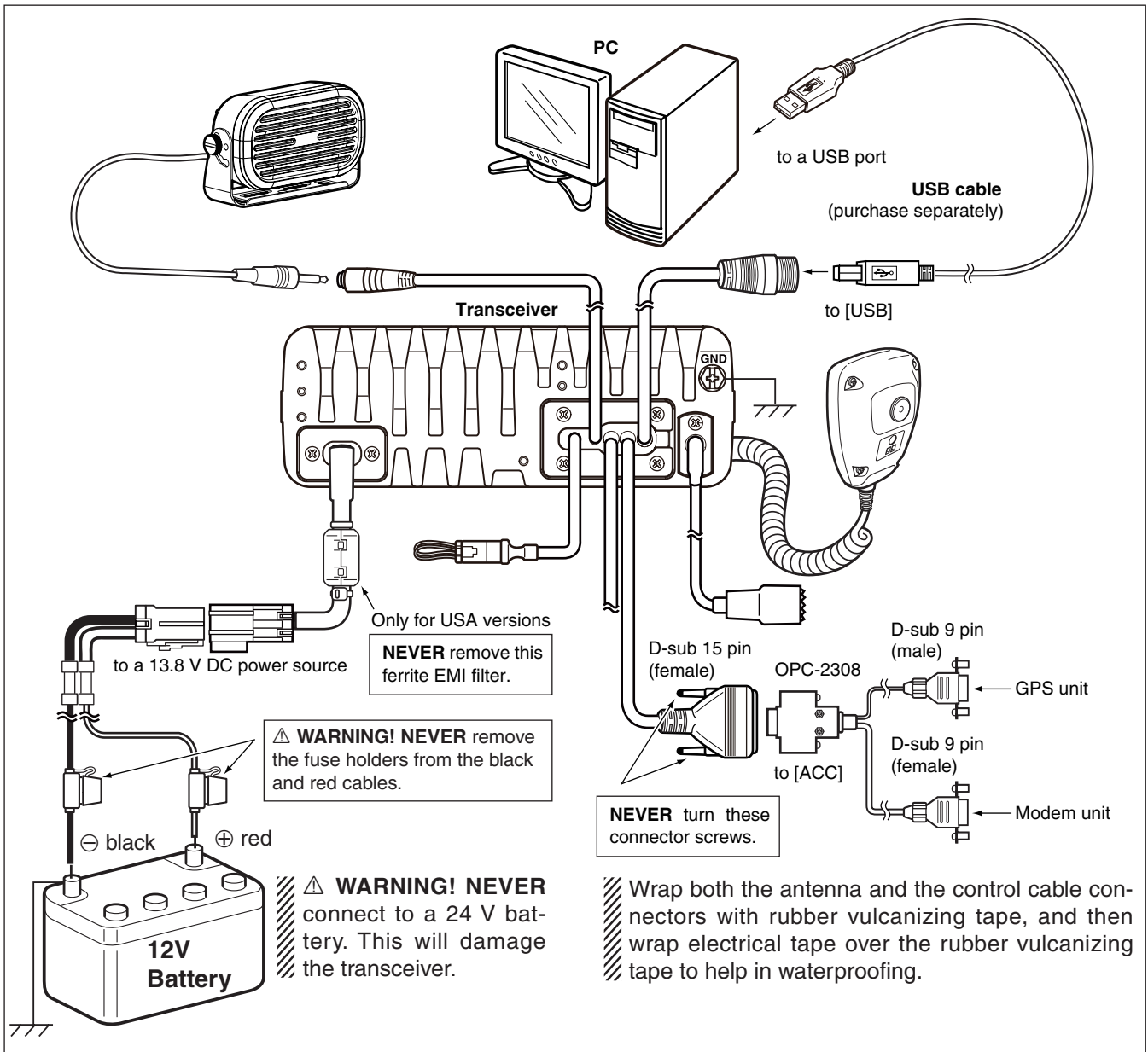

• CW key connection

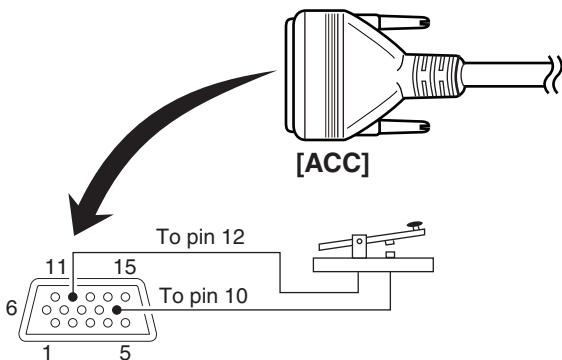

• FSK connection

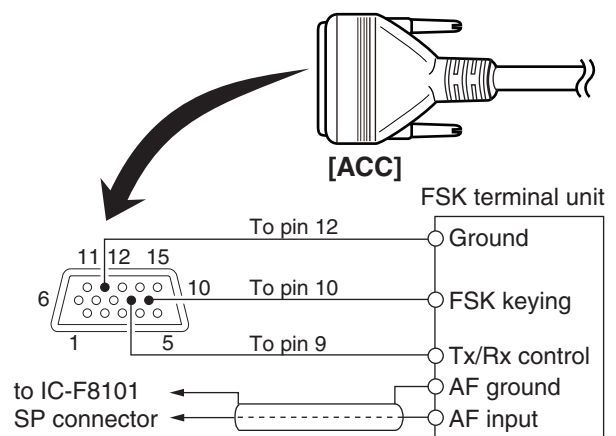

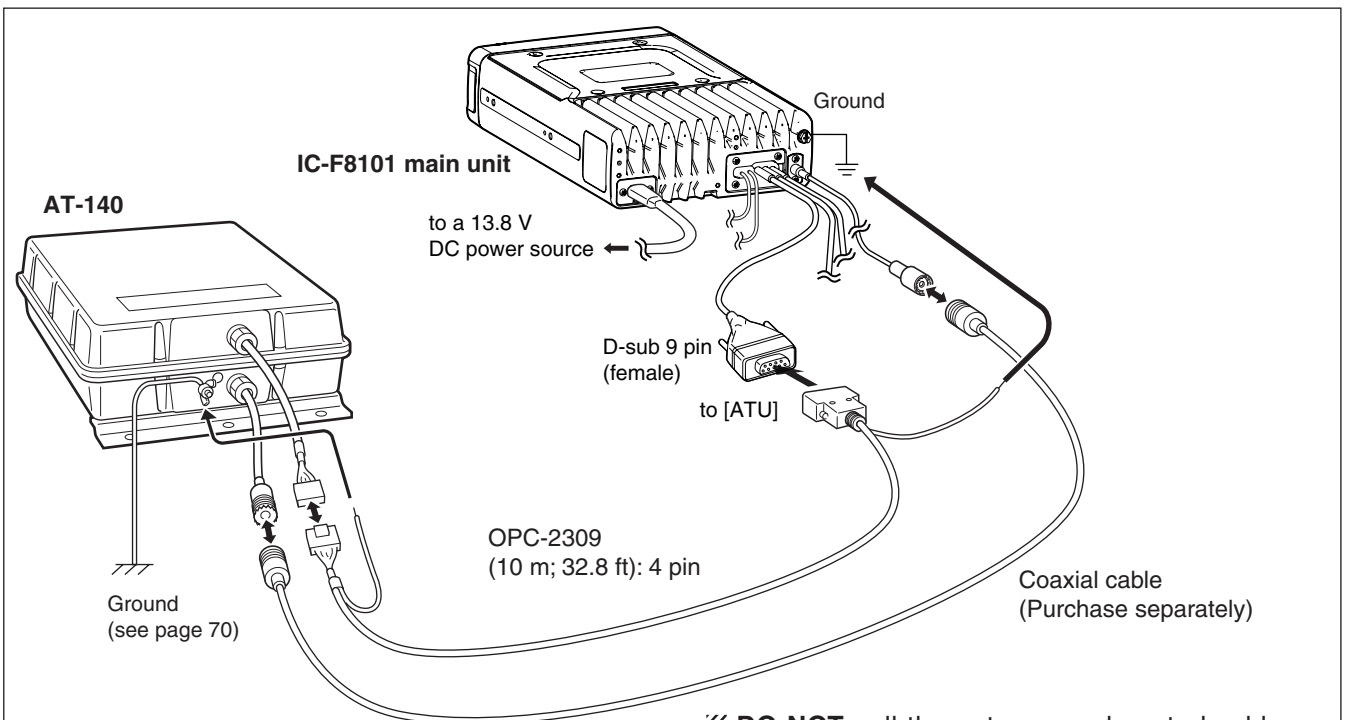

DO NOT pull the antenna and control cable receptacles. This may cause a cable disconnection (in the tuner unit), inside connector damage or a bad connection.

Wrap both the antenna and the control cable connectors with rubber vulcanizing tape, and then wrap electrical tape over the rubber vulcanizing tape to help in waterproofing.

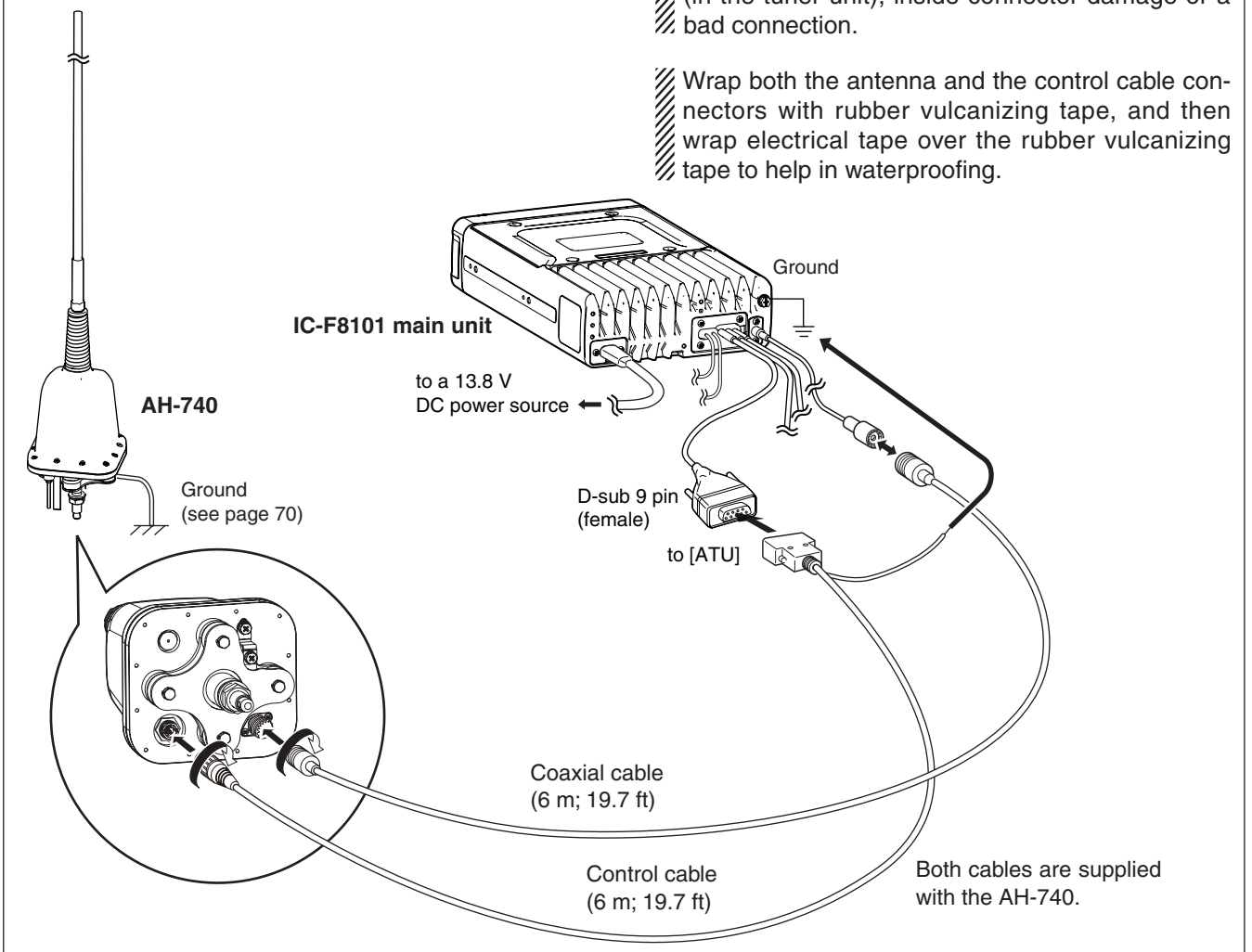

■ Ground connection

The transceiver and antenna tuner MUST have an adequate RF ground connection. Otherwise, the overall efficiency of the transceiver and antenna tuner installation will be reduced. Electrolysis, electrical shocks and interference from other equipment could also occur.

For best results, use a 50 or 75 mm (2 or 3 inches) wide copper strap, and make the connection as short as possible. Ground the transceiver and antenna tuner to the same ground point, otherwise the voltage difference (at the RF level) between two ground points may cause electrolysis.

⚠ WARNING! When grounding to a metal hull
 Use Zinc anodes to protect the hull from electrolysis.
 Ask your dealer, technical installer or refer to a technical book, and so on, for RF grounding details.

Best ground points

- External ground plate
- Copper screen
- Copper foil

Unusable ground points

(These connections may cause an explosion or electrical shock)

- Gas or electrical pipe
- Fuel tank or oil-catch pan

• Ground system example

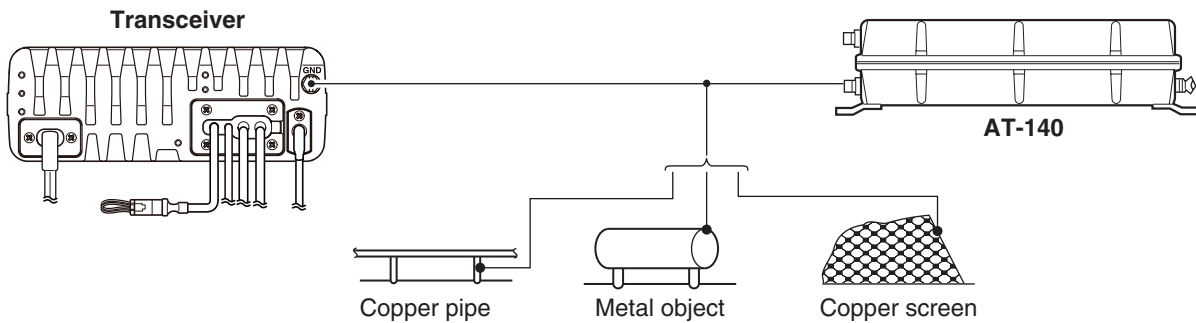

• About the ground strap connection for the AH-740

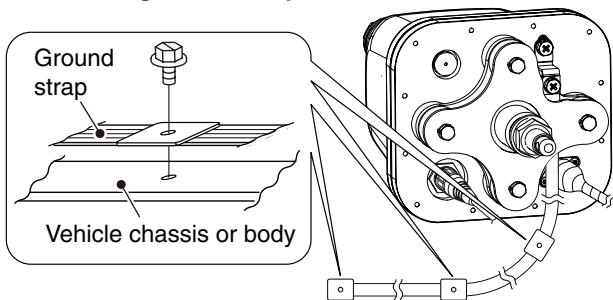

Power source

The transceiver requires regulated DC power of 13.8 V and at least 28 A. There are two ways to supply power:

- Direct connection to a 12 V battery in your vehicle through the supplied DC power cable.
- Use a DC power supply connected to an AC outlet.

DC power cable connection

NOTE: Use terminals for the cable connection.

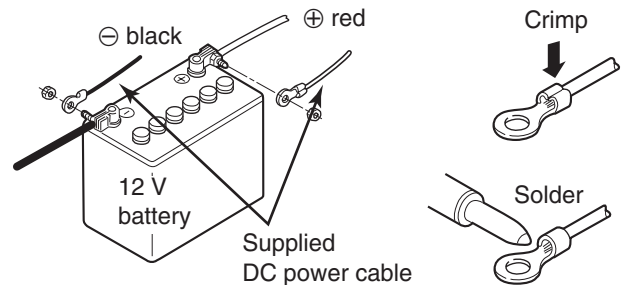

Antenna

Most stations operate with a whip or long wire (insulated back stay) antenna. However, these antennas cannot be connected directly to the transceiver since their impedance may not match with the transceiver antenna connector.

DANGER HIGH VOLTAGE!
NEVER touch the antenna element/wire while tuning or transmitting.

◇ AT-140 AUTOMATIC ANTENNA TUNER

See page 69.

◇ AH-740 AUTOMATIC TUNING ANTENNA

See page 69.

◇ Non-Icom tuner

Some non-Icom tuners may be used with the IC-F8101. Please consult your dealer if you wish to use one.

CFU-F8100 (Optional Cooling Fan)

① Attach the Cooling fan to the transceiver's heat-sink, and tighten the 4 supplied M3 × 8 mm screws.

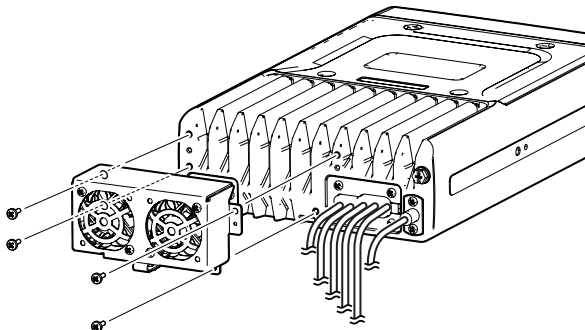

② Secure the connector and cables using the supplied cable tie.

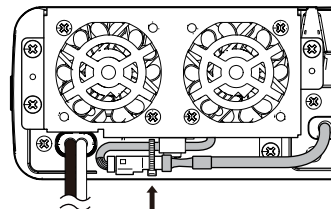

For Users in California (U.S.A.)

This CR1632 Lithium Battery contains Perchlorate Material—special handling may apply.

See <http://www.dtsc.ca.gov/hazardouswaste/perchlorate>

■ RMK-6 (Optional Separation kit)

The RMK-6 allows you to install the IC-F8101's Front panel separately from the Main unit for added installation convenience and operation. Use either the optional OPC-607, OPC-608, OPC-609 or OPC726 SEPARATION CABLE with the RMK-6.

The RMK-6 is the same as the one supplied in the Separated type transceiver.

◇ Supplied Accessories

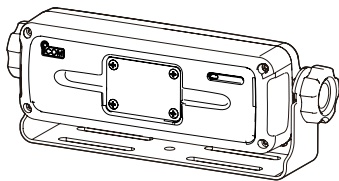

RMK-6 with Mounting bracket

Flat washers (M5)



Mounting screws (M5 × 12 mm)



Cable clamps (Screws M2.6 × 5 mm)



Spring washers (M5)



Self-tapping screws (M5 × 16 mm)



Hex socket screws

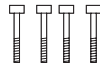

Nuts (M5)



Screws (M3 × 8 mm)



◇ Separation

The optional OPC-607 (3 m; 9.8 ft), OPC-608 (8 m; 26.2 ft), OPC-609 (1.9 m; 6.2 ft) or OPC-726 (5 m; 16.4 ft) SEPARATION CABLE is required for separately installing the transceiver Front panel and Main unit.

- ① First, make sure the transceiver's power is OFF, then disconnect the DC power cable.
- ② Remove the knob bolts and mounting bracket from the RMK-6.

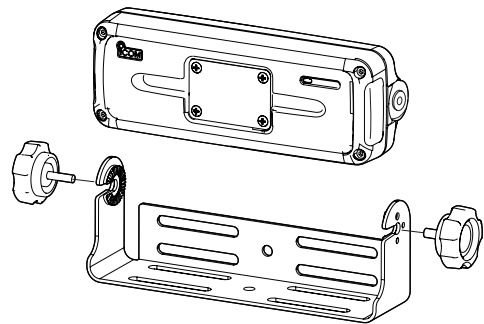

- ③ Unscrew the 4 hex socket screws using an allen wrench, then remove the Front panel from the transceiver in the direction of the arrow.
 - Separate the RMK-6's Front panel attachment and Main unit attachment in the same way.

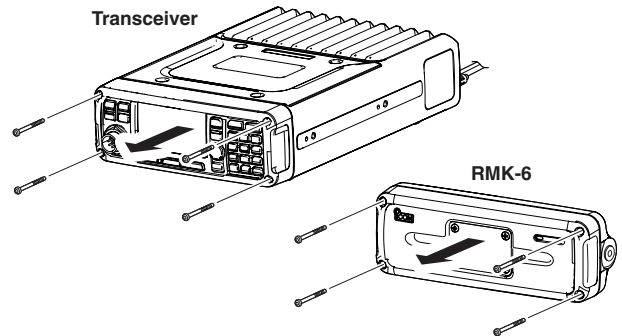

- ④ Disconnect the connection cable from the Front panel.

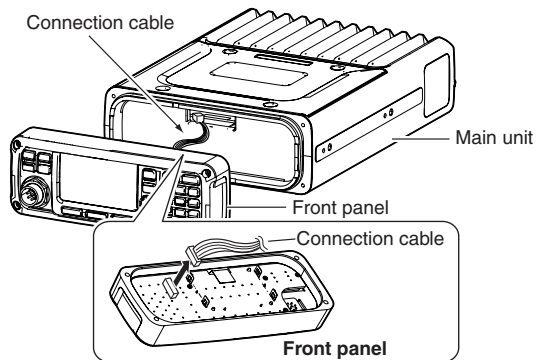

- ⑤ Unscrew the 4 rear plate screws, then remove the rear plates from both the front panel and Main unit attachments.

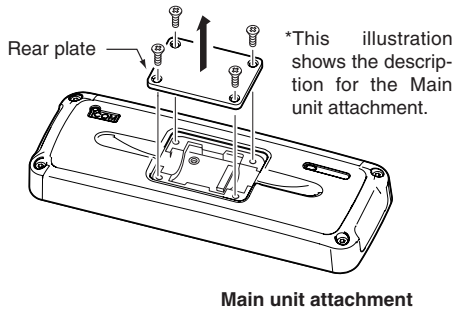

- ⑥ Connect either the OPC-607, OPC-608, OPC-609 or OPC-726 separation cable to the Main unit attachment, as shown below. After the connecting the cable, replace the rear plate and the 4 screws.
- The separation cable can be inserted into either the left or right grooves on the back of the attachment.

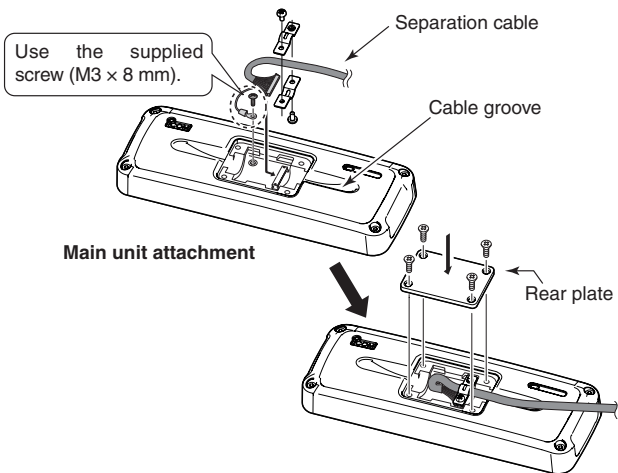

- ⑦ Connect the connection cable coming from the RMK-6, as shown below. Then tighten the 4 hex socket screws.

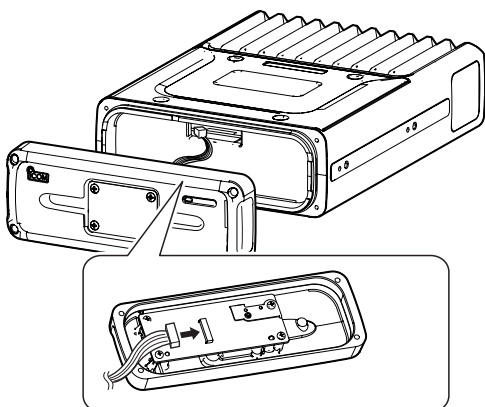

- ⑧ Connect the other end of the Separation cable to the front panel attachment, as shown below. After the cable connection, replace the removed rear plate and the 4 screws.
- The separation cable can be inserted into either the left or right grooves on the back of the attachment.

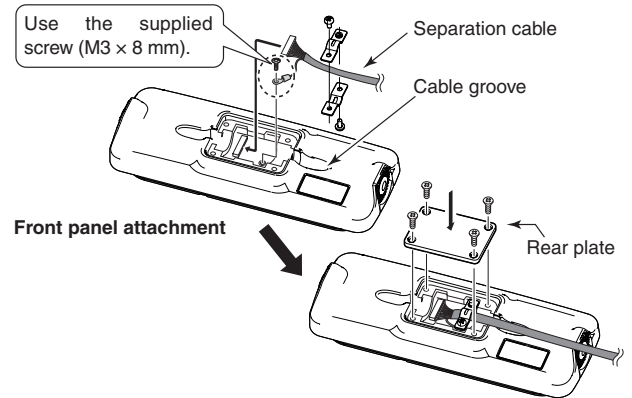

- ⑨ Connect the connection cable coming from the RMK-6, as shown below. Then tighten the 4 hex socket screws.

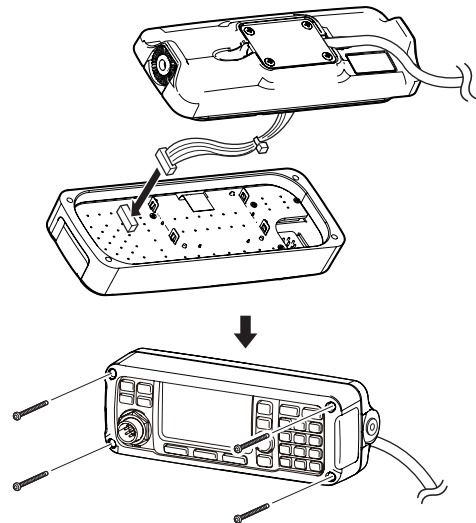

■ HM-192 (Optional Remote control microphone)

The HM-192 allows you to remotely control the transceiver by using the microphone instead of the Front panel*. Use either the optional OPC-607, OPC-608, OPC-609 or OPC-726 SEPARATION CABLE.

The HM-192 is the same as the one supplied in the Remote control microphone type transceiver.

*When the HM-192 is connected, the Front panel can not be used.

◇ Mounting

The optional OPC-607 (3 m; 9.8 ft), OPC-608 (8 m; 26.2 ft), OPC-609 (1.9 m; 6.2 ft) or OPC-726 (5 m; 16.4 ft) SEPARATION CABLE is required to install the transceiver's Main unit and Remote control microphone.

- ① Unscrew the 4 rear plate screws, then remove the rear plates from both the Extension MIC connector and the Main unit attachment.

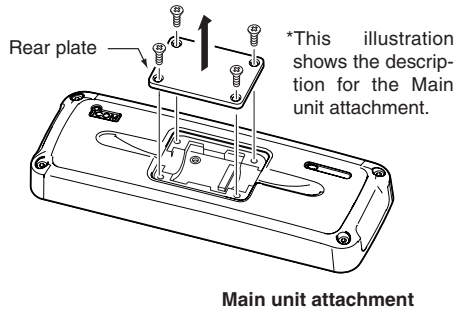

- ② Connect either the OPC-607, OPC-608, OPC-609 or OPC-726 separation cable to the Main unit attachment, as shown below.

After connecting the cable, replace the rear plate and the 4 screws.

- The separation cable can be inserted into either the left or right grooves on the back of the attachment.

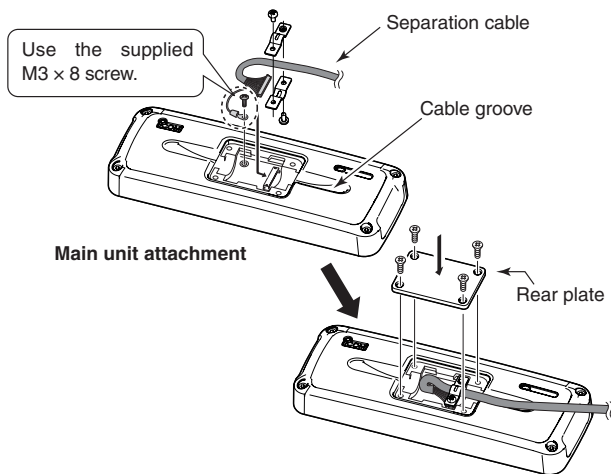

- ③ Connect the other side of the Separation cable to the Extension MIC connector, as described in step ②. After the cable is connected, replace the rear plate and the 4 screws.

- ④ Attach the Extension MIC connector to the desired place, then tighten the 2 supplied screws (M4 x 20 mm).

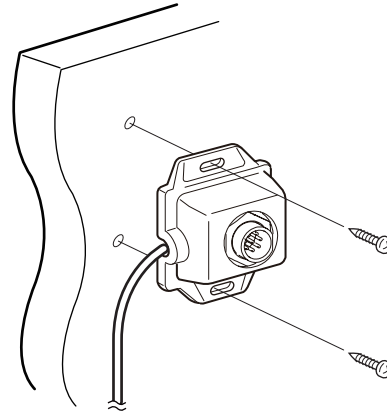

- ⑤ Attach the holder base to the desired place near the Extension MIC connector, then tighten the 2 supplied screws (M4 x 20 mm).

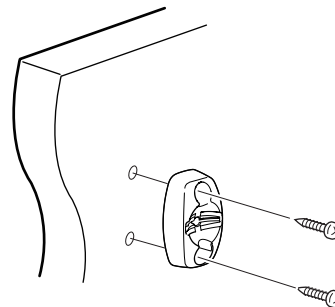

- ⑥ Adjust the MIC holder angle, then tighten the one supplied M4 x 14 mm screw.

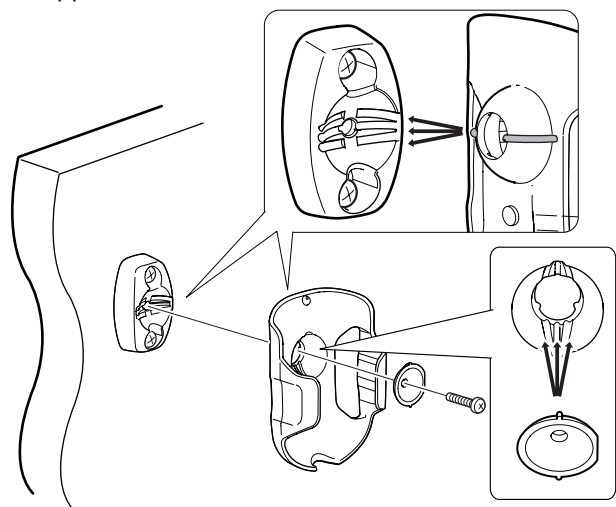

- ⑦ Connect the HM-192 to the Extension MIC connector.

■ Mounting

◇ Mounting location

Select a location that can support the weight of the transceiver and does not interfere with driving.

NEVER place the main unit or remote controller where normal operation of the vehicle may be hindered, or where it could cause bodily injury.

NEVER place the main unit or remote controller where air bag deployment may be obstructed.

DO NOT place the main unit or remote controller where hot or cold air blows directly onto it.

DO NOT place the main unit or remote controller in direct sunlight.

◇ Mounting the controller or speaker

Check the installation angle; the display may not be easy to read at some angles.

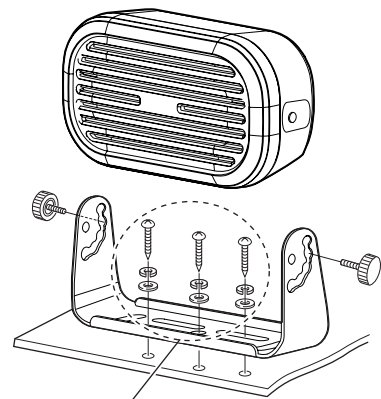
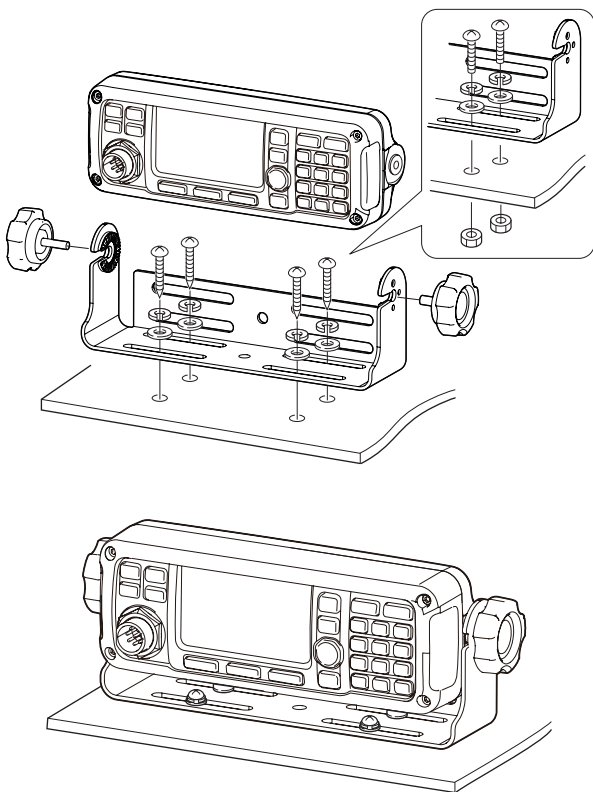

These screws are shown as mounting examples only.

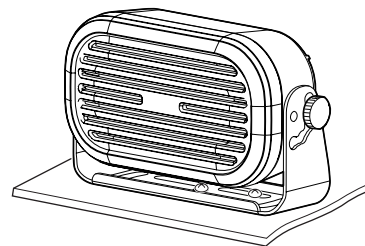

◇ **MB-126 (Optional mounting bracket)**

An optional mounting bracket MB-126 is used to mount the transceiver or transceiver's Main unit onto a flat surface.

- ① Attach the mounting plates and tighten the 2 supplied M5 × 8 mm screws on each side.

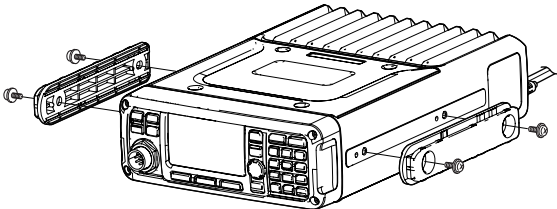

- ② Place the mounting bracket on the board, and then tighten the 4 supplied screws.

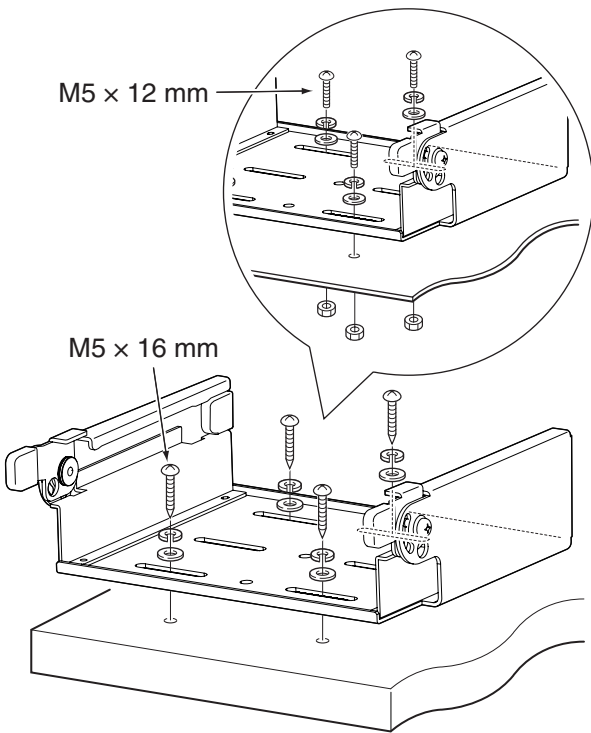

⚠ WARNING! Mount the mounting bracket to a surface that can support more than 10 kg (22 lb). The unit must be mounted on only a flat hard surface.

When using the M5 × 16 mm tapping screws: Mount the mounting bracket to a board that is more than 20 mm (0.8 inches) thick.

When using the M5 × 12 mm screws: Mount the mounting bracket to a board to which you can firmly tighten the screws with the washers and nuts.

- ③ Attach the Main unit to the mounting bracket, as shown below.

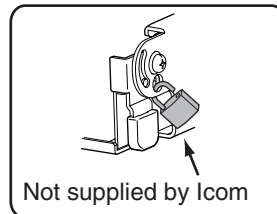
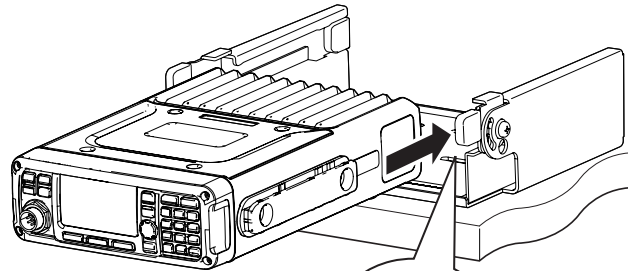

Attention to mount on the board:
If the supplied rubber feet are attached to the Main unit (p. 67), remove them before attaching it to the mounting bracket. Otherwise the feet get stuck, and you cannot slide the Main unit into the bracket.

- ④ The completed mounting should look like this.

• **Surface mounting**

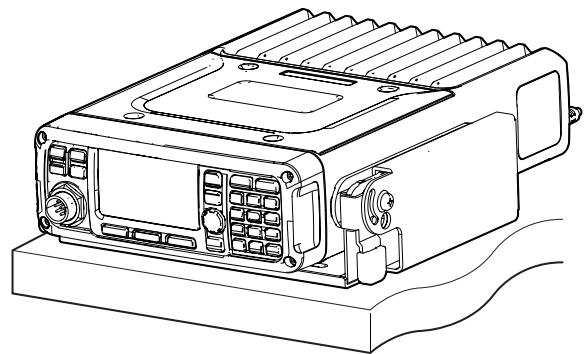

• **Overhead mounting**

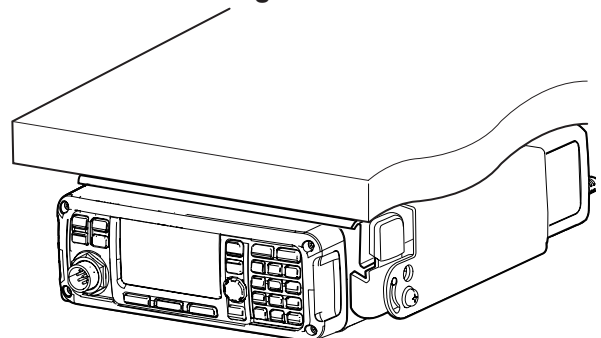

■ Fuse replacement

If a fuse blows, or the transceiver stops functioning, find the source of the problem, and repair it. Then replace the damaged fuse with a new, adequately rated fuse.

⚠ WARNING! Turn OFF the power and disconnect the DC power cable from the transceiver before performing any work on the transceiver. Otherwise, there is a danger of electric shock, equipment damage and/or fire or injury.

The IC-F8101 has two fuse types installed for transceiver protection.

- DC power cable ATC 30 A
- Circuitry fuse MINI BLADE 5 A

◇ DC power cable fuse replacement

Refer to the figure below for the DC power cable fuse replacement.

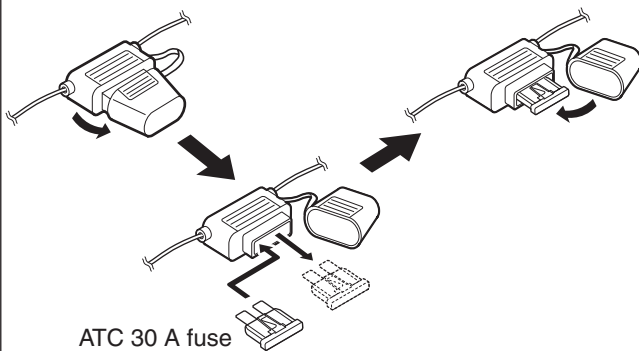

6

◇ Internal fuse replacement

- ① Turn the transceiver upside down.
- ② Unscrew 4 screws from the bottom cover, then remove the cover.

- ③ Replace the circuitry fuse as shown in the diagram below.
 - Use the supplied MINI BLADE 5 A fuse.

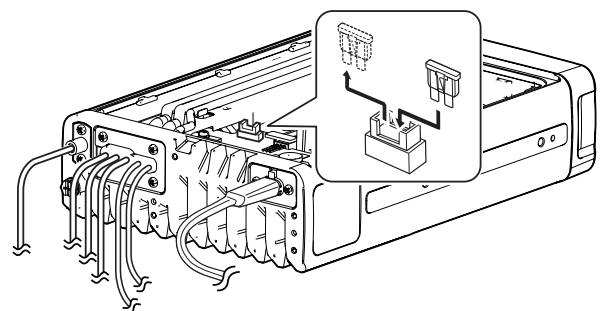
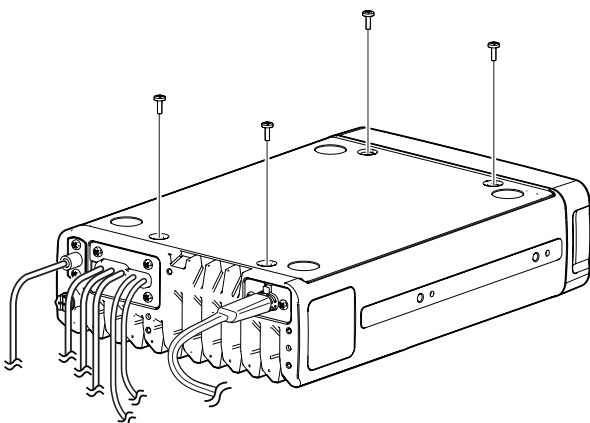

- ④ Reattach the bottom cover to its original position.

■ Connector information

ACC	Pin	Pin name	Description	Specification
	1	CI-V	—	—
	2	AF IN	Input terminal for the AF signal.	Input sensitivity (Data mode): More than 52.5 W at 100 mV
	3	AF OUT	Output terminal for the AF signal.	Output level: 200 to 400 mVrms when receiving Data mode
	4	AF GND	Ground line for the AF signal.	—
	5	GPS RXD	Input terminal for receive data from GPS unit.	NMEA0183
	6	NC	—	—
	7	RELAY	Goes to ground when transmitting.	Less than 100 mV
	8	EALC	ALC voltage input.	Control sensitivity (at -3 V input): More than 40 dB suppression
	9	MODPTT	PTT input terminal. When grounded, transmits.	Input voltage: Less than 0.8 V for transmit
	10	CW KEY	CW and FSK keying input.	CW: Less than 0.6 V for transmit RTTY: Open=Mark
	11	EALARM	Output terminal for the Alarm signal.	Output current: 12 mA±10% Open collector
	12	GND	Connect to ground.	—
	13	NC	—	—
	14	NC	—	—
	15	NC	—	—

ATU	Pin	Pin name	Description	Specification
	1	KEY	Key signal input.	—
	2	START	Start/bypass signal output.	—
	3	13.8V	13.8 V output for Antenna tuner.	13.8 V, maximum 2 A
	4	13.8V	13.8 V output for Antenna tuner.	13.8 V, maximum 2 A
	5	GND	Connect to ground.	—
	6	GND	Connect to ground.	—
	7	NC	—	—
	8	NC	—	—
	9	NC	—	—

■ Connector information for OPC-2308

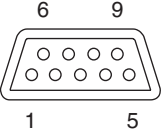
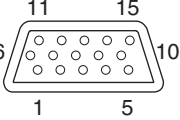
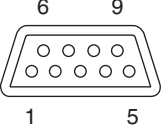
	Pin	Pin name	Pin	
 <p>D-sub 9 pin (Male)</p>	1	NC	—	 <p>D-sub 15 pin (Male)</p>
	2	GPS RX	5	
	3	NC	—	
	4	NC	—	
	5	GND	12	
	6	NC	—	
	7	NC	—	
	8	NC	—	
	9	NC	—	
 <p>D-sub 9 pin (Female)</p>	1	CI-V	1	
	2	MODPTT	9	
	3	NC	—	
	4	NC	—	
	5	NC	—	
	6	AF OUT	3	
	7	AF IN	2	
	8	AF GND	4	
	9	GND	12	

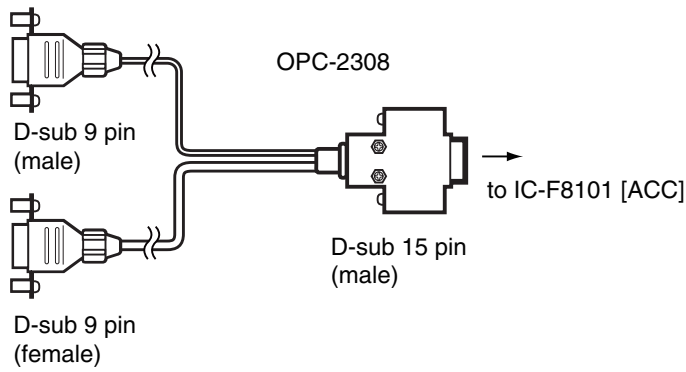

◇ General

- Frequency coverage:

Receive	0.5–29.9999 MHz
Transmit	1.6–29.9999 MHz
- Mode:

AUS versions	J3E (USB), A3E (AM) RX only
Other versions	J3E (USB/LSB), A3E (AM) A1A (CW), F1B (FSK), J2B (D1, D2, D3)
- No. of memory Ch.: 500 channels (maximum)
- Usable temp. range: –30°C to +60°C;
–22°F to +140°F
- Frequency stability: ±0.3 ppm (–30°C to +60°C;
–22°F to +140°F)
- Antenna impedance: 50 Ω
- Power supply: 13.8 V DC (negative ground)

AUS versions	10.8–15.6 V DC
Other versions	11.73–15.87 V DC
- Current drain:

Transmit	Less than 28 A (at maximum power)
Receive	Less than 3.0 A (at maximum audio)
- Dimensions (projections are not included):

Main/Front package	62(H)×174(W)×259(D) mm 2.4(H)×6.9(W)×10.2(D) in
--------------------	----------------------------------------------------
- Weight (approximately):

Main/Front package	3.9 kg, 8.6 lb
--------------------	----------------

◇ Transmitter

- Output power (typical):

AUS versions	
J3E	HIGH 100 W p-p MID 50 W p-p LOW 10 W p-p
Other versions	
J3E/A1A	HIGH 125 W p-p MID 50 W p-p LOW 10 W p-p
A3E	HIGH 30 W Carrier MID 12.5 W Carrier LOW 3 W Carrier
F1B/J2B	HIGH 75 W MID 50 W LOW 10 W
- Spurious emission:

USA versions	64 dB below peak output power
Other versions	64 dB (typical) below peak output power
- Carrier suppression: 50 dB
below peak output power
- Unwanted sideband suppression:

400 Hz	55 dB below peak output power
1 kHz	65 dB below peak output power
- Duty cycle:

Normal conversation	100% (–30°C to +60°C; –22°F to +140°F)
Continuous Data mode	25% (–30°C to +30°C; –22°F to +86°F)
All mode with Fan (CFU-F8100) is active	
	100% (–30°C to +45°C; –22°F to +113°F)

◇ Receiver

- Sensitivity:

J3E (Pre Amp ON)	
(0.5–1.5999 MHz)	14 dBμV (10 dB S/N)
(1.6–29.9999 MHz)	–14 dBμV (10 dB S/N)
A3E	
(0.5–1.5999 MHz)	22 dBμV (10 dB S/N)
(1.6–29.9999 MHz)	6 dBμV (10 dB S/N)
- Spurious response rejection ratio: More than 70 dB
- AF output power (at 13.8 V DC): More than 4.0 W at 10%
distortion with a 4 Ω load
- Clarifier range: ±200 Hz

AT-140 AUTOMATIC ANTENNA TUNER



Antenna and control cable receptacles for easy installation, and a tuner bypass function is available.

AH-740 AUTOMATIC TUNING ANTENNA

High performance, automatic high-speed tuning antenna.

- Frequency coverage
With 1.54 m whip antenna:
2.5 MHz–29.9999 MHz
With AH-5NV:
2.2 MHz–29.9999 MHz



AH-760 AUTOMATIC TUNING ANTENNA

High performance, automatic high-speed tuning antenna.

- Frequency coverage
With 1.54 m whip antenna:
1.6 MHz–29.9999 MHz
With AH-5NV:
1.6 MHz–16.0000 MHz



HM-192 #12

REMOTE CONTROL MICROPHONE

The same as that supplied with the IC-F8101 Remote control microphone type. Allows you to remotely control the transceiver with the microphone. The HM-192 requires either the OPC-607, OPC-608, OPC-609 or OPC-726 separation cable.

HM-193 HAND MICROPHONE

The same as that supplied with the IC-F8101 One package type or Separated type.

OPC-607/OPC-608/OPC-609/OPC-726

SEPARATION CABLE

- OPC-607: 3 m (9.8 ft)
- OPC-608: 8 m (26.2 ft)
- OPC-609: 1.9 m (6.2 ft)
- OPC-726: 5 m (16.4 ft)

OPC-2308 SHIELDED CONTROL CABLE

The shielded control cable protects the transceiver from RF feedback and connects a GPS unit or a modem unit to the transceiver.

OPC-2309 SHIELDED CONTROL CABLE

The shielded control cable protects the transceiver from RF feedback and extends the separation between the AT-140 and the transceiver up to 10 meters (32.8 feet).

RMK-6 SEPARATION KIT

The same as that supplied with the IC-F8101 Separated Type.

Allows you to install the transceiver front panel separate from the Main unit for operating convenience. The RMK-6 requires either the OPC-607, OPC-608, OPC-609 or OPC-726 separation cable.

SP-10, SP-25, SP-30, SP-35/35L

EXTERNAL SPEAKERS

A mounting bracket is supplied with the speaker.

- Impedance: 4 Ω
- Max. AF input: 5 W (SP-10)
- 7 W (SP-25, SP-35/35L)
- 30 W (SP-30)

AH-5NV NVIS KIT

Approximately 4.5 m (14.8 ft) long antenna.

- Frequency coverage
With AH-740: 2.2 MHz – 29.9999 MHz
With AH-760: 1.6 MHz – 16.0000 MHz

CFU-F8100 COOLING FAN

MB-126 MOUNTING BRACKET

Count on us!

