



VHF FM TRANSCEIVER

IC-H16

UHF FM TRANSCEIVER

IC-U16

OWNER'S MANUAL

FOREWORD

Congratulations on your purchase of the ICOM IC-H16/IC-U16, the most advanced VHF/UHF portables on the Land Mobile market today.

Utilizing sophisticated computer based technology and ICOM's precision VHF/UHF engineering, the IC-H16/IC-U16 incorporates state-of-the-art design concepts to meet the demanding needs and requirements of the Land Mobile user.

TABLE OF CONTENTS

SECTION	1	FEATURES	1
SECTION	2	SPECIFICATIONS	3
SECTION	3	ACCESSORIES.....	5
SECTION	4	PRE-OPERATION	6
SECTION	5	CONTROL FUNCTIONS.....	9
SECTION	6	GENERAL OPERATION.....	17
SECTION	7	MAINTENANCE.....	27
SECTION	8	OPTIONS	28

SECTION 1 FEATURES

1. MICROCIRCUIT TECHNOLOGY

Employing an on-board, high-technology microcomputer, the IC-H16/IC-U16 provides the maximum number of features for flexibility in addition to uncompromising performance and reliability in one compact package.

2. 16 SYNTHESIZED CHANNELS

Incorporating a unique data entry system, the IC-H16/IC-U16 can store up to 16 channels in memory with any combination of duplex or talk around frequencies. Because it is synthesized, there is never any need to purchase costly crystals for channel changes.

3. RUGGED CONSTRUCTION

Constructed with an all metal chassis, stainless steel battery slide rails, reinforced die-cast aluminum back as well as moisture and dust resistant seals, the IC-H16/IC-U16 is built to stand up to the most demanding environments.

4. HIGH OUTPUT POWER

The IC-H16 and IC-U16 provide a full 3 watts and 2.5 watts of output respectively, or 5 watts of output with the optional IC-CM7 battery pack.

5. POWER SAVER

Incorporated into the IC-H16/IC-U16 is a unique POWER SAVER circuit which places the radio in a "sleep" condition to conserve battery life when no signals are received or transmitted.

6. SCANNING

The IC-H16/IC-U16 can scan all programmed channels and will stop on received signals. Specific channels which you may not wish to scan can be deleted from the scanning sequence. Additionally, one channel can be given priority status and signals received on this channel would therefore be monitored regardless of other busy channels.

7. CTCSS ENCODER/DECODER

Up to 32 independent transmit and receive CTCSS tones can be programmed into the 16 memory channels allowing maximum flexibility for use on many repeater systems.

8. LCD READOUT

The multifunction, easy-to-read liquid-crystal display indicates the channel number and channel scanning order in addition to TX, RX, TONE, LOCK and CALL annunciators. A backlight is provided for viewing in low light conditions.

9. DTMF TONE GENERATOR

Included with the IC-H16/IC-U16 is a DTMF circuit that generates the standard telephone dial tones. This circuit is controlled from the front panel keyboard.

10. SLIDE-ON BATTERY

The supplied IC-CM8 is a high-capacity, rechargeable nickel cadmium battery pack which slides on or off the IC-H16/IC-U16 for easy removal or installation. A one button quick release lock is provided to prevent unwanted removal.

SECTION 2 SPECIFICATIONS

GENERAL

	LOW	HIGH
Frequency range	: IC-H16: 136 ~ 144MHz	* 148 ~ 174MHz
	IC-U16: 450 ~ 490MHz	480 ~ 512MHz
Number of channels	: 16 channels (keyboard programmable)	
	Simplex, semi-duplex operation	
Usable temperature	: $-30^{\circ}\text{C} \sim +60^{\circ}\text{C}$ ($-22^{\circ}\text{F} \sim +140^{\circ}\text{F}$)	
Channel spacing	: 25kHz	
Frequency stability	: $\pm 0.0005\%$	
Antenna impedance	: 50 ohms unbalanced	
Power supply requirement	: 8.4V DC with IC-CM8 attendant power pack (negative ground)	
Current drain	: Transmit : 1150mA approx.	
	Receive : 160mA approx.	
	Standby : 65mA approx.	
	(30mA with power saver)	
Dimensions	: 65(74)mm(W) x 196(207)mm(H) x 38(41)mm(D)	
	Bracketed values include projections.	
Weight	: 595g including IC-CM8 power pack.	

RECEIVER

Receiving system	:	Double-conversion superheterodyne
Modulation acceptance	:	F3E 16K0 (16F3)
Intermediate frequency	:	1st: 21.8MHz 2nd: 455kHz
Sensitivity	:	Less than 0.4 μ V for 12dB SINAD
Audio output power	:	500mW minimum at 10% distortion with 8 ohm load.
Audio output impedance	:	8 ohms

TRANSMITTER

		IC-CM8 battery pack	IC-CM7 (optional) battery pack
Output power (HIGH power position)	:	IC-H16: 3.0W IC-U16: 2.5W	5.0W 5.0W
(LOW power position)	:	IC-H16: 0.3W IC-U16: 0.5W	0.5W 0.5W
Emission mode	:	F3E 16K0 (16F3)	
Modulation system	:	Variable reactance frequency modulation	
Microphone	:	Built-in electret condenser microphone	

***NOTE:** The antenna supplied with the IC-H16 HIGH version is tuned for the band center but covers the entire 148MHz ~ 174MHz range. For even better efficiency when operating on channels close to the band edges, two other optional antennas are available. Ask your authorized ICOM dealer or service center for more information.

SECTION 3 ACCESSORIES

UNPACKING

Carefully remove your transceiver from the packing carton and examine it for signs of shipping damage. Notify the delivering carrier or dealer immediately, stating full details, should any damage be apparent. We recommend you keep the shipping carton for storing, moving or reshipping the transceiver if necessary. Accessory hardware, cables, etc., are packed with the transceiver. Make sure you have removed all equipment and parts before discarding the packing material.

Accessories included with the IC-H16/IC-U16:

1. IC-CM8 power pack. 1
(Attached to the set)
2. CM-16U wall charger 1
3. Flexible antenna* 1
4. Belt clip 1
5. Belt clip screws 2
6. Belt clip plastic washers 2
7. Earphone. 1
8. Handstrap 1
9. External speaker plug. 1
10. External microphone plug 1
11. Rainproof cap 1
12. DC power plug 1

* Both IC-H16 and IC-U16 antennas shown. One antenna per transceiver supplied.

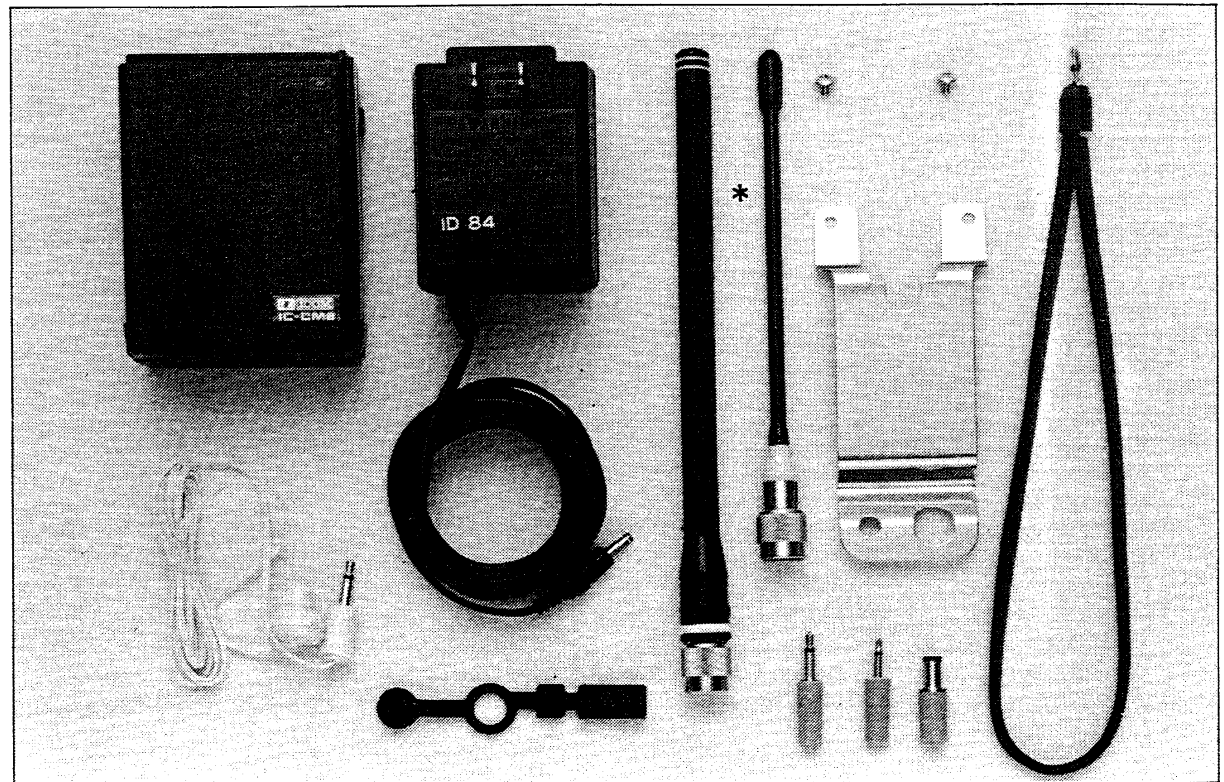

SECTION 4 PRE-OPERATION

BATTERY CHARGING

BATTERY PACK NOTE:

The full charge capacity of NiCd batteries may be reduced if repeatedly charged with only partial discharge periods. This is called the battery memory effect. If the battery capacity seems lower than when new, discharge the pack completely through normal use, then charge fully using the proper charger.

BATTERY PACK PRECAUTIONS

Prior to using the transceiver for the first time, the battery pack must be fully charged for optimum life and operation.

Connect the supplied CM-16U wall-charging adapter or the optional IC-CM1 cigarette lighter cable to the appropriate jack on the sides of the battery pack and charge for 15 hours. Be careful not to charge for more than 15 hours as damage could result.

When using the optional CM-35 or CM-60 drop-in chargers, the charging time is approximately 1.5 hours.

It is not necessary for the IC-CM8 to be installed on the transceiver for charging, however, if it is, be sure to turn the radio OFF.

1. Never short the battery contacts as damage may result.
2. Never discard used batteries into fire.
3. Optimum charging occurs when the ambient temperature is from 0°C to 46°C (32°F to 114°F). Charging outside of these temperature limits reduces the efficiency and is not recommended.

Charger Connections

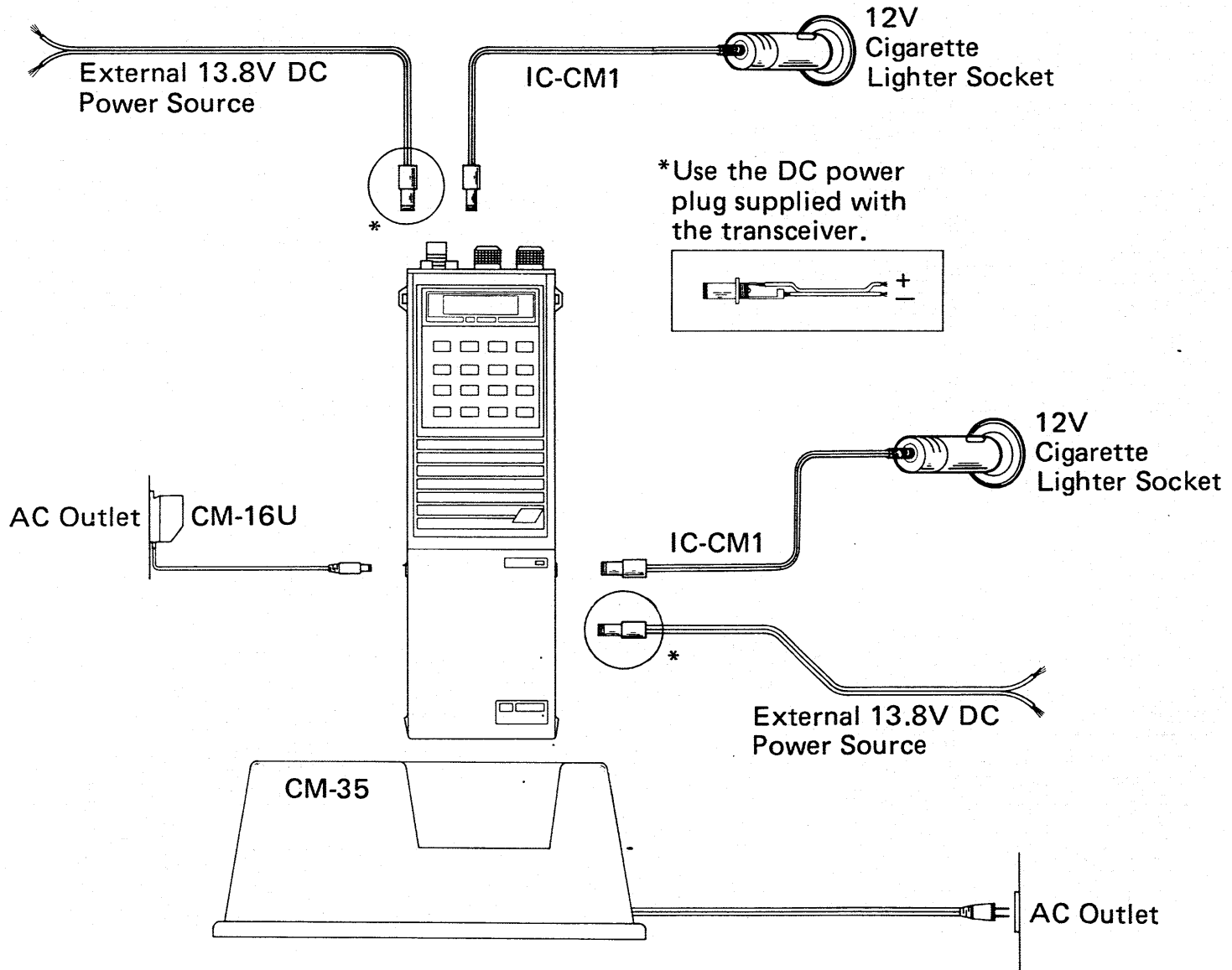

ANTENNA CONNECTION

Insert the connector on the flexible rubber antenna into the antenna connector on the top of the radio. Screw down securely.

For mobile operation, contact your nearest dealer for a high-performance magnetic mount or clip-on antenna.

BELT CLIP INSTALLATION

Attach the belt clip to the back panel using the two supplied screws and plastic washers.

CARRY HANDLE ATTACHMENT

Spread open and slide the ring of the hand strap over either of the projecting loops on the sides of the transceiver.

ATTACHMENT OF BELT CLIP AND HAND STRAP

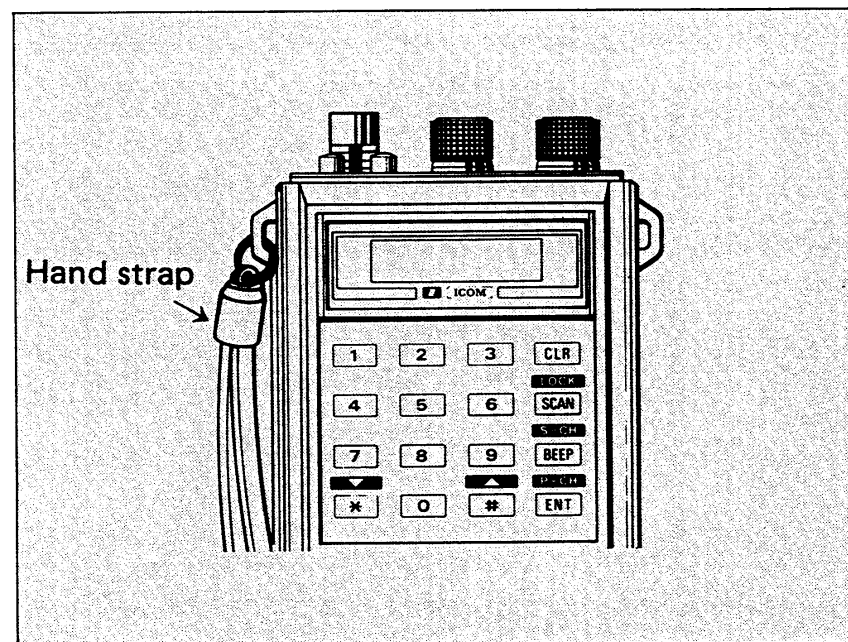
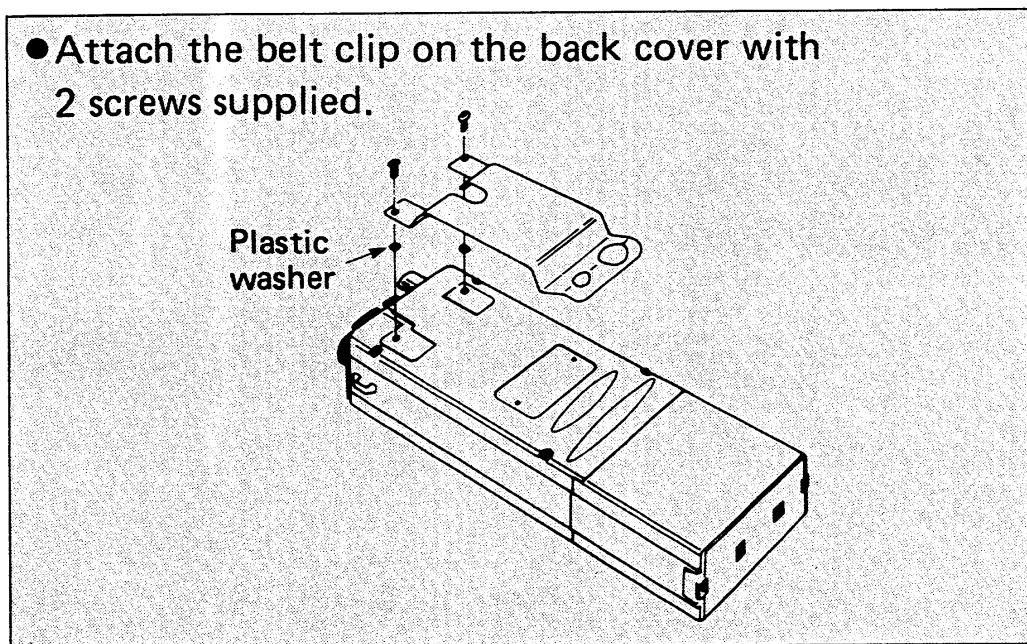

SECTION 5 CONTROL FUNCTIONS

TOP PANEL

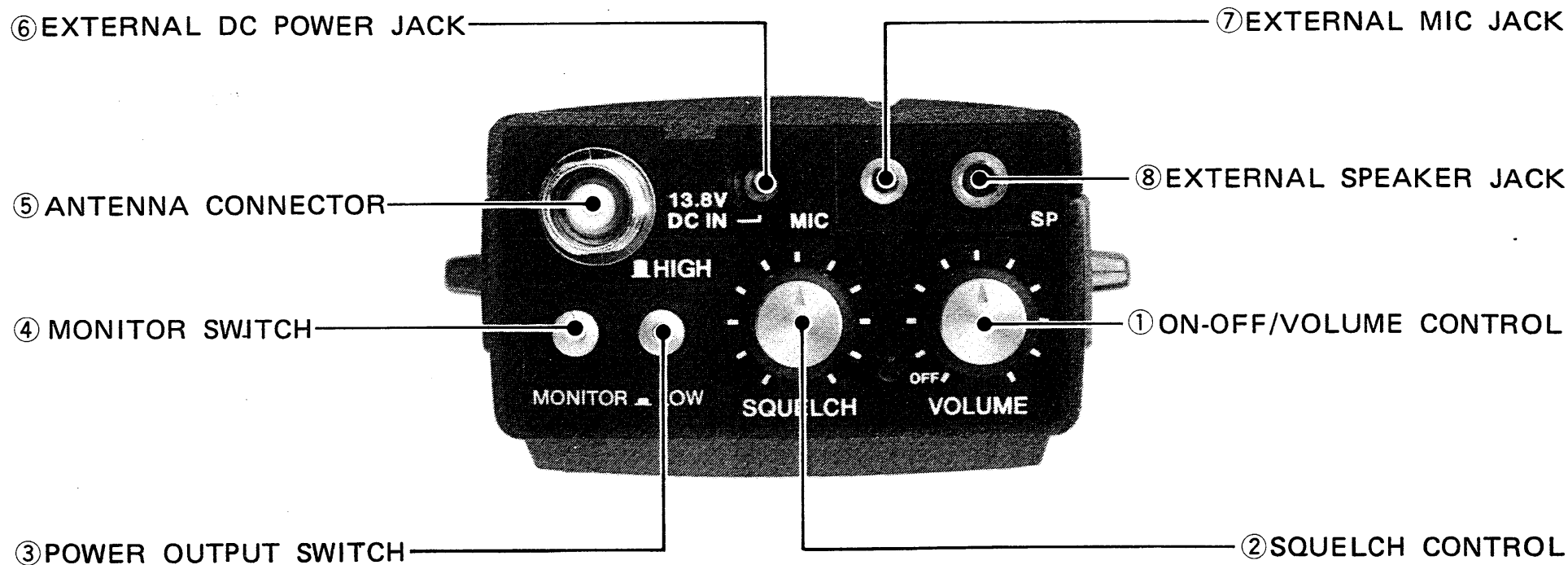

FRONT PANEL

REAR PANEL

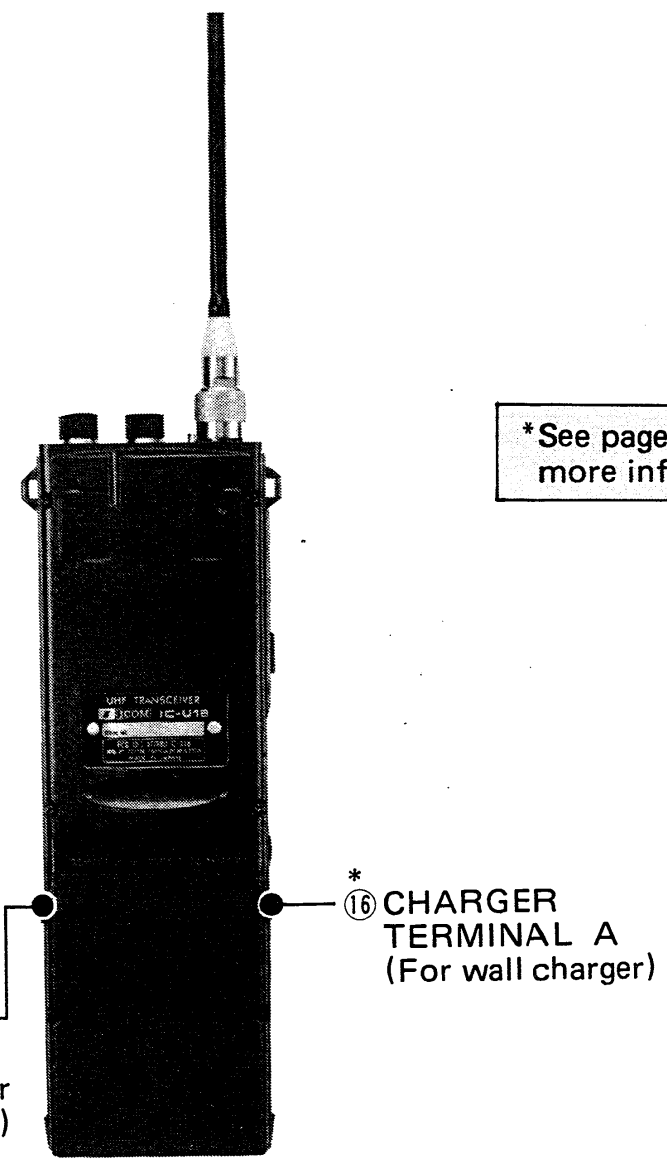
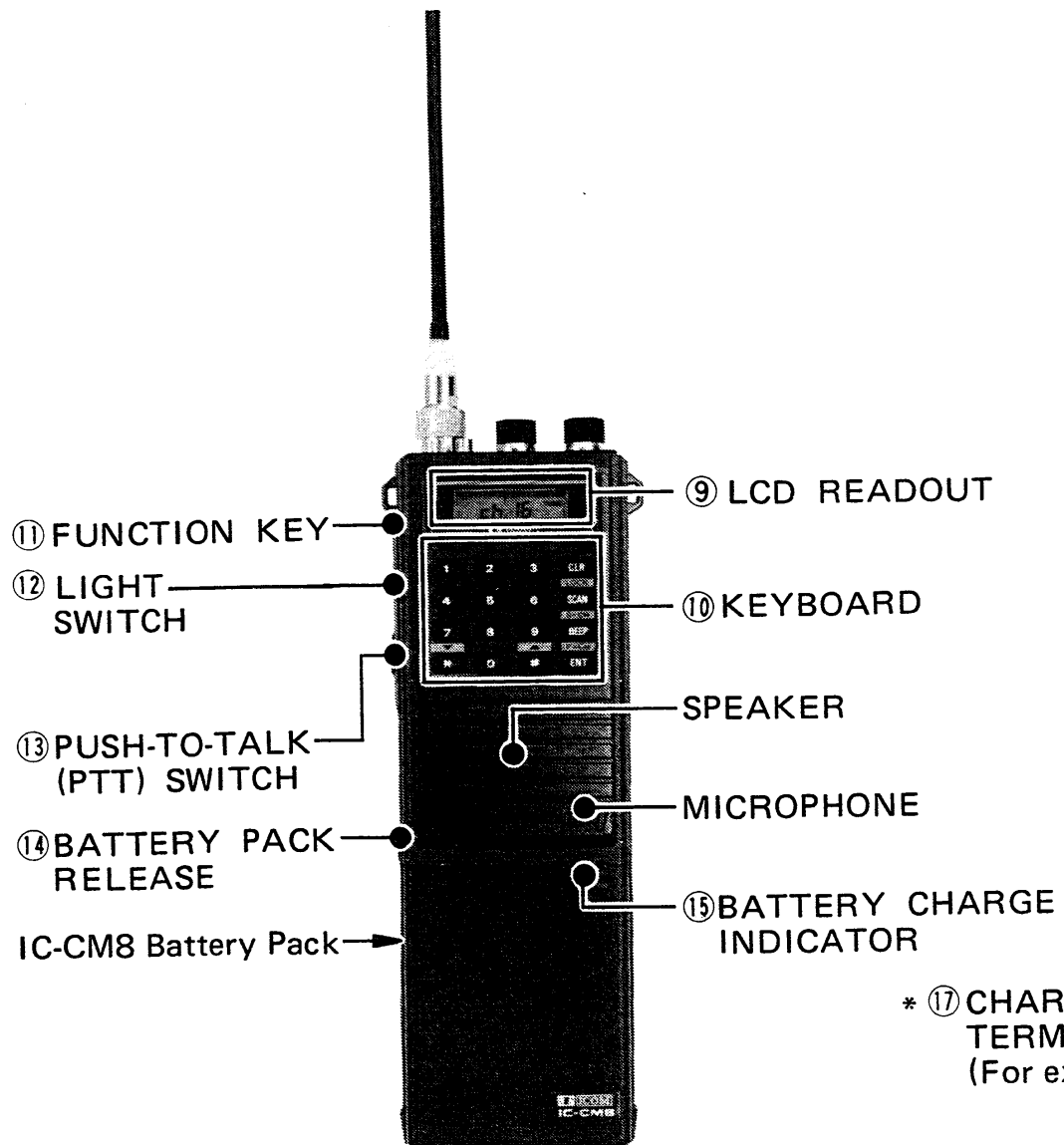

* See page 7 for more information

① ON-OFF/VOLUME CONTROL

Rotate clockwise to turn the radio ON and increase the volume level.

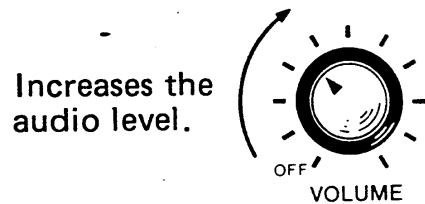

② SQUELCH CONTROL

Sets the squelch threshold level. Rotate this control completely counterclockwise to turn OFF the squelch function, and clockwise to raise the threshold level.

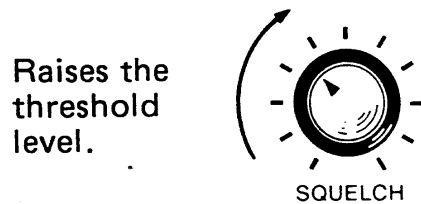

③ POWER OUTPUT SWITCH

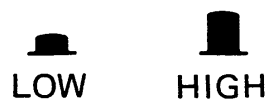

When this switch is depressed to the LOW position (IN), the output power is reduced which thus conserves battery life. When greater coverage or longer distance transmissions are needed, place the switch in the HIGH position (OUT) to provide full power. See page 4 for exact power levels.

④ MONITOR SWITCH

Push IN this locking switch in order to override the CTCSS decoder circuit when it is in the mute condition. For normal operation, leave the switch OUT (push again and release).

⑤ ANTENNA CONNECTOR

All antennas connected to the transceiver must be 50 ohms and have a TNC plug.

CAUTION: Transmitting without an antenna may damage the transmitter.

⑥ EXTERNAL DC POWER JACK

Connect the IC-CM1 cigarette lighter cable or external 13.8V DC power source to this jack for mobile operation. The IC-CM8 does not need to be installed for operation of the radio, however, if the battery pack is installed, it charges simultaneously.

⑦ EXTERNAL MIC JACK

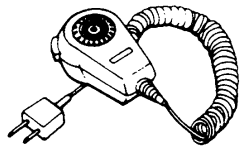

Speaker-microphone
IC-CM9 (optional)

The optional IC-CM9 speaker-microphone, optional HS-10 headset or the optional HS-15 boom mic can be connected for additional flexibility. (The HS-10 and HS-15 require the HS-10SA VOX unit or the HS-10SB PTT unit.) The built-in microphone is not functional when an external microphone is connected.

⑧ EXTERNAL SPEAKER JACK

Connect either an 8 ohm external speaker or the supplied earphone for private listening.

⑨ LCD READOUT

The display shows the operating channel, channel scanning sequence as well as TX, RX, LOCK, TONE, and CALL indicators.

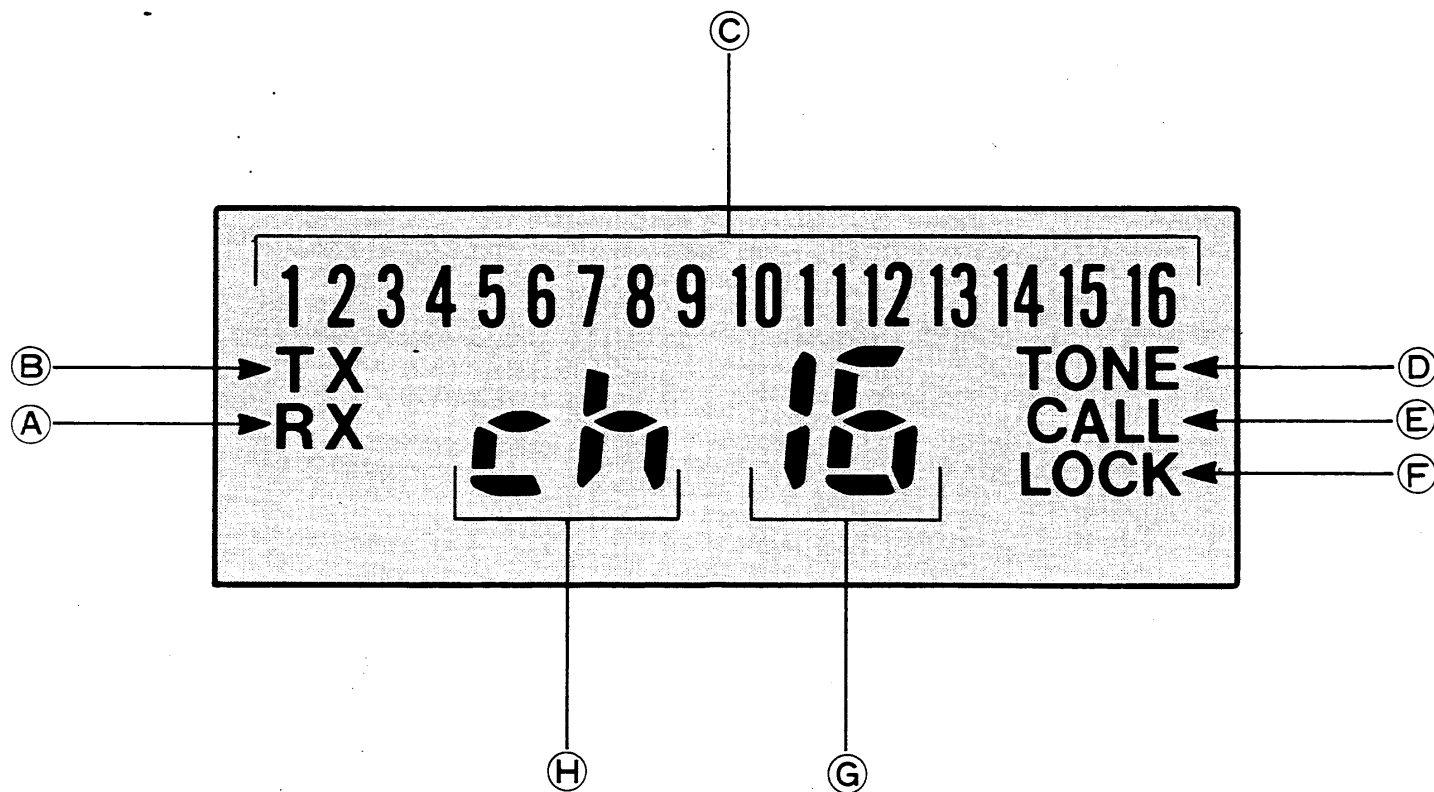

Ⓐ RECEIVE INDICATOR

"RX" appears when the set is in the receive mode.

Ⓑ TRANSMIT INDICATOR

"TX" appears when the set is in the transmit mode.

© SCAN/PRIORITY CHANNEL INDICATOR

The programmed channel numbers "1, 2, 3.....16" appear when the FUNC and BEEP switches are pushed. Those channels which are locked out do not appear. Also shows the priority channel number selected.

Ⓓ TONE INDICATOR

"TONE" appears when the built-in, subaudible tone encoder/decoder is programmed to operate on one of the channels. Only those receive signals accompanied by a special tone frequency are audible when this circuit is active.

Ⓔ CALL INDICATOR

"CALL" appears when a signal is received with the same subaudible tone as is programmed in the transceiver.

Ⓕ LOCK INDICATOR

"LOCK" appears when the keyboard has been deactivated to prevent unwanted keystroke entry.

Ⓖ CHANNEL NUMBER INDICATOR

Displays the operating channel number with 1 or 2 digits.

Ⓗ CHANNEL INDICATOR

Displays "ch" which represents the word "channel".

KEYBOARD

NOTE: The keyboard may also be used to generate DTMF tones. See page 25.

The keyboard has 16 keys consisting of ten numerical keys and six code keys. Some keys have dual functions.

The primary functions are available by simply pushing each key. The ten numerical keys input the number indicated on the key, whereas the code keys operate the various functions indicated on each key or above the key on a gray background.

The secondary functions are available by pushing each key while the FUNC key on the side of the transceiver is held down. Each secondary function is indicated above the key with letters on an olive background.

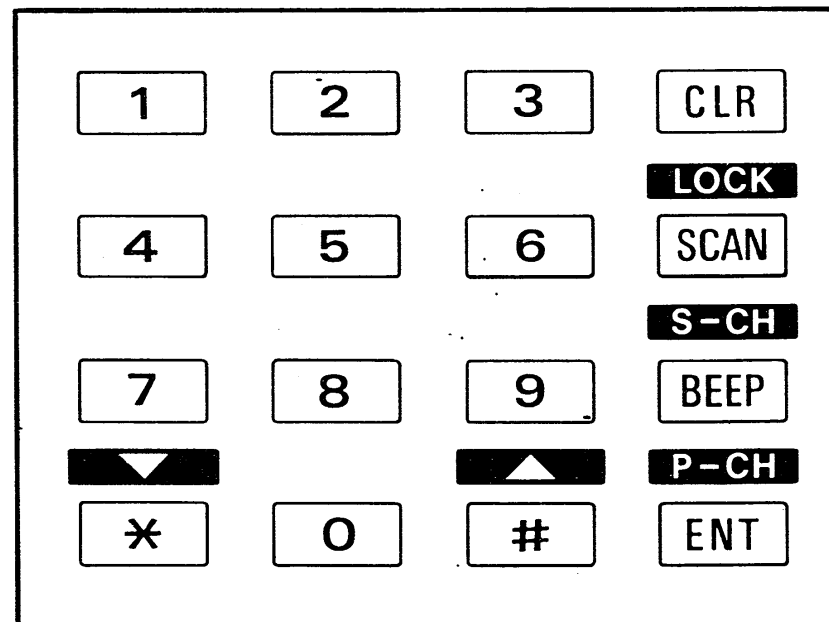

- ⑪ FUNCTION KEY Push this key to select the secondary function of each key.
- ⑫ LIGHT SWITCH Push this switch to turn ON the LCD readout light. The light remains ON only while the switch is held in.
- ⑬ PUSH-TO-TALK (PTT) SWITCH Push this switch to begin transmitting.
- ⑭ BATTERY PACK RELEASE Push the release button upwards, and slide the battery pack to the right to remove it from the transceiver.
- ⑮ BATTERY CHARGE INDICATOR Lights during battery charging with the CM-16U.
- ⑯ CHARGER TERMINAL A Connect the output plug from the supplied CM-16U wall charger here. See page 7.
- ⑰ CHARGER TERMINAL B Connect the output plug from an external 13.8V DC power source here. See page 7.

SECTION 6 GENERAL OPERATION

Verify that the ON-OFF/VOLUME control is in the OFF position before connecting power to the transceiver.

6-1 RECEIVING

- 1) Rotate the ON-OFF/VOLUME control clockwise beyond the "click".

NOTE: The small number at the top of the display indicates the priority channel selected. See SECTION 6 - 4 for more information.

Also, if the word "TONE" appears on the display, push the MONITOR switch while performing steps 2) and 3).

- 2) Rotate the SQUELCH control fully counterclockwise. Rotate the ON-OFF/VOLUME control clockwise for a comfortable listening level.
- 3) If only noise with no signal is heard from the speaker, rotate the SQUELCH control clockwise until the noise is quieted. This is the threshold point. The transceiver remains silent after this adjustment until a signal is received which opens the receiver's squelch circuit. If very weak signals are received, the squelch may open and close intermittently. In this case, rotate the SQUELCH control slightly more clockwise until the squelch operates correctly.

- 4) Select the desired channel. If a non-programmed channel is keyed in, this input is rejected and the display automatically reverts back to the previous channel.

EXAMPLE:

Select channel 6. Move to other channels.

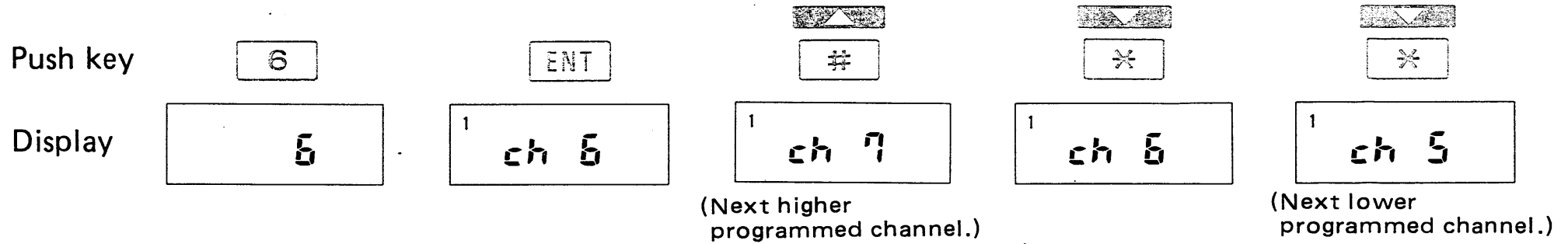























6 - 2 TRANSMITTING

- 1) Depress the PTT (push-to-talk) switch to begin transmitting. The letters "TX" appear on the display to indicate a signal is being transmitted.
- 2) Speak into the microphone using your normal voice level.
- 3) Release the PTT switch to return to the receive mode.

6-3 KEY FUNCTIONS

Some keys have dual functions. To select the secondary function, push the FUNC key located on the side of the transceiver, and then push the correct key for the function desired.

PRIMARY FUNCTION		SECONDARY FUNCTION	
KEY	FUNCTION	KEY	FUNCTION
	Inputs the digit 1.	-----	-----
	Inputs the digit 2.	-----	-----
	Inputs the digit 3.	-----	-----
	Inputs the digit 4.	-----	-----
	Inputs the digit 5.	-----	-----
	Inputs the digit 6.	-----	-----
	Inputs the digit 7.	-----	-----
	Inputs the digit 8.	-----	-----
	Inputs the digit 9.	-----	-----
	Inputs the digit 0.	-----	-----
	Decreases the operating channel number. Push the key once to select one channel number lower, or hold the key down to continuously shift downwards through the channels.	-----	-----

PRIMARY FUNCTION		SECONDARY FUNCTION	
KEY	FUNCTION	KEY	FUNCTION
	<p>Increases the operating channel number.</p> <p>Push the key once to select one channel number higher, or hold the key down to continuously shift upwards through the channels.</p>	-----	-----
	<p>Clears the scan function, and stops the scan at the displayed operating channel.</p>	-----	-----
	<p>Starts the scan function.</p> <p>Push this key to scan through all programmed channels.</p>	 	<p>Disables the keys to prevent accidental key operation..</p> <p>While holding the FUNC key down, push this key to clear the LOCK function.</p>
	<p>A beep tone is generated each time any key is pushed.</p> <p>Push the BEEP key once to turn the beep function ON. Push the key again to turn the function OFF.</p>	  (SCAN CHANNELS)	<p>Displays the channels to be scanned, and locks out channels not desired in the scanning sequence.</p> <p>While holding the FUNC key down, push this key:</p> <ol style="list-style-type: none"> 1) once to display the scan channels, 2) twice to alternately activate/deactivate the lockout function for the channel currently selected.
	<p>Selects the desired operating channel.</p> <p>Push this key after entering a channel number on the keyboard.</p>	  (PRIORITY CHANNEL)	<p>Assigns the most important channel with priority status during the scan.</p>

6 - 4 PROGRAMMING THE PRIORITY CHANNEL

The priority channel feature allows easy monitoring of your most important channel while still listening for signals on the other programmed channels.

- 1) Select an operating channel that you would like as the priority channel. Refer to SECTION 6 - 1 RECEIVING.
- 2) Push and hold the FUNC key, and then push the P-CH key. Release the FUNC key.
- 3) The selected operating channel is now the priority channel as indicated by the small number at the top of the display. The priority channel is automatically monitored when the scanning feature is used as explained in SECTION 6 - 5.

EXAMPLE:

Program channel 9 as the priority channel.
(previous priority channel was 5.)

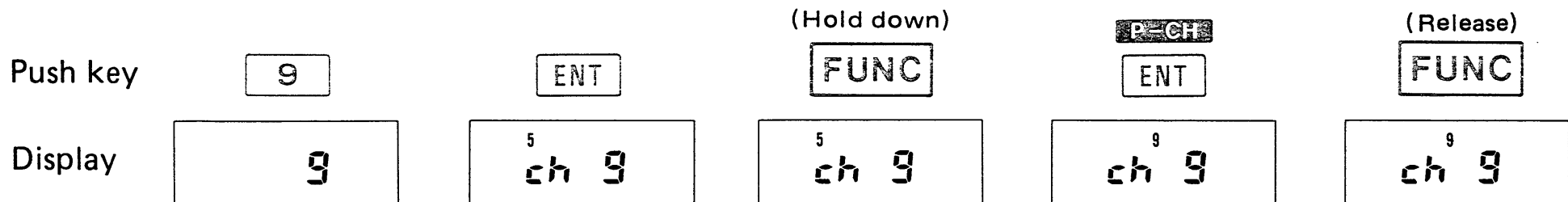

6 - 5 SCANNING

The IC-H16/IC-U16 is equipped with a scanning circuit designed to sample each of the programmed channels in a consecutive manner and stop to monitor only those channels which have communication on them.

- 1) Adjust the VOLUME and SQUELCH controls as explained in SECTION 6 - 1 RECEIVING.
- 2) Push the SCAN key to start the scan. The priority channel number begins blinking to indicate that scanning has started. If the SQUELCH is adjusted correctly, the scan halts when a receive signal opens the squelch circuit. Push the SCAN key again to resume scanning, or wait for the channel to clear and the scan automatically resumes.
- 3) Scanning begins from the displayed channel, and moves downwards through all programmed channels. The priority channel is automatically monitored briefly between each of the channels. On reaching the lowest programmed channel, the scan skips to the highest programmed channel and moves downwards again in a continuous loop.
- 4) When making a transmission while scanning, the transmit channel is the same as the channel on the display at the moment the PTT switch is pushed. After the transmission, the transceiver remains locked on the same channel.

- 5) Push the MONITOR switch while scanning to cancel the scan function and automatically select the priority channel. Or, push the CLR key or PTT switch to simply cancel the scan function.

EXAMPLE:

Scan all channels.

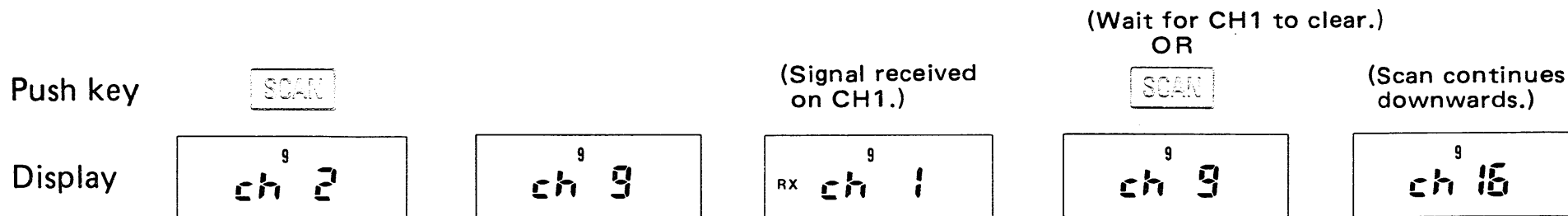

6-3 CHANNEL LOCK OUT.

This function allows you to selectively choose which channels the scanning function will monitor.

- 1) Select the channel you wish to delete from or add to the scan channels. See SECTION 6 - 1 RECEIVING.
- 2) Push and hold the FUNC key, and then push the S-CH key. The display shows all programmed scan channels which are not locked out. Push the S-CH key again to delete or add the channel selected in step 1). Release the FUNC key.

NOTE: The priority channel cannot be locked out.

EXAMPLE:

Lock out channel 14.

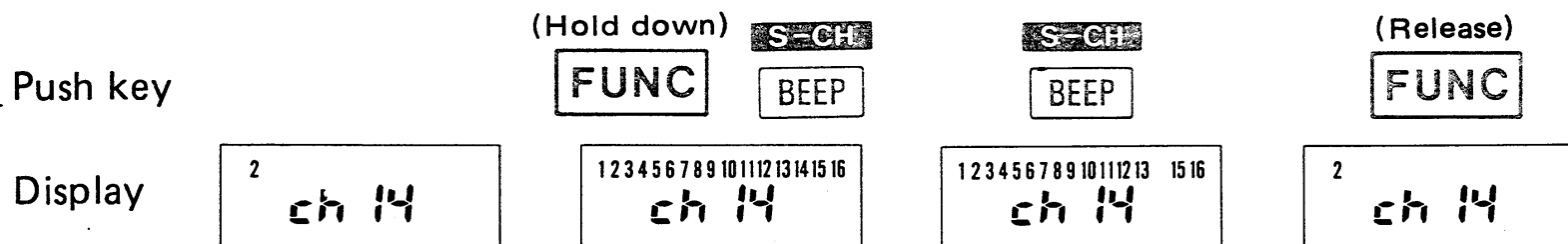

6 - 7 KEYBOARD LOCK FUNCTION

This feature prevents accidental changes of the operating channel or other functions selected from the keyboard.

- 1) Push and hold the FUNC key, and then push the LOCK key to activate the function.
- 2) The displayed channel is now locked. All keys on the keyboard are disabled.
- 3) To clear the lock function, push and hold the FUNC key, and then push the LOCK key again.

EXAMPLE:

Lock and unlock the keyboard.

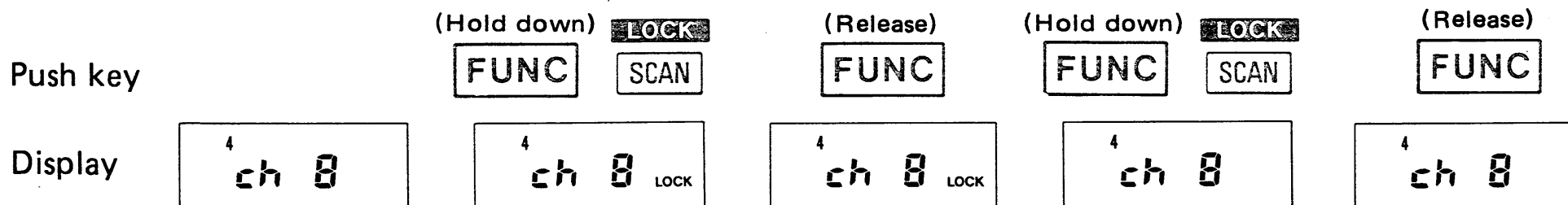

6 - 8 DTMF TONE GENERATOR

The front panel keyboard can also be used to generate the tones necessary for accessing a telephone system.

- 1) Push and hold the PTT (push-to-talk) switch.
- 2) Use the numbered keys on the keyboard to dial your desired number.

NOTE: After the first key is pushed, the PTT switch may be released. The radio automatically remains in the transmit mode if the keys are depressed successively without pausing.

- 3) The **CLR**, **SCAN**, **BEEP** and **ENT** keys generate the tones associated with the "A", "B", "C" and "D" keys, respectively, on a standard 16-key keyboard.

6 - 9 POWER SAVER FUNCTION

The IC-H16/IC-U16 contains a special circuit designed to save battery power when in the receive mode. This circuit begins operating automatically and causes the display to flash ON and OFF.

The power saver function cancels automatically if a signal is received, or if the PTT switch or any keys on the keyboard are pushed.

6 - 10 SPECIAL FEATURES

Following are several features available on your transceiver which can be easily programmed by a qualified technician. If you wish to incorporate or delete the following functions, visit your local ICOM dealer or authorized ICOM service center for further information.

TIME-OUT TIMER

Built into the IC-H16/IC-U16 is a special timer circuit which automatically turns the transmitter section OFF after a given period of time. When the transmitter is deactivated in this manner, the beep signal sounds and thus serves as an aid in keeping your transmissions brief.

TRANSMIT INHIBIT

When activated, this circuit mutes the transmitter and allows the radio to receive only. This is valuable for monitoring frequencies which you are not authorized to transmit on.

FREQUENCY PROGRAMMING

Incorporated in the IC-H16/IC-U16 is a sophisticated programming system which allows the programmed frequencies to be changed at any time or new frequencies to be added without changing crystals.

SECTION 7 MAINTENANCE

Your transceiver was quality-engineered and manufactured to provide years of trouble-free operation in many different environments.

On an annual basis, it is recommended that your IC-H16/IC-U16 be given a routine technical checkout to ensure optimum operation. Contact your ICOM dealer or authorized ICOM service center for this or any other required service.

If at any time your transceiver does not operate as described in this manual, turn the radio OFF and then ON again. This action resets the microprocessor in the transceiver and may eliminate your problem.

1) Rotate to OFF.



2) Rotate clockwise.



SECTION 3 OPTIONS

CM-60 DESK BATTERY MULTI-CHARGER

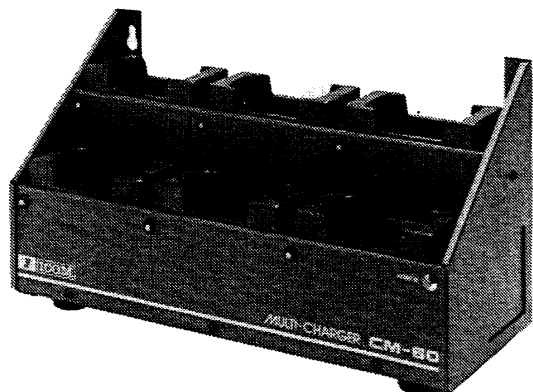

CM-35 DESK BATTERY CHARGER

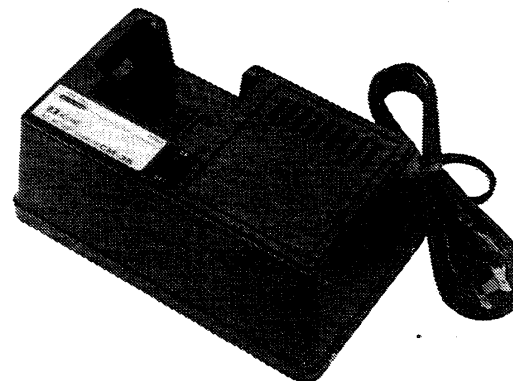

IC-CM9 SPEAKER-MICROPHONE



ANTENNAS FOR OTHER IC-H16
FREQUENCY RANGES





ICOM INCORPORATED
1-6-19, KAMIKURATSUKURI, HIRANO-KU,
OSAKA 547, JAPAN

A-0720A
Printed in Japan