



INSTRUCTION MANUAL

VHF FM TRANSCEIVER

IC-V8000



This device complies with Part 15 of the FCC rules. Operation is subject to the following two conditions: (1) This device may not cause harmful interference, and (2) this device must accept any interference received, including interference that may cause undesired operation.

Icom Inc.

FOREWORD

Thank you for purchasing this Icom product. The IC-V8000 VHF FM TRANSCEIVER is designed and built with Icom's superior technology and craftsmanship. With proper care, this product should provide you with years of trouble-free operation.

We want to take a couple of moments of your time to thank you for making your IC-V8000 your radio of choice, and hope you agree with Icom's philosophy of "technology first." Many hours of research and development went into the design of your IC-V8000.

◆ FEATURES

- *75 W* of high transmit output power*
(except Taiwan version)
- *Front mounted speaker for clear audio readability*
- *Tone squelch, DTCS squelch standard*
- *Dual color (amber & green) LCD backlight*
- *Remote control microphone available*
(optional for some versions)
- *Optional DTMF decoder*

IMPORTANT

READ ALL INSTRUCTIONS carefully and completely before using the transceiver.

SAVE THIS INSTRUCTION MANUAL— This instruction manual contains important operating instructions for the IC-V8000.

EXPLICIT DEFINITIONS

WORD	DEFINITION
⚠ WARNING!	Personal injury, fire hazard or electric shock may occur.
CAUTION	Equipment damage may occur.
NOTE	Recommended for optimum use. No risk of personal injury, fire or electric shock.

Icom, Icom Inc. and the ICOM logo are registered trademarks of Icom Incorporated (Japan) in the United States, the United Kingdom, Germany, France, Spain, Russia and/or other countries.

CAUTIONS

⚠ WARNING RF EXPOSURE! This device emits Radio Frequency (RF) energy. Extreme caution should be observed when operating this device. If you have any questions regarding RF exposure and safety standards please refer to the Federal Communications Commission Office of Engineering and Technology's report on Evaluating Compliance with FCC Guidelines for Human Radio frequency Electromagnetic Fields (OET Bulletin 65)

⚠ WARNING! NEVER connect the transceiver to an AC outlet. This may pose a fire hazard or result in an electric shock.

⚠ WARNING! NEVER operate the transceiver while driving a vehicle. Safe driving requires your full attention—anything less may result in an accident.

NEVER connect the transceiver to a power source of more than 16 V DC. This will ruin the transceiver.

NEVER connect the transceiver to a power source using reverse polarity. This will ruin the transceiver.

NEVER cut the DC power cable between the DC plug and fuse holder. If an incorrect connection is made after cutting, the transceiver may be damaged.

NEVER expose the transceiver to rain, snow or any liquids. The transceiver may be damaged.

NEVER operate or touch the transceiver with wet hands. This may result in an electric shock or ruin the transceiver.

NEVER place the transceiver where normal operation of the vehicle may be hindered or where it could cause bodily injury.

NEVER let objects impede the operation of the cooling fan on the rear panel.

DO NOT push the PTT when not actually desiring to transmit.

DO NOT allow children to play with any radio equipment containing a transmitter.

During mobile operation, **DO NOT** operate the transceiver without running the vehicle's engine. When the transceiver's power is ON and your vehicle's engine is OFF, the vehicle's battery will soon become exhausted.

BE CAREFUL! The transceiver will become hot when operating it continuously for long periods.

AVOID using or placing the transceiver in direct sunlight or in areas with temperatures below -10°C ($+14^{\circ}\text{F}$) or above $+60^{\circ}\text{C}$ ($+140^{\circ}\text{F}$).

AVOID the use of chemical agents such as benzine or alcohol when cleaning, as they can damage the transceiver's surfaces.

USE Icom microphones only (supplied or optional). Other manufacturer's microphones have different pin assignments and may damage the transceiver if attached.

SUPPLIED ACCESSORIES

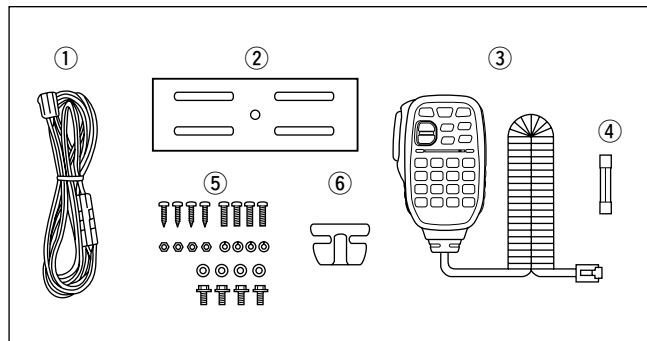

- ① DC power cable (3 m) 1
- ② Mobile mounting bracket 1
- ③ Microphone (HM-133V)* 1
- ④ Fuse (20 A) 1
- ⑤ Mounting screws, nuts and washers 1 set
- ⑥ Microphone hanger† 1

*HM-118N HAND MICROPHONE OR HM-118TN/TAN DTMF MICROPHONE supplied versions are also available.

†Depending on version.

TABLE OF CONTENTS

FOREWORD	i
IMPORTANT	i
EXPLICIT DEFINITIONS	i
CAUTIONS	ii
SUPPLIED ACCESSORIES	iii
TABLE OF CONTENTS	iii
QUICK REFERENCE GUIDE	I-VI
■ Installation	I
■ Your first contact	IV
■ Repeater operation	V
■ Programming memory	VI
1 PANEL DESCRIPTION	1-8
■ Front panel	1
■ Function display	3
■ Rear panel	5
■ Microphone (HM-133V)	6
■ Microphone keypad	7
2 SETTING A FREQUENCY	9-12
■ Preparation	9
■ Using the tuning dial	9
■ Using the keypad	10
■ Using the [▲]/[▼] keys	10
■ Tuning step selection	11
■ Lock functions	12
3 BASIC OPERATION	13-16
■ Receiving	13
■ Monitor function	13
■ Audio mute function	14
■ Squelch attenuator	14
■ Transmitting	15
■ Selecting output power	15
■ One-touch PTT function	16

4 REPEATER OPERATION	17–23		
■ Accessing a repeater	17	■ Transmitting a DTMF code	46
■ Subaudible tones	19	■ DTMF speed	47
■ Offset frequency	21	10 POCKET BEEP AND TONE SQUELCH	48–51
■ Repeater lockout	21	■ Pocket beep operation	48
■ Reverse duplex mode	22	■ Tone/DTCS squelch operation	50
■ Auto repeater	23	■ Tone scan	51
5 MEMORY OPERATION	24–34	11 PAGER/CODE SQUELCH	52–57
■ General description	24	■ Pager function	52
■ Memory channel selection	24	■ Code programming	52
■ Programming a memory channel	25	■ Pager operation	55
■ Transferring memory contents	27	■ Code squelch	57
■ Memory clearing	29	12 OTHER FUNCTIONS	58–70
■ Channel names programming	30	■ Set mode	58
■ Memory bank selection	32	■ Initial set mode	62
■ Memory bank setting	33	■ Weather channel operation	65
■ Transferring bank contents	34	■ Microphone keys	67
6 CALL CHANNEL OPERATION	35–36	■ Partial reset	68
■ Call channel selection	35	■ All reset	68
■ Call channel transferring	35	■ Data cloning	69
■ Programming a call channel	36	13 MAINTENANCE	71–73
7 SCAN OPERATION	37–42	■ Troubleshooting	71
■ Scan types	37	■ Fuse replacement	72
■ Scan start/stop	38	■ Optional unit installation	73
■ Scan edges programming	39	14 SPECIFICATIONS AND OPTIONS	74
■ Skip channel setting	41	15 MODE ARRANGEMENT	75–76
■ Scan resume condition	42		
8 PRIORITY WATCH	43–44		
■ Priority watch types	43		
■ Priority watch operation	44		
9 DTMF MEMORY ENCODER	45–47		
■ Programming a DTMF code	45		

1
2
3
4
5
6
7
8
9
10
11
12
13
14
15

QUICK REFERENCE GUIDE

■ Installation

◇ Location

Select a location which can support the weight of the transceiver and does not interfere with driving in any way. We recommend the locations shown in the diagram below.

NEVER place the transceiver where normal operation of the vehicle may be hindered or where it could cause bodily injury.

NEVER place the transceiver where air bag deployment may be obstructed.

DO NOT place the transceiver where hot or cold air blows directly onto it.

AVOID placing the transceiver in direct sunlight.

• Example— Installation location

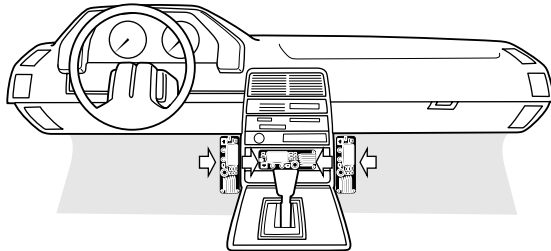

◇ Using the mounting bracket

- ① Drill 4 holes where the mounting bracket is to be installed.
 - Approx. 5.5–6 mm (1/4") when using nuts; approx. 2–3 mm (1/8") when using self-tapping screws.
- ② Insert the supplied screws, nuts and washers through the mounting bracket and tighten.
- ③ Adjust the angle for the clearest view of the function display.

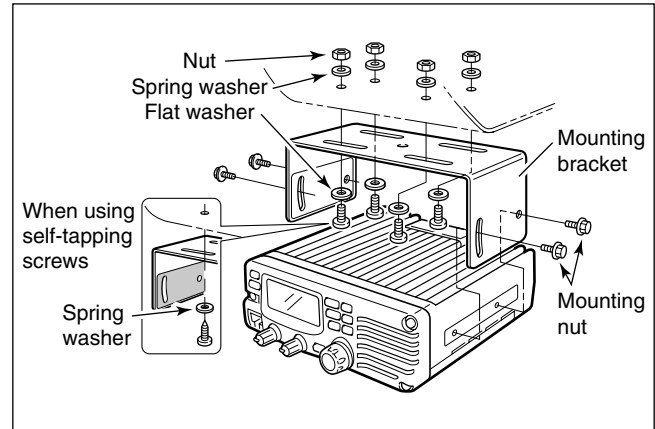

◆ **Battery connection**

- ⚠ **NEVER** connect the transceiver directly to a 24 V battery.
- ⚠ **DO NOT** use the cigarette lighter socket for power connections. (See p. 5 for details)

Attach a rubber grommet when passing the DC power cable through a metal plate to prevent short circuiting.

• **CONNECTING TO A DC POWER SOURCE**

- See p. 72 for fuse replacement.

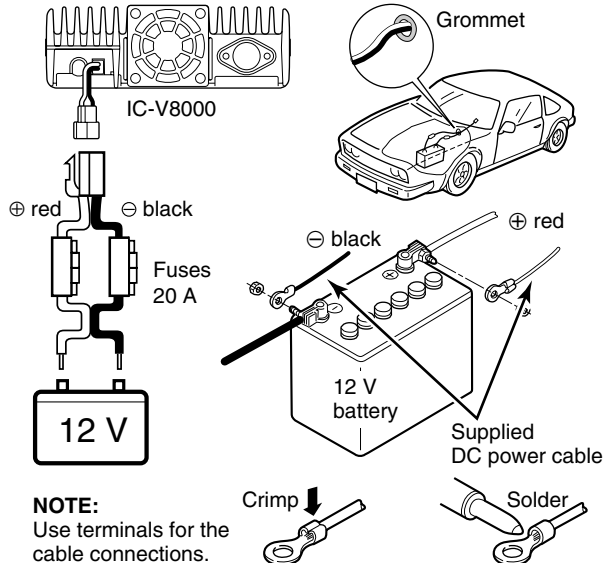

NOTE:
Use terminals for the cable connections.

◆ **DC power supply connection**

Use a 13.8 V DC power supply with at least 15 A capacity.

Make sure the ground terminal of the DC power supply is grounded.

• **CONNECTING TO A DC POWER SUPPLY**

- See p. 72 for fuse replacement.

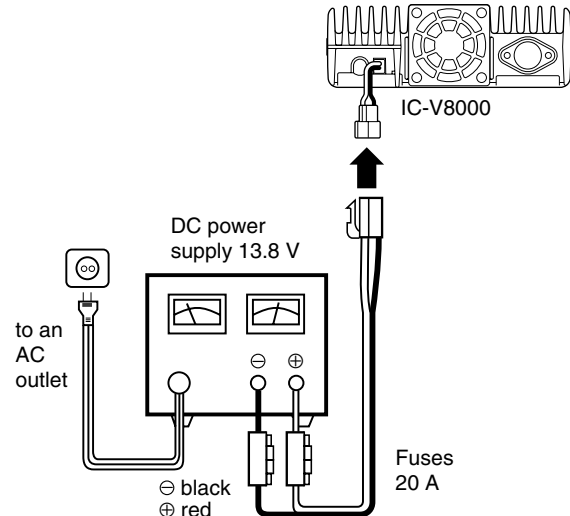

QUICK REFERENCE GUIDE

◇ Antenna installation

• Antenna location

To obtain maximum performance from the transceiver, select a high-quality antenna and mount it in a good location. A non-radial antenna should be used when using a magnetic mount.

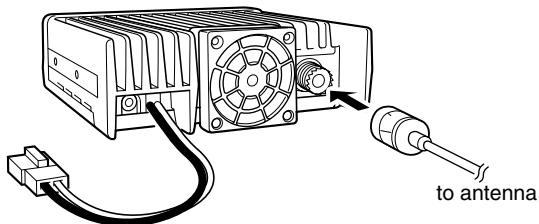
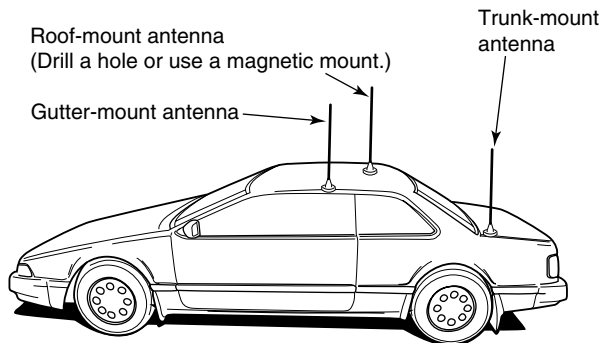

• Antenna connector

The antenna uses a PL-259 connector.

• PL-259 CONNECTOR

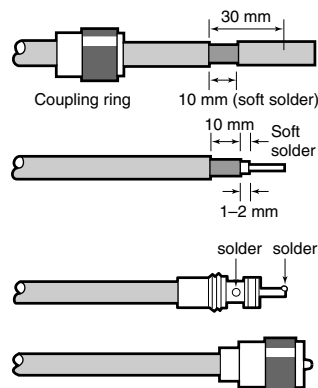

① Slide the coupling ring down. Strip the cable jacket and soft solder.

② Strip the cable as shown at left. Soft solder the center conductor.

③ Slide the connector body on and solder it.

④ Screw the coupling ring onto the connector body.
(10 mm \approx 3/8 in)

/// **NOTE:** There are many publications covering proper antennas and their installation. Check with your local dealer for more information and recommendations.

◇ Connecting a microphone

Connect a microphone to the eight-pin modular socket on the front panel of the transceiver.

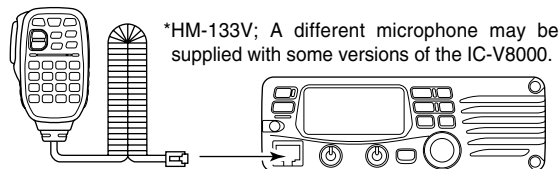

■ Your first contact

Now that you have your IC-V8000 installed in your car or shack, you are probably excited to get on the air. We would like to take you through a few basic operation steps to make your first “On The Air” an enjoyable experience.

1. Turning ON the transceiver

Before powering up your IC-V8000, you may want to make sure the audio volume and squelch level controls are set in 9–10 o'clock positions.

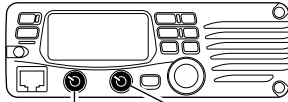

Set both [VOL] and [SQL] controls to 9–10 o'clock positions.

Although you have purchased a brand new transceiver, some settings may be changed from the factory defaults because of the QC process. Resetting the CPU is necessary to start from factory default.

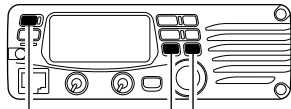

[PWR] [SET(LOCK)] [MW(S.MW)]

➔ While pushing [SET(LOCK)] and [MW(S.MW)], push [PWR] for 1 sec. to reset the CPU.

2. Tune the desired frequency

The tuning dial will allow you to dial in the frequency you want to operate. Pages 9 and 11 will instruct you on how to set the tuning speed.

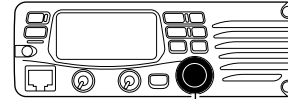



Tuning dial

Using the HM-133V

You can directly enter the frequency with the HM-133V keypad.

[EXAMPLE]: Setting frequency to 145.3625 MHz.

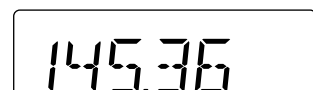
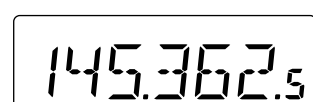
	Push VFO/LOCK	
	Push T-OFF ENT C	
Push ANM MONI1	DTCS HIGH 4 DTCS<sup>H</sup> MID 5	
	PTT-M PRIO 3 DTMF LOW 6	
	Push T-SCAN SCAN 2	

We hope these pointers have been helpful. Now you are ready to call CQ.

QUICK REFERENCE GUIDE

■ Repeater operation

1. Setting duplex

Push [LOW(DUP)] for 1 sec. once or twice to select minus duplex or plus duplex.

- The USA and CSA versions have an auto repeater function, therefore, setting duplex is not required.

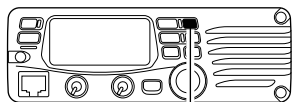

[LOW(DUP)]

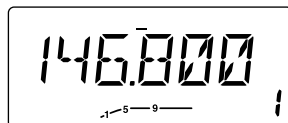

2. Repeater tone

Push [TONE(T-SCAN)] several times until “♪” appears, if the repeater requires a subaudible to be accessed.

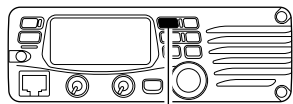

[TONE(T-SCAN)]

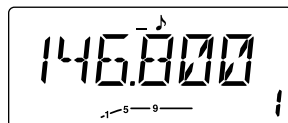

Using the HM-133V

Plus or minus duplex selection and the repeater tone setting can be made easily via HM-133V.

Push [DUP- 7(TONE)] for minus duplex; [DUP+ 8(TSQL((••)))] for plus duplex selection, push [FUNC] then [DUP- 7(TONE)] to turn the repeater tone ON.

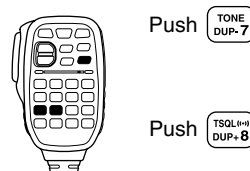

Push TONE
DUP-7



Push TSQL+
DUP+8

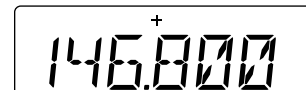

Push FUNC, then TONE
DUP-7

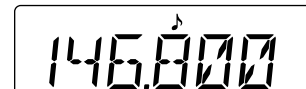

■ Programming memory channels

The IC-V8000 has a total of 200 memory channels (including 6 scan edges and 1 call channel) for storing often used operating frequency, repeater settings, etc.

1. Setting a frequency

In VFO mode, set the desired operating frequency with repeater, tone and tuning steps, etc.

2. Selecting a memory channel

Momentarily push [MW(S.MW)], then rotate the tuning dial to select the desired memory channel.

- “M” indicator and memory channel number blink.

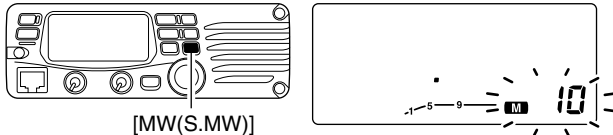

3. Writing a memory channel

Push and hold [MW(S.MW)] for 1 sec. to program.

- 3 beeps sound
- Memory channel number automatically increases when continuing to push [MW(S.MW)] after programming.

Using the HM-133V

- ① In VFO mode, set the desired operating frequency, including offset direction, tone settings, etc.
- ② Push [FUNC] then [CLR A(MW)].
 - “M” indicator and memory channel number blink.

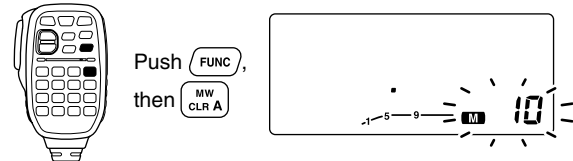

- ③ Push [▲]/[▼] to select the desired memory channel.
- ④ Push [FUNC] then push [CLR A(MW)] for 1 sec. to program.
 - 3 beeps sound
 - Memory channel number automatically increases when continuing to push [CLR A(MW)] after programming.

1

PANEL DESCRIPTION

■ Front panel

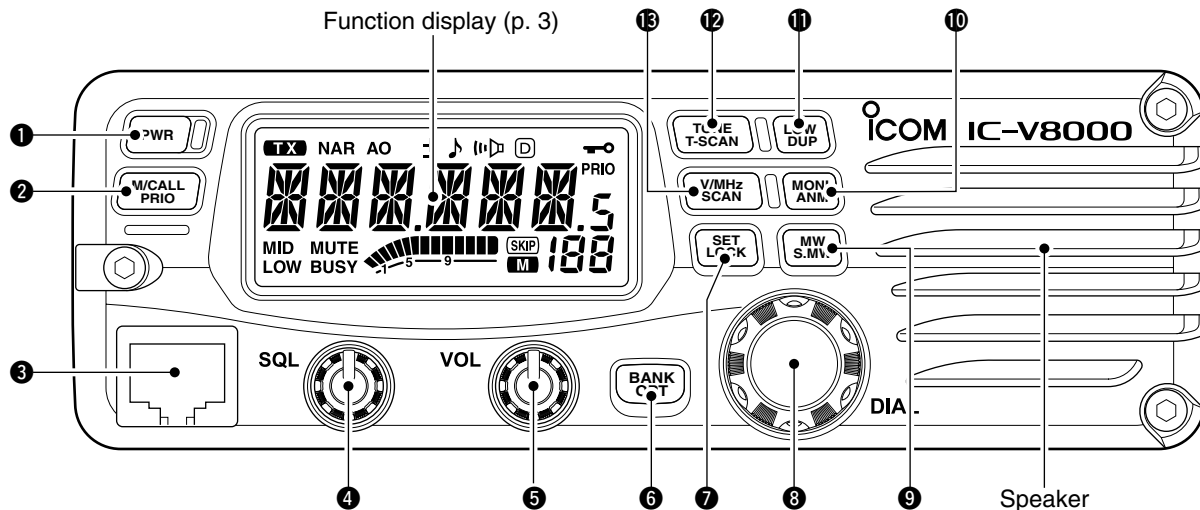

1 POWER SWITCH [PWR]

Turns power ON and OFF when pushed for 1 sec.

2 MEMORY/CALL•PRIORITY SWITCH [M/CALL(PRIO)]

➔ Push to select and toggle memory, call and weather channel* modes. (pgs. 24, 35, 65)

*Weather channels available for USA versions only.

➔ Starts priority watch when pushed for 1 sec. (p. 44)

3 MICROPHONE CONNECTOR

Connects the supplied microphone.

4 SQUELCH CONTROL [SQL]

Varies the squelch level. (p. 13)

- The RF attenuator activates and increases the attenuation when rotated clockwise to the center position and further.

5 VOLUME CONTROL [VOL]

Adjusts the audio level. (p. 13)

6 BANK•OPTION SWITCH [BANK(OPT)]

- ➔ Push to select memory bank condition during memory mode. (p. 32)
- ➔ Push for 1 sec. to select and toggle the pager and code squelch function when the optional UT-108 is installed. (p. 52)

7 SET•LOCK SWITCH [SET(LOCK)]

- ➔ Enters set mode when pushed. (p. 58)
- ➔ Switches the lock function ON and OFF when pushed for 1 sec. (p. 12)

8 TUNING DIAL [DIAL]

Selects the operating frequency (p. 9), memory channel (p. 24), the setting of the set mode item and the scanning direction (p. 38).

9 MEMORY WRITE SWITCH [MW(S.MW)] (p. 25)

- ➔ Selects a memory channel for programming.
- ➔ Programs the selected memory channel when pushed for 1 sec.
 - Continue to hold the switch to increment the memory channel automatically.

10 MONITOR•CHANNEL NAME SWITCH [MONI(ANM)]

- ➔ Push to switch the monitor function ON and OFF. (p. 13)
- ➔ In memory and call channel mode, switches the channel names or number ON and OFF. (p. 30)

11 OUTPUT POWER SWITCH [LOW(DUP)]

- ➔ Each push changes the output power selection. (p. 15)
- ➔ Select DUP-, DUP+ and simplex operation when pushed for 1 sec. (p. 17)

12 TONE/TONE SCAN SWITCH [TONE(T-SCAN)]

- ➔ Each push selects a tone function. (pgs. 17, 48)
 - Tone encoder, pocket beep, tone squelch or tone function OFF can be selected.
- ➔ Push for 1 sec. to start/stop the tone scan function. (p. 51)

13 VFO/MHz TUNING•SCAN SWITCH [V/MHz(SCAN)]

- ➔ Selects and toggles VFO mode and 1 MHz (or 10 MHz for some versions) tuning when pushed. (p. 9)
- ➔ Starts scan when pushed for 1 sec. (p. 38)
 - Cancels a scan when pushed during scan.

◇ **Microphone connector (front panel view)**

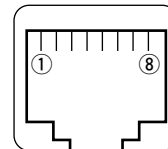

- ① +8 V DC output (Max. 10 mA)
- ② Channel up/down
- ③ 8 V control IN
- ④ PTT
- ⑤ GND (microphone ground)
- ⑥ MIC (microphone input)
- ⑦ GND
- ⑧ Data IN

1 PANEL DESCRIPTION

■ Function display

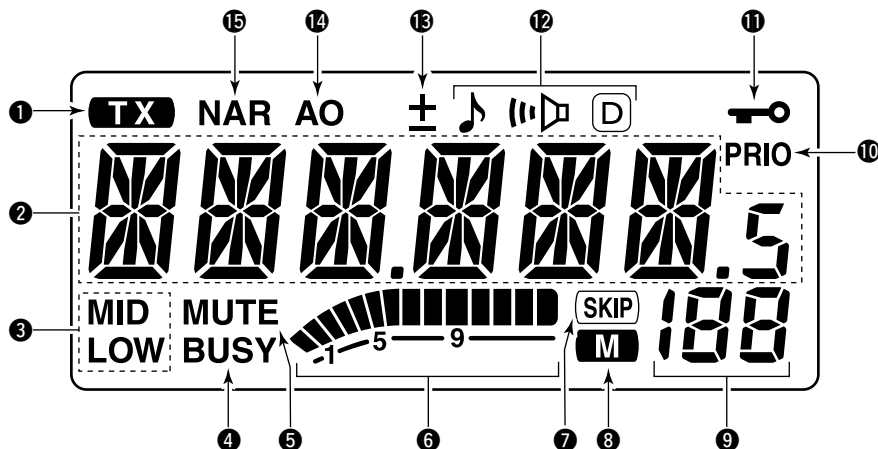

① TRANSMIT INDICATOR

- ➔ Appears while transmitting. (p. 15)
- ➔ Flashes while transmitting with the one-touch PTT function. (p. 16)

② FREQUENCY READOUT

- Shows the operating frequency, channel names, set mode contents, etc.
- Frequency decimal point flashes while scanning. (p. 38)
 - “d” appears in place of the 1st digit while the DTMF memory function is in use. (p. 45)

③ OUTPUT POWER INDICATORS

- “LOW” appears when low output power; “LOW” and “MID” appear when low mid output power; “MID” appears when middle output power is selected

④ BUSY INDICATOR (p. 13)

- ➔ Appears when a signal is being received or the squelch is open.
- ➔ Flashes while the monitor function is activated.

⑤ AUDIO MUTE INDICATOR (p. 14)

- Appears when the audio mute function is activated via microphone control.

6 S/R/F INDICATORS

- Shows the relative signal strength while receiving signals. (p. 13)
- Shows the output power level while transmitting. (p. 15)

7 SKIP INDICATOR (p. 41)

Appears when the displayed memory channel is specified as a skip channel.

8 MEMORY INDICATOR (p. 24)

Appears when memory mode is selected.

9 MEMORY CHANNEL NUMBER INDICATORS

- Shows the selected memory channel number. (p. 24)
- “C” appears when the call channel is selected. (p. 35)

10 PRIORITY WATCH INDICATOR (p. 44)

Appears while the priority watch is activated; blinks while the watch is paused.

11 LOCK INDICATOR (p. 12)

Appears when the lock function is activated.

12 TONE INDICATORS

- “♪” appears while the subaudible tone encoder is in use. (p. 17)
- “♭” appears while the tone (CTCSS) squelch function is in use. (p. 48)
- “@” appears while the tone (DTCS) squelch function is in use. (p. 48)
- “♯” appears with the “♭” or “@” indicator while the pocket beep function (CTCSS or DTCS) is in use. (p. 48)

13 DUPLEX INDICATORS (p. 17)

“+” appears when plus duplex, “-” appears when minus duplex operation is selected.

14 AUTO POWER-OFF INDICATOR (p. 64)

Appears while the auto power-off function is in use.

15 NARROW MODE INDICATOR (p. 61)

Appears when the narrow mode is selected.

Narrow mode is available with some USA versions only.

1 PANEL DESCRIPTION

■ Rear panel

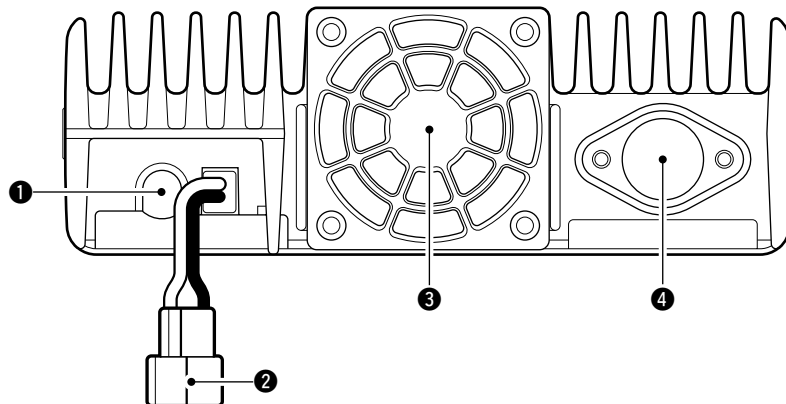

❶ SPEAKER JACK [SP]

Accepts an 8 Ω speaker.

- Audio output power is more than 2.0 W.

❷ POWER RECEPTACLE [DC13.8V]

Accepts 13.8 V DC $\pm 15\%$ with the supplied DC power cable.

⚠ **NOTE: DO NOT** use a cigarette lighter socket as a power source when operating in a vehicle. The plug may cause voltage drops and ignition noise may be superimposed onto transmit or receive audio.

❸ COOLING FAN

Rotates while transmitting.

Also rotates while receiving depending on the setting in set mode and transceiver's temperature. (p. 61)

❹ ANTENNA CONNECTOR [ANT]

Connects a 50 Ω antenna with a PL-259 connector and a 50 Ω coaxial cable.

Microphone (HM-133V*)

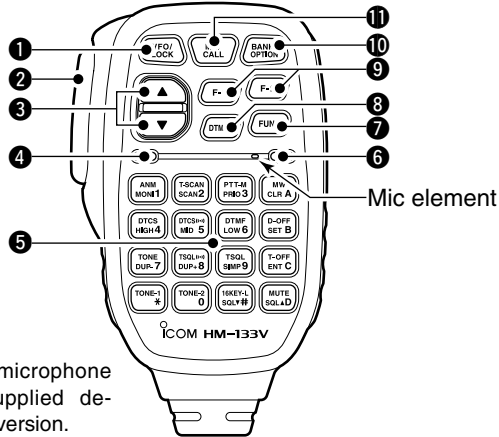

*A different microphone may be supplied depending on version.

1 VFO/LOCK SWITCH [VFO/LOCK]

- Push to select VFO mode. (p. 9)
- Push for 1 sec. to switch the lock function ON and OFF. (p. 12)

2 PTT SWITCH

- Push and hold to transmit; release to receive.
- Switches between transmitting and receiving while the one-touch PTT function is in use. (p. 16)

3 UP/DOWN SWITCHES [▲]/[▼]

- Push either switch to change operating frequency, memory channel, set mode setting, etc. (pgs. 10, 24)
- Push either switch for 1 sec. to start scanning. (p. 38)

4 ACTIVITY INDICATOR

- Lights red while any key, except [FUNC] and [DTMF-S], is pushed, or while transmitting.
- Lights green while the one-touch PTT function is in use.

5 KEYPAD (pgs. 7, 8)

6 FUNCTION INDICATOR

- Lights orange while [FUNC] is activated—indicates the secondary function of switches can be accessed.
- Lights green when [DTMF-S] is activated—DTMF signals can be transmitted with the keypad.

7 FUNCTION SWITCH [FUNC] (pgs. 7, 8)

8 DTMF MEMORY SELECT SWITCH [DTMF-S] (p. 46)

9 FUNCTION SWITCHES [F-1]/[F-2] (p. 67)

- Program and re-call your desired transceiver conditions.

10 BANK/OPTION SWITCH [BANK/OPTION]













- Push to select memory bank condition during memory mode. (p. 32)
- Push for 1 sec. to select and toggle pager and code squelch function when the optional UT-108 is installed. (p. 52)









11 MEMORY/CALL SWITCH [MR/CALL]

- Push to select memory mode. (p. 24)
- Push for 1 sec. to select call channel. (p. 35)

1 PANEL DESCRIPTION

■ Microphone keypad

KEY	FUNCTION	SECONDARY FUNCTION ( +key)	OTHER FUNCTIONS
	Switches between opening and closing the squelch. (p. 13)	In memory mode switches the channel names or number indication ON and OFF. (p. 31)	After pushing  : Transmits the appropriate DTMF code. (pgs. 20, 46) When the DTMF memory encoder is activated, push [0] to [9] to transmit the appropriate DTMF memory contents . (p. 46)
	Starts and stops scanning. (p. 38)	Starts and stops tone scanning. (p. 51)	
	Starts and stops priority watch. (p. 44)	Turns the one-touch PTT function ON and OFF. (p. 16)	
	Selects high output power. (p. 15)	Turns the DTCS squelch ON. (p. 50)	
	Selects mid. output power. (p. 15)	Turns the DTCS pocket beep function ON. (p. 49)	
	Selects low output power (p. 15)	Turns the DTMF memory encoder function ON. (p. 45)	
	Selects minus duplex operation. (p. 18)	Turns the subaudible tone encoder ON. (p. 18)	
	Selects plus duplex operation. (p. 18)	Turns the CTCSS pocket beep function ON. (p. 49)	
	Selects simplex operation. (p. 18)	Turns the tone squelch function ON. (p. 50)	
	No primary function.	Sends a 1750 Hz tone signal while pushing and holding. (p. 20)	

KEY	FUNCTION	SECONDARY FUNCTION ( +key)	OTHER FUNCTIONS
	<ul style="list-style-type: none"> ➔ Cancels frequency entry. (p. 10) ➔ Cancels the scan or priority watch. (pgs. 38, 44) ➔ Exit set mode. (p. 58) 	<ul style="list-style-type: none"> ➔ Selects a memory channel for programming. (p. 26) ➔ Advances the memory channel number when continuously pushed after programming is completed. (p. 26) 	After pushing  : Transmits the appropriate DTMF code. (pgs. 20, 46)
	<ul style="list-style-type: none"> ➔ Enters set mode (p. 58) ➔ Advances the set mode selection order after entering set mode. (p. 58) 	DTMF memory OFF. (p. 46)	
	<ul style="list-style-type: none"> ➔ Sets the keypad for numeral input. (p. 10) ➔ Reverses the set mode selection order after entering set mode. (p. 58) 	Turns the subaudible tone encoder, pocket beep or CTCSS/DTCS tone squelch OFF. (pgs. 18, 49, 50)	
	Adjusts the squelch level increments. (p. 13)	Mutes the audio. (p. 14) • Mute function is released when any operation is performed.	
	No primary function.	Sends a 1750 Hz tone signal for 0.5 sec. (p. 20)	
	Adjusts the squelch level decrement. (p. 13)	Locks the digit keys on the keypad (including the A to D, # and * keys. (p. 12)	

■ Preparation

◇ Turning power ON/OFF

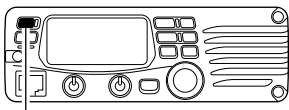

Push [PWR] for 1sec.

➔ Push [PWR] for 1 sec. to turn power ON and OFF.

◇ VFO mode selection

The transceiver has 2 basic operating modes: VFO mode and memory mode.

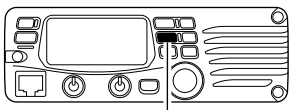

Push [V/MHz(SCAN)]

➔ Push [V/MHz(SCAN)] to select VFO mode.

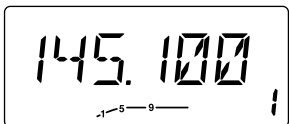

➔ Push [VFO/LOCK] to select VFO mode.

■ Using the tuning dial

① Rotate the tuning dial to set the frequency.

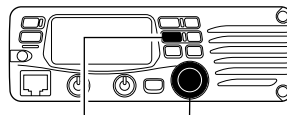

[V/MHz(SCAN)] Tuning dial

- If VFO mode is not selected, push [V/MHz(SCAN)] to select VFO mode.
- The frequency changes according to the selected tuning steps. (p. 11)

② To change the frequency in 1 MHz (10 MHz for some versions) steps, push [V/MHz(SCAN)], then rotate the tuning dial.

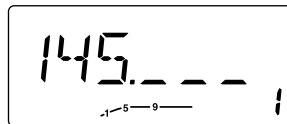

The display shows that the 1 MHz tuning step is selected.

- Pushing [V/MHz(SCAN)] for 1 sec. starts scan function. If scan starts, push [V/MHz(SCAN)] again to cancel it.



Note that in this manual, sections beginning with a microphone icon (as above), designate operation via the HM-133V microphone.

■ Using the keypad

The frequency can be directly set via numeral keys on the microphone.



- 1 Push [VFO/LOCK] to VFO mode, if necessary.
- 2 Push [ENT C(T-OFF)] to activate the keypad for digit input.
- 3 Push 6 keys to input a frequency.
 - When a digit is mistakenly input, push [ENT C(T-OFF)] to clear the input, then repeat input from the 1st digit.
 - Pushing [CLR A(MW)] clears input digits and retrieves the frequency.

[EXAMPLE]: Setting frequency to 145.3625 MHz.

Push

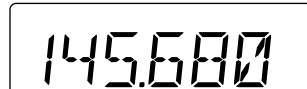

Push

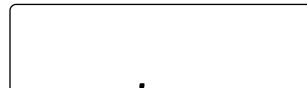

Push

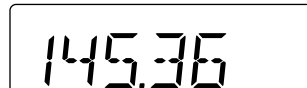

Push

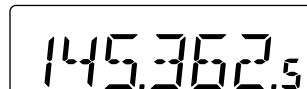

■ Using the [▲]/[▼] keys



- ➔ Push [▲] or [▼] to select the desired frequency.
- Pushing [▲]/[▼] for 1 sec. activates a scan. If scan starts, push [▲]/[▼] again or push [CLR A(MW)] to cancel it.

2 SETTING A FREQUENCY

■ Tuning step selection

USING SET MODE

Tuning steps are the minimum frequency change increments when you rotate the tuning dial or push [▲]/[▼] on the microphone. The following tuning steps are available.

- 5 kHz
- 10 kHz
- 12.5 kHz
- 15 kHz
- 20 kHz
- 25 kHz
- 30 kHz
- 50 kHz

NOTE: For convenience, select a tuning step that matches the frequency intervals of repeaters in your area.

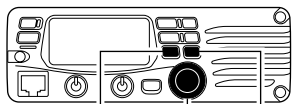

[SET(LOCK)] Tuning dial
[MW(S.MW)]

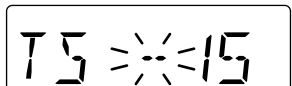

15 kHz tuning step

- ① Push [V/MHz(SCAN)] to select VFO mode, if necessary.
- ② Push [SET(LOCK)] to enter set mode.
- ③ Push [SET(LOCK)] or [MW(S.MW)] several times until "TS" appears as shown at left.
- ④ Rotate the tuning dial to select the desired tuning step.
- ⑤ Push [TONE(T-SCAN)] to exit set mode.



- ① Push [VFO/LOCK] to select VFO mode, if necessary.
- ② Push [SET B(D-OFF)] to enter set mode.
- ③ Push [SET B(D-OFF)] or [ENT C(T-OFF)] several times until "TS" appears.
- ④ Push [▲] or [▼] to select the desired tuning step.
- ⑤ Push [CLR A(MW)] to exit set mode.

■ Lock functions

To prevent accidental channel changes and unnecessary function access, use the lock function. The transceiver has 2 different lock functions.

◇ Frequency lock

This function locks the tuning dial and switches electronically and can be used together with the microphone lock function.

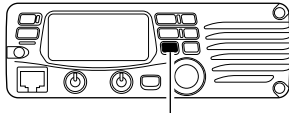

Push [SET(LOCK)] for 1 sec.

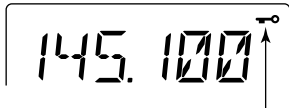

Appears

➔ Push [SET(LOCK)] for 1 sec. to turn the lock function ON and OFF.

- [PTT], [MONI(ANM)], [VOL] and [SQL] can be used while the channel lock function is in use. Also, TONE-1, TONE-2, DTMF tones or DTMF memory contents can be transmitted from the microphone.



➔ Push [VFO/LOCK] for 1 sec. to switch the lock function ON and OFF.

◇ Microphone keypad lock

This function locks the microphone keypad.



➔ Push [FUNC] then [SQL▼D(16KEY-L)] to switch the microphone keypad lock function ON and OFF.

- [PTT], [VFO/LOCK], [MR/CALL], [BANK/OPTION], [▲], [▼], [F-1], [F-2], [DTMF-S] and [FUNC] on the microphone can be used.
- All switches on the transceiver can be used.
- The keypad lock function is released when the power is turned OFF then ON again.

■ Receiving

- ① Push [PWR] for 1 sec. to turn power ON.
- ② Set the audio level.
 - ➔ Push [MONI(ANM)] to open the squelch.
 - ➔ Rotate the [VOL] control to adjust the audio output level.
 - ➔ Push [MONI(ANM)] again to close the squelch.
- ③ Set the squelch level.
 - ➔ Rotate [SQL] fully counterclockwise in advance.
 - ➔ Rotate [SQL] clockwise until the noise just disappears.
 - ➔ When interference is received, rotate [SQL] clockwise again for attenuator operation.
- ④ Set the operating frequency. (pgs. 9, 10)
- ⑤ When receiving a signal on the set frequency, squelch opens and the transceiver emits audio.

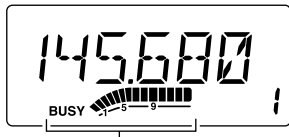

Appears when receiving a signal.

- “BUSY” appears and the S/R F indicator shows the relative signal strength for the received signal.

✓CONVENIENT!



The squelch level can also be adjusted with [SQL▲ D(MUTE)] and [SQL▼ #(16KEY-L)].



■ Monitor function

This function is used to listen to weak signals without disturbing the squelch setting or to open the squelch manually even when mute functions such as the tone squelch are in use.

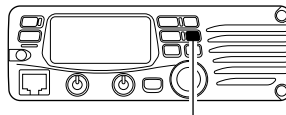

Push [MONI(ANM)]

- ➔ Push [MONI(ANM)] to open the squelch.
 - “BUSY” blinks.
 - Push [MONI(ANM)] again to cancel the function.

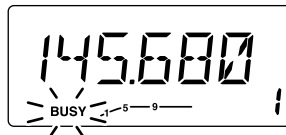

- ➔ Push [MONI 1(ANM)] to open the squelch.
 - Push [MONI 1(ANM)] again to cancel the function.

■ Audio mute function

This function temporarily mutes the audio without disturbing the volume setting.



- Push [FUNC] then [SQL▲ D(MUTE)] to mute audio signals.
 - "MUTE" appears.
 - Push [CLR A(MW)] (or any other key) to cancel the function.

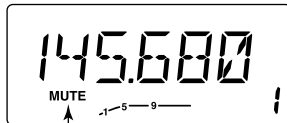

Appears

■ Squelch attenuator

The transceiver has an RF attenuator related to the squelch level setting. Approx. 10 dB attenuation is obtained at maximum setting.

- Rotate [SQL] clockwise past the 12 o'clock position to activate the squelch attenuator.
 - Attenuation level can be adjusted up to 10 dB (approx.) between 12 o'clock and fully clockwise position.
 - When setting the squelch from the microphone, a level greater than '19' activates the squelch attenuator.

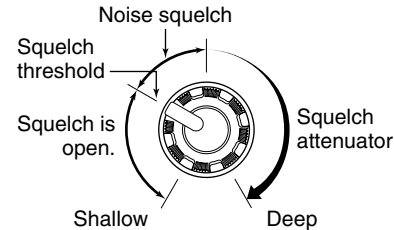

3 BASIC OPERATION

■ Transmitting

CAUTION: Transmitting without an antenna will damage the transceiver.

NOTE: To prevent interference, listen on the channel before transmitting by pushing [MONI(ANM)], or [MONI 1(ANM)] on the microphone.

- ① Set the operating frequency. (pgs. 9, 10)
 - Select output power if desired. See section at right for details.
- ② Push and hold [PTT] to transmit.
 - “TX” appears.
 - The S/RF indicator shows the output power selection.
 - A one-touch PTT function is available. See p. 16 for details.
- ③ Speak into the microphone using your normal voice level.
 - DO NOT hold the microphone too close to your mouth or speak too loudly. This may distort the signal.
- ④ Release [PTT] to return to receive.

IMPORTANT! (for 75 W transmission):

The IC-V8000 is equipped with protection circuit to protect the power amplifier circuit from high SWR (Standing Wave Ratio) and temperature. When a high SWR antenna or no antenna is connected, or when the transceiver temperature becomes extremely high, the transceiver reduces transmit output power to 25 W (approx.) automatically.

■ Selecting output power

The transceiver has 4* output power levels to suit your operating requirements. Low output powers during short-distance communications may reduce the possibility of interference to other stations and will reduce current consumption.

*The Taiwan version has only 3 levels.

Push [LOW(DUP)] several times to select the output power.

S/RF INDICATOR	POWER OUTPUT	
		Taiwan
High:	75 W	24 W
Mid.:	25 W*	10 W*
Mid. Low:	10 W*	N/A
Low:	5 W*	5 W*

• The output power can be changed while transmitting. *approx.

The microphone can also be used to select output power.

- ➔ Push [HIGH 4(DTCS)] for high output power; [MID 5(DTCS ((•)))] for middle output power; and [LOW 6(DTMF)] for low output power.
- The output power can be changed via the microphone during receive only.



■ One-touch PTT function

The PTT switch can be operated as a one-touch PTT switch (each push switches between transmit/receive). Using this function you can transmit without pushing and holding the PTT switch.

To prevent accidental, continuous transmissions with this function, the transceiver has a time-out timer. See p. 63 for details.



PTT-M

- 1 Push [FUNC] then [PRIO 3(PTT-M)] to turn the one-touch PTT function ON.
 - The activity indicator lights green.
- 2 Push [PTT] to transmit and push again to receive.
 - Two beeps sound when transmission is started and a long beep sounds when returning to receive.
 - “TX” flashes when transmitting with the one-touch PTT function.

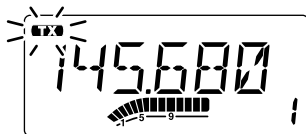

- 3 Push [FUNC] then [PRIO 3(PTT-M)] to turn the one-touch PTT function OFF.
 - The activity indicator goes out.

■ Accessing a repeater

- ① Set the receive frequency (repeater output frequency).
(pgs. 9, 10)
- ② Push [LOW(DUP)] for 1 sec., one or two times, to select minus duplex or plus duplex.
 - “-” or “+” appears to indicate the transmit frequency for minus shift or plus shift, respectively.
 - When the auto repeater function is turned ON (available for the USA and CSA versions), steps ② and ③ are not necessary. (p. 23)

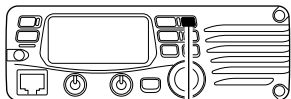

[LOW(DUP)]

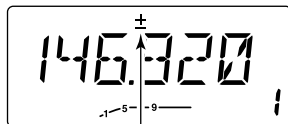

Either “-” or “+” appears.

- ③ Push [TONE(T-SCAN)] several times to turn ON the sub-audible tone encoder, according to repeater requirements.
 - “♪” appears
 - 88.5 Hz is set as the default; refer to p. 19 for tone frequency settings.
 - When the repeater requires a different tone system, see p. 20.

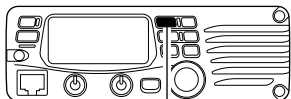

[TONE(T-SAN)]

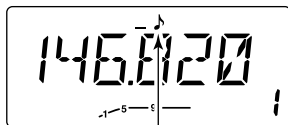

Appears

- ④ Push and hold [PTT] to transmit.
 - The displayed frequency automatically changes to the transmit frequency (repeater input frequency).
 - If “OFF” appears, confirm that the offset frequency (p. 21) is set correctly.
- ⑤ Release [PTT] to receive.

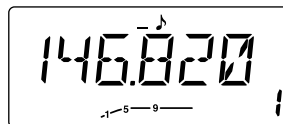

While receiving.

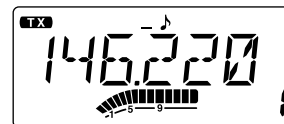

While transmitting

- ⑥ Push [MONI(ANM)] to check whether the other station's transmit signal can be received directly.
- ⑦ To return to simplex operation, push [LOW(DUP)] for 1 sec., once or twice, to clear the “-” or “+” indicator.
- ⑧ To turn OFF the subaudible tone encoder, push [TONE(T-SCAN)] several times until no tone indicators appear.



- 1 Set the receive frequency (repeater output frequency). (pgs. 9, 10)
- 2 Push [DUP- 7(TONE)] to select minus duplex; push [DUP+ 8(TSQL ((•)))] to select plus duplex.

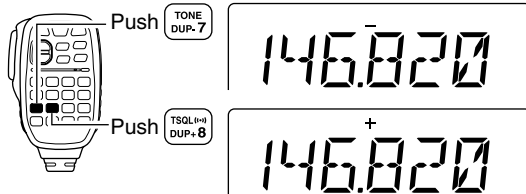

- 3 Push [FUNC] then [DUP- 7(TONE)] to turn ON the subaudible tone encoder according to repeater requirements.
 - Refer to p. 19 for the tone frequency setting.
 - When the repeater requires a different tone system, see p. 20.

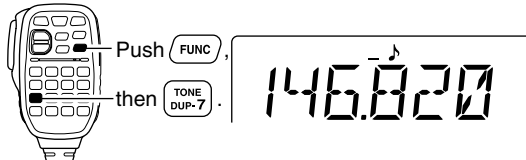

- 4 Push and hold [PTT] to transmit.
- 5 Release [PTT] to receive.
- 6 Push [MONI 1(ANM)] to check whether the other station's transmit signal can be received directly.



- 7 Push [SIMP 9(TSQL)] to return to simplex operation.
 - “+” or “-” indicator disappears.
- 8 To turn OFF the subaudible tone encoder, push [FUNC] then [ENT C(T-OFF)].

4 REPEATER OPERATION

■ Subaudible tones (Encoder function)

USING SET MODE

◇ Subaudible tones

- ① Select the mode/channel you wish to set the subaudible tones to, such as VFO mode or memory/call channel.
- ② Push [SET(LOCK)] to enter set mode.
- ③ Push [SET(LOCK)] or [MONI(ANM)] several times until “♪” and “rt” appears; or until “i” and “Ct” appears for tone squelch or pocket beep use.
 - When “d” is displayed in place of the 100 MHz digit, cancel the DTMF memory encoder in advance. (p. 46)

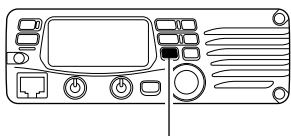

[SET(LOCK)]



- ④ Rotate the tuning dial to select and set the desired subaudible frequency.
- ⑤ Push [TONE(T-SCAN)] to exit set mode.

NOTE: The subaudible tone encoder frequency can be set in a memory/call channel temporarily. However, the set frequency is cleared once another memory channel or VFO mode is selected. To store the tone frequency permanently, overwrite the channel information.



- 1 Set the mode/channel you wish to set the subaudible tones to, such as VFO mode or memory/call channel.
 - The subaudible tone frequency is independently programmed into each mode or channel.
- 2 Push [SET B(D-OFF)] to enter set mode.
- 3 Push [SET B(D-OFF)] or [ENT C(T-OFF)] several times until “♪” and “rt” appears; or until “i” and “Ct” appears for tone squelch or pocket beep use.
 - When “d” is displayed in place of the 100 MHz digit, cancel the DTMF memory encoder in advance. (p. 46)



Push [D-OFF SET B]



- 4 Push [▲] or [▼] to select and set the desired subaudible tone frequency.
 - Push and hold [▲]/[▼] to change the above tones continuously.
- 5 Push [CLR A(MW)] to exit set mode.

• Subaudible tone frequency list

(unit: Hz)

67.0	79.7	94.8	110.9	131.8	156.7	171.3	186.2	203.5	229.1
69.3	82.5	97.4	114.8	136.5	159.8	173.8	189.9	206.5	233.6
71.9	85.4	100.0	118.8	141.3	162.2	177.3	192.8	210.7	241.8
74.4	88.5	103.5	123.0	146.2	165.5	179.9	196.6	218.1	250.3
77.0	91.5	107.2	127.3	151.4	167.9	183.5	199.5	225.7	254.1

◇ DTMF tones



➔ Push [DTMF-S], then push the keys of the desired DTMF digits.

- The function indicator lights green.
- 0–9, A–D, *(E) and #(F) are available.
- When “d” is displayed in place of the 100 MHz digit, cancel the DTMF memory encoder in advance. (p. 46)
- Push [DTMF-S] again to return the keypad to normal function control.
- The transceiver has 10 DTMF memory channels for autopatch operation. See p. 45 for details.

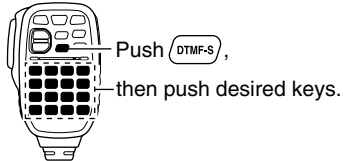

◇ 1750 Hz tone

The microphone has 1750 Hz tone capability, used for ring tone when calling, etc.



1 Push [FUNC].

- The function indicator lights orange.



2 Push [*(TONE-1)] to transmit a 1750 Hz tone call signal for 0.5 sec.; push and hold [0(TONE-2)] to transmit a 1750 Hz tone call signal for an arbitrary period.

- The function indicator goes out automatically.

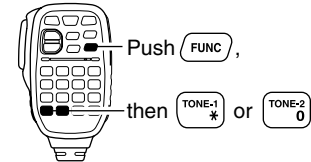

4 REPEATER OPERATION

■ Offset frequency USING SET MODE

When communicating through a repeater, the transmit frequency is shifted from the receive frequency by an amount determined by the offset frequency.

- ① Push [SET(LOCK)] to enter set mode.
- ② Push [SET(LOCK)] or [MW(S.MW)] until “±” and offset frequency appear.

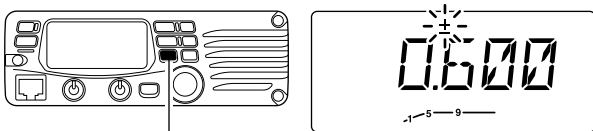

[SET(LOCK)]

- ③ Rotate the tuning dial to set the desired offset frequency.
- ④ Push [TONE(T-SCAN)] to exit set mode.



- ① Push [SET B(D-OFF)] to enter set mode.
- ② Push [SET B(D-OFF)] or [ENT C(T-OFF)] until “±” and offset frequency appear.

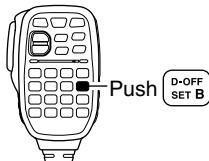

- ③ Push [▲] or [▼] to set the desired offset.
 - Direct frequency entry from the keypad is not possible.
- ④ Push [CLR A(MW)] to exit set mode.

■ Repeater lockout USING INITIAL SET MODE

This function helps prevent interference to other stations by inhibiting your transmission when a signal is received. The transceiver has two inhibiting conditions, repeater and busy.

- ① Push [PWR] to turn power OFF.
- ② While pushing [SET(LOCK)], turn power ON to enter initial set mode.

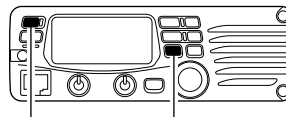

While pushing [SET(LOCK)],
turn power ON.

- ③ Push [SET(LOCK)] or [MW(S.MW)] several times until the “RLO” display appears as shown below.
- ④ Rotate the tuning dial to turn the repeater lockout function to “RP,” “BU” or OFF.



Repeater lockout function is
turned OFF.



Repeater lockout function is
turned ON.

- “RP”: Transmit is inhibited when a signal with un-matched sub-audible tone is received.
 - “BU”: Transmit is inhibited when a signal is received.
- ⑤ Push [PWR] to exit initial set mode.

■ Reversed duplex mode

USING SET MODE

When the reversed duplex mode is selected, the receive frequency shifts. (Transmit frequency shifts in normal duplex mode.) Each receive and transmit frequency is shown in the table below with the following conditions;

Input frequency : 145.30 MHz
 Direction : - (negative)
 Offset frequency : 0.6 MHz

Reversed	OFF	ON
Rx frequency	145.30 MHz	144.70 MHz
Tx frequency	144.70 MHz	145.30 MHz

- ① Push [SET(LOCK)] to enter set mode.
- ② Push [SET(LOCK)] or [MW(S.MW)] several times until the "REV" display appears as shown below.
- ③ Rotate the tuning dial to turn the repeater lockout function to ON or OFF.

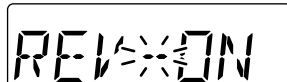

Reverse duplex mode is turned ON.

- ④ Push [TONE(T-SCAN)] to exit set mode.



- ① Push [SET B(D-OFF)] to enter set mode.
- ② Push [SET B(D-OFF)] or [ENT C(T-OFF)] until "REV" appears.

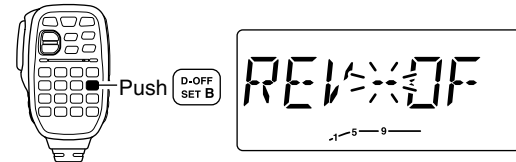

- ③ Push [▲] or [▼] to set the reversed duplex mode ON and OFF.
- ④ Push [CLR A(MW)] to exit set mode.

4 REPEATER OPERATION

■ Auto repeater USING INITIAL SET MODE (U.S.A. and C.S.A. versions only)

The USA and CSA versions automatically activate the repeater settings (DUP- or DUP+ and tone encoder ON/OFF) when the operating frequency falls within the general repeater output frequency range and deactivate them when outside of the range.

◇ Setting the auto repeater function ON/OFF

- ① Push [PWR] to turn power OFF.
- ② While pushing [SET(LOCK)], turn power ON to enter initial set mode.

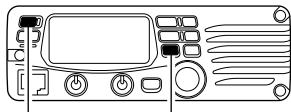

While pushing [SET(LOCK)],
turn power ON.

- ③ Push [SET(LOCK)] several times until the “RPT” display appears as shown above right.

- ④ Rotate the tuning dial to turn the auto repeater function to “R1,” “R2” or OFF.

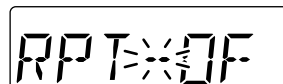

Auto repeater function is
turned OFF.

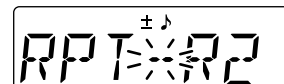

Auto repeater function is ON,
tone encoder is ON.

- “R1”: auto repeater is ON, tone encoder is OFF.
- “R2”: auto repeater is ON, tone encoder is ON.

- ⑤ Push [PWR] to exit initial set mode.

◇ Frequency range and offset direction

Frequency range	Duplex direction
145.200–145.495 MHz 146.610–146.995 MHz	“-” appears
147.000–147.395 MHz	“+” appears

■ General description

The transceiver has 207 memory channels including 6 scan edge memory channels (3 pairs), and 1 call channel. Each of these channels can be individually programmed with operating frequency (pgs. 9, 10), duplex direction (p. 19) and offset (p. 21), subaudible tone encoder or tone squelch and its tone frequency (pgs. 19, 48–50) and skip information* (p. 41). In addition, a total of 10 memory banks, A to J, are available for usage by group, etc.

*except for scan edge memory channels.

■ Memory channel selection

◇ Using the tuning dial

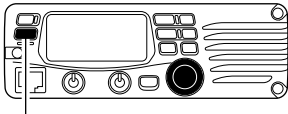

Push [M/CALL(PRIO)] to select memory mode.

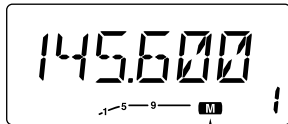

Appears

- ① Push [M/CALL(PRIO)] once or twice to select memory mode.
 - “M” indicator appears
- ② Rotate the tuning dial to select the desired memory channel.
 - Programmed memory channels only can be selected.

◇ Using the [▲]/[▼] keys

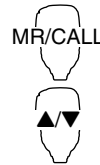

- ① Push [MR/CALL] to select memory mode.
- ② Push [▲] or [▼] to select and set the desired memory channel.
 - Pushing [▲]/[▼] for 1 sec. activates a scan.
 - If scan is activated, push [▲]/[▼] again or push [CLR A(MW)] to stop it.

◇ Using the keypad

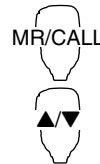

- ① Push [MR/CALL] to select memory mode.
- ② Push [ENT C(T-OFF)] to activate the keypad for numeral input.
- ③ Push 3 appropriate digit keys to input a channel number.
 - When inputting non-programmed channel numbers, the previous memory channel appears.
 - Push only 1 appropriate digit key, [MONI 1(ANM)], [SCAN 2(T-SCAN)] or [PRIO 3(PTT-M)], then push [* (TONE-1)] or [SQL▼#(16KEY-L)] to select scan edge channels. “*” and “#” can be used for “A” and “b” respectively.

5 MEMORY OPERATION

■ Programming a memory channel

VFO settings, including the set mode contents such as sub-audible tone frequency, etc., can be programmed into a memory channel.

- ① Set the desired frequency in VFO mode.
 - ➔ Push [V/MHz(SCAN)] to select VFO mode.
 - ➔ Set the frequency using the tuning dial.
 - ➔ Set other data (e.g. tone frequency, duplex information, etc.) if required.
- ② Push [MW(S.MW)] momentarily.
 - "M" indicator and the memory channel number blink.

- ③ Rotate the tuning dial to select the memory channel to be programmed.
 - Memory channels not yet programmed are blank.
- ④ Push [MW(S.MW)] for 1 sec. to program.
 - 3 beeps sound
 - Memory channel number automatically increases when continuing to push [MW(S.MW)] after programming.

✓ CONVENIENT

Memory programming can be performed in versatile ways e.g. memory channel to the same (or different) memory channel, memory channel to the call channel, etc.

[EXAMPLE]: Programming 145.870 MHz into memory channel 20 (blank channel) via the front panel.

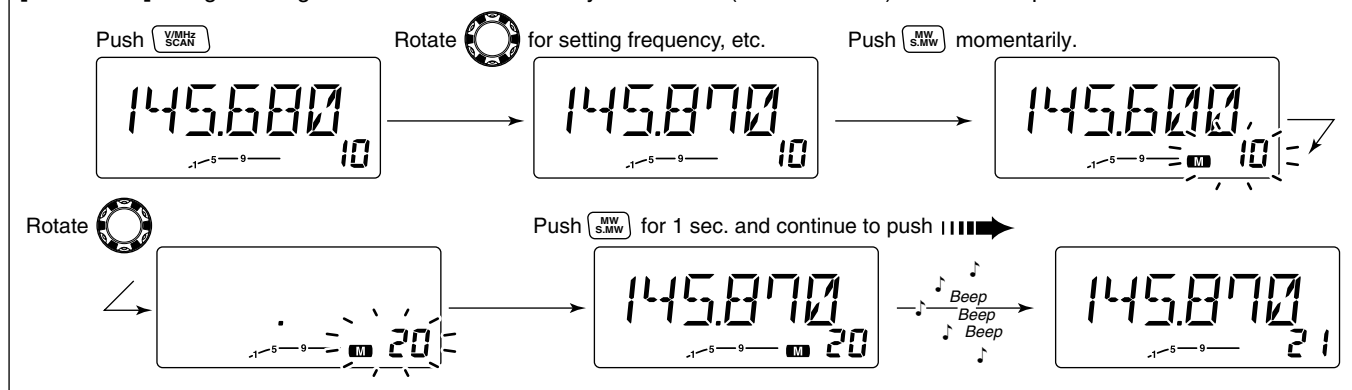

◇ Programming a memory channel via the microphone

 The microphone can also be used to program memory channels.

- 1 Set the desired frequency in VFO mode.
 - Push [VFO/LOCK] to select VFO mode.
 - Set the frequency using the keypad.
 - Set other data (e.g. offset frequency, duplex direction, sub-audible tone encoder ON/OFF and its frequency), if necessary.
- 2 Push [FUNC] then [CLR A(MW)] momentarily.
- 3 Select the memory channel to be programmed.
 - Push [▲] or [▼] to select the memory channel (direct numeral input cannot be used).
- 4 Push [FUNC] then [CLR A(MW)] for 1 sec. to program.
 - 3 beeps may sound and the VFO contents (including the subaudible tone frequency, etc.) are programmed.
 - Memory channel number increases when continuing to push [CLR A(MW)] after programming.

5

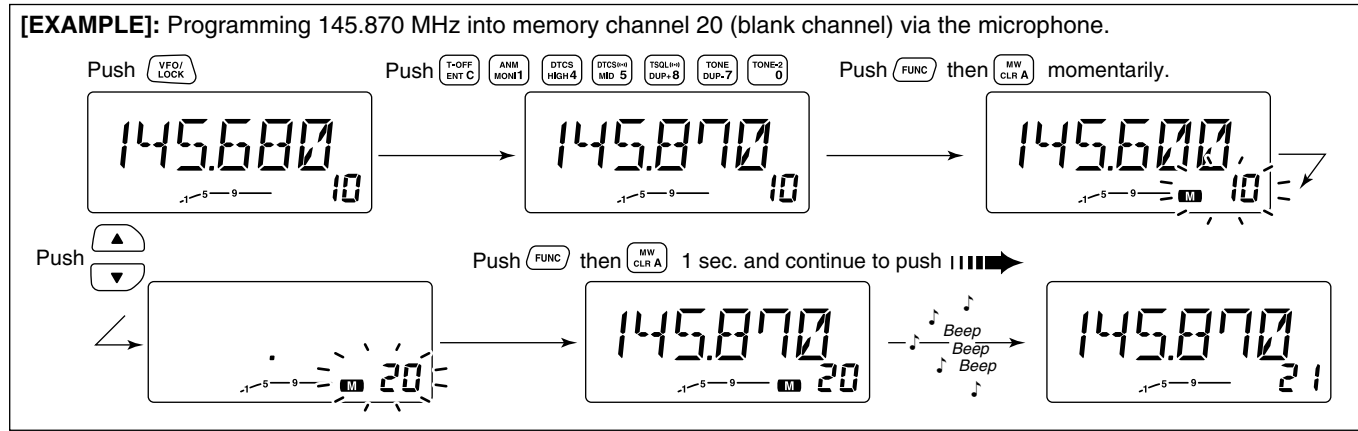

5 MEMORY OPERATION

■ Transferring memory contents

This function transfers a memory channel's contents to VFO (or another memory/call channel). This is useful when searching for signals around a memory channel frequency and for recalling the offset frequency, subaudible tone frequency etc.

◇ Memory/call→VFO

- ① Select the memory/call channel to be transferred.
 - ➔ Push [M/CALL(PRIO)] to select memory mode, then rotate the tuning dial to select the desired memory channel.
 - ➔ Push [M/CALL(PRIO)] for 1 sec. to select the call channel.
- ② Push [MW(S.MW)] for 1 sec. to transfer the selected memory/call channel contents to the VFO.
 - VFO mode is selected automatically.

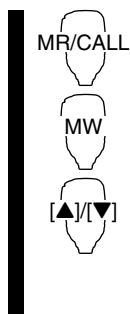

- ① Select the memory/call channel to be transferred.
 - ➔ Push [MR/CALL] to select memory mode, then select the desired memory channel via [▲]/[▼] or keypad.
 - ➔ Push [MR/CALL] for 1 sec. to select the call channel.
- ② Push [FUNC], then [CLR A(MW)] for 1 sec. to transfer the selected memory/call channel contents to the VFO.
 - VFO mode is selected automatically.

[EXAMPLE]: Transferring memory channel 30 contents to VFO.

Front panel operation:

Push to select memory mode.

Rotate for selecting memory channel.

Push for 1 sec.

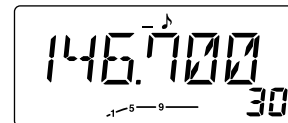
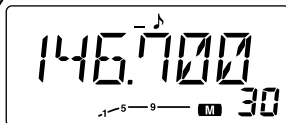
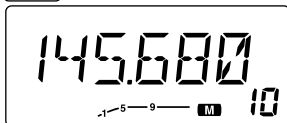

HM-133V operation:

Push to select memory mode.

Select memory channel.

Push then push for 1 sec.

◇ Memory/call↔call/memory

- ① Select the memory/call channel to be transferred.
 - ➔ Push [M/CALL(PRIO)] to select memory mode, then rotate the tuning dial to select the desired memory channel.
 - ➔ Push [M/CALL(PRIO)] for 1 sec. to select the call channel.
- ② Push [MW(S.MW)] momentarily.
 - “M” indicator and “- -” indication blink, and shows VFO conditions.
- ③ Rotate the tuning dial to select the target memory channel.
 - “C” blinks when the call channel is selected.
 - Scan edge channels, 1A/1b, 2A/2b, 3A/3b, can also be selected.
- ④ Push [MW(S.MW)] for 1 sec. to transfer the selected memory/call channel contents to the target memory.
 - The targeted memory and transferred contents are indicated.



- ① Select the memory/call channel to be transferred.
 - ➔ Push [MR/CALL] to select memory mode, then select the desired memory channel via [▲]/[▼] or keypad.
 - ➔ Push [MR/CALL] for 1 sec. to select the call channel.
- ② Push [FUNC], then [CLR A(MW)] momentarily.
 - “M” indicator and “- -” indication blink, and shows VFO conditions.
- ③ Push [▲]/[▼] to select the target memory channel.
 - “C” blinks when the call channel is selected.
 - Scan edge channels can also be selected.
 - The keypad cannot be used for the selection.
- ④ Push [FUNC] then push [CLR A(MW)] for 1 sec. to transfer the selected memory/call channel contents to the target memory.
 - The targeted memory and transferred contents are indicated.

[EXAMPLE]: Transferring memory channel 30 contents to channel 31.

Front panel operation:

Select the memory channel, then push .

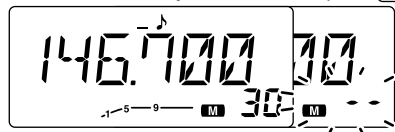

Select the target channel.

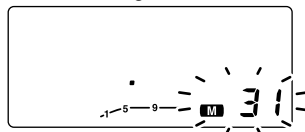

Push for 1 sec.

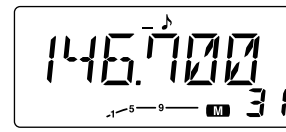

HM-133V operation:

Select the memory channel, push then push .

Push then push for 1 sec.

5 MEMORY OPERATION

■ Memory clearing

Contents of programmed memories can be cleared (blanked), if desired.

- ① Push [V/MHz(SCAN)] to select VFO mode.
- ② Push [MW(S.MW)] momentarily.
 - “M” indicator and the memory channel number blink.
- ③ Rotate the tuning dial to select the memory channel to be cleared.
 - Memory channels not yet programmed are blank.

- ④ Push [MW(S.MW)] momentarily, then push [MW(S.MW)] again for 1 sec.
 - **This operation must be performed within 1.5 sec.**
 - 3 beeps sound, then the frequency is cleared.
 - “M” indicator blinks continuously.
 - When clearing the call channel, the current VFO conditions are re-programmed into the call channel automatically.
- ⑤ Push any switch, except [MW(S.MW)], to return to VFO mode.

NOTE: Be careful!— the contents of cleared memories CANNOT be recalled.

[EXAMPLE]: Clearing memory channel 20.

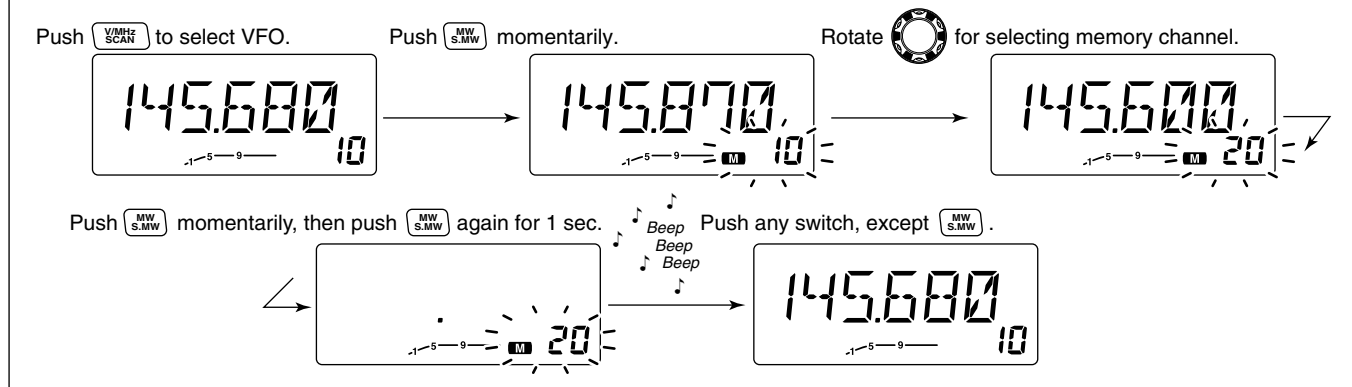

5 MEMORY OPERATION



Channel names can also be programmed via the microphone.

- 1 Select the memory/call channel to be assigned memory names.
 - ➔ Push [MR/CALL] to select memory mode, then select the desired memory channel via [▲]/[▼] or keypad.
 - Scan edge channels can also be selected.
 - ➔ Push [MR/CALL] for 1 sec. to select the call channel.
- 2 Push [FUNC], then [MONI 1(ANM)] momentarily.
- 3 Push [SET B(D-OFF)].
 - Frequency readouts disappear.
- 4 Push [▲]/[▼] to select the desired character.
 - The selected character blinks.
- 5 Push [SET B(D-OFF)] or [ENT C(T-OFF)] to move the cursor to left or right, respectively.
- 6 Repeat steps 4 and 5 until the desired channel names are displayed.
- 7 Push [CLR A(MW)] to program the name and exit the channel name programming condition.
- 8 Push [FUNC], then push [MONI 1(ANM)] to return to frequency indication if desired.

[EXAMPLE]: Programming “CLUB” into memory channel 1.

Select memory channel 1,
push [FUNC], then push [ANM
MONI 1].

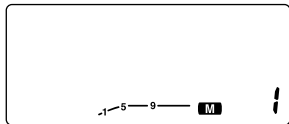

Push [▲]
[▼] to select the character.

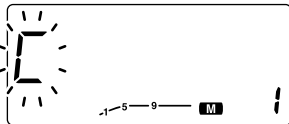

Push [D-OFF
SET B] or [T-OFF
ENT C] to move
the cursor.

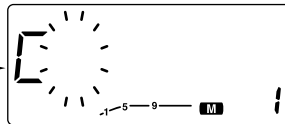

Repeat
previous
steps.

Push [MW
CLR A].

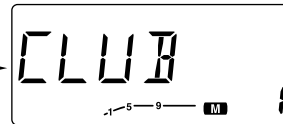

Memory bank selection

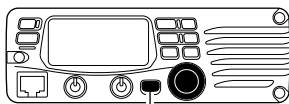

Push [BANK(OPT)] to select memory bank mode.

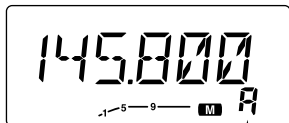

Shows bank initial.

- ① Push [M/CALL(PRIO)] to select memory mode, if desired.
- ② Push [BANK(OPT)] to select memory bank condition.
 - Bank initial blinks
- ③ Rotate the tuning dial to select the desired bank, A to J.
 - Banks that have no programmed contents are skipped.
- ④ Push [BANK(OPT)] to set the bank.
 - Initial stops blinking.
- ⑤ Rotate the tuning dial to select the contents in the bank.
 - No channel numbers are displayed for memory bank operation.
- ⑥ To return to regular memory condition, push [BANK(OPT)] twice.



- ① Push [MR/CALL] to select memory mode, if desired.
 - ➡ Push [MR/CALL] for 1 sec. to select the call channel.
- ② Push [BANK/OPTION] to select memory bank condition.
 - Bank initial blinks
- ③ Push [▲]/[▼] to select the desired bank, A to J.
 - Only programmed memory bank can be selected.
- ④ Push [BANK/OPTION] to set the bank.
 - Initial stops blinking.
- ⑤ Push [▲]/[▼] to select the desired contents in the bank.
 - No channel numbers are displayed for memory bank operation.
- ⑥ To return to regular memory condition, push [BANK/OPTION] twice.

5 MEMORY OPERATION

Memory bank setting

- 1 Push [M/CALL(PRIO)] to select memory mode, then select the desired memory channel via the tuning dial.
- 2 Push [BANK(OPT)].

- “-” indication blinks as follows.

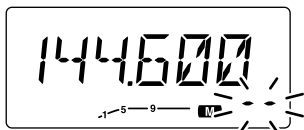

- 3 Push [BANK(OPT)] again to set the channel to bank setting stand-by condition.
- “-” indication blinking stops.
- 4 Push [MW(S.MW)] then rotate the tuning dial to select the desired bank to be set.
- “M” and bank initial blink as follows.

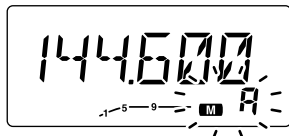

- 5 Push [MW(S.MW)] again to set the channel into the bank.
- “M” and bank initial blinking stops.
- 6 Push [BANK(OPT)] twice to return to regular memory condition.
- 7 Repeat steps 1 to 6 to set another memory channel into the same or another bank.

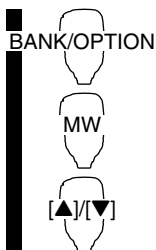

- 1 Push [MR/CALL] then select the desired memory channel via [▲]/[▼] or keypad.
- 2 Push [BANK/OPTION].
- “-” indication blinks.
- 3 Push [BANK/OPTION] again to set the channel to bank setting stand-by condition.
- “-” indication stops blinking.
- 4 Push [FUNC] then [CLR A(MW)] then push [▲]/[▼] to select the desired bank to be set.
- “M” and bank initial blink.
- 5 Push [CLR A(MW)] to set the channel into the bank.
- “M” and bank initial stops blinking.
- 6 Push [BANK/OPTION] twice to return to regular memory channel condition.
- 7 Repeat steps 1 to 6 to set another memory channel into the same or another bank.

■ Transferring bank contents

Contents of programmed memory banks can be cleared or transferred to another bank.

INFORMATION: Even if the memory bank contents are cleared, the memory channel contents still remain programmed.

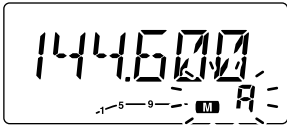
- ① Select the desired bank contents to be transferred or erased.
 - ➔ Push [M/CALL(PRIO)] to select memory mode.
 - ➔ Push [BANK(OPT)] then rotate the tuning dial to select the desired memory bank.
 - Bank initial blinks.
 - ➔ Push [BANK(OPT)] to select the bank then rotate the tuning dial to select the desired contents.
 - Bank initial stops blinking.
 - ② Push [MW(S.MW)] momentarily.
 - “M” and bank initial blink.
- 
- ③ Rotate the tuning dial to select the desired bank initial to transfer or erase.
 - Select “- -” indication when erasing the contents from the bank.
 - ④ Push [MW(S.MW)] again.
 - “M” and bank initial or “- -” indication stops blinking.
 - ⑤ Push [BANK(OPT)] twice to return to regular memory condition.

- ⑥ Repeat steps ① to ⑤ for transferring or erasing an another banks contents.

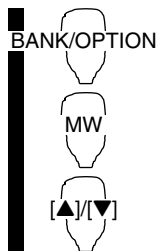

- ① Select the desired bank contents.
 - ➔ Push [MR/CALL] to select memory mode.
 - ➔ Push [BANK/OPTION] then select the desired memory bank via [▲]/[▼].
 - ➔ Push [BANK/OPTION] to select the bank then select the desired contents via [▲]/[▼].
- ② Push [FUNC] then [CLR A(MW)].
 - “M” and bank initial blinks.
- ③ Push [▲]/[▼] to select the desired bank initial to transfer or erase.
 - Select “- -” indication when erasing the contents from the bank.
- ④ Push [CLR A(MW)].
 - “M” and bank initial or “- -” indication stops blinking.
- ⑤ Push [BANK/OPTION] twice to return to regular memory condition.
- ⑥ Repeat steps ① to ⑤ for transferring or erasing an another banks contents.

Call channel selection

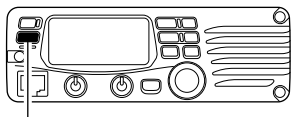

Push [M/CALL(PRIO)] several times to select the call channel.

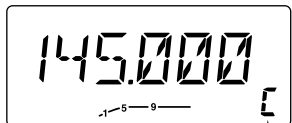

Appears



- ➔ Push [MR/CALL] for 1 sec. to select the call channel.
- Push [MR/CALL] to select memory mode, or push [VFO/LOCK] to select VFO mode.

✓ INFORMATION

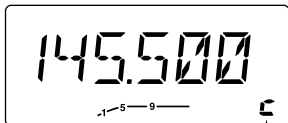

Small "c" shows VFO was selected from the call channel.

- ➔ Push [M/CALL(PRIO)] several times to select the call channel.
- "C" appears instead of memory channel number indication.
 - Push [M/CALL(PRIO)] once or twice to select memory mode, or push [V/MHz(SCAN)] to select VFO mode.

Call channel transferring

- ① Push [M/CALL(PRIO)] several times to select the call channel.
 - "C" appears.
- ② Push [MW(S.MW)] momentarily, then rotate the tuning dial to select the memory channel to transfer the contents to.
 - "M" indicator and memory channel number blink.
 - To transfer to the VFO, push [MW(S.MW)] for 1 sec.
- ③ Push [MW(S.MW)] for 1 sec. to transfer when a momentary push was used in the previous step.
 - If channel names have been programmed into the call channel, the names are also transferred.



- ① Push [MR/CALL] for 1 sec. to select the call channel.



- ② Push [FUNC], [CLR A(MW)] momentarily, then push [▲]/[▼] to select the memory channel to transfer the contents to.
 - To transfer to the VFO, push [FUNC], then push [CLR A(MW)] for 1 sec.



- ③ Push [FUNC], then [CLR A(MW)] for 1 sec. to transfer when a momentary push was used in the previous step.
 - If channel names have been programmed into the call channel, the names are also transferred.

■ Programming a call channel

Operating frequency, duplex information, subaudible tone information (tone encoder or tone squelch ON/OFF and its frequency) and alphanumeric channel names can also be programmed into the call channel.

- ① Set the desired frequency in VFO mode.
 - ➔ Push [V/MHz(SCAN)] to select VFO mode.
 - ➔ Set the frequency using the tuning dial.
 - ➔ Set other data as desired.
- ② Push [MW(S.MW)] momentarily.
- ③ Rotate the tuning dial to select the call channel
 - “M” indicator and “C” blink.

- ④ Push [MW(S.MW)] for 1 sec. to program.
 - 3 beeps sound and the unit returns to VFO mode automatically.

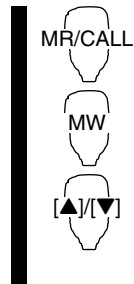
- 
- ① Set the desired frequency in VFO mode.
 - ➔ Push [VFO/LOCK] to select VFO mode.
 - ➔ Set the frequency.
 - ➔ Set other data as desired.
 - ② Push [FUNC], then [CLR A(MW)] momentarily.
 - ③ Select the call channel via [▲] or [▼].
 - ④ Push [FUNC] then [CLR A(MW)] for 1 sec. to program.
 - 3 beeps sound and the unit returns to VFO mode automatically.

[EXAMPLE]: Programming 145.120 MHz into the call channel via the microphone.

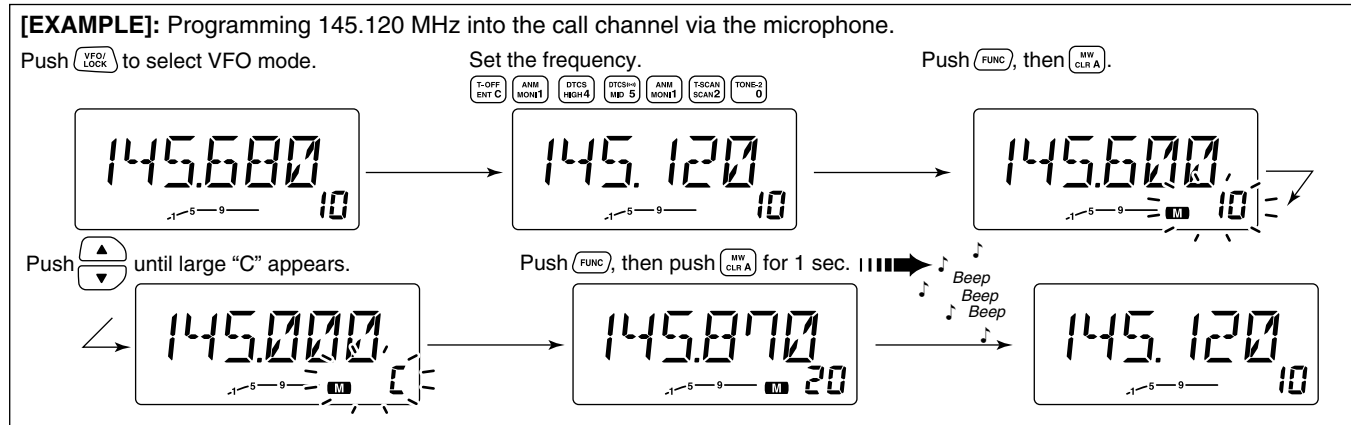

Push **[VFO/LOCK]** to select VFO mode.

Set the frequency.

Push **[FUNC]**, then **[MW CLR A]**.

Push **[▲/▼]** until large “C” appears.

Push **[FUNC]**, then push **[MW CLR A]** for 1 sec. **Beep Beep Beep**

■ Scan types

Scanning searches for signals automatically and makes it easier to locate new stations for contact or listening purposes.

There are 3 scan types and 4 resume conditions to suit your operating needs.

FULL SCAN (p. 38)

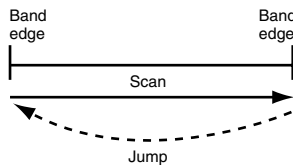

Repeatedly scans all frequencies over the entire band. Used as the simplest scan without any preliminary settings necessary.

PROGRAMMED SCAN (p. 38)

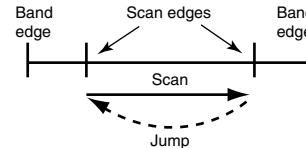

Repeatedly scans between two user-programmed frequencies. Used for checking for frequencies within a specified range such as repeater output frequencies, etc. 3 pairs of scan edges are available.

MEMORY SCAN (p. 38)

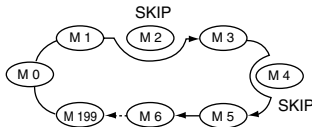

Repeatedly scans memory channels except those set as skip channels. Used for often-called channels and for bypassing normally busy channels such as repeater frequencies.

SCAN RESUME CONDITION (p. 42)

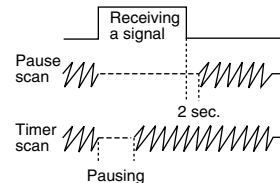

4 resume conditions are available: 3 timer scans and pause scan. When receiving a signal, pause scan pauses until the signal disappears; timer scans pause for 5, 10 or 15 sec.

NOTE: A tone scan function is available to search for subaudible tones (e.g. when you want to find a subaudible tone frequency necessary to open a repeater). See p. 51 for details.

■ Scan start/stop

◇ Preparation

Scan resume condition (p. 42); program the scan edges (pgs. 39, 40); program 2 or more memory channels (pgs. 25, 26); set skip settings, if desired (p. 41).

◇ Operation

- ① Select VFO mode for full/programmed scan with [V/MHz(SCAN)]; or memory mode for memory scan with [M/CALL(PRIO)].
 - Select the desired bank with [BANK(OPT)] for bank scan.
- ② Set the squelch to the point where noise is just muted.
- ③ Push [V/MHz(SCAN)] for 1 sec. to start the scan.
 - To change the scanning direction, rotate the tuning dial.
 - The memory channel readout blinks the scan type as follows:
- ④ Push [SET(LOCK)] to switch full and programmed scan (P1, P2 and P3).
- ⑤ To stop the scan, push [V/MHz(SCAN)].



- ① Push [VFO/LOCK] to select VFO mode for full/programmed scan; push [MR/CALL] to select memory mode for memory scan.
 - Push [BANK/OPTION] to select a bank for bank scan.
- ② Set the squelch to the point where noise is just muted.
- ③ Push [SCAN 2(T-SCAN)] to start the scan.
 - Push [▲] or [▼] for 1 sec. also starts the scan.
- ④ Push [SET B(D-OFF)] to switch full and programmed scan (P1, P2 and P3).
- ⑤ To stop the scan push [SCAN 2(T-SCAN)] or [CLR A(MW)].

• During full scan

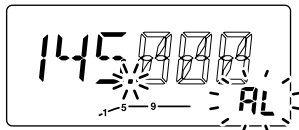

Push [SET(LOCK)] to select full or programmed scan (P1, P2 and P3) in sequence.

• During programmed scan

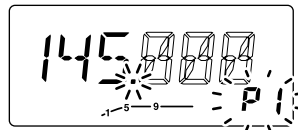

Indicates scan edge channels.

- P1 stands for 1A/1b
- P1 to P3 are available when they are programmed, and switches with [SET(LOCK)].

• During memory scan

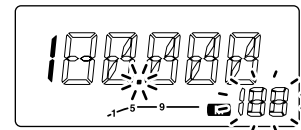

7 SCAN OPERATION

■ Scan edges programming

Scan edges can be programmed in the same manner as memory channels. Scan edges are programmed into scan edges, 1A/1b to 3A/3b, in memory channels.

- ① Set the edge frequency of the desired frequency range in VFO mode:
 - ➔ Set the frequency using the tuning dial.
 - ➔ Set other data (e.g. repeater settings, etc.) if desired.
- ② Push [MW(S.MW)] momentarily.
 - "M" indicator and channel number blink.
- ③ Rotate the tuning dial to select one of scan edge channel, 1A, 2A or 3A.

- ④ Push [MW(S.MW)] for 1 sec. to program.
 - 3 beeps sound and VFO is automatically selected.
 - Scan edge 1b, 2b or 3b is automatically selected when continuing to push [MW(S.MW)] after programming.
- ⑤ To program a frequency for the other pair of scan edges, 1b, 2b or 3b, repeat steps ① and ④.
 - If the same frequency is programmed into a pair of scan edges, programmed scan will not function.

[EXAMPLE]: Programming 145.300 MHz into scan edges 1A.

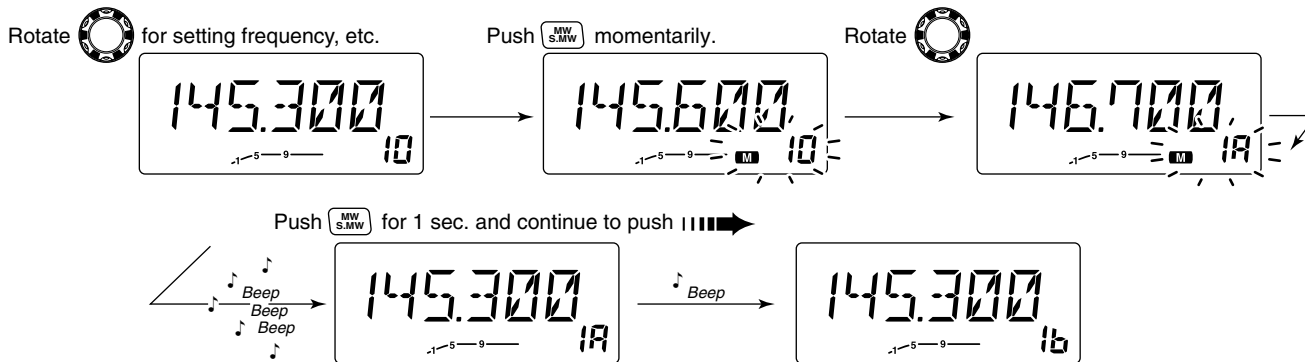

◇ Programming scan edges via microphone



- 1 Set the desired frequency in VFO mode.
 ➔ Push [VFO/LOCK] to select VFO mode.
 ➔ Set the frequency via the keypad or [▲]/[▼].
- 2 Push [FUNC] then [CLR A(MW)] momentarily.
- 3 Push [▲] or [▼] to select scan edge channels, 1A, 2A or 3A.
- 4 Push [FUNC], then push [CLR A(MW)] for 1 sec. to program.
 - 3 beeps sound and VFO is automatically selected.
 - Memory channel number advances to the next scan edge channel, 1b, 2b or 3b, when continuing to push [CLR A(MW)] after programming.

- 5 To program a frequency for the other scan edge channels, repeat steps 1 to 4.

[EXAMPLE]: Programming 145.300 MHz and 145.800 MHz into scan edges 1A and 1b, respectively.

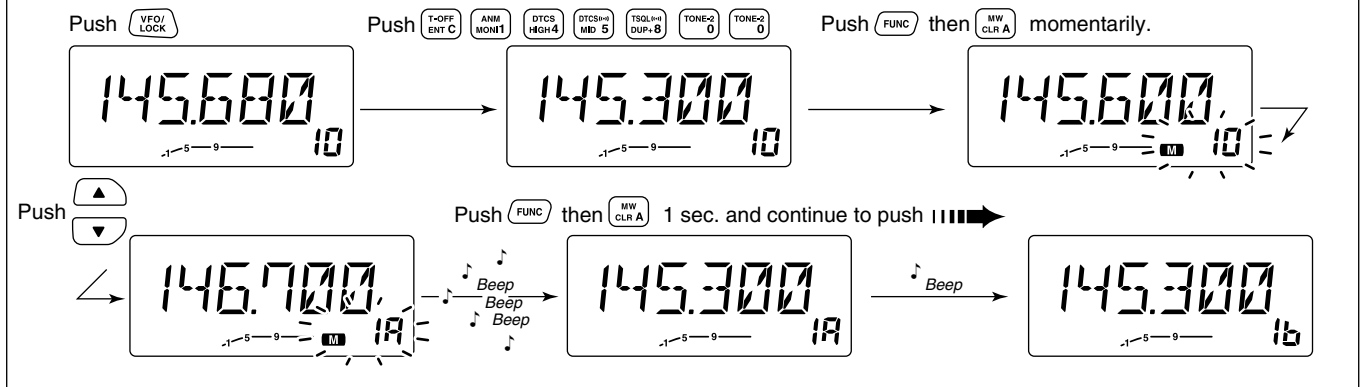

■ Skip channel setting

USING SET MODE

The memory skip function speeds up scanning by checking only those memory channels not set as skip channels. Set skip channels as follows.

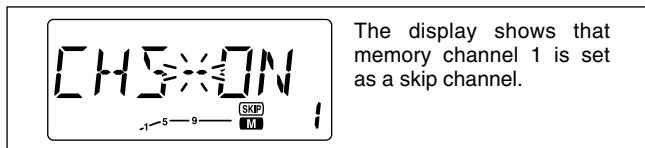

- ① Select a memory channel:
 - ➔ Push [M/CALL(PRIO)] to select memory mode.
 - ➔ Rotate the tuning dial to select the desired channel to be a skip channel.
- ② Push [SET(LOCK)] to enter set mode.
- ③ Push [SET(LOCK)] or [MW(S.MW)] several times until "CHS" appears as shown above.
- ④ Rotate the tuning dial to turn the skip function ON or OFF for the selected channel.
 - "SKIP" appears : The channel is skipped during scan. (CHS-ON)
 - "SKIP" disappears : The channel is scanned during scan. (CHS-OFF)
- ⑤ Push [TONE(T-SCAN)] to exit set mode.



- ① Select a memory channel.
 - ➔ Select memory mode by pushing [MR/CALL].
 - ➔ Push [▲] or [▼] to select the desired channel to be a skip channel.
- ② Push [SET B(D-OFF)] to enter set mode.
- ③ Push [SET B(D-OFF)] or [ENT C(T-OFF)] several times until "CHS" appears as shown at left.
- ④ Push [▲] or [▼] to set or cancel the skip setting.
 - See item ④ at left for skip indicator details.
- ⑤ Push [CLR A(MW)] to exit set mode.

NOTES:

Even though scan edge channels cannot be set as skip channels, they ARE skipped during memory scan.

SET mode cannot be accessed when memory names are displayed. To set the scan resume condition, return to frequency indication by pushing [MONI(ANM)] on the front panel for 1 sec., or push [FUNC] then [MONI 1(ANM)] (HM-133V) to cancel the channel name indication, then set as described on this page.

■ Scan resume condition

USING SET MODE

The scan resume condition can be selected as timer or pause scan. The selected resume condition is also used for priority watch. (p. 44)

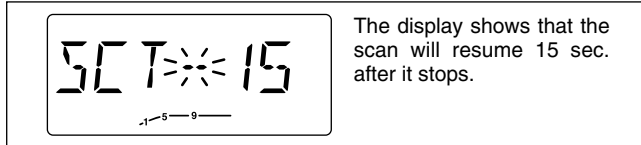

- ① Push [SET(LOCK)] to enter set mode.
- ② Push [SET(LOCK)] or [MW(S.MW)] several times until “SCT” or “SCP” appears as shown above.
 - When “d” is displayed in place of the 100 MHz digit, cancel the DTMF memory encoder in advance. (p. 46)
- ③ Rotate the tuning dial to set the desired timer:
 - “SCT-15” : Scan pauses 15 sec. while receiving a signal.
 - “SCT-10” : Scan pauses 10 sec. while receiving a signal.
 - “SCT-5” : Scan pauses 5 sec. while receiving a signal.
 - “SCP-2” : Scan pauses until the signal disappears and then resumes 2 sec. later.
- ④ Push [TONE(T-SCAN)] to exit set mode.



- ① Push [SET B(D-OFF)] to enter set mode.
- ② Push [SET B(D-OFF)] or [ENT C(T-OFF)] several times until “SCT” or “SCP” appears as shown at left.
- ③ Push [▲] or [▼] to select the scan resume condition.
 - See item ③ at left for scan resume condition details.
- ④ Push [CLR A(MW)] to exit set mode.

NOTE:

Set mode cannot be accessed when memory names are displayed. To set the scan resume condition, return to frequency indication by pushing [MONI(ANM)] on the front panel for 1 sec., or push [FUNC] then [MONI 1(ANM)] (HM-133V) to cancel the channel name indication, then set as described on this page.

Priority watch types

Priority watch checks for signals on a VFO frequency every 5 sec. while operating on a memory channel. The transceiver has 3 priority watch types to suit your needs. You can transmit on the VFO frequency while the priority watch operates.

The watch resumes according to the selected scan resume condition. See previous page for details.

NOTES:

- ▶ If the pocket beep function is activated, the transceiver automatically selects the tone squelch function when priority watch starts.

MEMORY CHANNEL WATCH

While operating on a VFO frequency, priority watch checks for a signal on the selected memory channel every 5 sec.

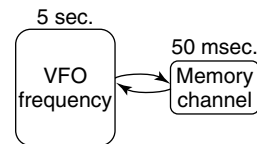

MEMORY SCAN WATCH

While operating on a VFO frequency, priority watch checks for signals on each memory channel in sequence.

- The memory skip function is useful to speed up the scan.

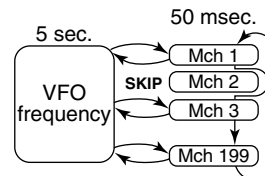

CALL CHANNEL WATCH

While operating on a VFO frequency, priority watch checks for signals on the call channel every 5 sec.

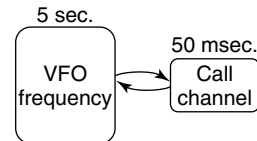

■ Priority watch operation

- ① Select VFO mode; then, set an operating frequency.
- ② Set the watching channel(s).
 - For memory channel watch:**
Select the desired memory channel.
 - For memory scan watch:**
Select memory mode; then, push [V/MHz(SCAN)] for 1 sec. to start memory scan.
 - For call channel watch:**
Select the call channel by pushing [M/CALL(PRIO)] several times.
- ③ Push [M/CALL(PRIO)] for 1 sec. to start the watch.
 - The transceiver checks the memory or call channel every 5 sec.
 - The watch resumes according to the selected scan resume condition. (p. 42)
 - While the watch is pausing, pushing [M/CALL(PRIO)] resumes the watch manually.
- ④ Push [M/CALL(PRIO)] while the display shows the memory channel to stop the watch.



While pausing or receiving a signal on the memory or call channel, "PRIO" and decimal point blink.



- ① Select VFO mode; then, set an operating frequency.
- ② Set the watching channel(s).
 - For memory channel watch:**
Push [MR/CALL] then [▲] or [▼] to select the desired memory channel.
 - For memory scan watch:**
Push [MR/CALL], then push [SCAN 2] to start the memory scan.
 - For call channel watch:**
Push [MR/CALL] for 1 sec. to select the call channel.
- ③ Push [PRIO 3(PTT-M)] to start the watch.
 - The transceiver checks the memory or call channel every 5 sec.
 - The watch resumes according to the selected scan resume condition. (p. 42)
 - To resume the watch manually when paused, push [PRIO 3(PTT-M)] or [CLR A(MW)].
- ④ To stop the watch, push [CLR A(MW)] once (or twice while watch is paused).

■ Programming a DTMF code

DTMF codes are used for autopatching, controlling other equipment, etc. The transceiver has 10 DTMF memory channels (d0–d9) for storage of often-used DTMF codes of up to 24 digits.



- 1 Push [FUNC] then [LOW 6(DTMF)] to turn the DTMF encoder ON.
 - “d” appears in place of the 100 MHz digit.
- 2 Push [SET B(D-OFF)] to enter the DTMF memory programming condition.
- 3 Push [▲] or [▼] to select the desired DTMF memory channel.

- 4 Push the desired digit keys.
 - When the first digit is input, previous memory contents are cleared automatically.
 - “E” stands for “*” and “F” stands for “#.”
 - Push [▲]/[▼] and repeat this step if you make a mistake.
 - The S/R/F indicator shows the digit group. The indication increases every 6 digits.
- 5 Push [VFO/LOCK] to exit the programming condition.
 - The [CLR A(MW)] key cannot be used to exit. If pushed, code “A” is input and the previously programmed data is erased. Reprogram in such a case.

[EXAMPLE]: Programming “5428A98” into DTMF memory channel “d4.”

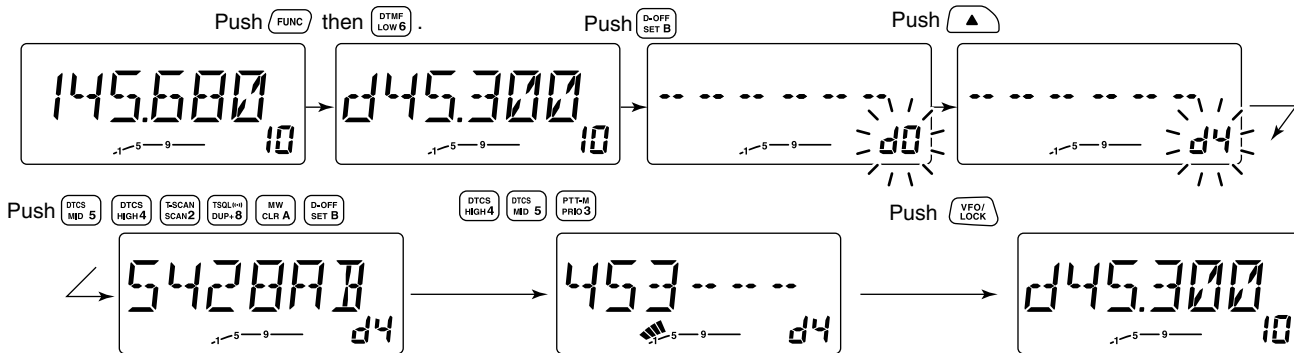

■ Transmitting a DTMF code

◇ Automatic transmission (DTMF memory)



- 1 Push [FUNC] then [LOW 6(DTMF)] to turn the DTMF memory encoder ON.
 - “d” appears in place of the 100 MHz digit.
- 2 Push [SET B(D-OFF)] to enter the DTMF memory programming condition.
- 3 Push [▲] or [▼] to select the desired channel.
- 4 Push [PTT] to transmit the selected memory.
 - Exit the programming condition automatically.
 - Each push of [PTT] transmits the DTMF code.
- 5 Push [FUNC] then [SET B(D-OFF)] to cancel the DTMF memory encoder.
 - When the DTMF encoder is turned ON continuously, each push of the PTT transmits the previously selected DTMF code.

◇ Transmitting a DTMF memory directly



- 1 Push [FUNC] then [LOW 6(DTMF)] to turn the DTMF memory encoder ON.
 - “d” appears in place of the 100 MHz digit.
- 2 Push [DTMF-S] to turn the DTMF memory direct selection ON.
 - The function indicator (microphone) lights green.
- 3 Push the desired DTMF channel number.
 - “0” to “9” are available for channel numbers.
 - The selected DTMF code is automatically transmitted without pushing PTT.

◇ Transmitting a DTMF memory directly— continued



- NOTE:** When no DTMF code programmed channel number is pushed, it transmits previously transmitted DTMF memory code.
- 4 Push [DTMF-S] again to deactivate the DTMF memory direct selection.
 - 5 Push [FUNC] then [SET B(D-OFF)] to cancel the DTMF memory encoder.

◇ Manual transmission



- 1 Deactivate the DTMF memory encoder by pushing [FUNC] then [SET B(D-OFF)].
- 2 Push [DTMF-S] to turn the DTMF direct selection ON.
 - The function indicator (microphone) lights green.
- 3 Push one of “A” to “F” keys momentarily, then push the desired DTMF keys, 0–9 and A to F.

• A: [CLR A(MW)]	B: [SET B(D-OFF)],
C: [ENT C(T-OFF)]	D: [SQL▲ D(MUTE)],
E: [* (TONE-1)]	F: [SQL▼ # (16KEY-L)]

 - Automatically transmits without pushing PTT.
 - The first code, one of “A” to “F,” is not transmitted. DTMF code transmission starts from the 2nd code.
- 4 Push [DTMF-S] again to deactivate the DTMF direct selection.

9 DTMF MEMORY ENCODER

■ DTMF speed USING INITIAL SET MODE

The rate at which DTMF memories send individual DTMF characters can be set to accommodate operating needs.

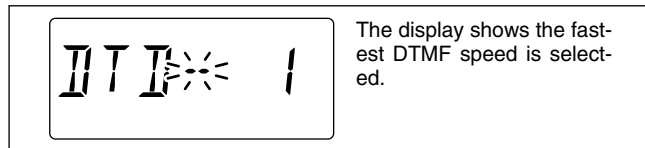

- ① Push [PWR] for 1 sec. to turn power OFF.
- ② While pushing [SET(LOCK)], push [PWR] for 1 sec. to turn power ON and enter initial set mode.
- ③ Push [SET(LOCK)] or [MW(S.MW)] several times until "DTD" appears as shown above.
- ④ Rotate the tuning dial to select the desired speed as shown in the table below.
- ⑤ Push [PWR] to exit initial set mode.

DISPLAY	INTERVAL	SPEED
DTD-- 1	100 msec.	5.0 cps
DTD-- 2	200 msec.	2.5 cps
DTD-- 3	300 msec.	1.6 cps
DTD-- 5	500 msec.	1.0 cps

cps=characters/sec

■ Pocket beep operation

This function uses subaudible tones for calling and can be used as a “common pager” to inform you that someone has called while you were away from the transceiver.

◇ Waiting for a call from a specific station

- ① Set the operating frequency.
- ② Push [SET(LOCK)] to enter set mode.

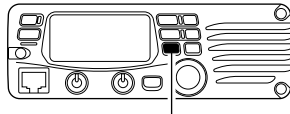

Push [SET(LOCK)] to enter set mode.

- ③ Push [SET(LOCK)] or [MW(S.MW)] several times until “Ct” for tone squelch or “dt” for DTCS squelch appears.



Tone squelch frequency setting

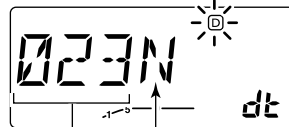

DTCS code Polarity N: normal
I: inverse

- ④ Rotate the tuning dial to select the desired tone squelch frequency or DTCS code and polarity.
- ⑤ Push [TONE(T-SCAN)] to exit set mode.

- ⑥ Push [TONE(T-SCAN)] several times until “|” or “|” are displayed to turn ON the pocket beep with tone squelch or DTCS squelch, respectively.

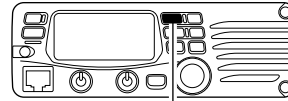

Push [TONE(T-SCAN)] several times to select the pocket beep function with tone squelch or DTCS squelch.

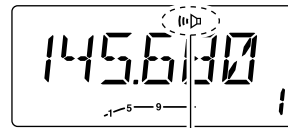

Appears when the pocket beep with tone squelch is activated.

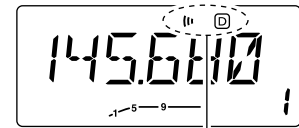









Appears when the pocket beep with DTCS squelch is activated.

- ⑦ When a signal with the matched tone is received, the transceiver emits beep tones and blinks “|”.
 - Beep tones sound for 30 sec. and “|” blinks. To stop the beeps and blinking manually, push any key. When the beep tones are not stopped manually, “|” continues flashing until step ⑧ is operated.
- ⑧ Push [PTT] to answer.
 - “|” disappears and cancels the pocket beep function automatically.
- ⑨ Push [TONE(T-SCAN)] several times until “|” or “|” disappears to cancel the tone squelch or DTCS squelch function.

10 POCKET BEEP AND TONE SQUELCH



- 1 Set the operating frequency.
- 2 Program the CTCSS tone frequency or DTCS code in set mode.
 - ➔ Push [SET B(D-OFF)] to enter set mode.
 - ➔ Push [SET B(D-OFF)] or [ENT C(T-OFF)] several times until “Ct” for tone squelch or “dt” for DTCS squelch appears.
 - “” blinks when tone squelch (“Ct”), or “” blinks when DTCS squelch (“dt”) is selected.
 - ➔ Push []/[] to select the desired tone frequency or DTCS code with polarity.
 - ➔ Push [CLR A(MW)] to exit set mode.
- 3 Push [FUNC] then push [DUP+ 8(TSQL ((·)))] or [MID 5(DTCS ((·)))] to turn ON the pocket beep with tone squelch or DTCS squelch, respectively.
- 4 When a signal with the matched tone is received, the transceiver emits beep tones for 30 sec. and blinks “”.
- 5 Push [PTT] to answer or push [CLR A(MW)] to stop the beeps and flashing.
 - “” disappears and cancels the pocket beep function automatically.
- 6 To cancel the tone squelch or DTCS squelch function, push [FUNC] then [ENT C(T-OFF)].
 - “” or “” disappears

◇ Available tone frequency list

67.0	79.7	94.8	110.9	131.8	156.7	171.3	186.2	203.5	229.1
69.3	82.5	97.4	114.8	136.5	159.8	173.8	189.9	206.5	233.6
71.9	85.4	100.0	118.8	141.3	162.2	177.3	192.8	210.7	241.8
74.4	88.5	103.5	123.0	146.2	165.5	179.9	196.6	218.1	250.3
77.0	91.5	107.2	127.3	151.4	167.9	183.5	199.5	225.7	254.1

NOTE: The transceiver has 50 tone frequencies and consequently their spacing is narrow compared to units having 38 tones. Therefore, some tone frequencies may receive interference from adjacent tone frequencies.

To prevent interference from adjacent tone frequencies, using the frequencies as in the following table, is recommended.

• Recommended tone frequencies



67.0	77.0	88.5	100.0	114.8	131.8	151.4	173.8	203.5	233.6
69.3	79.7	91.5	103.5	118.8	136.5	156.7	179.9	210.7	241.8
71.9	82.5	94.8	107.2	123.0	141.3	162.2	186.2	218.1	250.3
74.4	85.4	97.4	110.9	127.3	146.2	167.9	192.8	225.7	

◇ Calling a waiting station using pocket beep

A subaudible tone matched with the station’s CTCSS tone frequency or 3-digit DTCS code with polarity is necessary. Use the tone squelch on the next page or a subaudible tone encoder (pgs. 19, 50)

■ Tone/DTCS squelch operation

The tone or DTCS squelch opens only when receiving a signal with the same pre-programmed subaudible tone or DTCS code, respectively.

- ① Set the operating frequency.
- ② Program the CTCSS tone frequency or DTCS code in set mode.
 - See p. 48 for programming details.
- ③ Push [TONE(T-SCAN)] several times until “- “- When the received signal includes an unmatched tone, the squelch does not open. However, the S/Rf indicator shows the received signal strength.
- To open the squelch manually, push [MONI(ANM)].
- ⑤ Operate the transceiver in the normal way (push [PTT] to transmit; release [PTT] to receive).
- ⑥ To cancel the tone squelch, push [TONE(T-SCAN)] several times until “



- ① Set the operating frequency.
- ② Program the CTCSS tone frequency or DTCS code in set mode.
 - See p. 49 for programming details.
- ③ Push [FUNC] then [SIMP 9(TSQL)] or [HIGH 4(DTCS)] to turn the tone squelch or DTCS squelch ON.
- ④ When a signal with the matched tone is received, the squelch opens and the signal can be heard.
 - When the received signal includes an unmatched tone, the squelch does not open. However, the S/Rf indicator shows the received signal strength.
 - To open the squelch manually, push [MONI 1(ANM)].
- ⑤ Operate the transceiver in the normal way (push [PTT] to transmit; release [PTT] to receive).
- ⑥ To cancel the tone squelch, push [FUNC] then [ENT C(T-OFF)].
 - “10

10 POCKET BEEP AND TONE SQUELCH

■ Tone scan

By monitoring a signal that is being operated with pocket beep, tone or DTCS squelch function, you can determine the tone frequency or DTCS code necessary to open a squelch.

- ① Set the channel to be checked for a tone frequency or code.
- ② Push [TONE(T-SCAN)] several times to select the tone condition or type to be scanned.
 - One of “♪,” “♯” or “Ⓚ” appears
- ③ Push [TONE(T-SCAN)] for 1 sec. to start the tone scan.
 - To change the scanning direction, rotate the tuning dial.

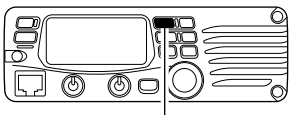

Push [TONE(T-SCAN)] for 1 sec. starts tone scan.

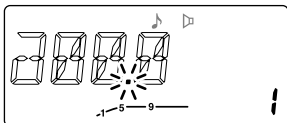

During CTCSS tone scan

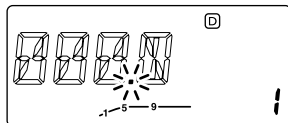

During DTCS code scan

NOTE: The decoded tone frequency is programmed temporarily when a memory or call channel is selected. However, this will be cleared when the memory/call channel is re-selected.

- ④ When the CTCSS tone frequency or 3-digit DTCS code is matched, the squelch opens and the tone frequency is temporarily programmed into the selected condition such as memory or call channel.
 - The tone scan pauses when a CTCSS tone frequency or 3-digit DTCS code is detected.
 - The decoded CTCSS tone frequency or 3-digit DTCS code is used for the tone encoder or tone encoder/decoder depending on the selected tone condition or type in step ②.
 - No indication : Cannot be used for operation.
 - “♪” : CTCSS tone encoder
 - “♯” : CTCSS tone encoder/decoder
 - “Ⓚ” : DTCS tone encoder/decoder
- ⑤ Push [V/MHz(SCAN)] to stop the scan.



- ① Set the channel to be checked for a tone frequency.
- ② Selects the tone condition or type to be scanned.
 - Push [FUNC] then push; [DUP- 7(TONE)] for repeater tone; [SIMP 9(TSQL)] for tone squelch; [HIGH 4(DTCS)] for DTCS squelch.
- ③ Push [FUNC] then [SCAN 2(T-SCAN)] to start the tone scan.
- ④ When the tone frequency is matched, the squelch opens and the tone frequency is programmed into the selected mode such as memory or call channel.
- ⑤ Push [CLR A(MW)] to stop the scan.

■ Pager function Optional UT-108 required

This function uses DTMF codes for paging and can be used as a “message pager” to inform you of a caller’s identification even when you leave the transceiver temporarily unattended.

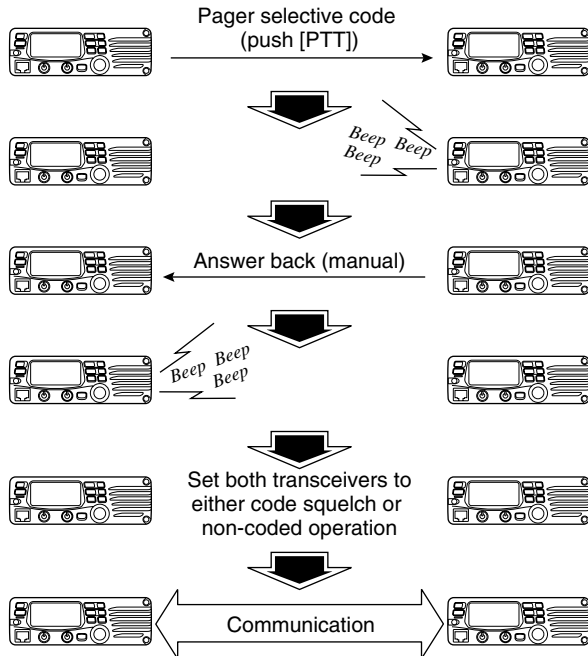

■ Code programming Optional UT-108 required

◇ Before programming

The pager and code squelch functions require ID codes and a group code. These codes are 3-digit DTMF codes and must be written into the code channels before operation.

- ① Decide the ID code of each transceiver and a group code for your group.
- ② Decide whether you want to return to normal operation or code squelch operation after a connection is made.
- ③ Program the ID code, group code and transmit codes (other station’s codes) as below.

◇ Code channel assignment

ID OR GROUP CODE	CODE CHANNEL NUMBER	“RECEIVE ACCEPT” OR “RECEIVE INHIBIT”
Your ID code	0	“Receive accept” only
Other parties’ ID code	1–6	“Receive inhibit” should be programmed in each channel.
Group code	One of 1–6	“Receive accept” must be programmed.
Memory space*	P	“Receive inhibit” only.

*Channel CP automatically memorizes an ID code when receiving a pager call. The contents in channel CP cannot be changed manually.

10
11

11 PAGER/CODE SQUELCH

◆ Code programming

An ID code **MUST** be programmed into code channel C0. Up to 6 transmit codes are programmable into code channels, C1 to C6, if required.

- ① Push [BANK(OPT)] for 1 sec.

- Pager mode is selected.
- 100 MHz digit shows “P.”

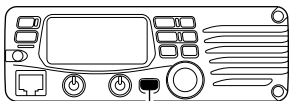

Push [BANK(OPT)] for 1 sec.

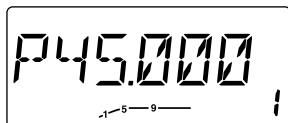

Pager mode indication

- ② Push [SET(LOCK)].

- One of either “CP” or “C0” to “C6” flashes.
- “C0” is the ID code and “C1” to “C6” are transmit codes.

- ③ Rotate the tuning dial to select code channel C0.

- A different ID code must be programmed into each transceiver.



- ④ Push [MW(S.MW)] to set into code programming condition.

- The 1st digit blinks and “C0” indication stops blinking.

- ⑤ Rotate the tuning dial to set the desired code.

- ⑥ Push [MW(S.MW)] to select 2nd digit, then rotate the tuning dial to set the desired code.

- 2nd digit blinks (1st digit stop blinking).
- Repeat this step for 3rd digit programming.

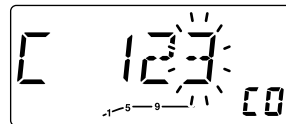

- ⑦ Push [MW(S.MW)] to program the ID code.

- Long beep sounds and the “C0” indication blinks.

- ⑧ Rotate the tuning dial to select a transmit code channel from “C1” to “C6.”

- ⑨ Repeat steps ④ to ⑦ to set transmit code channel.

- ⑩ Push [BANK(OPT)] to set the channel for “receive inhibit” or “receive accept.”

- When “receive inhibit” is set, “SKIP” appears as follows.
- Code channel C0 cannot be set as “receive inhibit.”
- See p. 54 for “receive accept” and “receive inhibit” details.

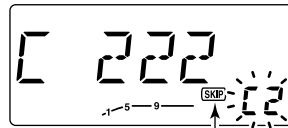

Appears when “receive inhibit” is set to the code channel.

- ⑪ Push [TONE(T-SCAN)] to return to the condition in step ①.

BANK/OPTION



- 1 Push [BANK/OPTION] for 1 sec. to select pager mode.
 - 100 MHz digit shows "P."
- 2 Push [SET B(D-OFF)] to enter to the code set mode.
 - One of either "CP" or "C0" to "C6" blinks.
 - "C0" is the ID code and "C1" to "C6" are the transmit code.
- 3 Push [▲] or [▼] to select the desired code channel.
- 4 Enter the desired 3-digit code via the keypad.
- 5 Push [SET B(D-OFF)] to set the channel for "receive inhibit" or "receive accept".
 - When "receive inhibit" is set, "SKIP" appears.
 - Code channel C0 cannot be set as "receive inhibit."
 - See right above for "receive accept" and "receive inhibit" details.
- 6 Repeat steps 3 to 5 to set additional code channels, if desired.
- 7 Push [CLR A(MW)] to exit code set mode.

• Receive accept/receive inhibit

- ↳ "Receive accept" ("SKIP" indicator does not appear) accepts pager calls when the transceiver receives a signal with a code the same as that in the code channel.
- ↳ "Receive inhibit" ("SKIP" indicator appears) rejects calls even when the transceiver receives a code the same as that in the code channel. Transmit codes should therefore be programmed for "receive inhibit," otherwise the transceiver will not reject unnecessary calls.

• Pager/code squelch operation during channel indication

To use these functions in channel indication, the pager/code squelch setting must be programmed with other memory contents before selecting channel number indication.

■ Pager operation

Optional UT-108 required

◇ Calling a specific station

- ① Program the desired code channel in advance (p. 53).
- ② Set the operating frequency.
 - Set the [VOL] and [SQL] to the desired level as in normal operation.
- ③ Push [BANK(OPT)] for 1 sec. to select pager mode.
 - 100 MHz digit shows “P.”

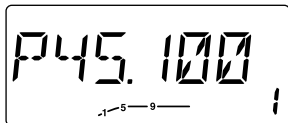

- ④ Select the desired transmit code channel:
 - ➔ Push [SET(LOCK)].
 - ➔ Rotate the tuning dial to select the code channel.
 - ➔ Push [TONE(T-SCAN)] to return to the previous condition.
- ⑤ Push [PTT] to transmit the pager code.
 - Transmits your ID and the selected transmit codes automatically.
- ⑥ Wait for an answer back.
 - When the transceiver receives an answer back code, the function display shows the other member's ID or group code.
- ⑦ After confirming a connection, push [BANK(OPT)] for 1 sec. to select the code squelch operation, or repeat the previous key operation again to select non-selective calling system.
- ⑧ Communicate with the other party as normal: push [PTT] to transmit; release to receive.



- ① Program the desired code channel in advance (p. 54).
- ② Set the operating frequency.
- ③ Push [BANK/OPTION] for 1 sec. to select pager mode.
 - 100 MHz digit shows “P.”
- ④ Select the desired transmit code channel:
 - ➔ Push [SET(LOCK)].
 - ➔ Push [▲]/[▼].
 - ➔ Push [CLR A(MW)] to return to the previous condition.
- ⑤ Push [PTT] to transmit the pager code.
- ⑥ Wait for an answer back.
 - When the transceiver receives an answer back code, the function display shows the other member's ID or group code.
- ⑦ After confirming a connection, push [BANK/OPTION] for 1 sec. to select the code squelch operation, or repeat the previous key operation again to select non-selective calling system.
- ⑧ Communicate with the other party as normal: push [PTT] to transmit; release to receive.

◇ Waiting for a call from a specific station



- ① Set the operating frequency.
- ② Push [BANK(OPT)] for 1 sec.
 - 100 MHz digit shows “P.”
- ③ Wait for a call.
 - When receiving a call, the caller’s ID or group code appears as shown at right.
- ④ Push [PTT] to send an answer back call and display the operating frequency.
- ⑤ After confirming a connection, push [BANK(OPT)] for 1 sec. to select code squelch operation, or repeat the previous key operation again to select non-selective calling system.

BANK/OPTION



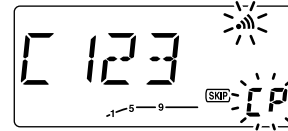

- ① Set the operating frequency.
- ② Push [BANK/OPTION] for 1 sec.
 - 100 MHz digit shows “P.”
- ③ Wait for a call.
 - When receiving a call, the caller’s ID or group code appears as shown at right.
 - DO NOT push any digit keys while code channels C0 to C6 are displayed, or code channel contents will be changed.
- ④ Push [PTT] to send an answer back call and display the operating frequency.
- ⑤ After confirming a connection, push [BANK/OPTION] for 1 sec. to select code squelch operation, or repeat the previous key operation again to select non-selective calling system.

• PERSONAL CALLS

CP and  blink.

This display appears when you are called with your ID code and the calling station’s ID code is 123.

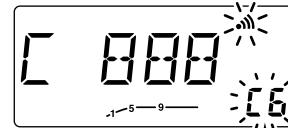
• GROUP CALLS

Code channel 

This display appears when you are called with the group code, 888, and 888 has been programmed into code channel C6.

• ERROR INFORMATION

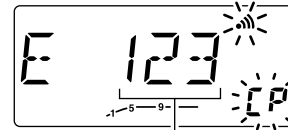

Previously received code.

When the transceiver receives an incomplete signal, “E” and previously received code appear.

■ Code squelch Optional UT-108 required

Code squelch provides communications with quiet standby since you will only receive calls from stations which know your ID or group code. Each push of [PTT] sends a 3-digit code in order to open the receiving station's code squelch prior to voice transmission.

- ① Set the operating frequency.
 - Set the AF and squelch to the desired level as in normal operation.
- ② Push [BANK(OPT)] for 1 sec. once or twice to select code squelch mode.
 - 100 MHz digit shows "C."

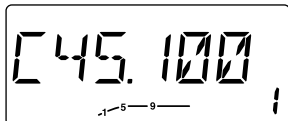

- ③ Select the desired transmit code channel:
 - ➔ Push [SET(LOCK)].
 - ➔ Rotate the tuning dial to select the code channel.
 - ➔ Push [TONE(T-SCAN)] to exit code set mode.
- ④ Operate the transceiver in the normal way (push [PTT] to transmit; release [PTT] to receive).
- ⑤ To cancel the code squelch, push [BANK(OPT)] for 1 sec.
 - 100 MHz digit shows "1" when the function is cancelled.



- ① Set the operating frequency.
- ② Push [BANK/OPTION] for 1 sec. once or twice to select code squelch mode.
 - 100 MHz digit shows "C."
- ③ Select the desired transmit code channel:
 - ➔ Push [SET(LOCK)].
 - ➔ Push [▲]/[▼].
 - ➔ Push [CLR A(MW)] to return to previous condition.
- ④ Communicate with the other party as normal: push [PTT] to transmit; release to receive.
- ⑤ To cancel the code squelch, push [BANK/OPTION] for 1 sec.

■ Set mode

• Set mode operation

- ① Push [SET(LOCK)] to enter the set mode.
- ② Push [SET(LOCK)] or [MW(S.MW)] to select the desired item.
- ③ Rotate the tuning dial to select the condition or value.
- ④ Push [TONE(T-SCAN)] to exit set mode.



- 1 Push [SET B(D-OFF)] to enter set mode.
- 2 Push [SET B(D-OFF)] or [ENT C(T-OFF)] to select the desired item.
- 3 Push [▲] or [▼] to select the condition or value.
- 4 Push [CLR A(MW)] to exit set mode.

• Set mode items

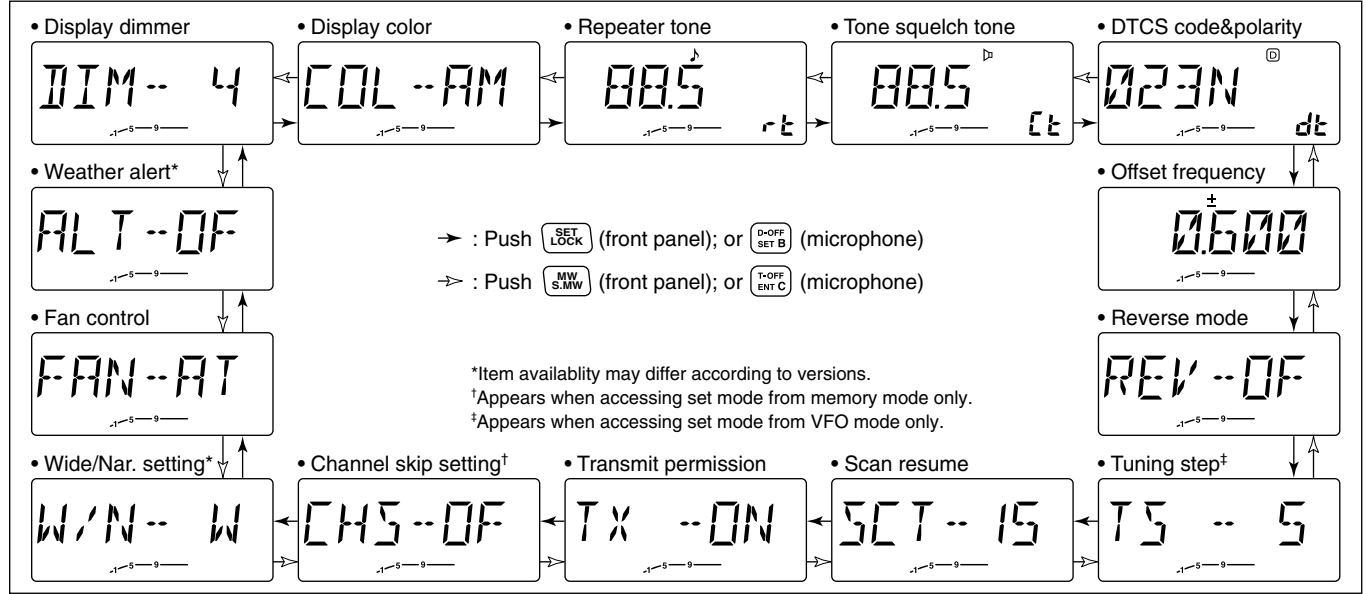

12 OTHER FUNCTIONS

◆ Display dimmer

Adjust to suit lighting conditions.

The levels 1 (dark) to 4 (bright: default) are available.

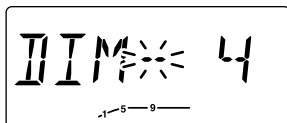

◆ Display color

The display color can be set to amber (default) or green.

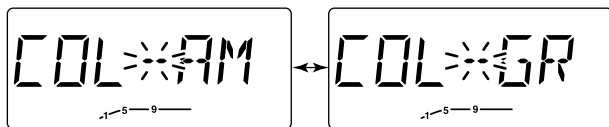

Amber setting (default)

Green setting

◆ Repeater tone

Sets subaudible tone frequency (encoder only) for repeater operation. Total of 50 tone frequencies (67.0–254.1 Hz) are available. (default: 88.5 Hz)



◆ Tone squelch tone

Sets subaudible tone frequency (both encoder and decoder) for tone squelch operation. Total of 50 tone frequencies (67.0–254.1 Hz) are available. (default: 88.5 Hz)



◆ Available subaudible tone frequencies

67.0	79.7	94.8	110.9	131.8	156.7	171.3	186.2	203.5	229.1
69.3	82.5	97.4	114.8	136.5	159.8	173.8	189.9	206.5	233.6
71.9	85.4	100.0	118.8	141.3	162.2	177.3	192.8	210.7	241.8
74.4	88.5	103.5	123.0	146.2	165.5	179.9	196.6	218.1	250.3
77.0	91.5	107.2	127.3	151.4	167.9	183.5	199.5	225.7	254.1

◆ DTCS code and polarity

Sets DTCS code (both encoder and decoder) for DTCS squelch operation. Total of 208 codes (104 codes for each normal and inverse polarities) are available. (default: 023N)

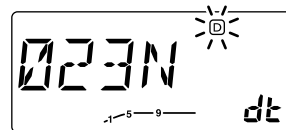

◆ Offset frequency

Sets the duplex offset frequency within 0 to 20 MHz range. During duplex (repeater) operation, transmit frequency (or receive when reverse function is set to ON) shifts the set frequency. (default value may differ depending on versions)

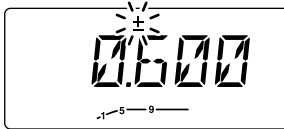

◆ Reverse mode

Sets the reverse function ON and OFF (default).

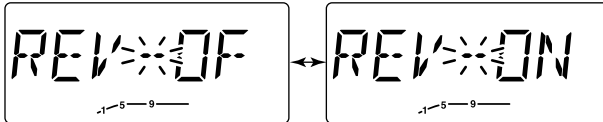

Reverse function OFF (default) Reverse function ON

◆ Tuning step

Selects tuning step from 5 (default), 10, 12.5, 15, 20, 25, 30 and 50 kHz for the tuning dial or [▲]/[▼] operation.

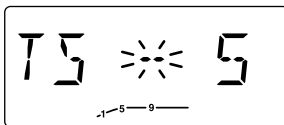

◆ Scan resume timer

Selects scan resume timer from SCT-15 (default), SCT-10, SCT-5 and SCP-2.

- SCT-15/10/5 : Scan pauses for 15/10/5 sec., then resumes.
- SCP-2 : Pause on a signal until signal disappears, then resumes 2 sec. after the signal disappears.

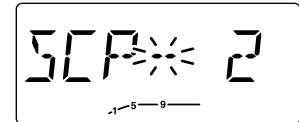
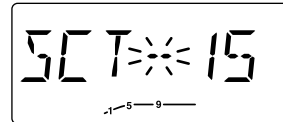

◆ Transmit permission

Turns transmission permission ON and OFF. This function can be set for each memory, call channel and VFO, independently.

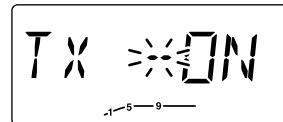

Transmission is permitted.
(default)

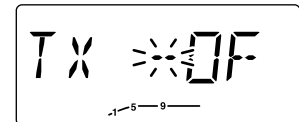

Transmission is inhibited.

12 OTHER FUNCTIONS

◆ Channel skip setting

Sets channel skip setting from ON and OFF for memory skip scan operation.

This item appears when set mode is accessed from memory mode only.

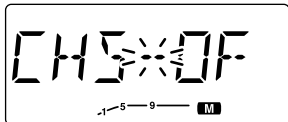

Scans the memory channel.
(does not skip; default)

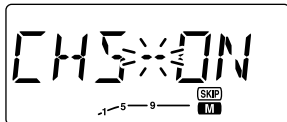

Does not scan the memory
channel (skips).

◆ Wide/Narrow setting

Sets both the transmission and reception passband width from wide and narrow.

When narrow is set, the transmission deviation and reception passband width become half of the wide setting (approx.).

This setting can be set for each memory, call and VFO independently.

This item appears in some USA versions only.

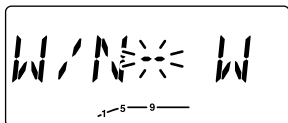

Wide setting (default)

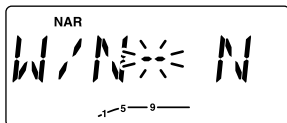

Narrow setting

◆ Cooling fan control

Selects the cooling fan control condition from Auto, ON-High, ON-Mid. and ON-Low.

- Auto (AT) : The fan rotates during transmit and for 2 min. after transmission in either high, middle or low speed, according to the transceiver temperature.
- ON-High (OH)/Mid. (OM)/Low (OL):
The fan continuously rotates in high, middle or low speed, respectively.

NOTE: When the transceiver internal temperature exceeds +45°C (approx.; +113°F), the fan continuously rotates at middle or high speed, regardless of this setting.

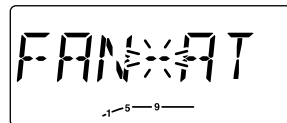

Auto setting (default)

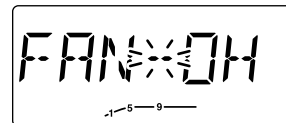

Continuously ON with high
speed setting.

◆ Weather alert function

U.S.A. versions only

Turns weather alert function ON and OFF.

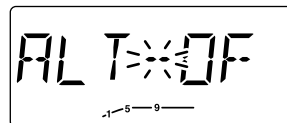

Weather alert OFF (default)

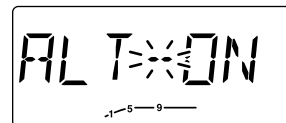

Weather alert ON

■ Initial set mode

AT POWER ON

The initial set mode is accessed at power ON and allows you to set seldom-changed settings. In this way, you can “customize” transceiver operations to suit your preference and operating style.

• Initial set mode items

◇ Entering initial set mode

- ① While pushing [SET(LOCK)], push [PWR] for 1 sec. to enter initial set mode.
- ② Push [SET(LOCK)] or [MW(S.MW)] to select the desired item.
- ③ Rotate the tuning dial to select the condition or value.
- ④ Push [PWR] to exit initial set mode.

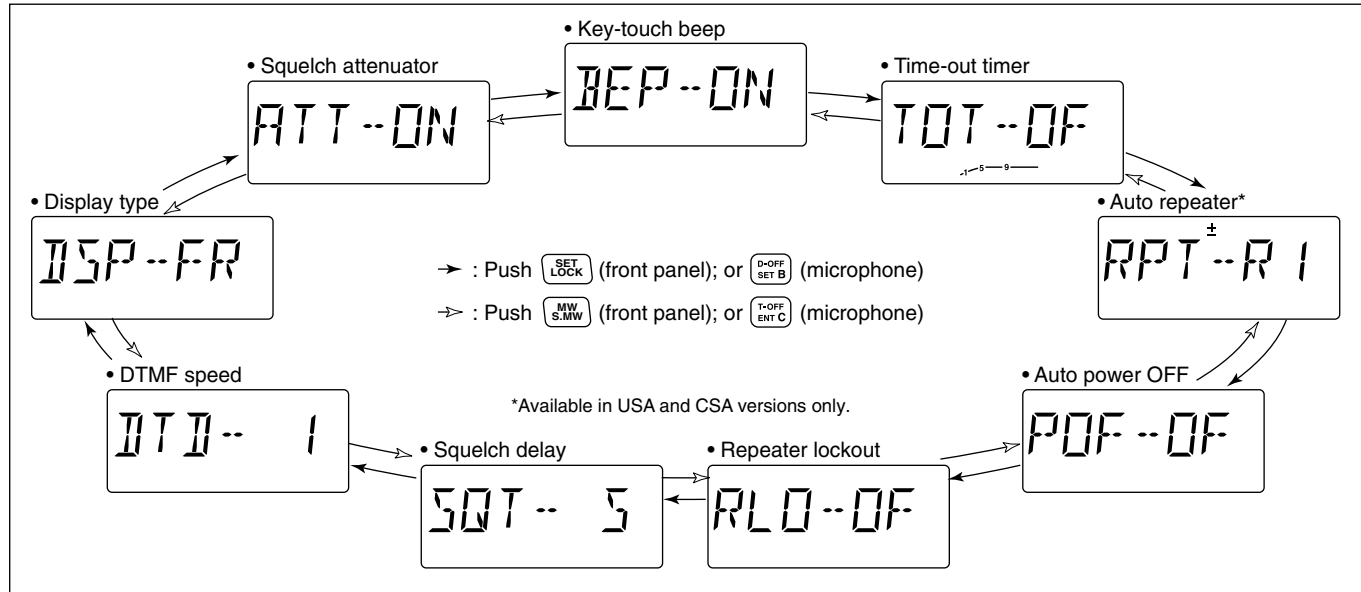

12 OTHER FUNCTIONS

◆ Key-touch beep

The key-touch beep can be turned OFF for silent operation. (default: ON)

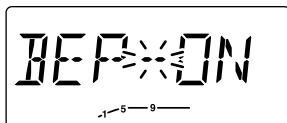

◆ Time-out timer

To prevent accidental prolonged transmission, etc., the transceiver has a time-out timer. This function cuts a transmission OFF after 1–30 min. of continuous transmission. This timer can be cancelled.

- TOT-OFF : The time-out timer is turned OFF. (default)
- TOT-1–30 : The transmission is cut OFF after the set period elapses.

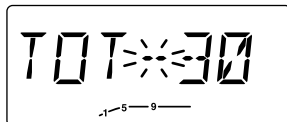
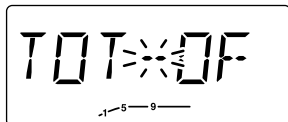

◆ Auto repeater

U.S.A. and C.S.A. versions only

The auto repeater function automatically turns ON or OFF the duplex operation with a specified shift direction and tone encoder, when the operating frequency falls within or outside of 145.200–145.495 MHz, 146.610–146.995 MHz and 147.000–147.395 MHz range. The offset and repeater tone frequencies are not changed by the auto repeater function, reset these frequencies, if necessary.

- OF : The auto repeater function is turned OFF.
- R1 : Activates for duplex only. (default)
- R2 : Activates for duplex and tone.

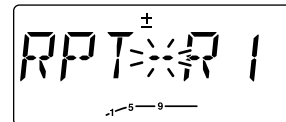
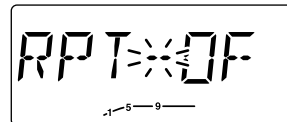

◆ Auto power OFF

The transceiver can be set to automatically turn OFF after a specified period with a beep when no key operations are performed.

30 min., 1 hour, 2 hours and OFF (default) can be specified. The specified period is retained even when the transceiver is turned OFF by the auto power OFF function. To cancel the function, select "OF" in this set mode.

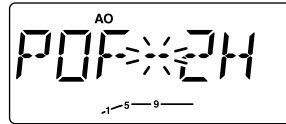
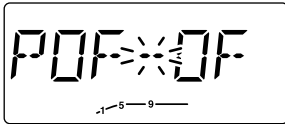

◆ Repeater lockout

Selects lockout type from repeater, busy and OFF.

- OF : No lockout is activated. (default)
- RP : The repeater lockout is turned ON.
- BU : The busy lockout is turned ON.

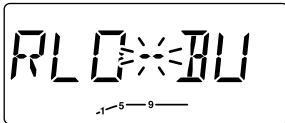

Busy lock-out setting

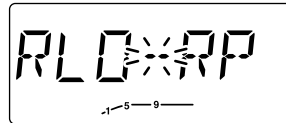

Repeater lock-out setting

◆ Squelch delay

Selects squelch delay from short and long to prevent repeated opening and closing of the squelch during reception of the same signal.

- S : Short squelch delay. (default)
- L : Long squelch delay

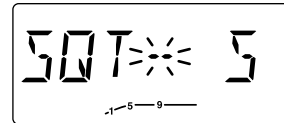

Short squelch delay setting

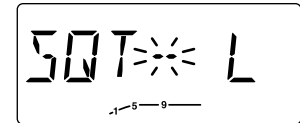

Long squelch delay setting

◆ DTMF speed

The rate at which DTMF memories send individual DTMF characters can be set to accommodate operating needs.

- 1 : 100 msec. interval; 5.0 cps speed (default)
- 2 : 200 msec. interval; 2.5 cps speed
- 3 : 300 msec. interval; 1.6 cps speed
- 5 : 500 msec. interval; 1.0 cps speed

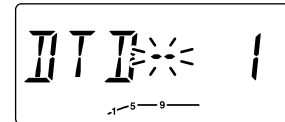

12 OTHER FUNCTIONS

◆ Display type

Selects LCD indication type from frequency, channel number and channel names.

- FR : Shows frequency (default)
- CH : Shows channel number*
- NM : Shows channel names*

*Memory channels only can be selected.

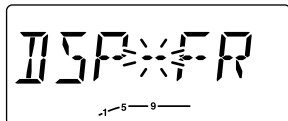

Frequency indication setting

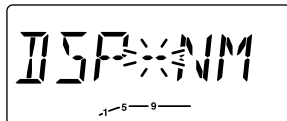

Memory channel name indication setting

◆ Squelch attenuator

Turns the squelch attenuator function ON and OFF.

- ON : The squelch attenuator activates when [SQL] control is set between 12 o'clock and fully clockwise position. (default)
- OF : The squelch attenuator does not function.

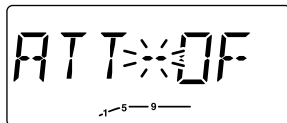
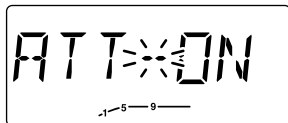

■ Weather channel operation

U.S.A. versions only

◆ Weather channel selection

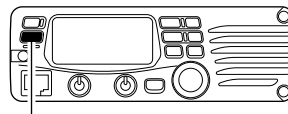

Push [M/CALL(PRIO)] several times to select the WX channel.

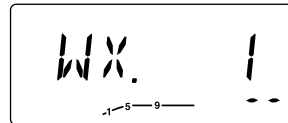

- ① Push [M/CALL(PRIO)] several times to select weather channel group.
- ② Rotate the tuning dial to select the desired weather channel.
- ③ Push [M/CALL(PRIO)] to select memory mode, or push [V/MHz(SCAN)] to select VFO mode.

◆ Weather alert function

NOAA broadcast stations transmit weather alert tones before important weather announcements. When the weather alert function is turned ON, the selected weather channel is monitored each 5 sec. for the announcement. When the alert signal is detected, the “AL.T” and the WX channel are displayed alternately and sounds a beep tone until the transceiver is operated. The previously selected (used) weather channel is checked periodically during standby or while scanning.

- ① Select the desired weather channel.
- ② Turn the weather alert function ON in set mode.
 - ➔ Push [SET(LOCK)] to enter set mode.
 - ➔ Push [SET(LOCK)] or [MW(S.MW)] to select the weather alert item, then rotate the tuning dial to set ON.
 - ➔ Push [TONE(T-SCAN)] to exit set mode.
- ③ Sets the desired stand-by condition.
 - Selects VFO, memory or call channel.
 - Scan or priority watch operation can also be selected.
- ④ When the alert is detected, a beep sounds and the following indication will be displayed.

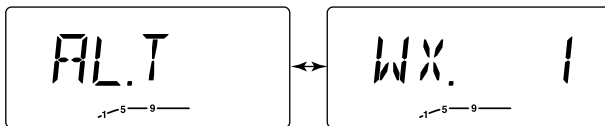

Shows above indications alternately.

- ⑤ Turn the weather alert function OFF in set mode.

NOTE: While receiving a signal (on a frequency other than the weather alert ON frequency), the receiving signal or audio will be interrupted momentarily every 5 sec. (approx.) in case the alert function is turned ON. This symptom is caused by the WX alert function. To cancel these symptoms, set the weather alert item OFF in set mode.

12 OTHER FUNCTIONS

■ Microphone keys

The supplied HM-133V's (optional for some versions) [F-1] and [F-2] keys memorize the transceiver conditions.

The [UP]/[DN] keys of the standard or an optional microphone (other than the HM-133V) can be assigned functions like the function keys on the transceiver's front panel.

◇ [F-1]/[F-2] keys on HM-133V

The following conditions can be memorized into [F-1] and [F-2] keys, independently.

- Operating frequency
- Repeater setting (offset direction and frequency, tone ON/OFF and frequency)
- Tone/DTCS squelch (ON/OFF, frequency/code and polarity)
- Transmit output power selection
- Set mode settings
- Initial set mode settings (except display type item)



➔ **Programming the condition**

Set the desired contents of each condition, then push [F-1]/[F-2] for 1 sec.

- 3 beeps sound.

➔ **Re-calling the condition**

Push [F-1]/[F-2] momentarily.

◇ [UP]/[DN] keys on a microphones (other than HM-133V)

AT POWER ON

The following functions are assigned to the [UP]/[DN] keys on the other microphones (HM-118N/TAN, etc.) when first applying power.

[UP] : channel up; push and hold to start scan, push again to stop scan.

[DN] : channel down; push and hold to start scan, push again to stop scan.

➔ **Assigning a function**

- ① Turn the power OFF.
- ② While pushing the desired switch on the transceiver and one of either [UP]/[DN] keys on the microphone, turn the power ON.
 - The function is programmed into the key.

➔ **Clearing an assignment**

- ① Turn the power OFF.
- ② While pushing the desired [UP] or [DN] key on the microphone, turn the power ON.

■ Partial reset

AT POWER ON

If you want to initialize the operating conditions (VFO frequency, VFO settings, set mode contents) without clearing the memory contents, a partial resetting function is available for the transceiver.

- ➔ While pushing [V/MHz(SCAN)], turn the power ON to partially reset the transceiver.

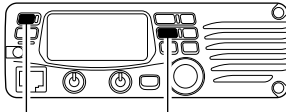

While pushing [V/MHz(SCAN)], turn power ON.

■ All reset

AT POWER ON

The function display may occasionally display erroneous information (e.g. when first applying power). This may be caused externally by static electricity or by other factors.

If this problem occurs, turn power OFF. After waiting a few seconds, turn power ON again. If the problem persists, perform the following procedure.

- Partial resetting is also available. See left for details.

/// IMPORTANT!:

Resetting the transceiver **CLEARs** all memory information and initializes all values in the transceiver.

- ➔ While pushing [SET(LOCK)] and [MW(S.MW)], turn the power ON to reset the CPU.

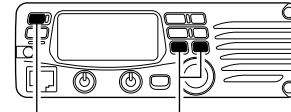

While pushing [SET(LOCK)] and [MW(S.MW)], turn power ON.

12 OTHER FUNCTIONS

■ Data cloning

AT POWER ON

Cloning allows you to quickly and easily transfer the programmed contents from one transceiver to another; or, data from a personal computer to a transceiver using the optional CS-V8000 CLONING SOFTWARE.

◇ Cloning between transceivers

- ① Connect the OPC-474 cloning cable to the [SP] jack of the master and sub-transceivers.

- The master transceiver is used to send data to the sub-transceiver.

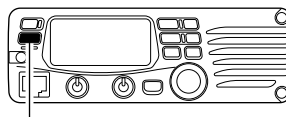
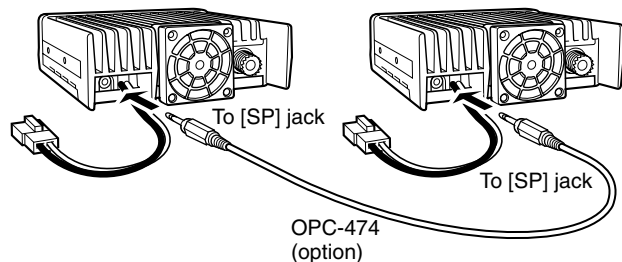

While pushing [M/CALL(PRIO)], turn power ON.

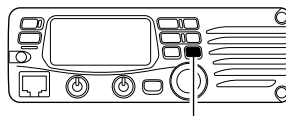

Pushing [MW(S.MW)] to start cloning (master transceiver).

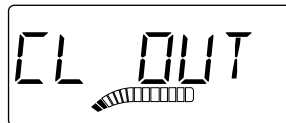

- ② While pushing [M/CALL(PRIO)], turn power ON to enter cloning mode (master transceiver only— power on only for sub-transceiver).

- “CLONE” appears and the transceivers enter the clone standby condition.

- ③ Push [MW(S.MW)] on the master transceiver.

- “CL OUT” appears in the master transceiver’s display and the S/R/F indicator shows that data is being transferred to the sub-transceiver.
- “CL IN” appears automatically in the sub-transceiver’s display and the S/R/F indicator shows that data is being received from the master transceiver.

- ④ When cloning is finished, turn power OFF, then ON to exit cloning mode.

◇ Cloning using a personal computer

Data can be cloned to and from a personal computer (Microsoft® Windows® 95/98/ME) using the optional CS-V8000 CLONING SOFTWARE and the optional OPC-478 CLONING CABLE. Consult the CS-V8000 CLONING SOFTWARE HELP file for details.

◇ Cloning error

NOTE: DO NOT push any key on the sub-transceiver during cloning. This will cause a cloning error.



When the display at left appears, a cloning error has occurred.

In such a case, both transceivers automatically return to the clone standby condition and cloning must be repeated.

13 MAINTENANCE

■ Troubleshooting

If your transceiver seems to be malfunctioning, please check the following points before sending it to a service center.

PROBLEM	POSSIBLE CAUSE	SOLUTION	REF.
No power comes on.	<ul style="list-style-type: none"> • Power connector has a poor contact. • Polarity of the power connection is reversed. • Blown fuse. 	<ul style="list-style-type: none"> • Check the connector pins. • Re-connect the power cable observing the proper polarity. Replace the fuse if damaged. • Check the cause, then replace the fuse. 	— pgs. II, 72 p. 72
No sound comes from the speaker.	<ul style="list-style-type: none"> • Volume is too low. • The audio mute function is activated. • Squelch is set too tight. • A selective call or squelch function is activated such as pocket beep or tone squelch. 	<ul style="list-style-type: none"> • Rotate [VOL] clockwise. • Push any switch or key to deactivate it. • Set the squelch level to the threshold. • Turn the appropriate function OFF. 	p. 13 p. 14 p. 13 pgs. 48, 49, 50
Sensitivity is low and only strong signals are audible.	<ul style="list-style-type: none"> • Antenna feedline or the antenna connector solder has a poor contact or is short circuited. • Squelch attenuator function is activated. 	<ul style="list-style-type: none"> • Check, and if necessary, replace the feedline or solder the antenna connector again. • Set [SQL] between 10–12 o'clock position. 	p. III p. 14
No contact possible with another station.	<ul style="list-style-type: none"> • The other station is using tone squelch. • The transceiver is set to duplex. 	<ul style="list-style-type: none"> • Turn the tone squelch function ON. • Set to simplex. 	p. 50 p. 17
Repeater cannot be accessed.	<ul style="list-style-type: none"> • Wrong offset frequency is programmed. • Wrong subaudible tone frequency is programmed. 	<ul style="list-style-type: none"> • Correct the offset frequency. • Correct the subaudible tone frequency. 	p. 21 p. 19
Frequency cannot be set.	<ul style="list-style-type: none"> • The frequency lock function is activated. • Priority watch is paused on the watching frequency. 	<ul style="list-style-type: none"> • Turn the function OFF. • Push [M/CALL(PRIO)] to cancel the watch. 	p. 12 p. 44
Frequency cannot be set via the microphone.	<ul style="list-style-type: none"> • The frequency lock function is activated. • The microphone keypad lock function is activated. • Priority watch is paused on the watching frequency. 	<ul style="list-style-type: none"> • Push [SET(LOCK)] for 1 sec. to deactivate the frequency lock function. • Push [FUNC] then [#(16KEY-L)] to deactivate the microphone keypad lock function. • Push [M/CALL(PRIO)] to cancel the watch. 	p. 12 p. 12 p. 44

PROBLEM	POSSIBLE CAUSE	SOLUTION	REF.
Some memory channels cannot be selected via the microphone keypad.	<ul style="list-style-type: none"> The input channel number has not yet been programmed. 	<ul style="list-style-type: none"> Rotate the tuning dial to check whether the channel has been programmed or not. 	—
Scan does not operate.	<ul style="list-style-type: none"> The squelch is open. Only 1 memory channel is programmed or other channels are set as skip channels. Priority watch is activated. 	<ul style="list-style-type: none"> Set the squelch to the threshold point. Program other memory channels or cancel the memory skip function in the desired channels. Cancel the watch. 	p. 13 pgs. 25, 26, 41 p. 44
Transmission is automatically cut off.	<ul style="list-style-type: none"> Time-out timer is activated. 	<ul style="list-style-type: none"> Set the timer to OFF. 	p. 63
Transmission continues even when the PTT is released.	<ul style="list-style-type: none"> One-touch PTT function is activated. 	<ul style="list-style-type: none"> Turn the function OFF. 	p. 16
The function display shows erroneous information.	<ul style="list-style-type: none"> The CPU is malfunctioning. 	<ul style="list-style-type: none"> Reset the CPU. 	p. 68

■ Fuse replacement

If the fuse blows or the transceiver stops functioning, find the source of the problem if possible, and replace the damaged fuse with a new, rated one (FGB 20 A) as shown at right.

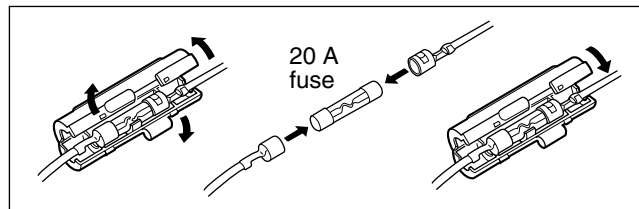

13 MAINTENANCE

■ Optional unit installation

- ① Remove the 3 allen-socket bolts from the front panel using with an allen wrench (2.5 mm; 1/10")

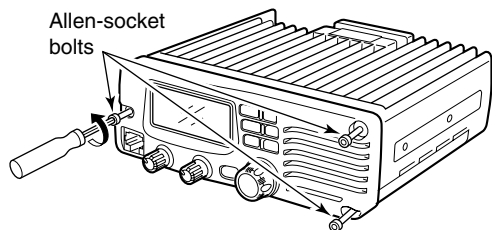

- ② Detach the front panel from the main unit.

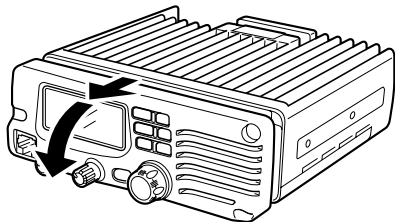

- ③ Remove the protective paper attached to the bottom of the optional unit to expose the adhesive strip.

- ④ Install the unit as illustrated below. Insert tightly to avoid bad contact.

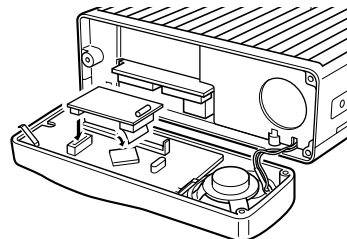

- ⑤ Return the front panel and the allen-socket bolts to their original position.

NOTE: When attaching the front panel to the main unit, make sure the speaker wires are running in the groove as illustrated below to prevent catching between front panel and main unit.

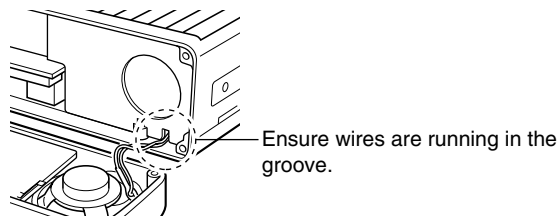

■ Specifications

GENERAL

- Frequency coverage : (unit: MHz)
 - USA Tx: 144–148/Rx: 136–174*
 - Asia, CSA Tx: 144–148/Rx: 136–174*
 - (Central South America)
 - Australia Tx/Rx: 144–148
 - Taiwan, Korea Tx/Rx: 144–146
 - *Guaranteed: 144–148 MHz range only.
 - Type of emission : FM
 - Number of memory channels : 207 (incl. 6 scan edges and 1 call)
 - Frequency resolution : 5, 10, 12.5, 15, 20, 25, 30, 50 kHz
 - Operating temperature range : –10°C to +60°C; +14°F to +140°F
 - Frequency stability : ±10 ppm (–10°C to +60°C)
 - Power supply requirement : 13.8 V DC ±15%
 - Current drain (at 13.8 V DC: approx.):
 - Transmit at 75 W 15 A
 - Receive standby 0.3 A typical
 - max. audio 1.0 A
 - Antenna connector : SO-239 (50 Ω)
 - Dimensions (proj. not included) : 150(W) × 50(H) × 150(D) mm
5²⁹/₃₂(W) × 2(H) × 5²⁹/₃₂(D) in
 - Weight (approx.) : 1.1 kg; 2 lb 7 oz
- ### TRANSMITTER
- Modulation system : Variable reactance frequency mod.
 - Output power : 75/25/10/5 W* (approx.)
*24/10/5 W only for the Taiwan version.
 - Max. frequency deviation : ±5.0 kHz (wide)/±2.5 kHz (narrow)[†]
 - Spurious emissions : Less than –60 dB
 - Microphone connector : 8-pin modular (600 Ω)

RECEIVER

- Receive system : Double-conversion superheterodyne
- Intermediate frequencies : 1st: 21.7 MHz, 2nd: 450 kHz
- Sensitivity (at 12 dB SINAD) : 0.15 μV typical
- Squelch sensitivity (threshold) : 0.08 μV typical
- Selectivity (typical) : 75 dB (wide)/60 dB (narrow)[†]
- Spurious and image rejection : 75 dB typical
- AF output power (at 13.8 V DC): More than 2.0 W at 10% distortion with an 8 Ω load
- Ext. speaker connector : 3-conductor 3.5 (d) mm (1/8")/8 Ω

[†]Some versions only.

All stated specifications are subject to change without notice or obligation.

■ Options

UT-108 DTMF DECODER UNIT

HM-95/HM-118TAN/TN DTMF MICROPHONES

HM-118N HAND MICROPHONE

HM-133V REMOTE-CONTROL MICROPHONE

SP-10 EXTERNAL SPEAKER

OPC-440/OPC-647 MIC EXTENSION CABLES

OPC-441 SPEAKER EXTENSION CABLE

OPC-1132/OPC-347 DC POWER CABLES

OPC-589 ADAPTER CABLE

CS-V8000 CLONING SOFTWARE + **OPC-478** CLONING CABLE

OPC-474 CLONING CABLE

15 MODE ARRANGEMENT

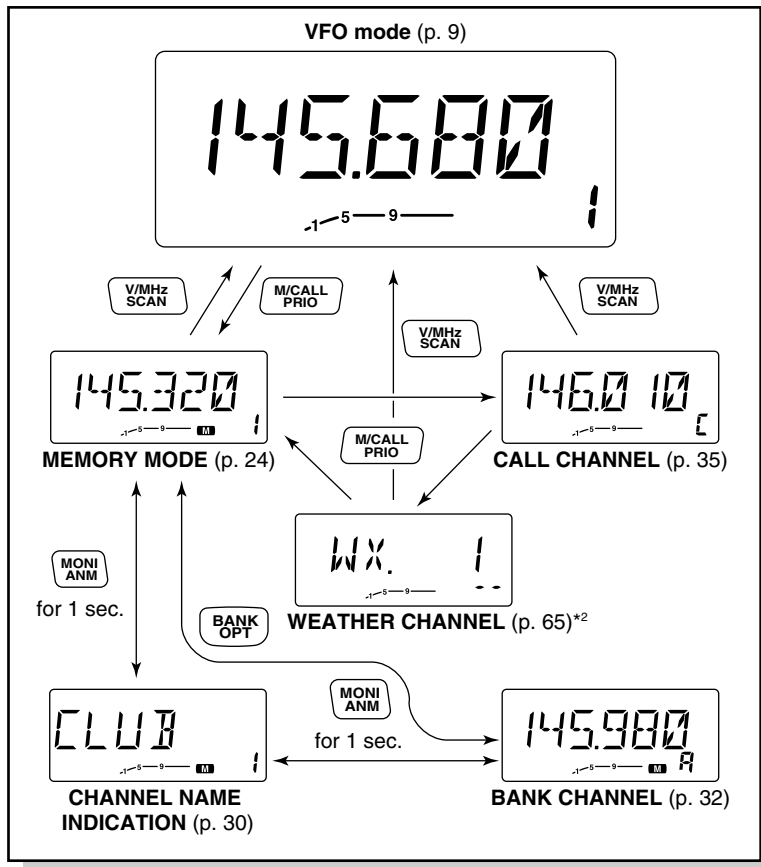

SET LOCK

TONE T-SCAN

When the DTMF memory encoder is activated.

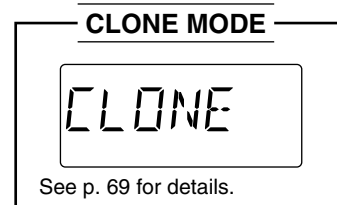
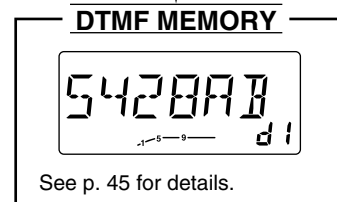

*1 Appears when accessing from memory mode only.

*2 Available for USA versions only.

*3 Appears in some version only.

*4 Appears when accessing from VFO mode only.

SET MODE

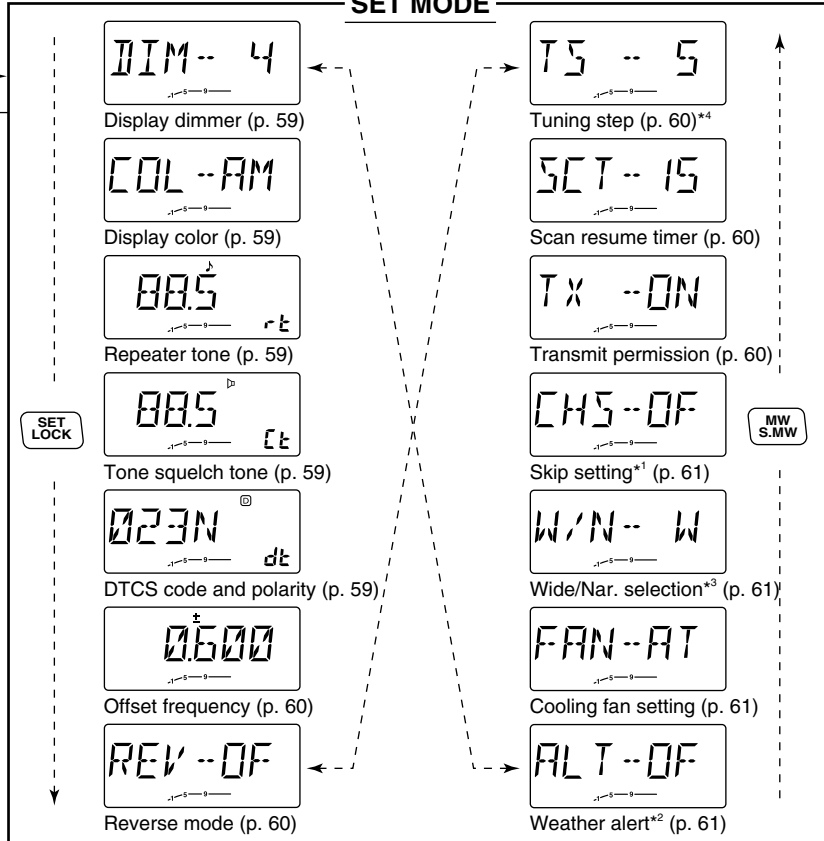

INITIAL SET MODE

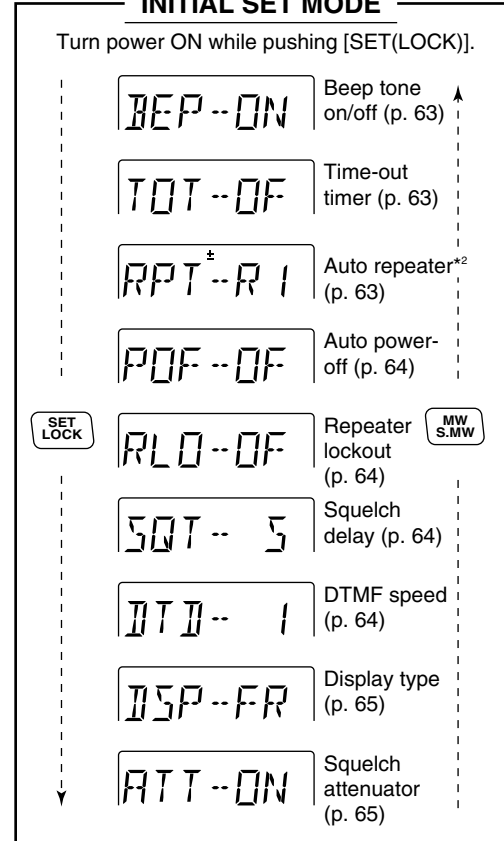

Count on us!

A-6115D-1EX-②
Printed in Japan
© 2001, 2002 Icom Inc.

Icom Inc.
1-1-32 Kamiminami, Hirano-ku, Osaka 547-0003 Japan