

**JSS-2150**

---

**150W MF/HF RADIO EQUIPMENT**

**INSTRUCTION  
MANUAL**

**JRC** *Japan Radio Co., Ltd.*





## CAUTIONS AGAINST HIGH VOLTAGE

Radio and radar devices are operated by high voltages of anywhere from a few hundred volts up to many hundreds of thousands of volts. Although there is no danger with normal use, it is very dangerous if contact is made with the internal parts of these devices. (Only specialists should attempt any maintenance, checking or adjusting.)

There is a very high risk of death by even a few thousand volts, in some cases you can be fatally electrocuted by just a few hundred volts. To prevent accidents, you should avoid contact with the internal parts of these devices at all costs. If contact is inevitable as in the case of an emergency, you must switch off the devices and ground a terminal in order to discharge the capacitors. After making certain that all the electricity is discharged, only then can you insert your hand into the device. Wearing cotton gloves and putting your left hand in your pocket, in order not to use both hands simultaneously, are also very good methods of shock prevention.

Quite often, an injury occurs by secondary factors, therefore it is necessary to choose a sturdy and level working surface. If someone is electrocuted it is necessary to thoroughly disinfect the affected area and seek medical attention as soon as possible.

## Cautions concerning treatment of electrocution victims

When you find an electrocution victim, you must first switch off the machinery and ground all circuits. If you are unable to cut off the machinery, move the victim away from it using a non-conductive material such as dry boards or clothing.

When someone is electrocuted, and the electrical current reaches the breathing synapses of the central nervous system inside the brain, breathing stops. If the victim's condition is stable, he or she can be administered artificial respiration. An electrocution victim becomes very pale, and their pulse can be very weak or even stop, consequently losing consciousness and becoming stiff. Administration of first aid is critical in this situation.

# First aid

## ☆Note points for first aid

Unless there is impending danger leave the victim where he or she is, then begin artificial respiration. Once you begin artificial respiration, you must continue without losing rhythm.

- (1) Make contact with the victim cautiously, there is a risk that you may get electrocuted.
- (2) Switch off the machinery and then move the victim away slowly if you must.
- (3) Inform someone immediately (a hospital or doctor, dial emergency numbers, etc.).
- (4) Lay the victim on his or her back and loosen any constrictive clothing (a tie, or belt).
- (5)
  - (a) Check the victim's pulse.
  - (b) Check for a heartbeat by pressing your ear against the victim's chest.
  - (c) Check if the victim is breathing by putting the back of your hand or face near the victim's face.
  - (d) Check the pupils of the eyes.
- (6) Open the victim's mouth and remove any artificial teeth, cigarette or chewing gum. Leave the mouth opened and flatten the tongue with a towel or by putting something into the mouth to prevent the victim's tongue from obstructing the throat. (If he or she is clenching the teeth and it is difficult to open the mouth, use a spoon or the like to pry open the mouth.)
- (7) Continually wipe the mouth to prevent the accumulation of saliva.

# ☆ If the victim has a pulse but is not breathing

(“Mouth to mouth” resuscitation) Figure 1

- (1) Place the victim’s head facing backward (place something under the neck like a pillow).
- (2) Point the chin upward to widen the trachea.
- (3) Pinch the victim’s nose, take a deep breath, then put your mouth over the victim’s mouth and exhale completely, making sure that your mouth completely covers the victim’s mouth. Then remove your mouth. Repeat this routine 10 to 15 times per minute (holding the nostrils).
- (4) Pay attention to the victim to notice if he or she starts to breath. If breathing returns, stop resuscitation.
- (5) If it is impossible to open the victim’s mouth, put something like a plastic straw or vinyl tube into one of the nostrils then blow air in while covering the mouth and the other nostril.
- (6) Occasionally, when the victim comes back to consciousness, they immediately try to stand up. Prevent this and keep them in a laying position. Give them something warm to drink and be sure that they rest (do not give them any alcohol).

## Administering artificial respiration by raising the head.

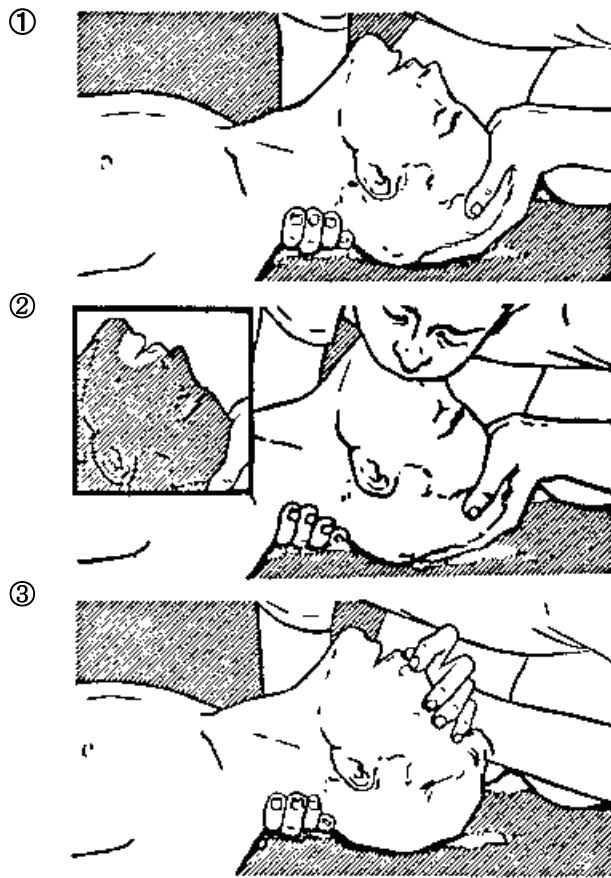

Figure 1

- (1) Raise the back of head, then place one hand on the forehead and place the other hand under the neck. →①  
Most victims open their mouth when this is done, making “mouth to mouth” resuscitation easier.
- (2) Cover the victim’s mouth by opening your mouth widely, then push your cheek against the victim’s nose, →②  
or pinch the victim’s nose to prevent air from leaking out of it. →③
- (3) Completely exhale into the lungs.  
Exhale into the lungs until the chest inflates.  
You have to blow as rapidly as possible for the first 10 times.

# ☆ If the victim has no pulse and is not breathing

(Heart massage in combination with artificial respiration.) Figure 2

If the victim has no pulse, his or her pupils are dilated, and if you cannot detect a heartbeat, the heart may have stopped, beginning artificial respiration is critical.

- (1) Put both hands on the diaphragm, with hands on top of each other keeping both arms straight (If your elbows are bent, you cannot push with as much power). Press the diaphragm with your body weight until the chest sinks about 2 cm (about 50 times per minute).
- (2) If administering first aid when alone:  
Perform the heart massage about 15 times then blow in twice. Repeat this routine.  
If administering first aid with two people:  
One person performs the heart massage 5 times, and the other person blows air in once. Repeat this routine (Heart massage and "mouth to mouth" resuscitation used together).
- (3) Constantly check the pupils and the pulse, if the pupils become normal and the pulse steadies, keep them in a laying position and give them something warm to drink, be sure that they rest (do not give them any alcohol). In any case you have to entrust major decision making to a doctor. Having understanding people around is essential to the victim's recovery from the mental shock of electrocution.

①

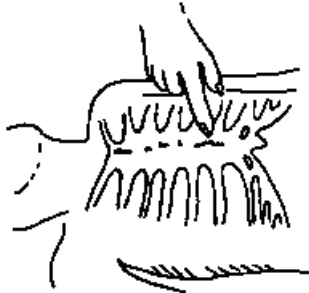

②



③



④

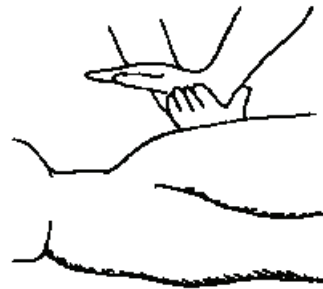

(Heart massage in combination with artificial respiration.) Figure 2

## Preface

Thank you for choosing the Model JRC JSS-2150 150W MF/HF radio equipment. This radio equipment can be used as a Global Maritime Distress and Safety System (GMDSS) radio device, compliant with international regulations, that provides emergency communications and standard communications capabilities for small and large ships.

- Please read this instruction manual thoroughly before using the JSS-2150 150W MF/HF radio equipment, and use it in accordance with the instructions contained herein.
- Please keep this manual available for future reference. Please refer to it if any difficulties are encountered when using the equipment.

## Before operation

### Concerning the symbols

This manual uses the following symbols to explain correct operation and to prevent injury or damage to property.

The symbols and descriptions are as follows. Understand them before proceeding with this manual.



Indicates a warning that, if ignored, may result in serious injury or even death.



Indicates a caution that, if ignored, may result in injury or damage to property.

### Examples of symbols



The  $\Delta$  symbol indicates caution (including DANGER and WARNING). The illustration inside the  $\Delta$  symbol specifies the content of the caution more accurately. (This example warns of possible electrical shock.)



The  $\odot$  symbol indicates that performing an action is prohibited. The illustration inside the  $\odot$  symbol specifies the contents of the prohibited operation. (In this example disassembly is prohibited.)



The  $\bullet$  symbol indicates operations that must be performed. The illustration inside the  $\bullet$  symbol specifies obligatory instructions. (In this example unplugging is the obligatory instruction.)

### Concerning the WARNING labels

The WARNING labels are put on the NTD-2150 MF/HF Transceiver, NFC-2150 Antenna tuner, NBD-2150 AC/DC Power supply, and NBB-724 Battery charger. Do not take off, destroy, or modify the labels.

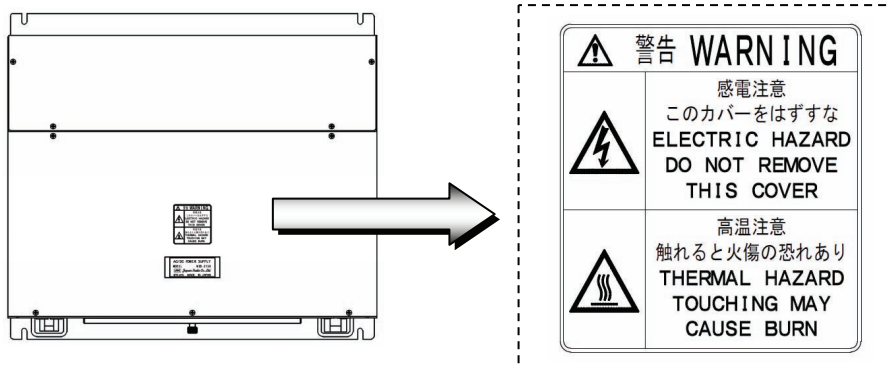

Ex) NBD-2150 AC/DC Power supply (Upper view)



## Handling precautions

### WARNING



Do not open the equipment to inspect or repair internal circuits. Inspection or repairs by anyone other than a specialized technician may result in fire, electrical shock, or malfunction.

If internal inspection or repair is necessary, contact our service center or agents.



Do not disassemble or customize this unit.

Doing so may cause fire, electrical shock, or malfunction.



Do not get this equipment wet or spill any liquids on or near this equipment.

Doing so may cause electrical shock, or equipment malfunction.



Do not touch any of the areas with warning labels.

Doing so may cause electrical shock.



Do not use voltage other than that specified.

Doing so may cause fire, electrical shock, or malfunction.



Do not remove protective covers on the high voltage terminals.

Doing so may cause electrical shock.



Do not insert anything flammable into the equipment.

Doing so may cause fire, electrical shock, or malfunction.



If a distress call is received, make sure to inform the ship's captain or officer in charge.

Doing so may save the lives of the crews and passengers on the ship in distress.



This equipment is used for both distress communication and routine communication. Contact JRC or our agent if any problem is observed in this unit during routine operation or inspection.

## Handling precautions

### CAUTION



Do not use this equipment anywhere other than specified. Doing so may cause failure or malfunction.



Do not turn the trimmer resistors or the trimmer capacitors on the PCB unit. Doing so may cause failure or malfunction.



Do not install the equipment in a place near water or in one with excessive humidity, steam, dust, or soot. Doing so may cause fire, electrical shock, or malfunction.



Do not test the distress call. Doing so may inconvenience local shipping and rescue centers.



Do not turn off the equipment when at sea because the SOLAS Convention requires keeping watch on distress and safety frequencies at all times. Always listen to 2187.5 kHz, and 8414.5 kHz, and one or more of the following frequencies; 4207.5 kHz, 6312.0 kHz, 12577.0 kHz, or 16804.5 kHz. In class B mode, it is necessary to keep watch only on 2187.5 kHz.



When completely turning off the power to the equipment, turn off the breaker on the transceiver



To operate DSC functions of the equipment, the ID numbers assigned to the ship must be registered in advance. If registration is necessary, contact our service center or agents.



To install this equipment, contact our service center or agents. Special knowledge on selecting the place where the antenna is to be mounted and setting the ID number (MMSI) assigned to the ship is required in addition to installing the equipment.



When sending a distress call, follow the instructions of the ship's captain or officer in charge.



- If a false distress call is transmitted accidentally, follow the instructions below:
1. Press the **CANCEL** key on the controller (when appropriate, follow the commands on screen) and terminate the transmission of the distress call.
  2. Report the false distress call to a nearby RCC (Rescue Coordination Center). (In Japan, inform the nearest Japan Coast Guard.)  
Information to be reported:  
The date/time, location, and reason why the false distress call was transmitted. Also report the ship's name, type, nationality, and ID number as well as the unit model name and manufacture number/date, if possible.
  3. Report the false distress call to nearby ships using 2182.0 kHz or another frequency for distress and safety purposes on the radiotelephone.
  4. If any acknowledgements to the distress call are received, inform the ships of the false distress call.



To turn off an alarm or clear a display such as a received DSC message, do not press the **DISTRESS** key. Doing so may cause a false distress call. (Press the **CANCEL** key to turn off the alarm and delete the message.)

# CAUTION



When sending a drobose call, do not press the **DISTRESS** key. Doing so may cause a false distress call.  
(Drobosc calls can be sent via the [Call] button displayed on the screen.)



A distress acknowledgement or a distress relay call can be transmitted from a received distress message stored in the log, but when sending such a call, follow the instructions of the ship's captain or officer in charge.



Received distress calls are automatically deleted after 48 hours to avoid accidental resending or other misoperation. Accordingly, if such messages cannot be read, it is not a malfunction.



The received distress message logs are cleared when turning off the power by such as the breaker on the transceiver. Due to the SOLAS Convention (keeping watch on distress and safety frequencies at all times), do not turn off the equipment when at sea.



The time in the 7.1 Date & time menu means the present time, and is different from the time in the 7.2 POS/TIME menu that means the time when the position information is valid.



The time in the 7.2 POS/TIME menu means the time when the position information is valid, and is different from the present time mentioned in the 7.1 Date & time menu.



The batteries, except for sealed lead-acid batteries that require no equalization, should be carried out the equalizing charge at least every six months



The thermal head of the NKG-91 printer may be very hot after printing. Do not touch the thermal head of the printer. Make sure the thermal head is cool before replacing the paper or cleaning the thermal head.



The paper used in the NKG-91 printer is heat sensitive. Take the following precautions when using this paper.

- Store the paper away from heat, humidity, or heat sources.
- Do not rub the paper with any hard objects.
- Do not place the paper near organic solvents.
- Do not allow the paper to come in contact with polyvinyl chloride film, erasers, or adhesive tape for long periods of time.
- Keep the paper away from freshly copied diazo type or wet process copy paper.



The print head of the NKG-800 printer may be very hot after printing. Do not touch the print head of the printer. Make sure the print head is cool before replacing the paper or cleaning the print head.



Do not use the NKG-800 printer if there is no ink ribbon cartridge or paper. Do not twist the ink ribbon when installing the ink ribbon cartridge.



Before opening and closing the cover of the NKG-800 printer, turn off the printer. Wait more than 2 seconds after turning the printer off before turning it back on again so it can initialize correctly.

# DISTRESS CALLS

## Sending a Distress Call (Distress Alert)

### ⚠ CAUTION



When sending a distress call, follow the instructions of the ship's captain or officer in charge.

1. Open the **DISTRESS** key cover on the NCM-2150 controller.



2. Press and hold the **DISTRESS** key for 4 seconds to send the distress call. When the countdown is finished the screen below on the right is displayed, and after tuning the antenna to the frequency, the distress call is transmitted.

ID 431001234	TIME 23:59(UTC)
Pos 89° 59.0123' N	179° 59.6789' E@23:59 (EXT)
DSC Rx: 2177.0/Tx: 2177.0kHz	
3)Editing a distress msg	
Distress call starts	
in 4 sec	
Comm type: Radiotelephone	
EOS :EOS	
[Return] [Tips] [Cancel]	



ID 431001234	TIME 23:59(UTC)
Pos 89° 59.0123' N	179° 59.6789' E@23:59 (EXT)
DSC Rx: 2187.5/Tx: 2187.5kHz	
Distress calling	
Stage :Transmitting	
Next :---	
Call-F:2187.5/4207.5/6312.0	
(kHz) 8414.5/12577.0/16804.5	
[MoreInfo]	
WKR scan bands:	
2 4 6 8 12 16 (MHz)	
ATT12 AGC-F BC TXON	

3. After sending the distress call, wait for an acknowledgement.

The radiotelephone can be used to communicate even while waiting for an acknowledgement. The screen below is displayed when an acknowledgement is received. Press the **CANCEL** key or ENT to cancel the alarm, and then select Continue with the jog dial and press ENT. Unless an acknowledgement is received or the distress call is cancelled manually, the equipment repeats the distress call every 3.5 to 4.5 minutes.

ID 431001234	TIME 23:59(UTC)
Pos 89° 59.0123' N	179° 59.6789' E@23:59 (EXT)
TEL Rx: 4125.0/Tx: 4125.0kHz	
Received the acknowledgement	
Type	:Distress ACK
To	:All ships
From	:001234567
Dist-ID	:431001234
Nature	:Undesignated
Position	:89° 59.0123' N
	179° 59.6789' E
UTC of pos:	23:59
Press CANCEL to silence alarm.	



ID 431001234	TIME 23:59(UTC)
Pos 89° 59.0123' N	179° 59.6789' E@23:59 (EXT)
TEL Rx: 4125.0/Tx: 4125.0kHz	
Received the acknowledgement	
▲ Dist-ID	:431001234
Nature	:Undesignated
Position	:89° 59.0123' N
	179° 59.6789' E
UTC of pos:	23:59
Mode	:Radiotelephone
EOS	:EOS
Rx FRQ	:2187.5kHz
[Continue]	

#### 4. After receiving acknowledgement, use the radiotelephone to request rescue.

First, the responding station calls by radiotelephone. Communicate the following information to that station.

- Say "MAYDAY".
- Say "This is (name of your ship)".
- Tell the station the ship's Maritime Mobile Service Identity (MMSI) number, call sign, ship's position, nature of distress, and rescue requests.

#### Note

If time permits, enter the nature of the distress as follows, just before sending the distress call. (For more details, see 4.5.3.)

- 1) **Open menu 3. Editing a distress msg.**
- 2) **Press ENT in the screen displayed at right and select the nature of the distress.**
- 3) **Press ENT to confirm the selection.**  
The nature of the distress is set. If the position and time (UTC) are not displayed automatically for any reason, input them manually at this time.
- 4) **Press and hold the **DISTRESS** key for 4 seconds to send the distress call.**  
The rest of the procedure is the same as described above.

ID 431001234	TIME 23:59(UTC)
Pos 89° 59.0123' N	
179° 59.6789' E@23:59	(EXT)
DSC Rx: 2177.0/Tx: 2177.0kHz	
3) Editing a distress msg	
Nature	[Undesignated]
Position	[NE]
	[ 89° 59.0123' N]
	[179° 59.6789' E]
UTC of pos	[23:59]
Mode(fixed)	[Radiotelephone]
Attempt type	[Multi-FRQ]
Tx bands	[2/4/6/8/12/16]
[Preview]	[Tips] [Cancel]

## Terminating a Distress Call

### ! CAUTION



If a false distress call is transmitted accidentally, follow the instructions below:

1. Immediately terminate the distress call according to the following procedure.
2. Report the false distress call to a nearby RCC (Rescue Coordination Center).  
(In Japan, inform the nearest Japan Coast Guard.)  
Information to be reported:  
The date/time, location, and reason why the false distress call was transmitted. Also report the ship's name, type, nationality, ID number as well as the unit model name and manufacture number/date, if possible.
3. Report the false distress call to nearby ships using 2182.0 kHz or another frequency for distress and safety purposes on the radiotelephone.
4. If any acknowledgements to the distress call are received, inform the ships of the false distress call.

#### 1. Press the **CANCEL** key on the NCM-2150 controller.

If the **CANCEL** key is pressed during transmission of the distress call, the screen immediately returns to the status display.

If the **CANCEL** key is pressed in the interval between automatic resending of the distress call, the screen shown below is displayed. Select Break with the jog dial and press ENT to return to the status display.



ID 431001234	TIME 23:59(UTC)
Pos 89° 59.0123' N	
179° 59.6789' E@23:59	(EXT)
TEL Rx: 8291.0/Tx: 8291.0kHz	
Distress calling	
- Attention -	
Now continuing the	
distress call mode.	
Break this mode?	
[Continue]	[Break]
WKR scan bands:	
2 4 6 8 12 16 (MHz)	[ATT12] [AGC-P] [BC]

# Receiving a Distress Call

## WARNING



If a distress call is received, make sure to inform the ship's captain or officer in charge. Doing so may save the lives of the crew and passengers on the ship in distress.

### 1. When a distress call is received, the distress message is displayed.

The ALM lamp starts blinking, and an alarm gradually grows louder.

ID 431001234	TIME 23:59 (UTC)
Pos 89° 59.0123' N	
179° 59.6789' E@23:59	(EXT)
TEL Rx: 4100.0/Tx: 4100.0kHz	
Received distress message	
Type	:Distress
From	:431022222
Nature	:Man overboard
Position	:90° 00.0000' N
	:180° 00.0000' E
UTC of pos:	23:57
Mode	:Radiotelephone
▼ EOS	:EOS
Press CANCEL to silence alarm.	

### 2. Press the **CANCEL** key to stop the alarm and then select Accept with the jog dial and press ENT. Keep watch on the distress call's frequency of the radiotelephone.

Keep watch for at least 5 minutes. Notify the coast station as appropriate.

ID 431001234	TIME 23:59 (UTC)
Pos 89° 59.0123' N	
179° 59.6789' E@23:59	(EXT)
TEL Rx: 4100.0/Tx: 4100.0kHz	
Received distress message	
▲ Position	:90° 00.0000' N
	:180° 00.0000' E
UTC of pos:	23:57
Mode	:Radiotelephone
EOS	:EOS
Rx FRQ	:2187.5/-----./
	-----./-----./
	-----./-----.-kHz
[Accept]	[Cancel]



ID 431001234	TIME 23:59 (UTC)
Pos 89° 59.0123' N	
179° 59.6789' E@23:59	(EXT)
TEL	
RX	2182.0 kHz
TX	2182.0 kHz
SIG ■■■■■■■■■■ 	
WKR scan bands:	<b>ATT12</b> <b>AGC-F</b> <b>BC</b>
2 4 6 8 12 16 (MHz)	<b>TXON</b>

### 3. To respond to the distress call and coordinate with the coast station, select acknowledge (ACK) from the menu in 4. DSC logs and send it. After sending it, communicate with the ship in distress via the radiotelephone as follows.

- Say "MAYDAY".
- Repeat the identity (MMSI) of the ship in distress 3 times
- Say, "This is".
- Repeat the identity (MMSI) of your ship 3 times
- Say "RECEIVED MAYDAY".

# Equipment exterior

- JSS-2150 150W MF/HF Radio Equipment



NTD-2150 150 W MF/HF Transceiver



NFC-2150 Antenna Tuner



NCM-2150 MF/HF Controller/NQW-261 Handset

- NKG-91 Printer

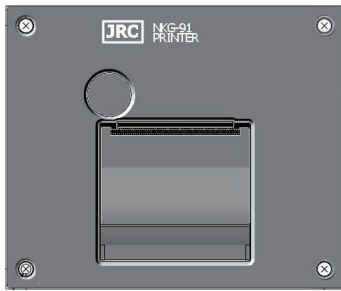

- DPU-414 Printer



- NKG-800 Printer



- NBD-2150 AC/DC Power supply

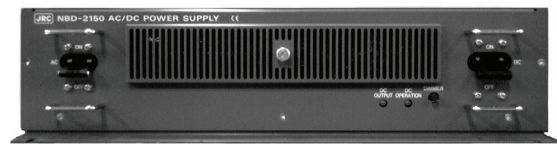

- NBB-724 Battery charger



- NCH-321A Distress Message Controller (DMC)

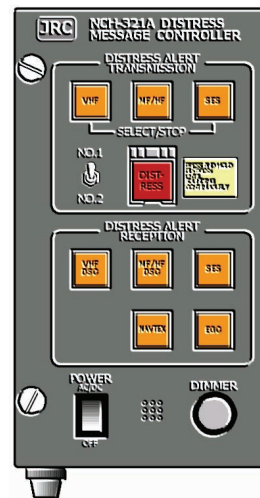



# Contents

<b>Preface</b> .....	<b>v</b>
<b>Before operation</b> .....	<b>vi</b>
<b>Handling precautions</b> .....	<b>vii</b>
<b>DISTRESS CALLS</b> .....	<b>x</b>
<b>Equipment exterior</b> .....	<b>xiii</b>
<b>Glossary of terms</b> .....	<b>xix</b>
<b>1. EQUIPMENT OVERVIEW</b> .....	<b>1-1</b>
1.1 Functions .....	1-1
1.2 Features .....	1-1
1.3 Basic configuration .....	1-2
1.3.1 Basic configuration of the main unit .....	1-2
1.3.2 Options .....	1-2
1.3.3 System configuration .....	1-3
1.4 External dimensions .....	1-4
1.5 Block diagram .....	1-12
<b>2. NAMES AND FUNCTIONS</b> .....	<b>2-1</b>
2.1 Controller (NCM-2150) .....	2-1
2.2 Main displays .....	2-3
2.2.1 Status display .....	2-3
2.2.2 Function screen and key operations .....	2-4
2.2.3 Menu screen .....	2-5
2.2.4 DSC message receiving screen .....	2-5
<b>3. INSTALLATION</b> .....	<b>3-1</b>
<b>4. OPERATION</b> .....	<b>4-1</b>
4.1 Controller operation overview .....	4-1
4.2 Basic communications procedure .....	4-3
4.2.1 Turning on the power .....	4-3
4.2.2 Turning off the power/ Putting into sleep mode .....	4-4
4.2.3 Communicating in radiotelephone mode .....	4-5
4.2.4 Communicating in CW mode .....	4-7
4.2.5 Receiving AM broadcasts .....	4-9

4.3	Setting the radio .....	4-10
4.3.1	Setting the communication frequencies .....	4-10
4.3.2	Setting the communication channels .....	4-11
4.3.3	Setting the automatic gain control (AGC) .....	4-15
4.3.4	Setting the noise reduction (NR) .....	4-15
4.3.5	Setting the attenuation (ATT) .....	4-16
4.3.6	Setting the clarifier .....	4-16
4.3.7	Setting the squelch level .....	4-17
4.3.8	Setting the CW bandwidth .....	4-17
4.3.9	Scanning the Rx frequencies .....	4-18
4.3.10	Reducing the Tx power .....	4-19
4.3.11	Setting the antenna tuning power .....	4-19
4.4	Basic DSC operations .....	4-20
4.4.1	Routine calls to an individual station .....	4-20
4.4.2	Routine calls to a group of ships .....	4-23
4.4.3	Receiving routine calls .....	4-25
4.5	Emergency calls (DSC safety/urgency/distress calls) .....	4-29
4.5.1	Safety calls .....	4-29
4.5.1.1	Individual calls .....	4-29
4.5.1.2	Area calls .....	4-31
4.5.1.3	Other features of the safety calls (position request/test) .....	4-33
4.5.1.4	Receiving safety calls .....	4-37
4.5.2	Urgency calls .....	4-40
4.5.2.1	Individual calls .....	4-40
4.5.2.2	Area calls .....	4-41
4.5.2.3	Special calls (medical transport/neutral ship) .....	4-43
4.5.2.4	Receiving urgency calls .....	4-43
4.5.3	Distress calls .....	4-45
4.5.3.1	Quick distress calls .....	4-45
4.5.3.2	Distress calls from the menu .....	4-48
4.5.3.3	Receiving distress calls .....	4-51
4.5.3.4	Acknowledging a received distress call .....	4-52
4.5.4	Distress relay calls on behalf of someone else .....	4-53
4.5.4.1	Coast station calls .....	4-53
4.5.4.2	Area calls .....	4-55
4.5.4.3	Receiving drobose calls .....	4-57
4.5.5	Distress relay calls .....	4-58
4.5.5.1	Sending distress relay calls .....	4-58
4.5.5.2	Receiving distress relay calls .....	4-60
4.6	DSC call log .....	4-62
4.6.1	Received distress messages .....	4-62
4.6.2	Received other messages .....	4-63
4.7	Popup screens .....	4-64
<b>5.</b>	<b>SETTINGS &amp; REGISTRATIONS .....</b>	<b>5-1</b>
5.1	Date and time settings .....	5-1

5.2	Own ship position and time settings .....	5-3
5.3	Controller settings .....	5-4
5.3.1	LCD adjustment .....	5-4
5.3.2	Sound settings .....	5-4
5.3.3	User key assignments .....	5-5
5.3.4	Selecting Tx meters .....	5-6
5.3.5	Transferring user channel data to another controller .....	5-7
5.4	Registering user channels .....	5-8
5.5	Advanced settings for DSC/WKR .....	5-10
5.5.1	Automatic acknowledgement .....	5-10
5.5.2	Setting DSC watch frequency .....	5-11
5.5.3	Disabling receiving alarms for routine and safety calls .....	5-11
5.5.4	Using medical/neutral settings for urgency calls .....	5-11
5.5.5	Registering the ship's group ID .....	5-11
5.6	Setting connections for options .....	5-12
<b>6.</b>	<b>MAINTENANCE &amp; INSPECTION .....</b>	<b>6-1</b>
6.1	General maintenance & inspection .....	6-1
6.2	Self diagnosis inspection .....	6-2
6.3	System alarm indication .....	6-5
6.3.1	Alarm list .....	6-6
6.3.2	Viewing the alarm history .....	6-8
6.4	Software version .....	6-9
6.5	Troubleshooting .....	6-10
6.5.1	Procedures for locating malfunctions .....	6-10
6.5.2	Guide to locating faults .....	6-11
6.5.3	Consumables .....	6-12
6.5.4	Repair units/parts .....	6-12
6.5.5	Regular replacement parts .....	6-12
<b>7.</b>	<b>AFTER-SALES SERVICE .....</b>	<b>7-1</b>
<b>8.</b>	<b>DISPOSAL .....</b>	<b>8-1</b>
<b>9.</b>	<b>SPECIFICATIONS .....</b>	<b>9-1</b>
9.1	JSS-2150 150W MF/HF Radio Equipment .....	9-1
9.2	Options .....	9-4
9.3	Peripheral interfaces .....	9-6
<b>10.</b>	<b>OPTIONS OPERATION .....</b>	<b>10-1</b>
10.1	AC/DC power supply (NBD-2150) .....	10-1
10.2	Battery charger (NBB-724) .....	10-2
10.3	Printer (NKG-91) .....	10-4
10.4	Printer (NKG-800) .....	10-5
10.5	Operations using a SELCALL unit .....	10-8

<b>11. Appendix</b> .....	<b>11-1</b>
11.1 Frequencies for distress and safety calls .....	11-1
11.2 National DSC frequencies for routine calls .....	11-2
11.3 International DSC frequencies for routine calls .....	11-2
11.4 ITU channel list (TEL/CW) .....	11-3
11.5 Guide to MF/HF operation .....	11-11

# Glossary of terms

This section defines general and DSC terms related to this equipment.

## ● General terms

### **DSC**

Digital Selective Calling device  
Used in routine calls, safety and urgency calls, and distress calls for rescue requests.

### **GMDSS**

Global Maritime Distress and Safety System.

### **GPS**

Global Positioning system

### **IMO**

International Maritime Organization

### **ITU**

International Telecommunication Union  
Establishes conventions and regulations for all electrical wired and radio, land, sea, air, and space communications. It contains internal organizations such as ITU-R and ITU-T.

### **ITU-R**

The International Telecommunications Union (ITU) radio communications department.

### **LT**

Local time

### **MMSI**

Maritime Mobile Service Identity  
The 9-digit Maritime Mobile Service Identity number assigned to each ship and coast station.

### **NMEA**

Maritime equipment transmission standard established by the National Marine Electronics Association.

### **PTT**

Push to talk

### **RCC**

Rescue Co-ordinate Center

### **RMS**

Remote Maintenance System  
Transmits ship equipment information temporarily stored in the VDR via Inmarsat to land, for use in maintenance and management of radio equipment.

### **RR**

Radio Regulations  
International regulations for radio transmission established by the treaty of the ITU.

### **SOLAS Convention**

International Convention for Safety of Life at Sea  
The international convention applies to all ships engaged on international voyages. A safety certificate is issued if the conditions of this convention are satisfied.

### **SQL (Squelch)**

A function that acts to suppress the audio output of a receiver in the absence of a radio signal of sufficient strength.

### **UTC**

Universal Time Coordinated

### **MF/HF**

Medium frequencies and high frequencies (300 kHz to 30 MHz)

### **VOL (Volume)**

Speaker volume

### **WRC**

World Radiocommunication Conference

### **WKR**

Watch Keeping Receiver  
The WKR is the receiver dedicated to monitoring the distress and safety frequencies.

## ● DSC terms

### Address

General term for Maritime Mobile Service Identity number (MMSI).

This equipment uses To/From to distinguish between the sender and receiver. It also means the Self-ID (own ship MMSI) and Dist-ID (MMSI of a ship in distress).

### Category

Message code indicating priority of the call.

Priority levels are listed below.

- Routine... General calls for routine work
- Safety... Calls for safety communications
- Urgency... Calls for urgent communications
- Distress... Calls for distress communications

### EOS (End Of Sequence)

Termination code appended to call messages.

Other codes are listed below.

- ACK RQ... Acknowledgement request
- ACK BQ... Acknowledgement responding to the ACK RQ

### ECC (Error Check Character)

Error check code appended to the end of call messages.

This is not normally displayed, but if an error occurs on a message, an ECC error is displayed.

### Mode

Message code indicating communication mode after a DSC call.

This equipment is fixed to radiotelephone.

### Nature of Distress

Message code indicating the type of distress when a distress call is issued.

Codes are listed below.

- Fire... Fire, explosion
- Flooding... Flooding
- Collision... Collision
- Grounding... Grounding
- Listing... Risk of ship capsizing
- Sinking... Sinking
- Disabled... Ship inoperable/adrift
- Undesignated... Undesignated distress
- Abandoning... Abandoning ship
- Piracy attack... Piracy/robbery attack
- Man overboard... Man overboard

### Polling

Polling is a feature for routine calling.

It is used, for example, to confirm whether a ship is within radio range when a coast station requests navigational information of the ship.

### Reason

Message code indicating reason for negative acknowledgement response.

Codes are listed below.

- No reason... No reason
- Congestion... Maritime information exchange center congested
- Busy... Busy
- Queue... Queued
- Barred... Station barred
- No operator... No operator
- Temp no oper... Temporarily no operator
- EQP disabled... Equipment disabled
- Unable FRQ... Indicated frequency cannot be used
- Unable mode... Indicated mode cannot be used

### Rx FRQ

Received frequency of the call

### Subject

Message code clarifying communication contents when sending an urgency call to all ships.

When sailing in dangerous waters, such as in areas of political instability, these call messages are used with the following information.

- Neutral ship: In accordance with ITU resolution 18 (Mob-83), inform all ships that own ship is of neutral nationality.
- Medical TRANSP: Inform all ships that own ship is performing medical transportation, and is protected under the 1949 Geneva Convention.

### Topic

Message codes in an acknowledged message

After sending an individual call, "Unable to comply" is displayed when the responding station cannot comply.

**Type**

Message code indicating the type of the call.  
Codes are listed below.

- Individual call... Individual call message
- Individual ACK... Acknowledgement of individual call message
- Individual NACK... Negative acknowledgement of individual call message
- Group call... Group call message
- GEO area call... Area call message
- All ships call... Call to all ships
- Distress... Distress call message
- Distress ACK... Acknowledgement of distress call message
- Distress relay... Distress relay message
- Distress relay ACK... Acknowledgement of distress relay message
- Distress relay GEO... Area call of distress relay message

**Intent**

Message code indicating specific content.  
Indicates the type of the call for a specific purpose, not for radiotelephone communication.

- Polling... Polling
- Position RQ... Ship position request
- Ship position... Ship position notification
- Test... Safety test call

**Work FRQ**

Message code indicating communication frequency after a DSC call.





# 1. EQUIPMENT OVERVIEW

## 1.1 Functions

This equipment includes MF/HF transceiver, Class-A DSC and DSC watch keeping receiver required as the Global Maritime Distress and Safety System (GMDSS). It is designed as a separated transceiver and small, lightweight controller(s) for easy installation not only in international passenger ships and freight ships of 300 tons or more, but also conventional ships of less than 300 tons. It has the DSC routine and distress call functions, and function keys that can be set to run a self-diagnostic function and DSC safety test call for periodic inspections.

## 1.2 Features

- Compliant with the ITU Radio Regulations (RR), the IMO performance standards, and the ITU-R recommendations.
- Contains all channels specified in the ITU Radio Regulations (RR).
- Separately designed transceiver and controller enable easy installation in limited or difficult spaces.
- A semi-transmissive LCD with a wide viewing angle is easily viewable even in direct light or when backlit and allows it to be installed in a variety of positions.
- The backlights of the LCD and operation keys are fully adjustable, preventing interference with night watch keeping.
- When in distress, the DSC can send a distress message with the expanded position data accurate up to 1/10000 of a minute for both latitude and longitude to make search and rescue operations by the RCC easier.
- High-quality stable operation is possible by using DSP technology on a transceiver with a DSC/WKR modem.
- The DSC/WKR modem operates in Class A mode suitable for all areas, and in Class B mode limited to ships navigating in A1 and A2 areas.
- An advanced digital audio amplifier with a built-in loud speaker provides a maximum of 5 W of clear audio.
- A dedicated self-diagnosis key makes maintenance and inspection simple.
- Besides printers and GPS, other peripherals such as the remote maintenance system (RMS) can be connected to the equipment.

## 1.3 Basic configuration

### 1.3.1 Basic configuration of the main unit

No.	Description	Model	Qty	Notes
1	MF/HF transceiver	NTD-2150	1	
2	MF/HF controller	NCM-2150	1	Includes the connection cable (7ZCJD0343)
3	Handset	NQW-261	1	Includes the cradle
4	Antenna tuner	NFC-2150	1	
5	Instruction manual	7ZPJD0449	1	This manual

### 1.3.2 Options

No.	Description	Model	Notes
1	TX antenna	NAW-60	6m whip antenna
2	RX/WKR antenna	NAW-60	6m whip antenna
3	Joint box	JQD-69C	For both RX and WKR
4	Junction box	NQD-2253	
5	Coaxial connector	M-P-7, M-A-JJ	For RG-12/UY and RG-10/UY
6	AC/DC power supply	NBD-2150	
7	Battery charger	NBB-724	
8	MF/HF controller	NCM-2150	One additional controller available.
8-1	Flush mounting bracket	MPBC42957	
8-2	Mounting bracket	MPBX44354	
8-3	Connection box	NQD-2250	
9	Handset	NQW-261	Waterproof type (IP66 equivalent)
10	Printer	NKG-91	Wall mount or flush mount type
10-1	Printer connection cable	7ZCJD0254A	
10-2	Printer paper	7ZPJD0384	
10-3	Wall mounting bracket	MPBP31446	
11	Printer	DPU-414	Desktop type
11-1	Printer connection cable	7ZCJD0254A	
11-2	Printer power cable	7ZCJD0257C	
11-3	Printer paper	6ZCAF00252A	
12	Printer	NKG-800	Desktop type
12-1	Printer connection cable	6ZCSC00407	
12-2	Printer power cable	6JNKD00100B	
12-3	Printer paper	5ZPCM00006	
12-4	Ink ribbon (SP-16051)	5ZZCM00003	
13	Distress message controller	NCH-321A	

1.3.3 System configuration

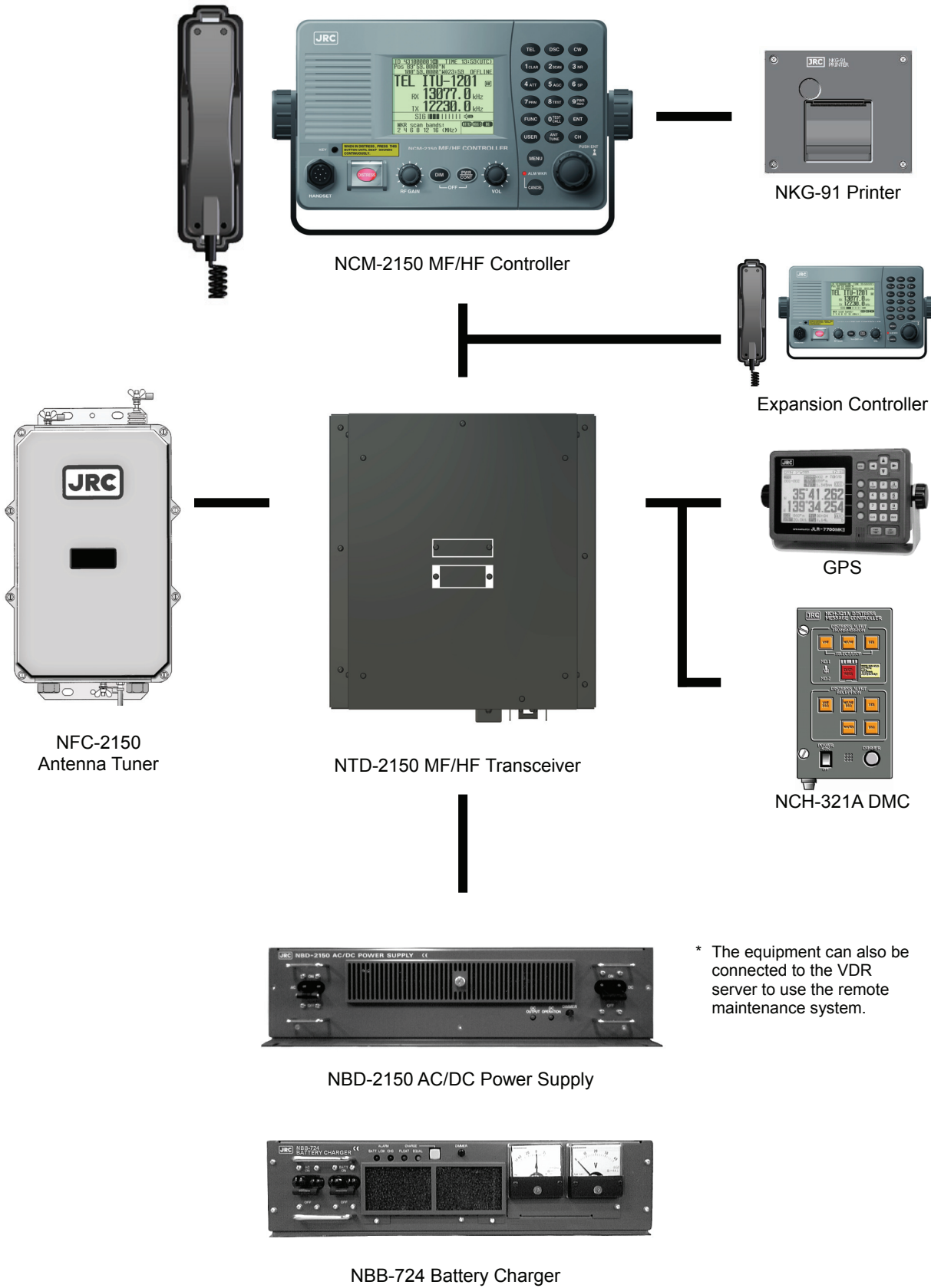

## 1.4 External dimensions

Below are the external dimensions of each unit.

### ( 1 ) MF/HF Transceiver (NTD-2150)

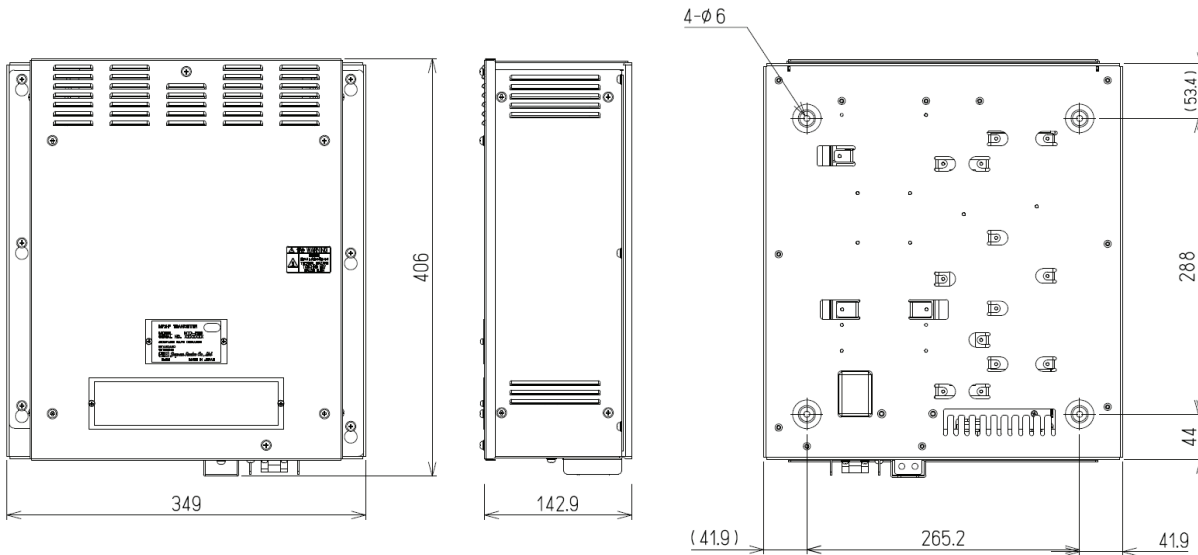

Unit: mm  
Weight: Approx. 13 kg

### ( 2 ) MF/HF Controller (NCM-2150)

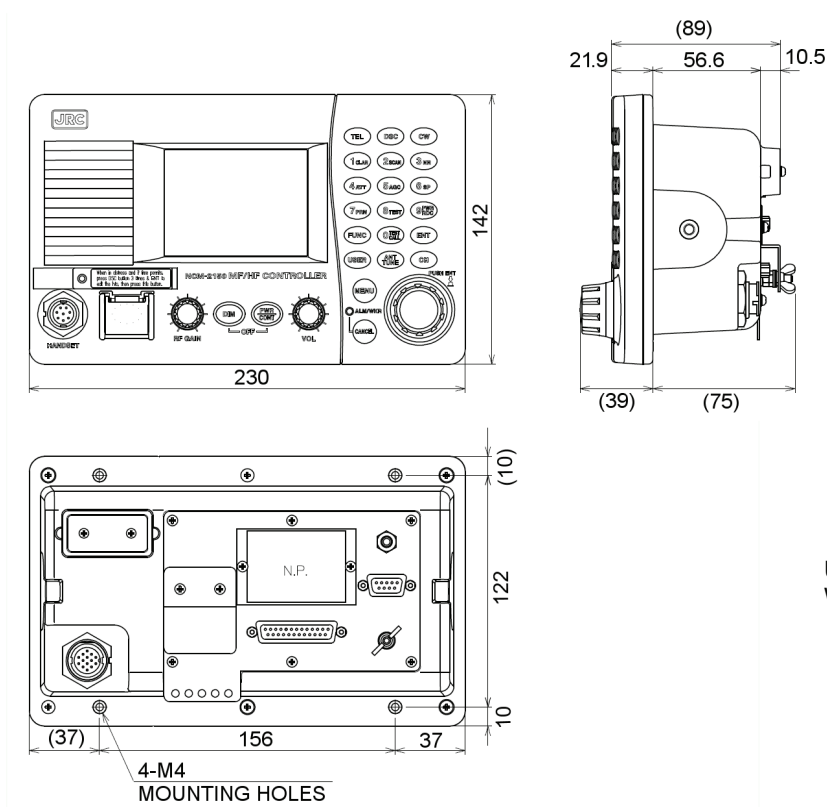

Unit: mm  
Weight: Approx. 1.3 kg

( 3 ) Handset (NQW-261)

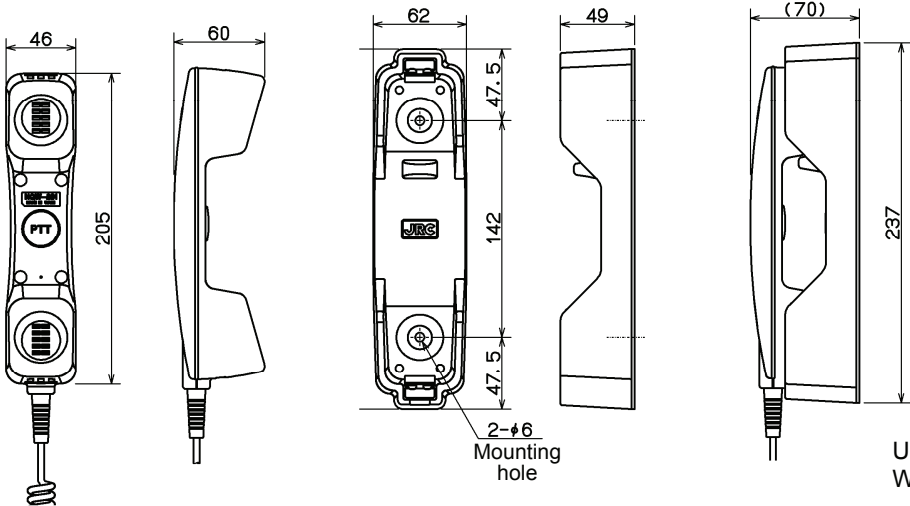

Unit: mm  
Weight: Approx. 0.5 kg

( 4 ) Connection box (NQD-2250)

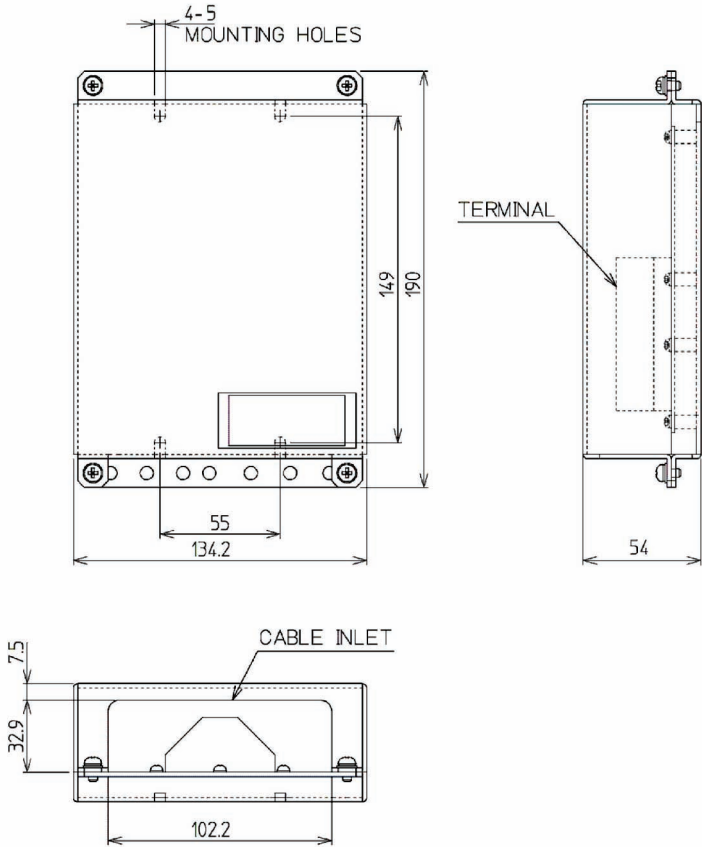

Unit: mm  
Weight: Approx. 0.6 kg

Equipment Overview

( 5 ) Antenna Tuner (NFC-2150)

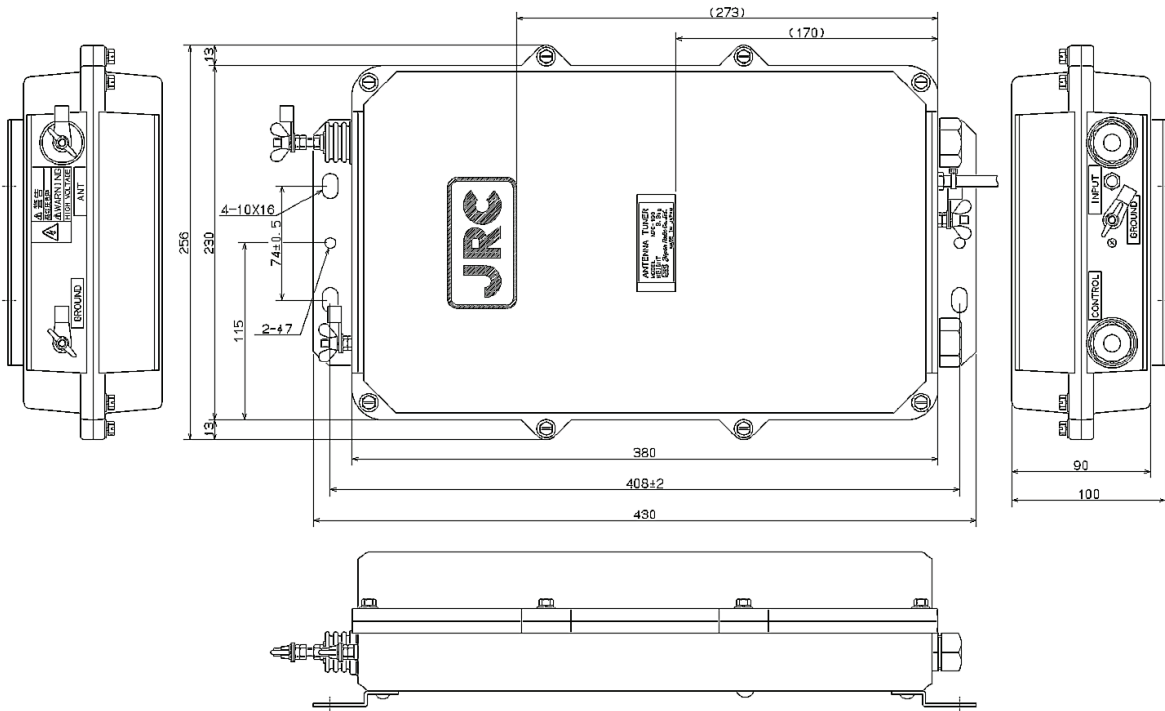

Unit: mm  
Weight: Approx. 3.3 kg

( 6 ) Junction Box (NQD-2253)

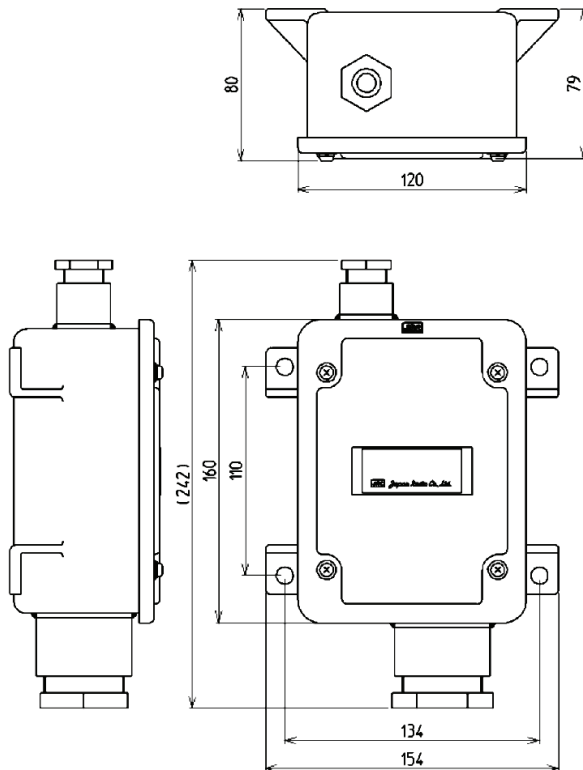

Unit: mm  
Weight: Approx. 1.2 kg



Equipment Overview

( 8 ) Battery Charger (NBB-724)

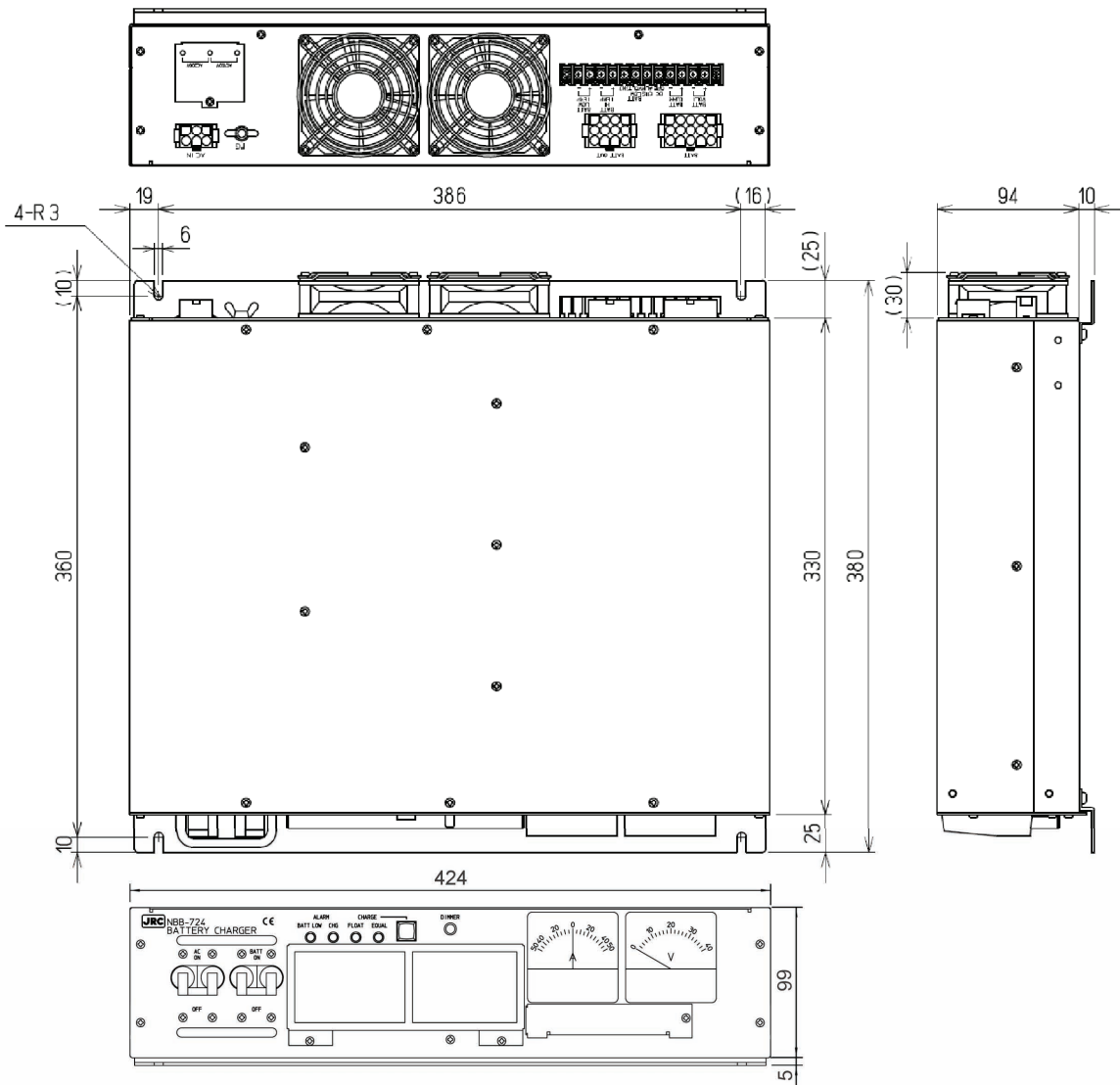

Unit: mm  
Weight: Approx. 12.0 kg



(9) Printer (NKG-91)

● Wall mount type

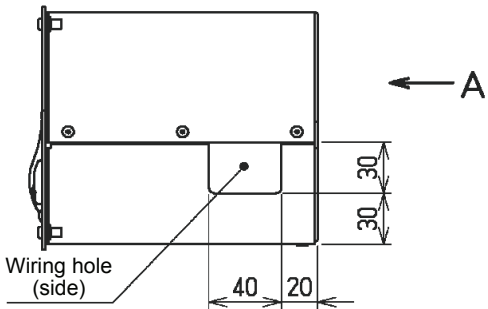
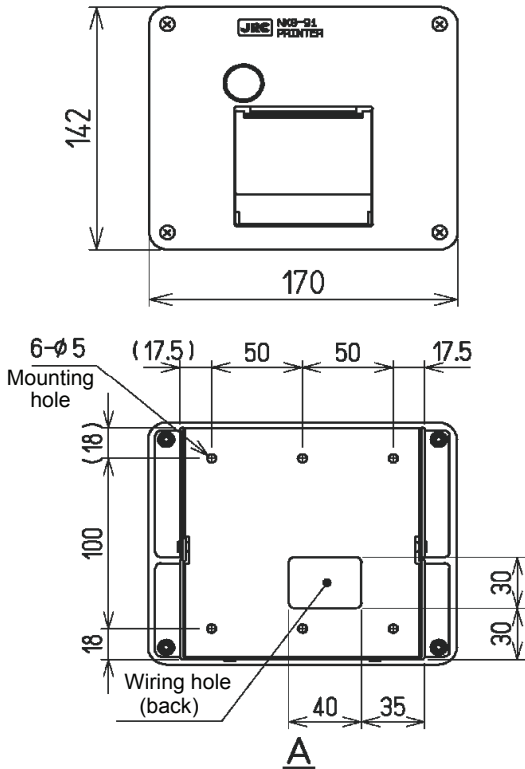

Unit: mm  
Weight: Approx. 1.5 kg

● Flush mount type

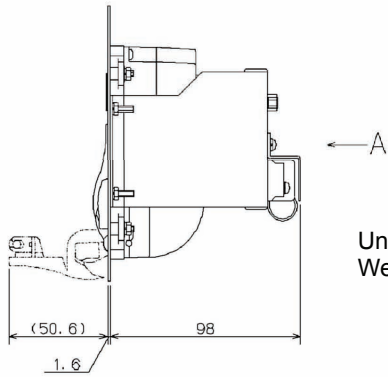
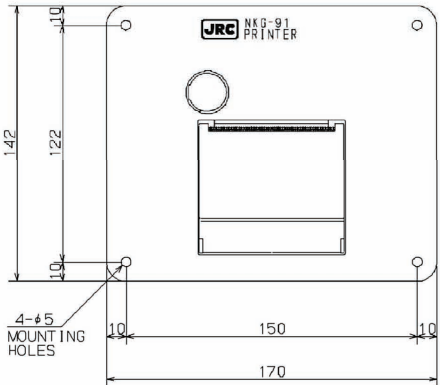
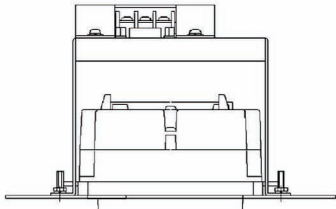

Unit: mm  
Weight: Approx. 0.8 kg

Equipment Overview

( 1 0 ) Printer (DPU-414)

- Desktop type

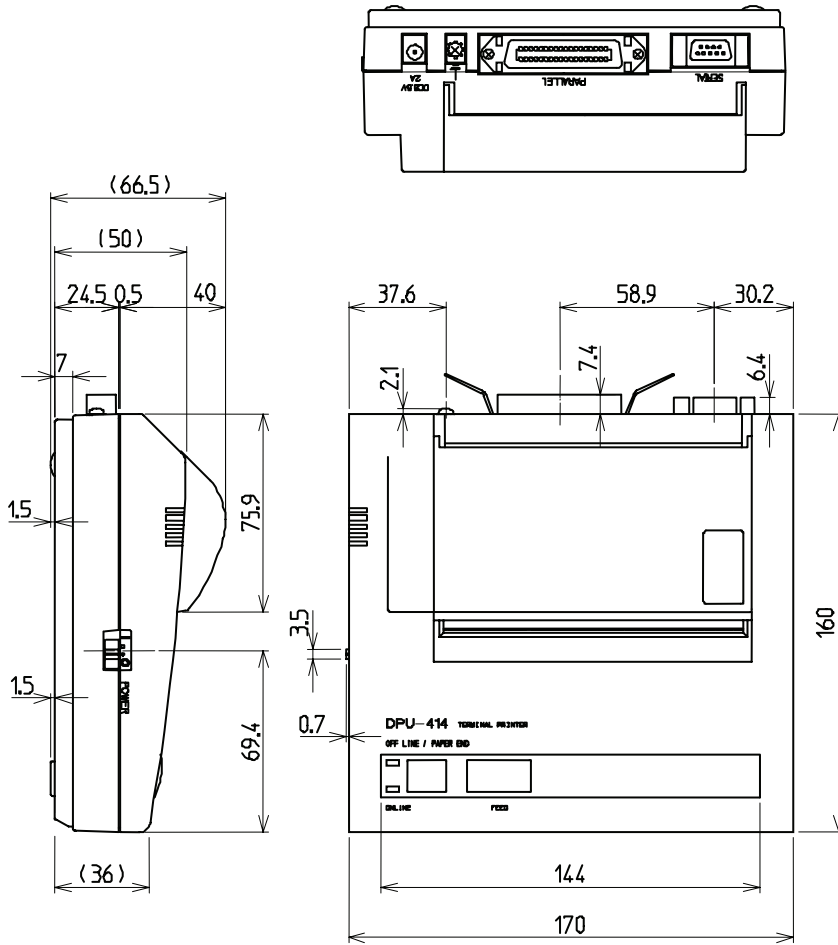

Unit: mm  
Weight: Approx. 0.6 kg

( 1 1 ) Printer (NKG-800)

- Desktop type

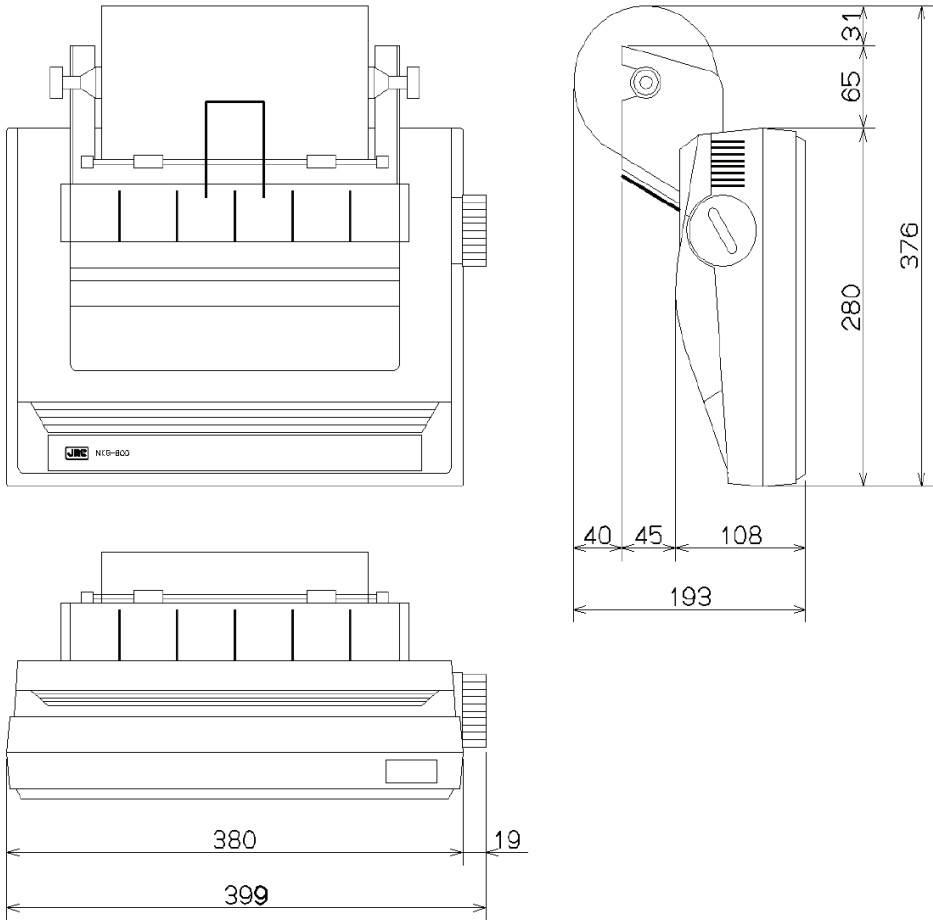

Unit: mm  
Weight: Approx. 3.7 kg

# 1.5 Block diagram

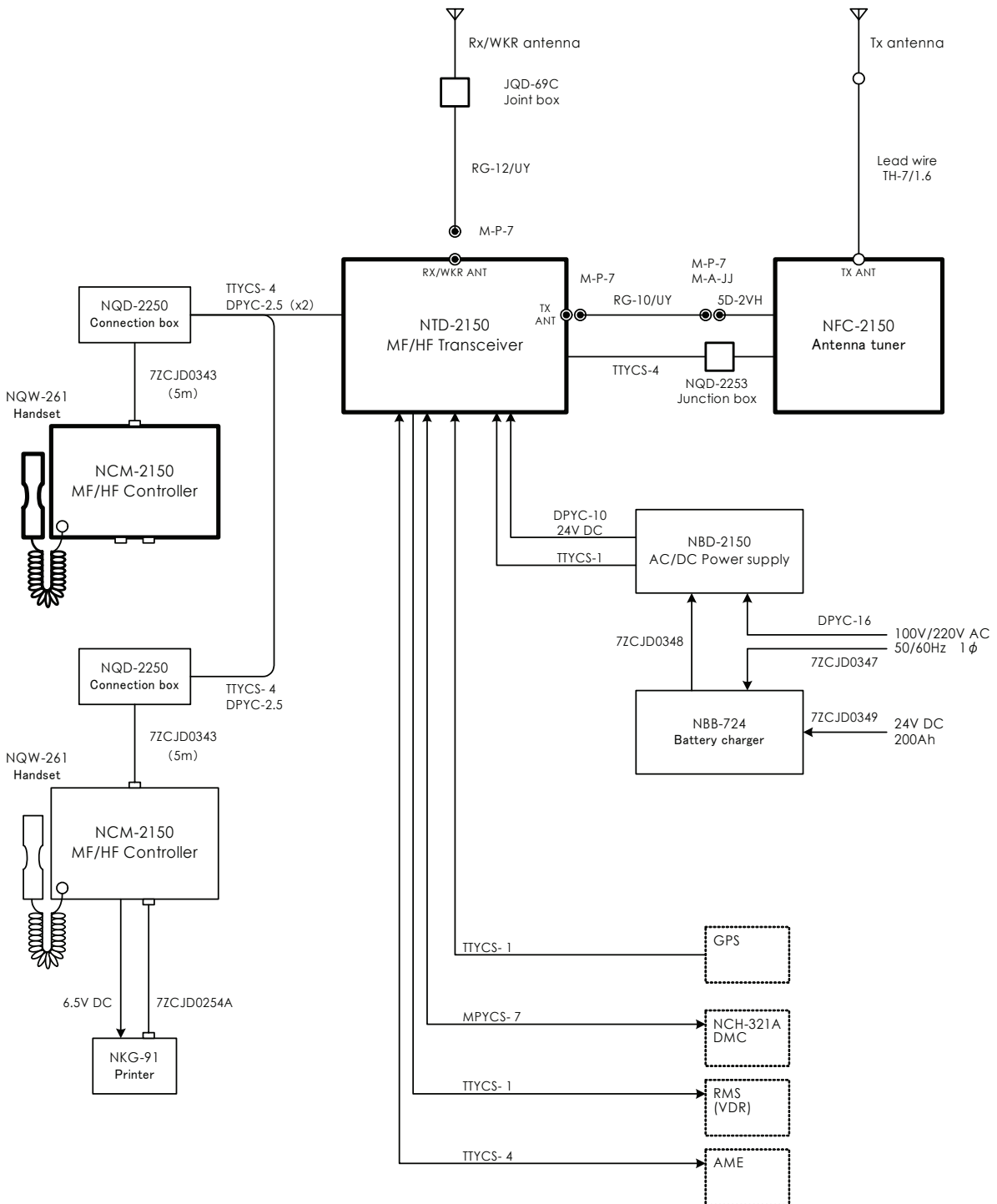

## 2. NAMES AND FUNCTIONS

### 2.1 Controller (NCM-2150)

The controller parts and their functions are described below.

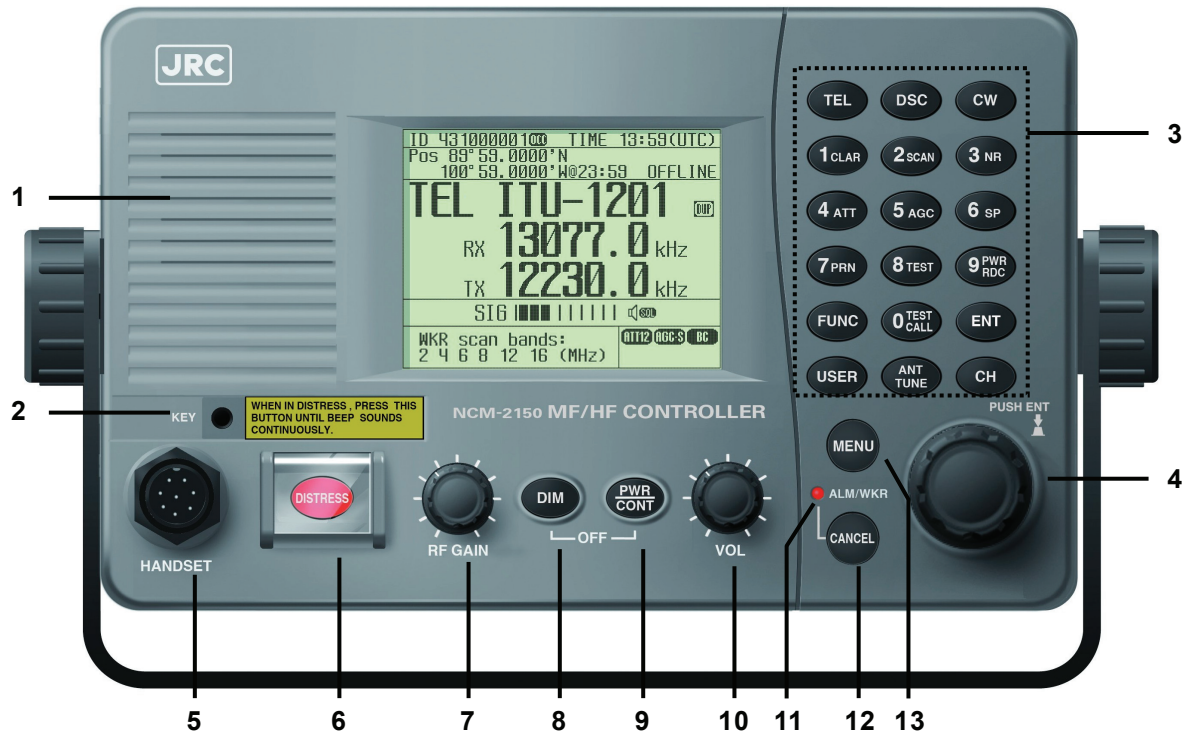

1. Internal loud speaker
2. Jack for telegraph in continuous wave (CW) mode
3. Numeric keypad (10-key) and function keys

In addition to entering numeric values, when combined with the FUNC key, the keys have the following functions.

- **TEL** ..... Displays the status display in TEL mode.
- **DSC** ..... Displays the status display in DSC mode.
- **CW** ..... Displays the status display in CW mode.
- **1CLAR** ..... Displays the setting screen for the clarifier.
- **2SCAN** ..... Displays the scan menu.
- **3NR** ..... Displays the setting screen for noise reduction.
- **4ATT** ..... Displays the setting screen for attenuation.
- **5AGC** ..... Displays the setting screen for AGC (automatic gain control).
- **6SP** ..... Turns speaker on or off.
- **7PRN** ..... Prints the specified screen.
- **8TEST** ..... Displays the self-diagnosis menu.
- **9 PWR RDC** ..... Switches Tx power between high and low.
- **0 TEST CALL** ..... Displays the DSC test call menu.
- **FUNC** ..... Enables functions assigned to number keys.

## Names and Functions

- **ENT** ..... Enter key.
- **USER** ..... User defined key. Register a frequently used menu and use this key to open it quickly.
- **ANT TUNE** ..... Tunes the antenna.
- **CH** ..... Sets the communication channel input mode (user channel, ITU channel, or free frequency).

### 4. Jog dial

- On the status display, rotating the jog dial changes the channel or Rx frequency.
- On a menu or popup screen, rotating the jog dial moves the cursor position or screen contents. When selecting a button or an item on the screen, rotate the jog dial until the cursor is on it and then press the jog dial.

**Note** Press the jog dial to obtain access rights from another controller.

### 5. Handset connector

### 6. DISTRESS key (Under a clear cover with spring)

When in distress, sends a DSC distress call when pressed and held for 4 seconds.

### 7. RF GAIN control

Adjusts sensitivity level.

**Note** Gain is set to maximum immediately after DSC mode is set, regardless of the position of the control.

### 8. DIM (Dimmer) key

Adjusts dimmer level (Max → Typ → Min → Off) of the LCD display and key switches. Additionally used to put into sleep mode by pressing it in combination with the **PWR/CONT** key at the same time (a confirmation screen is displayed).

- Note**
- The adjusted dimmer level is not saved. When the controller is powered off and on again, the dimmer level is always set to Typ (default).
  - If a DSC message is received, the dimmer adjustment cycle becomes "Max → Typ → Typ → Typ" while the receiving alarm is activated.

### 9. PWR/CONT (Power/Contrast) key

Turns on the equipment or changes the controller from sleep mode to standby. Once turned on, this key is also used to adjust the LCD contrast.

### 10. VOL (Volume) control

Adjusts volume of built-in loud speaker.

### 11. ALM/WKR lamp

Lights up red on any malfunction detected in the equipment or after sending a DSC distress call, or blinks red on receiving a DSC call. Lights green to indicate the DSC watchkeeping receiver is operating while the equipment is in sleep mode.

### 12. CANCEL key

Cancels menus or stops alarms.

### 13. MENU key

Displays menu list.

### 14. Handset

When using in radiotelephone mode, press and hold the PTT key to talk.

### 15. Cradle (for handset)

## 2.2 Main displays

The LCD screen on the controller changes according to current conditions. This section describes the status display, FUNC menu, main menu, and DSC message receiving screens.

### 2.2.1 Status display

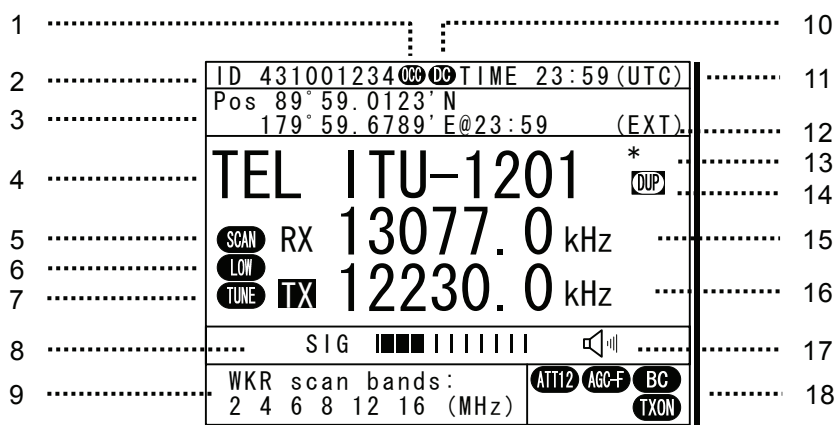

1. Occupied mark. Indicates another controller has the access rights.
2. Indicates the ship's MMSI.
3. Indicates the ship's position and that time.
4. Indicates the communication mode and channel.
5. Indicates the receiver is scanning.
6. Indicates Tx power is low.
7. Indicates the following conditions if Tx frequency is not tuned.
  - Not tuned : Blinks
  - Tuning : Lights
  - Tuned : Off
8. When in reception or standby, indicates strength of received signal (S meter), or when in transmission, indicates strength of transmitted signal in one of the pre-set units shown below.
  - Tx power (PWR)
  - Antenna current (Ia)
  - PA voltage (Vc)
  - PA current (Ic)
9. Indicates the frequency (band) the DSC watch keeping receiver is monitoring for distress and safety calls.
10. Indicates the equipment is running on DC power.
11. Indicates current time as follows:
  - Universal time coordinated : UTC
  - Local time : LT
12. Indicates the source of the ship's position information as follows.
  - External device (e.g. GPS) : EXT
  - Manual input : MAN
  - No input : OFFLINE
13. Indicates the user channel in use is transmitted at the band power level because the channel power is not registered.
14. Indicates channel or frequency is duplex for communicating with a coast station.
15. Indicates the reception frequency.
16. Indicates the transmission frequency. TX mark is highlighted when transmitting.
17. Indicates the built-in loud speaker is on or off.  indicates the squelch is on.
18. Indicates the reception status (attenuation, AGC, noise reduction) and transmission status (PA power).

**2.2.2 Function screen and key operations**

The functions assigned to the number keys are temporarily enabled by pressing the FUNC key in the status display or pressing and holding the FUNC key and then pressing the number key.

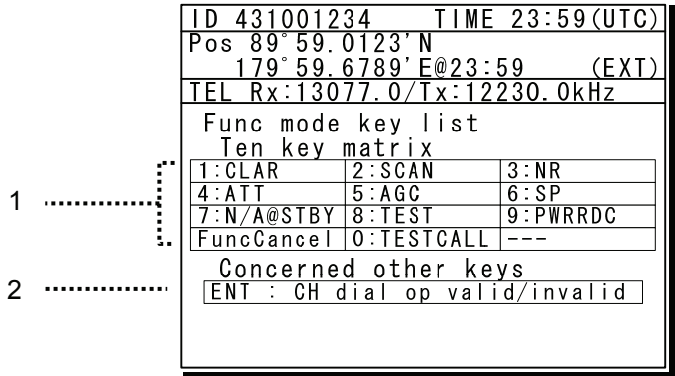

1. Indicates the enabled number key and its function when the FUNC key is pressed in the status display. Pressing the number keys here operates the function for that key as shown at the right.

- 1 CLAR : Displays the clarifier adjustment menu
- 2 SCAN : Displays the scan menu
- 3 NR : Displays the noise reduction menu
- 4 ATT : Displays the attenuation menu
- 5 AGC : Displays the AGC menu
- 6 SP : Turns the built-in loud speaker on or off
- 7 PRN : N/A (This screen cannot be printed)
- 8 TEST : Displays the self-diagnosis menu
- 9 PWR RDC : Displays the Tx power reduction menu
- 0 TEST CALL : Displays the DSC test call menu
- FUNC : Closes this screen (returns to the status display)

2. Indicates that pressing ENT enables or disables the use of the jog dial to change the frequency and channel in the status display.

**Note** In the following situations the function assigned to the function key cannot be used.

Equipment status	1CLAR	2SCAN	3NR	4ATT	5AGC	6SP	7PRN	8TEST	9 PWR RDC	0 TEST CALL
DSC mode	●		●							
In status display while inputting frequency	●	●	●	●	●	●	●	●	●	●
While tuning antenna or transmitting	●	●	●	●	●	●	●	●	●	●
While printing	●	●	●	●	●	●	●	●	●	●
During self-diagnosis	●	●	●	●	●	●	●	●	●	●
While scanning	●						●		●	
While waiting for DSC acknowledgement	●	●	●				●	●		●
While just received DSC message is displayed	●	●					●	●		●
While alarm screen is displayed	●	●	●	●	●	●	●	●	●	●



### 2.2.3 Menu screen

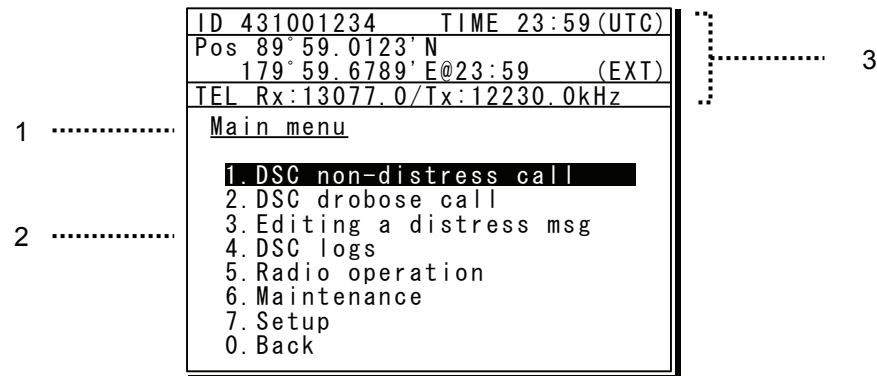

1. Indicates the current menu name.
2. Indicates the menu content. The cursor line or position is highlighted. Select items with the jog dial and press ENT to confirm.
3. Indicates the main radio information the same as the status display. Also indicates the following marks in the frequency information area according to the conditions.

**T** : Tuning condition  
**L** : Tx power is low

### 2.2.4 DSC message receiving screen

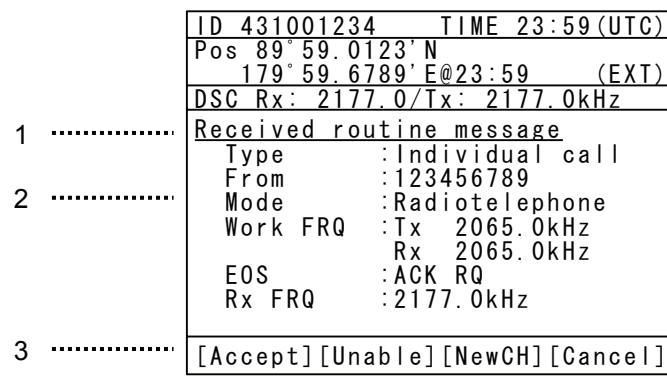

1. Indicates the received message category. (Routine, Safety, Urgency, Distress)
2. Shows the received message. The example above shows the following contents.
  - Type : Individual call to own ship
  - From : The caller's MMSI is 123456789.
  - Mode : Radiotelephone is requested as a subsequent communication type.
  - Work FRQ : Indicates the proposed working channel
  - EOS : Acknowledgement requested
  - Rx FRQ : The received frequency of this call
3. Indicates message handling menu for received message. The example above shows the following.
  - [Accept] Select to agree to the call, and start radiotelephone communications immediately.
  - [Unable] Select to not agree to the call, and reply to the call as "unable to comply".
  - [NewCH] Select to agree to the call except on the proposed channel, and reply to the call with a new channel proposal.
  - [Cancel] Return to the previous screen.

**Note**

- When [Unable] or [NewCH] is selected, an editing screen appears.
- In the case of the position request, test, and polling calls, if the Auto ACK setting is on and acknowledged automatically, the receiving screen is not displayed. Also, when the Auto ACK setting is off, the above receiving screen is displayed and [Send ACK] appears for sending the acknowledgement.

### 3. INSTALLATION

#### CAUTION



To install this equipment, contact our service center or agents.  
Special knowledge on selecting the place where the antenna is to be mounted and setting the ID number (MMSI) assigned to the ship is required in addition to installing the equipment.

## 4. OPERATION

This chapter describes basic controller operations, radiotelephone communications, DSC calling procedures, and other radio functions.

### 4.1 Controller operation overview

Basically, the controller is operated with the numeric keypad (10key), the **MENU** key, and jog dial. The following is an overview of their operation.

- When two controllers are connected, only one controller having the access right can operate the radiotelephone, except for sending a distress call, changing audio volume, and changing display conditions. (Unless otherwise mentioned, the instructions below are for the controller with the access rights.)
- To obtain the access right at a controller without access rights, press ENT to get the access right unless the other controller is being operated (PTT/KEY ON or menu operations).
- The **DISTRESS** key is always available even if the controller does not have the access right. (The DISTRESS key has the highest priority.)
- On the status display, the communication frequency or channel can be set by using the number keys or by rotating the jog dial.
- Pressing the **TEL**, **DSC**, or **CW** keys changes the communication mode and returns the menu display to the status display. When this is done, the channel input mode changes to the free frequency mode.
- When the communication mode is set to TEL or CW, pressing the same communication mode key turns the PA on and off. (When the PA is on, **TXON** appears.)
- All functions can be accessed using the **MENU** key, jog dial, and the dedicated keys/controls. (See the menu tree of the equipment on the next page.)
- Pressing or pressing and holding the **FUNC** (function) key and a number key allows rapid access to that function.
- There are two ways to access main menu items. After pressing the **MENU** key to display the main menu, use either the jog dial to move the cursor to the desired item and press ENT to select it, or select the item by pressing the respective number key. (Ex: For Self diagnosis (6.1.1 Transceiver), press **MENU** → **6SP** → **1CLAR** → **1CLAR**)
- Any menu can be assigned to the **USER** key to quickly open it with a single touch of a button.
- Normally the **ANT TUNE** key is always enabled.
- The **CH** key's channel input mode can be changed to a User channel, ITU channel, or to a free frequency. This key is only enabled when the status display is displayed.
- Pressing the **CANCEL** key in any menu moves the display up one level in the hierarchy (or to the status display). The same results can be achieved by selecting "0. Back" when available on-screen. Further, pressing the **CANCEL** key on an input line will clear the entered data.
- Pressing the **MENU** key in any menu opens the main menu. Also, pressing **MENU** while in the main menu returns to the status display.
- If no operations are done for 10 minutes while a menu is open, the screen automatically returns to the status display.
- Dialog boxes (popup screens) are opened when necessary and operations can be done in the dialog box.
- Screens in the menu tree on the following page indicated by "Printable" can be printed from a printer connected to the controller by pressing and holding the **FUNC** key and then pressing the **7PRN** key.

# Operation

## Menu tree

Main Menu	Hierarchical Menu 1	Hierarchical Menu 2	Shortcut Key	Note	
1. DSC non-distress call			FUNC - 0		
2. DSC drobose call					
3. Editing a distress msg					
4. DSC logs	4.1 Received distress	(Received message screen)		Printable	
	4.2 Received others	(Received message screen)		Printable	
5. Radio operation	5.1 User channel list (index)	5.1 User channel list (table)		Printable	
	5.2 ITU channel list (index)	5.2 ITU channel list (table)		Printable	
	5.3 Mode				
	5.4 Receiver	5.4.1 Auto gain control		FUNC - 5	
		5.4.2 Noise reduction		FUNC - 3	
		5.4.3 Attenuation		FUNC - 4	
		5.4.4 Clarifier		FUNC - 1	
		5.4.5 Squelch			
		5.4.6 CW bandwidth			
	5.5 Transmitter	5.4.7 Scan		FUNC - 2	
5.5.1 Power			FUNC - 9		
	5.5.2 Tune power				
6. Maintenance	6.1 Self diagnosis	6.1.1 Transceiver - ATU - PA - TRX - WKR MODEM	FUNC - 8	Printable	
		6.1.2 Controller		Printable	
		6.1.3 Transceiver log		Printable	
		6.1.4 Controller log		Printable	
		6.1.5 DSC loop			
	6.2 Alarm information	Alarm history		Printable	
	6.3 Software version			Printable	
7. Setup	7.1 Date & time	7.1.1 Date			
		7.1.2 Present time			
		7.1.3 Display form			
	7.2 POS/TIME	7.2.1 Own position			
		7.2.2 UTC of position			
	7.3 My controller	7.3.1 LCD adjustment 1. Contrast 2. Dimmer 3. Screen saver			
		7.3.2 Sound 1. Operation 2. Notification level 3. Sidetone		FUNC - 6 <sub>(SP)</sub>	
		7.3.3 User key assign			
		7.3.4 Tx meter			
		7.3.5 Data transfer			
		7.4 User channels (index)	7.4 User channels (table)		Printable
	7.5 DSC/WKR condition	7.5.1 Automatic ACK 1. Test call 2. Position RQ call 3. Polling call			
		7.5.2 WKR scanning FRQ			
		7.5.3 Safety/Routine alarm			
		7.5.4 Medical/Neutral use			
		7.5.5 Group-ID			
	7.6 Option	7.6.1 Connection			Printable
7.6.2 Data out					
7.6.3 Baudrate					
7.6.4 Flow control					
7.6.5 Print direction					

## 4.2 Basic communications procedure

The following describes basic radio communication procedures.

### 4.2.1 Turning on the power

# ⚠ CAUTION

Do not turn off the equipment when at sea because the SOLAS Convention requires keeping watch on distress and safety frequencies at all times. Always listen to 2187.5 kHz and 8414.5 kHz, and one or more of the following frequencies; 4207.5 kHz, 6312.0 kHz, 12577.0 kHz, or 16804.5 kHz. In class B mode, it is necessary to keep watch only on 2187.5 kHz.

#### ■ Procedure ■

1. Make sure the equipment is connected to a power source and turn on the breaker on the transceiver.
  - The controller and transceiver start the internal check. After the check is finished correctly, the status display appears and becomes receiving condition (standby) on the receiving frequency showing.
  - If the NBD-2150 AC/DC Power supply is connected, turn on its breaker first.

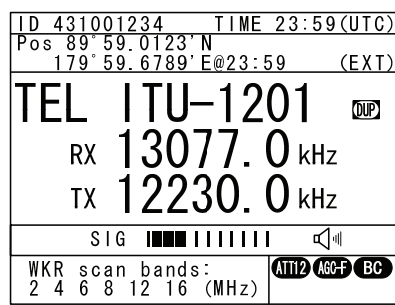
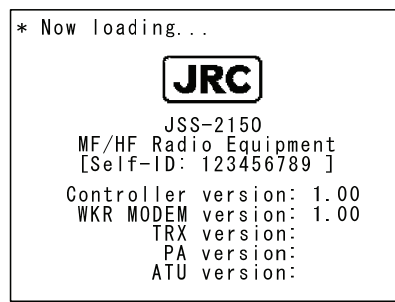

**Note**

- When turning on the controller or the equipment in sleep mode, press **PWR CONT** key for one second.
- Pressing **PWR CONT** key for 6 seconds makes the system reset to restart.
- When two controllers are connected, and one controller is turned on from sleep mode, the status display is displayed immediately without checking operations.
- If errors are detected during the operation check, the message is displayed. Please inform JRC or our agent of the error contents.

**4.2.2 Turning off the power/ Putting into sleep mode**

**⚠ CAUTION**



When completely turning off the power to the equipment, turn off the breaker on the transceiver

**■ Procedure ■**

1. Press the **PWR/CONT** key and **DIM** key simultaneously.

After that, the power-off process is activated according to the controllers' status.

- **When using only one controller**  
 Select the desired item below on the popup screen shown at right
  - [OK]: Turns off the power. (Puts into sleep (energy saving) mode.)
  - [Cancel]: Returns to the previous screen.

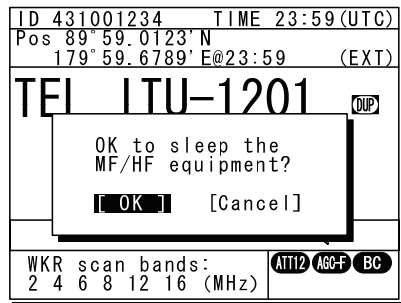

- **When using two controllers**  
 On a controller with access rights, select the desired item below on the popup screen shown at right
  - [EQP]: Turns off the power. (Puts into sleep (energy saving) mode.)
  - [CTRL]: Puts the controller into sleep mode and gives access rights to another controller.
  - [Cancel]: Returns to the previous screen.

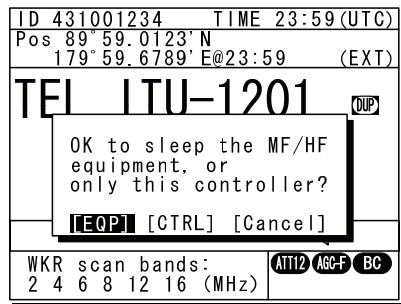

- On a controller without access rights, select the desired item below on the displayed popup screen at right
- [OK]: Puts one controller into sleep mode.
  - [Cancel]: Returns to the previous screen.

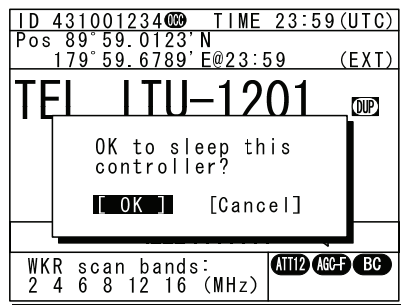

**Note**

- In sleep mode, the equipment and controller change to the following statuses.
  - If all the equipment goes to sleep, the ALM lamp lights green to indicate the DSC watch keeping receiver is on and operating.
  - If a distress or urgent DSC message is received, the equipment automatically turns on and sounds an alarm.
- Turn off both the AC and DC breakers if turning off the power at an external NBD-2150 AC/DC Power supply.

**4.2.3 Communicating in radiotelephone mode**

Use the handset to communicate in radiotelephone mode.

**■ Procedure ■**

1. When operating on a controller without access rights (OCC is displayed), press the jog dial to obtain the access rights.

Unless the controller with access rights is being used, the access rights are acquired and the OCC display on the screen disappears.

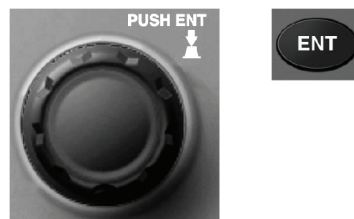

2. Press the **TEL** key.

- The communication mode is set to TEL.
- Pressing the **TEL** key again turns the power to the PA on and off.
- If the power to the PA is on, **TXON** is displayed as shown at right.

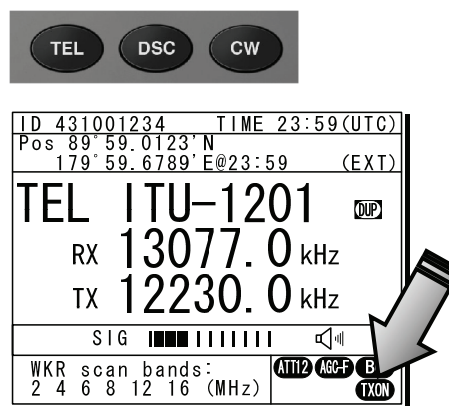

3. Set the frequency for making calls in radiotelephone mode.

- Note**
- The frequency is set on the receiving status in the status display. For details, see "4.3.1 Setting the communication frequencies" and "4.3.2 Setting the communication channels".
  - See the frequency for making calls in the appendix "11.4 ITU channel list (TEL/CW)".



4. Adjust the volume of the loudspeaker by turning the volume control.



5. Turn the RF GAIN control to an appropriate reception level.



## Operation

6. Press the **ANT TUNE** key to tune the antenna.

**Note**

- **TUNE** blinks if the transmission frequency is not tuned.
- Even if **TUNE** is not displayed, tune the antenna before making a call.
- **TUNE** lights during tuning. It goes out after tuning.

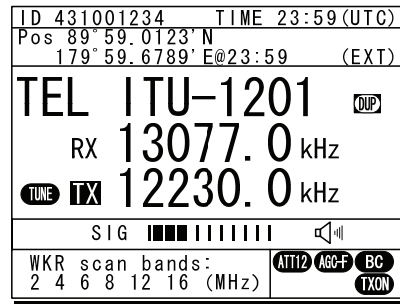

7. Lift the handset from the cradle.

8. Press the PTT key to talk.

The **TX** and **TXON** marks appear on the screen to show the equipment is transmitting. Releasing the PTT key returns it to receiving.

**Note**

Pressing the PTT key turns on the power to the PA automatically.

9. When finished communicating, return the handset to the cradle.

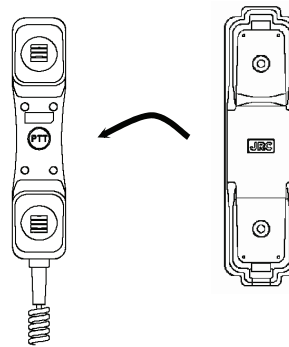

## ■ Making a radiotelephone call ■

1. Set a frequency the objective station is monitoring.
2. Lift the handset from the cradle.
3. Press the PTT key, check that **TX** and **TXON** are displayed and make a call as described below.
  - Say the name of the station being called ... Repeat 3 times.
  - Say "This is..."
  - Say own ship name ... Repeat 3 times.
  - If necessary, indicate your working frequency.
  - "over"
4. Release the PTT key to listen.
5. Start communicating according to the response. When changing frequencies, make sure that no other stations are using the indicated working channel.

**Note**

- When transmitting from your own station, always press the PTT key while talking.
- On a simplex channel, always say "over" just before releasing the PTT key.
- Always say "out" when terminating communications.



**4.2.4 Communicating in CW mode**

Use a CW keyer to communicate in CW mode.

**■ Procedure ■**

1. When operating on a controller without access rights (OCC is displayed), press the jog dial to obtain the access rights.

Unless the controller with access rights is being used, the access rights are acquired and the OCC display on the screen disappears.

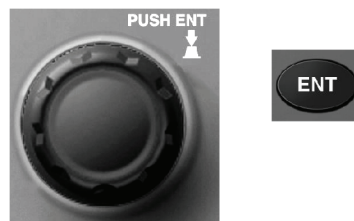

2. Press the **CW** key.
  - The communication mode is set to CW.
  - Pressing the **CW** key again turns the power to the PA on and off.
  - If the power to the PA is on, **TXON** is displayed as shown at right.

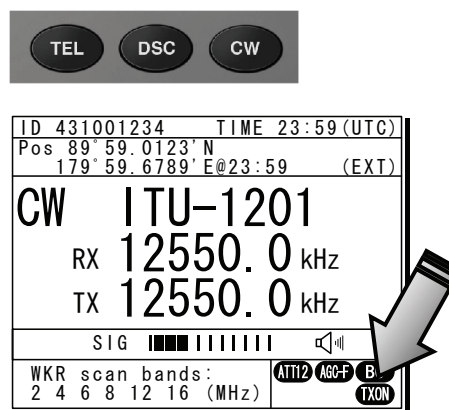

3. Set the frequency for making calls in CW mode.

**Note** - The frequency is set on the receiving status in the status display. For details, see "4.3.1 Setting the communication frequencies" and "4.3.2 Setting the communication channels".  
 - See the frequency for making calls in the appendix "11.4 ITU channel list (TEL/CW)".



4. Adjust the volume of the loudspeaker by turning the volume control.



5. Turn the RF GAIN control to an appropriate reception level.



## Operation

6. Press the **ANT TUNE** key to tune the antenna.

**Note**

- **TUNE** blinks if the transmission frequency is not tuned.
- Even if **TUNE** is not displayed, tune the antenna before making a call.
- **TUNE** lights during tuning. It goes out after tuning.

ID 431001234	TIME 23:59(UTC)
Pos 89°59.0123' N	
179°59.6789' E@23:59	(EXT)
<b>CW</b>	<b>ITU-1201</b>
RX	12550.0 kHz
<b>TUNE</b> TX	12550.0 kHz
SIG ■■■■■■■■■■	
WKR scan bands: 2 4 6 8 12 16 (MHz)	<b>ATT12</b> <b>AGC-F</b> <b>BC</b> <b>TXON</b>

7. Communicate in CW mode using the CW keyer connected to the KEY jack on the controller as shown in the figure to the right.

The **TX** and **TXON** marks appear on the screen to show the equipment is transmitting.

**Note**

- After keying on, turns on the PA power automatically.
- For the sidetone setting, see "5.3.2 Sound settings".



**4.2.5 Receiving AM broadcasts**

It is possible to listen to the radio in AM mode.

**■ Procedure ■**

1. When operating on a controller without access rights (OCC is displayed), press the jog dial to obtain the access rights.

Unless the controller with access rights is being used, the access rights are acquired and the OCC display on the screen disappears.

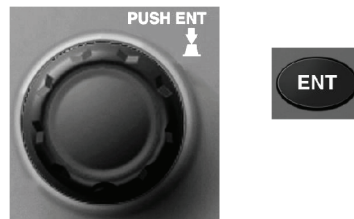

2. Press the **MENU** key, and through hierarchical menus, select 5. Radio operation.

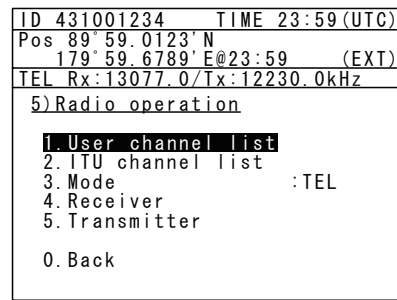

3. Move the cursor to 3. Mode, and press ENT.

Move the cursor to the right as shown in the figure at right to select a communication mode.

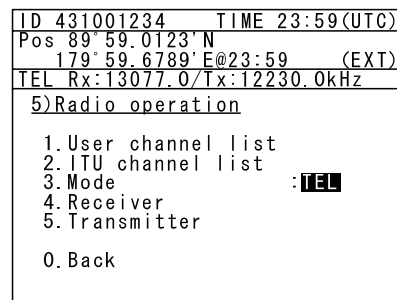

4. Turn the jog dial to select AM, and press ENT.

The communication mode is set to AM.

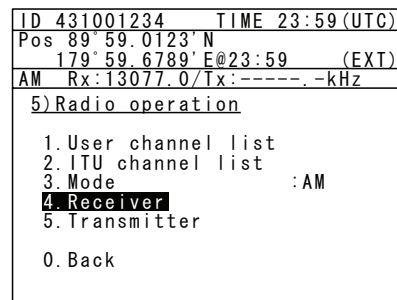

5. Press the **MENU** key twice to return to the status display and then input an AM broadcast frequency using the numeric keys. Then press ENT to receive the broadcast.

- Note**
- Adjust the reception level and volume by turning the VOL and RF GAIN knobs according to the reception conditions.
  - The AM mode is for reception only so a transmission frequency is not shown.



## 4.3 Setting the radio

This section describes how to set the communication frequencies and how to use the receiver and transceiver functions.

### 4.3.1 Setting the communication frequencies

Use the free frequency input mode to input the communication frequencies directly.

#### ■ Procedure ■

1. In the status display, use the numeric keypad to input the frequency.

**Note**

- When 1 is input using the numeric keypad, it appears on the far right as shown in the screen on the right.
- In the user/ITU channel input mode, press the **CH** key once or twice to hide the channel display.

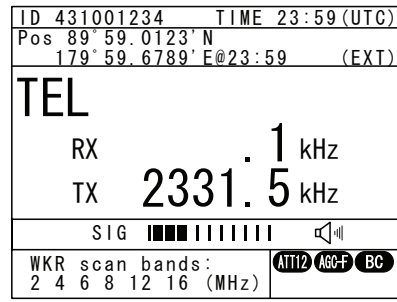

2. Input numbers to the 0.1 kHz place and press ENT.

The transmission frequency input mode opens as shown in the screen at right.

**Note**

- For a simplex frequency, press ENT to automatically input the same frequency as the receiving frequency to complete communication frequency settings.

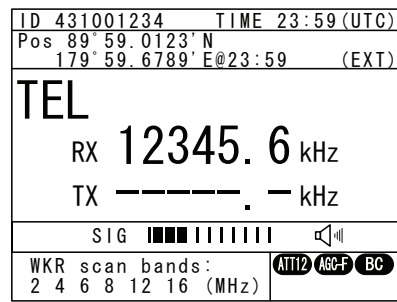

3. Input the transmission frequency in the same way as the reception frequency.

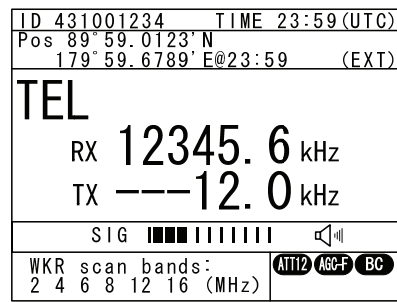

4. Input numbers to the 0.1 kHz place and press ENT.

The communication frequency settings are complete.

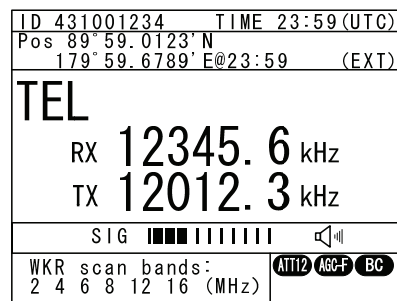

**Note**

- Turn the jog dial in the status display to change the reception frequency on the 0.1 kHz scale. For simplex frequencies, the transmission frequency is changed at the same time.

**4.3.2 Setting the communication channels**

Besides the free frequencies described previously, ITU channel mode and user channel modes can also be set. The ITU channel mode is mode for using channels based on the international standard and is built-in to the equipment. The user channel mode is the mode for using channels on pre-registered frequencies. These modes can be used according to the operations.

(1) Selecting a frequency and channel input mode

■ Procedure ■

1. Set the screen of the status display.

The status display at right shows free frequency mode.

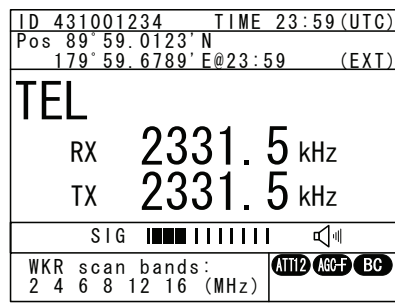

2. Press the **CH** key.

As shown below, each time the **CH** key is pressed the mode changes in order from the free frequency mode, ITU channel mode, to the user channel mode.

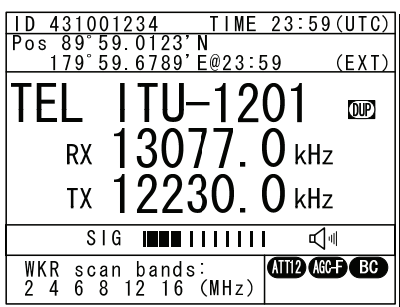
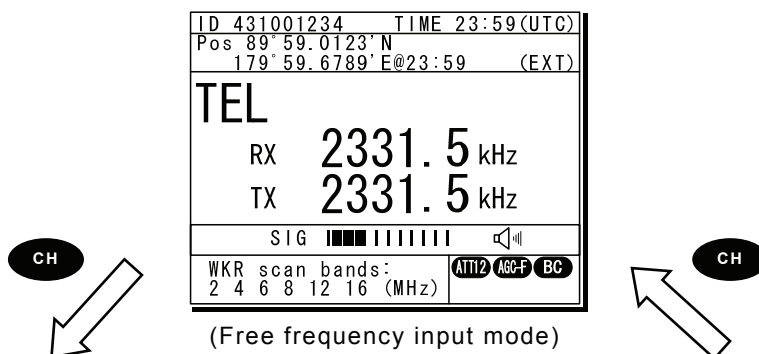

(ITU channel mode)

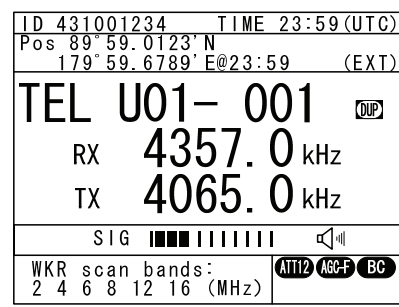
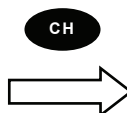

(User channel mode)

- Note**
- If changed to the ITU channel mode, the communication mode of the free frequency input mode and the previous (or lowest) ITU channel number are applied.
  - If the communication mode is changed by pressing the **TEL**, **DSC**, or **CW** keys, the free frequency input mode is set.

(2) Setting the ITU channels

■ Procedure ■

1. After setting the TEL or CW communication modes, pressing the **CH** key opens the status display for the ITU channel mode.

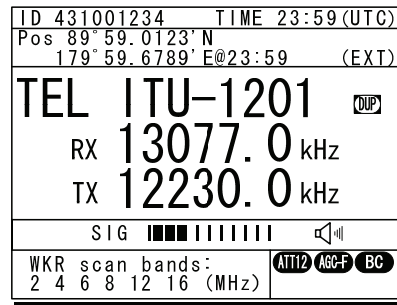

2. Input the channel by using the numeric keypad.

**Note** When 4 is input using the numeric keypad, it appears on the far right as shown in the screen on the right.

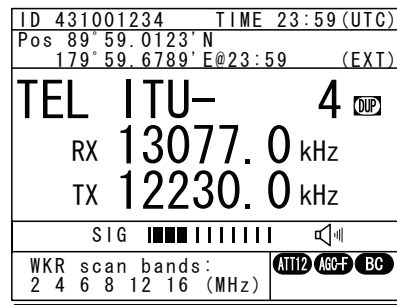

3. Input the rest of the digits and press ENT.

The input ITU channel frequency is displayed and the settings are complete.

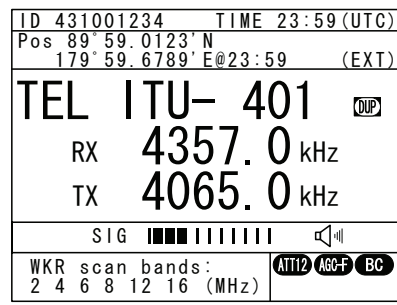

- Note**
- See the appendix "11.4 ITU channel list (TEL/CW)" for a list of pre-installed ITU channels and their frequencies.
  - Besides doing settings with the numeric keypad, settings can also be done with the jog dial.

(3) Setting user channels

A total of 20 groups with 20 channels set to each group (i.e. 400 channels) can be registered on the equipment. This section explains how to set channels that are already registered.

■ Procedure ■

1. Use the **CH** key to open the user channel mode status display.

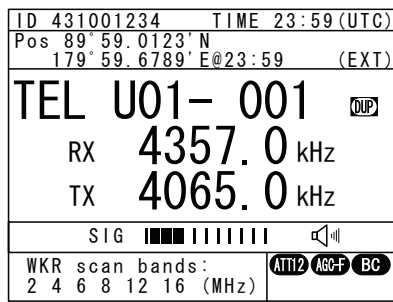

2. Pressing ENT causes the channel group number to blink so a channel group can be input.

Use the numeric keypad or jog dial to input the number of a registered group.

**Note** When 2 is input using the numeric keypad, it appears on the far right as shown in the screen on the right.

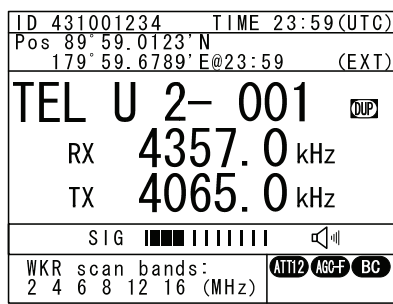

3. After inputting a group number, pressing ENT causes the channel number to blink so a user channel can be input.

Use the numeric keypad or jog dial to input the number of a registered channel.

**Note** When 3 is input using the numeric keypad, it appears on the far right as shown in the screen on the right.

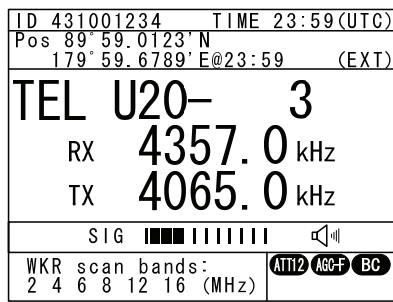

4. Input the rest of the digits and press ENT.

- The input user channel frequency is displayed and the settings are complete.
- The group name is displayed for 3 seconds after the settings are done.

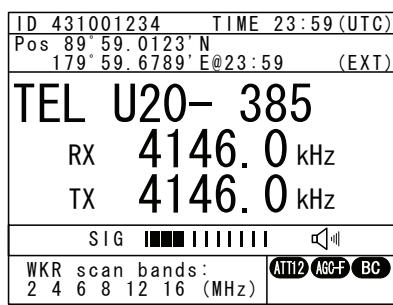

- Note**
- Channels can be set directly in the status display by using the numeric keypad or the jog dial without setting a channel group. After inputting with the numeric keypad, press ENT.
  - See "5.4 Registering user channels" for how to register frequencies to user channels.

(4) Using channel lists

Besides the procedure above, user channels and ITU channels can also be set from the channel lists (5.1 User channel list or 5.2 ITU channel list). This section explains how to set channels that are already registered from the user channel list.

■ Procedure ■

1. Press the **MENU** key, and through hierarchical menus, select 5. Radio operation.

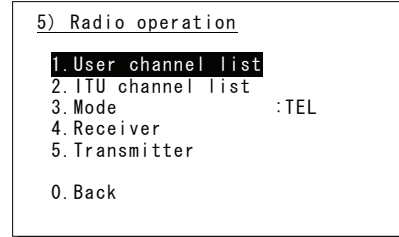

2. Select 1. User channel list and press ENT.

The user channel list index (group list) as shown at right is displayed.

No	CH group name	Type
01	JRC Tokyo	TEL
02	Pacific ABC	CW
03		
04		
05		
06		
07		
▼08		

3. Select the intended channel group and press ENT.

The user channel list as shown at right is displayed.

5.1) User channel list (table)			
Name: JRC Tokyo			
Type: TEL			
CHNo	Rx [kHz]	Tx [kHz]	Mode
001	4357.0	4065.0	TEL
002	4360.0	4068.0	TEL
003	4363.0	4071.0	TEL
004	4366.0	4074.0	TEL
005	4369.0	4077.0	TEL
▼006	4372.0	4080.0	TEL

4. Select the channel to set and press ENT.

The user channel settings are complete, the status display is displayed.

ID 431001234	TIME 23:59(UTC)
Pos 89° 59.0123' N	179° 59.6789' E@23:59 (EXT)
<b>TEL U01-001</b>	
RX	4357.0 kHz
TX	4065.0 kHz
SIG ■■■■■■■■■■	
WKR scan bands:	ATT12 ABC-F BC
2 4 6 8 12 16 (MHz)	



**4.3.3 Setting the automatic gain control (AGC)**

■ **Procedure** ■

1. Press the **MENU** key, and through hierarchical menus, select 5.4 Receiver.

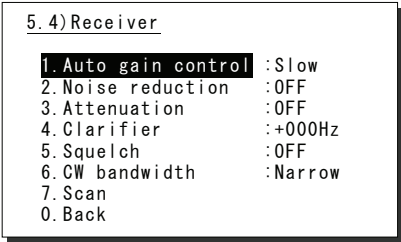

2. Select 1. Auto gain control and press ENT, when the cursor moves to the right use the jog dial to select Slow, Fast, or OFF.

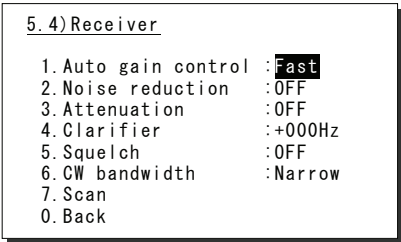

After selecting and pressing ENT, the settings are complete.

**Note** The same settings can be done by pressing and holding the **FUNC** key and the **5AGC** key at the same time.

**4.3.4 Setting the noise reduction (NR)**

■ **Procedure** ■

1. Press the **MENU** key, and through hierarchical menus, after 5.4 Receiver appears, move the cursor to 2. Noise reduction.

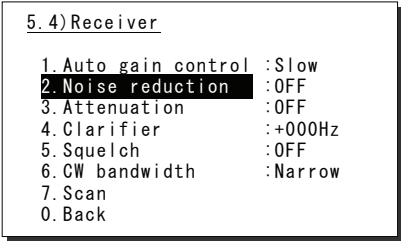

2. Press ENT to move the cursor to the right, then use the jog dial to select NR1, NR2, BC, or OFF.

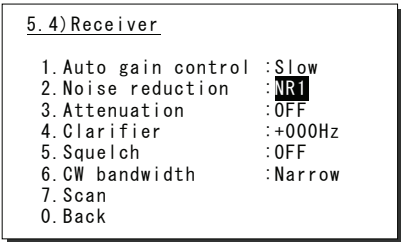

After selecting and pressing ENT, the settings are complete.

**Note**

- The various settings are shown below.
  - NR1 : Noise reduction (low)
  - NR2 : Noise reduction (high)
  - BC : Beat canceller
- The same settings can be done by pressing and holding the **FUNC** key and the **3NR** key at the same time.
- This function is disabled in DSC mode.

**4.3.5 Setting the attenuation (ATT)**

**■ Procedure ■**

**1.** Press the **MENU** key, and through hierarchical menus, after 5.4 Receiver appears, move the cursor to 3. Attenuation.

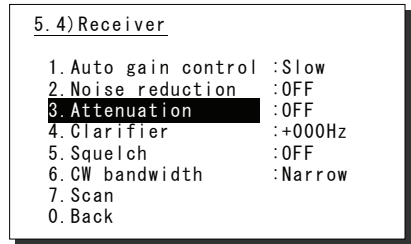

**2.** Press ENT to move the cursor to the right, then use the jog dial to select 6dB, 12dB, 18dB, or OFF.

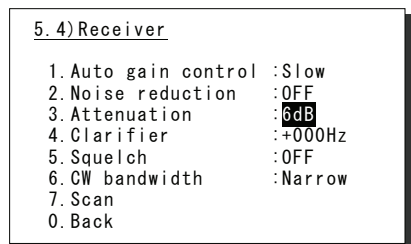

After selecting and pressing ENT, the settings are complete.

**Note** The same settings can be done by pressing and holding the **FUNC** key and the **4ATT** key at the same time.

**4.3.6 Setting the clarifier**

**■ Procedure ■**

**1.** Press the **MENU** key, and through hierarchical menus, after 5.4 Receiver appears, move the cursor to 4. Clarifier.

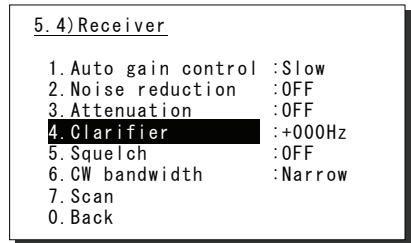

**2.** Press ENT to move the cursor to the right, then use the jog dial or numeric keypad to select a value in the range of -200 to +200 Hz.

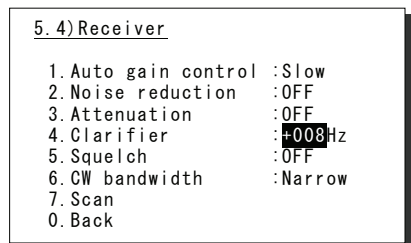

After inputting and pressing ENT, the settings are complete.

**Note**

- When using the numeric keypad, input "+" with the **1CLAR** key and "-" with the **2SCAN** key.
- Pressing and holding the **FUNC** key and the **1CLAR** key at the same time opens a popup screen. The same settings can be done here.
- This function is disabled in DSC mode.

**4.3.7 Setting the squelch level**

**■ Procedure ■**

1. Press the **MENU** key, and through hierarchical menus, after 5.4 Receiver appears, move the cursor to 5. Squelch.

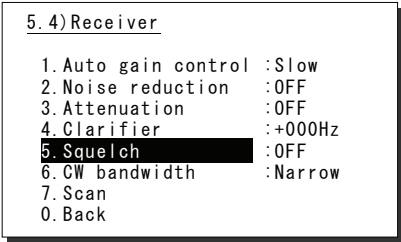

2. Press ENT to move the cursor to the right, then use the jog dial or numeric keypad to input a value in the range of 000 to 100.

After inputting and pressing ENT, the settings are complete.

- Note**
- Setting the value to 000 automatically displays it as OFF.
  - This function is disabled in DSC mode.

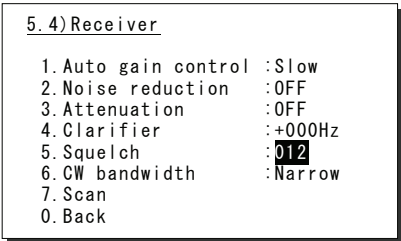

**4.3.8 Setting the CW bandwidth**

**■ Procedure ■**

1. Press the **MENU** key, and through hierarchical menus, after 5.4 Receiver appears, move the cursor to 6. CW bandwidth.

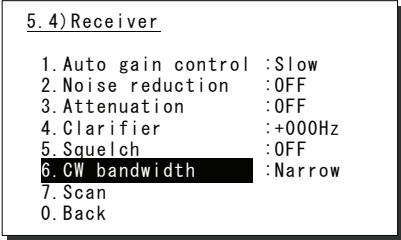

2. Press ENT to move the cursor to the right, then use the jog dial to select Wide or Narrow.

After inputting and pressing ENT, the settings are complete.

- Note**
- Setting the value to 000 automatically displays it as OFF.
  - This function is enabled in CW mode only.

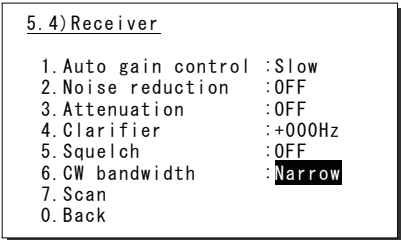

**4.3.9 Scanning the Rx frequencies**

Scanning is done for each group of user channels.

**■ Procedure ■**

1. Press the **MENU** key, and through hierarchical menus, after 5.4 Receiver appears, move the cursor to 7. Scan.

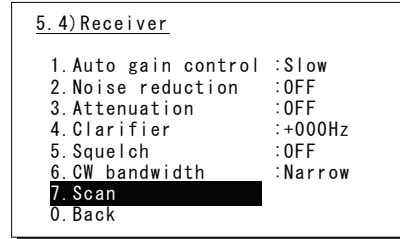

2. Press ENT to confirm the selection.

The group list as shown at right is displayed.

- Note**
- The previous scan can be restarted by pressing and holding the **FUNC** key and then pressing the **2SCAN** key on the status display.
  - If the user channel is not registered, scan cannot be done so the screen shown at right is not displayed.

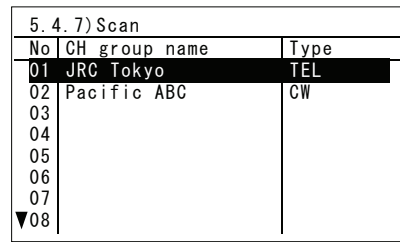

3. Select the channel group to scan with the cursor and press ENT.

The popup screen as shown at right is displayed.

- Note**
- If the popup screen shown at right is displayed during scanning, Stop appears instead of Execute.

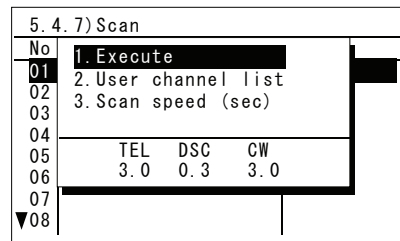

4. 1. Select Execute and press ENT, the screen at right is displayed and scanning starts.

- To confirm the channel lists registered in a channel group, select 2. User channel list and press ENT.
- To change the scanning speed, select 3. Scan speed (sec) and press ENT. The setting range is 0.3 to 9.9 seconds, the same as TEL/DSC/CW.

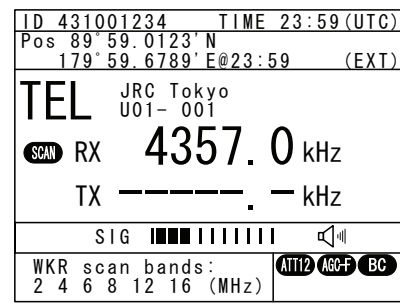

- Note**
- Scanning can be done regardless of the squelch being set to open or close. When pushing PTT or keying the CW keyer or when squelch is closed and opens, scanning stops momentarily. In this case the scanning can be restarted by pressing ENT.
  - To stop scanning, press the **CANCEL** key.
  - When scanning to receive routine DSC calls, set the scan speed to 0.3 seconds within 6 channels.  
Note: If too many channels are being scanned, it may not catch the reception.

### 4.3.10 Reducing the Tx power

#### ■ Procedure ■

1. Press the **MENU** key, and through hierarchical menus, select 5.5 Transmitter.

```
5.5)Transmitter
1. Power      :High
2. Tune power :Normal
0. Back
```

2. 1. Select Power and press ENT to move the cursor to the right, then use the jog dial to select Low.

After selecting and pressing ENT, the settings are complete.

```
5.5)Transmitter
1. Power      :Low
2. Tune power :Normal
0. Back
```

#### Note

- The same settings can be done by pressing and holding the **FUNC** key and the **9<sup>PWR</sup><sub>RDC</sub>** key at the same time.
- When the Tx power is reduced, **LOW** (status display) or **L** (menu screen) is displayed.

### 4.3.11 Setting the antenna tuning power

#### ■ Procedure ■

1. Press the **MENU** key, and through hierarchical menus, after 5.5 Transmitter appears, move the cursor to 2. Tune power.

```
5.5)Transmitter
1. Power      :High
2. Tune power :Normal
0. Back
```

2. Press ENT to move the cursor to the right, then use the jog dial to select a value from 0 to 3.

- The larger the number the stronger the antenna tuning power.
- The factory default setting is 0 (Normal).
- After selecting and pressing ENT, the settings are complete.

```
5.5)Transmitter
1. Power      :High
2. Tune power :+2
0. Back
```

## 4.4 Basic DSC operations

When calling stations, the DSC is also available for a routine, safety, urgency, or a distress call. This section explains basics of how to use the DSC to make routine calls.

### 4.4.1 Routine calls to an individual station

For radiotelephone communication, a DSC routine call to an objective station can be made as follows.

#### ■ Procedure ■

1. Press **MENU** key, and through hierarchical menus, select 1. DSC non-distress call.

```

1)DSC non-distress call
Call type :[RTN/Indv/TEL ]
Address   :[          ]
Calling FRQ:[Tx 2177.0kHz]
           :[Rx 2177.0kHz]
Working FRQ:[Tx   . kHz]
           :[Rx   . kHz]

[Call] [Preview] [Cancel]
    
```

2. Select Address and press ENT to move the cursor to the right and input the other stations 9-digit MMSI.

```

1)DSC non-distress call
Call type :[RTN/Indv/TEL ]
Address   :[0          ]
Calling FRQ:[Tx 2177.0kHz]
           :[Rx 2177.0kHz]
Working FRQ:[Tx   . kHz]
           :[Rx   . kHz]

[Call] [Preview] [Cancel]
    
```

3. To change the call frequency, select Calling FRQ and press ENT to move the cursor to the right, then input the Tx and Rx frequencies with the numeric keypad.

- Note**
- When 2 is input using the numeric keypad, it appears on the far right as shown in the screen on the right.
  - Press ENT for every setting of the Tx and Rx frequencies.

```

1)DSC non-distress call
Call type :[RTN/Indv/TEL ]
Address   :[431123456]
Calling FRQ:[Tx 2177.2kHz]
           :[Rx   . ]
Working FRQ:[Tx   . kHz]
           :[Rx   . kHz]

[Call] [Preview] [Cancel]
    
```

4. Select Working FRQ and press ENT to move the cursor to the right and input the working frequency (radiotelephone frequency) with the numeric keypad.

- Note**
- When 2 is input using the numeric keypad, it appears on the far right as shown in the screen on the right.
  - Press ENT for every setting of the Tx and Rx frequencies.

```

1)DSC non-distress call
Call type :[RTN/Indv/TEL ]
Address   :[431123456]
Calling FRQ:[Tx 2169.0kHz]
           :[Rx 2169.0kHz]
Working FRQ:[Tx 2169.2kHz]
           :[Rx   . kHz]

[Call] [Preview] [Cancel]
    
```

- When input is complete, the cursor moves to Call.

Check the settings before making routine calls.

**Note** Select Preview and press ENT before calling to display the details of the message as shown at right (bottom).

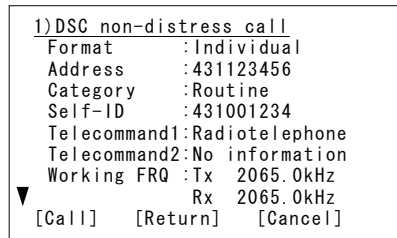
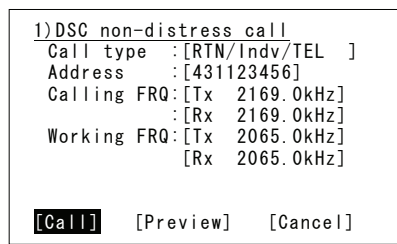

- Select Call and press ENT to start the procedure for making a routine individual call.

- The sending procedure screen as shown at right is displayed.
- After that the status is shown at Stage. Here it is checking if the channel is free.

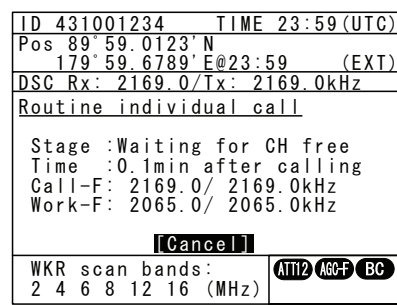

- When a free channel is confirmed, the antenna is tuned, and a DSC message is sent.

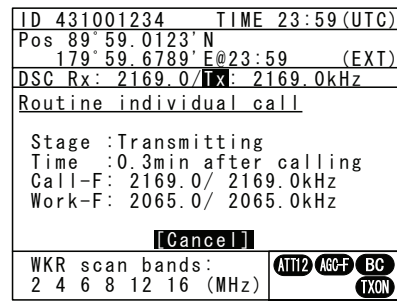

- After the DSC message is sent, wait for acknowledgement.

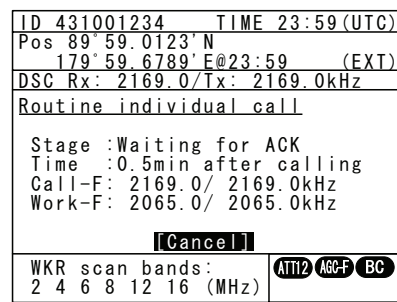

- Acknowledgement is received.

- The ALM lamp starts blinking, and the call alarm gradually grows louder.
- The radiotelephone frequency is set and the antenna is tuned automatically.

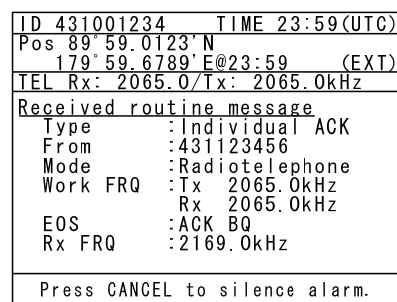

Operation

**10.** Press the **CANCEL** key or ENT.

The alarm stops and the screen shown at right is displayed.

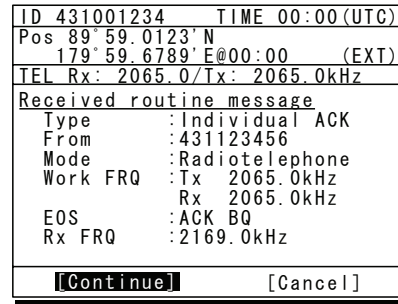

**11.** Press ENT.

The status display shown at right, with communication frequencies set, is displayed and the routine call is completed. Start communications using the handset.

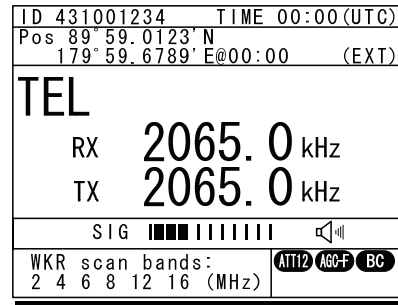

**Note** The popup screen shown at the right (bottom) appears if the antenna tuning that started in step 9 above is not finished yet.

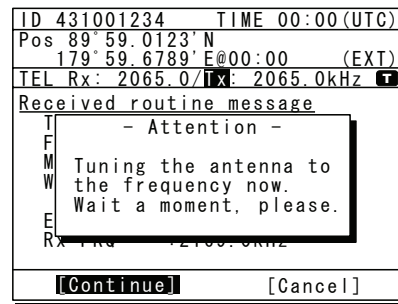

- Note**
- If the MMSI of the coast station is input at Address, the following display and functions are available.
    - The initial call frequencies are TX 2189.5 kHz and Rx 2177 kHz. Frequencies can also be selected from among international frequencies by using the numeric keypad or the jog dial. For details, see "11.3 International DSC frequencies for routine calls".
    - The working frequency is specified by the coast station so Working FRQ is not displayed.
  - If the objective station is unable to comply with the call, own station (caller) may receive one of the following acknowledgements may be received. (\* are coast stations only) In this case, wait and retry the call again later, if possible, according to the message.

No reason/ No reason.	No operator/ Operator is not present.
Congestion/ The maritime information exchange center is congested.	Temp no operator/ The operator is temporarily away.
Busy/ Busy.	EQP disabled/ The equipment has been disabled.
Queue/ The call has been queued.*	Unable FRQ/ The proposed frequency cannot be used.
Barred/ The station is closed.	Unable mode/ The proposed mode cannot be used.



**4.4.2 Routine calls to a group of ships**

For radiotelephone broadcasting, a DSC routine call to a group of ships can be made as follows.

**■ Procedure ■**

1. Press **MENU** key, and through hierarchical menus, select 1. DSC non-distress call.

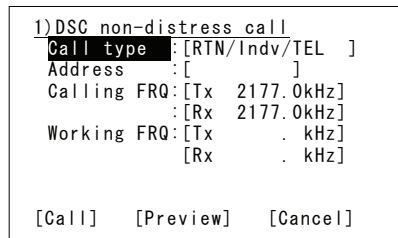

2. Select Call type and press ENT to move the cursor to the right. Then use the jog dial to select RTN/Group/TEL.

After selecting and pressing ENT, the cursor moves to Address.

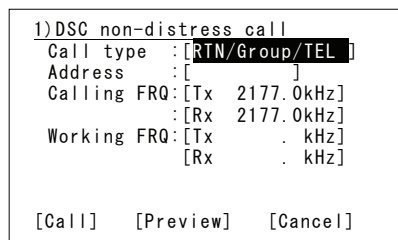

3. Select Address and press ENT to move the cursor to the right and input the group of ships' 9-digit MMSI.

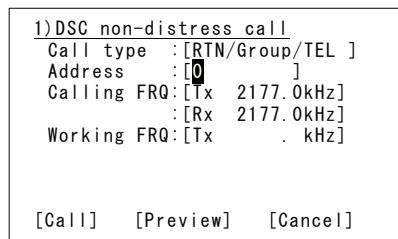

4. To change the call frequency, select Calling FRQ and press ENT to move the cursor to the right, then input the Tx and Rx frequencies with the numeric keypad.

- Note** - When 2 is input using the numeric keypad, it appears on the far right as shown in the screen on the right.
- Press ENT for every setting of the Tx and Rx frequencies.

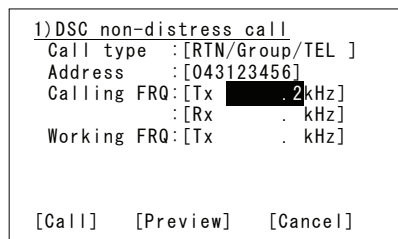

5. Select Working FRQ and press ENT to move the cursor to the right and input the working frequency (radiotelephone frequency) with the numeric keypad.

- Note** - When 2 is input using the numeric keypad, it appears on the far right as shown in the screen on the right.
- After inputting press ENT.

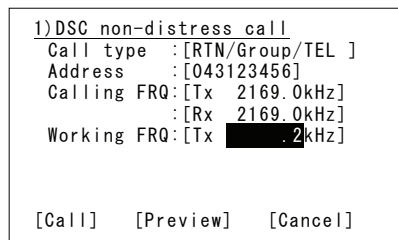

Operation

6. When input is complete, the cursor moves to Call.

Check the settings before making routine calls.

**Note** Select Preview and press ENT before calling to display the details of the message as shown at right (bottom).

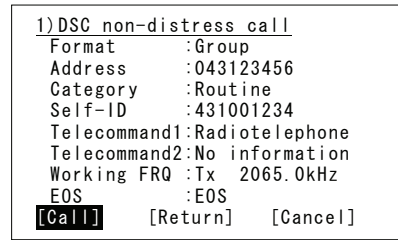
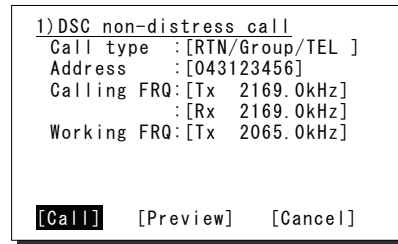

7. Select Call and press ENT to start the procedure for making a routine call.

- The sending procedure screen as shown at right is displayed.
- After that, the status is shown at Stage. Here it is checking if the channel is free.

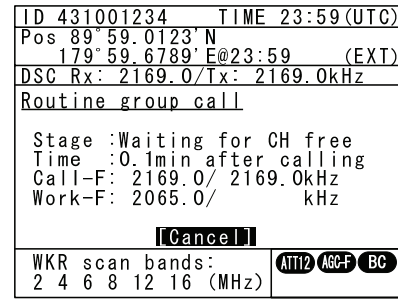

8. When a free channel is confirmed, the antenna is tuned, and a DSC message is sent.

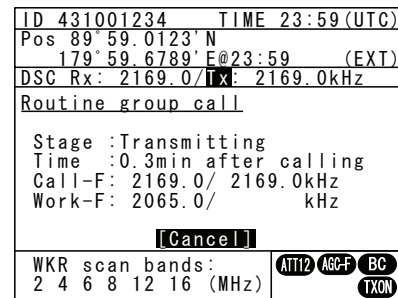

9. After sending a DSC message, immediately change the communication frequencies of the radiotelephone and tune the antenna.

When tuning is finished, the status display shown at right, with communication frequencies set, is displayed and the group call is completed. Start broadcasting using the handset.

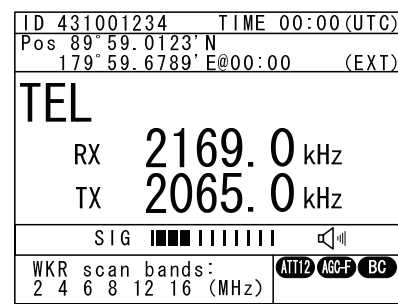

**4.4.3 Receiving routine calls**

When receiving a DSC call from a coast or ship station, the message will be displayed immediately on the screen. After that, perform the following procedures as appropriate.

**(1) Receiving an individual call (type: radiotelephone)**

**■ Procedure ■**

1. The screen at right is displayed, and the ALM lamp blinks and the alarm grows louder gradually.

The example message contains the following information.

- Message type: Individual call
- Caller's MMSI: 123456789
- Communication mode: Radiotelephone
- Work frequency: Tx 2065.0 kHz  
Rx 2065.0 kHz
- Sequence process: ACK RQ
- Receiving frequency: 2177.0 kHz

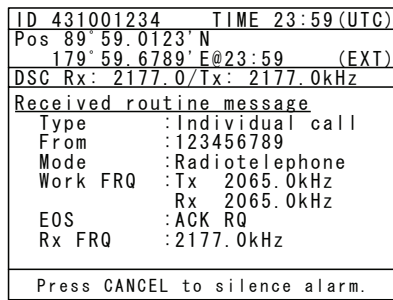

2. Press the **CANCEL** key or ENT to stop the alarm, and the screen at right is displayed.

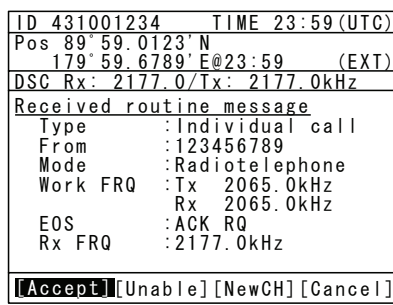

3. If the call can be accepted, select Accept and press ENT.

- The acknowledgement procedure screen as shown at right is displayed.
- After that, the status is shown at Stage. Here it is checking if the channel is free.
- See the following notes for information about the other items (Unable/NewCH/Cancel) in the handling menu.

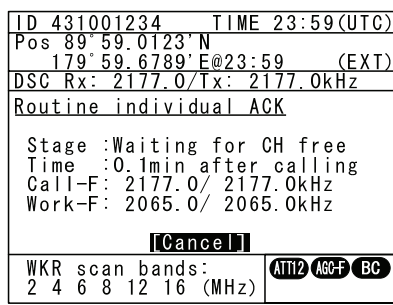

4. When a free channel is confirmed, the antenna is tuned, and an acknowledgement message is sent.

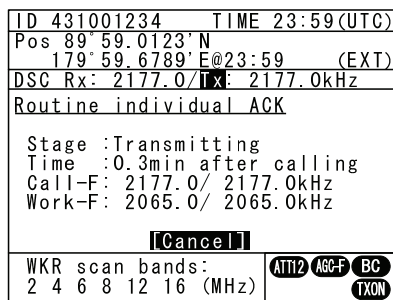

Operation

- 5. After sending an acknowledgement message, changes the working frequency and tunes the antenna.

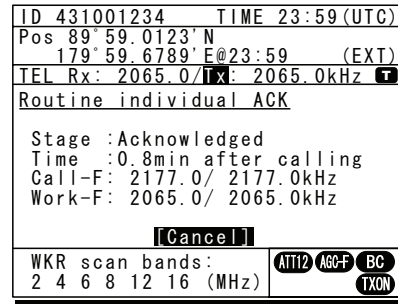

- 6. When acknowledgement is finished, the status display is displayed.

Start communications using the handset.

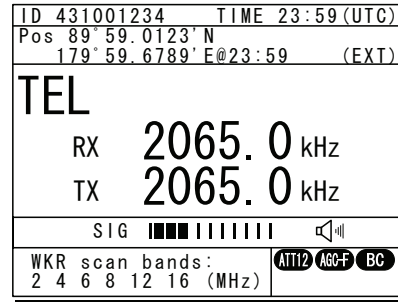

**Note**

- When Unable (unable to comply) is selected in the received message handling menu, the following popup screen opens. Select a reason to insert in the message.

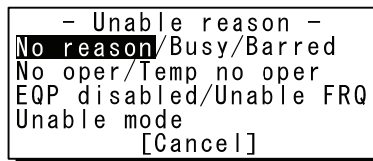

No reason/ No reason.	Temp no oper/ The operator is temporarily away.
Busy/ Busy.	EQP disabled/ The equipment has been disabled.
Barred/ The station is closed.	Unable FRQ/ The proposed frequency cannot be used.
No oper/ Operator is not present.	Unable mode/ The proposed mode cannot be used.

- When New CH (change working frequency) is selected in the received message handling menu, the following popup screen opens. Enter an appropriate working frequency.

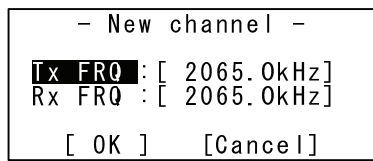

- When Cancel is selected in the received message handling menu, the previous screen reappears.

## (2) Receiving an individual call (type: polling)

### ■ Procedure ■

1. The screen at right is displayed, and the ALM lamp blinks and the alarm grows louder gradually.

The example message contains the following information.

- Message type: Individual call
- Caller's MMSI: 001234567
- Purpose of call: Polling
- Sequence process: ACK RQ
- Receiving frequency: 2177.0 kHz

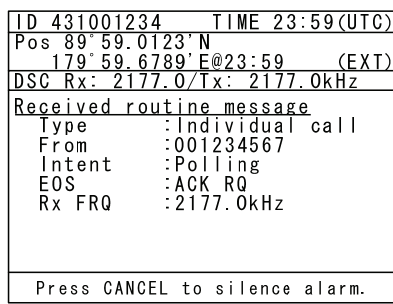

2. Press the **CANCEL** key or ENT to stop the alarm, and the screen at right is displayed.

**Note**

When the Auto ACK is set to on and the status display is displayed, the acknowledgement is automatically sent upon receiving a call, without the notification shown at right.

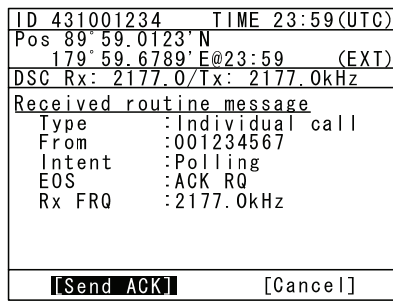

3. Select Send ACK and press ENT to send a reply message.

- The acknowledgement procedure screen as shown at right is displayed.
- After that, the status is shown at Stage. Here it is checking if the channel is free.

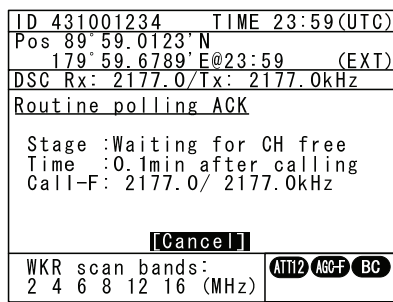

4. When a free channel is confirmed, the antennas are tuned, and an acknowledgement message is sent.

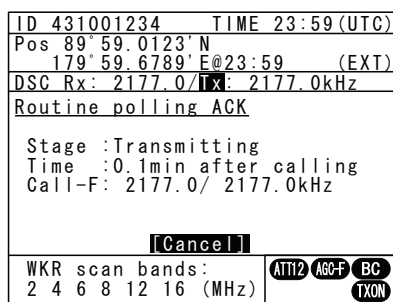

5. Once the reply message is sent, the status display is displayed.

The polling call is now complete because there is no communication using the radiotelephone.

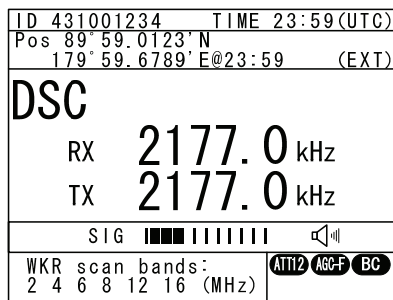

### (3) Receiving a group call

#### ■ Procedure ■

1. The screen at right is displayed, and the ALM lamp blinks and the alarm grows louder gradually.

The example message contains the following information.

- Message type: Group call
- Caller's MMSI: 123456789
- Communication mode: Radiotelephone
- Work frequency: Receiving 2065.0 kHz
- Sequence process: Response unnecessary
- Receiving frequency: 2177.0 kHz

ID 431001234	TIME 23:59(UTC)
Pos 89° 59. 0123' N	179° 59. 6789' E@23:59 (EXT)
DSC Rx: 2177. 0/Tx: 2177. 0kHz	
Received routine message	
Type	: Group call
From	: 123456789
Mode	: Radiotelephone
Work FRQ	: Rx 2065. 0kHz
EOS	: EOS
Rx FRQ	: 2177. 0kHz
Press CANCEL to silence alarm.	

2. Press the **CANCEL** key or ENT to stop the alarm, and the screen at right is displayed.

ID 431001234	TIME 23:59(UTC)
Pos 89° 59. 0123' N	179° 59. 6789' E@23:59 (EXT)
DSC Rx: 2177. 0/Tx: 2177. 0kHz	
Received routine message	
Type	: Group call
From	: 123456789
Mode	: Radiotelephone
Work FRQ	: Rx 2065. 0kHz
EOS	: EOS
Rx FRQ	: 2177. 0kHz
[Accept]	[Cancel]

3. If possible to listen to the broadcast, select Accept and press ENT to set the working channel.

ID 431001234	TIME 23:59(UTC)
Pos 89° 59. 0123' N	179° 59. 6789' E@23:59 (EXT)
TEL	
RX	2065. 0 kHz
TX	2177. 0 kHz
SIG ■■■■■■■■■■	
WKR scan bands:	ATT12 AGC-F BC
2 4 6 8 12 16 (MHz)	

## 4.5 Emergency calls (DSC safety/urgency/distress calls)

In emergency, the DSC is available for safety, urgency, or distress calls. For safety and urgency calls, either individual calls or area calls is selectable for the type of call. For distress calls, enabled to send either after entering the nature of distress or frequency, or without entering anything. In both cases, pressing the **DISTRESS** key is required to send the distress call.

### 4.5.1 Safety calls

#### 4.5.1.1 Individual calls

For radiotelephone communication, a DSC safety call to an objective station can be made as follows.

■ **Procedure** ■

1. Press **MENU** key, and through hierarchical menus, select 1. DSC non-distress call.

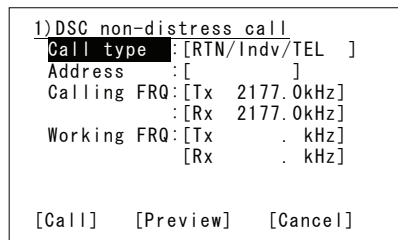

2. Select Call type and press ENT to move the cursor to the right. Then use the jog dial to select SAF/Indv/TEL.

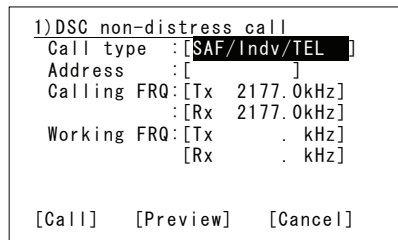

3. Press ENT.  
 The text displayed in Calling FRQ and Working FRQ changes as shown to the right, and the cursor moves to Address.

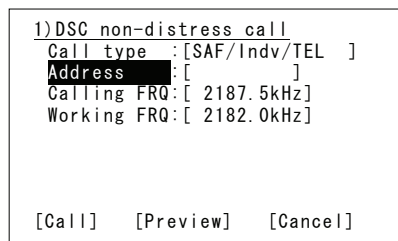

4. Select Address and press ENT to move the cursor to the right and input the other stations 9-digit MMSI.

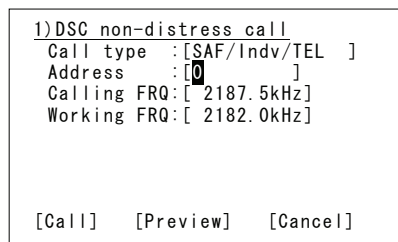

## Operation

- 5.** To change the call frequency, select Calling FRQ and press ENT to move the cursor to the right. Then select the distress and safety frequencies using the jog dial.

**Note**

- The numeric keypad can also be used.
- For information on distress and safety calls, See "11.1 Frequencies for distress and safety calls".

```

1)DSC non-distress call
Call type  :[SAF/Indv/TEL ]
Address    :[431123456]
Calling FRQ:[ 4207.5kHz]
Working FRQ:[ 2182.0kHz]

[Call]  [Preview]  [Cancel]
    
```

- 6.** Press ENT.

The work frequency of the same band as the input Calling FRQ is automatically set in Working FRQ and the cursor moves to Working FRQ.

```

1)DSC non-distress call
Call type  :[SAF/Indv/TEL ]
Address    :[431123456]
Calling FRQ:[ 4207.5kHz]
Working FRQ:[ 4125.0kHz]

[Call]  [Preview]  [Cancel]
    
```

- 7.** Move the cursor to Call and press ENT to start the procedure for making an individual safety call.

- The sending procedure screen as shown at right is displayed.
- After that, the status is shown at Stage. DSC messages are sent immediately upon antenna tuning because a free channel (excluding test calls) is not confirmed for a safety category.

```

ID 431001234    TIME 23:59(UTC)
Pos 89°59.0123'N
   179°59.6789'E@23:59    (EXT)
DSC Rx: 4207.5/Tx: 4207.5kHz
Safety individual call

Stage :Transmitting
Time  :0.3min after calling
Call-F: 4207.5/ 4207.5kHz
Work-F: 4125.0/ 4125.0kHz

[Cancel]

WKR scan bands:  [ATT12] [AGC-F] [BC]
2 4 6 8 12 16 (MHz) [TXON]
    
```

**Note**

The following procedure is the same as in "4.4.1 Routine calls to an individual station".



### 4.5.1.2 Area calls

For radiotelephone broadcasting, a DSC safety area call can be made as follows.

#### ■ Procedure ■

1. Press **MENU** key, and through hierarchical menus, select 1. DSC non-distress call.

```

1)DSC non-distress call
Call type : [RTN/Indv/TEL ]
Address   : [          ]
Calling FRQ: [Tx 2177.0kHz]
           : [Rx 2177.0kHz]
Working FRQ: [Tx      . kHz]
           : [Rx      . kHz]

[Call] [Preview] [Cancel]
    
```

2. Select Call type and press ENT to move the cursor to the right. Then use the jog dial to select SAF/Area/TEL.

```

1)DSC non-distress call
Call type : [SAF/Area/TEL ]
Address   : [          ]
Calling FRQ: [Tx 2177.0kHz]
           : [Rx 2177.0kHz]
Working FRQ: [Tx      . kHz]
           : [Rx      . kHz]

[Call] [Preview] [Cancel]
    
```

3. Press ENT.

The display changes as shown to the right and the cursor moves to Area form.

```

1)DSC non-distress call
Call type : [SAF/Area/TEL ]
Area form : [Center&rad]
- Center  : [89° N179° E]
- Radius  : [0500NM]
Calling FRQ: [ 2187.5kHz]
Working FRQ: [ 2182.0kHz]

[Call] [Preview] [Cancel]
    
```

4. Set the area to call.

Enter as below according to the Area form settings.

- When Center&rad
  - Enter the center point of the area in Center.
  - Enter the radius of the area in Radius.
- When Corner&dev (shown at right)
  - Enter the northwest corner of the area in Corner.
  - Enter the south and north/east and west deviation in a range from 00 to 99 in Deviation.

```

1)DSC non-distress call
Call type : [SAF/Area/TEL ]
Area form : [Corner&dev]
- Corner  : [ ° N ° E]
- Deviation: [ ° / °]
Calling FRQ: [ 2187.5kHz]
Working FRQ: [ 2182.0kHz]

[Call] [Preview] [Cancel]
    
```

5. To change the call frequency, select Calling FRQ and press ENT to move the cursor to the right. Then select the distress and safety frequencies using the jog dial.

- Note**
- The numeric keypad can also be used.
  - For information on distress and safety calls, See "11.1 Frequencies for distress and safety calls".

```

1)DSC non-distress call
Call type : [SAF/Area/TEL ]
Area form : [Center&rad]
- Center  : [89° N179° E]
- Radius  : [0500NM]
Calling FRQ: [ 4207.5kHz]
Working FRQ: [ 2182.0kHz]

[Call] [Preview] [Cancel]
    
```

Operation

**6.** Press ENT.

The work frequency of the same band as the input Calling FRQ is automatically set in Working FRQ and the cursor moves to Working FRQ.

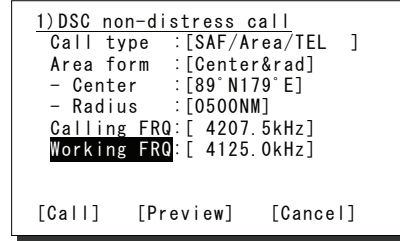

**7.** Move the cursor to Call and press ENT to start the procedure for making an area safety call.

- The sending procedure screen as shown at right is displayed.
- After that, the status is shown at Stage. DSC messages are sent immediately upon antenna tuning because a free channel (excluding test calls) is not confirmed for a safety category.

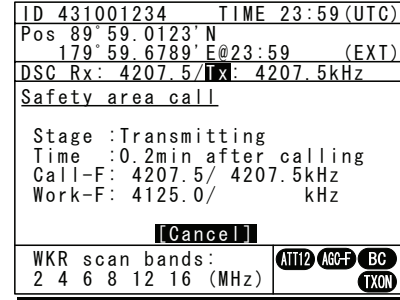

**8.** After sending a DSC message, immediately change the communication frequencies of the radiotelephone and tune the antennas.

Once tuning is complete, the status display shown at right is displayed with communication frequencies set and the area call is completed. Start broadcasting using the handset.

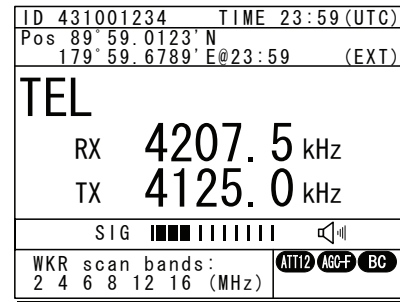

### 4.5.1.3 Other features of safety calls (position request/test)

Use safety calls to request position information to stations and to make DSC test calls.

#### (1) Position request call

##### ■ Procedure ■

1. Press **MENU** key, and through hierarchical menus, select 1. DSC non-distress call.

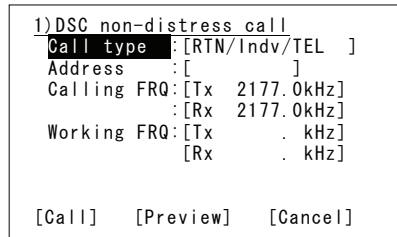

2. Select Call type and press ENT to move the cursor to the right. Then use the jog dial to select SAF/Indv/PosRQ.

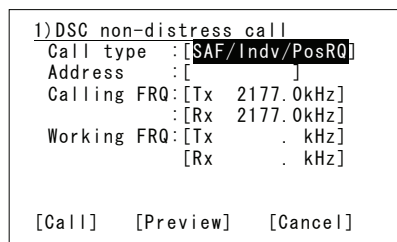

3. Press ENT.  
 The display changes as shown to the right and the cursor moves to Address.

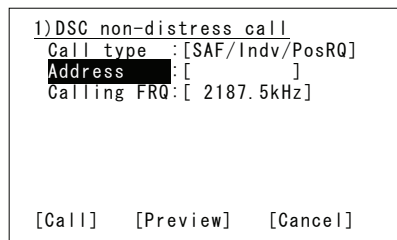

4. Select Address and press ENT to move the cursor to the right and input the other stations 9-digit MMSI.

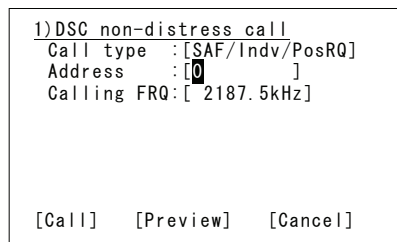

5. To change the call frequency, select Calling FRQ and press ENT to move the cursor to the right. Then select the distress and safety frequencies using the jog dial and press ENT.

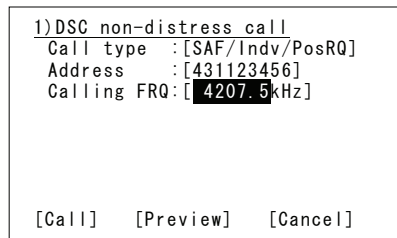

- Note**
- The numeric keypad can also be used.
  - For information on distress and safety calls, See "11.1 Frequencies for distress and safety calls".
  - After input is complete, check the details of the message before sending it using Preview.

## Operation

6. Select Call and press ENT to start the procedure for making a position request call.

- The sending procedure screen as shown at right is displayed.
- After that, the status is shown at Stage. DSC messages are sent immediately upon antenna tuning because a free channel (excluding test calls) is not confirmed for a safety category.

ID 431001234	TIME 23:59(UTC)
Pos 89°59.0123'N	
179°59.6789'E@23:59	(EXT)
DSC Rx: 4207.5/Tx: 4207.5kHz	
Safety position request call	
Stage :Transmitting	
Time :0.1min after calling	
Call-F: 4207.5/ 4207.5kHz	
<b>[Cancel]</b>	
WKR scan bands:	<b>ATT12</b> <b>AGC-F</b> <b>BC</b>
2 4 6 8 12 16 (MHz)	<b>TXON</b>

7. After the DSC message is sent, wait for acknowledgement.

ID 431001234	TIME 23:59(UTC)
Pos 89°59.0123'N	
179°59.6789'E@23:59	(EXT)
DSC Rx: 4207.5/Tx: 4207.5kHz	
Safety position request call	
Stage :Waiting for ACK	
Time :0.5min after calling	
Call-F: 4207.5/ 4207.5kHz	
<b>[Cancel]</b>	
WKR scan bands:	<b>ATT12</b> <b>AGC-F</b> <b>BC</b>
2 4 6 8 12 16 (MHz)	

8. When a reply is received, a message, like the one at right, with the position information of the other station is displayed.

- The ALM lamp starts blinking, and the call alarm gradually grows louder.
- Press either the **CANCEL** key or ENT to silence the alarm and display Close. After checking the position of the other station in the reply message, press ENT in Close to show the status display.
- The position request process is now complete because there is no communication using the radiotelephone.

ID 431001234	TIME 23:59(UTC)
Pos 89°59.0123'N	
179°59.6789'E@23:59	(EXT)
DSC Rx: 4207.5/Tx: 4207.5kHz	
Received safety message	
Type	: Individual ACK
From	: 431123456
Intent	: Ship position
Position	: 90°00'N
	: 180°00'E
UTC of pos:	: 12:34
EOS	: ACK BQ
Rx FRQ	: 4207.5kHz
Press CANCEL to silence alarm.	

### Note

Even if the equipment is functioning properly, Unknown may be displayed for the time and position depending on the condition of the station, and replies may be not be received depending on the status of radio wave propagation.

## (2) Test call

### ■ Procedure ■

1. Press **MENU** key, and through hierarchical menus, select 1. DSC non-distress call.

```

1)DSC non-distress call
Call type : [RTN/Indv/TEL ]
Address   : [          ]
Calling FRQ: [Tx  2177.0kHz]
           : [Rx  2177.0kHz]
Working FRQ: [Tx    . kHz]
           : [Rx    . kHz]

[Call]  [Preview]  [Cancel]
    
```

2. Select Call type and press ENT to move the cursor to the right. Then use the jog dial to select SAF/Indv/Test.

```

1)DSC non-distress call
Call type : [SAF/Indv/Test ]
Address   : [          ]
Calling FRQ: [Tx  2177.0kHz]
           : [Rx  2177.0kHz]
Working FRQ: [Tx    . kHz]
           : [Rx    . kHz]

[Call]  [Preview]  [Cancel]
    
```

3. Press ENT.

The display changes as shown to the right and the cursor moves to Address.

```

1)DSC non-distress call
Call type : [SAF/Indv/Test ]
Address   : [          ]
Calling FRQ: [ 2187.5kHz]

[Call]  [Preview]  [Cancel]
    
```

4. Select Address and press ENT to move the cursor to the right and input the other stations 9-digit MMSI.

```

1)DSC non-distress call
Call type : [SAF/Indv/Test ]
Address   : [0          ]
Calling FRQ: [ 2187.5kHz]

[Call]  [Preview]  [Cancel]
    
```

5. To change the call frequency, select Calling FRQ and press ENT to move the cursor to the right. Then select the distress and safety frequencies using the jog dial and press ENT.

```

1)DSC non-distress call
Call type : [SAF/Indv/Test ]
Address   : [431123456]
Calling FRQ: [ 4207.5kHz]

[Call]  [Preview]  [Cancel]
    
```

- Note**
- The numeric keypad can also be used.
  - For information on distress and safety calls, See "11.1 Frequencies for distress and safety calls".
  - After input is complete, check the details of the message before sending it using Preview.

Operation

6. Select Call and press ENT to start the procedure for making a test call.

- The sending procedure screen as shown at right is displayed.
- After that, the status is shown at Stage. Here it is checking if the channel is free.

ID 431001234	TIME 23:59 (UTC)
Pos 89°59.0123' N	179°59.6789' E@23:59 (EXT)
DSC Rx: 4207.5/Tx: 4207.5kHz	
Safety test call	
Stage :Waiting for CH free Time :0.1min after calling Call-F: 4207.5/ 4207.5kHz	
<b>[Cancel]</b>	
WKR scan bands: 2 4 6 8 12 16 (MHz)	<b>[ATT12] [AGG-F] [BC]</b>

7. When a free channel is confirmed, the antennas are tuned, and a DSC message is sent.

ID 431001234	TIME 23:59 (UTC)
Pos 89°59.0123' N	179°59.6789' E@23:59 (EXT)
DSC Rx: 4207.5/Tx: 4207.5kHz	
Safety test call	
Stage :Transmitting Time :0.3min after calling Call-F: 4207.5/ 4207.5kHz	
<b>[Cancel]</b>	
WKR scan bands: 2 4 6 8 12 16 (MHz)	<b>[ATT12] [AGG-F] [BC]</b> <b>[TXON]</b>

8. After the DSC message is sent, wait for acknowledgement.

ID 431001234	TIME 23:59 (UTC)
Pos 89°59.0123' N	179°59.6789' E@23:59 (EXT)
DSC Rx: 4207.5/Tx: 4207.5kHz	
Safety test call	
Stage :Waiting for ACK Time :0.5min after calling Call-F: 4207.5/ 4207.5kHz	
<b>[Cancel]</b>	
WKR scan bands: 2 4 6 8 12 16 (MHz)	<b>[ATT12] [AGG-F] [BC]</b>

9. When a reply is received, the reply message is displayed as shown at the right.

- The ALM lamp starts blinking, and the call alarm gradually grows louder.
- Press either the **[CANCEL]** key or ENT to silence the alarm and display Close. Press ENT to display the status display.
- The test call process is now complete because there is no communication using the radiotelephone.

ID 431001234	TIME 23:59 (UTC)
Pos 89°59.0123' N	179°59.6789' E@23:59 (EXT)
DSC Rx: 4207.5/Tx: 4207.5kHz	
Received safety message	
Type	: Individual ACK
From	: 123456789
Intent	: Test
EOS	: ACK BQ
Rx FRQ	: 4207.5kHz
Press CANCEL to silence alarm.	

- Note**
- Press the **[O TEST CALL]** key while holding the **[FUNC]** key to start from 3 above.
  - According to the condition of the station and the radio wave propagation conditions, the acknowledgement may not be received even if the equipment works normally.

### 4.5.1.4 Receiving safety calls

When receiving a safety call from a coast station or another ship station, the message is displayed immediately. Then treat the message according to the type as below.

#### (1) Receiving an individual call (Type: Radiotelephone)

This procedure is identical to the case of a routine call. However the screen shown at right will be displayed with the alarm.

The example message contains the following information.

- Message type: Individual call
- Caller's MMSI: 123456789
- Communication mode: Radiotelephone
- Work frequency: Tx 4125.0 kHz  
Rx 4125.0 kHz
- Sequence process: ACK RQ
- Receiving frequency: 4207.5 kHz

ID 431001234	TIME 23:59(UTC)
Pos 89° 59.0123' N	179° 59.6789' E@23:59 (EXT)
TEL Rx: 2065.0/Tx: 2065.0kHz	
Received safety message	
Type	: Individual call
From	: 123456789
Mode	: Radiotelephone
Work FRQ	: Tx 4125.0kHz
	: Rx 4125.0kHz
EOS	: ACK RQ
Rx FRQ	: 4207.5kHz
Press CANCEL to silence alarm.	

#### (2) Receiving an individual call (Type: Position request)

##### ■ Procedure ■

1. The screen at right is displayed, and the ALM lamp blinks and the alarm grows louder gradually.

The example message contains the following information.

- Message type: Individual call
- Caller's MMSI: 123456789
- Purpose of call: Position request
- Sequence process: ACK RQ
- Receiving frequency: 16804.5 kHz

ID 431001234	TIME 23:59(UTC)
Pos 89° 59.0123' N	179° 59.6789' E@23:59 (EXT)
TEL Rx: 4125.0/Tx: 4125.0kHz	
Received safety message	
Type	: Individual call
From	: 123456789
Intent	: Position RQ
EOS	: ACK RQ
Rx FRQ	: 16804.5kHz
Press CANCEL to silence alarm.	

2. Press the **CANCEL** key or ENT to stop the alarm, and the screen at right is displayed.

**Note** When the Auto ACK is set to on and the status display is displayed, the acknowledgement is automatically sent upon receiving a call, without the notification shown at right.

ID 431001234	TIME 23:59(UTC)
Pos 89° 59.0123' N	179° 59.6789' E@23:59 (EXT)
TEL Rx: 4125.0/Tx: 4125.0kHz	
Received safety message	
Type	: Individual call
From	: 123456789
Intent	: Position RQ
EOS	: ACK RQ
Rx FRQ	: 16804.5kHz
[Send ACK]	[Cancel]

Operation

3. Select Send ACK and press ENT to send a reply message.

- The acknowledgement procedure screen as shown at right is displayed.
- After that, the status is shown at Stage. DSC messages are sent immediately upon antenna tuning because a free channel (excluding test calls) is not confirmed for a safety category.

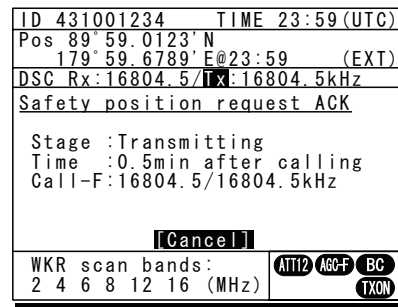

4. Once the acknowledgement is sent, the status display is displayed.

The position request process is now complete because there is no communication using the radiotelephone.

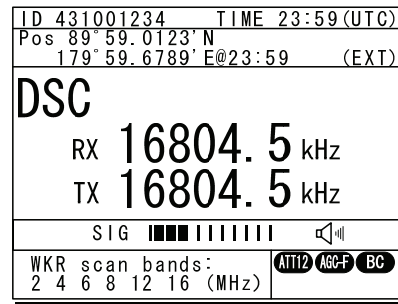

**Note**

If there is no position information (GPS is not connected or 23.5 hours have elapsed since manual input) when pressing ENT with Send ACK selected, enter the appropriate information on the following position and the time input screen that appears.

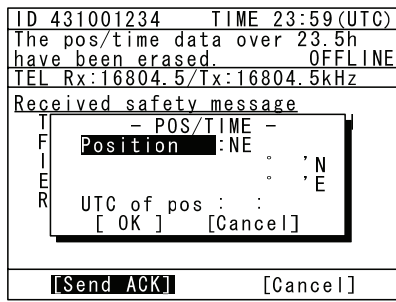

**(3) Receiving an individual call (Type: Test)**

This procedure is the same as making a routine polling call. However the screen shown at right will be displayed with the alarm.

The example message contains the following information.

- Message type: Individual call
- Caller's MMSI: 123456789
- Purpose of call: Test
- Sequence process: ACK RQ
- Receiving frequency: 16804.5 kHz

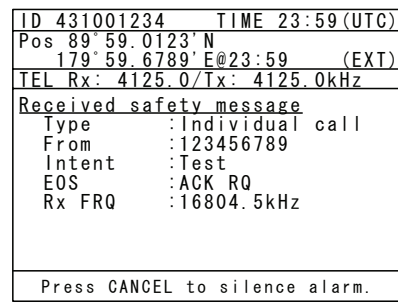



#### (4) Receiving an Area Call

This procedure is the same as making a routine category group call.

However the screen shown at right will be displayed with the alarm.

The example message contains the following information.

- Message type: Area call
- Call area: North latitude  
80 to 90 degrees  
East longitude  
170 to 180 degrees
- Caller's MMSI: 431022222
- Communication mode: Radiotelephone
- Work frequency: Rx 2182.0 kHz
- Sequence process: End of sequence
- Receiving frequency: 2187.5 kHz

ID 431001234	TIME 23:59 (UTC)
Pos 89° 59.0123' N	
179° 59.6789' E@23:59	(EXT)
TEL Rx: 2065.0/Tx: 2065.0kHz	
<u>Received safety message</u>	
Type	:GEO area call
To	:80° N-90° N/ 170° E-180° E
From	:431022222
Mode	:Radiotelephone
Work FRQ	:Rx 2182.0kHz
EOS	:EOS
Rx FRQ	:2187.5kHz
Press CANCEL to silence alarm.	

**4.5.2 Urgency calls**

**4.5.2.1 Individual calls**

For radiotelephone communication, a DSC urgency call to an objective station can be made as follows.

**■ Procedure ■**

**1.** Press **MENU** key, and through hierarchical menus, select 1. DSC non-distress call.

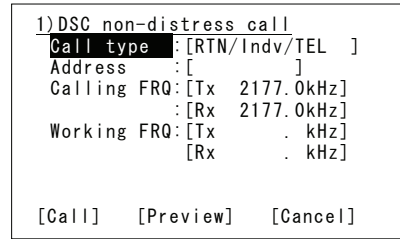

**2.** Select Call type and press ENT to move the cursor to the right. Then use the jog dial to select URG/Indv/TEL.

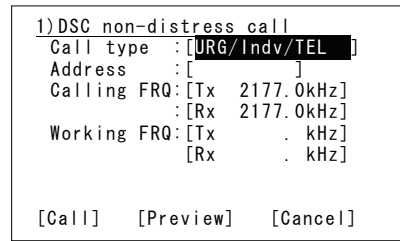

**3.** Press ENT.

The text displayed in Calling FRQ and Working FRQ changes as shown to the right, and the cursor moves to Address.

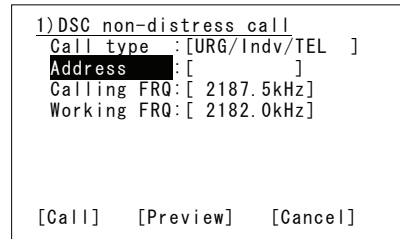

**Note** The following procedure is the same as for safety calls in "4.5.1.1 Individual calls".

### 4.5.2.2 Area calls

For radiotelephone broadcasting, a DSC urgency area call can be made as follows.

#### ■ Procedure ■

1. Press **MENU** key, and through hierarchical menus, select 1. DSC non-distress call.

```

1)DSC non-distress call
Call type : [RTN/Indv/TEL ]
Address   : [                ]
Calling FRQ: [Tx 2177.0kHz]
           : [Rx 2177.0kHz]
Working FRQ: [Tx      . kHz]
           : [Rx      . kHz]

[Call] [Preview] [Cancel]
    
```

2. Select Call type and press ENT to move the cursor to the right. Then use the jog dial to select URG/Area/TEL.

```

1)DSC non-distress call
Call type : [URG/Area/TEL ]
Address   : [                ]
Calling FRQ: [Tx 2177.0kHz]
           : [Rx 2177.0kHz]
Working FRQ: [Tx      . kHz]
           : [Rx      . kHz]

[Call] [Preview] [Cancel]
    
```

3. Press ENT.

The display changes as shown to the right and the cursor moves to Area form.

```

1)DSC non-distress call
Call type : [URG/Area/TEL ]
Area form : [Center&rad]
- Center  : [89° N179° E]
- Radius  : [0500NM]
Subject   : [No information]
Calling FRQ: [ 2187.5kHz]
Working FRQ: [ 2182.0kHz]

[Call] [Preview] [Cancel]
    
```

4. Set the area to call.

Enter as below according to the Area form settings.

- When Center&rad
  - Enter the center point of the area in Center.
  - Enter the radius of the area in Radius.
- When Corner&dev (shown at right)
  - Enter the northwest corner of the area in Corner.
  - Enter the south and north/east and west deviation in a range from 0 to 99 in Deviation.

```

1)DSC non-distress call
Call type : [URG/Area/TEL ]
Area form : [Corner&dev]
- Corner  : [ ° N ° E]
- Deviation: [ ° / °]
Subject   : [No information]
Calling FRQ: [ 2187.5kHz]
Working FRQ: [ 2182.0kHz]

[Call] [Preview] [Cancel]
    
```

5. After the area is input, the cursor moves to Subject.

If necessary, set the subject as Medical TRNSP (medical transport ship) or Neutral ship (neutral nationality).

**Note** It is fixed at No information when the power is turned on. For details, see "4.5.2.3 Special calls (medical transport/neutral ship)".

```

1)DSC non-distress call
Call type : [URG/Area/TEL ]
Area form : [Center&rad]
- Center  : [89° N179° E]
- Radius  : [0500NM]
Subject   : [No information]
Calling FRQ: [ 2187.5kHz]
Working FRQ: [ 2182.0kHz]

[Call] [Preview] [Cancel]
    
```

Operation

6. To change the call frequency, select Calling FRQ and press ENT to move the cursor to the right. Then select the distress and safety frequencies using the jog dial.

- Note**
- The numeric keypad can also be used.
  - For information on distress and safety calls, See "11.1 Frequencies for distress and safety calls".

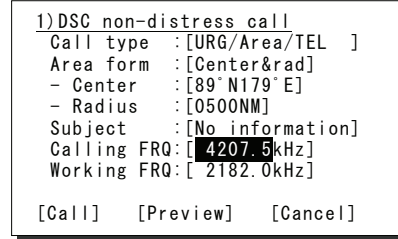

7. Press ENT.

The work frequency of the same band as the input Calling FRQ is automatically set in Working FRQ and the cursor moves to Working FRQ.

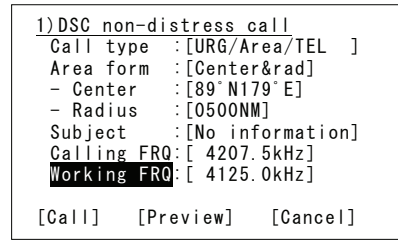

8. Move the cursor to Call and press ENT to start the procedure for making an urgency call.

- The sending procedure screen as shown at right is displayed.
- After that, the status is shown at Stage. DSC messages are sent immediately upon antenna tuning because a free channel is not confirmed for the urgency safety category.

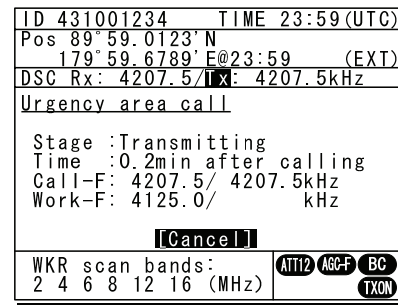

9. After sending a DSC message, immediately change the communication frequencies of the radiotelephone and tune the antennas.

Once tuning is complete, the status display shown at right is displayed with communication frequencies set and the area call is completed. Start broadcasting using the handset.

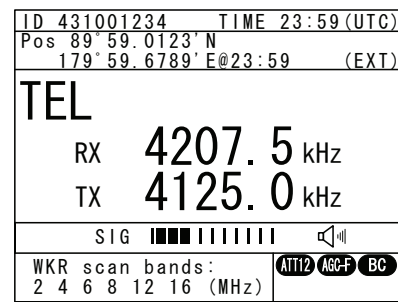

### 4.5.2.3 Special calls (medical transport/neutral ship)

When sailing dangerous waters such as in areas of political instability, additional information can be added to urgency calls made to all ships in the area if any of the following apply.

- Own ship is performing medical transportation and protected under the 1949 Geneva Convention.
- Own ship is of neutral nationality in accordance with ITU resolution 18 (Mob-83).

#### ■ Procedure ■

1. Set 7.5.4 Medical/Neutral use to ON, before this call operation.

**Note** - This setting is always reset to the default value (OFF) after turning the power off and on.  
 - These calls can always be received regardless of the settings.

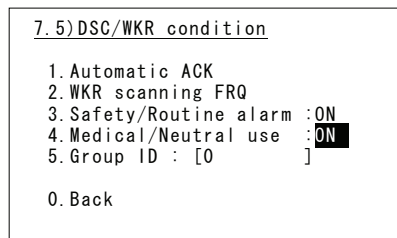

2. Make the urgency area call as described in "4.5.2.2 Area calls."

**Note** The subject items can be edited according to these settings.

### 4.5.2.4 Receiving urgency calls

When receiving an urgency call from a coast or another ship station, the message is displayed immediately with the specific alarm for urgency calls, and treat the message appropriately. Note that the two tone alarm is applied for urgency calls and differs from routine and safety call alarms.

#### (1) Receiving an Individual Call

#### ■ Procedure ■

This procedure is the same for routine and safety calls. However, the screen shown at right is displayed with the alarm.

The example message contains the following information.

- Message type: Individual call
- Caller's MMSI: 123456789
- Communication mode: Radiotelephone
- Work frequency: Tx 4125.0 kHz  
Rx 4125.0 kHz
- Sequence process: ACK RQ
- Receiving frequency: 4207.5 kHz

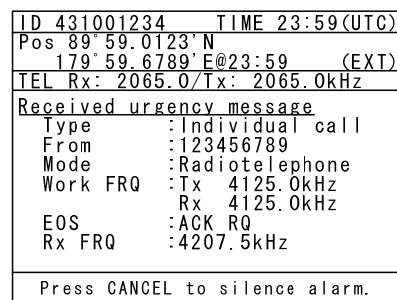

## (2) Receiving an Area Call

---

### ■ Procedure ■

This procedure is the same as receiving a safety area call.

However, the screen shown at right is displayed with the alarm.

The example message contains the following information.

- Message type: Area call
- Call area: North latitude  
80 to 90 degrees  
East longitude  
170 to 180 degrees
- Caller's MMSI: 431022222
- Communication mode: Radiotelephone
- Work frequency: Receiving  
2182.0 kHz
- Sequence process: Response  
unnecessary
- Receiving frequency: 2187.5 kHz

ID 431001234	TIME 23:59(UTC)
Pos 89°59.0123'N	
179°59.6789'E@23:59	(EXT)
TEL Rx: 2065.0/Tx: 2065.0kHz	
Received urgency message	
Type	:GEO area call
To	:80°N-90°N/ 170°E-180°E
From	:431022222
Mode	:Radiotelephone
Work FRQ	:Rx 2182.0kHz
EOS	:EOS
Rx FRQ	:2187.5kHz
Press CANCEL to silence alarm.	

**Note**

If receiving a call containing information regarding a medical transport or neutral ship, the message shows it as the "Subject".

**4.5.3 Distress calls**

When in distress, distress calls are always transmitted by pressing the dedicated **DISTRESS** key. The distress calls transmit your own MMSI, ships position, time of the position, and the nature of distress.



## CAUTION



Do not test the distress call.  
Doing so may inconvenience local shipping and rescue centers.



When sending a distress call, follow the instructions of the ship's captain or officer in charge.



If a false distress call is transmitted accidentally, follow the instructions below:

1. Press the **CANCEL** key on the controller (when appropriate, follow the commands on screen) and terminate the transmission of the distress call.
2. Report the false distress call to a nearby RCC (Rescue Coordination Center).  
(In Japan, inform the nearest Japan Coast Guard.)

Information to be reported:

The date/time, location, and reason why the false distress call was transmitted. Also report the ship's name, type, nationality, ID number as well as the unit model name and manufacture number/date, if possible.

3. Report the false distress call to nearby ships using 2182.0 kHz or another frequency for distress and safety purposes on the radiotelephone.
4. If any acknowledgements to the distress call are received, inform the ships of the false distress call.

**4.5.3.1 Quick distress calls**

The following describes the procedure to send a distress call immediately without using menus. In this case, the nature of distress in the message will be sent as "Undesignated" by default. Further, if no information for the position and the time of position obtained within 23.5 hours, this information will be composed automatically.

■ **Procedure** ■

1. Open the **DISTRESS** key cover.



## Operation

- Press and hold the **DISTRESS** key for 4 seconds until the countdown is completed.

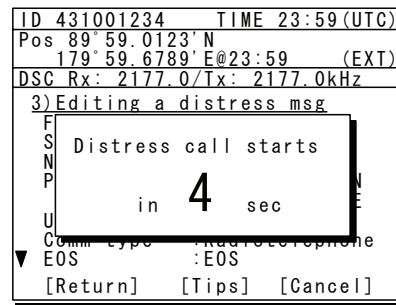

- After the antenna is tuned, the distress call is sent.

In this case, the distress call is sent on all distress and safety frequencies. The distress message is sent within 1 minute.

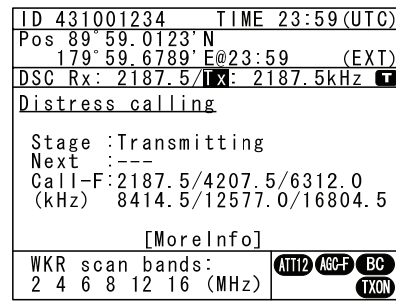

- The equipment stays in distress mode until acknowledgement is received.

- Unless an acknowledgement is received or the distress call is cancelled manually, the distress call repeats automatically in a variable interval every 3.5 to 4.5 minutes. (The time until the next broadcast is shown at Next.)
- Press ENT in the screen displayed at right to show the content of the message being sent.
- The distress call can be sent manually while waiting for acknowledgement by the **DISTRESS** key operation mentioned above.
- The radiotelephone can be used for communication while waiting for acknowledgement. The distress/safety frequencies for the radiotelephone can be changed by turning the jog dial.

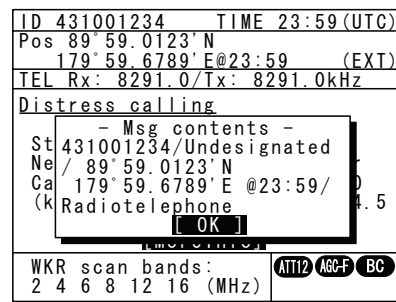
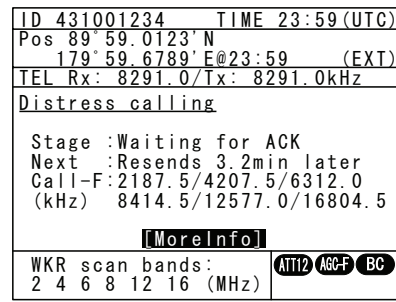

- When the acknowledgement is received, the message is displayed as shown at the right.

- The ALM lamp starts blinking, and the call alarm gradually grows louder.
- The radiotelephone mode is set to the distress/safety frequency of the band on which the acknowledgement is received and antenna tuning is done immediately.

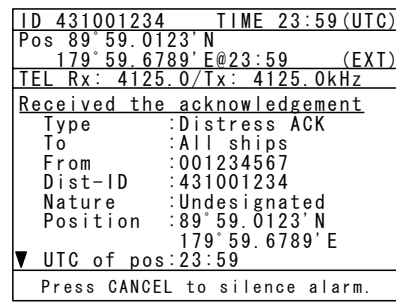



6. Press the **CANCEL** key or ENT.
- Continue is displayed after the alarm stops.
  - Turn the jog dial to scroll the received message. When the last line of the message is reached the cursor moves to Continue.

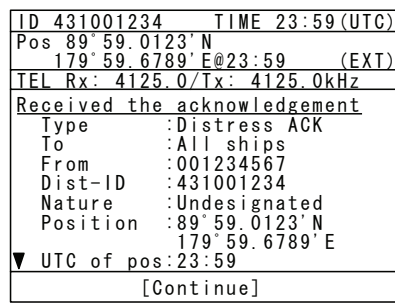

7. Pressing ENT while the cursor is on Continue displays the status display. Use the radiotelephone's handset to call for help.

Normally, the responding station calls on the radiotelephone. Then reply to the receipt as follows.

- Say, "MAYDAY".
- Say, "This is".
- Own ship's MMSI and call sign, position, nature of distress, and rescue requests

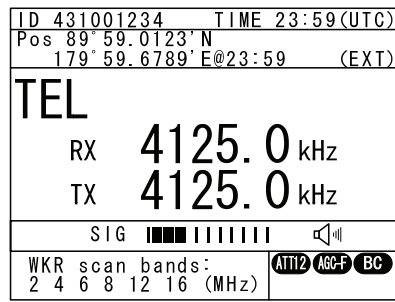

**Note** The following popup screens are displayed as appropriate in distress mode.

Popup message	Contents	Note
Attention / Resending the distress call soon...	Notifies that the distress call will be resent automatically within 12 seconds.	
Attention / Now continuing the distress call mode. Break this mode?	Confirmation screen when the CANCEL key is pressed in distress mode	To continue distress mode, select [Continue], or to cancel distress mode, select [Break]

### 4.5.3.2 Distress calls from the menu

The following describes the procedure to send a distress call with the nature of distress selected in the menu. Also, besides manually inputting position and the time information, the transmission method and frequency can be set here.

Note: Multi-frequency or single frequency can be selected as the transmission method. The various methods are shown below.

- Multi-frequency method: The distress call message is sent continuously on each frequency, 2187.5 kHz, 8414.5 kHz, and at least one other distress/safety frequency.
- Single frequency method: The same distress call message is sent on one distress/safety frequency 5 times continuously. If 2 or more distress/safety frequencies are selected, the same message is transmitted 5 times continuously in the same way on the other frequency after an interval between 3.5 to 4.5 minutes (variable).

#### ■ Procedure ■

- Press the **MENU** key, and through hierarchical menus, select 3 Editing a distress msg.

The distress type is displayed as Undesignated as a default value. If the position information is input automatically by a GPS type device, or has already input manually, that information is also displayed.

```

3)Editing a distress msg
Nature      : [Undesignated ]
Position    : [NE]
             : [ 89° 59. 0123' N]
             : [179° 59. 6789' E]
UTC of pos  : [23:59]
Mode(fixed) : [Radiotelephone]
Attempt type: [Multi-FRQ ]
Tx bands    : [2/4/6/8/12/16]
[Preview]   [Tips]   [Cancel]
    
```

- Press ENT and select the nature of distress.

The nature of distress is selectable from below.

Nature of distress	Contents
Fire	Fire, explosion
Flooding	Flooding
Collision	Collision
Grounding	Grounding
Listing	Listing, in danger of capsizing
Sinking	Sinking
Disabled	Disabled and adrift
Undesignated	Undesignated distress
Abandoning	Abandoning ship
Piracy attack	Piracy/armed robbery attack
Man overboard	Man overboard

```

3)Editing a distress msg
Nature      : [Fire ]
Position    : [NE]
             : [ 89° 59. 0123' N]
             : [179° 59. 6789' E]
UTC of pos  : [23:59]
Mode(fixed) : [Radiotelephone]
Attempt type: [Multi-FRQ ]
Tx bands    : [2/4/6/8/12/16]
[Preview]   [Tips]   [Cancel]
    
```

- Press ENT.

The cursor moves to Position. If a valid position and time of that position are already displayed, no entry is necessary. Skip to step 6.

```

3)Editing a distress msg
Nature      : [Fire ]
Position    : [NE]
             : [ 89° 59. 0123' N]
             : [179° 59. 6789' E]
UTC of pos  : [23:59]
Mode(fixed) : [Radiotelephone]
Attempt type: [Multi-FRQ ]
Tx bands    : [2/4/6/8/12/16]
[Preview]   [Tips]   [Cancel]
    
```

4. Press ENT and select the quadrant of the position with the jog dial.

The quadrant changes from NE → NW → SE → SW → CL. Select CL to delete the input information.

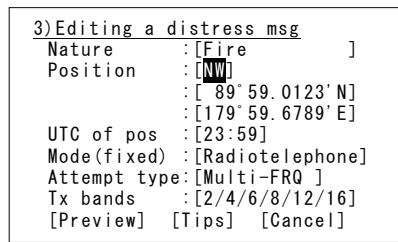

5. After pressing ENT, input the latitude, longitude, and time using the numeric keypad.

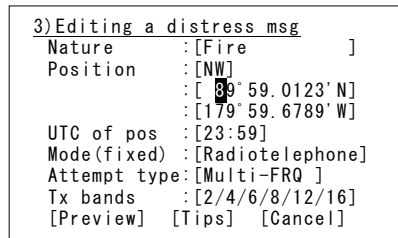

6. Move the cursor to Attempt type and press ENT to change the transmission method for the distress call.

Multi-frequency method is set as the default. To change to the single frequency method, select Single-FRQ with the job dial and press ENT.

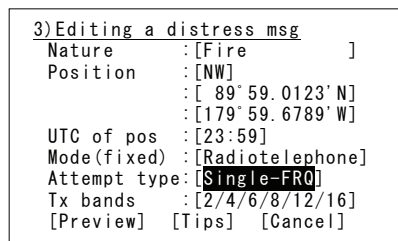

7. Move the cursor to Tx bands and press ENT to change the transmission frequency for the distress call.

- At first, all the frequencies are selected as transmission frequencies.
- To change the frequencies, move the cursor by pressing ENT to the frequencies (band) to be unselected, turn the jog dial so they are blank and press ENT.
- For the Multi-frequency method, 2 and 8 are fixed and are skipped. Also in this case, it is necessary to select more than one other band.
- After completing the Tx band settings, the cursor returns to Nature.

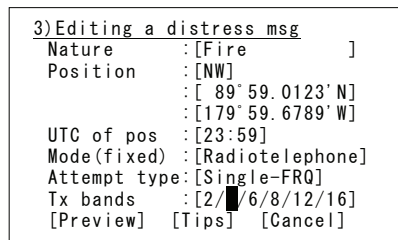

8. Open the **DISTRESS** key cover.



Operation

9. Press and hold the **DISTRESS** key for 4 seconds until the countdown is completed.

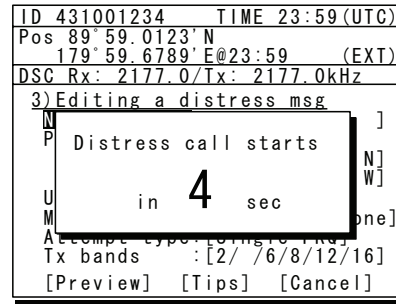

**Note**

- The rest of the procedure is the same as described in the "Quick distress call".
- Select Preview and press ENT before calling to display the details of the message as shown below.

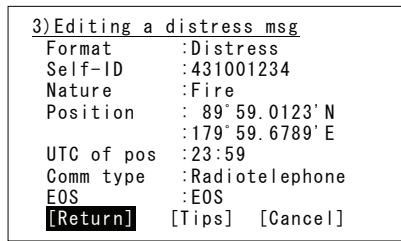

- Select Tips and press ENT to display precautions about operations in this screen in a popup screen as shown below.

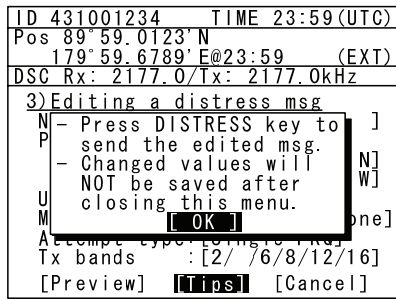

### 4.5.3.3 Receiving distress calls

When a distress call is received from another ship, the message is immediately displayed with the specific two-tone alarm sound that is different from a routine or safety call.

# ! WARNING

If a distress call is received, make sure to inform the ship's captain or officer in charge. Doing so may save the lives of the crews and passengers on the ship in distress.

#### ■ Procedure ■

1. When a distress call is received, the distress message is displayed.
  - The ALM lamp starts blinking, and the call alarm gradually grows louder. However, the aural alarm keeps silence if the distress position is not within 500nm, and is not in the polar areas (greater than 70°N/S).
  - The example message contains the following information.
    - Message type: Distress call
    - Caller's MMSI: 431001234
    - Nature of distress: Man overboard
    - Position & time: North latitude 12° 34.0000'  
East longitude 123° 45.0000'  
23:57
    - Communication mode: Radiotelephone
    - Sequence process: End of sequence
    - Receiving frequency\*: 2187.5 kHz

\* Scroll to view

ID 431001234 TIME 23:59(UTC)	
Pos 89° 59.0123' N 179° 59.6789' E@23:59 (EXT)	
TEL Rx: 4100.0/Tx: 4100.0kHz	
Received distress message	
Type	:Distress
From	:43102222
Nature	:Man overboard
Position	:12° 34.0000' N 123° 45.0000' E
UTC of pos:	:23:57
Mode	:Radiotelephone
▼ EOS	:EOS
Press CANCEL to silence alarm.	

Rx FRQ	:2187.5/----- -/
	----- -/----- -/
	----- -/----- -kHz

2. Press the **CANCEL** key or ENT to stop the alarm, and the screen at right is displayed.

Turn the jog dial to scroll the received message. When the last line of the message is reached the cursor moves to Accept.

ID 431001234 TIME 23:59(UTC)	
Pos 89° 59.0123' N 179° 59.6789' E@23:59 (EXT)	
TEL Rx: 4100.0/Tx: 4100.0kHz	
Received distress message	
Type	:Distress
From	:43102222
Nature	:Man overboard
Position	:12° 34.0000' N 123° 45.0000' E
UTC of pos:	:23:57
Mode	:Radiotelephone
▼ EOS	:EOS
[Accept]	[Cancel]

3. Press ENT while Accept is selected to set the radiotelephone mode's distress/safety frequency to the band the distress message was received on. The status display is displayed to watch the distress communications.

Keep watch for at least 5 minutes. Notify the coast station as appropriate.

ID 431001234 TIME 23:59(UTC)	
Pos 89° 59.0123' N 179° 59.6789' E@23:59 (EXT)	
TEL	
RX	2182.0 kHz
TX	2182.0 kHz
SIG ■■■■■■■■■■	
WKR scan bands: 2 4 6 8 12 16 (MHz)	ATT12 AGC-F BC

### 4.5.3.4 Acknowledging a received distress call

Ship stations must keep watch on distress communications after they receive the distress call. If necessary (after consulting with the RCC or a coast station and being directed to do so) it is possible to acknowledge the ship in distress from your own ship.

#### ■ Procedure ■

1. Press the **MENU** key, and through hierarchical menus, select 4.1 Received distress.

On the bottom line, the MMSI of the ship is displayed highlighted by the cursor.

ID 431001234		TIME 23:59(UTC)	
Pos 89° 59. 0123' N			
179° 59. 6789' E@23:59 (EXT)			
DSC Rx: 2177. 0/Tx: 2177. 0kHz			
4.1)Received distress			
No	Date/Time	CAT	Format
01	2008-08-05 11:20	---	DSTRS
02	2008-07-31 10:33	DST	INDIV
03	2008-07-31 10:25	DST	AREA
04	2008-07-31 10:03	---	DSTRS
05	2008-07-19 22:53	ERR	DSTRS
From: 123456789			

2. Select the distress call to acknowledge and press ENT.

The distress message is displayed with the ACK/Relay/Close handling menu.

**Note** If the distress call message could not be received on 2187.5 kHz, ACK is disabled so it is not displayed.

ID 431001234		TIME 23:59(UTC)	
Pos 89° 59. 0123' N			
179° 59. 6789' E@23:59 (EXT)			
DSC Rx: 2177. 0/Tx: 2177. 0kHz			
Received distress message			
Type	:Distress		
From	:123456789		
Nature	:Man overboard		
Position	:12° 34. 0000' N		
	123° 45. 0000' E		
UTC of pos:	:11:20		
Mode	:Radiotelephone		
▼ EOS	:EOS		
[ACK]	[Relay]	[Close]	

3. Scroll the received message by using the jog dial, when the cursor is on ACK press ENT.

The warning message, "In principle, the ACK should be sent by a coast station" is displayed.

ID 431001234		TIME 23:59(UTC)	
Pos 89° 59. 0123' N			
179° 59. 6789' E@23:59 (EXT)			
DSC Rx: 2177. 0/Tx: 2177. 0kHz			
Received distress message			
▲ P	- Attention -		
U	In principle, the ACK		
M	should be sent by a		
E	coast station.		
R	[Continue] [Cancel]		
	12577. 0/16804. 5kHz		
[ACK]	[Relay]	[Close]	

4. After confirming the warning message, select "Continue" and press ENT to send the acknowledgement in 2187.5 kHz DSC mode.

After sending the acknowledgement the radiotelephone mode is set to 2182.0 kHz, communicate by radiotelephone with the ship in distress according to the following procedure.

- Say "MAYDAY".
- Repeat the identity (MMSI) of the ship in distress 3 times
- Say "This is..."
- Repeat the identity (MMSI) of your ship 3 times
- Say "RECEIVED MAYDAY".

ID 431001234		TIME 23:59(UTC)	
Pos 89° 59. 0123' N			
179° 59. 6789' E@23:59 (EXT)			
TEL Rx: 2187. 5/Tx: 2187. 5kHz			
Received distress message			
▲ P	Sending the message.		
U			
M			
E			
R			
	12577. 0/16804. 5kHz		
[ACK]	[Relay]	[Close]	

**4.5.4 Distress relay calls on behalf of someone else**

If another ship is in distress but is itself unable to make a distress call, and the master of the ship considers that further help is necessary, the distress relay call on behalf of the ship can be transmitted using the "DSC drobose call" menu. In this case, compose a distress relay call format by inputting the MMSI (if known), the ship's position and the time of position (if known), and the nature of distress to send to a specific area or a coast station.

## ! CAUTION

When sending a drobose call, do NOT press the **DISTRESS** key. Doing so may cause a false distress call.  
(Drobose calls can be sent via the [Call] button displayed on the screen.)

**4.5.4.1 Coast station calls**

Transmits a drobose call to a specified coast station.

**■ Procedure ■**

1. Press the **MENU** key, and through hierarchical menus, select 2 DSC drobose call.

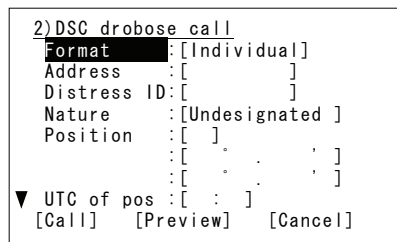

2. Select Address and press ENT, input the MMSI of the calling coast station.

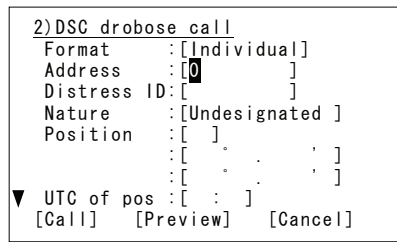

3. If the 9-digit identity (MMSI) of the ship in distress is known, select Distress ID, press ENT and input it.

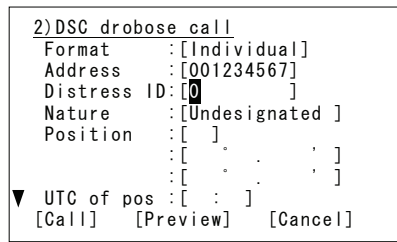





9. When an acknowledgement is received from a coast station, the screen at right is displayed.

- The ALM lamp starts blinking, and the call alarm gradually grows louder.
- Press either the **CANCEL** key or ENT to silence the alarm and display Accept in the handling menu.
- Select Accept and press ENT to display the status display and make a distress call on the radiotelephone.

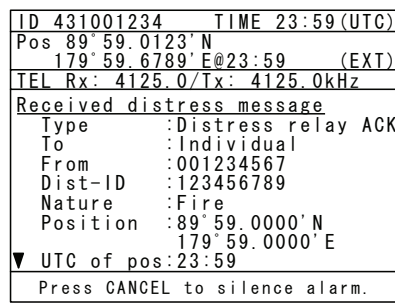

#### 4.5.4.2 Area calls

Transmits a DSC drobose call to all ships in a specified area.

##### ■ Procedure ■

1. Press the **MENU** key, and through hierarchical menus, select 2 DSC drobose call.
2. Select Format and press ENT, then select the Area (center) or Area (corner) with the jog dial.
3. Press ENT.
  - The display changes as shown to the right and the cursor moves to Center or Corner.
  - The input is the same as for safety and urgency area calls.
4. If the 9-digit identity (MMSI) of the ship in distress is known, select Distress ID, press ENT and input it.

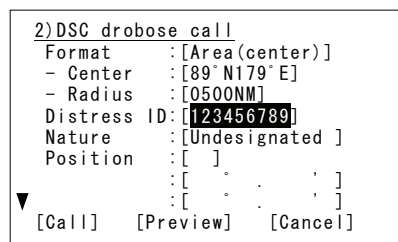
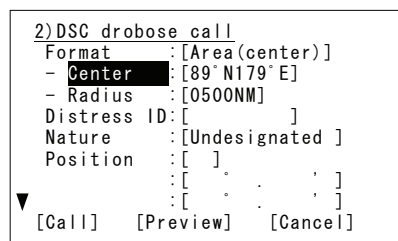
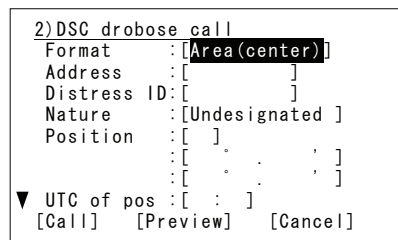
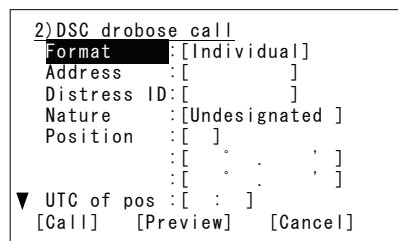



### 4.5.4.3 Receiving drobose calls

When receiving a drobose call directed to ships in a specified area, the ship stations (inc. your own ship) are allowed to acknowledge only by the radiotelephone. (Receiving a distress relay call from a coast station is the same.)

#### ■ Procedure ■

1. When a DSC drobose call is received, the screen at right is displayed.

- The ALM lamp starts blinking, and the call alarm gradually grows louder. However, the aural alarm keeps silence in cases below;
  - the distress position is not within 500nm and is not in the polar areas (greater than 70°N/S), or
  - duplicate area calls are received within 1 hour.

➤ The example message contains the following information.

- Message type: Distress relay area call
  - Call area: North latitude  
80 to 90 degrees  
East longitude  
170 to 180 degrees
  - Caller's MMSI: 431000123
  - Ship in distress MMSI: 431022222
  - Nature of distress: Man overboard
  - Position & time\*: North latitude  
90° 00.0000'  
East longitude  
180° 00.0000'  
23:57
  - Communication mode\*: Radiotelephone
  - Sequence process\*: End of sequence
  - Receiving frequency\*: 4207.5 kHz
- \* Scroll to view

ID 431001234	TIME 23:59(UTC)
Pos 89° 59.0123' N	179° 59.6789' E@23:59 (EXT)
TEL Rx: 4100.0/Tx: 4100.0kHz	
Received distress message	
Type	:Distress relay GEO
To	:80° N-90° N/ 170° E-180° E
From	:431000123
Dist-ID	:431022222
Nature	:Man overboard
Position	:90° 00.0000' N 180° 00.0000' E
▼ Press CANCEL to silence alarm.	

UTC of pos:	23:57
Mode	:Radiotelephone
EOS	:EOS
Rx FRQ	:4207.5kHz

2. Press the **CANCEL** key or ENT to stop the alarm, and the screen at right is displayed.

Turn the jog dial to scroll the received message. When the last line of the message is reached the cursor moves to Accept.

ID 431001234	TIME 23:59(UTC)
Pos 89° 59.0123' N	179° 59.6789' E@23:59 (EXT)
TEL Rx: 4100.0/Tx: 4100.0kHz	
Received distress message	
Type	:Distress relay GEO
To	:80° N-90° N/ 170° E-180° E
From	:431000123
Dist-ID	:431022222
Nature	:Man overboard
Position	:90° 00.0000' N 180° 00.0000' E
▼ [Accept] [Cancel]	

3. Press ENT while Accept is selected to set the radiotelephone mode's distress/safety frequency to the band the distress message was received on. The status display is displayed to watch the distress communications.

Keep watch for at least 5 minutes. Notify the coast station as appropriate.

ID 431001234	TIME 23:59(UTC)
Pos 89° 59.0123' N	179° 59.6789' E@23:59 (EXT)
<b>TEL</b>	
RX	4125.0 kHz
TX	4125.0 kHz
SIG ■■■■■■■■■■	
WKR scan bands:	ATT12 AGC-F BC
2 4 6 8 12 16 (MHz)	

**4.5.5 Distress relay calls**

After receiving a distress call, ship stations must keep watch on the distress/safety frequency of the radiotelephone for at least 5 minutes. If there is no response from the coast station, the received distress message can be sent to the coast station as a distress relay call.

**4.5.5.1 Sending distress relay calls**

A distress relay call can be composed from the log of the received distress message.

**■ Procedure ■**

1. Press the **MENU** key, and through hierarchical menus, select 4.1 Received distress.

On the bottom line, the MMSI of the ship is displayed highlighted by the cursor.

ID 431001234				TIME 23:59(UTC)	
Pos 89°59.0123' N				179°59.6789' E@23:59 (EXT)	
DSC Rx: 2177.0/Tx: 2177.0kHz					
4.1)Received distress					
No	Date/Time	CAT	Format		
01	2008-08-05 11:20	---	DSTRS		
02	2008-07-31 10:33	DST	INDIV		
03	2008-07-31 10:25	DST	AREA		
04	2008-07-31 10:03	---	DSTRS		
05	2008-07-19 22:53	ERR	DSTRS		
From: 123456789					

2. Select the distress call to be relayed and press ENT.

The distress message is displayed with the ACK/Relay/Close handling menu.

ID 431001234				TIME 23:59(UTC)	
Pos 89°59.0123' N				179°59.6789' E@23:59 (EXT)	
DSC Rx: 2177.0/Tx: 2177.0kHz					
Received distress message					
Type :Distress					
From :123456789					
Nature :Man overboard					
Position :12°34.0000' N					
:123°45.0000' E					
UTC of pos:11:20					
Mode :Radiotelephone					
▼ EOS :EOS					
[ACK]		[Relay]		[Close]	

3. Scroll the received message by using the jog dial, when the cursor is on Relay press ENT.

The warning message, "Normally, the relay call should be sent to a coast station." is displayed.

ID 431001234				TIME 23:59(UTC)	
Pos 89°59.0123' N				179°59.6789' E@23:59 (EXT)	
DSC Rx: 2177.0/Tx: 2177.0kHz					
Received distress message					
▲ P - Attention -					
U Normally, the relay					
M call should be sent					
E to a coast station.					
R [Continue] [Cancel]					
12577.0/16804.5kHz					
[ACK]		[Relay]		[Close]	

4. After confirming the warning message, select "Continue" and press ENT.

Enter the appropriate address and call frequency in the screen as shown at right.

**Note**

- The screen at right is for sending individual distress relay calls.
- To transmit the distress relay call to a specified area, use the jog dial to move the cursor to Area as shown in the screen at right and then press ENT.

ID 431001234				TIME 23:59(UTC)	
Pos 89°59.0123' N				179°59.6789' E@23:59 (EXT)	
DSC Rx: 2177.0/Tx: 2177.0kHz					
Received distress message					
▲ P - Individual call -					
U Address : [            ]					
M Call FRQ : [ 2187.5kHz ]					
E [Call] [Area] [Cancel]					
R 12577.0/16804.5kHz					
[ACK]		[Relay]		[Close]	

The screen at right is displayed, and the operations are the same as for making safety and urgency calls to areas.

- To specify the northwest corner and the south/north and east/west deviation, select Corner/dev at Format and press ENT in the screen shown at right (below), and input appropriate values.

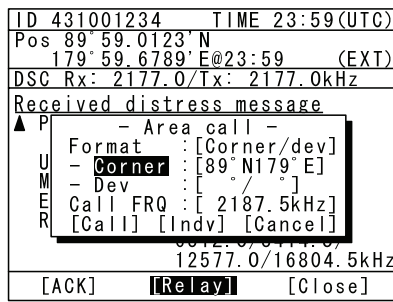
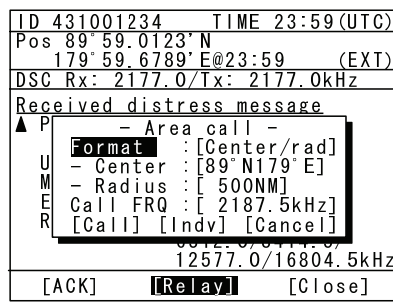

5. Select Call and press ENT to tune the antenna and make a distress relay call.

**Note** After finishing the transmission, DSC transmission frequency and the same band for radiotelephone mode's distress/safety frequency settings are shown in the status display. Start distress communication when reply is received on the radiotelephone.

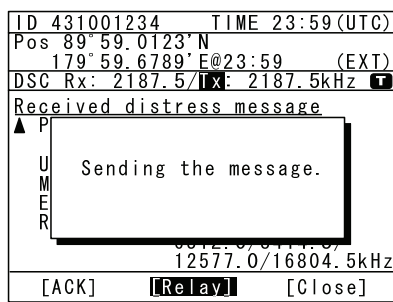

6. After sending a distress relay call to a coast station, and when the acknowledgement is received via DSC, the screen at right is displayed.

- The ALM lamp starts blinking, and the call alarm gradually grows louder.
- Press either the **CANCEL** key or ENT to silence the alarm and display Accept in the handling menu.
- Select Accept and press ENT to display the status display and start distress communication on the radiotelephone.

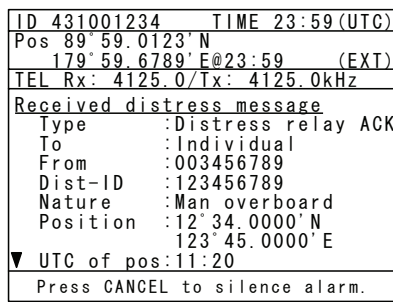

### 4.5.5.2 Receiving distress relay calls

As a general rule, ship stations should respond via radiotelephone after receiving a distress relay call. But if called individually by another ship station, and if allowed by a coast station, a distress relay acknowledgement can be transmitted as follows. Further, a distress relay acknowledgement can be composed from the log of the received distress relay message.

#### ■ Procedure ■

1. When a distress relay call is received, the screen at right is displayed.

- The ALM lamp starts blinking, and the call alarm gradually grows louder. However, the aural alarm keeps silence in cases below;
    - the distress position is not within 500nm and is not in the polar areas (greater than 70°N/S), or
    - duplicate all ships calls or area calls are received within 1 hour.
  - The example message contains the following information.
    - Message type: Distress relay message
    - To: Individual (own ship)
    - Caller's MMSI: 431000123
    - Ship in distress MMSI: 431022222
    - Nature of distress: Man overboard
    - Position & time: North latitude 90° 00.0000'  
East longitude 180° 00.0000'  
23:57
    - Communication mode\*: Radiotelephone
    - Sequence process\*: ACK RQ
    - Receiving frequency\*: 4207.5 kHz
- \* Scroll to view

ID 431001234	TIME 23:59(UTC)
Pos 89° 59.0123' N	179° 59.6789' E@23:59 (EXT)
TEL Rx: 4100.0/Tx: 4100.0kHz	
Received distress message	
Type	: Distress relay
To	: Individual
From	: 431000123
Dist-ID	: 431022222
Nature	: Man overboard
Position	: 90° 00.0000' N 180° 00.0000' E
▼ UTC of pos:	23:57
Press CANCEL to silence alarm.	

Mode	: Radiotelephone
EOS	: ACK RQ
Rx FRQ	: 4207.5kHz

2. Press the **CANCEL** key or ENT to stop the alarm, and the screen at right is displayed.

Turn the jog dial to scroll the received message. When the last line of the message is reached the cursor moves to Accept.

ID 431001234	TIME 23:59(UTC)
Pos 89° 59.0123' N	179° 59.6789' E@23:59 (EXT)
TEL Rx: 4100.0/Tx: 4100.0kHz	
Received distress message	
Type	: Distress relay
To	: Individual
From	: 431000123
Dist-ID	: 431022222
Nature	: Man overboard
Position	: 90° 00.0000' N 180° 00.0000' E
▼ UTC of pos:	23:57
[Accept]	[Cancel]

3. Press ENT while Accept is selected to set the radiotelephone mode's distress/safety frequency to the band the distress message was received on. The status display is displayed to watch the distress communications.

- Keep watch for at least 5 minutes.
- When acknowledging the distress relay, follow the procedure described below.

ID 431001234	TIME 23:59(UTC)
Pos 89° 59.0123' N	179° 59.6789' E@23:59 (EXT)
<b>TEL</b>	
RX	4125.0 kHz
TX	4125.0 kHz
SIG ■■■■■■■■■■	
WKR scan bands:	ATT12 AGC-F BC
2 4 6 8 12 16 (MHz)	

- Press the **MENU** key, and through hierarchical menus, select 4.1 Received distress.

On the bottom line, the MMSI of the ship is displayed highlighted by the cursor.

ID 431001234				TIME 23:59(UTC)	
Pos 89° 59.0123' N					
179° 59.6789' E@23:59 (EXT)					
TEL Rx: 4125.0/Tx: 4125.0kHz					
4.1) Received distress					
No	Date/Time	CAT	Format		
01	2008-08-01 23:31	DST	INDIV		
02	2008-07-31 10:33	DST	AREA		
03	2008-07-31 10:25	---	DSTRS		
04	2008-07-31 10:03	---	DSTRS		
05	2008-07-19 22:53	ERR	DSTRS		
From: 431000123					

- Select the distress relay call to be acknowledged and press ENT.

The distress relay message is displayed.

ID 431001234				TIME 23:59(UTC)	
Pos 89° 59.0123' N					
179° 59.6789' E@23:59 (EXT)					
TEL Rx: 4125.0/Tx: 4125.0kHz					
Received distress message					
Type	: Distress relay				
To	: Individual				
From	: 431000123				
Dist-ID	: 431022222				
Nature	: Man overboard				
Position	: 90° 00.0000' N				
	180° 00.0000' E				
▼ UTC of pos:	23:57				
[Relay ACK]					[Close]

- Use the jog dial to scroll the screen.

When the last line of the message is reached the cursor moves to Relay ACK.

ID 431001234				TIME 23:59(UTC)	
Pos 89° 59.0123' N					
179° 59.6789' E@23:59 (EXT)					
TEL Rx: 4125.0/Tx: 4125.0kHz					
Received distress message					
▲ Dist-ID	: 431022222				
Nature	: Man overboard				
Position	: 90° 00.0000' N				
	180° 00.0000' E				
UTC of pos:	23:57				
Mode	: Radiotelephone				
EOS	: ACK RQ				
Rx FRQ	: 4207.5kHz				
[Relay ACK]					[Close]

- Select Relay ACK and press ENT to tune the antenna and send a distress relay acknowledgement.

After transmission, displays the status display in radiotelephone mode. Then wait for a call on the frequency of the radiotelephone mode.

ID 431001234				TIME 23:59(UTC)	
Pos 89° 59.0123' N					
179° 59.6789' E@23:59 (EXT)					
DSC Rx: 4207.5/Tx: 4207.5kHz					
Received distress message					
▲ D	Sending the message.				
N					
P					
U					
M					
EOS	: ACK RQ				
Rx FRQ	: 4207.5kHz				
[Relay ACK]					[Close]

## 4.6 DSC call log

Received DSC messages are classified as distress messages and as other messages. The 20 most recent messages for both types are saved in the log.

### ⚠ CAUTION



A distress acknowledgement or a distress relay call can be transmitted from a received distress message stored in the log, but when sending such a call, follow the instructions of the ship's captain or officer in charge.



Received distress message logs are automatically deleted after 48 hours to avoid accidental resending or other misoperation. Accordingly, if such messages cannot be read, it is not a malfunction.



The received distress message logs are cleared when turning off the power by such as the breaker on the transceiver. Due to the SOLAS Convention (keeping watch on distress and safety frequencies at all times), do not turn off the equipment when at sea.

### 4.6.1 Received distress messages

The distress call, distress acknowledgement, distress relay call, and distress relay acknowledgement messages are stored in this log. For distress alerts, messages with the same content are received at a maximum of 6 messages for the multi-frequency method or a maximum of 5 messages for the single frequency method, but only one is stored unless otherwise closed the received message during that multiple receptions.

#### ■ Procedure ■

1. Press the **MENU** key, and through hierarchical menus, select 4.1 Received distress.

- On the bottom line, the MMSI of the ship is displayed highlighted by the cursor.
- If the message includes a reception error (ECC error) ERR is shown in the CAT field.

ID 431001234	TIME 23:59(UTC)		
Pos 89° 59. 0123' N	179° 59. 6789' E@23:59 (EXT)		
DSC Rx: 2177.0/Tx: 2177.0kHz			
4.1)Received distress			
No	Date/Time	CAT	Format
01	2008-08-05 11:20	---	DSTRS
02	2008-07-31 10:33	DST	INDIV
03	2008-07-31 10:25	DST	AREA
04	2008-07-31 10:03	---	DSTRS
05	2008-07-19 22:53	ERR	DSTRS
From: 123456789			

2. Select a displayed message and press ENT.

The message is displayed with the ACK, Relay, Relay ACK, or Close handling menu.

ID 431001234	TIME 23:59(UTC)
Pos 89° 59. 0123' N	179° 59. 6789' E@23:59 (EXT)
DSC Rx: 2177.0/Tx: 2177.0kHz	
Received distress message	
Type	: Distress
From	: 123456789
Nature	: Man overboard
Position	: 12° 34. 0000' N
	: 123° 45. 0000' E
UTC of pos:	: 11:20
Mode	: Radiotelephone
▼ EOS	: EOS
[ACK]	[Relay] [Close]



**4.6.2 Received other messages**

Received messages that are not in the distress category (routine, safety, and urgency) are stored in this log.

**■ Procedure ■**

**1.** Press the **MENU** key, and through hierarchical menus, select 4.2 Received others.

- On the bottom line, the MMSI of the ship is displayed highlighted by the cursor.
- If the message includes a reception error (ECC error) ERR is shown in the CAT field.

ID 431001234				TIME 23:59(UTC)	
Pos 89° 59.0123' N				179° 59.6789' E@23:59 (EXT)	
DSC Rx: 2177.0/Tx: 2177.0kHz					
4.2)Received others					
No	Date/Time	CAT	Format		
01	2008-07-31 11:00	RTN	INDIV		
02	2008-07-22 18:17	SAF	AREA		
03	2008-07-22 18:17	URG	AREA		
04	2008-07-19 22:53	ERR	INDIV		
From: 003456789					

**2.** Select a displayed message and press ENT.

The selected message is displayed.

ID 431001234		TIME 23:59(UTC)	
Pos 89° 59.0123' N		179° 59.6789' E@23:59 (EXT)	
TEL Rx: 2065.0/Tx: 2065.0kHz			
Received routine message			
Type	: Individual call		
From	: 003456789		
Mode	: Radiotelephone		
Work FRQ	: Tx 2065.0kHz		
	: Rx 2065.0kHz		
EOS	: ACK RQ		
Rx FRQ	: 2177.0kHz		
<b>[Close]</b>			

## 4.7 Popup screens

The contents of the popup screens are as follows (in alphabetical order).

Message	Buttons	Description
Access denied Another controller is currently in use.	OK	Cannot obtain the access right because another controller is currently in use.
Attention DISTRESS stopped by another unit.	OK	Stopped the distress alert by another unit such as DMC.
Attention In principle, the ACK should be sent by a coast station.	Continue/ Cancel	In principle, distress acknowledgement is sent by coast station. Continue: Continues the operation. Cancel: Cancels this operation.
Attention Normally, the relay call should be sent to a coast station.	Continue/ Cancel/ OK* (*drobose call only)	Normally, DSC distress relay acknowledgements are sent to a coast station. Continue: Continue making call. Cancel: Stop making call. OK: Continue making call.
Attention Now continuing the distress call mode. Break this mode?	Continue/ Break	Pressed the CANCEL key during the distress call mode. Is it ok to break? Continue: Continues the distress mode. Break: Breaks the distress mode.
Attention Failed to send the DSC message.	OK	Cannot send DSC message for some reason.
Attention Left without operating. The menu will be closed automatically, soon...	Cancel	This process will be canceled and returns to the status display condition because the controller has been left without operating. Cancel: Cancels the shutdown.
Attention Resending the distress call soon...	Cancel	DSC resends the distress call automatically soon. Cancel: Shows the confirmation popup for the distress mode termination.
Attention Tuning the antenna to the frequency now. Wait a moment, please.	-----	Tuning the antenna. Wait a moment.
Channel/frequency dial operation is invalid right now. To enable it, press FUNC, and ENT.	-----	The channel operation with the jog dial is disabled right now. To enable it, press the FUNC key and ENT in order.
Data sending...	Cancel	Updating user channel information on other controller using the Data transfer menu. Cancel: Cancels update.
DISTRESS call starts in Xsec	-----	The DISTRESS key is being pressed. Distress call starts in X seconds.
Erase all channels?	OK/ Cancel	Is it OK to delete all channel information of the group selected. OK: Erases all channels. Cancel: Cancels this operation.

Erase all groups? (All registered user channels)	OK/ Cancel	Is it OK to delete all groups and user channels? OK: Erases all data. Cancel: Cancels this operation.
Erase this channel?	OK/ Cancel	Is it ok to erase user channel information that is now selected? OK: Erases this data. Cancel: Cancels this operation.
Function denied Currently running the self diagnosis.	OK	Cannot put the controller into sleep mode during the self diagnosis.
Invalid address	OK	The address specified for DSC call is empty or invalid.
Invalid distress ID	OK	The distress ID specified for DSC drobose call is invalid.
Invalid value	OK	An invalid value is detected while processing a task.
OK to sleep the MF/HF equipment, or only this controller?	EQP/ CTRL/ Cancel	Is it OK to put MF/HF radio equipment or controller into sleep mode? EQP: MF/HF radio equipment CTRL: Controller Cancel: Cancels this operation.
OK to sleep this controller?	OK/ Cancel	OK to put this controller into sleep mode? OK: Puts one controller into sleep mode. Cancel: Cancels this operation.
OK to sleep the MF/HF equipment?	OK/ Cancel	Is it OK to put MF/HF radio equipment into sleep mode? OK: Puts it into sleep mode. Cancel: Cancels this operation.
OK to transfer the user channels to another controller?	OK/ Cancel	Is it OK to transfer this controller's user channel information to another controller? OK: Transfers the data. Cancel: Cancels this operation.
OK to update this user channel table?	OK/ Cancel	There is a request from controller with access rights to update user channel information on this controller. Is it OK to update? OK: Update the data. Cancel: Do not update the data.
- Press DISTRESS key to send the edited msg. - Changed values will NOT be saved after closing this menu.	OK	- Press the DISTRESS key when sending a message created with the Editing a distress msg menu. - The data input in this menu is not saved when it is closed.
Press ENT to stop the sound.	-----	Testing the loudspeaker now. After checking the sound, press ENT to stop it.
Pressing the DISTRESS on another unit, and starts in Xsec	-----	The DISTRESS key is being pressed on another unit. Distress call starts in X seconds.

## Operation

Print out this data?	OK/ Cancel	Print out the displayed data? OK: Prints out now. Cancel: Stops this operation.
Printer error	OK	Stopped printing for no printer detection.
Printing now...	-----	Printing out the displayed data. Wait a moment.
Remaining the field maintenance mode. This mode will be canceled soon.	OK/ Cancel	Equipment is left in the field maintenance mode. Sleep mode will start soon.
Sending the message.	-----	Sending the DSC message now.
System busy	OK	There is no reply from the transceiver.
Updating the table...	Cancel	Using the Data transfer menu to update user channel information on this controller. Cancel: Cancels update.
View alarm history?	OK/ Cancel	View the alarm history? OK: Views the alarm history. Cancel: Cancels this operation.
Wait a moment, please.	-----	Now processing, please wait a moment.

## 5. SETTINGS & REGISTRATIONS

This chapter describes the procedures for settings and registrations such as manual date and time settings, registration of channels in each mode, advanced DSC settings, printer settings, and other settings for the equipment.

### 5.1 Date and time settings

Normally, the date and time are updated automatically if importing GPS information. But, if necessary, input these parameters manually as follows.

#### ⚠ CAUTION



The time in the 7.1 Date & time menu means the present time, and is different from the time in the 7.2 POS/TIME menu that means the time when the position information is valid.

#### ■ Procedure ■

1. Press the **MENU** key, and through hierarchical menus, select 7.1 Date & time.

```
7.1)Date & time
1. Date :2008-12-31
2. Present time :23:59
3. Display form
  - UTC/LT :UTC
  - LT diff : :
0. Back
```

2. To input the date, press ENT.

Input the year, month, and date with the numeric keypad or jog dial, and press ENT.

```
7.1)Date & time
1. Date :2008-12-31
2. Present time :23:59
3. Display form
  - UTC/LT :UTC
  - LT diff : :
0. Back
```

3. After completing the above steps, the cursor moves to 2. Present time.

```
7.1)Date & time
1. Date :2008-12-31
2. Present time :23:59
3. Display form
  - UTC/LT :UTC
  - LT diff : :
0. Back
```

## Settings & Registrations

### 4. To input the present time, press ENT.

- Input the hours and minutes with the numeric keypad or jog dial, and press ENT.
- To close this menu after completing the date and time settings, place the cursor on any one of the selectable items and press the **CANCEL** key.

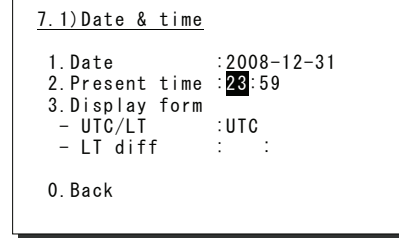

#### Note

In addition to the above, the following items can be set in this menu.

- UTC/LT: Select a type of time, Universal Time Coordinated (UTC) or Local Time (LT), shown on the screen.
- LT diff: Set the local time difference to display the local time.

## 5.2 Own ship position and time settings

Normally, the ship's position and the time are updated automatically if importing GPS information. But, if necessary, input these parameters manually as follows.

### ⚠ CAUTION



The time in the 7.2 POS/TIME menu means the time when the position information is valid, and is different from the present time mentioned in the 7.1 Date & time menu.

#### ■ Procedure ■

1. Press the **MENU** key, and through hierarchical menus, select 7.2 POS/TIME.
2. To input your own ship's position, press ENT.  
Select the position quadrant with the jog dial, and press ENT. Then input the latitude and longitude with the numeric keypad or jog dial, and press ENT.
3. After completing the above steps, the cursor moves to 2. UTC of position.
4. To input the UTC of position entered above, press ENT.
  - Input the hours and minutes with the numeric keypad or jog dial, and press ENT.
  - To close this menu, place the cursor on any one of the selectable items and press the **CANCEL** key.

```

7.2) POS/TIME
1. Own position: NE
                  89° 59.1234' N
                  179° 59.1234' E
2. UTC of position:
                  23:59
0. Back
  
```

```

7.2) POS/TIME
1. Own position: NE
                  89° 59.1234' N
                  179° 59.1234' E
2. UTC of position:
                  23:59
0. Back
  
```

```

7.2) POS/TIME
1. Own position: NE
                  89° 59.1234' N
                  179° 59.1234' E
2. UTC of position:
                  23:59
0. Back
  
```

```

7.2) POS/TIME
1. Own position: NE
                  89° 59.1234' N
                  179° 59.1234' E
2. UTC of position:
                  23:59
0. Back
  
```

#### Note

- If the position and the time information are received from an external device, such as a GPS, the manually entered data is overwritten automatically.
- If the position and the time information are not received, from a GPS or other device, within 10 minutes after powering on, or after 10 minutes has elapsed since input was interrupted, the similar screen appears with an alarm automatically. Further, regardless of either manual or automatic input, if the position and the time are not updated within 4 hours since the last entry, the screen with the alarm will appear repeatedly.

## 5.3 Controller settings

The following describes the procedure regarding individual settings for the controller such as LCD adjustment.

### 5.3.1 LCD adjustment

The LCD conditions for viewability are adjustable as follows.

#### ■ Procedure ■

1. Press the **MENU** key, and through hierarchical menus, select 7.3.1 LCD adjustment.

The screen as shown at right is displayed.

```

7.3.1) LCD adjustment
1. Contrast : 06
2. Dimmer
   Maximum : 10
   Typical  : 08
   Minimum  : 06
3. Screen saver : OFF
   Timer (sec): 060
0. Back
    
```

2. Move the cursor to the desired item and press ENT. Then alter the settings as appropriate with the numeric keypad or jog dial, and press ENT again.

- Set each item within the ranges given below:
  - Contrast: 1 - 13
  - Dimmer: 1 - 10
  - Screen saver: ON/OFF
  - Timer: 1 - 999 seconds
- To close this menu, place the cursor on any one of the selectable items and press the **CANCEL** key.

```

7.3.1) LCD adjustment
1. Contrast : 06
2. Dimmer
   Maximum : 10
   Typical  : 08
   Minimum  : 06
3. Screen saver : OFF
   Timer (sec): 060
0. Back
    
```

### 5.3.2 Sound settings

Sound settings such as the click beep are adjustable as follows.

#### ■ Procedure ■

1. Press the **MENU** key, and through hierarchical menus, select 7.3.2 Sound.

The screen as shown at right is displayed.

```

7.3.2) Sound
1. Operation
   - Speaker : ON
   - Click   : ON
2. Notification level: 7
3. Sidetone   : ON
0. Back
    
```

2. Move the cursor to the desired item and press ENT. Then set the conditions as appropriate with the numeric keypad or jog dial, and press ENT again.

- Notification level for a tone can be set within 1 - 7.
- When Sidetone is set to ON, an 800 Hz tone sounds during keying in.
- To close this menu, place the cursor on any one of the selectable items and press the **CANCEL** key.

```

7.3.2) Sound
1. Operation
   - Speaker : ON
   - Click   : ON
2. Notification level: 7
3. Sidetone   : ON
0. Back
    
```



### 5.3.3 User key assignments

User key assignment enables the desired menu to be displayed immediately without moving through the hierarchical menus, and is assignable as follows.

#### ■ Procedure ■

1. Press the **MENU** key, and through hierarchical menus, select 7.3.3 User key assign.

The screen at right is displayed. If the desired menu has already been registered, the cursor is placed on that menu.

```
7.3.3)User key assign
1. DSC non-distress call
2. DSC drobose call
3. Editing a distress msg
4. DSC logs
5. Radio operation
6. User channel list
7. ITU channel list
8. Receiver
```

2. Move the cursor to the desired menu to be registered with the jog dial.

The assignable menus are as follows:

1. DSC non-distress call	(Menu1)	16. Setup	(Menu7)
2. DSC drobose call	(Menu2)	17. Date & time	(Menu7.1)
3. Editing a distress msg	(Menu3)	18. POS/TIME	(Menu7.2)
4. DSC logs	(Menu4)	19. My controller	(Menu7.3)
5. Radio operation	(Menu5)	20. LCD adjustment	(Menu7.3.1)
6. User channel list	(Menu5.1)	21. Sound	(Menu7.3.2)
7. ITU channel list	(Menu5.2)	22. User channels	(Menu7.4)
8. Receiver	(Menu5.4)	23. DSC/WKR condition	(Menu7.5)
9. Scan	(Menu5.4.7)	24. Automatic ACK	(Menu7.5.1)
10. Transmitter	(Menu5.5)	25. WKR scanning FRQ	(Menu7.5.2)
11. Maintenance	(Menu6)	26. Option	(Menu7.6)
12. Self diagnosis	(Menu6.1)	27. CH dial lock ON/OFF	---
13. DSC loop	(Menu6.1.1)	28. 2182kHz	---
14. Alarm information	(Menu6.2)	29. AM mode	---
15. Software version	(Menu6.3)		

3. Press ENT to complete registration.

After registration, the screen returns to the previous hierarchical menu as shown at right.

```
7.3)My controller
1. LCD adjustment
2. Sound
3. User key assign
4. Tx meter :PWR
5. Data transfer
0. Back
```

#### Note

When the **USER** key is pressed in the factory default setting, this menu is immediately displayed.

**5.3.4 Selecting Tx meters**

The meter displayed in the status display indicates the strength of the received signal (S meter). However, it can also indicate one of Tx power, antenna current, PA voltage or PA current during transmission.

**■ Procedure ■**

1. Press the **MENU** key, and through hierarchical menus, select 7.3 My controller.

The screen as shown at right is displayed.

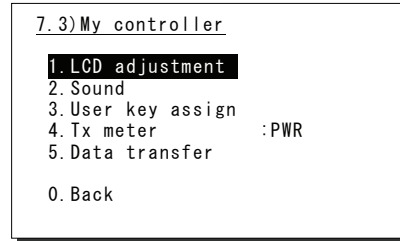

2. Move the cursor to 4. Tx meter with the numeric keypad or jog dial.

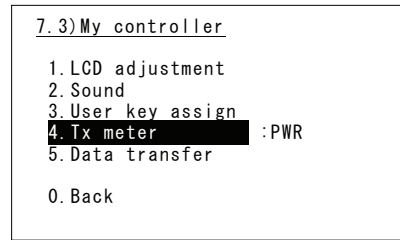

3. Press ENT, and select the meter type with the jog dial.

The selectable meters are as follows:

- PWR..... Tx power
- Ia ..... Antenna current
- Vc ..... PA voltage
- Ic ..... PA current

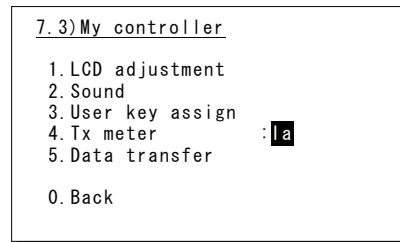

4. Press ENT to confirm the selection.

The setting is complete.

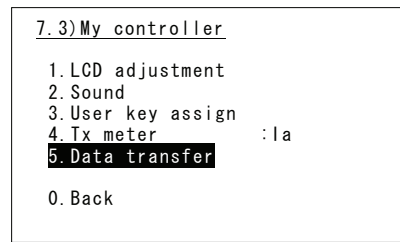

### 5.3.5 Transferring user channel data to another controller

When 2 controllers are connected, stored information (user channel table) can be transferred from the controller having access rights to another controller (monitor condition).

#### ■ Procedure ■

1. Press the **MENU** key, and through hierarchical menus, select 7.3 My controller.

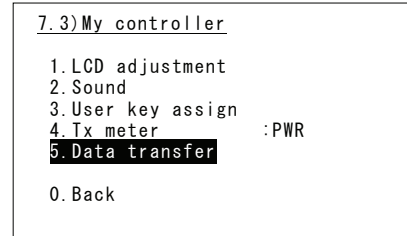

2. Move the cursor to 5. Data transfer with the numeric keypad or jog dial.

The popup screen as shown at right is displayed.

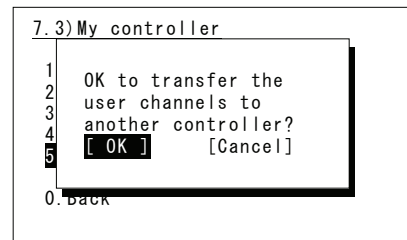

3. Press ENT to confirm the selection.

- The popup screen as shown at right is displayed to indicate the controller's status for forwarding.
- The screen at right (below) is displayed on the monitor.  
If OK is selected or the screen is left as it is for 10 seconds, transferring of stored information is started.

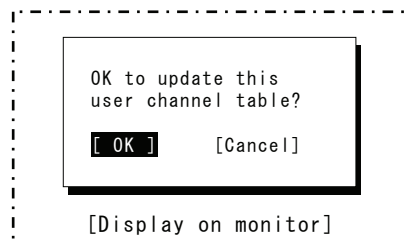
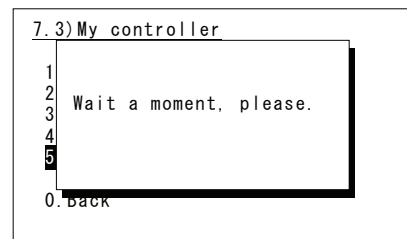

4. Forwarding of stored information is started.

- During forwarding, the popup screen as shown at right is displayed.
- The screen at right (below) is displayed on the monitor.
- The previous screen is returned to when forwarding is completed.

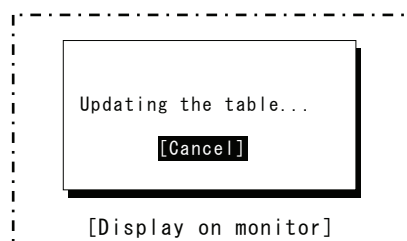
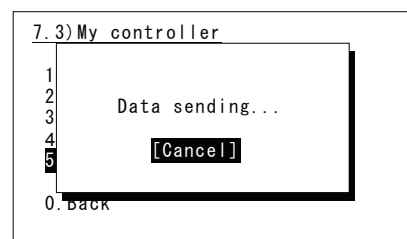

**Note** To cancel forwarding midway, press the **CANCEL** key or ENT.

## 5.4 Registering user channels

Often used frequencies can be registered as user channels and used in scanning radio settings or groups. A total of 20 groups with 20 channels set to each group (i.e. 400 channels) can be registered.

### ■ Procedure ■

1. Press the **MENU** key, and through hierarchical menus, select 7.4 User channels (index).

7.4) User channels (index)		
No	CH group name	Type
01	JRC Tokyo	TEL
02	Pacific ABC	CW
03		
04		
05		
06		
07		
▼08		

2. Select the desired row or group to be edited with the numeric keypad or jog dial.

The screen at right is displayed. (This example is for new registration to group 03.) Also, if an unregistered group is opened, TEL is displayed at Type as the default.

7.4) User channels (table)			
Name:			
Type: TEL			
CHNo	Rx [kHz]	Tx [kHz]	Mode
041			
042			
043			
044			
045			
▼046			

3. Press ENT to enter the group name.

- Up to 18 characters can be registered.
- The following characters are available:
  - Alphabet (capital and small letters)
  - Numbers 0 - 9
  - The following signs, space and determination symbol (◀)
    - [ ] \_ " # % & ' ( ) ? @ + - / = : ; < >
- Group names can be omitted.

7.4) User channels (table)			
Name: ◀			
Type: TEL			
CHNo	Rx [kHz]	Tx [kHz]	Mode
041			
042			
043			
044			
045			
▼046			

4. Select a character and press ENT one by one.

- When inputting numbers with the numeric keypad ENT is not needed.
- To return to the previous letter, press the **CANCEL** key.
- To complete name entry of 18 characters long, press ENT after selecting the last character by the jog dial. Or, if the name is less than 18 characters long, following the name, select the determination symbol (◀), as shown at right and press ENT.

7.4) User channels (table)			
Name: Japan Radio◀			
Type: TEL			
CHNo	Rx [kHz]	Tx [kHz]	Mode
041			
042			
043			
044			
045			
▼046			

**Note**

The character sequence shown by turning the jog dial is as follows:  
 ◀ A B C D E F G H I J K L M N O P Q R S T U V W X Y Z a b c d e f g h i j k l m n  
 o p q r s t u v w x y z [ ] \_ " # % & ' ( ) ? @ + - / = : ; < > 0 1 2 3 4 5 6 7 8 9 (space)

5. After completing the above steps, the cursor returns to Type.

- If necessary, change the group attribute (communication mode or custom).
- The following attributes can be selected:
  - TEL.....Radiotelephone mode
  - DSC.....Digital selective calling mode
  - CW .....Continuous wave mode
  - Custom     Communication mode mix

7.4) User channels (table)			
Name: Japan Radio			
Type: TEL			
CHNo	Rx [kHz]	Tx [kHz]	Mode
041			
042			
043			
044			
045			
▼ 046			

6. When setting of group attributes is completed, the cursor returns to the topmost row of the channel number. (CHNo).

7.4) User channels (table)			
Name: Japan Radio			
Type: TEL			
CHNo	Rx [kHz]	Tx [kHz]	Mode
041			
042			
043			
044			
045			
▼ 046			

7. Select the channel number to register with the jog dial, and press ENT.

Register as follows in the popup screen at right.

- When the group attribute is Custom, specify the communication mode at Mode. Otherwise, the communication mode is fixed to the mode specified at Type.
- To reference a frequency from the ITU channel, move the cursor to ITU channel, press ENT, and specify that channel number.
- Move the cursor to Rx freq(kHz), press ENT, and enter the Rx frequency.
- Move the cursor to Tx freq(kHz), press ENT, and enter the Tx frequency.

7.4) User channels (table)			
Name: CHNo. 041/Type TEL			
Type: Mode : TEL			
CH	ITU Channel		ie
04	Rx freq(kHz) :		
04	Tx freq(kHz) :		
04	[OK] [Cancel] [Erase]		
044			
045			
▼ 046			

8. After completing the above steps, move the cursor to OK, and press ENT to complete registration.

- Follow the same procedure above to create a group of channels.
- Already registered channels can be changed by the above procedure.
- To close this menu, place the cursor on any one of the registration numbers, and press the **CANCEL** key.

7.4) User channels (table)			
Name: Japan Radio			
Type: TEL			
CHNo	Rx [kHz]	Tx [kHz]	Mode
041	4071.0	4071.0	TEL
042			
043			
044			
045			
▼ 046			

**Note**

- To delete an already registered channel, move the cursor to Erase in the above popup screen, and press ENT.
- To erase an already registered group, move the cursor to "000 ALL CLEAR function" in the bottommost row of the channel list, and press ENT. Next, move the cursor to OK in the confirmation screen, and press ENT.
- To erase all already registered groups, move the cursor to "00 ALL CLEAR function" in the User channels (index) screen, and press ENT. Next, move the cursor to OK in the confirmation screen, and press ENT.

## 5.5 Advanced settings for DSC/WKR

The following describes the procedure for the advanced DSC settings such as automatic acknowledgement, as well as setting the watch frequency of the watch keeping receiver.

### ■ Menu screen ■

Press the **MENU** key, and through hierarchical menus, select 7.5 DSC/WKR condition.

The following describes the procedures from this screen. Note that the screen at right shows factory default settings.

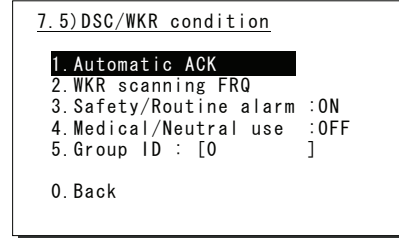

### 5.5.1 Automatic acknowledgment

If any one of the individual calls below is received when the automatic acknowledgement is set to ON and no menu is displayed, the acknowledgement is sent automatically without notice.

- Safety - a test call
- Safety - a position request call
- Routine - a polling call

### ■ Procedure ■

**1.** Move the cursor to 1. Automatic ACK, and press ENT.

The screen as shown at right is displayed.

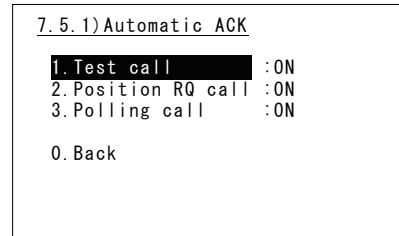

**2.** Set the call setting targeted for automatic acknowledgement to ON.

### 5.5.2 Setting DSC watch frequency

Set the frequency to watch on the WKR (DSC watch keeping receiver).

#### ■ Procedure ■

1. Move the cursor to 2. WKR scanning FRQ, and press ENT.

The screen as shown at right is displayed.

#### 7.5.2) WKR scanning FRQ

##### 1. Registration

```

- CH1 2187.5kHz : (Const)
- CH2 4207.5kHz : OFF
- CH3 6312.0kHz : ON
- CH4 8414.5kHz : (Const)
- CH5 12577.0kHz : ON
- CH6 16804.5kHz : OFF
0. Back

```

2. Press ENT, and set another frequency in addition to 2187.5 kHz and 8414.5 kHz to ON.

#### Note

In accordance with the SOLAS Convention, 2187.5 kHz and 8414.5 kHz cannot be turned OFF.

### 5.5.3 Disabling receiving alarms for routine and safety calls

The alarm for routine and safety calls can be disabled as follows.

#### ■ Procedure ■

To disable the receiving alarms for routine and safety calls, set 3. Safety/Routine alarm to OFF with the jog dial.

### 5.5.4 Using medical/neutral settings for urgency calls

Set the condition so that an urgency area call containing the additional subject of either "Medical transportation" or "Neutral nationality" can be sent. Additionally, note that this setting returns to the default setting (OFF) if the power is turned off.

#### ■ Procedure ■

To use these kinds of calls, set 4. Medical/Neutral use condition to ON with the jog dial.

### 5.5.5 Registering the ship's group ID

Register the group ID (group ship ID number) for receiving group calls.

#### ■ Procedure ■

Register the group ID at 5. Group ID using a 9-digit number (leftmost digit fixed to 0).

## 5.6 Setting connections for options

When setting connections between the controller and optional devices, such as a printer, configure the conditions as appropriate according to the device type, as follows.

### ■ Procedure ■

1. Press the **MENU** key, and through hierarchical menus, select 7.6 Option.

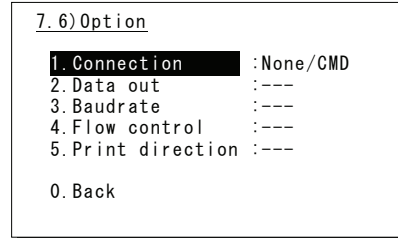

2. Move the cursor to the desired item, and press ENT.

Move the cursor to the right. Then select the condition as appropriate and press ENT.

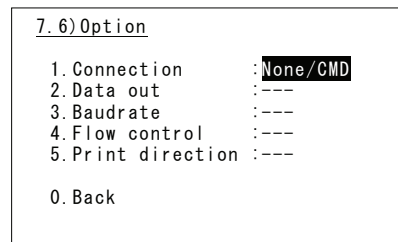

**Note** - The content and the selectable conditions of each item are as follows.

Item Name	Content	Selectable conditions ( <input type="checkbox"/> : Factory default)
Connection	Connection status and printer type	<input checked="" type="checkbox"/> None/CMD/ <input type="checkbox"/> Serial PRN/ <input type="checkbox"/> NKG-800/ <input type="checkbox"/> EXT MODEM
Data out	Printing method for DSC messages	<input checked="" type="checkbox"/> / <input type="checkbox"/> Auto/ <input type="checkbox"/> Manual
Baudrate	Transmission speed to printer	<input checked="" type="checkbox"/> / <input type="checkbox"/> 4.8k/ <input type="checkbox"/> 9.6k/ <input type="checkbox"/> 38.4k/ <input type="checkbox"/> 57.6kbps
Flow control	Handshake setting with printer	<input checked="" type="checkbox"/> / <input type="checkbox"/> None/ <input type="checkbox"/> Hard
Print direction	Printing sequence of lines	<input checked="" type="checkbox"/> / <input type="checkbox"/> Upright/ <input type="checkbox"/> Invert

- When connecting a serial printer (e.g. NKG-91), set the items as follows:
  - 1.Connection :Serial PRN
  - 2.Data out :Auto
  - 3.Baudrate :4.8k
  - 4.Flow control :Hard
  - 5.Print direction :Invert (NKG-91)/Upright (DPU-414)
- When connecting the NKG-800 printer, set the items as follows:
  - 1.Connection :NKG-800
  - 2.Data out :Auto
- If no option is connected, select None/CMD at the Connection.  
 Note) When None/CMD is set, connect nothing to the serial port.
- Other items are fixed to "---" when the Connection is set to EXT MODEM.
- Only one printer can be connected to the equipment. If the Connection is set to Serial PRN or NKG-800 on another controller, selectable items of the Connection are restricted either None/CMD or EXT MODEM.



## 6. MAINTENANCE & INSPECTION

The performance and lifetime of the equipment depend on appropriate maintenance. This chapter describes an outline of maintenance and inspection, self diagnosis and troubleshooting.

### 6.1 General maintenance & inspection

In order to operate the equipment under optimum conditions, it is vital to perform regular inspections and also, to keep accurate records. Inspections enable problems to be identified before they become major malfunctions. The following inspections should be made regularly.

Inspection sequence	Inspection item	Procedure
1	Antenna system	Check that antennas and the connectors are secure.
2	RF GAIN function	In the radiotelephone mode (TEL), turn the RF GAIN control on the controller having access rights. Is the radio static (noise) from the speaker adjustable?
3	Receiver condition check by speaker output	Check that the voice level and noise level are not abnormally loud or soft.
4	Handset PTT switch	In the radiotelephone (TEL) mode, press the PTT switch, and check that the unit transmits immediately on the Tx meter or by <b>TX</b> and <b>TXON</b> displayed on the screen.
5	Transmission and reception check by performing radio communication	In the radiotelephone (TEL) mode, check that normal conversation is possible.

## 6.2 Self diagnosis inspection

The following describes the procedure for performing self diagnosis in the 6.1 Self diagnosis menu.

### ■ Procedure ■

1. Press **FUNC** → **8TEST**.

The 6.1 Self diagnosis menu is displayed.

```
6.1)Self diagnosis
1. Transceiver
2. Controller
3. Transceiver log
4. Controller log
5. DSC loop
0. Back
```

2. Select Transceiver, Controller, or DSC loop.

- When Transceiver is selected, the screen at right is displayed.
- For DSC loop, a shortcut menu for diagnosing the modem is as shown in the screen at right.

```
6.1.1)Transceiver
Target :ALL
- ATU -
1. Serial I/F :
2. Band1-Input :
3. Band1-Tune :
4. Band2-Input :
5. Band2-Tune :
6. Band3-Input :
7. Band3-Tune :
```

3. In the above screen, press ENT, select the diagnosis mode with the jog dial, and press ENT. Self diagnosis is performed.

The following test modes are available:

- 6.1.1) Transceiver ... ALL (all modes)
  - TRX&MODEM
  - PA&ATU
  - WKR MODEM
  - TRX
  - PA
  - ATU
- 6.1.2) Controller..... ALL (all modes)
  - DGT CKT
  - AF output
  - LCD&LED
  - Speaker
  - Printer

```
6.1.1)Transceiver
Target :TRX&MODEM
- ATU -
1. Serial I/F :
2. Band1-Input :
3. Band1-Tune :
4. Band2-Input :
5. Band2-Tune :
6. Band3-Input :
7. Band3-Tune :
```

```
6.1.1)Transceiver
Target :ATU
- ATU -
1. Serial I/F :OK
2. Band1-Input :Checking
3. Band1-Tune :
4. Band2-Input :
5. Band2-Tune :
6. Band3-Input :
7. Band3-Tune :
```

- Note**
- If the jog dial is turned while the cursor is at Target when Transceiver is selected, the diagnosis items of each unit and previous diagnosis results can be browsed.
  - To cancel self diagnosis midway, press the **CANCEL** key.
  - The results of the self diagnosis are stored as a log, and up to 10 logs can be confirmed from the 6.1.3 Transceiver log or 6.1.4 Controller log menu.
  - The self diagnosis results are printed out to the connected printer.
  - The self diagnosis test contents and results are as shown below.

Unit Name	Test Item	Contents	Results
Transceiver	ATU	<ul style="list-style-type: none"> <li>• Serial I/F :Serial communication</li> <li>• Band1-Input :2140 kHz input value</li> <li>• Band1-Tune :2140 kHz tuning operation</li> <li>• Band2-Input :4149 kHz input value</li> <li>• Band2-Tune :4149 kHz tuning operation</li> <li>• Band3-Input :6230 kHz input value</li> <li>• Band3-Tune :6230 kHz tuning operation</li> <li>• Band4-Input :8297 kHz input value</li> <li>• Band4-Tune :8297 kHz tuning operation</li> <li>• Band5-Input :16546 kHz input value</li> <li>• Band5-Tune :16546 kHz tuning operation</li> <li>• Band6-Input :25118 kHz input value</li> <li>• Band6-Tune :25118 kHz tuning operation</li> </ul>	OK: Normal NG: Abnormal
	PA	<ul style="list-style-type: none"> <li>• PA mute port :Confirmation of PA diagnosis viability</li> <li>• RBK port :RBK overcurrent detection</li> <li>• Memory1 :EEPROM1 operation</li> <li>• Memory2 :EEPROM2 operation</li> <li>• Band1-Output :2140 kHz output</li> <li>• Band2-Output :4149 kHz output</li> <li>• Band3-Output :6230 kHz output</li> <li>• Band4-Output :8297 kHz output</li> <li>• Band5-Output :16546 kHz output</li> <li>• Band6-Output :25118 kHz output</li> <li>• Input voltage :Input signal from TRX</li> </ul>	OK: Normal NG: Abnormal
	TRX	<ul style="list-style-type: none"> <li>• Memory :EEPROM operation</li> <li>• Digital CKT :FPGA operation</li> <li>• BK port :BK signal state</li> <li>• PLL lock :State of PLL for DDS/DUC clock</li> <li>• Band1-TX output :1600 kHz output</li> <li>• Band2-TX output :22000 kHz output</li> <li>• Band3-TX output :27500 kHz output</li> <li>• Band4-TX output :RX diagnosis circuit</li> <li>• Band1-RX BPF1 :1600 kHz Rx level</li> <li>• Band2-RX BPF2 :390 kHz Rx level</li> <li>• Band3-RX BPF3 :1590 kHz Rx level</li> <li>• Band4-RX BPF4 :3190 kHz Rx level</li> <li>• Band5-RX BPF5 :6090 kHz Rx level</li> <li>• Band6-RX BPF6 :10790 kHz Rx level</li> <li>• Band7-RX BPF7 :17990 kHz Rx level</li> <li>• Band8-RX BPF8 :27500 kHz Rx level</li> </ul>	OK: Normal NG: Abnormal
	WKR MODEM	<ul style="list-style-type: none"> <li>• Memory1 :FROM operation</li> <li>• Memory2 :EEPROM operation</li> <li>• Memory3 :SDRAM operation</li> <li>• PLL lock :State of PLL for DDS clock</li> <li>• Band1-RX BPF1 :2187.5 kHz DSC loop</li> <li>• Band2-RX BPF2 :4207.5 kHz DSC loop</li> <li>• Band3-RX BPF3 :6312.0 kHz DSC loop</li> <li>• Band4-RX BPF4 :8414.5 kHz DSC loop</li> <li>• Band5-RX BPF5 :12577.0 kHz DSC loop</li> <li>• Band6-RX BPF6 :16804.5 kHz DSC loop</li> <li>• Band7-RX BPF7 :Wide-band filter operation</li> <li>• Loop test1 :AF DSC loop</li> <li>• Loop test2 :AF DSC&amp;TRX loop</li> </ul>	OK: Normal NG: Abnormal

Maintenance & Inspection

Unit Name	Test Item	Contents	Results
Controller	DGT CKT	<ul style="list-style-type: none"> <li>• Memory1 :FROM operation</li> <li>• Memory2 :EEPROM operation</li> <li>• Memory3 :SDRAM operation</li> </ul>	OK: Normal NG: Abnormal
	AF output	AF connection to TRX	OK: Normal NG: Abnormal
	LCD&LED	Screen and ALM lamp display operation Note: Check visually if every dot and red and green ALM lamp alternately work normally for 3 seconds.	DONE
	Speaker	Sound test Note: Check if the 1500 Hz tone sounds correctly. After that, press ENT on the popup screen to finish this process.	DONE
	Printer	Print out test Note: When the printer is connected, check the print result in the printed data output.	DONE

## 6.3 System alarm indication

This equipment displays alarms as follows when an internal or external error is detected.

Alarm information	
PA	:001, Overcurrent
PA	:008, High temperature

### Note

- To return to the previous screen after the alarm is displayed, press the **CANCEL** key.
- When the TRX 024.PLL unlock or WKR MODEM 030.PLL unlock alarm is occurring, that mark remains as shown below until the equipment is restored to normal conditions.

ID 431001234	TIME 23:59 (UTC)
Pos 89° 59.0123' N	
179° 59.6789' E@23:59	(EXT)
<b>TEL ITU-1201</b>	
RX 13077.0	kHz
TX 12230.0	kHz
SIG	
WKR scan bands:	<b>Un</b> lock
	<b>UNLOCK</b>

### 6.3.1 Alarm list

The following list shows the types of system alarms and contents when an alarm is detected on the equipment.

Alarm Number	Source Unit	Display	Contents	Troubleshooting Procedure
001	PA	Overcurrent	Detected an overcurrent (20 A or more) in the PA power supply.	Re-tune or operate on another frequency.
007	PA	SWR/Overload	Detected the condition SWR > 3.	Re-tune or operate on another frequency.
008	PA	High temperature	Detected an out-of-range temperature (110°C or more) at the radiator.	Stop transmission, or reduce output.
010	PA	RBK overcurrent	Detected RBK overcurrent.	<i>Please contact JRC or our agency.</i>
055	PA	24V low voltage	Detected a drop (12V or less) in the PA power supply voltage.	<i>Please contact JRC or our agency.</i>
091	PA	EEPROM	Detected a memory error.	<i>Please contact JRC or our agency.</i>
017	ATU	ATU lost	Detected a serial communication error with the tuner.	<i>Please contact JRC or our agency.</i>
018	ATU	High voltage	Detected a high voltage (3.5 kV or more) in antenna output.	Re-tune, or reduce output.
019	ATU	High temperature	Detected an out-of-range temperature (70°C or more) inside the enclosure.	Stop transmission, or reduce output.
020	TRX	DISP_KEY	Detected abnormal ON signal at the PTT or Ext key of the controller.	<i>Please contact JRC or our agency.</i>
021	TRX	EXT_KEY	Detected abnormal ON signal at the transceiver external key.	<i>Please contact JRC or our agency.</i>
022	TRX	SEL_BK	Detected abnormal ON signal at the Selcall key on the transceiver.	<i>Please contact JRC or our agency.</i>
023	TRX	-BK	Detected the -BK output error during transmission.	<i>Please contact JRC or our agency.</i>
024	TRX	PLL unlock	Detected PLL unlock for the DDS or DUC clock.	<i>Please contact JRC or our agency.</i>
030	WKR MODEM	PLL unlock	Detected PLL unlock for the DDS clock.	<i>Please contact JRC or our agency.</i>
031	WKR MODEM	MCDSP WDT	Detected MCDSP malfunction.	<i>Please contact JRC or our agency.</i>
032	WKR MODEM	VDSP WDT	Detected VDSP malfunction.	<i>Please contact JRC or our agency.</i>
033	WKR MODEM	MMSI lost	Detected non-registration or loss of the ship's MMSI.	<i>Please contact JRC or our agency.</i>
094	WKR MODEM	Memory	Detected a memory error.	<i>Please contact JRC or our agency.</i>
035	Controller	CTRL1 RBK OC	Detected an overcurrent on the RBK circuit of controller 1.	<i>Please contact JRC or our agency.</i>
036	Controller	CTRL1 PTT	Detected an error on the PTT control line of controller 1.	<i>Please contact JRC or our agency.</i>
037	Controller	CTRL1 CW KEY	Detected an error on the CW key control line of controller 1.	<i>Please contact JRC or our agency.</i>
038	Controller	CTRL1 EXT KEY	Detected an error on the external key control line of controller 1.	<i>Please contact JRC or our agency.</i>
039	Controller	CTRL2 RBK OC	Detected an overcurrent on the RBK circuit of controller 2.	<i>Please contact JRC or our agency.</i>
040	Controller	CTRL2 PTT	Detected an error on the PTT control line of controller 2.	<i>Please contact JRC or our agency.</i>
041	Controller	CTRL2 CW KEY	Detected an error on the CW key control line of controller 2.	<i>Please contact JRC or our agency.</i>
042	Controller	CTRL2 EXT KEY	Detected an error on the external key control line of controller 2.	<i>Please contact JRC or our agency.</i>
047	Controller	PA lost	Detected a serial communication error with the PA.	<i>Please contact JRC or our agency.</i>
048	Controller	TRX lost	Detected a serial communication error with the TRX.	<i>Please contact JRC or our agency.</i>

050	Controller	MODEM lost	Detected a serial communication error with the WKR MODEM.	<i>Please contact JRC or our agency.</i>
051	Controller	CTRL1 lost	Detected a serial communication error with the No.1 controller.	<i>Please contact JRC or our agency.</i>
052	Controller	CTRL2 lost	Detected a serial communication error with the No.2 controller.	<i>Please contact JRC or our agency.</i>
095	Controller	CTRL1 memory	Detected a memory error on the No.1 controller.	<i>Please contact JRC or our agency.</i>
096	Controller	CTRL2 memory	Detected a memory error on the No.2 controller.	<i>Please contact JRC or our agency.</i>

Also, the following alarms are displayed when an error is detected just after turning on the equipment. Please notify JRC or our agency of the details of the alarm.

Display	Contents
Detected this controller's barcode number lost! So required to replace the CONTROL UNIT in it with the new one.	Detected an error in the barcode number on the controller.
Detected this controller's SIO error! So required initial set after restarting as the maintenance mode.	Detected a communication error between the controller and transceiver at startup.
Detected this controller's address setting error! So required initial set after restarting as the maintenance mode.	Detected this controller's address error when starting the controller.
Detected MMSI lost! So concerned DSC functions no longer available now.	Unregistered MMSI, or lost the MMSI.
Detected PA UNIT lost or this controller's SIO error! So required initial set after restarting as the maintenance mode.	Detected malfunction of the PA unit or communication error on the controller.
Detected TRX UNIT lost! So concerned all functions no longer available now.	Detected TRX unit malfunction.

**6.3.2 Viewing the alarm history**

The following describes how to view alarm information detected by the equipment or a history of past occurring alarms in the 6.2 Alarm information menu.

**■ Procedure ■**

1. Press the **MENU** key, and through hierarchical menus, select 6.2 Alarm information.

One of the screens shown at right is displayed indicating if an alarm is occurring.

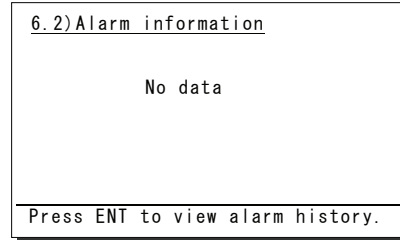

(If there is no alarm)

**Note** The displayed alarm information is formatted as follows.

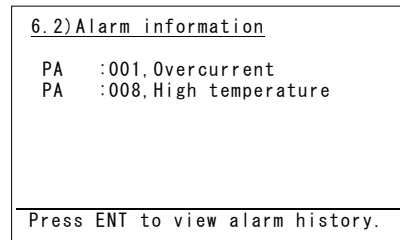
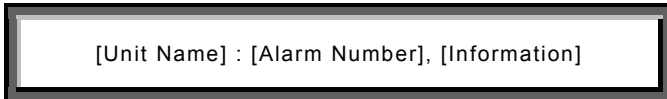

(If there is an alarm)

2. To check the alarm history, press ENT. The popup screen at right is displayed, select OK.

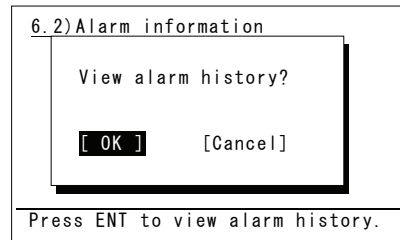

3. The alarm history is displayed. Up to 100 of the latest histories are stored. If necessary, scroll with the jog dial.

**Note** The displayed alarm history is formatted as follows.

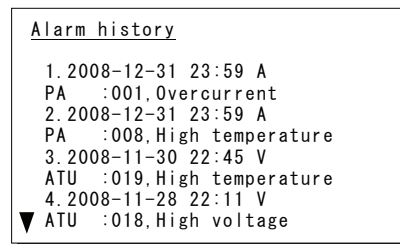
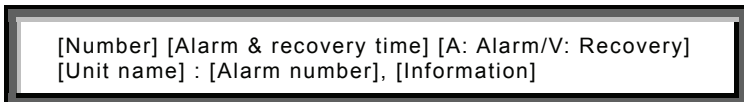



## 6.4 Software version

To view the version of the software currently running on the equipment, press the **MENU** key, and display 6.3 Software version in the menu list.

The software version of the transceiver and controller are displayed as shown at right.

6.3) Software version	
- Controller	: 1.00
- WKR MODEM	: 1.00
- TRX	: 1.00
- PA	: 1.00
- ATU	: 1.00
<b>0. Back</b>	

## 6.5 Troubleshooting

### WARNING



This equipment is used for both distress communication and routine communication. Contact JRC or our agent if any problem is observed in this unit during routine operation or inspection.



Do not open the equipment to inspect or repair internal circuits. Inspection or repairs by anyone other than a specialized technician may result in fire, electrical shock, or malfunction. If internal inspection or repair is necessary, contact our service center or agents.

### 6.5.1 Procedures for locating malfunctions

- 1) First, check the power supply voltage and connectors.
- 2) If there are no problems with the above, use a tester to check for errors.

The following table shows the instruments required for performing repairs and the severity of the malfunctions. If the user is to locate the malfunction himself, perform only No. 1 and No. 2.

No.	Type of Malfunction	Examples
1	Faults requiring no instrument to locate	<ul style="list-style-type: none"> <li>• Faulty connector contacts</li> <li>• Broken antenna cables</li> <li>• Defective switches, controls, etc.</li> <li>• Other problems that can be visually detected</li> </ul>
2	Malfunctions that can be discovered and repaired with a tester	<ul style="list-style-type: none"> <li>• Confirmation of power supply voltage</li> <li>• Breaks in external wiring</li> </ul>
3	Malfunctions requiring special instrument	<ul style="list-style-type: none"> <li>• Fan malfunction in transceiver and ATU enclosure fan</li> <li>• Crystal oscillator frequency deviation</li> <li>• Decrease in transmitting power and reception sensitivity</li> <li>• Decrease in transmitter modulation level</li> <li>• Malfunction in semiconductors, ICs, and similar devices</li> </ul>

### 6.5.2 Guide to locating faults

Use the following table as a guide to locating the causes of malfunctions in the equipment. Also, when contacting JRC or our agency, please notify us of the malfunction conditions.

No.	Symptom	Typical causes
1	Nothing is displayed on the controller screen.	<ul style="list-style-type: none"> <li>• Malfunction in the controller cable</li> <li>• Abnormal power supply voltage</li> <li>• Malfunction in the power switch, display circuit or control circuit</li> </ul>
2	<b>TX</b> and <b>TXON</b> is displayed but no voice is transmitted in the TEL mode.	<ul style="list-style-type: none"> <li>• Malfunction in the handset</li> <li>• Malfunction in the controller cable</li> <li>• Malfunction in the AF signal transmission circuit</li> </ul>
3	<b>TX</b> is displayed but <b>TXON</b> is not, and transmission is not possible.	<ul style="list-style-type: none"> <li>• Malfunction in the transmission circuit</li> </ul>
4	<b>TX</b> and <b>TXON</b> are displayed, and transmission is not possible.	<ul style="list-style-type: none"> <li>• Malfunction in the handset PTT switch (TEL mode)</li> <li>• Malfunction in the electrical key connection (CW mode)</li> <li>• Malfunction in the transmission circuit</li> </ul>
5	Reception sensitivity is poor.	<ul style="list-style-type: none"> <li>• Antenna damage</li> <li>• Break or short circuit of antenna cable</li> <li>• Malfunction in the antenna connectors</li> <li>• Malfunction in the receiver circuit</li> </ul>
6	Little or no sound from the speaker, both static and voices.	<ul style="list-style-type: none"> <li>• Malfunction in the speaker</li> <li>• Malfunction in the receiver circuit</li> </ul>
7	Radio static (noise) is output from the speaker, but cannot receive transmissions from other stations.	<ul style="list-style-type: none"> <li>• Antenna damage</li> <li>• Break or short circuit of antenna cable</li> <li>• Malfunction in the antenna connectors</li> <li>• Malfunction in the receiver</li> </ul>

**Note** The following are not faults.

Symptom	Possible Causes	Handling
The VOL control, the dimmer, and PWR key on the controller can be operated, but the radiotelephone functions such as the RG GAIN control cannot be operated.	Multiple controllers are connected, and another controller has access rights.	Press ENT to obtain access rights, and after that, retry the operation.
No response from other station via radiotelephone or DSC call.	No operator in that station, or unavailable to respond due to other duties.	Wait and retry later.
When multiple controllers are connected, access rights cannot be obtained by pressing ENT on a monitor controller.	Another controller with higher priority is in use for communicating or is performing menu operations.	After operations on the other controller are finished, obtain access rights.
If the system is left on a screen other than the status display for a while, the screen returns to the status display.	After 10 minutes of leaving the system on a menu screen, the inactivity timer is activated and the screen returns to the status display. (By ITU-R M.493-11 recommendation)	Do not leave the equipment during menu operation.
The received distress call log has been erased without operation.	Automatically deleted the received distress calls which are 48 hours old after that reception. (Regulated by IMO A.806(19)) Or the equipment had been turned off by such as the breaker on the transceiver.	Print and save received messages if necessary.

### 6.5.3 Consumables

The following shows consumables. Please contact JRC or our agency to order parts.

Location	Description	Model (Part number)	Replacement Guide
NKG-91 PRINTER	Printer paper	7ZPJD0384	Indicating red mark on the paper edge
DPU-414 PRINTER	Printer paper	6ZCAF00252A	Indicating red mark on the paper edge
NKG-800 PRINTER	Printer paper	5ZPCM00006	Indicating red mark on the paper edge
	Ink ribbon (SP-16051)	5ZZCM00003	When print becomes light

### 6.5.4 Repair units/parts

The repair units and replacement part units are as follows.

#### ● NTD-2150 MF/HF TRANSCEIVER

Description	Model (Part number)	Notes
PA UNIT	CAH-2415	
TRX UNIT	CMN-2250	
WKR MODEM UNIT	CMJ-2250	
POWER SUPPLY	CBD-2415	
TERMINAL UNIT	CQD-2415	
EXTENSION BOARD	CQD-2416	Options

#### ● NCM-2150 MF/HF CONTROLLER

Description	Model (Part number)	Notes
CONTROL UNIT	CDJ-3775	
AF CONT UNIT	CMV-3775	
LCD UNIT	CDE-3770	
MAIN PANEL UNIT	CCK-3775	
SUB PANEL UNIT	CCK-3776	
SPEAKER	7USJD0007	
CONTROLLER CABLE	7ZCJD0343	Control cable (5 m)

#### ● NFC-2150 ANTENNA TUNER

Description	Model (Part number)	Notes
MATCHING UNIT	CFG-2150	

### 6.5.5 Regular replacement parts

The following shows parts that need to be replaced regularly. Please contact JRC or our agency to order parts.

Description	Model (Part number)	Replacement Period
Cooling fan	3108NL-05W-B50-L09	Approx. 50,000 hours of use at room temperature
LCD unit	CDE-3770	Approx. 20,000 hours of continued use at maximum brightness

## 7. AFTER-SALES SERVICE

### ★ Warranty

The **warranty period** is determined by JRC's warranty regulations, but is normally 1 year from the date of purchase.

### ★ Repair Part Inventory Period

Parts necessary for proper functioning of this equipment will be kept available for 10 years after product discontinuation.

### ★ When Requesting Repairs

If what appears to be a defect is detected, refer to "6.5 Troubleshooting" to check if the equipment is actually defective.

If the problem is due to a defect, immediately stop use of the system and contact the store where you purchased the system, or one of our branches.

- **During the warranty period**, if a malfunction occurs with the equipment while in standard usage in accordance with this instruction manual, we or our agencies will repair the malfunction at no charge at the store where the equipment was purchased or another location specified by JRC. If the malfunction occurs due to improper usage, fault, or any external abnormal condition such as fire, pollution, abnormal voltage, natural disaster (ex. thunder storms, earthquake) etc., JRC will repair the equipment for a fee. Furthermore, regardless of the warranty period, orders of consumables will be charged.
- **After the warranty expires**, we will repair the malfunction for a fee, if repair is possible.
- **Please inform us of the following**:
  - ☆ Product name, model name, manufactured date, serial number
  - ☆ As much information as you can provide about the malfunction (alarm number, whether transmission is possible or not, etc.)
  - ☆ Your company or organization name, address, and phone number

### ★ Periodical Maintenance Recommendation

Depending on the usage conditions, with extended use, the performance of this equipment may degrade over time, and externally installed parts such as the antenna may degrade due to vibration, so we recommend periodical maintenance in addition to the standard maintenance.

Please contact the store where you purchased the equipment, or one of our branches, to request periodical maintenance.

Periodical maintenance requires a service charge.

If you have any questions regarding after-sales service, please contact the store where you purchased the equipment, or one of our branches.

Refer to the inside of the back cover for contact numbers and locations.

## **8. DISPOSAL**

Observe all rules and regulations of the local authorities when disposing of this equipment.

## 9. SPECIFICATIONS

### 9.1 JSS-2150 150W MF/HF Radio Equipment

#### ● General Specifications

Transmission frequency	1605.0 - 27500.0 kHz (100 Hz steps)
Reception frequency	90.0 - 29999.9 kHz (100 Hz steps)
Frequency stability	Within $\pm 10$ Hz
Type of emission	TEL mode : J3E DSC mode : F1B CW mode : A1A AM mode : H3E H2B mode : H2B DATA mode : J2D
Channels	User definable channels : Max. 400 ch (20 channels x 20 groups) ITU preset channels : 831 ch
Scan channels	Max. 20 channels (group specification method)
Nominal frequency	J3E/ A1A/ H3E/ H2B/ J2D : Carrier frequencies F1B : Assigned frequency
Communication method in TEL	Push-to-talk (simplex, semi-duplex)
Antenna impedance	50 $\Omega$ unbalanced
Channel switching duration	15 sec or less
Interface	IEC61162-1 (GPS/AME/RMS)
Compass safety distance	1.9 m
Main controls	DSC call (sending and receiving), communication frequency/ channel settings, Tx power settings, RF gain adjustment, volume adjustment, LCD adjustment
Performance criteria	IMO A.806(19), A.694(17), MSC68(68), MSC/Circ.862
Power supply voltage	24 VDC (21.6 VDC to 31.2 VDC)
Current consumption	150W transmission : Maximum 30 A Reception: : Maximum 5 A
Operating temperature range	-15°C - +55°C (parts exposed to condensation -25°C - +55°C)
Storage temperature range	-15°C - +55°C (parts exposed to condensation -25°C - +70°C)
Humidity resistance	No abnormality after standing 4 hours in +40°C, 93%RH
Vibration resistance (3 axes)	2 Hz - 5 Hz to 13.2 Hz : Full amplitude $\pm 1$ mm $\pm 10\%$ 13.2 Hz to 100 Hz : Maximum acceleration 7 m/s <sup>2</sup> fixed  No abnormality after testing resonance points or at 30 Hz for 2 hours or more
Continuous operation (TEL)	No abnormality after operating continuously for 8 hours
Continuous operation (DSC, WKR)	No abnormality after operating continuously for 24 hours
Protection rating	IP22 equivalent (controller panel)
Dimensions and mass	Transceiver 349mm(W) x 391mm(H) x 143mm(D) [excluding projections], approximately 12.3kg Antenna tuner 256mm(W) x 430mm(H) x 100mm(D) [excluding projections], approximately 3.3kg Controller 230mm(W) x 142mm(H) x 89mm(D) [excluding projections], approximately 1.3kg

## Specifications

### ● Transmitter

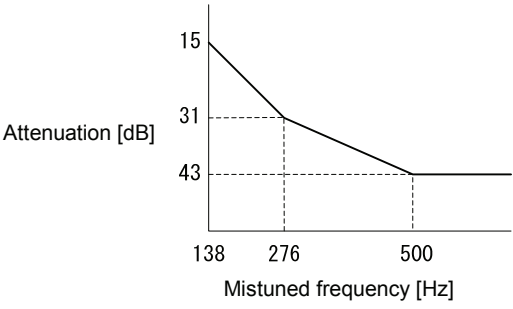
Antenna output power	1605.0 - 3999.9 kHz : 75/ 100Wpep 4000.0 - 27500.0 kHz : 75/ 100/ 150Wpep
Modulation method	Low-power stage balanced modulation
Occupied bandwidth	J3E/ J2D/ H2B : Within 3 kHz F1B/ A1A : Within 0.5 kHz
Carrier suppression (J3E)	40 dB or more
Unwanted emissions in the out-of-band domain	Mean power of 50 mW or lower, or 43 dB or more lower than the mean power of the basic frequency
Unwanted emissions in the spurious domain	At J3E: 1.5 to 4.5 kHz : 31 dB or more 4.5 to 7.5 kHz : 38 dB or more 7.5 kHz and upwards : 43 dB or more (Peak power of unwanted emissions is 50 mW or less.)  At F1B: 
Overall distortion and noise	-20 dB or less
AF frequency response	Deviation is within 6 dB in 350 Hz to 2700 Hz range.
Tone frequency	1500 Hz or 1400 Hz

### ● Receiver

Receiving system	Double superheterodyne
1st IF	70.036 MHz
2nd IF	36 kHz
Reception frequency stability	Within $\pm 10$ Hz
Sensitivity (SINAD 20dB)	J3E : 2.5 $\mu$ V or less (1605.0 to 27500.0 kHz) F1B : 0.7 $\mu$ V or less (1605.0 to 27500.0 kHz) A1A : 1.4 $\mu$ V or less (1605.0 to 27500.0 kHz)
Pass band/Adjacent signal selectivity	J3E : 2.4 - 3.0 kHz (6 dB bandwidth) within $\pm 2.1$ kHz (66 dB bandwidth) F1B : 270 - 300Hz (6 dB bandwidth) within $\pm 550$ Hz (60 dB bandwidth)
Spurious response	J3E : 60 dB or more F1B : Symbol error rate of 1% or better at a wanted signal level of 10 $\mu$ V and an unwanted signal level of 31.6 mV separated by 750 Hz
Blocking/Desensitization	J3E : When an unwanted signal level separated by 3 kHz is added to the wanted signal level of 10 $\mu$ V, the unwanted signal input voltage suppressing output of the wanted signal by 3 dB is 10 mV or more. F1B : Symbol error rate of 1% or better at a wanted signal level of 10 $\mu$ V and an unwanted signal level of 1 mV separated by 500 Hz
Overall distortion and noise	When an input signal level of 30 $\mu$ V is applied, the ratio between low-frequency output 1000 Hz and unwanted components contained in that output is 30 dB or more.
Conducted spurious emission	Power emitted from antenna terminal is 2 nW or less (9kHz - 2GHz) and 20 nW or less (2GHz - 4GHz).
Clarifier variable range	$\pm 200$ Hz (1 Hz steps)
Antenna impedance	50 $\Omega$ unbalanced
Line output	0 dBm 600 $\Omega$ (balanced)



● DSC Watch Keeping Receiver

Reception frequency	Distress and safety frequencies of 2187.5 kHz and 8414.5 kHz, and additionally on one or more of the 4207.5 kHz/ 6312.0 kHz/ 12577.0 kHz/ 16804.5 kHz
Receiving system	Double superheterodyne
1st IF	40.04025 MHz
2nd IF	40.25 kHz
Frequency stability	Within $\pm 10$ Hz
Sensitivity	1% or lower symbol error rate at reception input voltage of $1\mu\text{V}$
Passband	6 dB bandwidth : 270 - 300 Hz 30 dB bandwidth : Within $\pm 380$ Hz 60 dB bandwidth : Within $\pm 550$ Hz
Spurious response	Symbol error rate of 1% or better when an unwanted signal level of 31.6 mV is applied to a wanted signal level of 10 $\mu\text{V}$ from an intermediate frequency separated by 750 Hz or more through to a frequency 3x the test frequency
Blocking/Desensitization	Symbol error rate of 1% or better at a wanted signal level of 10 $\mu\text{V}$ and an unwanted signal level of 1 mV separated by 500 Hz
Conducted spurious emission	Power emitted from antenna terminal is 2 nW or less.
Antenna impedance	50 $\Omega$ unbalanced

● DSC Modem

Modulation rate	Within 100 baud $\pm 30 \times 10^{-6}$
Modulation method	FSK (sub-carrier: 1700 Hz)
Mark frequency (Y)	Transmission : Within 1615 Hz $\pm 0.5$ Hz Reception (permissible value) : Within 1615 Hz $\pm 20$ Hz
Space frequency (B)	Transmission : Within 1785 Hz $\pm 0.5$ Hz Reception (permissible value) : Within 1785 Hz $\pm 20$ Hz
DSC protocol	ITU-R recommendation M.493-11 (Class A and B)
DSC operation standards	ITU-R recommendation M.541-9, M.821-1
DSC code	10-bit error detecting code
Message storage	20 messages for distress and 20 messages for others

● Antenna tuner

Frequency range	1605.0 - 27500.0 kHz
Max. input power	1605.0 - 3999.9 kHz : 150W <sub>pep</sub> 4000.0 - 27500.0 kHz : 200W <sub>pep</sub>
SWR after tuning	2:1 or less
Tuning method	Preset or auto-tuning
Tuning time	Preset tuning: 0.5 secs, auto-tuning: max. 45 secs
Power supply	24 VDC (21.6 VDC to 31.2 VDC)

● Controller

Communication speed	57.6 kbps
Communication interface	RS-485 and RS-232C, and Centronics compliant
Microphone input impedance	150 $\Omega$ balanced
Standard modulation input	-54 dBm
Audio output	Internal loud speaker (8 $\Omega$ ) : 5W max External speaker impedance : 8 $\Omega$ or more Handset phone (150 $\Omega$ ) : Rated 1mW or more
LCD display	3.8 inch FSTN monochrome, 320 x 240 dot, LED backlight

## 9.2 Options

### (1) AC/DC Power supply (NBD-2150)

Source voltage	90 VAC - 132 VAC or 180 VAC to 264 VAC (50/60 Hz) and 24 VDC (21.6 VDC to 31.2 VDC)
Output voltage	24 VDC (19.0 VDC to 34.0 VDC)
Maximum output current	30 A
Source switching function	Automatic switching to DC power when AC power is cut off. (uninterrupted output) Automatic switching from DC to AC when AC power is restored.
Alarm notification functions	AC power OFF, low battery voltage
Temperature range for full performance	-15°C - +55°C
Operating temperature range	-15°C - +55°C
Storage temperature range	-25°C - +65°C
Humidity resistance	No abnormality after standing 4 hours in +40°C, 93% RH
Vibration resistance (3 axes)	2 Hz - 5 Hz to 13.2 Hz: : Full amplitude $\pm 1 \text{ mm} \pm 10\%$ 13.2 Hz to 100 Hz: : Maximum acceleration 7 $\text{m/s}^2$ fixed No abnormality after testing resonance points or at 30 Hz for more than 2 hours
Continuous operation	No abnormality after operating continuously for 8 hours

### (2) Battery charger (NBB-724)

Source voltage	90 VAC - 132 VAC or 180 VAC to 264 VAC (50/60 Hz)
Current consumption	Charging : 15 A or less (100 VAC input) 8 A or less (220 VAC input) Discharging : 0.5 A or less (at 24 VDC operation)
Charging current	Float charging : 20 A Balanced charging : 10 A
Alarm notification functions	Abnormal charging, low battery voltage
Temperature range for full performance	-15°C - +55°C
Operating temperature range	-15°C - +55°C
Storage temperature range	-25°C - +65°C
Humidity resistance	No abnormality after standing 4 hours in +40°C, 93% RH
Vibration resistance (3 axes)	2 Hz - 5 Hz to 13.2 Hz: : Full amplitude $\pm 1 \text{ mm} \pm 10\%$ 13.2 Hz to 100 Hz: : Maximum acceleration 7 $\text{m/s}^2$ fixed No abnormality after testing resonance points or at 30 Hz for more than 2 hours
Continuous operation	No abnormality after operating continuously for 8 hours

## (3) Printer (NKG-91)

Printing system	Thermal line dot
Communication interface	RS-232C, 4.8/9.6/38.4 kbps
Data control	RTS/CTS
Data buffer	4096 byte
Maximum print speed	20 mm/sec or more
Roll paper width	58 mm
Power supply voltage	6.5 VDC (5 VDC to 8.7 VDC)
Current consumption	Maximum 2 A

## (4) Printer (DPU-414)

Printing system	Thermal serial dot
Communication interface	RS-232C, 4.8k/9.6k/38.4 kbps
Data control	HW busy
Data buffer	About 28 Kbyte
Maximum print speed	52.5 cps
Roll paper width	112 mm
Power voltage	6.5 VDC
Current consumption	Maximum 2 A

## (5) Printer (NKG-800)

Printing system	Serial impact dot matrix
Communication interface	Centronics compliant
Supported fonts	ANK FX850 mode                      324 characters IBM Proprinter II mode              264 characters
Paper feed system	Roll paper holder
Paper type	209 - 216 mm (8.23 - 8.50") roll paper
Buffer size	ANK FX850 mode                      21 kbytes IBM Proprinter II mode              9.3 kbytes
Density adjustment	Manual (nonstepped)
Power supply voltage	10.2 VDC - 31.2 VDC
Power consumption	Maximum 35 W

## 9.3 Peripheral interfaces

### (1) GPS or other navigation aid interface

Interface standard	NMEA0183/IEC61162-1 compliant
Protocol	4800 bps, start 1 bit, data 8 bit, stop 1 bit Non parity
Input sentence	NMEA0183 V1.5: GGA/ GLL/ RMC V2.0: GGA/ GLL/ RMC/ ZDA V2.3: GGA/ GLL/ RMC/ GNS/ ZDA (Talker = "GP" or other)
Data type	Ship position & time information: GGA/ GNS/ GLL/ RMC Date information: ZDA/ RMC Equipment time information: ZDA/ GGA/ GNS/ GLL/ RMC

### (2) RMS interface

Interface standard	IEC61162-1 compliant
Protocol	4800 bps, start 1 bit, data 8 bit, stop 1 bit Non parity
Output message	IEC61162-1 compliant proprietary sentence \$PJRCL sentence (for RMS log saving) \$PJRCM sentence (Device ID = "CV")
Data type	Model number, serial number, self-diagnosis information, etc.

# 10. OPTIONS OPERATION

## 10.1 AC/DC Power supply (NBD-2150)

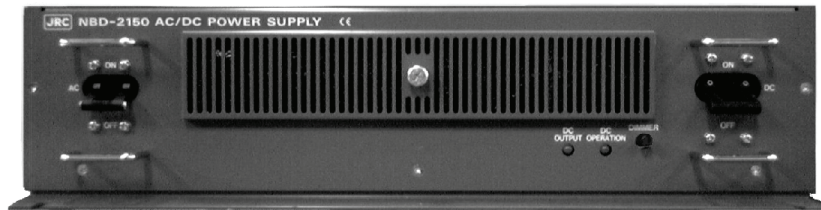

1. AC breaker
2. DC OUTPUT lamp
3. DC OPERATION lamp
4. Dimmer control
5. DC breaker



### ■ Procedure ■

1. Turn on the AC and DC breakers.

Turn on only the DC breaker when the AC input is not connected to the equipment.

2. Make sure that the DC OUTPUT lamp lights in green.

If this lamp is lit in green, this indicates that 24 V DC power is being output normally.

#### Note

- If only DC power is used, the DC OPERATION lamp lights. Be careful not to discharge the battery too much.
- If the DC OUTPUT lamp lights in red when the AC breaker is turned on, there may be abnormal condition or a malfunction with the AC power circuit as follows.
  - Input/Output overvoltage
  - Input/Output low voltage
  - Overcurrent
  - Failure of this unit

Additionally note that the DC power is output when the DC OPERATION lamp lights as mentioned above.

## 10.2 Battery charger (NBB-724)

### ⚠ CAUTION



The batteries, except for sealed lead-acid batteries that require no equalization, should be carried out the equalizing charge at least every six months

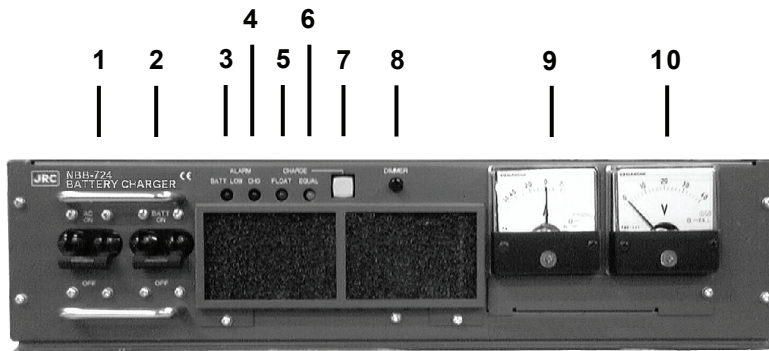

1. AC breaker ..... When turned on, enables to use the AC mains input.
2. BATT breaker ..... When turned on, connects the internal circuit to the battery, and after that turning on the AC breaker enables charging of the battery. Note that if detected over discharge of the battery (approx. 19.5V), this breaker trips automatically.
3. BATT LOW alarm lamp ... This lamp turns on and the buzzer sounds to indicate low voltage of the battery (approx. 21.5V).
4. CHG alarm lamp ..... This lamp turns on (or blinks\*) and the buzzer sounds to indicate any one of the following alarms.
  - The BATT breaker is OFF while the AC breaker is ON.
  - Over voltage (equalizing charge voltage + 1.0V)
  - High temperature of the charging circuit (+75°C) \*
5. FLOAT charge lamp ..... This lamp turns on during the floating charge operation.
6. EQUAL charge lamp ..... This lamp turns on during the equalizing charge operation.
7. CHARGE mode switch.... Changes the charge mode between floating and equalizing charge.
8. Dimmer control ..... Adjust the dimmer level.
9. Current meter ..... Indicates the charge current (+) or discharge current (-).
10. Voltage meter ..... Indicates the output voltage of the battery.

## (1) Charging a battery in the floating mode

---

### ■ Procedure ■

Turn the AC and BATT breakers on.

- FLOAT lamp turns on during the floating charge operation.
- When turning on the AC breaker prior to BATT breaker, CHG alarm lamp turns on and the buzzer sounds. But this is not malfunction as mentioned above.

## (2) Charging a battery in the equalizing mode

---

### ■ Procedure ■

#### 1. Turn the AC and BATT breakers on.

Make sure FLOAT lamp is turned on and the battery charge is started in the floating mode.

#### 2. Press the CHARGE mode switch.

- The lighting lamp is changed from FLOAT to EQUAL to indicate operating in the equalizing mode.
- The charging mode can be switched between FLOAT and EQUAL alternately.

#### 3. When the equalizing charge is completed, returns to the floating mode automatically.

The equalizing charge is continued until the charge current goes down to approx. 3.0A or until 10 hours elapse.

#### Note

- The battery can be used as a secondary power source when the BATT breaker is ON while the AC breaker is OFF. However in this case, be sure not to cause over discharge condition.
- When any alarm is occurred, treat it as follows.
  - BATT LOW ..... Carry on charging. This alarm is cleared automatically after the battery voltage increases to approx. 23.5V.
  - BATT breaker OFF ..... Turn the BATT breaker on.
  - Over voltage ..... Turn off the AC and BATT breakers until the battery voltage returns to the normal condition.
  - High temperature ..... The built-in charging circuit is disconnected until the temperature returns to the normal condition (60°C or lower) automatically
  - Over discharge ..... When the BATT breaker trips, turn on the breakers in the order of AC and BATT so that the charge operation is restarted.

## 10.3 Printer (NKG-91)

### ⚠ CAUTION



The thermal head of the NKG-91 printer may be very hot after printing. Do not touch the thermal head of the printer. Make sure that the thermal head is cool before replacing the paper or cleaning the thermal head.



The paper used in the NKG-91 printer is heat sensitive. Take the following precautions when using this paper.

- Store the paper away from heat, humidity, or heat sources.
- Do not rub the paper with any hard objects.
- Do not place the paper near organic solvents.
- Do not allow the paper to come in contact with polyvinyl chloride film, erasers, or adhesive tape for long periods of time.
- Keep the paper away from freshly copied diazo type or wet process copy paper.

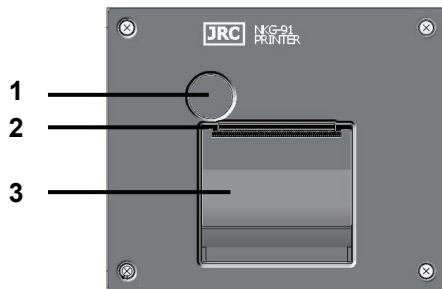

1. Paper cover open button
2. Paper cutter
3. Paper cover

### ■ Loading the printer paper ■

1. Press the paper cover open button.

The paper cover will open.

2. Insert the paper as shown in the diagram at right.

Position the paper such that the leading edge extends outside the printer, and press both sides of the paper cover to close it.

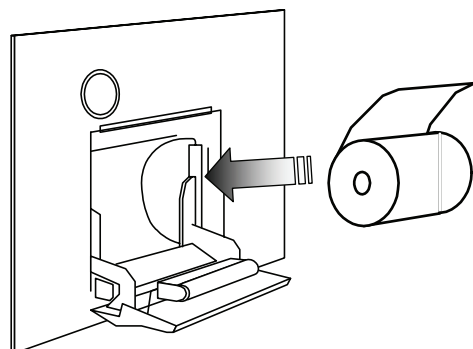

**Note**

The printer will be turned on and off simultaneously with the equipment.



## 10.4 Printer (NKG-800)

### ⚠ CAUTION



The print head of the NKG-800 printer may be very hot after printing. Do not touch the print head of the printer. Make sure that the print head is cool before replacing the paper or cleaning the print head.



Do not use the NKG-800 printer if there is no ink ribbon cartridge or paper. Do not twist the ink ribbon when installing the ink ribbon cartridge.



Before opening and closing the cover of the NKG-800 printer, turn off the printer. Wait more than 2 seconds after turning the printer off before turning it back on again so it can initialize correctly.

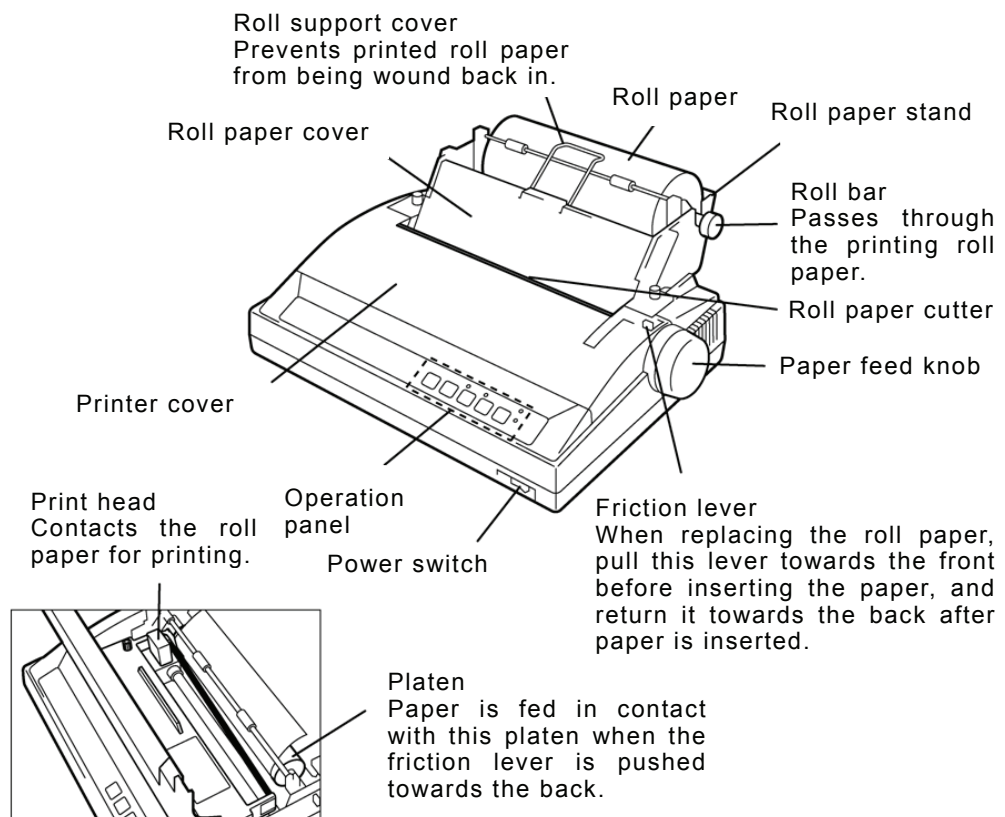

The following shows the functions of the operation panel.

P.PARK	FF	LF	NLQ	ONLINE
<b>Paper Park</b> Rewinds the roll paper.	<b>Feed Form</b> Feeds paper one page at a time.	<b>Line Feed</b> Feeds the paper one line at a time.	<b>High-quality Printing</b> Switches the printer to the high-quality printing mode.	<b>Printer Ready Setting</b> The printer is ready for printing when the lamp is lit.

Note 1: Before performing P.PARK/FF/LF/NLQ, press ONLINE to set the printer offline (lamp out).

Note 2: When the printer runs out of roll paper, the P.OUT lamp lights and the printer automatically goes offline.

## ■ Loading the printer paper ■

1. Turn the printer OFF, loosen the roll paper stand fixing screws, and slide the stand backwards to open the printer cover.

At this step, also remove the roll paper cover.

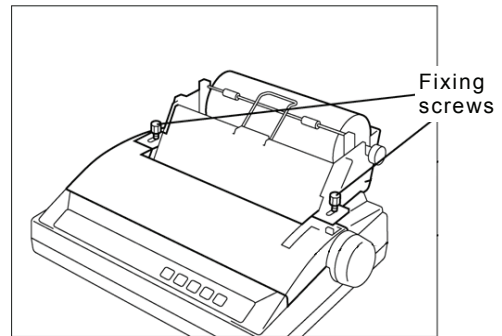

2. Pass the roll bar through the roll paper, and install the roll paper onto the roll paper stand paying attention to its orientation.

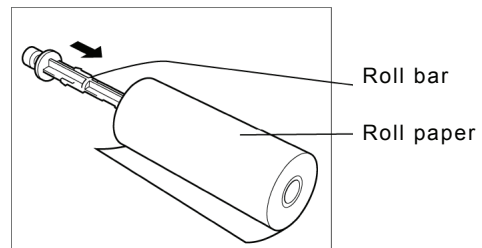

3. Pass the roll paper over the guide bar as shown in the figure at right.

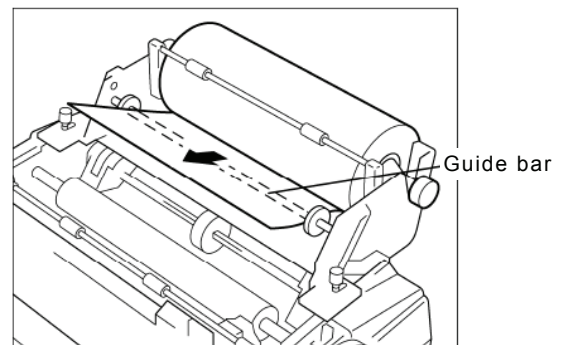

4. Pull the friction lever towards the front, and insert the leading edge of the paper into the rear of the platen. Then, return the friction lever to the back, and turn the paper feed knob to feed the paper out.

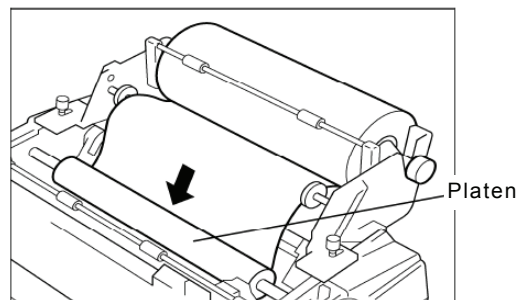

5. Lift the paper load lever up to hold down paper fed out of the platen.

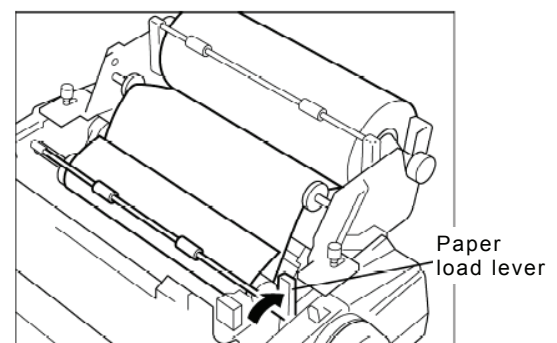

- Return the roll paper cover to its original position, and place the roll support cover as shown in the figure at right.

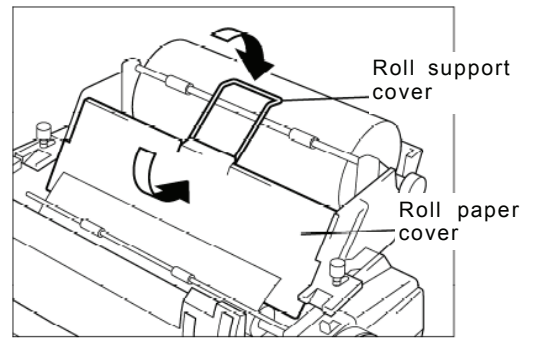

- Close the printer cover, return the roll paper stand to its original position, and tighten the fixing screws.

**Note**

To perform a print test, turn the printer on with the LF key held down.  
To end the print test, turn the printer off.

## ■ Replacing the ink ribbon ■

- Turn the printer on, and following the same procedure as that in the previous section, open the printer cover, lift up the ink ribbon cartridge by holding the projection on the cartridge, and lift the cartridge up to remove it.

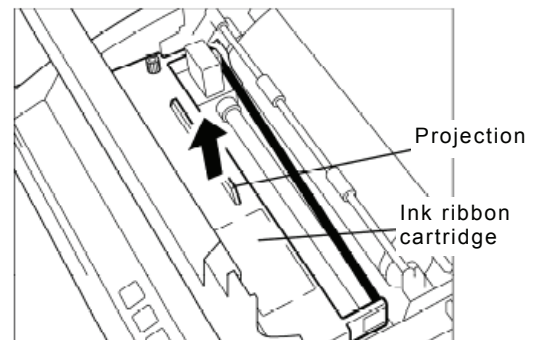

- Using the knob on the new cartridge to make the ribbon taut, manually move the print head to the left edge, and attach the ribbon so that it is between the ribbon mask and print head.

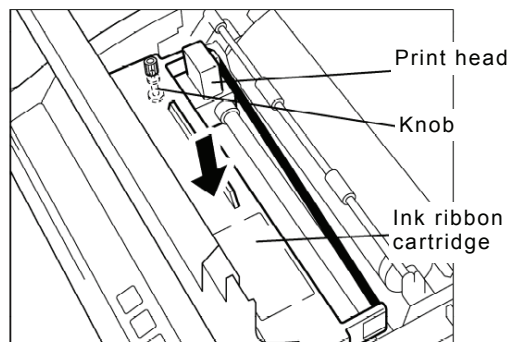

- Close the printer cover, return the roll paper stand to its original position, and tighten the fixing screws.

**Note**

For other details, check the NKG-800 Installation Guide. The printer's operation mode can be set by the DIP switches. However, leave the DIP switch settings at their factory defaults (all off) when using the printer connected to the equipment.

## 10.5 Operations using a SELCALL unit

The JSS-2150 MF/HF radio equipment can be connected to external selective calling devices for fishing boats (Selcall) to send signals for calling Selcall buoys or Selcall receivers on ships.

**Note** For details on operations of Selcall devices, refer to the Instruction Manual for that device.

### ■ Procedure ■

1. Finish all menu operations to return the screen to the status display.

When a transmission is made from the Selcall device while menus are displayed, menus can no longer be operated until transmission ends.

ID 431001234	TIME 23:59(UTC)
Pos 89°59.0123' N	
179°59.6789' E@23:59	(EXT)
TEL ITU-1201 <span style="float:right">DUP</span>	
RX 13077.0 kHz	
TX 12230.0 kHz	
SIG ■■■■■■■■■■ <span style="float:right">🔊</span>	
WKR scan bands:	ATT12 AGC-F BC
2 4 6 8 12 16 (MHz)	

2. Set the frequency (e.g. 2331.5 kHz) for transmitting on the Selcall device in the free frequency input mode. Then tune the antenna by pressing **ANTI TUNE** key.

In this case, input both the Rx and Tx frequencies as simplex frequencies.

**Note** Set the communication mode to TEL.

ID 431001234	TIME 23:59(UTC)
Pos 89°59.0123' N	
179°59.6789' E@23:59	(EXT)
TEL	
RX 2331.5 kHz	
TX 2331.5 kHz	
SIG ■■■■■■■■■■ <span style="float:right">🔊</span>	
WKR scan bands:	ATT12 AGC-F BC
2 4 6 8 12 16 (MHz)	

3. Operate the Selcall device to start transmission.

When transmission is started, the communications mode automatically changes to H2B as shown at right.

ID 431001234	TIME 23:59(UTC)
Pos 89°59.0123' N	
179°59.6789' E@23:59	(EXT)
H2B	
RX 2331.5 kHz	
<b>TX</b> 2331.5 kHz	
PWR ■■■■■■■■ <span style="float:right">🔊</span>	
WKR scan bands:	ATT12 AGC-F BC
2 4 6 8 12 16 (MHz)	TXON

4. When transmission ends, the communications mode returns to the original mode.

ID 431001234	TIME 23:59(UTC)
Pos 89°59.0123' N	
179°59.6789' E@23:59	(EXT)
TEL	
RX 2331.5 kHz	
TX 2331.5 kHz	
SIG ■■■■■■■■■■ <span style="float:right">🔊</span>	
WKR scan bands:	ATT12 AGC-F BC
2 4 6 8 12 16 (MHz)	

# 11. Appendix

This section lists frequencies used for DSC such as frequencies used for routine calls and frequencies used for safety and distress calls. It also lists the channel list of ITU frequencies built-in to this equipment and the instructions for operating the MF/HF radio equipment.

## 11.1 Frequencies for distress and safety calls

The following is a list of international<sup>1</sup> transmission frequencies (all simplex) used by coast and ship stations for distress and safety purposes either with DSC or a radiotelephone. CH No. indicates channel numbers preprogrammed to this equipment.

(DSC)		(radiotelephone)	
CH No.	TRx (kHz)	CH No.	TRx (kHz)
---	2187.5	---	2182.0
401	4207.5	---	4125.0
601	6312.0	---	6215.0
801	8414.5	833	8291.0
1201	12577.0	1221	12290.0
1601	16804.5	1621	16420.0

### Note

- When making DSC calls, the frequencies above can only be used if the message category is Distress, Urgency, or Safety.
- The DSC frequencies listed above are watched by the DSC watch keeping receiver.
- The radiotelephone frequencies of 4125.0 kHz and 6215.0 kHz are the same as the transmission frequencies of ITU channels 421 and 606. However, when making calls for distress and safety purposes, use these frequencies<sup>2</sup> as simplex channels because duplex mode is used to call coast stations.

<sup>1</sup> RR Appendix 15

<sup>2</sup> RR Article 52.221.3

## 11.2 National DSC frequencies for routine calls

When ship and coast stations call national stations for purposes that are not safety or distress purposes, normally use the national frequencies allocated by the administrator prior to using the international frequencies listed later.<sup>3</sup>

**Note** The frequency for Japan is 2169.0 kHz (simplex).

## 11.3 International DSC frequencies for routine calls

The following international<sup>4</sup> frequencies are used when calling ship and coast stations via DSC if the other station's nationality or the frequency they are watching is not know, except for safety or distress calls. CH No. indicates channel numbers preprogrammed to this equipment.

CH No.	Tx (kHz)	Rx (kHz)	CH No.	Tx (kHz)	Rx (kHz)
---	2189.5	2177.0	1602	16805.0	16903.0
402	4208.0	4219.5	1603	16805.5	16903.5
403	4208.5	4220.0	1604	16806.0	16904.0
404	4209.0	4220.5	1801	18898.5	19703.5
602	6312.5	6331.0	1802	18899.0	19704.0
603	6313.0	6331.5	1803	18899.5	19704.5
604	6313.5	6332.0	2201	22374.5	22444.0
802	8415.0	8436.5	2202	22375.0	22444.5
803	8415.5	8437.0	2203	22375.5	22445.0
804	8416.0	8437.5	2501	25208.5	26121.0
1202	12577.5	12657.0	2502	25209.0	26121.5
1203	12578.0	12657.5	2503	25209.5	26122.0
1204	12578.5	12658.0			

- Note**
- The above frequencies can only be used when the DSC message category is Routine.
  - The above table lists the sending and receiving frequencies (duplex) when a ship station calls a coast station.
  - Routine calls between ship stations use 2177.0 kHz as simplex.
  - Channels not listed in the table above (401/601/801/1201/1601) are the frequencies listed earlier for distress and safety purposes.
  - In the table above, channels 402/602/802/1202/1602/1801/2201/2501 should be selected first when making routine DSC calls on international frequencies.<sup>5</sup>

<sup>3</sup> ITU-R M.541-9 Annex 3 4.1.2

<sup>4</sup> RR Appendix 15

<sup>5</sup> RR Appendix 17 part A footnote I

## 11.4 ITU channel list (TEL/CW)

This section lists the channels preprogrammed into this equipment as TEL and CW ITU frequencies.

### (1) Radiotelephone mode (ITU-RR Appendix 17)

CH No.	Tx (kHz)	Rx (kHz)	Remarks	CH No.	Tx (kHz)	Rx (kHz)	Remarks
401	4065.0	4357.0		607	6218.0	6519.0	
402	4068.0	4360.0		608	6221.0	6522.0	
403	4071.0	4363.0		609	6224.0	6224.0	Simplex <sup>(*3)</sup>
404	4074.0	4366.0		610	6227.0	6227.0	Simplex <sup>(*3)</sup>
405	4077.0	4369.0		611	6230.0	6230.0	Simplex <sup>(*3)</sup>
406	4080.0	4372.0					
407	4083.0	4375.0		801	8195.0	8719.0	
408	4086.0	4378.0		802	8198.0	8722.0	
409	4089.0	4381.0		803	8201.0	8725.0	
410	4092.0	4384.0		804	8204.0	8728.0	
411	4095.0	4387.0		805	8207.0	8731.0	
412	4098.0	4390.0		806	8210.0	8734.0	
413	4101.0	4393.0		807	8213.0	8737.0	
414	4104.0	4396.0		808	8216.0	8740.0	
415	4107.0	4399.0		809	8219.0	8743.0	
416	4110.0	4402.0		810	8222.0	8746.0	
417	4113.0	4405.0		811	8225.0	8749.0	
418	4116.0	4408.0		812	8228.0	8752.0	
419	4119.0	4411.0		813	8231.0	8755.0	
420	4122.0	4414.0		814	8234.0	8758.0	
421	4125.0	4417.0	(*1)(*2)	815	8237.0	8761.0	
422	4128.0	4420.0		816	8240.0	8764.0	
423	4131.0	4423.0		817	8243.0	8767.0	
424	4134.0	4426.0		818	8246.0	8770.0	
425	4137.0	4429.0		819	8249.0	8773.0	
426	4140.0	4432.0		820	8252.0	8776.0	
427	4143.0	4435.0		821	8255.0	8779.0	(*2)
428	4146.0	4146.0	Simplex <sup>(*4)</sup>	822	8258.0	8782.0	
429	4149.0	4149.0	Simplex <sup>(*5)</sup>	823	8261.0	8785.0	
				824	8264.0	8788.0	
601	6200.0	6501.0		825	8267.0	8791.0	
602	6203.0	6504.0		826	8270.0	8794.0	
603	6206.0	6507.0		827	8273.0	8797.0	
604	6209.0	6510.0		828	8276.0	8800.0	
605	6212.0	6513.0		829	8279.0	8803.0	
606	6215.0	6516.0	(*1)(*2)	830	8282.0	8806.0	

Appendix

CH No.	Tx (kHz)	Rx (kHz)	Remarks	CH No.	Tx (kHz)	Rx (kHz)	Remarks
831	8285.0	8809.0		1239	12344.0	13191.0	
832	8288.0	8812.0		1240	12347.0	13194.0	
833	8291.0	8291.0	Simplex <sup>(*1)</sup>	1241	12350.0	13197.0	
834	8294.0	8294.0	Simplex <sup>(*6)</sup>	1242	12353.0	12353.0	Simplex <sup>(*3)</sup>
835	8297.0	8297.0	Simplex <sup>(*7)</sup>	1243	12356.0	12356.0	Simplex <sup>(*3)</sup>
				1244	12359.0	12359.0	Simplex <sup>(*2)</sup>
1201	12230.0	13077.0		1245	12362.0	12362.0	Simplex <sup>(*3)</sup>
1202	12233.0	13080.0		1246	12365.0	12365.0	Simplex <sup>(*3)</sup>
1203	12236.0	13083.0					
1204	12239.0	13086.0		1601	16360.0	17242.0	
1205	12242.0	13089.0		1602	16363.0	17245.0	
1206	12245.0	13092.0		1603	16366.0	17248.0	
1207	12248.0	13095.0		1604	16369.0	17251.0	
1208	12251.0	13098.0		1605	16372.0	17254.0	
1209	12254.0	13101.0		1606	16375.0	17257.0	
1210	12257.0	13104.0		1607	16378.0	17260.0	
1211	12260.0	13107.0		1608	16381.0	17263.0	
1212	12263.0	13110.0		1609	16384.0	17266.0	
1213	12266.0	13113.0		1610	16387.0	17269.0	
1214	12269.0	13116.0		1611	16390.0	17272.0	
1215	12272.0	13119.0		1612	16393.0	17275.0	
1216	12275.0	13122.0		1613	16396.0	17278.0	
1217	12278.0	13125.0		1614	16399.0	17281.0	
1218	12281.0	13128.0		1615	16402.0	17284.0	
1219	12284.0	13131.0		1616	16405.0	17287.0	
1220	12287.0	13134.0		1617	16408.0	17290.0	
1221	12290.0	12290.0	Simplex <sup>(*1) (*8)</sup>	1618	16411.0	17293.0	
1222	12293.0	13140.0		1619	16414.0	17296.0	
1223	12296.0	13143.0		1620	16417.0	17299.0	
1224	12299.0	13146.0		1621	16420.0	16420.0	Simplex <sup>(*1) (*9)</sup>
1225	12302.0	13149.0		1622	16423.0	17305.0	
1226	12305.0	13152.0		1623	16426.0	17308.0	
1227	12308.0	13155.0		1624	16429.0	17311.0	
1228	12311.0	13158.0		1625	16432.0	17314.0	
1229	12314.0	13161.0		1626	16435.0	17317.0	
1230	12317.0	13164.0		1627	16438.0	17320.0	
1231	12320.0	13167.0		1628	16441.0	17323.0	
1232	12323.0	13170.0		1629	16444.0	17326.0	
1233	12326.0	13173.0		1630	16447.0	17329.0	
1234	12329.0	13176.0		1631	16450.0	17332.0	
1235	12332.0	13179.0		1632	16453.0	17335.0	
1236	12335.0	13182.0		1633	16456.0	17338.0	
1237	12338.0	13185.0		1634	16459.0	17341.0	
1238	12341.0	13188.0		1635	16462.0	17344.0	



CH No.	Tx (kHz)	Rx (kHz)	Remarks
1636	16465.0	17347.0	
1637	16468.0	17350.0	
1638	16471.0	17353.0	
1639	16474.0	17356.0	
1640	16477.0	17359.0	
1641	16480.0	17362.0	
1642	16483.0	17365.0	
1643	16486.0	17368.0	
1644	16489.0	17371.0	
1645	16492.0	17374.0	
1646	16495.0	17377.0	
1647	16498.0	17380.0	
1648	16501.0	17383.0	
1649	16504.0	17386.0	
1650	16507.0	17389.0	
1651	16510.0	17392.0	
1652	16513.0	17395.0	
1653	16516.0	17398.0	
1654	16519.0	17401.0	
1655	16522.0	17404.0	
1656	16525.0	17407.0	
1657	16528.0	16528.0	Simplex <sup>(+3)</sup>
1658	16531.0	16531.0	Simplex <sup>(+3)</sup>
1659	16534.0	16534.0	Simplex <sup>(+3)</sup>
1660	16537.0	16537.0	Simplex <sup>(+2)</sup>
1661	16540.0	16540.0	Simplex <sup>(+3)</sup>
1662	16543.0	16543.0	Simplex <sup>(+3)</sup>
1663	16546.0	16546.0	Simplex <sup>(+3)</sup>
1801	18780.0	19755.0	
1802	18783.0	19758.0	
1803	18786.0	19761.0	
1804	18789.0	19764.0	
1805	18792.0	19767.0	
1806	18795.0	19770.0	(+2)
1807	18798.0	19773.0	
1808	18801.0	19776.0	
1809	18804.0	19779.0	
1810	18807.0	19782.0	
1811	18810.0	19785.0	
1812	18813.0	19788.0	
1813	18816.0	19791.0	
1814	18819.0	19794.0	
1815	18822.0	19797.0	

CH No.	Tx (kHz)	Rx (kHz)	Remarks
1816	18825.0	18825.0	Simplex <sup>(+3)</sup>
1817	18828.0	18828.0	Simplex <sup>(+3)</sup>
1818	18831.0	18831.0	Simplex <sup>(+3)</sup>
1819	18834.0	18834.0	Simplex <sup>(+3)</sup>
1820	18837.0	18837.0	Simplex <sup>(+3)</sup>
1821	18840.0	18840.0	Simplex <sup>(+3)</sup>
1822	18843.0	18843.0	Simplex <sup>(+3)</sup>
2201	22000.0	22696.0	
2202	22003.0	22699.0	
2203	22006.0	22702.0	
2204	22009.0	22705.0	
2205	22012.0	22708.0	
2206	22015.0	22711.0	
2207	22018.0	22714.0	
2208	22021.0	22717.0	
2209	22024.0	22720.0	
2210	22027.0	22723.0	
2211	22030.0	22726.0	
2212	22033.0	22729.0	
2213	22036.0	22732.0	
2214	22039.0	22735.0	
2215	22042.0	22738.0	
2216	22045.0	22741.0	
2217	22048.0	22744.0	
2218	22051.0	22747.0	
2219	22054.0	22750.0	
2220	22057.0	22753.0	
2221	22060.0	22756.0	(+2)
2222	22063.0	22759.0	
2223	22066.0	22762.0	
2224	22069.0	22765.0	
2225	22072.0	22768.0	
2226	22075.0	22771.0	
2227	22078.0	22774.0	
2228	22081.0	22777.0	
2229	22084.0	22780.0	
2230	22087.0	22783.0	
2231	22090.0	22786.0	
2232	22093.0	22789.0	
2233	22096.0	22792.0	
2234	22099.0	22795.0	
2235	22102.0	22798.0	
2236	22105.0	22801.0	

## Appendix

CH No.	Tx (kHz)	Rx (kHz)	Remarks	CH No.	Tx (kHz)	Rx (kHz)	Remarks
2237	22108.0	22804.0		2258	22171.0	22171.0	Simplex <sup>(*)3</sup>
2238	22111.0	22807.0		2259	22174.0	22174.0	Simplex <sup>(*)3</sup>
2239	22114.0	22810.0		2260	22177.0	22177.0	Simplex <sup>(*)3</sup>
2240	22117.0	22813.0					
2241	22120.0	22816.0		2501	25070.0	26145.0	
2242	22123.0	22819.0		2502	25073.0	26148.0	
2243	22126.0	22822.0		2503	25076.0	26151.0	
2244	22129.0	22825.0		2504	25079.0	26154.0	
2245	22132.0	22828.0		2505	25082.0	26157.0	
2246	22135.0	22831.0		2506	25085.0	26160.0	
2247	22138.0	22834.0		2507	25088.0	26163.0	
2248	22141.0	22837.0		2508	25091.0	26166.0	
2249	22144.0	22840.0		2509	25094.0	26169.0	
2250	22147.0	22843.0		2510	25097.0	26172.0	(*)2
2251	22150.0	22846.0		2511	25100.0	25100.0	Simplex <sup>(*)3</sup>
2252	22153.0	22849.0		2512	25103.0	25103.0	Simplex <sup>(*)3</sup>
2253	22156.0	22852.0		2513	25106.0	25106.0	Simplex <sup>(*)3</sup>
2254	22159.0	22159.0	Simplex <sup>(*)3</sup>	2514	25109.0	25109.0	Simplex <sup>(*)3</sup>
2255	22162.0	22162.0	Simplex <sup>(*)3</sup>	2515	25112.0	25112.0	Simplex <sup>(*)3</sup>
2256	22165.0	22165.0	Simplex <sup>(*)3</sup>	2516	25115.0	25115.0	Simplex <sup>(*)3</sup>
2257	22168.0	22168.0	Simplex <sup>(*)3</sup>	2517	25118.0	25118.0	Simplex <sup>(*)3</sup>

\*1) Used for distress and safety purposes (operates duplex channel as simplex).

\*2) For calling.

\*3) For inter-ship communications.

\*4) For inter-ship communications. You can also communicate with coast stations on Rx 4351.0 kHz.

\*5) For inter-ship communications. You can also communicate with coast stations on Rx 4354.0 kHz.

\*6) For inter-ship communications. You can also communicate with coast stations on Rx 8707.0 kHz.

\*7) For inter-ship communications. You can also communicate with coast stations on Rx 8710.0 kHz.

\*8) From January 2004, calling on channel 1221 (previously duplex) is prohibited.

\*9) From January 2004, calling on channel 1621 (previously duplex) is prohibited.

## (2) CW mode (ITU-RR Appendix 17)

CH No.	TRx (kHz)	Remarks	CH No.	TRx (kHz)	Remarks	CH No.	TRx (kHz)	Remarks
401	4182.0	Calling	605	6278.0	Calling	809	8370.0	Calling
402	4182.5	Calling	606	6278.5	Calling	810	8370.5	Calling
403	4184.0	Calling	607	6279.0	Calling	811	8342.0	
404	4184.5	Calling	608	6279.5	Calling	812	8342.5	
405	4183.0	Calling	609	6280.0	Calling	813	8343.0	
406	4183.5	Calling	610	6280.5	Calling	814	8343.5	
407	4185.0	Calling	611	6285.0		815	8344.0	
408	4185.5	Calling	612	6285.5		816	8344.5	
409	4186.0	Calling	613	6286.0		817	8345.0	
410	4186.5		614	6286.5		818	8345.5	
411	4187.0		615	6287.0		819	8346.0	
412	4187.5		616	6287.5		820	8346.5	
413	4188.0		617	6288.0		821	8347.0	
414	4188.5		618	6288.5		822	8347.5	
415	4189.0		619	6289.0		823	8348.0	
416	4189.5		620	6289.5		824	8348.5	
417	4190.0		621	6290.0		825	8349.0	
418	4190.5		622	6290.5		826	8349.5	
419	4191.0		623	6291.0		827	8350.0	
420	4191.5		624	6291.5		828	8350.5	
421	4192.0		625	6292.0		829	8351.0	
422	4192.5		626	6292.5		830	8351.5	
423	4193.0		627	6293.0		831	8352.0	
424	4193.5		628	6293.5		832	8352.5	
425	4194.0		629	6294.0		833	8353.0	
426	4194.5		630	6294.5		834	8353.5	
427	4195.0		631	6295.0		835	8354.0	
428	4195.5		632	6295.5		836	8354.5	
429	4196.0		633	6296.0		837	8355.0	
430	4196.5		634	6296.5		838	8355.5	
431	4197.0		635	6297.0		839	8356.0	
432	4197.5		636	6297.5		840	8356.5	
433	4198.0		637	6298.0		841	8357.0	
434	4198.5		638	6298.5		842	8357.5	
435	4199.0		639	6299.0		843	8358.0	
436	4199.5		640	6299.5		844	8358.5	
437	4200.0		641	6300.0		845	8359.0	
438	4200.5					846	8359.5	
439	4201.0		801	8366.0	Calling	847	8360.0	
440	4201.5		802	8366.5	Calling	848	8360.5	
441	4202.0		803	8368.0	Calling	849	8361.0	
			804	8369.0	Calling	850	8361.5	
601	6277.0	Calling	805	8367.0	Calling	851	8362.0	
602	6277.5	Calling	806	8367.5	Calling	852	8362.5	
603	6276.0	Calling	807	8368.5	Calling	853	8363.0	
604	6276.5	Calling	808	8369.5	Calling	854	8363.5	

Appendix

CH No.	TRx (kHz)	Remarks	CH No.	TRx (kHz)	Remarks	CH No.	TRx (kHz)	Remarks
855	8364.0		1232	12432.5		1279	12456.0	
856	8364.5		1233	12433.0		1280	12456.5	
857	8365.0		1234	12433.5		1281	12457.0	
858	8365.5		1235	12434.0		1282	12457.5	
859	8371.0		1236	12434.5		1283	12458.0	
860	8371.5		1237	12435.0		1284	12458.5	
861	8372.0		1238	12435.5		1285	12459.0	
862	8372.5		1239	12436.0		1286	12459.5	
863	8373.0		1240	12436.5		1287	12460.0	
864	8373.5		1241	12437.0		1288	12460.5	
865	8374.0		1242	12437.5		1289	12461.0	
866	8374.5		1243	12438.0		1290	12461.5	
867	8375.0		1244	12438.5		1291	12462.0	
868	8375.5		1245	12439.0		1292	12462.5	
869	8376.0		1246	12439.5		1293	12463.0	
			1247	12440.0		1294	12463.5	
1201	12550.0	Calling	1248	12440.5		1295	12464.0	
1202	12550.5	Calling	1249	12441.0		1296	12464.5	
1203	12552.0	Calling	1250	12441.5		1297	12465.0	
1204	12553.5	Calling	1251	12442.0		1298	12465.5	
1205	12551.0	Calling	1252	12442.5		1299	12466.0	
1206	12551.5	Calling	1253	12443.0		12100	12466.5	
1207	12552.5	Calling	1254	12443.5		12101	12467.0	
1208	12553.0	Calling	1255	12444.0		12102	12467.5	
1209	12554.0	Calling	1256	12444.5		12103	12468.0	
1210	12554.5	Calling	1257	12445.0		12104	12468.5	
1211	12422.0		1258	12445.5		12105	12469.0	
1212	12422.5		1259	12446.0		12106	12469.5	
1213	12423.0		1260	12446.5		12107	12470.0	
1214	12423.5		1261	12447.0		12108	12470.5	
1215	12424.0		1262	12447.5		12109	12471.0	
1216	12424.5		1263	12448.0		12110	12471.5	
1217	12425.0		1264	12448.5		12111	12472.0	
1218	12425.5		1265	12449.0		12112	12472.5	
1219	12426.0		1266	12449.5		12113	12473.0	
1220	12426.5		1267	12450.0		12114	12473.5	
1221	12427.0		1268	12450.5		12115	12474.0	
1222	12427.5		1269	12451.0		12116	12474.5	
1223	12428.0		1270	12451.5		12117	12475.0	
1224	12428.5		1271	12452.0		12118	12475.5	
1225	12429.0		1272	12452.5		12119	12476.0	
1226	12429.5		1273	12453.0		12120	12476.5	
1227	12430.0		1274	12453.5				
1228	12430.5		1275	12454.0		1601	16734.0	Calling
1229	12431.0		1276	12454.5		1602	16734.5	Calling
1230	12431.5		1277	12455.0		1603	16736.0	Calling
1231	12432.0		1278	12455.5		1604	16738.0	Calling

CH No.	TRx (kHz)	Remarks	CH No.	TRx (kHz)	Remarks	CH No.	TRx (kHz)	Remarks
1605	16735.0	Calling	1652	16639.5		1699	16663.0	
1606	16735.5	Calling	1653	16640.0		16100	16663.5	
1607	16736.5	Calling	1654	16640.5		16101	16664.0	
1608	16737.0	Calling	1655	16641.0		16102	16664.5	
1609	16737.5	Calling	1656	16641.5		16103	16665.0	
1610	16738.5	Calling	1657	16642.0		16104	16665.5	
1611	16619.0		1658	16642.5		16105	16666.0	
1612	16619.5		1659	16643.0		16106	16666.5	
1613	16620.0		1660	16643.5		16107	16667.0	
1614	16620.5		1661	16644.0		16108	16667.5	
1615	16621.0		1662	16644.5		16109	16668.0	
1616	16621.5		1663	16645.0		16110	16668.5	
1617	16622.0		1664	16645.5		16111	16669.0	
1618	16622.5		1665	16646.0		16112	16669.5	
1619	16623.0		1666	16646.5		16113	16670.0	
1620	16623.5		1667	16647.0		16114	16670.5	
1621	16624.0		1668	16647.5		16115	16671.0	
1622	16624.5		1669	16648.0		16116	16671.5	
1623	16625.0		1670	16648.5		16117	16672.0	
1624	16625.5		1671	16649.0		16118	16672.5	
1625	16626.0		1672	16649.5		16119	16673.0	
1626	16626.5		1673	16650.0		16120	16673.5	
1627	16627.0		1674	16650.5		16121	16674.0	
1628	16627.5		1675	16651.0		16122	16674.5	
1629	16628.0		1676	16651.5		16123	16675.0	
1630	16628.5		1677	16652.0		16124	16675.5	
1631	16629.0		1678	16652.5		16125	16676.0	
1632	16629.5		1679	16653.0		16126	16676.5	
1633	16630.0		1680	16653.5		16127	16677.0	
1634	16630.5		1681	16654.0		16128	16677.5	
1635	16631.0		1682	16654.5		16129	16678.0	
1636	16631.5		1683	16655.0		16130	16678.5	
1637	16632.0		1684	16655.5		16131	16679.0	
1638	16632.5		1685	16656.0		16132	16679.5	
1639	16633.0		1686	16656.5		16133	16680.0	
1640	16633.5		1687	16657.0		16134	16680.5	
1641	16634.0		1688	16657.5		16135	16681.0	
1642	16634.5		1689	16658.0		16136	16681.5	
1643	16635.0		1690	16658.5		16137	16682.0	
1644	16635.5		1691	16659.0		16138	16682.5	
1645	16636.0		1692	16659.5		16139	16683.0	
1646	16636.5		1693	16660.0				
1647	16637.0		1694	16660.5		2201	22279.5	Calling
1648	16637.5		1695	16661.0		2202	22280.0	Calling
1649	16638.0		1696	16661.5		2203	22280.5	Calling
1650	16638.5		1697	16662.0		2204	22281.0	Calling
1651	16639.0		1698	16662.5		2205	22281.5	Calling

Appendix

CH No.	TRx (kHz)	Remarks	CH No.	TRx (kHz)	Remarks	CH No.	TRx (kHz)	Remarks
2206	22282.0	Calling	2241	22257.0		2276	22274.5	
2207	22282.5	Calling	2242	22257.5		2277	22275.0	
2208	22283.0	Calling	2243	22258.0		2278	22275.5	
2209	22283.5	Calling	2244	22258.5		2279	22276.0	
2210	22284.0	Calling	2245	22259.0		2280	22276.5	
2211	22242.0		2246	22259.5		2281	22277.0	
2212	22242.5		2247	22260.0		2282	22277.5	
2213	22243.0		2248	22260.5		2283	22278.0	
2214	22243.5		2249	22261.0		2284	22278.5	
2215	22244.0		2250	22261.5		2285	22279.0	
2216	22244.5		2251	22262.0				
2217	22245.0		2252	22262.5		2501	25171.5	Calling
2218	22245.5		2253	22263.0		2502	25172.0	Calling
2219	22246.0		2254	22263.5		2503	25171.5	Calling
2220	22246.5		2255	22264.0		2504	25172.5	Calling
2221	22247.0		2256	22264.5		2505	25161.5	
2222	22247.5		2257	22265.0		2506	25162.0	
2223	22248.0		2258	22265.5		2507	25162.5	
2224	22248.5		2259	22266.0		2508	25163.0	
2225	22249.0		2260	22266.5		2509	25163.5	
2226	22249.5		2261	22267.0		2510	25164.0	
2227	22250.0		2262	22267.5		2511	25164.5	
2228	22250.5		2263	22268.0		2512	25165.0	
2229	22251.0		2264	22268.5		2513	25165.5	
2230	22251.5		2265	22269.0		2514	25166.0	
2231	22252.0		2266	22269.5		2515	25166.5	
2232	22252.5		2267	22270.0		2516	25167.0	
2233	22253.0		2268	22270.5		2517	25167.5	
2234	22253.5		2269	22271.0		2518	25168.0	
2235	22254.0		2270	22271.5		2519	25168.5	
2236	22254.5		2271	22272.0		2520	25169.0	
2237	22255.0		2272	22272.5		2521	25169.5	
2238	22255.5		2273	22273.0		2522	25170.0	
2239	22256.0		2274	22273.5		2523	25170.5	
2240	22256.5		2275	22274.0		2524	25171.0	

## 11.5 Guide to MF/HF operation

Be aware of the following points when using the MF/HF radio equipment.

- Frequencies available for communication are always changing.
- Not all frequency bandwidths can always be used for communication.
- After sending the DSC test call to a coast station, you will not always receive the acknowledgement.

### 1. About the MF/HF radio equipment

Although for ship MF/HF radio equipment the 1.6 MHz to 27.5 MHz frequencies are normally available, select an appropriate frequency from the frequencies assigned to your ship for communication. As noted below, the use of the appropriate frequency depends upon the radio wave propagation characteristics of the ionosphere. **Therefore, not all frequency bands are available for communication even if the equipment is functioning properly.**

### 2. Special characteristics of MF/HF radio wave propagation

As shown in the figure to the right, the major MF/HF radio waves used for communications are terrestrial waves (path 1) and waves reflected from the ionosphere (paths 2 and 3). You can communicate using waves reflected from the ionosphere and the earth because the effective communication range of terrestrial waves is limited<sup>6</sup>.

The available range of frequencies for communication depends upon the radio wave propagation characteristics of the ionosphere. They will also change dramatically depending on the position and distance from the station, the season, the time, and the sunspot number (approx. 0 to 250) which changes every 11 years<sup>7</sup>.

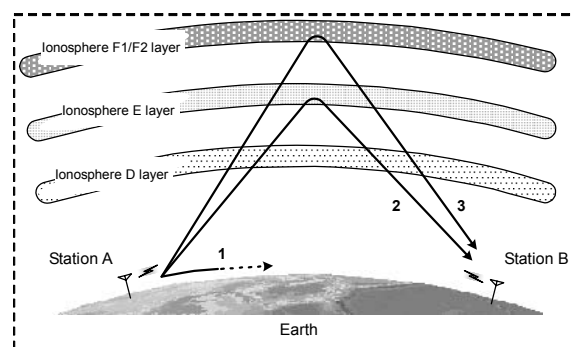

The available range of frequencies for communication depends upon the radio wave propagation characteristics of the ionosphere. They will also change dramatically depending on the position and distance from the station, the season, the time, and the sunspot number (approx. 0 to 250) which changes every 11 years<sup>7</sup>.

### 3. Selecting communication frequencies

MF/HF band communication frequencies cannot be predetermined. However, you can select frequencies referring to previous communications logs, the frequency transition table in this chapter under "Selecting communication frequencies in the MF/HF band (reference)", and the radio wave propagation image.

### 4. About DSC testing

DSC operation is prescribed as an international standard<sup>8</sup> of the ITU and coast stations that receive DSC test calls should acknowledge the calls. Responses may be sent manually instead of automatically depending on the equipment at the coast station. **It may take longer than expected to receive the acknowledgement even if your equipment is functioning properly and you have selected the proper frequency.**

<sup>6</sup> You may experience skip zones where both terrestrial waves and waves reflected from the ionosphere are unavailable at the end of the effective communication range of terrestrial waves.

<sup>7</sup> Radio wave propagation is affected by phasing, the Dellinger phenomenon, magnetic storms, and atmospheric. Interference tends to be greater at night when radio waves can travel greater distances.

<sup>8</sup> ITU-R Recommendation M. 541

## Selecting communication frequencies in the MF/HF band (reference)

When communicating with the MF/HF radio equipment, select frequencies referring to the frequency transition table and the radio wave propagation images (excluding the polar latitudes) shown below<sup>9</sup>.

Example: When communicating with a station approximately 5000 km away at around 12 pm in the winter with a sunspot number of 100, select frequencies in the 18, 22, or 25 MHz bands for the best results.

### ➤ Frequency transition table

Transmissions conditions			Guideline for selecting frequency (for a sunspot count of 100)								
Distance	Season & time		2 M	4 M	6 M	8 M	12 M	16 M	18 M	22 M	25 M
Long distances (e.g. 5000 km)	Winter	Day	[Shaded area from 12M to 25M]								
		Night	[Shaded area from 4M to 12M]								
	Summer	Day	[Shaded area from 8M to 22M]								
		Night	[Shaded area from 2M to 16M]								
Short distances (e.g. 1000 km)	Winter	Day	[Shaded area from 6M to 18M]								
		Night	[Shaded area from 2M to 8M]								
	Summer	Day	[Shaded area from 4M to 12M]								
		Night	[Shaded area from 2M to 4M]								

### ➤ Radio wave propagation images

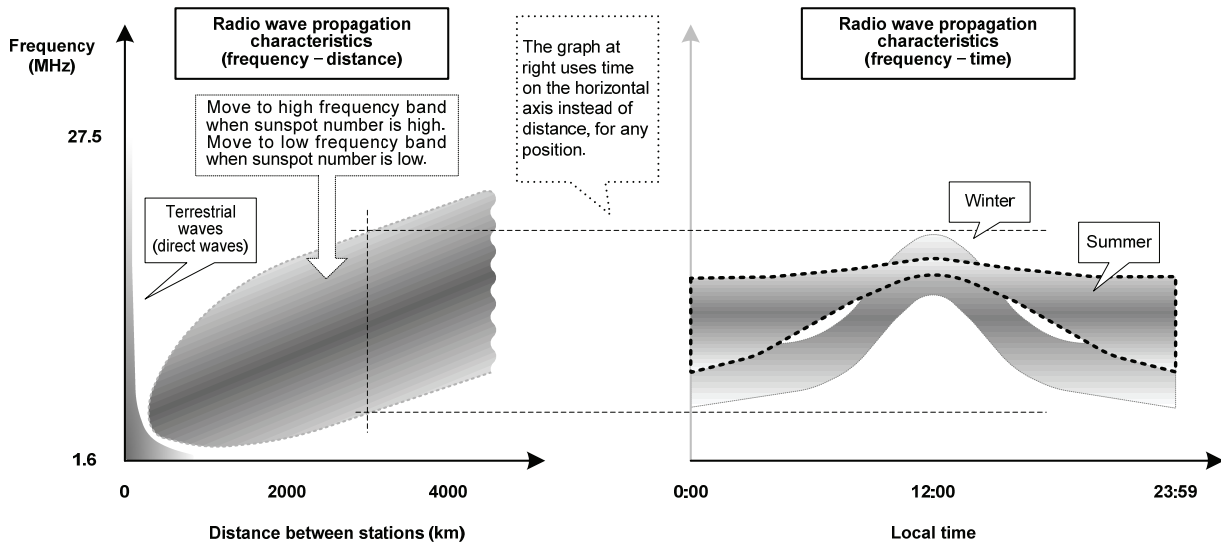

<sup>9</sup> These are based on the prediction of HF radio wave propagations. Communication is not guaranteed.



## 电子信息产品有害物资申明

日本无线株式会社

### Declaration on toxic & hazardous substances or elements of Electronic Information Products Japan Radio Company Limited

#### 有毒有害物质或元素的名称及含量

(Names & Content of toxic and hazardous substances or elements)

形式名(Type): JSS-2150

名称(Name): MF/HF Radio equipment

部件名称 (Part name)	有毒有害物质或元素 (Toxic and Hazardous Substances and Elements)					
	铅 (Pb)	汞 (Hg)	镉 (Cd)	六价铬 (Cr <sup>6+</sup> )	多溴联苯 (PBB)	多溴二苯醚 (PBDE)
天线 (Antenna)	×	○	×	×	×	×
船内装置 (Inboard Unit)	×	○	×	×	×	×
外部设备(Peripherals) ·选择(Options) ·打印机(Printer) ·电线类(Cables) ·手册(Documentnts)	×	○	×	×	×	×
<p>○: 表示该有毒有害物质在该部件所有均质材料中的含量均在SJ/T11306-2006 标准规定的限量要求以下。 (Indicates that this toxic, or hazardous substance contained in all of the homogeneous materials for this part is below the requirement in SJ/T11363-2006.)</p> <p>×: 表示该有毒有害物质至少在该部件的某一均质材料中的含量超出SJ/T11363-2006 标准规定的限量要求。 (Indicates that this toxic or hazardous substance contained in at least one of the homogeneous materials used for this part is above the limit requirement in SJ/T 11363-2006.)</p>						

JRC Code No. : 7ZPJD0449





アスベストは使用していません  
Not use the asbestos

CODE No.7ZPJD0449

For further information, contact:

**JRC** *Japan Radio Co., Ltd.*  
Since 1915

URL <http://www.jrc.co.jp>

Marine Service Department

Telephone : +81-3-3492-1305

Facsimile : +81-3-3779-1420

e-mail : [tmsc@jrc.co.jp](mailto:tmsc@jrc.co.jp)

AMSTERDAM Branch

Telephone : +31-20-658-0750

Facsimile : +31-20-658-0755

e-mail : [service@jrcams.nl](mailto:service@jrcams.nl)

SEATTLE Branch

Telephone : +1-206-654-5644

Facsimile : +1-206-654-7030

e-mail : [service@jrcamerica.com](mailto:service@jrcamerica.com)

01ETM

ISO 9001, ISO 14001 Certified

©APR. 2009 Edition 1 JRC

Printed in Japan