

VHF FM TRANSCEIVER

# TK-790H(B)

## SERVICE MANUAL

### SUPPLEMENT

# KENWOOD

Kenwood Corporation

© 2005-2 PRINTED IN JAPAN  
B51-8718-00 (N) PDF

This service manual applies to products with 60400001 or subsequent serial numbers.



---

## CONTENTS

---

<b>PARTS LIST</b> .....	<b>2</b>
<b>PC BOARD</b>	
<b>FINAL UNIT (X45-3560-10)</b> .....	<b>4</b>
<b>SCHEMATIC DIAGRAM</b>	
<b>FINAL UNIT (X45-3560-10)</b> .....	<b>8</b>

---

# TK-790H(B)

## PARTS LIST

\* New Parts.  $\Delta$  indicates safety critical components.

Parts without **Parts No.** are not supplied.

Les articles non mentionnés dans le **Parts No.** ne sont pas fournis.

Teile ohne **Parts No.** werden nicht geliefert.

L : Scandinavia

Y : PX (Far East, Hawaii)

Y : AAFES (Europe)

K : USA

T : England

X : Australia

P : Canada

E : Europe

M : Other Areas

### FINAL UNIT (X45-3560-10)

Ref. No.	Address	New parts	Parts No.	Description	Destination	Ref. No.	Address	New parts	Parts No.	Description	Destination
<b>FINAL UNIT (X45-3560-10)</b>						C95			CK73GB1E103K	CHIP C 0.010UF K	
C1-6			CK73FB1H102K	CHIP C 1000PF K		C96			CK73GB1H102K	CHIP C 1000PF K	
C8			CK73FB1E104K	CHIP C 0.10UF K		C98			CK73GB1H102K	CHIP C 1000PF K	
C11			CK73FB1H102K	CHIP C 1000PF K		CN1,2			E04-0154-05	PIN SOCKET	
C13			CM73F2H180J	CHIP C 18PF J		CN3,4			E23-1116-05	RELAY TERMINAL	
C15			CK73FB1H102K	CHIP C 1000PF K		W1,2			E37-0783-05	PROCESSED LEAD WIRE	
C16			CM73F2H470J	CHIP C 47PF J		W4			E37-0706-05	LEAD WIRE WITH CONNECTOR	
C18			C92-0726-05	CHIP-ELE 47UF 25WV		W5			E37-0701-05	LEAD WIRE WITH CONNECTOR	
C19			CM73F2H151J	CHIP C 150PF J		L1			L34-1039-05	AIR-CORE COIL	
C21			CM73F2H181J	CHIP C 180PF J		L2			L39-0421-04	COIL	
C22,23			CM73F2H681J	CHIP C 680PF J		L3,4			L34-1231-15	AIR-CORE COIL	
C24,25			CM73F2H201J	CHIP C 200PF J		L5			L34-1246-15	AIR-CORE COIL	
C28-31			CM73F2H271J	CHIP C 270PF J		L6			L34-1247-05	AIR-CORE COIL	
C32-35			CM73F2H221J	CHIP C 220PF J		L7,8			L34-1232-15	AIR-CORE COIL	
C37			CK73FB1H102K	CHIP C 1000PF K		L9			L34-1231-15	AIR-CORE COIL	
C38			CK73FB1H103K	CHIP C 0.010UF K		L10			L34-1088-05	AIR-CORE COIL	
C39			CK73FB1E104K	CHIP C 0.10UF K		L11			L40-1885-34	SMALL FIXED INDUCTOR (180NH)	
C40,41			CM73F2H681J	CHIP C 680PF J		R1			RK73FB2A330J	CHIP R 33 J 1/10W	
C42			CK73FB1H102K	CHIP C 1000PF K		R2			RK73FB2A473J	CHIP R 47K J 1/10W	
C43			CM73F2H620J	CHIP C 62PF J		R4			RK73FB2A103J	CHIP R 10K J 1/10W	
C44			C90-5299-05	ELECTRO 470UF 25WV		R5			RK73FB2A471J	CHIP R 470 J 1/10W	
C45			CK73FB1H103K	CHIP C 0.010UF K		R6			RK73FB2A122J	CHIP R 1.2K J 1/10W	
C46			CM73F2H620J	CHIP C 62PF J		R7			RK73FB2A472J	CHIP R 4.7K J 1/10W	
C47			CK73FB1H102K	CHIP C 1000PF K		R8			RD14DB3A3R3J	SMALL-RD 3.3 J 1W	
C48			CK73FB1E104K	CHIP C 0.10UF K		R9,10			RS14DB3D2R2J	FL-PROOF RS 2.2 J 2W	
C49			CM73F2H470J	CHIP C 47PF J		R13			RD14DB3A3R3J	SMALL-RD 3.3 J 1W	
C50			C90-5299-05	ELECTRO 470UF 25WV		R16,17			R92-1221-05	CHIP R 82 J 1/4W	
C51			CM73F2H180J	CHIP C 18PF J		R18			RK73FB2A122J	CHIP R 1.2K J 1/10W	
C52			CK73FB1H102K	CHIP C 1000PF K		R19			RK73FB2A103J	CHIP R 10K J 1/10W	
C53			CC73FCH1H180J	CHIP C 18PF J		R20			RK73FB2A271J	CHIP R 270 J 1/10W	
C55			CK73FB1H102K	CHIP C 1000PF K		R21			RK73FB2A330J	CHIP R 33 J 1/10W	
C58			CK73FB1H102K	CHIP C 1000PF K		R22			RK73FB2A271J	CHIP R 270 J 1/10W	
C60			CC73FCH1H020C	CHIP C 2.0PF C		R24			RK73FB2A561J	CHIP R 560 J 1/10W	
C61			CK73FB1H102K	CHIP C 1000PF K		R25			R92-1061-05	JUMPER REST 0 OHM	
C63			CK73FB1H102K	CHIP C 1000PF K		R30			RK73GB1J102J	CHIP R 1.0K J 1/16W	
C64			CM73F2H100D	CHIP C 10PF D		R32			RK73GB1J102J	CHIP R 1.0K J 1/16W	
C65			C92-0729-05	CHIP-ELE 330UF 25WV		R33			RK73GB1J103J	CHIP R 10K J 1/16W	
C66			CM73F2H360F	CHIP C 36PF F		R34			RK73GB1J102J	CHIP R 1.0K J 1/16W	
C67			C92-0729-05	CHIP-ELE 330UF 25WV		R35			RK73GB1J182J	CHIP R 1.8K J 1/16W	
C68,69			CK73FB1H102K	CHIP C 1000PF K		R36			RK73GB1J104J	CHIP R 100K J 1/16W	
C70			CM73F2H360F	CHIP C 36PF F		R37,38			RK73GB1J103J	CHIP R 10K J 1/16W	
C71			CM73F2H080D	CHIP C 8.0PF D		R39			RK73GB1J273J	CHIP R 27K J 1/16W	
C72			CM73F2H180J	CHIP C 18PF J		R40			RK73GB1J183J	CHIP R 18K J 1/16W	
C73,74			CK73FB1H102K	CHIP C 1000PF K		R41			RK73GB1J153J	CHIP R 15K J 1/16W	
C83			C92-0606-05	CHIP-TAN 4.7UF 10WV		R42			RK73GB1J103J	CHIP R 10K J 1/16W	
C84			CK73GB1C104K	CHIP C 0.10UF K		R43			RK73GB1J273J	CHIP R 27K J 1/16W	
C85			CK73GB1E103K	CHIP C 0.010UF K		R44			R92-1252-05	CHIP R 0 OHM J 1/16W	
C86			CK73GB1H471K	CHIP C 470PF K		R45			RK73GB1J103J	CHIP R 10K J 1/16W	
C87			CK73GB1H102K	CHIP C 1000PF K		R46			RK73GB1J272J	CHIP R 2.7K J 1/16W	
C88			CK73GB1C104K	CHIP C 0.10UF K		R47			RK73GB1J103J	CHIP R 10K J 1/16W	
C89			C92-0003-05	CHIP-TAN 0.47UF 25WV		R48			RK73GB1J272J	CHIP R 2.7K J 1/16W	
C90			CK73GB1H102K	CHIP C 1000PF K		R49			RK73GB1J154J	CHIP R 150K J 1/16W	
C91			C90-4016-05	ELECTRO 47UF 16WV		VR1			R12-6429-05	TRIMMING POT. (100K)	
C92			CK73FB1H102K	CHIP C 1000PF K		K1			S51-1437-05	RELAY	
C94			CK73GB1H102K	CHIP C 1000PF K							

## PARTS LIST

FINAL UNIT (X45-3560-10)

Ref. No.	Address	New parts	Parts No.	Description	Destination	Ref. No.	Address	New parts	Parts No.	Description	Destination
D1,2			HSM88AS	DIODE							
D4			22ZR-10D	SURGE ABSORBER							
D5			1SS193	DIODE							
D6			02CZ10(X,Y)	ZENER DIODE							
D7			SG-5L(R)	DIODE							
D10			02DZ5.6(X,Y)	ZENER DIODE							
D11,12			1SS355	DIODE							
IC1			RA30H1317M-31	MOS-IC							
IC2,3			OP291GS	BI-POLAR IC							
Q1,2			2SC2712(Y)	TRANSISTOR							
Q6,7			2SC2782	TRANSISTOR							
Q8			FMC2	DIGITAL TRANSISTOR							
Q9			2SD1624(S)	TRANSISTOR							
Q20			2SC4116(Y)	TRANSISTOR							
TH1			PTH9M04BC471TS	THERMISTOR							
-			212-0702-05	INSULATING TUBE							

# TK-790H(B) PC BOARD

FINAL UNIT (X45-3560-10) Component side view (J72-0568-12)

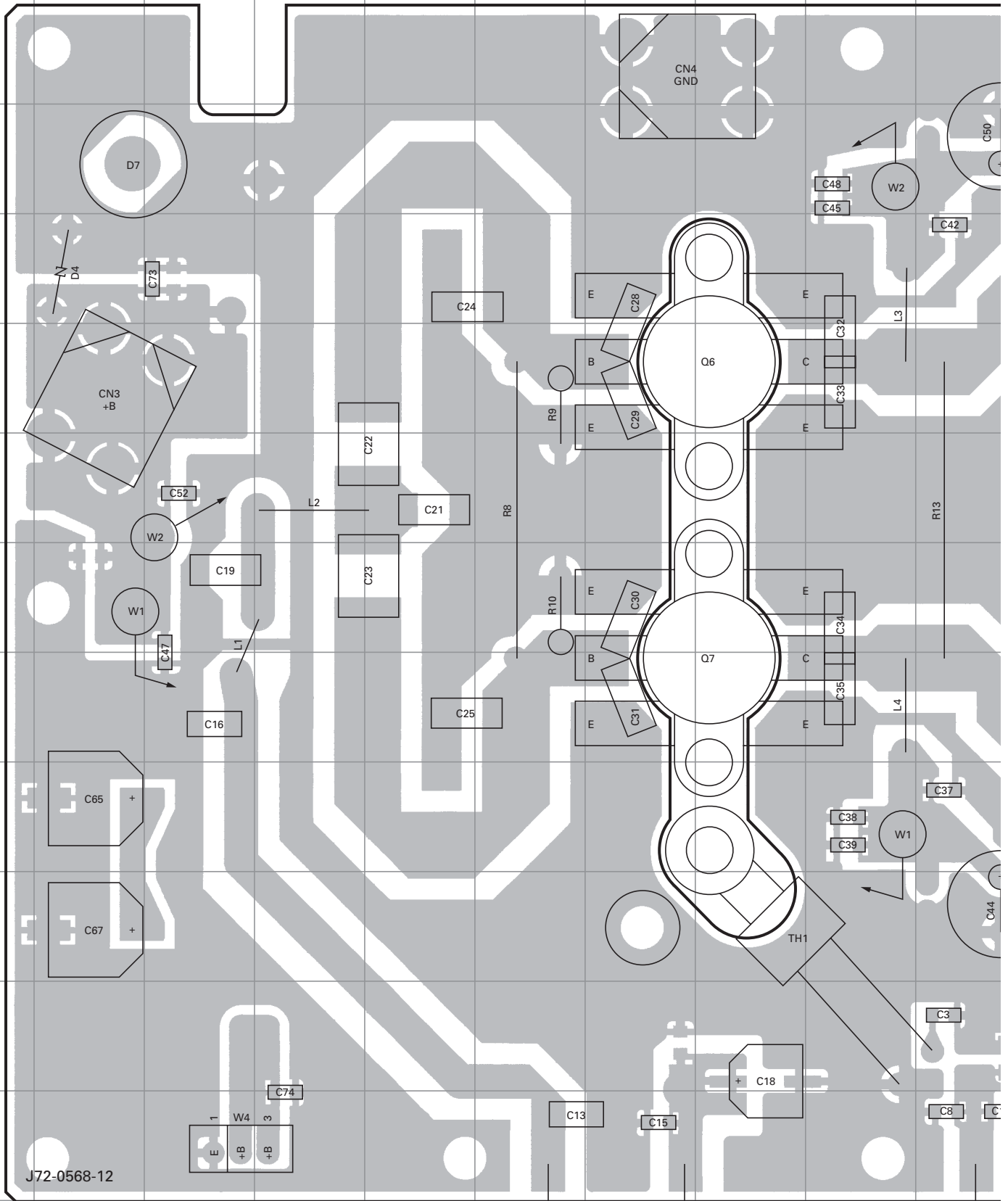

# PC BOARD TK-790H(B)

## FINAL UNIT (X45-3560-10) Component side view (J72-0568-12)

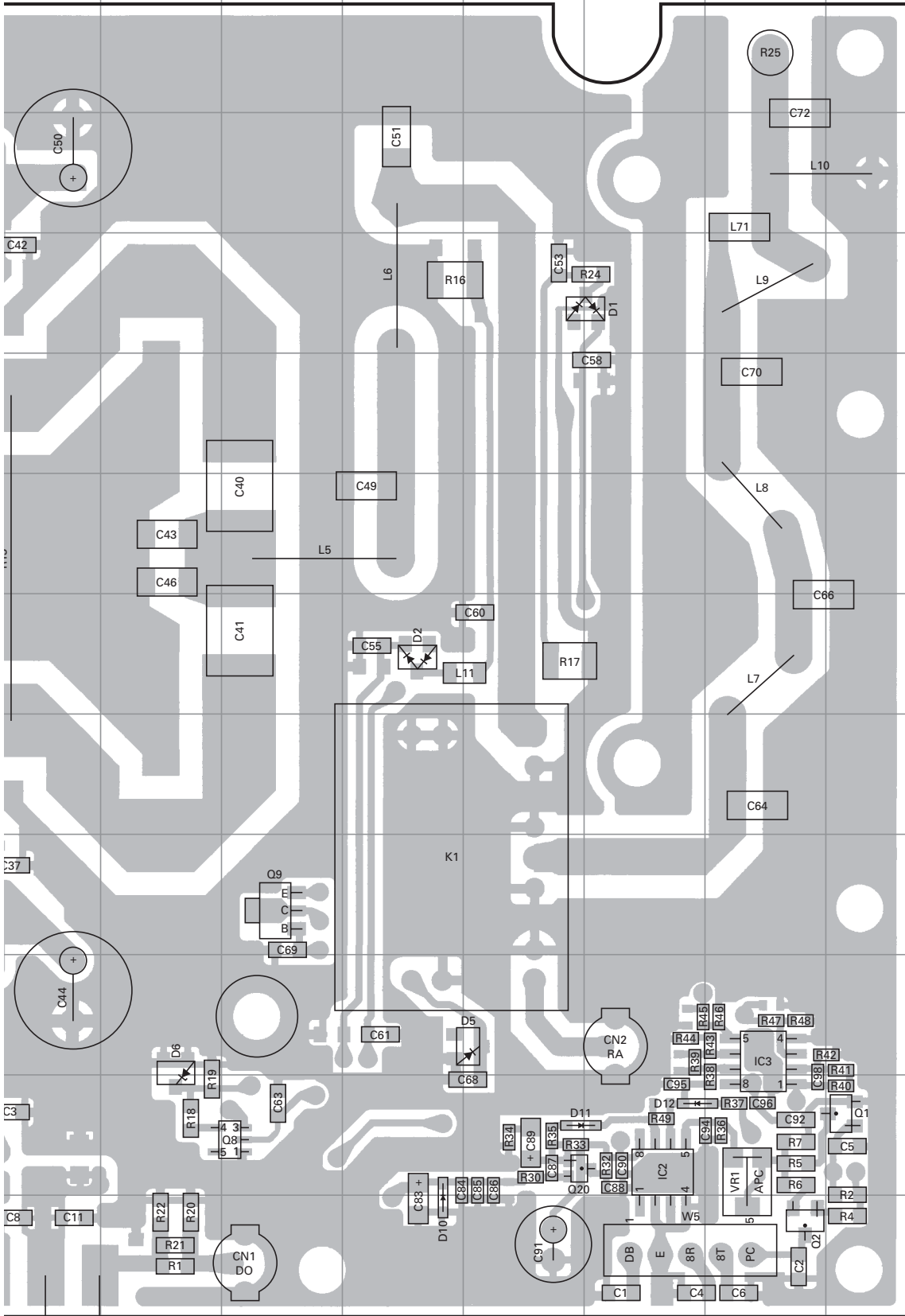

Ref. No.	Address
IC1	13H
IC2	11O
IC3	10P
Q1	11Q
Q2	12P
Q6	5H
Q7	8H
Q8	11L
Q9	9L
Q20	11N
D1	4O
D2	7M
D4	4B
D5	10N
D6	10K
D7	3B
D10	12M
D11	11N
D12	11O

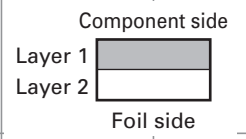

# TK-790H(B) PC BOARD

# PC BOARD TK-790H(B)

FINAL UNIT (X45-3560-10) Component side view (J72-0568-12)

FINAL UNIT (X45-3560-10) Component side view (J72-0568-12)

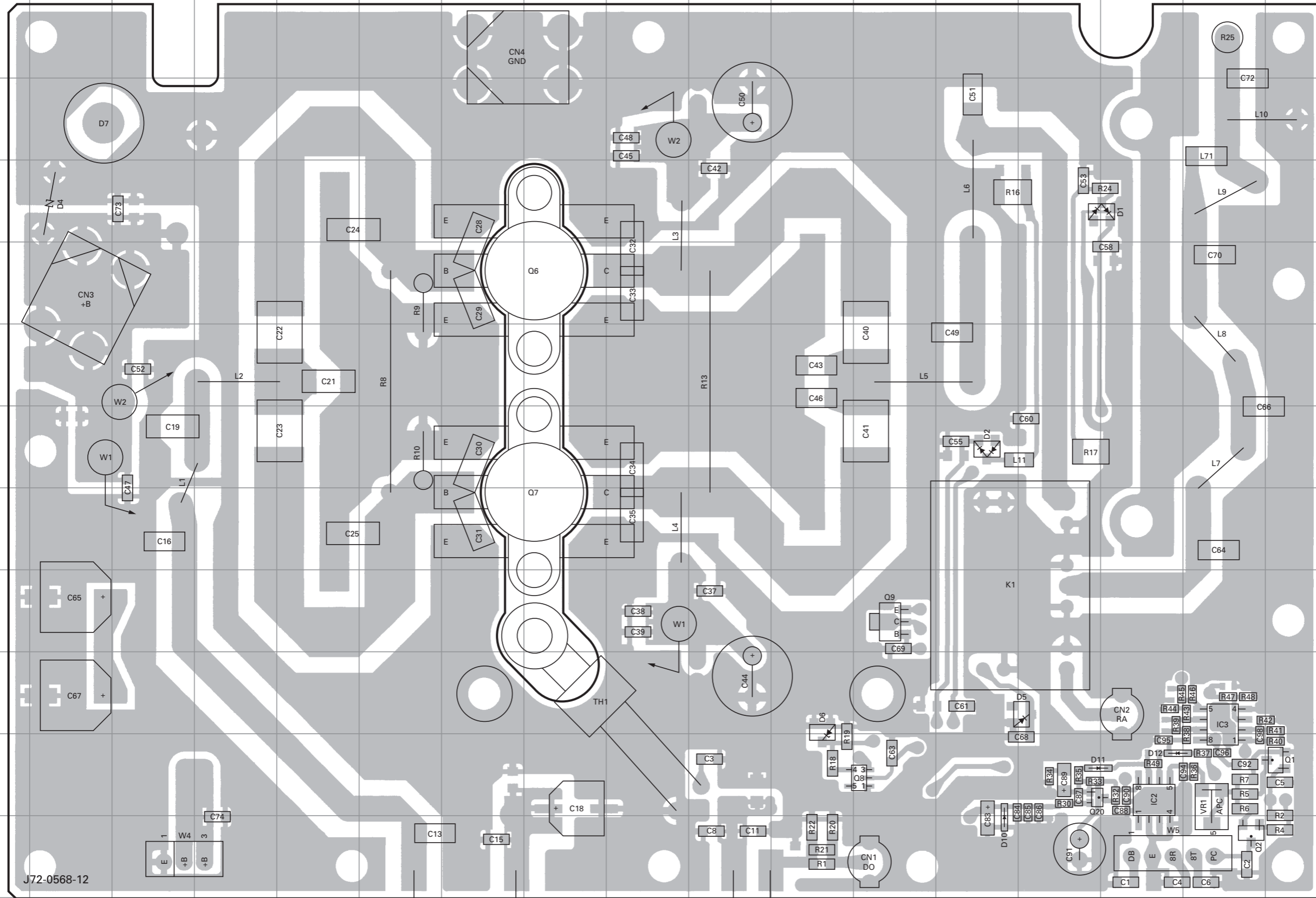

Ref. No.	Address
IC1	13H
IC2	11O
IC3	10P
Q1	11Q
Q2	12P
Q6	5H
Q7	8H
Q8	11L
Q9	9L
Q20	11N
D1	4O
D2	7M
D4	4B
D5	10N
D6	10K
D7	3B
D10	12M
D11	11N
D12	11O

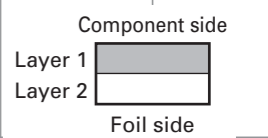

J72-0568-12

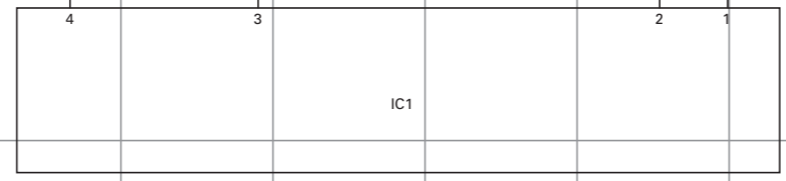

A B C D E F G H I J

# TK-790H(B) PC BOARD

FINAL UNIT (X45-3560-10) Foil side view (J72-0568-12)

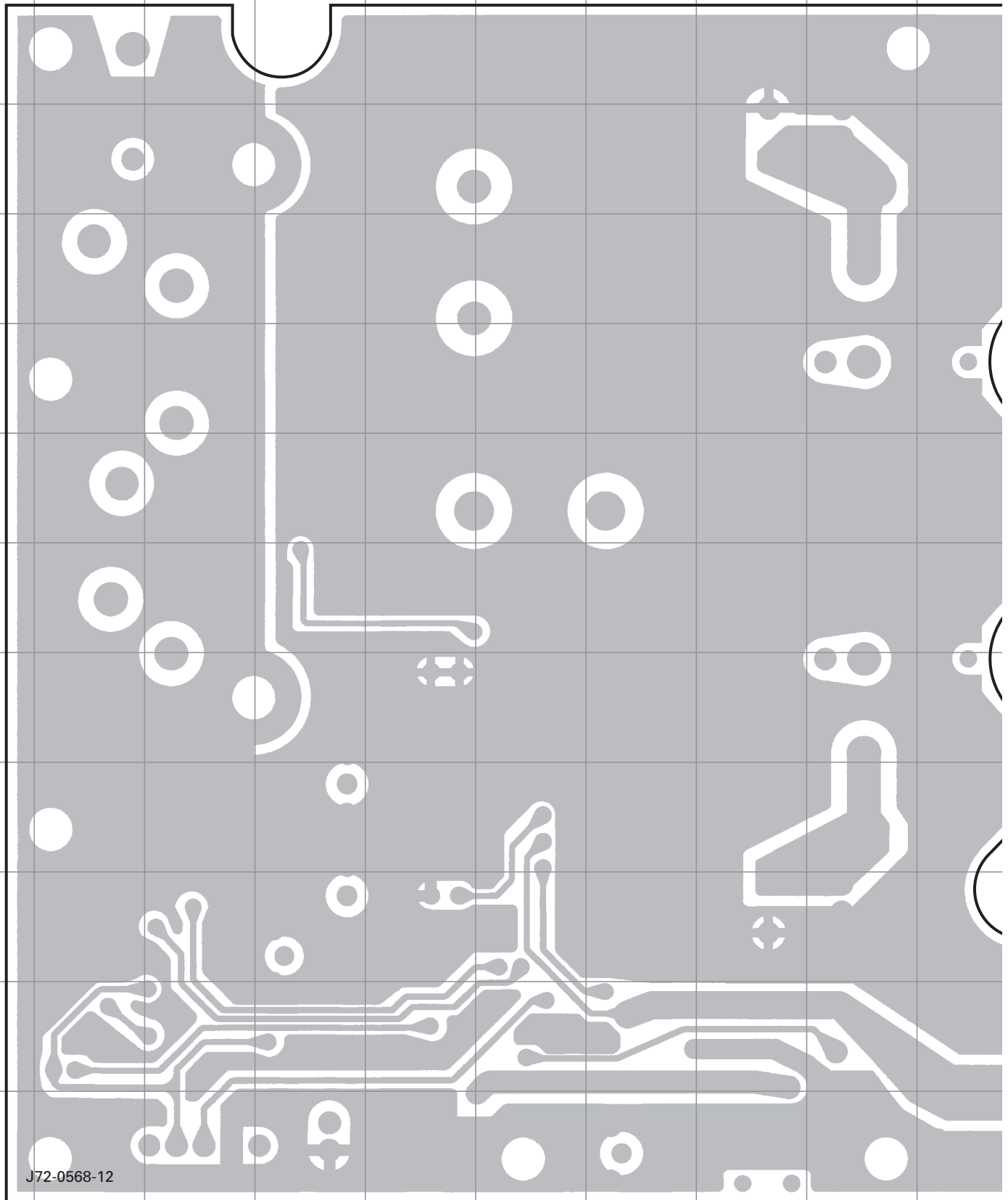

J72-0568-12

# PC BOARD TK-790H(B)

FINAL UNIT (X45-3560-10) Foil side view (J72-0568-12)

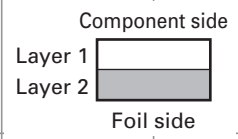
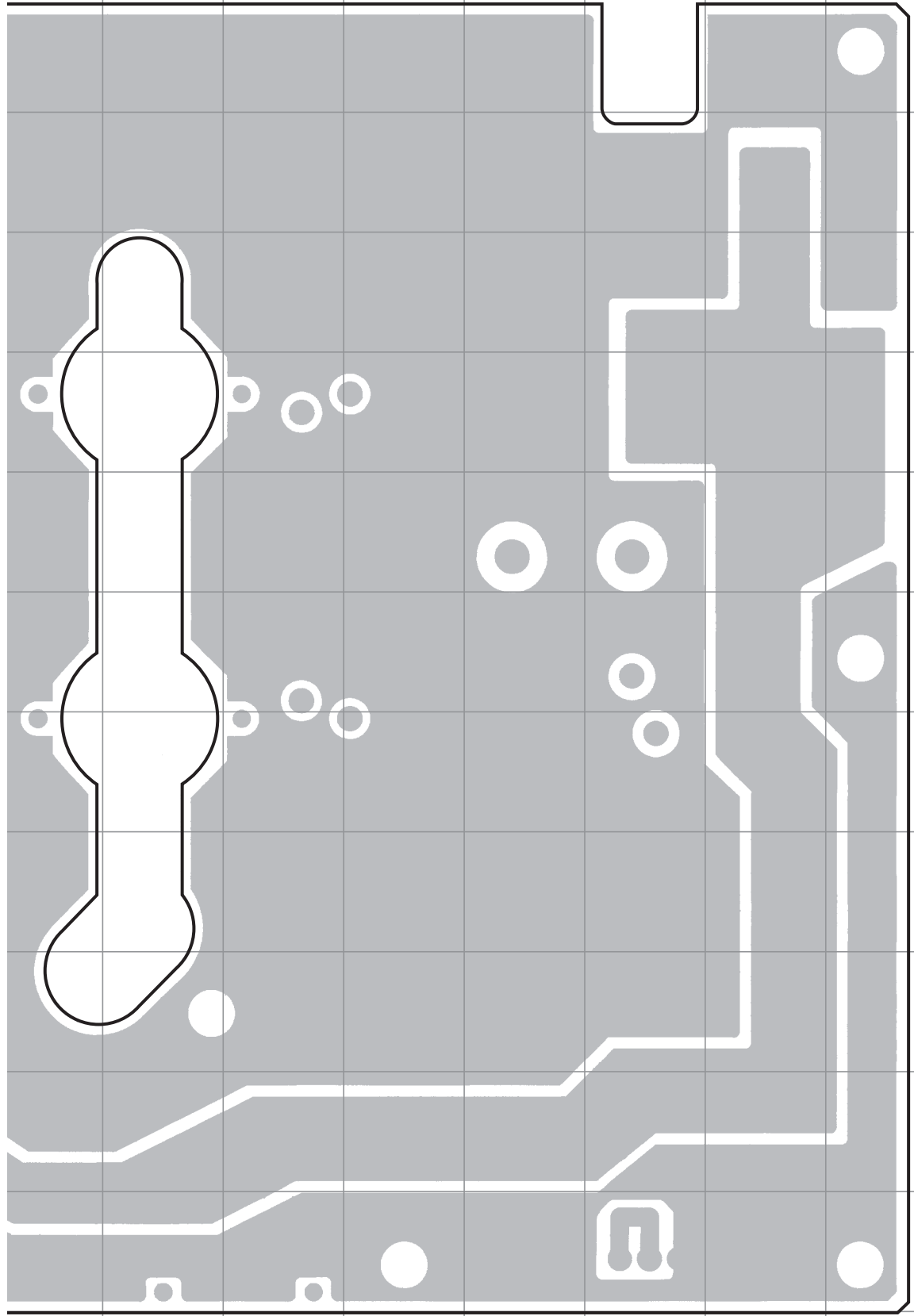

1  
2  
3  
4  
5  
6  
7  
8  
9  
10  
11  
12  
13  
14



# TK-790H(B) PC BOARD

# PC BOARD TK-790H(B)

FINAL UNIT (X45-3560-10) Foil side view (J72-0568-12)

FINAL UNIT (X45-3560-10) Foil side view (J72-0568-12)

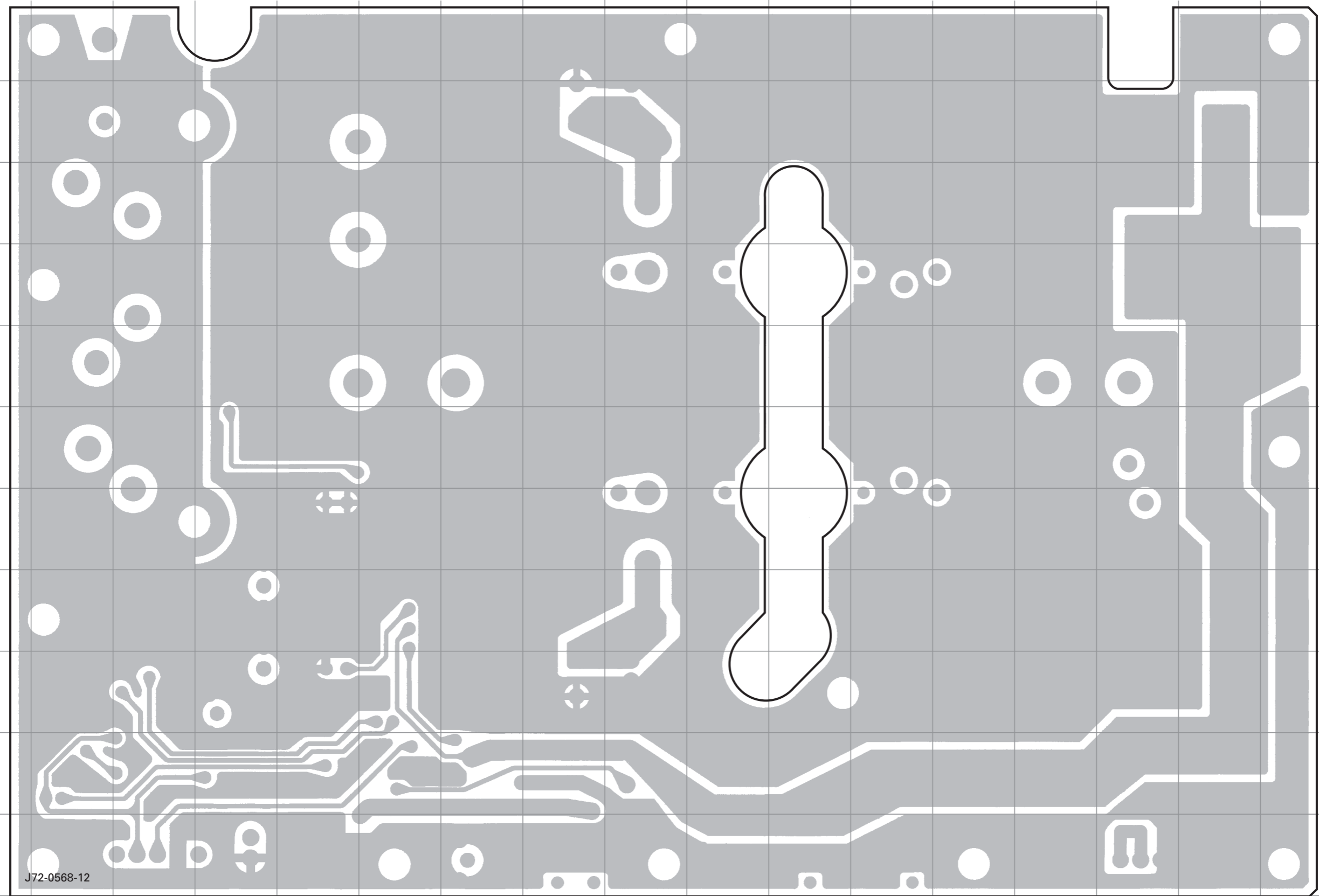

J72-0568-12

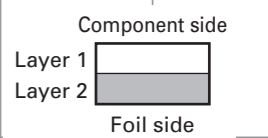

# TK-790H(B) SCHEMATIC DIAGRAM

FINAL UNIT (X45-3560-10) : TK-790H(B)K

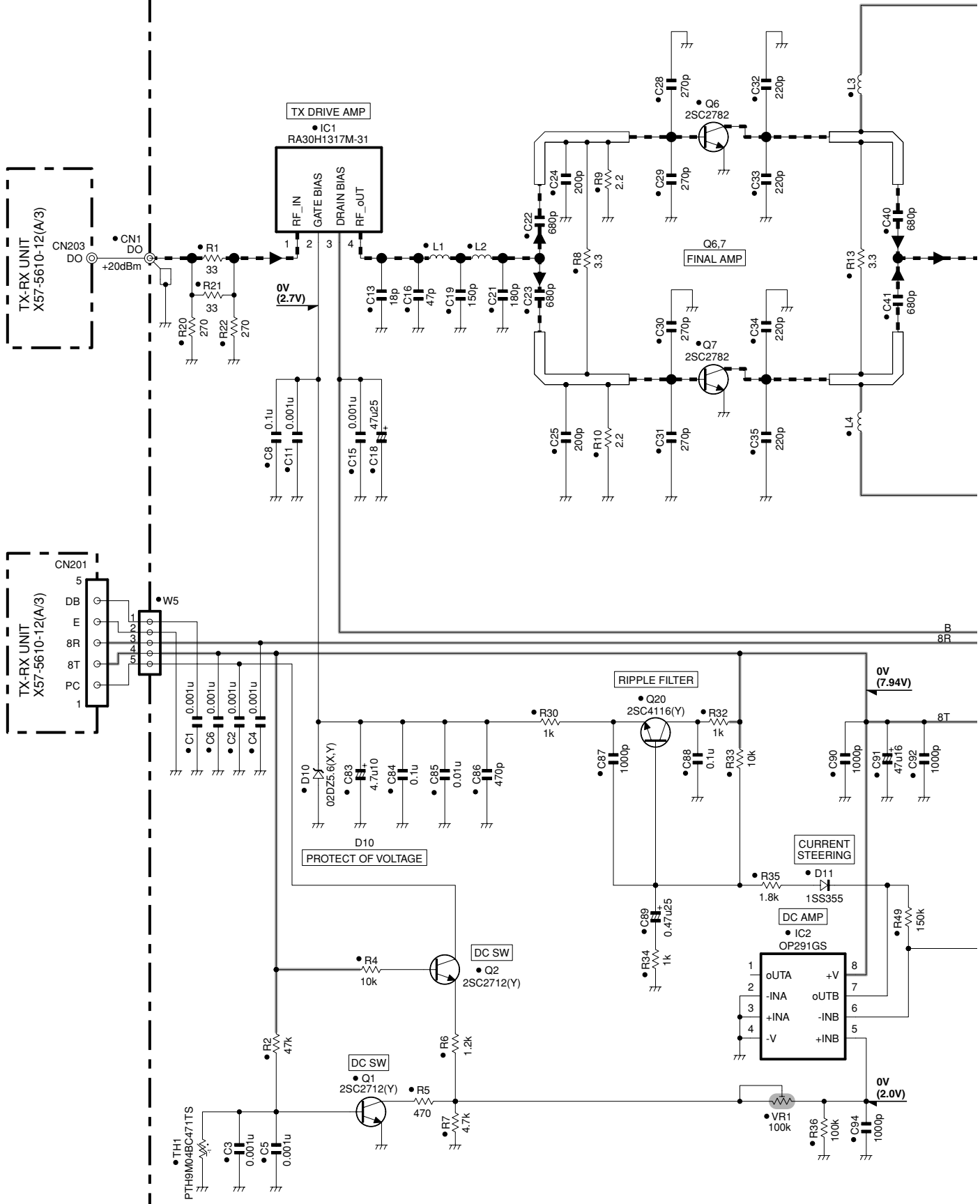

# SCHEMATIC DIAGRAM TK-790H(B)

FINAL UNIT (X45-3560-10)

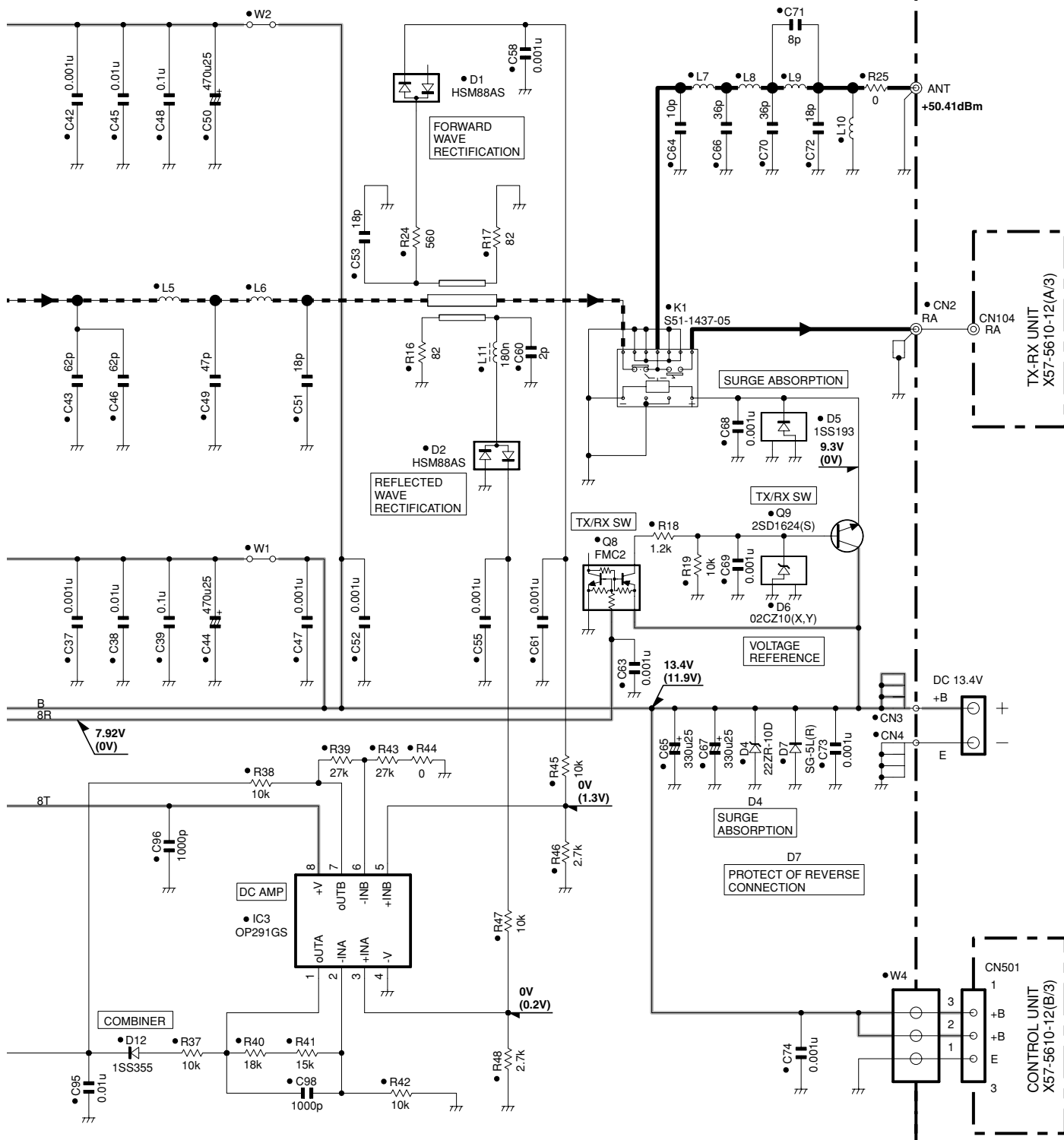

Note : The components marked with a dot (•) are parts of layer 1.

FINAL UNIT (X45-3560-10) : TK-790H(B)K

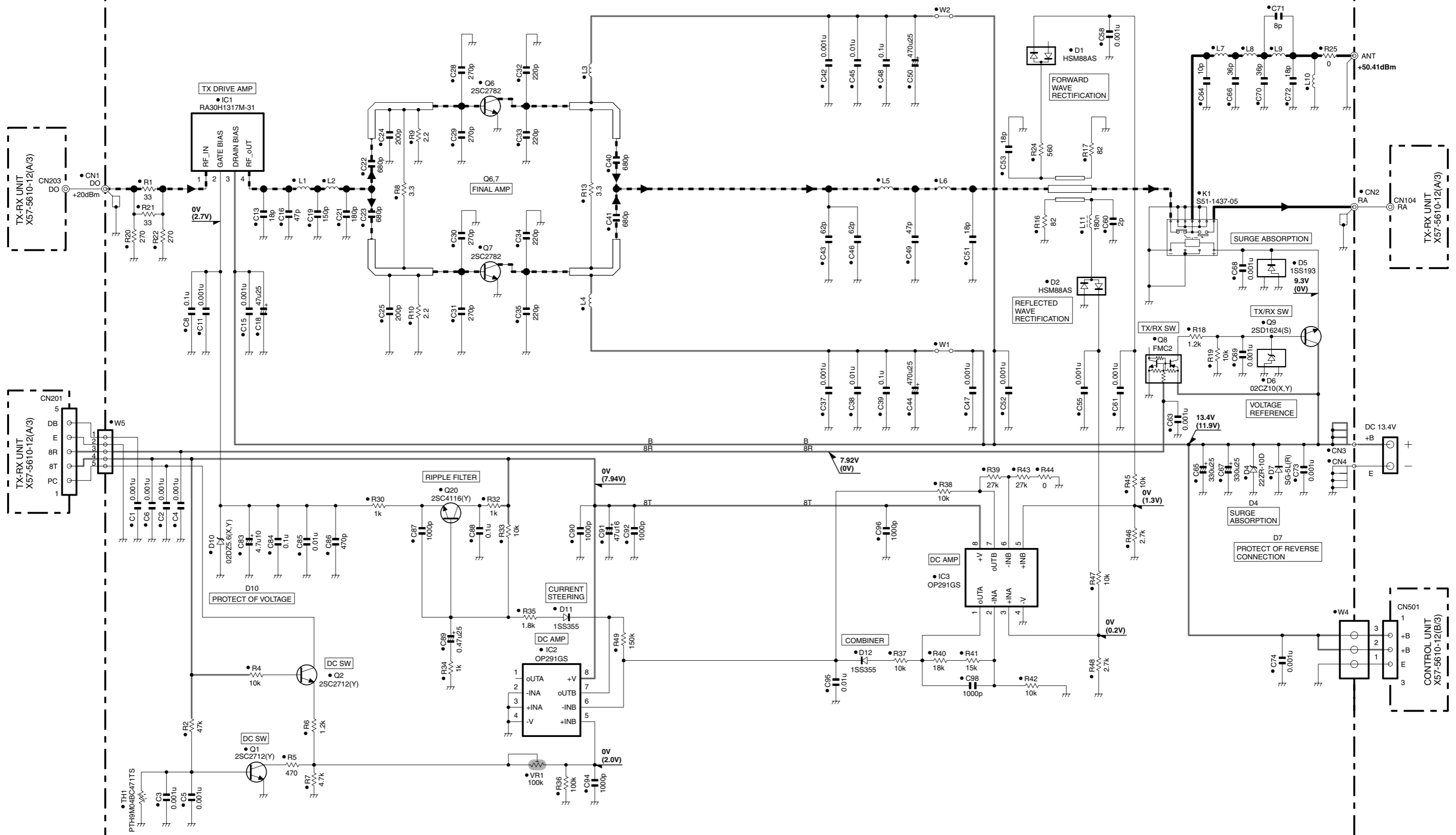

# TK-790H(B)

## **Kenwood Corporation**

2967-3, Ishikawa-machi, Hachioji-shi, Tokyo, 192-8525 Japan

### **Kenwood U.S.A. Corporation**

P.O. BOX 22745, 2201 East Dominguez Street, Long Beach, CA 90801-5745, U.S.A.

### **Kenwood Electronics Canada Inc.**

6070 Kestrel Road, Mississauga, Ontario, Canada L5T 1S8

### **Kenwood Electronics Deutschland GmbH.**

Rembrücker Str. 15, 63150 Heusenstamm, Germany

### **Kenwood Electronics Belgium N.V.**

Leuvensesteenweg 248 J, 1800 Vilvoorde, Belgium

### **Kenwood Electronics France S.A.**

13, Boulevard Ney, 75018 Paris, France

### **Kenwood Electronics U.K. Ltd.**

KENWOOD House, Dwight Road, Watford, Herts., WD18 9EB United Kingdom

### **Kenwood Electronics Europe B.V.**

Amsterdamseweg 37, 1422 AC Uithoorn, The Netherlands

### **Kenwood Electronics Italia S.p.A.**

Via G. Sirtori, 7/9 20129 Milano, Italy

### **Kenwood Electronics Iberica S.A.**

Bolivia, 239-08020 Barcelona, Spain

### **Kenwood Electronics Australia Pty. Ltd.**

(A.C.N. 001 499 074)

16 Giffnock Avenue, Centrecourt Estate, North Ryde, N.S.W. 2113 Australia

### **Kenwood Electronics (Hong Kong) Ltd.**

Unit 3712-3724, Level 37, Tower one Metroplaza, 223 Hing Fong Road, Kwai Fong, N.T., Hong Kong

### **Kenwood Electronics Singapore Pte. Ltd.**

1 Ang Mo Kio Street 63, Singapore 569110