

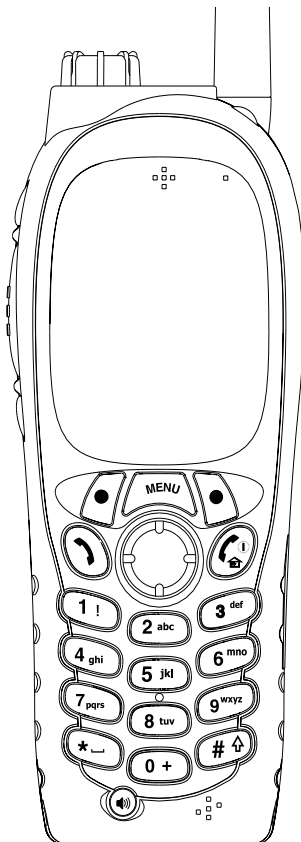

MTH800

TETRA Handportable Terminal Feature User Guide



6802972C35-O

11/08/2004

Contents

Safety Information	1
General Safety Information	1
Copyright Information	1
Product Specific Information	2
Getting Started	3
How to Use this Guide	3
Installing the Battery	4
Replacing the Battery	5
Charging the Battery	5
Battery Capacity Information	6
Battery Maintenance	6
Attaching the Antenna	8
Controls and Indicators	9
Powering On/Off (On-Off/End/Home Key)	11
Powering On (Emergency Button)	12
Powering On with Transmit Inhibit (TXI) Active	12
Unlocking the MTH800	12
Locking/Unlocking the Keys/Buttons	13
Selecting Your Network	13
How to Hold Your MTH800	13
Use in Low Audio (Phone, PABX, and Full-duplex Private Calls)	14
Use in High Audio (Group and Private Calls)	14
Lapel/Shoulder Use	14
Speakerphone Use	14
Looking after your MTH800	14
The Display	15
Home (Idle) Display	15
Status Icons	15
The LED Status Indicator	17
Key, Knob, and Button Overview	17
Soft Keys	17
Menu Key	17
Rotary Knob	18

Emergency Button	19
Function Keys	19
Speaker Control Key	21
Aliases (Names)	21
Screen Saver	22
Home Display Text Message	22
Terminal Disable/Enable	23
Selecting TMO or DMO Operation	23
General	23
Entering TMO or DMO	24
TMO Calls	24
DMO Calls	25
Making Calls	25
Modifying the Type of Call	25
Receiving Calls	25
Preemptive Calling	26
Receiving an Emergency Group Call during a Call	27
Receiving a Private PPC during a Call	27
Broadcast Call	28
Ambience Listening (AL)	28
Cancelling a Call	29
Using In-call Features	29
Local Area Service	30
TMO Group Call	32
General	32
Dual Microphone Feature	33
Selecting a Group	33
Using the Rotary Knob	34
Using the Navigation Key	34
Using Alphabetic Search	34
Using Folder Search	34
Selecting a Folder	35
Using the Navigation Key	35
To Select a Folder	35
“My Groups” Folder	35
Selecting My Groups	35
Adding/Deleting Groups from My Groups	35

Group Scrolling Configuration	35
Activating/deactivating Scanning	36
Making a Group Call	36
Receiving a Group Call	37
General	37
Receiving a Group Call in Idle Screen with Scan Off	38
Receiving a Group Call in Idle Screen with Scan On	38
Receiving a Group Call during an On-going Group Call	39
Receiving an Emergency Group Call	39
Receiving a Broadcast Call	39
Transmit Inhibit	39
Dynamic Group Number Assignment (DGNA)	40
DGNA Reception with Notification Message	40
DGNA Reception without Notification Message	41
DMO Group Call	42
General	42
Dual Microphone Feature	42
“My Groups” Folder	42
Selecting the My Groups Folder	43
Adding/Deleting Groups from the My Groups Folder	43
Selecting a Group	43
Selecting a Folder	43
Making a DMO Group Call without Gateway	43
Making a DMO Group Call via Gateway	43
Receiving a DMO Group Call	45
Receiving an Emergency Group Call	46
Transmit Inhibit	46
Exiting DMO	46
Private Call	47
General	47
Dual Microphone Feature	47
Making a Private Call	47
Other Ways of Dialing	48
Dialing via Contact List	48
Short Number Dial	48
Recent Calls List	48
One-touch Dial	49

Calling a Number in a Message	49
Receiving a Private Call	49
Making a Private PPC (Preemptive Priority Call)	49
Call Queuing	50
Phone and PABX Calls	51
General	51
Dual Microphone Feature	51
Making a Phone or PABX Call	51
Other Ways of Dialing	52
Dialing via the Contact List	52
Speed Dial	52
One-touch Dial	52
DTMF Overdial	53
Recent Calls List	53
Calling a Number in a Message	53
Answering a Phone or PABX Call	53
Emergency Operation	54
General	54
Dual Microphone Feature	54
Entering TMO or DMO	54
Important Information	54
Emergency in TMO	54
Overview	54
Changing Folder or Group	55
Entering or Exiting Emergency Mode	55
Sending an Emergency Alarm	56
Making an Emergency Group Call	57
Hot Microphone Feature	57
Receiving an Emergency Group Call	58
Making an Emergency Private Call	58
Receiving an Emergency Private Call	59
Modifying the Type of Call	59
Emergency in DMO	59
General	59
Changing Folder or Group	60
Making an Emergency Group Call	60
Receiving an Emergency Group Call	60

GPS Location Services	61
Enhancing GPS Performance	62
GPS Icon	63
GPS Enable/Disable	63
Entering GPS Location Service	64
Viewing Your Position	64
GPS Testpage	65
Entering the Testpage	66
The Menu	69
To Enter the Menu Items	69
To Return to the Previous Level	69
To Exit the Menu Items	70
Menu Icons	70
List of Menu Items	71
Messages	74
Contacts	74
General	74
Contact Icons	74
Creating a Contact	75
Editing a Contact	76
Deleting a Number	76
Deleting a Contact	76
Checking Capacity	76
Security	77
PIN Protect	77
Change Code	78
Locking/Unlocking the Keypad	79
Air Encryption On/Off	79
Encryption Key Deletion	80
K Validity	80
SCK Validity	81
Setup	81
Entering the Setup Sub-menu	81
Setting the Vibrate Feature	81
Setting the Ring Style	82
Setting the Volume	83
Setting the Display's Working Language	83

Setting Up the Data Function	83
Setting Group Audio	84
Setting Tones	85
Display Features	86
Setting the Display's Vertical Flip	87
Setting the Text Size	88
Setting the Screen Saver	88
Setting the Backlight	89
Setting the Wallpaper	89
Setting the Contrast	90
Entering More...	90
Entering Group Setup	90
Entering Scan	90
Setting Group Scanning	91
Viewing the Active Scan List	92
Editing Scan Lists	93
My Groups (TMO/DMO)	95
Selecting a Group from My Groups	95
Adding a Group to My Groups	95
Deleting a Group from My Groups	95
Deleting All Groups from My Groups	96
Viewing/Modifying Personal Information	96
Recent Calls	96
Viewing Recent Calls	97
Storing Recent Calls to Contacts	97
Deleting Recent Calls	98
Calling from Recent Calls	98
Shortcuts	99
Help on Creating a Menu Shortcut	99
Creating Menu Shortcut	99
Viewing the Menu Shortcut List	99
Editing Shortcuts	99
Deleting Shortcuts	100
Shortcut Display Messages	100
Menu Shortcut Use	100
Networks	101
Entering the Networks Sub-menu	101

Selecting Your Network	101
Selecting Trunked Mode	102
Selecting Direct Mode	102
Setting Transmit Inhibit (TXI) Mode	102
GPS Location Services	103
Messages	104
General	104
Sending a Text Message	104
Receiving Messages	105
Displaying Long Text Messages	105
Entering the Messages Sub-menu	106
New Message	106
Creating a Message	106
Sending the Message	106
Using the Inbox	107
Inbox Icons	107
Entering the Inbox	107
Reading a Message in the Inbox	108
New Message Received	108
Handling Messages	108
Calling a Number in a Message	109
User Defined Templates	110
Predefined Templates	110
Sending a Status Message to a Group	112
Targeted Status	112
Writing Text	114
Selecting the Text Entry Mode	114
Adding Secondary to the List of Text Entry Modes	114
Selecting the Text Entry Method and Language	114
Icons	115
TAP Display	116
iTAP Display	116
Keys Usage	117
Other Keys	120
Writing in iTAP Alphanumeric	121
Word Locking	122
Writing in Numeric Mode	122

Writing in Symbol Mode	122
Writing in TAP Alphanumeric	122
Adding Words to the Dictionary	123
What to do if...	124
Tones	128
Appendix A. Accessories	132
Index	134
Quick Reference Guide	139

© Motorola Inc., 2004

MOTOROLA and the Stylized M Logo are registered in the U.S. Patent and Trademark Office. All other product or service names are the property of their respective owners.

Safety Information

General Safety Information

- This terminal meets the applicable safety standards if used as prescribed. All operating and safety instructions are to be followed carefully.



CAUTION! *Before using this product, read the operating instructions for safe usage contained in the Product Safety and RF Exposure booklet, Motorola Publication part number 6866537D38 (for Europe, Middle East and Africa regions) or 6804110J47/6804113J24 (for Asia and Pacific regions), enclosed with your radio.*

- Motorola recommends the usage of Motorola approved accessories only.
- Only specialized workshops should be contacted for installation, maintenance and repair work.
- Keep this **User Guide** and the **Product Safety and RF Exposure booklet** in a safe place and make it available to other operators, and in case, that the radio is passed on to other people.

Copyright Information

The Motorola products described in this manual may include copyrighted Motorola computer programs stored in semiconductor memories or other mediums. Laws in the United States and other countries preserve for Motorola certain exclusive rights for copyrighted computer programs, including the exclusive right to copy or reproduce in any form the copyrighted computer program. Accordingly, any copyrighted Motorola computer programs contained in the Motorola prod-

ucts described in this manual may not be copied or reproduced in any manner without the express written permission of Motorola. Furthermore, the purchase of Motorola products shall not be deemed to grant either directly or by implication, estoppel, or otherwise, any licence under the copyrights, patents, or patent applications of Motorola, except for the normal non-exclusive royalty-free licence to use that arises by operation of the law in the sale of a product.

Product Specific Information

- Max. Voltage 4.2 V
- Max. Current 0.5 A
- Max. RF Power 1 Watt
- Max. Speaker Load 0.5 Watts at 8 Ohms
- Antenna Impedance 50 Ohms
- Operation Temperature Range -20° C to +60° C
- Operating Time Continuous / Intermittent



Note: *In general, the radio transmit and receive time (operating cycle time) is determined by the communication system. On overload, respectively on extensive use beyond the systems specifications at high ambient temperatures, the radio is protected by its thermal control, which cuts down the RF output power, thus reducing the radio coverage range.*

Getting Started

Congratulations on your purchase of the Motorola MTH800. Enhanced TETRA features and state-of-the-art technology help to keep you in constant touch with all of your work and personal contacts.

You can operate your MTH800 in English, German, French, Spanish, Dutch, or in a language defined by your Service Provider. The default setting from factory is English. For more information, please see “Setting the Display’s Working Language” on page 83.

How to Use this Guide

This guide describes the MTH800 features as setup and pre-programmed at the factory.

Your Service Provider or your organisation may have customised your MTH800 to optimise its use for your individual needs. Check with your Service Provider or organisation to find out the differences from this guide.

Throughout the text in this publication, you will notice the following special notations used to highlight certain information or items:

Example	Description
 or Select	Key presses are shown as a key symbol or in bold print for soft key functions.
More...> Networks > TXI Mode > Activate	Indicates navigation in menu items.
Contacts	Highlighted text indicates the selection.
✓On	Indicates the active setting.

Example	Description
Status Delivered	Information appearing on the MTH800 display is shown in special print.
<User Defined>	Indicates a prompt or message configured by your Service Provider.
	A Note contains additional information which is relevant to the item feature.

Installing the Battery

1. Remove the battery from its protective clear plastic case.
2. If necessary, remove the battery cover as shown below.
3. Insert the battery top into the compartment as illustrated.
4. Carefully press the battery silver bottom downward until it clicks into place.
5. Replace battery cover.

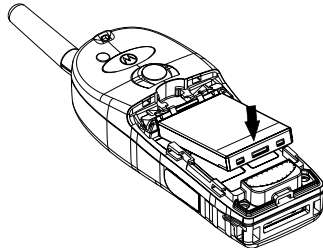
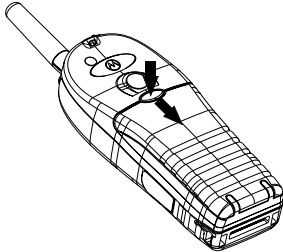

Replacing the Battery

1. To remove the battery cover, push down the cover button. Slide the cover away.
2. Push retaining clip up and then lift the top of the battery out.
3. Replace the battery.

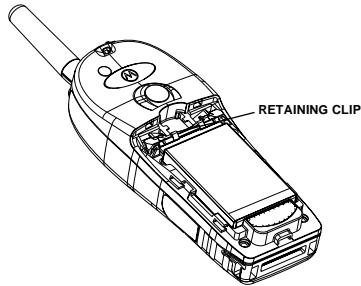

Charging the Battery

Motorola approved chargers provide optimum performance. Other chargers may not fully charge your Motorola Lithium-Ion battery or may reduce the life of the battery.

The MTH800 can be either **On** or **Off** during charging.

1. Insert the connector on the charger into the socket at the base of the MTH800. Select the required plug adapter (UK or European type) and connect to the charger. Then plug the charger into a suitable mains socket.
2. The MTH800 displays the **Charger Connected** message only if the MTH800 is **On** when connecting the charger. If the MTH800 is **Off**, the display shows an icon of the battery in charging.

The Battery icon shows the charging status (see below).



Empty



Full



Empty



Full

Battery Capacity

Battery Charge Progress

Battery Capacity Information

Information	Description
Green icon	Full (70% - 100% capacity)
Yellow icon	Middle (40%-70% capacity)
Red icon	Low (10% - 40% capacity)
Empty icon	Very low (5%-10% capacity)
Low Battery message	Less than 5% capacity

Battery Maintenance

The performance of the rechargeable battery delivered with your terminal depends on the way the battery is treated.

Therefore, to comply with the Motorola warranty for batteries and to assure high performance and a long life cycle of your Motorola rechargeable battery, please read and follow the maintenance rules stated below.

Storage

Do not store your battery where the temperatures will exceed 65 °C or fall below -20 °C.

New Lithium-Ion batteries (i.e. batteries that have never been charged before) may be stored for up to 2 years (with up to 50% of maximum charge) in well ventilated, cool and dry areas with some capacity loss in life cycle.

Batteries, which have already been charged and then stored for more than 2 months should be recharged overnight (14-16 hours) before use.

Extending Battery Life

A battery is an expendable part and may need replacing during the life of the terminal. To ensure maximum service life of your handset, always replace the battery with a genuine Motorola replacement.

In order to ensure maximum life from your battery, do not place the handset and/or battery in the charger, unless you really want to charge the battery.

Battery Charging Temperature

Your charger will only charge your battery when it is at temperature range of 1 °C to 37°C.

This is due to the fact that the internal battery cell can be charged in the temperature range of 0 °C to 45 °C.

As the temperature gets colder (close to 0 °C) less capacity is stored in the battery.

If, during charging, the temperature is out of range, the battery might not be fully charged since the charging is temporarily stopped until the temperature becomes suitable.

The range of battery operation is from 0 °C to +45 °C in charger mode and from -10 °C to +60 °C in discharge (application) mode.

First Time Battery Charging

Always charge your new battery/(whichever type) overnight (14-16 hours) before using it. This is referred to as Initialising and will ensure maximum battery start capacity.

Battery Charging Rules

Generally, to reduce the number of charge cycles as much as you can wait for Low Battery message to charge as this will ensure maximum battery life.

Do not use your charger as a terminal stand or leave your terminal and fully charged battery connected to the charger whilst not charging. Continuous charging will shorten the battery life.

Attaching the Antenna



Turn the MTH800 Off before installing or removing the antenna.

Insert the bottom of the antenna into the screw-in base on the top of the MTH800. Turn counter clockwise until snug. **Do not force.**

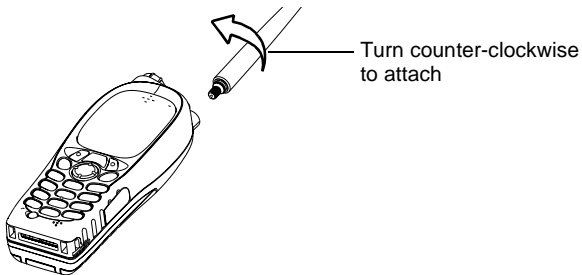

Controls and Indicators

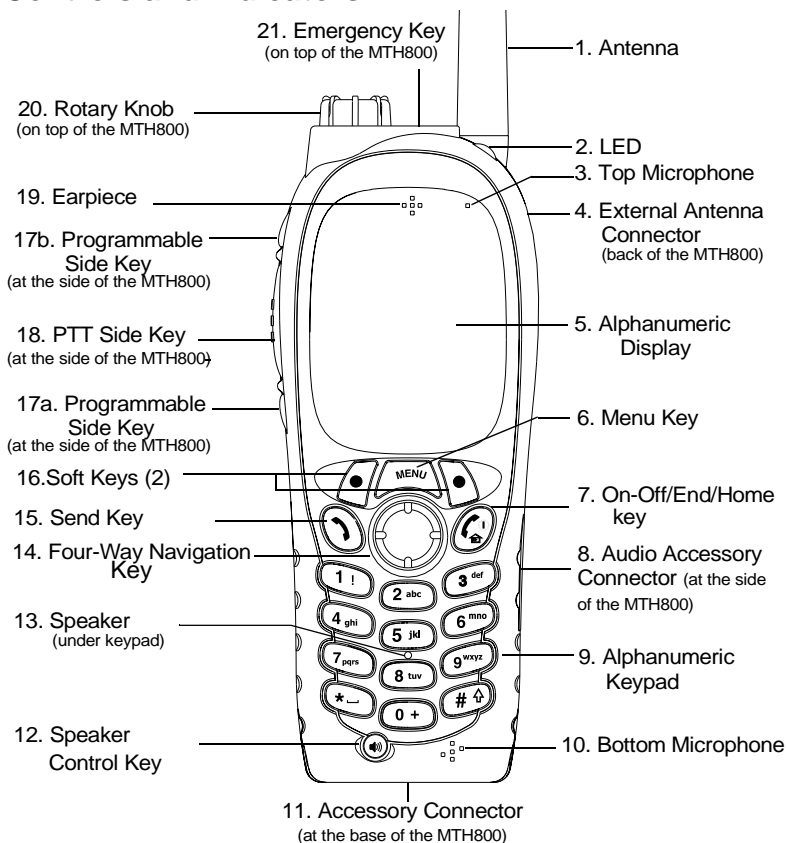

Number	Description
1	Antenna
2	LED (Indicator)
3	Top Microphone Activated during half-duplex, high-audio calls such as Group Calls.

Number	Description
4	External Antenna Connector Used with the digital car kit to connect the RF signal to the external antenna. (At the back of the MTH800)
5	Colour Display Provides alphanumeric text and images within 65,536 colours and 130 x 130 pixels with backlighting and scalable fonts.
6	Menu Key Used to enter the main menu and the context sensitive menu.
7	On-Off/End//Home Key Press and hold to turn the MTH800 On/Off. Press to end calls. Press to return to the Home display (idle screen).
8	Audio Accessory Connector (At the side of the MTH800)
9	Alphanumeric Keypad Use the keypad to enter alphanumeric characters for dialing, contact entries and text messages.
10	Bottom Microphone Activated during half-duplex and full-duplex, low-audio calls such as Phone Calls.
11	Accessory Connector Provides connection for accessories. (At the base of the MTH800)
12	Speaker Control Key Selects earpiece (low audio) or speaker (high audio)
13	Speaker (under keypad)
14	Four-Way Navigation Key Press up, down, left or right for list scrolling, while moving around the menu hierarchy, or for alphanumeric text editing.
15	Send Key Used to initiate or answer full-duplex calls (such as Phone Calls), or send status and text messages.

Number	Description
16	Soft Key(s) Press to select the option that appears in the display directly above the left or right soft key.
17	Programmable Side Keys 1 and 2 Default programming: upper Side key activates/deactivates Backlight; lower Side key activates Screen Saver. (See also No. 19)
18	Push-To-Talk Button (PTT) Press and hold this side button to talk in half-duplex calls, release it to listen. Press to send status and text messages.
19	Earpiece
20	Programmable Rotary Knob Default programming: "Dual" - Press the knob to toggle between "volume" and "list". Side keys (No. 17) operate as programmed.
21	Programmable Emergency Button (on top of the MTH800) Press and hold to enter Emergency mode, and send Emergency Alarms (as programmed). Press and hold to start an Emergency Private Call (half-duplex or full-duplex). When the MTH800 is Off, press and hold to power on in Emergency Operation or in standard mode (as programmed).



Before using your MTH800 for the first time, remove the plastic lens protector from the display, and charge battery overnight to ensure battery is initialised to it's full capacity.

Powering On/Off (On-Off/End/Home Key)

To power **On**, press and hold . Your MTH800 performs a self-check and registration routine. After successful registration, the MTH800 is in service.

To power **Off**, press and hold . You will hear a beep and the **Powering Off** message is displayed.

Powering On (Emergency Button)

Press and hold the Emergency button to power **On**.

The MTH800 will power **On** in Emergency Operation or in standard mode (as programmed).

Powering On with Transmit Inhibit (TXI) Active

Transmit Inhibit is a feature allowing you to switch off transmission before entering a Radio-Frequency (RF) sensitive area. To activate this feature, press  and select **More...> Networks > TXI Mode > Activate**.



Pressing the Emergency button, even if Transmit Inhibit is activated, causes the MTH800 to transmit immediately. The MTH800 must **NOT** be within the RF sensitive area when entering Emergency Operation.

The TXI Mode remains active at power **On**. You will be asked whether to leave the TXI Mode **On** or not.



Ensure you have left the RF sensitive area before deactivating Transmit Inhibit.

Press the **Yes** key to deactivate the TXI Mode. If the MTH800 was previously used in Trunked Mode, it will register to the network. If the MTH800 was previously used in Direct Mode, it will remain in Direct Mode.

Press **No** in Trunked Mode and the MTH800 powers down; press **No** in DMO and you remain in DMO with TXI selected.

Unlocking the MTH800

Your MTH800 may be locked at power up.

To unlock the MTH800 after powering on, enter the code at the prompt. The MTH800 enters the default Home display.



The unlock code is originally set to 0000. Your Service Provider may change this number before you receive your terminal.

Locking/Unlocking the Keys/Buttons

Press  .



When there is an incoming call and the keypad is locked, you can still use

PTT, Rotary knob, ,  and .



The Emergency button is not locked. Pressing the Emergency button unlocks all keys.

Selecting Your Network

Before you start operating your MTH800, you can select the network you want your MTH800 to be registered to. For detailed information, see “Networks” on page 101.

How to Hold Your MTH800

The terminal has two microphones: a top microphone for half-duplex dispatcher calls and a bottom microphone for full-duplex telephone-like calls.

A call can be placed in high or low audio. To activate low or high audio, see page 21.

In high audio the user transmits via the top microphone and listens via the internal speaker.

In low audio the user speaks into the bottom microphone and listens via the earpiece.

Group and Private Calls are half-duplex calls and can be placed in high or low audio.

Phone, PABX, and full-duplex Private Calls are placed in low audio. The speakerphone feature allows to hold Phone, PABX, and full-duplex Private Calls via the MTH800 internal speaker.

Use in Low Audio (Phone, PABX, and Full-duplex Private Calls)

When placing or receiving a call and while speaking, hold your MTH800 as you would a telephone. Speak into the bottom microphone. Listen via the earpiece.

Keep antenna at least 2.5 centimetres from your head and body.

Use in High Audio (Group and Private Calls)

Hold MTH800 in a vertical position with its top microphone 5.0 to 10 centimetres away from your mouth. Speak into the top microphone. Listen via the terminal's internal speaker.

Keep antenna at least 2.5 centimetres from your head and body.

Lapel/Shoulder Use

For Group and Private Calls turn your head towards your shoulder/lapel, and speak directly into the top microphone. Listen via the terminal's internal speaker.

Speakerphone Use

Place the MTH800 30 to 60 centimetres away from you. In a noisy environment, you may want to move the MTH800 closer to you for better transmission.

Looking after your MTH800

Never leave your MTH800 or battery in extreme temperatures (over 60 °C)—for example, behind windscreen in very hot, direct sunlight. Do not immerse your MTH800 in water.

To clean your MTH800, use a moistened or antistatic cloth. DO NOT use a dry or electrostatically charged cloth.

The Display

Home (Idle) Display



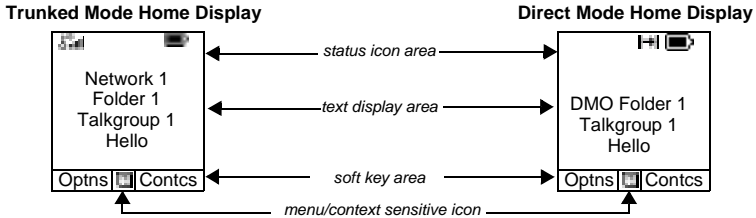







A powered-on, idle terminal shows the following typical Home display:



Status Icons

Status icons appear when your phone is engaged in certain activities or when you have activated certain features.

Status Icon	Description
Trunked Mode Operation	
	Signal Strength (TMO) Allows you to check signal strength. More bars indicate a stronger signal.
	No Service
	Scan Indicates scanning is activated in the MTH800.
	Data Connected Displayed when the MTH800 is successfully connected to an external device and ready for data transfer.
	Data Transmit/Receive Displayed when the MTH800 is transferring data to/receiving data from the external device (laptop or desktop PC).
Direct Mode Operation	
	Signal Strength (DMO) Indicates an incoming Direct Mode Group Call.

Status Icon	Description
	<p>Direct Mode Displayed when the MTH800 is in Direct Mode.</p>
	<p>DMO Gateway Indicates that gateway is selected. The icon has three states: Solid—while the MTH800 is synchronised with the gateway. Flashing—while the MTH800 is not synchronised or during attachment. No icon—during a radio to radio call, i.e. not using a gateway.</p>
General Icons	
	<p>All Tones Off Indicates that all alert tones are off in the MTH800.</p>
	<p>Vibrate On Indicates that the MTH800 will vibrate to alert you of an incoming call.</p>
	<p>Vibrate and Ring Indicates that the MTH800 will vibrate and ring to alert you of an incoming call.</p>
	<p>Speaker Off (Low Audio) Indicates that the audio will sound through the earpiece. (See detailed explanation of Speaker Control Key.)</p>
	<p>Battery Strength Shows the charge in your battery. Full icon is full charge.</p>
	<p>Emergency Appears while the MTH800 is in Emergency Operation.</p>
	<p>List Scrolling Displayed to indicate that the Rotary knob use is list scrolling, as long as this use is selected.</p>
	<p>New Message Has Arrived Indicates a new message just arrived.</p>
	<p>New Message(s) in Inbox Indicates that you have unread messages in your Inbox.</p>



The LED Status Indicator

The LED indicator shows the in-service states of your MTH800. Please refer to the table below.

Indicator	Status
Solid green	In use
Flashing green	In service
Solid red	Out of service
Flashing red	Connecting to a network/ Entering DMO
Solid orange	Transmit Inhibit (TXI) in service/ Channel busy in DMO
Flashing orange	Incoming call
No indication	Switched off

Key, Knob, and Button Overview

Soft Keys

Press  or  to select the option that appears in the screen directly above the left or right soft key. In this example, **Contcs** is displayed above the key. Pressing  enters the contact list. In the user guide, this action is described as “press **Contcs**”.

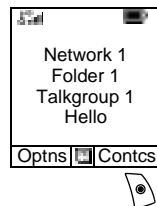

Menu Key

Press  to enter:

- **The menu (when there is no on-going activity).** The MTH800 menus allow you to control your MTH800 settings. Menus are organised in a hierarchy. See “List of Menu Items” on page 71. The menu options provide access to a further list of options called a sub-menu.

- The **context sensitive menu** (when  icon is on) to view a list of items for the current menu.

Examples of Menu and Sub-menus:

The example below shows how to setup the Vibrate function in the terminal.

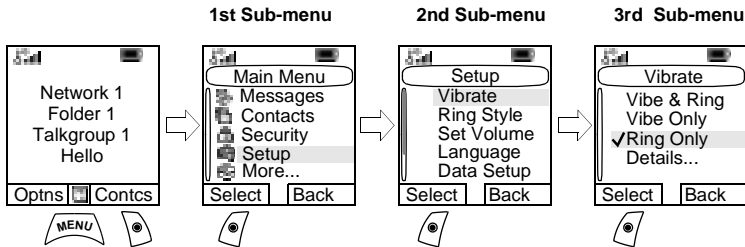

Example of Context Sensitive Menu

This example shows the screen when editing a name listed in the contact list. From the Home display, press **Contcs**. Scroll to the name you wish to edit. Press .

The context sensitive menu opens up, allowing you to choose among the entries.

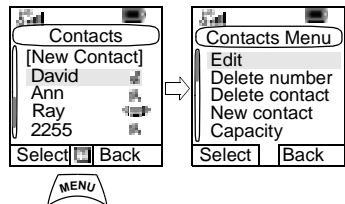

Rotary Knob

The Service Provider can program the Rotary knob to one of the following uses:

1. Dual Control - the knob is used as both a Volume control and to scroll through Lists. Press the knob to toggle between Volume and List (default programming).
2. List Control - the knob is used to scroll lists or menu items. In this case volume control is always via the Side keys.
3. Volume Control - the knob is used only as a volume control; turn clockwise to increase the audio volume level.

Press and hold the Rotary knob to lock it, press and hold it again to unlock. Powering Off also unlocks a locked Rotary knob.

Emergency Button

Press and hold this button to enter Emergency Operation.

When the MTH800 is powered down, press and hold this button to power **On** in Emergency Operation (if configured by your Service Provider).

See “Emergency Operation” on page 54.

Function Keys



For information on the function assigned to each Side or Numeric key, please refer to your Service Provider.



The required time you need to press the Side or Numeric keys to activate a one-touch function is set as default to 1 second. This time may be set, however, by your Service Provider.

Side Keys

The Rotary knob and Side key programming are paired:

Rotary Knob Programming	Side Key Programming
Dual Control	Programmed to a one-touch function
List Control	△: Volume Up ▽: Volume Down
Volume Control	Programmed to a one-touch function

When the Rotary knob is programmed to Volume Control or Dual Control, the Side keys support the one-touch feature that allows you to select or activate commonly used features by pressing and holding a single key. By default, the upper side key is set to “Backlight On/Off” and the lower side key is set to “Screen Saver On”. Please check with your Service Provider.

Programmable Numeric Keys

The MTH800 supports the one-touch feature that allows you to select/activate commonly used features by pressing and holding a numeric key. Your Service Provider should program the numeric keys with the relevant features.

The following table lists the programmable features and their availability in specific MTH800 states/modes. For detailed information on the features, see the relevant section in the user guide.

Feature	Description
Talkgroup Switch	Switch to a specific talkgroup
Talkgroup Scan	Toggles on/off the Talkgroup Scan function (TMO only)
Home Revert	Puts the MTH800 back Home display.
DMO/TMO	Toggles between DMO and TMO
Status Message	Sends a dedicated status message to a dedicated address (TMO only)
Text Message Template	Sends a predefined/user defined template to a dedicated address (TMO only)
Call Dial (Private, Phone, PABX)	Initiates a call to a predefined entry in the contact list (TMO only)
Vertical Flip Display	Toggles on/off vertical flip
Transmit Inhibit (TXI)	Toggles between activated and deactivated TXI Mode.
Screen Saver	Activates screen saver.
Backlight Adjustment	Toggles on/off backlight.



If dialing via one-touch numeric key is enabled, one-touch dial is disabled (see page 52).

To use the one-touch feature:

- Press and hold the required numeric key for a few seconds.
- Your MTH800 will display the number and act according to the programmed feature.

Speaker Control Key

Press  to activate the earpiece (low audio) or speaker (high audio), depending on the menu settings.

Type of Call	Menu Setting	Key Use
Half-duplex call (Group*/Private)	Menu > Setup > Group Audio > Spkr Cntrl	Speaker On/Off for Group and Private Calls
	Menu > Setup > Group Audio > Always Loud	Speaker On/Off for Private Call
Full-duplex call (Private/Phone/ PABX)	-----	Controls speaker/earpiece of the on-going call,

* In an Emergency Group Call, the voice sounds from the speaker regardless of the speaker setting.

Aliases (Names)

Aliases are optional names that you can assign to stored phone and private numbers (or IDs). To edit an alias, see page 76.

Aliases can be up to 12 characters in length and may consist of letters, numbers, and spaces.

Aliases are displayed during contact list scrolling or during an incoming call. Aliases are also used in alphanumeric search to retrieve numbers from your memory list.

The following screens show examples of how the caller's private number can be displayed.

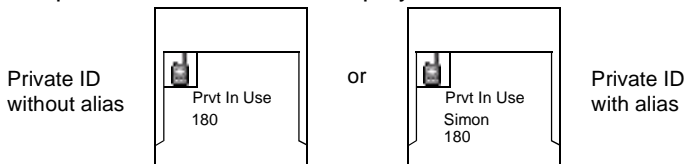

Screen Saver

If your Service Provider configured this feature, the screen saver will automatically cover the MTH800 display after the MTH800 stays idle for a pre-programmed period of time. If you press a key or a call arrives, the screen saver is deactivated and the MTH800 resumes standard operation.

You can also activate this feature manually, by pressing the relevant pre-programmed button (either a side button or numeric key). For example, if manually activated during a group call, the screen saver allows to hide the caller's identity for confidentiality. The screen saver consists of a logo and an alphanumeric text. Check in the menu options whether the Service Provider has given you the capability of entering your own screen saver text (see page 88).

Home Display Text Message

Your MTH800 is provided with a feature that allows your Service Provider to send special text messages to your MTH800 display.

The message is displayed when your MTH800 is idle.

The message will stay on your MTH800 display until a new message is received.

If configured by your Service Provider, your MTH800 will display an internal Home display until another message is received.

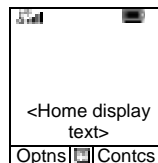

Terminal Disable/Enable

Your MTH800 is provided with a feature that allows your Service Provider to disable it temporarily in case it is stolen. When your MTH800 is disabled, no calls can be initiated or received.

While your MTH800 is disabled, it will look and act like it is turned **Off**.

If you try to turn your MTH800 **On**, when it is disabled, it will operate as described above.

If your MTH800 is found, your Service Provider can re-enable it. After your MTH800 is re-enabled, you may resume normal operation.

Selecting TMO or DMO Operation

General

In Trunked Mode Operation (TMO) the MTH800 is used with the infrastructure services within system coverage.

In Direct Mode Operation (DMO) the MTH800 is used without infrastructure services required.



While operating in DMO the propagation travels directly from the transmitting terminal antenna to the receiving terminal antenna, with no assistance from any base station or tower. Therefore, the range is critically dependent on the position of the user and the antenna. To achieve best results, hold the terminal in the hand as high as comfortably possible, and be sure not to obstruct the antenna in any way. Be sure that the antenna is clear from the body, cables, or other obstructions. As there is no tower-mounted base station to assist, and the two users are usually standing at ground level, the range is usually shorter than that can be achieved towards a tower or hilltop. Any obstructions (hills, buildings, etc.) between the users will further decrease the range. Conversely, raising the terminal higher or moving to a higher location may improve the range.



A MTH800 in DMO can communicate with the trunked system (and vice-versa) through a gateway device. To use that feature, please enable the gateway option in your MTH800 (see “Making a DMO Group Call via Gateway” on page 43).



In DMO it is only possible to place Group calls and Emergency Group Calls.

Entering TMO or DMO

Enter TMO or DMO in one of the following ways:

- From the Home display press **Optns** and select **Direct Mode** if the MTH800 is in TMO.
- From the Home display press **Optns** and select **Trunked Mode** if the MTH800 is in DMO.
- Press  and select **More...> Networks > Trunked Mode** if the MTH800 is in DMO.
- Press  and select **More...> Networks > Direct Mode** if the MTH800 is in TMO.
- Press the TMO/DMO one-touch button (if programmed by your Service Provider).



Your terminal can alert you of an incoming call. Select the alert settings in the Vibrate menu and Tones menu items.

TMO Calls

You can make and receive the following types of calls when the MTH800 operates in Trunked Mode:

- Group Calls
- Private Calls
- Phone Calls
- PABX Calls—local (office) extension calls
- Emergency Calls

DMO Calls

You can make and receive Group Calls when the MTH800 operates in Direct Mode (DMO). This includes Emergency Group Calls.

The MTH800 returns to the Home display when there is no activity for a few seconds.

Making Calls

See the relevant sections in the user guide.

Modifying the Type of Call

The infrastructure can modify the type of call you started.

For example, you might start a a half-duplex Private Call, and the infrastructure could modify the call to a Group Call.

The terminal will alert you of the modification and will display the following messages, depending on the type of call:

- **Call Modified** (to full-duplex)
- **Call Modified Use PTT** (modified to half-duplex)

Continue the modified call depending on the type of call.



- Half-duplex Private Call modified from direct setup to hook setup: a ringing tone will alert of the change.
- Half-duplex Private Call modified from hook setup to direct setup: there will be no indication of the change.

Receiving Calls

The MTH800 will automatically receive the incoming call. Additionally, if Inactivity Revert Mode is enabled, the MTH800 returns automatically to the Home display, after that call ends.



Inactivity Revert Mode will occur if configured by your Service Provider.

Your MTH800 will alert you of an incoming call depending on the setting you selected in the Vibrate menu option (see page 81) and the Tones menu option (see page 85).

During message editing, you will be alerted of an incoming Group/Emergency/Broadcast Group Call if configured by your Service Provider.

Preemptive Calling

Preemptive calling is particularly useful when you need to speak urgently with a user whose terminal is busy in a non-emergency voice call.

A preemptive priority call (PPC) is either an Emergency Group Call or a Private PPC (half-duplex or full-duplex call).

The feature allows to disconnect the on-going lower priority call and to connect to the incoming higher priority call.

To place a PPC, see the Emergency Operation and Private Call sections in the user guide.

The MTH800 will receive the call via speaker or earpiece, according to the setting used when the PPC is received.



For call alert, see settings in the Vibrate menu option (page 81) and the Tones menu option (page 85).

Receiving a PPC is explained in the following paragraphs.

In the screens, **<Any> in Use** refers to any of the non-emergency voice calls: Group, Private, Phone, or PABX.

Receiving an Emergency Group Call during a Call

The MTH800 receives the Emergency Group Call, drops the on-going non-emergency voice call, and connects to the Emergency Group Call.

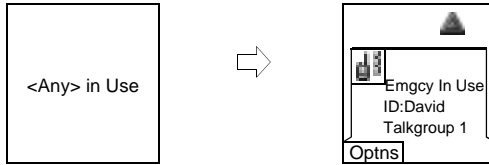

Receiving a Private PPC during a Call

If configured by your Service Provider, the MTH800 receives the PPC, drops the on-going, non-emergency, lower priority voice call, and connects to the higher priority Private Call.

A PPC with lower or equal priority, will be dropped without any indication to the called user and will enter the missed call list.

A PPC Call with Emergency Call priority will be displayed on the screen as "Emergency" (instead of "Priority").

Half-duplex Private PPC Received

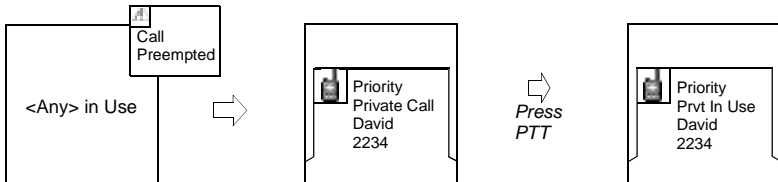

Full-duplex Private PPC Received

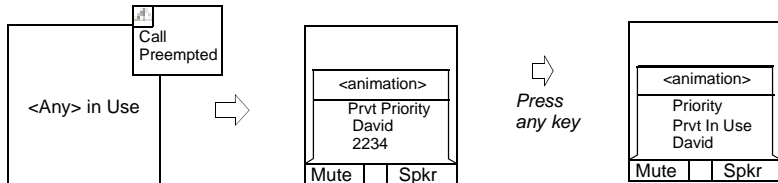

Broadcast Call

The Broadcast Group Call (also called Site Wide Call) is a high-priority group call from the console operator (or dispatcher) to all users located at one or more sites. The terminals are configured to monitor a Broadcast Call, but the users cannot talk back.

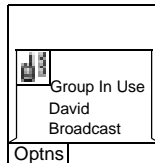

The call can be received as normal Broadcast Call or Emergency Broadcast Call.

The Broadcast Call preempts an on-going Group Call that has the same (or lower) call priority.

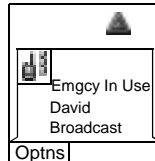

For selecting a talkgroup during a broadcast call, see “Selecting a Group” on page 33. For changing folder during a broadcast call, see “Selecting a Folder” on page 35.

Ambience Listening (AL)

This feature, if enabled by your Service Provider, allows a console operator (or dispatcher) to establish a special call with a specific terminal to monitor voice activity in the local vicinity. The call is setup without any indication to the affected terminal, and any lower priority ongoing voice call or packet data transfer may be pre-empted.

After accepting the call, the terminal transmits in a half-duplex Private Call without any action from or indication to the user. The Ambience Listening call shall automatically end when the user initiates any voice call and uses the terminal normally.

Cancelling a Call

Choose one of the following, as relevant:

- Press . If you wish to make a new call, start it at once.
- Wait to answer the call. After a time-out set by your Service Provider, the call number will be forwarded to the missed call list.
- Press **Reject** soft key (displayed in an incoming full-duplex call). The call number will be forwarded to the missed call list.

Using In-call Features

Handsfree Speakerphone

The speakerphone feature allows you to hold impromptu meetings in Phone, PABX, and full-duplex Private Calls.

During speakerphone operation, you may either speak or listen, but you cannot do both at the same time.



1. To activate speakerphone, press **Spkr**. The display shows **Speaker ON**.
2. Place the MTH800 30 to 60 cm away from you. In a noisy environment, you may want to move the MTH800 closer to you for better transmission.
3. To de-activate speakerphone, press **Erpce**. The display shows **Speaker OFF**.

To burst into conversation while the other party is talking, press and hold **PTT**. You will hear a tone. Start talking, and release **PTT** to listen again to the other party.

Muting/Unmuting the Bottom Microphone

During a Phone, PABX, or full-duplex Private Call, use the mute feature to:

- hold conversation without being heard by the caller
 - silence possible background noise in your area.
1. Press **Mute**. The display shows **Mute is ON**. The microphone is muted. You can hear the incoming audio, but the caller cannot hear any speech coming from your MTH800.
 2. To speak, press **Unmut**. The display shows **Mute is OFF**. The microphone is on.

Local Area Service

This mode, also called Fallback Mode, allows more than one terminal from the same site to communicate when the link between the site and network central controller fails. Entering and exiting Local Area Service (that is, returning to System Wide Services) is done automatically.

Entering Local Area Service

When the MTH800 receives a Local Area Service indication from the system, the following occurs:

- The MTH800 sounds a tone.
- The display shows the “Local Area Service” message.
- Display icons and soft keys turn brown.
- Any call in progress is dropped upon entering Local Area Service mode.

If configured by your Service Provider, this message/alert is periodically repeated to remind you that the MTH800 is still operating in Local Area Service mode.

The following features are available while the MTH800 is in Local Area Service:

- Registration
- Attachment
- Group Call
- Emergency Call
- Emergency Alarm

Exiting Local Area Service

When the link with the central network controller is re-established, the MTH800 exits Local Area Service and the following occurs:

- the MTH800 sounds a tone
- any call in progress during Local Area Service is dropped.

TMO Group Call

General

A Group Call is an instant communication between you and others in a talkgroup that you select. Participants may join (late entry) and leave an on-going Group Call. A talkgroup is a pre-defined set of subscribers enabled to participate in and/or invoke a Group Call, that is set up by your Service Provider.

Talkgroups appear on your display as names or numbers (for example: Sales, Service, Electricians, Talkgrp10).

Talkgroups are divided into **folders**. Each folder may contain several talkgroups.

For ease of use, your MTH800 also provides the ability to:

- Perform an alphabetical search of the talkgroup aliases. Scroll through the entire talkgroup list.
- Organise your favourite groups into one folder called My Groups (set up by your Service Provider).

Your talkgroups may be organized into **scan lists** (set up by your Service Provider, or by yourself through the Menu).

When you activate one of these scan lists, your MTH800 will continuously monitor the activities of the selected talkgroups.

By assigning priorities to the talkgroups defined in the **scan list**, you will be capable of accepting calls that have higher priority than the on-going call.

You can start talkgroup, folder, or scanning selection when the terminal is idle or receiving a call.

When receiving a call, choose one of the following:

- Exit selection screen to join the call.
- Join the call from the selection screen by pressing **PTT**.
- Continue selection.

Each talkgroup may have one associated **Announcement Talkgroup** (ATG) that it monitors (if set up by your Service Provider).

An ATG is a special group which is linked to a number of talkgroups and has the highest priority level, thus enabling broadcast of the call to all these talkgroups.

When an ATG is selected, the scanning icon is not displayed. The MTH800 monitors the ATG scan list instead of the selected scan list. The ATG scan list contains all the talkgroups associated with a selected ATG. Your Service Provider should advise what talkgroups are associated with which Announcement Talkgroup.

Your MTH800 will always monitor the Group Calls in the ATG scan list. To place an Announcement Call, you must first select the specified Announcement Talkgroup as advised by your Service Provider, otherwise you will only be able to participate when an Announcement Talkgroup is received.

Activation and deactivation of talkgroup scanning has no effect on the ATG scan list.

Dual Microphone Feature

See “How to Hold Your MTH800” on page 13.

Selecting a Group

You can select a talkgroup in one of the following ways, by using the:

- Rotary knob
- navigation key
- alphabetical search feature
- folder search

For group scrolling configuration, see page 35.



When you navigate in the “My Groups” folder and select a DMO group, your terminal will switch between TMO and DMO (and vice-versa).

Using the Rotary Knob

(If configured by your Service Provider)

From the Home display, press shortly on the Rotary knob and rotate until the requested group appears.

Group selection occurs:

- After a time-out,
- Or, by pressing **Select** (if configured by your Service Provider).

Using the Navigation Key

From the Home display, scroll left or right until the requested group appears. Then press **Select** to confirm selection.

Pressing the **PTT** will also choose the group automatically and start transmission.

Using Alphabetic Search

From the Home display, press **Optns**. Select a group by alphabetic search (“**TG by abc**”). Enter the first character of the group’s name. Select the group.

Using Folder Search

From the Home display, press **Optns**. Select a group by folder search (“**TG by Folder**”). Select the folder and select the group.

Selecting a Folder

You can select a folder by using one of the following:

- the Rotary knob (if configured by your Service Provider)
- the navigation key

Using the Navigation Key

When using the navigation key to select a folder, press **Select** to confirm the selection.

To Select a Folder

From the Home display, press **Optns**. Select **Folder**, and select the desired folder. The display shows the last selected group in that folder.

“My Groups” Folder

You can organise your favourite groups into one folder called “My Groups”.

Selecting My Groups

From the Home display, press  to quickly access the folder.

Adding/Deleting Groups from My Groups

For more information, see “My Groups (TMO/DMO)” on page 95.

Group Scrolling Configuration

Your Service Provider can configure scrolling via rotary knob or navigation key as follows:

- Scroll to next folder—when the folder end is reached during group scrolling, further scrolling switches to the group list in the next folder.

For example: Folder 1 has Group11 and Group12. Folder 2 has Group21 and Group22. Group11, Group12, Group21, Group22 will appear during scrolling.

OR

- Stay in folder—when the folder end is reached during group scrolling, further scrolling restarts the folder group list. To move to the next Folder, you should select it.
For example: Folder 1 has Group11 and Group12. Folder 2 has Group21 and Group22. Select Folder 1: Group11, Group12, Group11, Group12 will appear during scrolling. Change to Folder 2: Group 21, Group 22, Group 21, and Group 22 will appear during scrolling.

In addition, your Service Provider might configure the rotary knob as follows:

- End-Stop Rotary Knob Scrolling—the rotary knob will stop when it reaches the last group in the folder, and a tone will alert you that you have reached the last group in the folder. Use the navigation key to continue scrolling through the list.

Activating/deactivating Scanning

See “Setting Group Scanning” on page 91.

Making a Group Call

1. From the Home display and if this is the required group, press and hold the **PTT**.
2. Wait for the talk permit tone (if configured) and then speak into the microphone. Release the **PTT** button to listen.

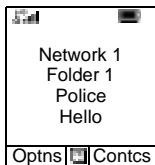

When you start a call, all members of the selected group who have their units turned on, will receive the Group Call.

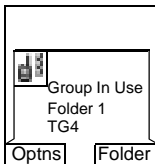

If you are in an on-going Group Call and wish to make a new call, press  to ignore the current call. Start the new call.



The “No Group” message is displayed when you are out of the normal coverage area of your selected group. You must then select a new group that is valid for your working location.

Receiving a Group Call

General

Unless it is engaged in a call, your MTH800 will receive the Group Call. To answer the call, press and hold **PTT**.

Your MTH800 shows the Group name and the caller’s private number or name if previously stored in your contact list.

The following screens show examples of how the caller’s private number (ID 124) is displayed.

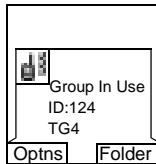

Private ID
without alias

OR

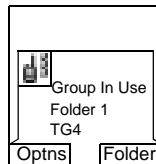

Private ID
with alias



For incoming call alert, see settings in the Vibrate menu option (page 81) and the Tones menu option (page 85).



Any incoming Group call is ALWAYS received through the main speaker. If configured by your Service Provider, the Group Audio menu item allows to set up the audio of the incoming Group Call.

If the setup is Speaker Control, you can direct the audio of an active group to the earpiece (low audio) or the main speaker (high audio). In low audio speak into the bottom microphone and listen via the earpiece. In high audio speak into the top microphone and listen via the speaker.

At the end of a call which has been directed to the earpiece, an audio hang timer is activated, if it is enabled by your Service Provider. Within the preprogrammed hang time, any incoming call is still received through the earpiece. When the timer expires, a low pitch tone is emitted alerting you that the next incoming Group call will be received through the speaker. Upon hearing this alert, you are advised to hold the terminal at a comfortable distance away from the speaker.



When receiving a Group call, you will hear a “New Group Call” tone (if configured by your Service Provider).

Receiving a Group Call in Idle Screen with Scan Off

You can receive a group call from the selected talkgroup or from the associated ATG only.

Your MTH800 will receive the Group Call.

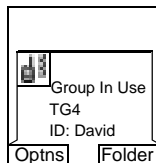

Receiving a Group Call in Idle Screen with Scan On

With Scan On, you can receive a group call from the scan list you set up, in addition to receiving a group call from the selected talkgroup or from the associated ATG.

Receiving the scan call functions as receiving an associated ATG or selected call in scan off (see previous page), except for the following:

- The display is different when receiving the call in idle screen, as shown here.
- The terminal sounds a tone as explained in the note below.

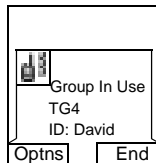

- When receiving a High Priority Group Call, you will hear a “High Priority Group Call” tone (if configured by your Service Provider).
- When receiving a Group Call from your scan list, which is not from a high priority group, you will hear a “New Group Call” tone (if configured by your Service Provider).
- To block reception of a Group Call, select **Optns** then **Block**. Powering off/on the terminal unblocks the reception of this Group Call.

Receiving a Group Call during an On-going Group Call

Depending on how the Service Provider has configured incoming calls, the incoming call will either be:

- Forced upon you and will interrupt the on-going call (if the incoming call has higher priority than the on-going call).
or
- Presented to you (if it has higher priority than the on-going call).
To accept the call, press **Join**.
To cancel the call, press **End**.

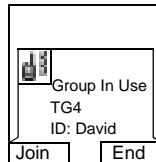

Receiving an Emergency Group Call

For detailed information, see page 27.

Receiving a Broadcast Call

For detailed information, see page 28.

Transmit Inhibit

You can activate the Transmit Inhibit (TXI) Mode before entering RF sensitive areas, e.g. in hospitals or in potentially explosive areas, where safety can be jeopardized due to MTH800 transmission radiation.



Radiation of the MTH800 is only suppressed if the TXI Mode is activated or the MTH800 is separated from power supply.

In TXI Mode the MTH800 will not transmit under any circumstances, except for the Emergency Call, which can be initiated even if the MTH800 is in TXI Mode.

All MTH800 functions and keys which cause transmission, e.g. registration to the network, change of talkgroup or folder, sending messages, pressing **PTT**, etc. are disabled. In this case the display shows “Not Allowed In TXI Mode” and the MTH800 sounds the “Transmit Inhibit” tone.

When no danger to safety exists anymore (for instance if you leave the RF sensitive area), the TXI Mode can be deactivated and the MTH800 returns to standard operation.

Setting the TXI Mode is described in “Setting Transmit Inhibit (TXI) Mode” on page 102.

Activated Transmit Inhibit is indicated by the solid orange LED and flashing between the two displays:

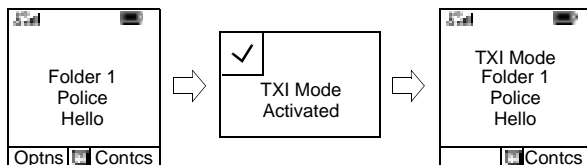

Dynamic Group Number Assignment (DGNA)

DGNA provides the ability for a network operator or authorised user to dynamically allocate new, or update existing talkgroups to selected terminals over the air interface. Using supplementary services messages (SS-DGNA), the network operator can command your terminal to add talkgroups or to update the existing talkgroups, or to delete talkgroups from the list. This operation is performed by transmitting the data into your MTH800.





Your Service Provider can gather some Talkgroups under one Super-group and transmit it to your MTH800 as a DGNA. In such a case, you will be able to participate in calls to/from all the groups in the Super-group.

DGNA Reception with Notification Message

When a DGNA message is received and DGNA notification was configured by your Service Provider, you will get a tone indication and notification message (“**Talkgroup list updating**”), and then a display of the new assignments.



You can use the **View, Attach, Back** soft keys, , Rotary knob, , and Emergency button.

Pressing one of them exits the DGNA display.

1. To view the added/deleted talkgroups details press **View**. You may scroll through the list.
2. To return to the previous display press **Back**.
3. To select the DGNA group, press **Attach**. Or scroll to another group and press **Attach**.

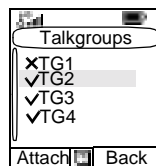
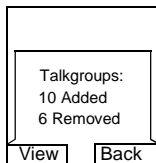

- Group attachment is not allowed in TXI Mode.
- Once you exit the DGNA notification screen, select one of the newly added groups as explained on see page 33.

If the DGNA message is received to delete all Talkgroups, your MTH800 will display the following:

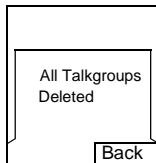

DGNA Reception without Notification Message

If DGNA notification was not configured by your Service Provider, you will get a tone indication and notification message only and only if a selected group was changed by the DGNA.

DMO Group Call

General

In DMO, the MTH800 can be used without your Service Provider's infrastructure.

Direct Mode allows communication with other terminals also operating in Direct Mode, which are on the same frequency and talkgroup as your MTH800.



In DMO it is only possible to place Group Calls and Emergency Group Calls.

You can receive a call:

- From the selected talkgroup
- From other users within talkback range (if configured by your Service Provider). This is called an InterMNI (Mobile Network identity) call.
- From an open group. (An open group is a super-group to which all DMO groups belong.)

When you start a call, the members of the selected talkgroup who have their units turned on, and are within the group subscriber identity (as configured by the Service Provider), will receive the transmission.

In DMO the MTH800 can communicate with the trunking system (and vice-versa) if the Gateway option is enabled in the MTH800.

Dual Microphone Feature

See "How to Hold Your MTH800" on page 13.

"My Groups" Folder

You can organise your favourite groups into one folder called "My Groups".

Selecting the My Groups Folder

From the Home display, press  to quickly access the folder.

Adding/Deleting Groups from the My Groups Folder

For more information, see “My Groups (TMO/DMO)” on page 95.

Selecting a Group

See the Group Call section, page 32.

Selecting a Folder

See the Group Call section, page 32.

Making a DMO Group Call without Gateway

1. Enter **Direct Mode** by pressing **Optns** and selecting **Direct Mode**.
2. Make sure that you have selected the required group. Press and hold the **PTT** button.
3. Wait for the talk permit tone and then speak into the microphone. Release the **PTT** button to listen.

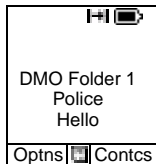

Making a DMO Group Call via Gateway

While in DMO, proceed as follows to choose a gateway to set up a call for the selected talkgroup:

1. Press **Optns** and select **Gateway**.
2. The display shows the last gateway type selection. Scroll to your selection and press **Select**:

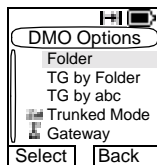

- None: the MTH800 will not use a gateway for that talkgroup.
- Automatic: the MTH800 will use the first available gateway for that talkgroup. The Gateway icon will flash until the terminal finds an available gateway.
- Specific: the MTH800 will use a specific gateway for that talkgroup.

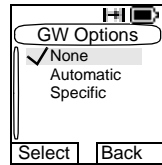

Upon selecting “Specific”, you will see one of the following displays:

- The selected gateway address (e.g.: 1022), pre-programmed by your Service Provider or previously entered by yourself via the keypad. Press **Ok** to use the current address, or enter a new address via the keypad, and press **Ok**. The Gateway icon will flash until the terminal finds an available gateway.
- “None”, indicating that no specific gateway was selected for that talkgroup. Enter an address via the keypad, and press **Ok**. The Gateway icon will flash until the terminal finds an available gateway.

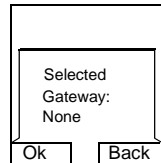
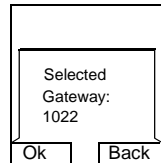

Pressing **Back** causes the following message to be displayed for a few seconds: “No Specific Gateway Was Selected”. The MTH800 exits the Gateway menu option and the previous gateway type will be selected.

When the MTH800 is synchronised with the gateway, the Gateway icon will be solid.

3. To place the call, proceed as explained on page 43.

If you press **PTT** while the gateway is not available, you will start a DMO call without gateway. The Gateway icon will disappear.

If you press **PTT** while the selected gateway is available, but the call is rejected by the gateway, your MTH800 will sound a tone and display the



following screen, informing you that the call will be setup without gateway. The Gateway icon will disappear.

If you press **PTT** while the gateway is available, you will start a DMO call with gateway. The Gateway icon will be solid.

Receiving a DMO Group Call

You can receive a DMO Group Call only when your MTH800 is in DMO.

Your MTH800 will display the caller's private number or alias, and the talkgroup name.

The following screens show examples of how the caller's identity can be displayed.



For call alert, see settings in the Vibrate menu option (page 81) and the Tones menu option (page 85).

Receiving a DMO Group Call (not via Gateway)

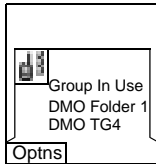

Without alias and Private ID

OR

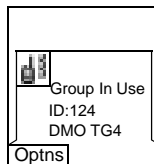

Private ID without alias

OR

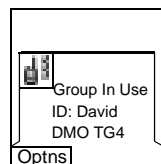

Private ID with alias

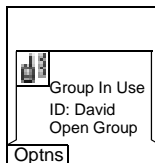

Open Group Call

OR

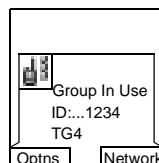

InterMNI Call

When an InterMNI call is received, you can press Network to see the Network alias and/or number.

Receiving a Group Call (via Gateway)

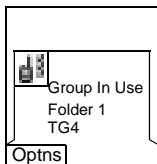

Without alias and
Private ID

OR

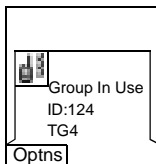

Private ID
without alias

OR

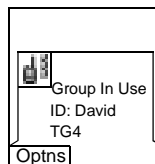

Private ID
with alias

The display shows the ID of the TMO caller.

Press **Optns** to select a new gateway type (see page 44).

Receiving an Emergency Group Call

For detailed information, see page 27.

Transmit Inhibit

For detailed information, see page 39.

Exiting DMO

To exit DMO, press **Optns** and select **Trunked Mode**. For other ways, see “Selecting TMO or DMO Operation” on page 23.

Private Call

General

A Private Call, also called Point-to-Point or individual call, is a call between two individuals. No other terminal can hear the conversation. This call can be a full-duplex call (if the system allows) instead of the standard half-duplex call. In a full-duplex call, both participants can speak at the same time, while in a half-duplex call, only one person can speak at a time.

For operating the MTH800 in RF sensitive areas, see “Transmit Inhibit” on page 39.



While Transmit Inhibit is activated, an incoming Private Call is indicated, but it is not possible to answer the call.

Dual Microphone Feature

See “How to Hold Your MTH800” on page 13.

Making a Private Call





If you are in an on-going Group Call and wish to make a new call, press  to ignore the current call. Dial the number.

1. From the Home display dial a number.
2. If Private is not the first type of call presented, press CType to select the Private Call type.
3. For a *half-duplex* call, press and release the **PTT** button. You will hear a ringing tone. Wait for the called person to answer your call. (This is also called a hook setup.) *OR*,

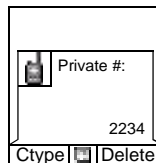
Press and hold **PTT**. Wait for the talk permit tone (if configured) before talking, and release the **PTT** when listening. (This is also called a direct setup.)



For a *full-duplex* call, press and release . You will hear a ringing tone. Wait for the called person to answer your call.

4. To end the call, press .



If the called person or the infrastructure end the call, the **Call Ended** message is displayed.



While Transmit Inhibit is activated, an incoming Private Call is indicated, but you cannot answer the call.



Other Ways of Dialing

Dialing via Contact List

You can also use the contact list to select a number you previously stored. Press **Contcs** and search the stored number by scrolling ( or ) or by entering the first character of the contact name.





If no name is stored under a letter, the MTH800 automatically searches forward, alphabetically, until the next name is found. If more than one name in the list begins with the same letter, scroll to view other names.

If the contact has more than one number stored, pickers surround the contact icon. Use  /  to select the number.

Short Number Dial

If set up by your Service Provider, Short Dial allows you to dial part of the full number of the person you wish to call. Your MTH800 will automatically complete the number and send it over the air based on your own MTH800's identity. For example:

1. Dial 456 (instead of 4282456, the full number).
2. To place the call, press the **PTT** or .
3. To hang up, press or .

Recent Calls List

Select the number from the recent call list. See "Recent Calls" on page 96.



One-touch Dial

See “Programmable Numeric Keys” on page 20.

Calling a Number in a Message

See “Calling a Number in a Message” on page 109.

Receiving a Private Call

1. The MTH800 switches to the incoming Private Call. The display shows the caller's identity.
2. To answer an incoming *half-duplex* call, press **PTT**. To answer an incoming *full-duplex* call (indicated by **Spkr/Earpc** keys), press .
3. To end the call, press .



Your terminal can alert you of an incoming call. Select the alert settings in the Vibrate menu and Tones menu items

Making a Private PPC (Preemptive Priority Call)



This feature is only available if set up by your Service Provider.

1. Enter the private number and press PTT or .
2. If the display shows the called user is busy, press **Yes** to interrupt the on-going call.
3. You will hear a ringing tone. Wait for the called person to answer your call.
4. Continue the call as in a regular half-duplex or full-duplex Private Call.

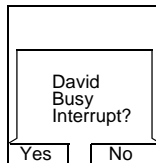

Call Queuing

When there are no available infrastructure resources for a call while in a setup phase, or while in an active call during cell re-selection, the call will be queued. The MTH800 will remain in queue for a pre-programmed period of time. If the resources become available, the call will proceed. If there are no resources after a certain period of time, the MTH800 will end the call.

Phone and PABX Calls

General

The **Phone Call** allows you to call a landline telephone number or a cellular mobile phone number. The **Private Automatic Branch Exchange (PABX) Call** allows you to call local (office) extension numbers. This type of call needs to be activated by your Service Provider.

In this publication we use “phone number” when referring to these numbers.

Both calls have the same dialing features.

For operating the MTH800 in RF sensitive areas, see “Transmit Inhibit” on page 39.



While Transmit Inhibit is activated, an incoming Phone or PABX Call is indicated, but it is not possible to answer the call.



Dual Microphone Feature

See “How to Hold Your MTH800” on page 13.

Making a Phone or PABX Call





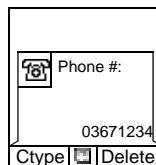

If you are in an on-going Group Call wish to make a new call, press  to ignore the current call. Dial the number.

1. From the Home display dial a number.
2. If Phone or PABX are not the first type of call presented, press **CType** repeatedly to select the Phone or PABX Call type.
3. Press and release . You will hear a ringing tone. Wait for the called person to answer your call.
4. To end the call, press .





Other Ways of Dialing

Dialing via the Contact List

You can also use the contact list to select a number you previously stored. Press **Contcs** and search the stored number by scrolling ( or ) or by entering the first character of the contact name. If the contact has more than one number, use  /  to select the number.





If no name is stored under a letter, the MTH800 searches forward, alphabetically, until the next name is found. If more than one name in the list begins with the same letter, scroll to view other names.

If the contact has more than one number stored, pickers surround the contact icon. Use  /  to select the number.

Speed Dial

Speed dial allows you to dial a shortened number of up to three digits instead of the full number. The speed dial number is the location of an entry in the contact list.

1. Enter the pre-programmed speed dial number (for example: 5) and press .
2. To place the call, press .
3. To hang up, press .

One-touch Dial

One-touch dialing allows you to place a call by pressing and holding one of the numeric keys (0-9) or side keys. The number is the location of an entry (0-9) in the contact list.

1. Press and hold the required numeric key for a few seconds. Your MTH800 will display the number and dial it.
2. To hang up, press .



If dialing via one-touch numeric key is enabled, one-touch dial is disabled (see page 20).

DTMF Overdial

If set up by your Service Provider, DTMF allows you to communicate with an automated answering device (for example, the voice mail or answering machine) during an on-going call.

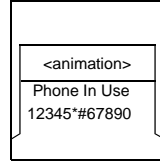

While in an on-going call, press the DTMF keys (0-9, *, #). When pressed, the DTMF key will sound a tone and the entered digit will be displayed on the screen.



Recent Calls List

Select the number from the recent call list. See “Recent Calls” on page 96.

Calling a Number in a Message

See “Calling a Number in a Message” on page 109.

Answering a Phone or PABX Call

1. The MTH800 switches to the incoming Phone/PABX Call.
2. To answer the incoming call, press  or any other key if programmed (except Home/End/On-Off key).
3. To end the call, press .

If the called person or the infrastructure end the call, the **Call Ended** message is displayed.



For call alert, see settings in the Vibrate menu option (page 81) and the Tones menu option (page 85).

Emergency Operation

General

Emergency Operation is available in TMO and in DMO, if the MTH800 is in service.

Dual Microphone Feature

See “How to Hold Your MTH800” on page 13.

Entering TMO or DMO

See “Selecting TMO or DMO Operation” on page 23.

Important Information



- The required time you need to press the Emergency button is set by default to 0.5 seconds. The time can be configured by your Service Provider.
- Pressing the Emergency button even if Transmit Inhibit is activated causes immediately the MTH800 to transmit. When entering Emergency Operation the MTH800 should not be within the RF sensitive area any longer!
- The MTH800 interrupts the AL call when you press the Emergency button.
- For call alerts, see settings in the Vibrate menu option (page 81) and the Tones menu option (page 85).

Emergency in TMO

Overview

Please check with your Service Provider for the configuration of your terminal.

Your terminal may be configured with one of the following:

- **Emergency Group Call**

The terminal will enter **Emergency Mode** when you press and hold the Emergency button.

The Emergency Mode allows you to use the **PTT** to transmit with Emergency priority (by either initiating an Emergency Group Call or requesting emergency transmit priority).

After entering Emergency Mode, you may send an Emergency Alarm (if configured) and then start the Emergency Group Call and activate Hot Microphone (if configured).

The **Emergency Alarm** is a special Status message sent to the infrastructure before the Emergency Group Call starts. The terminal may wait for infrastructure acknowledge for this Alarm and attempt retries. Each time you press the Emergency button, the terminal will send an Emergency Alarm.

Hot Mic (Hot Microphone) allows you to talk without pressing the **PTT**. Pressing **PTT** during Hot Mic ends Hot Mic transmission. Pressing the **End** soft key ends Hot Mic activity. If Hot Mic is disabled, then use **PTT** to talk.

- **Emergency Private Call (half-duplex or full-duplex)**

The terminal will start an **Emergency Private Call** to a pre-defined ID when you press and hold the Emergency button.

If an Emergency Private Call gets modified to an Emergency Group Call, the terminal will enter Emergency Mode and will leave the Emergency Mode when the call ends.

Changing Folder or Group

See Group Call section on page 32.

Entering or Exiting Emergency Mode

Upon entry into Emergency Mode any existing call or service other than packet data service will be aborted or cleared down.

In Emergency Mode, the terminal will automatically reject Phone, PABX and Private Calls, and will not monitor the groups in the user selected scan list. If an ATG is the selected group, however, the terminal will monitor the sub-

groups associated with the ATG. The terminal will remain in Emergency Mode until you exist it.

Press and hold the Emergency button to enter Emergency Mode.

When the MTH800 is **Off**, press this button to power the MTH800 **On** in Emergency Mode (if configured).

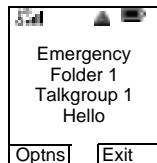

The terminal exits Emergency Mode and switches to the Home display:

- If you press and hold the **Exit** soft key during an Emergency Group Call.
- If the infrastructure ends the Emergency Group Call.

Sending an Emergency Alarm

Your MTH800 will send an Emergency Alarm to the dispatcher (if configured by your Service Provider):

- Automatically, upon entering Emergency Mode.
- If you press the Emergency button while the MTH800 is in Emergency Mode.
- If you change group while in Emergency Mode.

The screen will show one of the following delivery reports:

- **Alarm Sent**
- **Alarm Failed**

In both cases, the screen returns within a few seconds to the main screen of the Emergency Mode.



Some systems do not support the Emergency Alarm feature when the user is in a "Local Area Service" area (see page 30).

Making an Emergency Group Call



While in an Emergency Group Call, you can still perform group operations (such as changing group/folder, searching for a group, or entering the My Groups folder).

To initiate or answer a call while in Emergency Mode:

- Press and hold **PTT**.
- Wait for the talk permit tone (if configured) and talk.
- Release **PTT** to listen.

For the delivery reports, see “Sending an Emergency Alarm” above.

You can also participate in an Emergency Group Call (initiated by others) in Emergency Mode or in a standard Group Call.

Hot Microphone Feature

If the Hot Microphone feature was programmed into your MTH800 by your Service Provider, you can make an Emergency Group Call without the need to press and hold the **PTT**.

The following will happen upon entering Emergency Mode:

1. The MTH800 will automatically send an Emergency Alarm to the dispatcher (if configured by your Service Provider).
2. A Talk permit tone will be heard.
3. The following typical display will appear:
The microphone will stay open for a time period determined and programmed by your Service Provider.

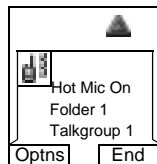

After the Hot Microphone time period expires, or if you press **PTT** during the Hot Microphone period, or if you press **End** soft key: the **Hot Mic Ended** message will be displayed. The talk session ends. To resume, press the Emergency button again.

If talk permit is granted to another member of the group, an “Emergency call received” tone will be heard. If configured by your Service Provider, your MTH800 will automatically attempt to get talk permit again and the **Wait For Mic** message will be displayed.

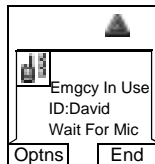

During this pending time the MTH800 microphone is not active until the Emgcy Mic On message is displayed again.

Receiving an Emergency Group Call

A terminal in TMO receives an Emergency Group Call to the selected group, associated ATG (Announcement Talkgroup), or scanned group. If the ATG is the currently selected group, the terminal will receive the Emergency Group Call to the group associated with this ATG. (For information on the ATG, see page 32.)

When the MTH800 receives the call, the display will show **Emgcy In Use** and the caller's identity.

If upon entering Emergency Mode, your MTH800 receives an Emergency call, and Hot Microphone was enabled by your Service Provider, the Wait For Mic message will be displayed. Your MTH800 will attempt to get a talk permit.

The caller's voice will always sound via the speaker (unless an external earpiece is connected to the terminal).

If configured by your Service Provider, the screen background will be red.

Making an Emergency Private Call

- Press and hold the Emergency button.
- The terminal will start the call as a half-duplex or full-duplex call (as programmed). The Emergency ID is pre-defined and is not displayed.
- Continue the call as you would do in a half-duplex or full-duplex call.

Receiving an Emergency Private Call

- The talker's identity is displayed when the terminal receives the half-duplex call.
- When the terminal receives the call, the display will show **Emergency Prvt In Use** and the caller's identity.
- If configured by your Service Provider, the screen background will be red.
- Continue the call as you would do in a half-duplex or full-duplex call.

Modifying the Type of Call

The infrastructure can modify on-going calls as follows:

- Emergency Group Call to Emergency Private Call, and vice versa.
- Anyone of the above to a Phone Call.

If Hot Mic is interrupted when the modification occurs, the display will show the **Hot Mic Ended** message.

Continue the modified call depending on the type of call.

Emergency in DMO

General

You can initiate an Emergency Group Call to a group.

You can receive an Emergency Group Call:

- From the selected talkgroup
- From other users within talkback range (if configured by your Service Provider). This is called an InterMNI call.
- From an open group. (An open group is a super-group to which all DMO groups belong.)

Emergency calls can be placed via gateway. For gateway settings, see the DMO section, page 43.

Changing Folder or Group

Proceed as explained in the Group Call section, page 32.

Making an Emergency Group Call

To initiate or answer a call:

- Enter Emergency Mode by pressing the Emergency button.
- Press and hold **PTT**.
- Wait for the talk permit tone (if configured) and talk.
- Release **PTT** to listen.

Receiving an Emergency Group Call

- The display shows “**Emrgncy-In Use**” and the caller’s identity as a private number or an alias.
- The caller’s voice will always sound via the speaker (unless an external earpiece is connected to the terminal).
- If configured by your Service Provider, the screen background will be red.
- If the incoming call is an InterMNI call in Emergency Mode, you can view network information by pressing **Optns** and selecting **Network**.
- If the incoming call is an InterMNI call *not* in Emergency Mode, you can view network information by pressing **Network**.

GPS Location Services

Your terminal's GPS Location feature uses information from Global Positioning System (GPS) satellites orbiting the Earth to determine the approximate geographical location of your terminal. The availability and accuracy of this location information (and the amount of time that it takes to calculate it) will vary depending on the environment in which you are using the terminal.

For example, GPS location fixes are often difficult to obtain indoors, in covered locations, between high buildings, or in other situations where you have not established a clear broad view of the sky.

SEE: IMPORTANT: Things to Keep in Mind.

The GPS location Service can assist your Dispatcher or Colleagues in many ways such as more efficient deployment of resources or locating your terminal if you trigger your emergency service.

The terminal can be configured to display location information on the terminal's display or to send it over the air to your dispatcher where it can be displayed in control center (Please check with your Service Provider on the configuration of your terminal).

IMPORTANT: Things to Keep in Mind

Where adequate signals from multiple satellites are not available (usually because your terminal cannot establish a view of a wide area of open sky), the GPS feature of your terminal **WILL NOT WORK**. Such situations include but are not limited to:

- In underground locations
- Inside of buildings, trains, or other covered vehicles
- Under any other metal or concrete roof or structure
- Near a powerful radio or television tower

- When your GPS antenna is covered (for example, by your hand or other object) or facing the ground
- In temperature extremes outside the operating limits of your terminal

Even where location information can be calculated in such situations, it may take longer to do so. Therefore, in any emergency situation, always report your location to your dispatcher.

Furthermore, please note that even where adequate signals from multiple satellites are available, your GPS feature will only provide an approximate location, often within 20 - 100 meters from your actual location.

Enhancing GPS Performance

Sometimes the GPS feature of your terminal may be unable to complete a location calculation successfully. You will then see a message indicating that your terminal cannot see enough visible satellites.

To maximize the ability of your terminal to determine a location fix please note the following guidelines:

- Stay in the open. The GPS feature works best where there is nothing between your terminal and a large amount of open sky. If possible, go outside, away from tall buildings and foliage. While performance in a building is improved by moving closer to windows, glass with certain sun shielding films may block satellite signals.
- Position your terminal to enhance reception. Signals from GPS satellites are transmitted to your GPS antenna, which is in your terminal antenna. Hold your terminal away from your body, giving the antenna clear access to satellite signals. Do not cover the antenna area with your fingers or anything else.

- Stand still. If possible, stand still until your terminal is finished determining your location. Moving your terminal at a walking pace while your terminal is calculating your approximate location may substantially decrease GPS performance.
- In a car. When using the GPS feature in a car, position your terminal so that the GPS antenna has good access to GPS signals. Typically, the GPS antenna has best access to GPS signals in a car when placed near a window.

GPS Icon

When your terminal is receiving valid GPS location data, a GPS icon will be shown in the display:



Please note, that during emergency mode, your terminal will not display the GPS icon even when receiving GPS location data. If valid GPS location data is available when you leave emergency mode the GPS icon will be displayed again.

GPS Enable/Disable

1. From the main menu, press  and select **More...> Location > Interface**. The current selection (**On/Off**) is highlighted. Select the new choice. The display shows:

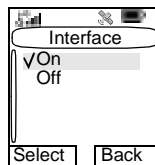

- **Location Service Off**
- **Location Service On**

Entering GPS Location Service

To enter the GPS sub-menu, press  and select **More...> Location**:

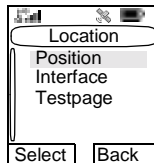

- **Position** provides the actual position information.
 - **Interface** allows you to enable/disable the GPS location service.
 - **Testpage** provides the actual satellite information.
- Scroll to your selection and press **Select** to access the next display.

This estimate of accuracy of the calculated location is only a very rough estimate and may vary substantially from the actual accuracy of the approximate location information reported.



- The variation will vary in accordance to the GPS Configuration set by your Service Provider.
- The availability of the GPS Location menus is dependent on your terminal configuration, please contact your Service Provider for further details.

Viewing Your Position

1. From the main menu, press  and select **More...> Location > Position**.
2. Scroll to view the entire screen.

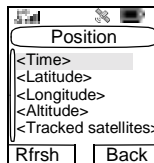

This displays the following information about the last time your location was calculated (if available):

- The **time** the location was last calculated
- The **latitude** expressed in degrees, minutes, and seconds
- The **longitude** expressed in degrees, minutes, and seconds
- The **altitude** expressed in meters
- The **number of satellites** used to calculate the location. In general, more satellites make for better accuracy. The maximum is twelve satellites.

To calculate your location again, press **Rfrsh**.

It may take your terminal several minutes to complete the process of determining your location. During this time, a message usually appears on your terminal's display stating:

- Insufficient Visible Satellites, or
- Insufficient Visible Data

For tips on getting the best location calculation, see “Enhancing GPS Performance” on page 62.

The **Position** screen displays the updated information.

To cancel a location calculation before it is completed:

Press **Back** to return to the previous screen.

Each time approximate location of your terminal is calculated, the latest location information is stored in your terminal and remains there even when your terminal is powered off. You will see this information the next time you view the **Position** screen.

If you received a terminal call or alert while attempting to determine your location, the **Position** screen will disappear, but your terminal will continue attempting to determine its location. If it is successful, the new location information will be displayed the next time you view the **Position** screen.

GPS Testpage

Satellite Almanac Data

Government officials maintains an almanac of data about where GPS satellites are as they orbit the Earth. This information is available to your terminal. Keeping your satellite almanac up to date helps your terminal determine your location more quickly.

The almanac contains information about the location of satellites, their operational status, and other satellite information.

In most cases, your terminal will be able to get a fix in strong satellite signal conditions with outdated almanac data, but it may take longer.



When you make an Emergency Call, your terminal does not rely upon the almanac to determine your location.

Entering the Testpage

The Testpage provides GPS information (such as the number of satellites used, the strength of each one, etc.).

1. From the main menu, press  and select **More...> Location > Testpage**.
2. Scroll to your selection and press **Select** to access the next display.

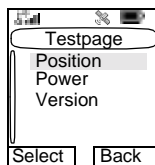

Position

1. From the main menu, press  and select **More...> Location > Testpage > Position**.
2. Scroll to your selection and press **Select** to access the next display.

This displays the following information about the last time your location was calculated:

- The **time** the location was last calculated
- The **latitude** expressed in degrees, minutes, and seconds
- The **longitude** expressed in degrees, minutes, and seconds
- The **altitude** expressed in meters
- The number of **satellites used**
- The **bearing (B)** - refers to the direction to a waypoint
- The **horizontal speed (HS)**
- The **level of confidence** in percent (LC)

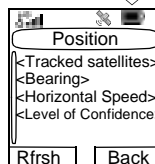
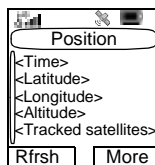

Power

1. From the main menu, press  and select **More...> Location > Testpage > Power**.
2. Scroll to your selection and press **Select** to access the next display.

This displays a list of satellites. Scroll to your selection and press **Select** to access the data for each satellite:

- Satellite PRN (Pseudo Random Noise) number (i.e., the satellite ID number)
- Satellite Status
- Satellite Mode
- Satellite Carrier-to-Noise (C/N) ratio (i.e.: a power ratio of wanted to unwanted signal, expressed in decibels).

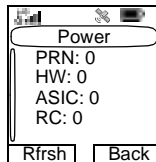

Satellite Status indicates the Channel status. Channel assignments only persist until the Phoenix IC computes a new visible list (which happens periodically in the Phoenix IC after position fix). Satellites above the horizon will remain on their assigned channels. Satellites below the horizon will be removed from their pseudo-channels.

The possible values are:

- 0- Searching
- 1- Detecting
- 2- Acquiring
- 3- Frequency locking
- 4- Bit sync detecting
- 5- Tracking
- 6- Time decoding
- 7- Ephemeris decoding
- 8- Available for fix
- 9-11 - Reserved

Satellite Mode indicates which parameters are valid upon input. The remaining parameters are ignored. On output, the Mode indicates which parameters have been measured or calculated.

The possible parameters are:

- Doppler
- Doppler Uncertainty
- Code Phase
- Code Phase Uncertainty
- Data Phase
- Data Bit
- Azimuth
- Elevation

Version

1. From the main menu, press  and select **More...> Location > Testpage > Version**.
2. Scroll to your selection and press **Select** to access the next display.

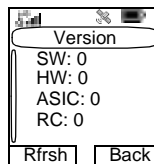



This displays the following information about the software used to calculate the location:

- **Software Version (SW)** - the version of the firmware installed on the Phoenix Integrated Circuit (IC).
- **Hardware Version (HW)** - the version of the Phoenix IC
- **ASIC** (Application Specific Integrated Circuit) Version
- **Release Code (RC)**

The Menu

To Enter the Menu Items

You can enter the menu items during a call. If you are viewing a menu when a new call starts, the terminal will exit the menu.

1. Press .
2. Scroll to the required item, press **Select** or  to select.

Or use shortcuts to access frequently-used menu items. (See “Shortcuts” on page 99.)

If the menu item contains a further set of menu items as in the example below, repeat step 2.

Navigating Menu Items

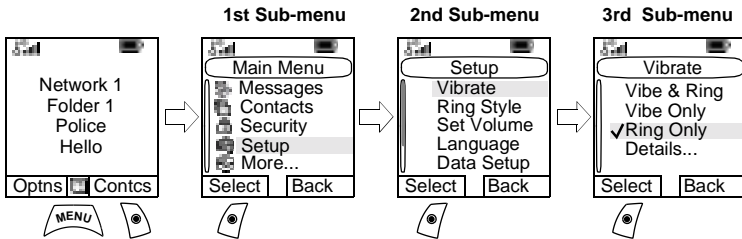

When scrolling up/down menu items, try also right/left scrolling. (This will select the item or return to previous level.)

In a list press and hold  for automatic scrolling.

To Return to the Previous Level

Press Back or .

To Exit the Menu Items









Press .



Your MTH800 may exit if no key presses are detected for a time-out period.

Menu Icons

The following icons make it easy to identify the menu items at first glance.

Menu Icon	Description
	Main Menu Items/Context Sensitive Menu Appears above  if the main menu items/context sensitive menu are active.
	Messages <ul style="list-style-type: none">• Send status messages,• Send short text messages (free text or according to user defined or predefined templates),• Receive messages in Inbox.
	Contacts Add, search, edit, or erase entries in the contact list.
	Security Lets you turn On/Off and verify security features, and change passwords.
	Setup Allows you to customise your MTH800.
	More... Contains more customisable menu items.
	Scroll Bar Indicates navigation among items that occupy more than one screen. If all items appear in one screen, the scroll bar is empty.

List of Menu Items

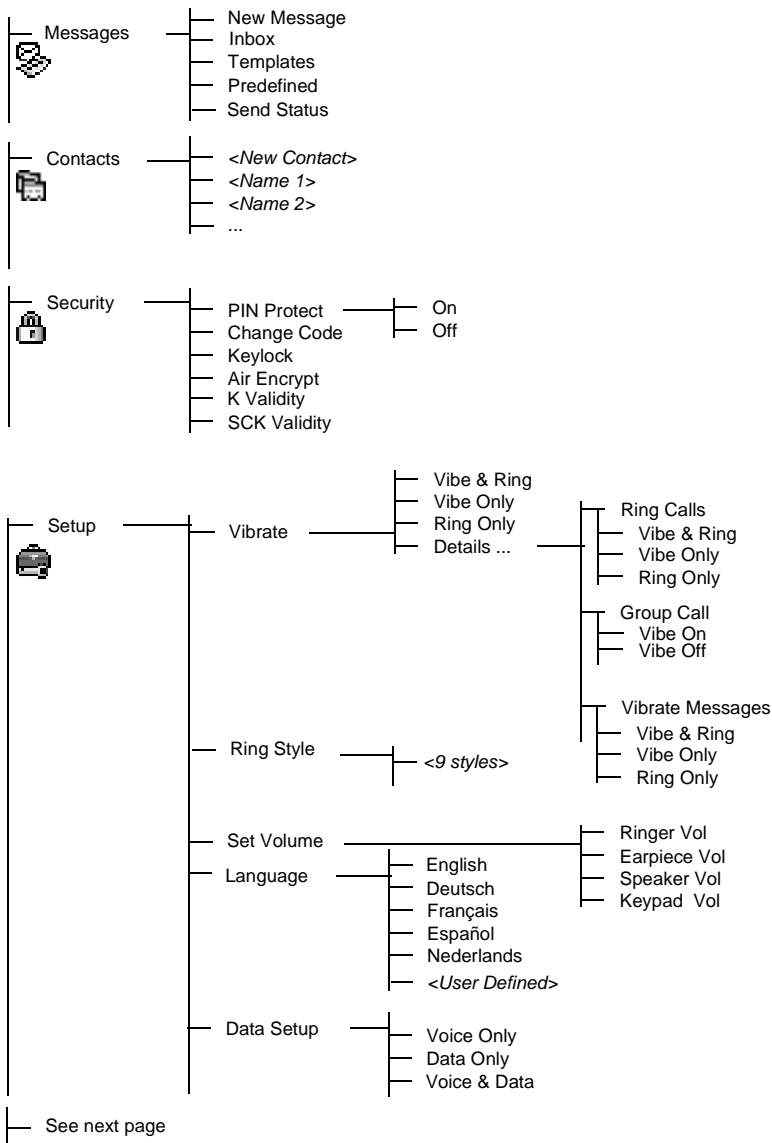

List of Menu Items (Cont'd)

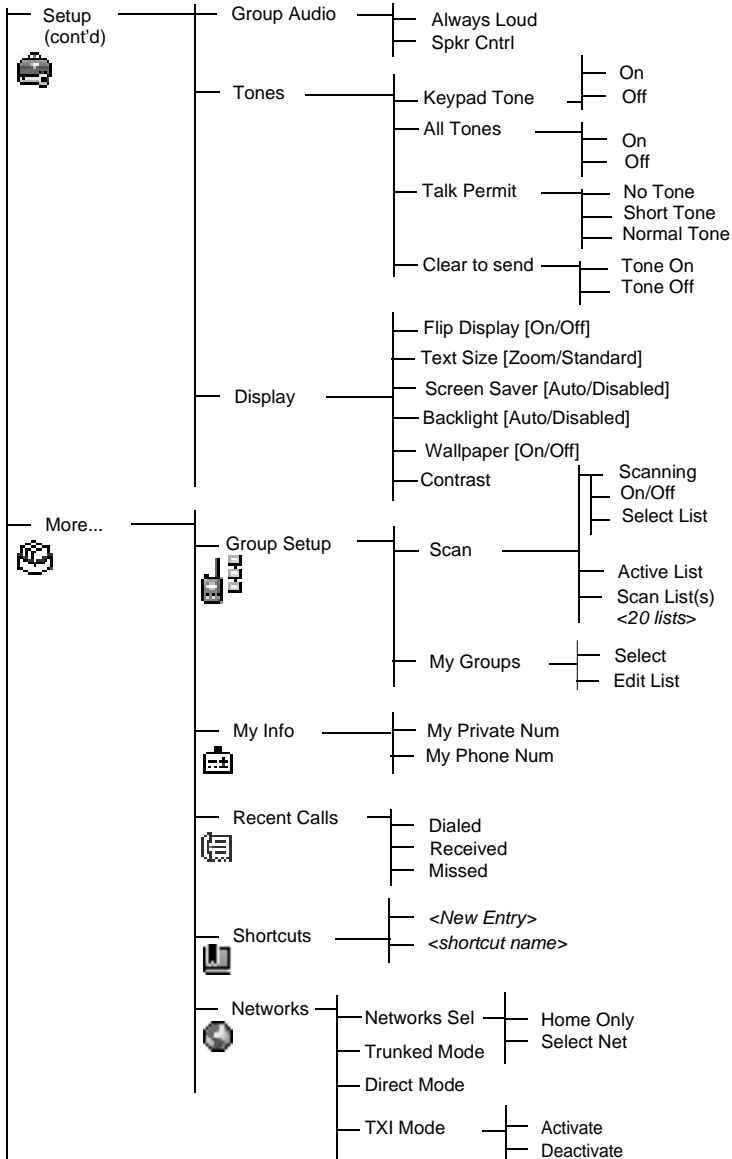

List of Menu items (Cont'd)

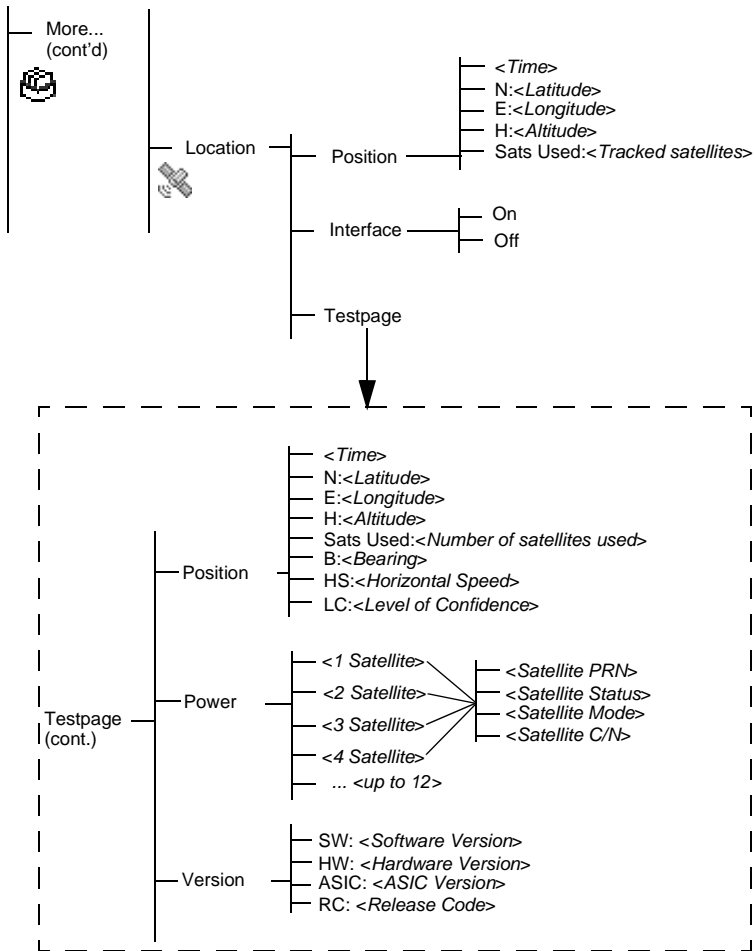

This is the standard menu layout. Your Service Provider may enable/disable some menu items or change their names.

Messages

Refer to “Messages” on page 104 for details.

Contacts





General



Contacts stores Private, Phone, and PABX numbers. Each Contacts entry can store several numbers. A Contacts entry contains:

- A name—A name is required if you are storing more than one number to the entry; otherwise, it is optional. Typically, this is the name of the person whose contact information is stored in the entry.
- A Contacts type—Each number stored must be assigned a Contacts type.
- A number—Each Contacts entry must contain a number. This may be any type of phone number and Private ID.
- A Speed Dial number — When you store a phone number, it is assigned a Speed Dial number. You can accept the default Speed Dial number or change it.

Contact Icons

In the contact list display, the following icons may appear next to the contact numbers to indicate the type of stored number.

Contact Icon	Description
	Private ID Number
	Mobile Phone Number
	Home Phone Number
	Work Phone Number

Contact Icon	Description
	PABX Number
	Other Phone Number
	Pickers Indicate more than one number is stored with the contact.

Creating a Contact

- From the Home display, press **Contcs**.
Select **[New Contact]**.
Or - from the main menu select **Contacts**. Select **[New Contact]**.
Or - while editing the list from the Contacts Menu, select **[New Contact]**.
- Enter name. (For details on text editor use, see “Writing Text” on page 114). Press **Ok** to confirm.
- Scroll left or right and select the type of stored number (such as Private).
- Enter number (#). Press **Ok**.
- Scroll up and down the entries. Continue to enter other types and numbers, as you may keep several numbers (Private, Mobile, Home, Work, PABX, Other) for the same person under the same contact name. To correct an entry, press **Change**.
- When finished, press **Done**. Press **Back** to return to Home display.

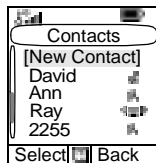

Editing a Contact

1. From the contact list, scroll to the entry you want to edit.
2. Press  to enter Contacts. Select **Edit**. The entry details screen displays.
3. Follow the instructions in “Creating a Contact” on page 75 to edit the various fields.

Deleting a Number

1. From the contact list, scroll to the entry that contains the number you want to delete.
2. Scroll left or right to display the contact type for the number you want to delete.
3. Press .
4. Select **Delete Number**.
5. Press **Yes** to confirm.



If an entry contains only one number, deleting the number deletes the entry.

Deleting a Contact

1. From the contact list, scroll to the entry you want to delete.
2. Press .
3. To delete the entire entry, select **Delete Contact**.
4. Press **Yes** to confirm.

Checking Capacity

To see how many numbers are stored in Contacts:

1. From the contact list, press .
2. Select **Capacity**.
3. Select the contacts to check. Select **Back** to exit.

Security

From the main menu, select > **Security**.

PIN Protect

Network access protection is configured by your Service Provider:

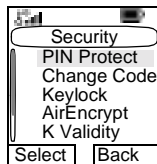

- No access to network operation — you can only send or receive Emergency Calls and adjust the volume level. Unit lock takes effect at the next power on.

To protect access to network operation:

1. From the main menu, select > **Security** > **PIN Protect**. **On** is highlighted.
2. Press **Select**.
3. At the **Code?** prompt enter the 4-digit code (factory setting 0000). To avoid disclosure of the code, asterisks are displayed instead of the code digits. The display will show the following message:

Unit Locked—you entered the correct code. The display returns to the Security sub-menu and shows the active setting: **On**.

To unlock the MTH800 before powering off:

1. From the main menu, select > **Security** > **PIN Protect**. **Off** is highlighted.
2. Press **Select**.
3. At the **Code?** prompt enter the 4-digit code. The display will show the following message:

Unit Unlocked—you entered the correct code. The display returns to the Security sub-menu and shows the active setting: **Off**.

To unlock the MTH800 after powering on, enter the code at the prompt. The MTH800 enters the Home display.

If you fail to enter the correct code, the following message will be displayed:

Incorrect Code Entered—You are prompted to try again. After failing, your MTH800 will be blocked. Please check with your Service Provider how many failed attempts are allowed.

How to unblock the MTH800

The display shows **Unit Blocked**. You send or receive calls an Emergency Call.

To unblock the MTH800, enter the PUK (Personal Unblocking Key). The PUK is an eight-digit master code to be obtained from your Service Provider.

After entering the PUK successfully, you will be prompted to replace the forgotten code.

At the **New Code?** prompt enter the new 4-digit code, and repeat the code to confirm. If the code does not match, you will be prompted to enter it again until the new code message is accepted.

Change Code

From the main menu, select **> Security > Change Code**.



The default PIN code is 0000.

At the **Old Code?** prompt, enter the 4-digit code. If the old code does not match the entered code at verification, the display prompts you to re-enter the old code.

If the entered code matches the old code, the display prompts you to enter a new 4-digit code and to repeat it for confirmation. If the confirmation code does not match the new code, the display prompts you to re-enter the new code.

When the new code is accepted, the display returns to the Security sub-menu.

Locking/Unlocking the Keypad



To prevent accidental key/button presses:

1. Press   **OR**,

From the main menu, select **> Security > Keylock**. The keypad is locked except .

2. To unlock the keypad, press  .



When there is an incoming call and the keypad is locked, you can still use the **PTT**, rotary knob, , and .



The Emergency button is not locked. Entering Emergency Operation, unlocks all keys.

Air Encryption On/Off

From the main menu, select **> Security > AirEncrypt**.

This sub-menu allows you to view air encryption On/Off state.

Call encryption provides service confidentiality between you and the system.

If encryption is on and you receive a clear call (unencrypted), the MTH800 will display a **Call & Data Not Encrypted** message.



You cannot manually disable Air Encryption (if fitted) from the menu. This sub-menu only indicates if Air Encryption is enabled at that moment.



The Air Encryption feature is **ONLY** enabled depending on your Service Provider.

Encryption Key Deletion

Please check with your Service Provider whether the terminal is provided with air interface encryption keys.

You can delete the air interface encryption keys from the terminal by entering the following sequence from the keypad:

****00##**



CAUTION!

Using this feature will disable the terminal, and your Service Provider will need to re-enable the terminal.



Deletion should be performed in idle TMO/DMO or Emergency Operation.

K Validity

From the main menu, select **Security > K Validity**.

K (Key) is a secret key the infrastructure uses to authenticate the MTH800 in the system. It is part of the authentication that provides service confidentiality between your MTH800 and the system.

To verify K validity, press **Select**. The display will show one of the following messages:

- **K is Valid**—the infrastructure can authenticate your MTH800.
- **K is Invalid**—the infrastructure shall not authenticate your MTH800. Please call your Service Provider to restore K to your MTH800.

SCK Validity

From the main menu, select **Security > SCK Validity**.

SCK (Static Cipher Key) is a secret key the infrastructure uses to encrypt call and data in the system. Air interface encryption provides service confidentiality between your MTH800 and the system. Your MTH800 should be provided with a set of SCKs.

To verify SCK validity, press **Select**. The display will show one of the following messages:

- **SCK is Valid**—your MTH800 can work encrypted.
- **SCK is Invalid**—your MTH800 cannot work encrypted.
Please call your Service Provider to restore SCKs to your MTH800.

Setup

Entering the Setup Sub-menu

From the main menu, select **> Setup**.

This sub-menu allows you to change your MTH800 configuration: vibrate, ring style, volume, language, data setup, speaker, tones, and display.

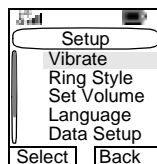

Setting the Vibrate Feature

This sub-menu allows you to determine if your MTH800 vibrates, or rings, or both vibrates and rings when receiving a call.

To change the Vibrate setting:

1. From the main menu, select **Setup > Vibrate**.
2. Scroll through the settings.
3. Select required setting, and press **Back to exit**.

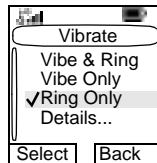

The Vibrate settings mentioned above apply for all calls. Your MTH800 can associate different Vibrate settings for different calls.

To make specific Vibrate settings for different calls:

1. From the main menu, select **Setup > Vibrate > Details**.
2. Choose which type of call that you want to modify its Vibrate settings, and press **Select**.

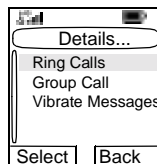

Ring calls are Phone calls, PABX and Full-Duplex Private calls. Calls are Group, Emergency and Private (in half-duplex). Vibrate Message (Vibrate Msgs) are Status Messages and Text Messages.

3. Select the required setting, and press **Select**. Press **Back** to exit



If you chose Ring Calls or Messages, the settings available are Vibe & Ring, Vibe Only or Ring Only. If you chose Group Call, the settings available are Vibe On or Vibe Off only.

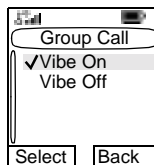
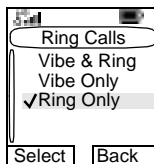

Setting the Ring Style

This sub-menu allows you to set the incoming call ring style. Your MTH800 features nine selectable ring styles.

From the main menu, select **Setup > Volume**.



Upon entry into this sub-menu, the display shows the current ring style used.

Scroll to the desired style and press **Set**. You will hear the new ring style immediately for a few seconds. If necessary, adjust the volume level.

Setting the Volume

Once in the menu, select **3 Set Volume**.

This sub-menu allows you to adjust the ringer, earpiece, speaker, and keypad tone volume.

To set the volume:

1. From the main menu, select **Setup > Volume**.
2. Scroll through the list.
3. Choose the required item, and press **Change**.
4. Adjust the volume level. A feedback tone is heard, and a volume level bar is displayed.
5. Press **Back** to exit.

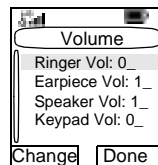

Setting the Display's Working Language

From the main menu, select **Setup > Language**.

The display shows the current language used. You can customize your MTH800 to operate in English, German, French, Spanish, Dutch, or in a language defined by your Service Provider. The default setting from factory is English.



Scroll to the desired language and press **Select**. The display shows the selected language for a few seconds.

Setting Up the Data Function

You can connect the MTH800 to an external device (such as a laptop or desktop PC). The MTH800 will then be capable of transmitting and receiving data from the external device. To connect the MTH800 accessory connector to the external device, use cable FKN4897. The external device must run an application complying with the TETRA standards.

From the main menu, select **Setup > Data Setup**.

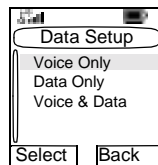

The display shows the current setting:

1. **Voice Only**—The MTH800 will receive and transmit voice calls only.
2. **Data Only**—The MTH800 acts as a modem. The MTH800 will reject incoming and outgoing voice calls (except for Emergency Calls), status and text messages.
3. **Voice & Data**—The MTH800 acts as a modem but voice calls will have priority over data calls and will interrupt them.

Scroll to the desired setting and press **Select**.

In **Data Only** and in **Voice & Data**, the Data Connected icon is displayed after you have connected the MTH800 to the external device and the MTH800 is ready for data transfer. The Data Transmit/Receive icon is displayed to indicate data is being transferred to/received from the external device.

The MTH800 ends the AL call and the microphone is closed when the MTH800 is in one of the following states:

- Entering the out-of-service area
- Outgoing packet data call setup

To exit **data**, return to **Data Setup** and select **Voice Only**. The MTH800 returns automatically to Voice communication.



Data services are available only in TMO. Data Services are blocked in TXI Mode.



When set to Voice Only, the built in data modem is disabled to conserve battery power.

Setting Group Audio

You can control audio routing (speaker/earpiece) for any Private or Group Call via the dedicated Speaker Control key (see page 21.)

You can also define via the menu to have all Group calls in high audio or controlled by the Speaker Control key.

1. From the main menu, select **Setup > Group Audio**.
2. The display shows the current audio setting. When set to Always Loud, the audio sounds from the speaker (high audio). When set to Speaker Control, the audio will sound from the earpiece or the speaker, per Speaker Control key use.
3. Select the required setting.

Setting Tones

From the main menu, select **Setup > Tones**.

This sub-menu allows you to activate/deactivate the MTH800 tones.

For a detailed list of tones, see “Tones” on page 128.

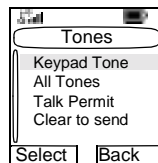

Setting Keypad Tone

To activate/deactivate keypad tone at every key press:

1. From the main menu, select **Setup > Tones > Keypad Tone**.
2. Scroll through the settings (**On/Off**).
3. Choose required setting, and press **Select**, or press **Back** to exit.

Setting All Tones

To activate/deactivate all tones (keypad tone and other activity tones used in your MTH800):

1. From the main menu, select **Setup > Tones > All Tones**.
2. Scroll through the settings (**On/Off**).
3. Choose required setting, and press **Select**, or press **Back** to exit.



When all tones are disabled, your MTH800 switches into covert mode, and all audio is routed to the earpiece, instead of the speaker for low audio operation. Remember to disable this feature, when your covert operation is complete, to return your MTH800 to high audio operation.

Setting Talk Permit Tone

There are 3 tone settings:

- **No Tone** (no tone heard upon pressing the **PTT**).
- **Short Tone** (a short tone heard upon pressing the **PTT**).
- **Normal Tone** (the factory-default tone heard upon pressing the **PTT**).

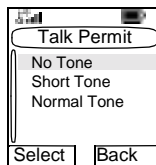

To change your Talk Permit Tone settings:

1. From the main menu, select **Setup > Tones > Talk Permit**.
2. Scroll through the settings.
3. Choose required setting, and press **Select**. Press **Back** to exit.

Setting Clear to Send

The Clear to Send tone indicates to the transmitting terminal that the receiving terminal is ready to accept the transmission.

To activate/deactivate the Clear to Send tone:

1. From the main menu, select **Setup > Tones > Clear to send**.
2. Choose required setting, and press **Select**. Press **Back** to exit.

Display Features

The display menu controls how the display appears.

From the main menu, select **Setup > Display**:

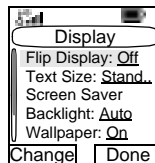

- **Flip Display**—flips the display upside down.
- **Text Size**—sets size of text on the display.
- **Screen Saver**—covers the MTH800 display after the MTH800 stays idle for a pre-programmed period of time (if configured by your Service Provider).

- Backlight—A backlight lights the display and keypad when you make or receive a call, or press keys or buttons. Backlight can be set to Automatic or Disabled.
- Wallpaper—changes the wallpaper that appears on the idle screen.
- Contrast—sets the contrast of the display.

Setting the Display's Vertical Flip

When this feature is activated, the content of the display is flipped upside down. The feature is particularly useful for a user who has to wear the MTH800 on shoulder, belt, or lapel and at the same time wishes to read the display upside down.

To activate/deactivate:

From the main menu, select **Setup > Display > Flip Display > On**. Or press and hold the pre-programmed one-touch button (if configured by your Service Provider).

Please note the position of the soft keys in the vertical display.

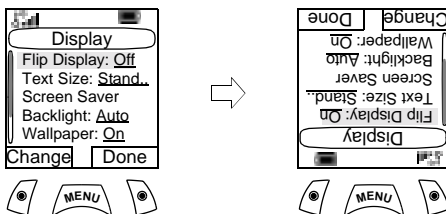

For Rotary knob use in the flipped display, see page 18.
See below for navigation key use in the flipped display.

Scrolling down and up using the navigation key

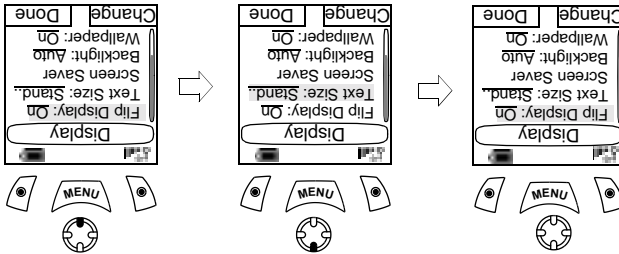

Scrolling left and right using the navigation key

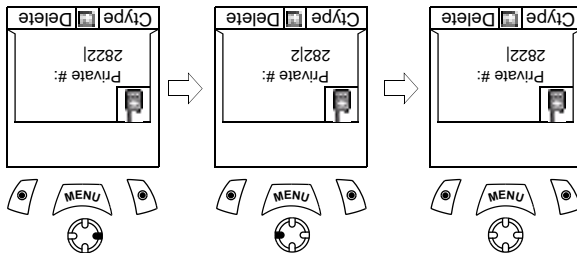

To exit display flip:

From the main menu, select **Setup > Display > Flip Display > Off**.

Setting the Text Size

1. From the main menu, select **Setup > Display > Text Size**.
2. Press **Change**. Select **Normal** or **Zoomed** to see the text on the display in two sizes.

Setting the Screen Saver

1. From the main menu, select **Setup > Display > Screen Saver**.
2. Press **Change**. Press **Change** again and select the screen saver setting: **Automatic** or **Disabled**.

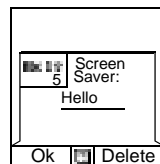

3. Scroll to **Text**. Press **Change**. Type/ edit the screen saver text using the keypad. (For details on text editor use, see "Writing Text" on page 114).
4. Press **Done** to exit.



The menu options will display the Screen Saver if your Service Provider pre-programmed this feature.

Setting the Backlight

Your MTH800 has 2 backlight settings:

Auto

Any key press turns the backlight on. The backlight remains on until the pre-programmed timer runs out.

Disable

The backlight feature is disabled.

To change your backlight settings:

1. From the main menu, select **Setup > Display > Backlight**.
2. Press **Change**.
3. Select required setting.
4. Press **Done** to exit.

Setting the Wallpaper

1. From the main menu, select **Setup > Display > Wallpaper**.
2. Press **Change**.
3. Select required setting (**On/Off**).
4. Press **Done** to exit.

Setting the Contrast

1. From the main menu, select **Setup > Display > Contrast**.
2. Press **Change**.
3. Use the left and right navigation keys to change the contrast. Press **Ok**.
4. Press **Done** to exit.

Entering More...

From the main menu, select **More**. This sub-menu Contains more customisable menu items.

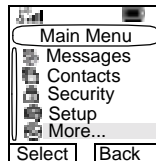

Entering Group Setup

From the main menu, select **More > Group Setup**. This sub-menu allows you to set the Scan and My Groups features.

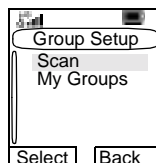

Entering Scan

From the main menu, select **More > Group Setup > Scan**.

This sub-menu allows you to activate/deactivate scanning, view the active scan list, and edit the scan lists.



It is not possible to enable or disable group scanning in TXI Mode.

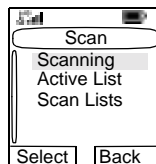

Setting Group Scanning

This sub-menu allows you to activate/deactivate the scanning of a list of pre-defined groups programmed in the MTH800. The MTH800 will join any group call as long as this group is defined in the scan list and scan is turned on.

From the main menu, select **More > Group Setup > Scan > Scanning**.

After completing the settings, the display returns to the Scan sub-menu.

Set Scanning to On

Scanning is **Off**. Select **On**. A message may indicate that all scan lists are empty. Select **Scan Lists** to fill the scan list(s).

The display shows the following state:

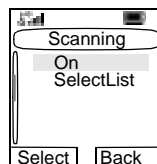

Then, the display shows (for example) the

Scanning Scan List 1 message. The terminal will then try to attach to this list.

Set Scanning to Off

Scanning is on. Select **Off**. The display shows the following state:

Then, the display shows the **Scanning is Off** message.

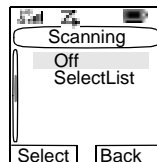

Selecting a List with Scanning On

1. Select **SelectList**.
2. To select a list other than the highlighted one, scroll and press **Select**. The display shows (for example) the **Scanning Scan List 1** message. The terminal will then try to attach to this list.

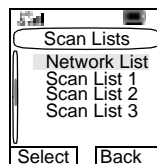

Selecting a List with Scanning Off

1. Select **SelectList**.
2. To select a list other than the highlighted one, scroll and press **Select**. The display shows (for example) the **Scan List 1 Selected** message.

The Network List

Your terminal can scan (and attach) to a list belonging to another infrastructure than the Dimetra infrastructure:

- Upon pressing **Select**, if the Network List is selected, only this list will attach. If a user list is selected, then both the Network List and the user list will be attached.
- In some cases part of the groups in the scan list could be invalid for specific sites. In this case, when the terminal tries attachment to the list, the infrastructure might partially reject attachments. The terminal's display shows: "List partially attached".
- When the Network List is empty, it will be displayed as **No List**. Selecting **No List** will display the message **No Selected Scan List**.

Viewing the Active Scan List

This sub-menu allows you to view the active scan list (Scan List 1 in this example).

1. From the main menu, select **More > Group Setup > Scan > Active List**. Press **View**.

The display will show one of the following states:

- There is a selected, inactive scan list (**Scan List 1 is Not Active**). Scanning is off.
- Scanning is off and the Network List is selected (**Network List Not Active**).
- There is a selected, active scan list. Scanning is on.

Then, the display will show the Scan Lists sub-menu.

2. Scroll to the required list and press **View** to see the groups that belong to the list.
3. Scroll to the required group and press **View** to view the group status (attached or not attached) and priority (if pre-programmed).
4. Press **Back** to return to the previous display. Then, if required, press . You can select to **delete** the group from the scan list or **change** its priority.

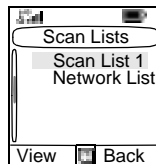

If the Network List is empty, it will not be displayed.

Editing Scan Lists

1. From the main menu, select **More > Group Setup > Scan > Scan Lists**.
2. Scroll to the required scan list. Press **View** to see the groups used in the scan list. Press **Back** to return to the previous display.
3. To edit/view the contents of a scan list, press .
4. In the List Optns sub-menu, scroll to the required option and press **Select**.

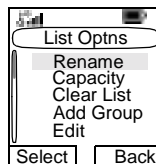
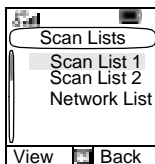

- The options below **cannot** be used for the Network List.
- If the Network List is empty, it will not be displayed.

- **Rename** the active scan list. (For details on text editor use, see “Writing Text” on page 114). Enter a new name (alias) and press **Ok**. The display shows the new setting.
- Check the **capacity** of the active scan list (number of groups stored in the list).

- To **Clear** all groups from the selected scan list, press **Yes**. You will be prompted to remove all groups from the selected scan list.
- **Add** a group to the selected scan list. Every added group (including a favourite group) comes with its folder, its name or number, and its priority (if pre-programmed).
 - To select a folder, scroll through the folder list. The list does not show folders whose groups are fully used in the selected scan list. Press **Ok** to select a folder.
 - To select a group, scroll through the group list within the selected folder. The list shows groups that are not in the selected scan list. Press **Ok**.
 - To set a priority to a group, scroll through the priority list: high, medium, or low.
 - A call from a high priority group will interrupt an on-going call with a medium and low priority.
 - A call from a medium priority group will interrupt an on-going call with a low priority.
 - A call from a low priority group will not interrupt any on-going call.
- **Edit** the scan list groups.
 - Scroll to the group you wish to remove from the selected scan list, and press **Delete**. You will be prompted to remove the selected group. After a few seconds, the display shows the updated scan list.
 - To change the group priority, press **Priority**. Scroll to the selected priority and press **Select**.

My Groups (TMO/DMO)

This sub-menu allows you to select/edit your favourite group list.

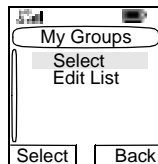

Selecting a Group from My Groups

1. From the main menu, select **More > Group Setup > My Groups > Select**. (If the folder is empty, add groups.)
2. The screen returns to the Home display. My Groups is displayed as the first highlighted folder in the list of folders. You can now scroll through the favourite group list. Press **Select** to confirm your choice.

When selecting **My Groups** and no groups exist from the current DMO/TMO, you may be forced to switch from TMO to DMO or from DMO to DMO. In this case you will be prompted to accept the mode change.

Adding a Group to My Groups

1. From the main menu, select **More > Group Setup > My Groups > Edit List > [New Group]**.
2. Select a group by folder search ("**TMO/DMO by Folder**"). Select the folder and select the group. The group is added to the "My Groups" folder. *OR*, select a group by alphabetic search ("**TMO/DMO by abc**"). Enter the first character of the group's name.

Deleting a Group from My Groups

1. From the main menu, select **More > Group Setup > My Groups > Edit List**.
2. Select the group you wish to remove. Select **Yes** to confirm removal.

Deleting All Groups from My Groups

1. From the main menu, select **More > Group Setup > My Groups > Edit List**.
2. Press . Select **Delete All**. Select **Yes** to confirm removal.

Viewing/Modifying Personal Information

Use this feature to view your own private or phone number at any time.

1. From the main menu, select **More > My Info**.
2. Select **My Private Number** or **My Phone Number**.

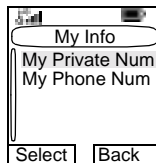

The displayed private number cannot be modified.

To modify the displayed phone number, press **Edit**.

Edit the number and select **Ok** to confirm. The new phone number does not modify the MTH800 number in the system.

Recent Calls

You can view the history of all calls:

- Dialed Calls
- Received Calls — calls you answered
- Missed Calls — calls received but not answered, or rejected by the MTH800.

Each list of calls may contain up to 10 numbers, the more recent call being at the top of the list.

If the number of a recent call is stored in the contact list, the name associated with the number appears in the recent calls list.

An icon appears beside the name or number, indicating the contact type of the number used in the call. See "Contacts" on page 74.

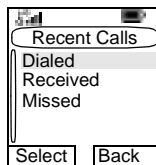

Old calls remain in your recent calls list until you delete them or until they reach the end of the list.

A number dialed more than once, will appear only once in the list.

Upon receiving a missed call notification, the MTH800 will display the missed calls prompt.

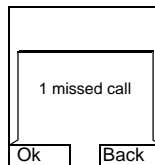

When a call is received during an active call, the number is written to the missed calls list.

This missed calls prompt will be invoked automatically at the end of the call. Press **Ok** to display the missed calls list.

Viewing Recent Calls

1. From the main menu, select **More > Recent Calls**.
2. Scroll to the desired list (dialed, received, or missed) and press **Select**.

To get more information on a recent call:

From the recent calls list, select the call you want information on. Press **View**. This displays information such as the name associated with the call and the number of the call.

Storing Recent Calls to Contacts

1. From the recent calls list, scroll to the number you want to store.
2. Press **Store**.



If **Store** is not in this menu, the number is already stored in Contacts.

3. To store the number as a new entry, select **[New Entry]**. Or, to store the number to an existing entry, select the entry.
4. With the contact type field highlighted, scroll left or right to display the contact type you want to assign the number. For information on contact types, see page 74.

5. If you wish to add more information to the entry, see page 75.
6. Press **Done**.

Deleting Recent Calls

1. From the recent calls list, scroll to the call you want to delete.
2. Press . Enter Dialed Calls. Select **Delete**. Press **Yes** to confirm.

To delete all calls:

1. From the recent calls list, press .
2. Select **Delete All**. Press **Yes** to confirm.

Calling from Recent Calls

1. You can make a Phone, PABX, or Private Call from the entry, depending on the entry you are selecting in the list.



A call that was missed or received without a calling number, will be stored in the list as “unknown”. You cannot start a call to such a number.

2. After completing the call, the MTH800 will exit the received/missed/dialed list.



From the Home display press  to access the list of the last dialed calls.

Shortcuts

Use shortcuts to access frequently-used menu items.

Help on Creating a Menu Shortcut

1. From the main menu, select **More > Shortcuts**.
2. Select **[New Entry]** and read the first page of instructions. Press **More** to read the second page.
3. Press **Done** to exit help.

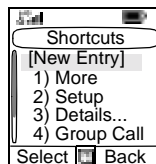

Creating Menu Shortcut

For example, let's create a shortcut to the All Tones options.

1. From the main menu, select **Menu > Setup > Tones**, then highlight **All Tones**.
2. Press and hold  until a confirmation screen appears. Press **Yes** to confirm.
3. The first free position is assigned as a shortcut key. A confirmation screen appears. Press **Done** to confirm.

Viewing the Menu Shortcut List

1. Press .
2. Select **More > Shortcuts**. The display shows the shortcut list.



If the Service Provider configures the shortcuts, [New Entry] will not be displayed.

Editing Shortcuts

1. From the main menu, select **More > Shortcuts**.
2. Scroll to the shortcut you wish to edit.

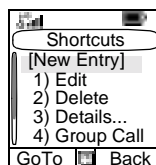



To modify a menu setting or create a new shortcut from this step, highlight the menu option and select **GoTo**. Otherwise, go to Step 3.

3. Press  and select **Edit**.
4. After a few seconds, you will be prompted to confirm the newly created shortcut. The first free position is assigned as a shortcut key. Press **Yes** to confirm. Press **No** to cancel.

If the number is already assigned as a shortcut for another option, you will be asked to replace the current shortcut number with a newly created one.

Deleting Shortcuts

1. From the main menu, select **More > Shortcuts**.
2. Scroll to the shortcut you wish to delete.
3. Press  and select **Delete**. Press **Yes** to delete a shortcut. Press **No** to cancel.

Shortcut Display Messages

The display might show one the following messages for a few seconds:

- **Shortcuts Full:** the shortcut list is full.
Press **Yes** to confirm that you wish to assign a shortcut to the option. Enter a new key number. If the number is already assigned as a shortcut for another option, you will be asked to replace the current shortcut number with a newly created one.
- **Shortcut not Allowed for this Item**
- **Invalid Shortcut Position:** enter a new number from the number entry screen.

Menu Shortcut Use

From the Home display, press  and the numeric key(s) assigned to the shortcut.

Networks

Entering the Networks Sub-menu

From the main menu, select **More > Networks**.

This sub-menu allows you to select the network your MTH800 registers to, and what mode it operates on.

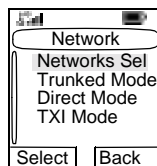

Selecting Your Network

This sub-menu allows you to select the network your MTH800 will be registered to.

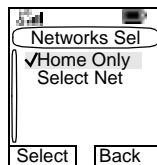

Selecting Home Only Network Registration

From the main menu, select **More > Networks > Networks Sel > Home Only**.

Selecting this sub-menu causes your MTH800 to recognise the first network on the allowed network list only and to register to it.

Using the Select Net Registration

If configured by your Service Provider, this sub-menu allows you to select manually the network from the allowed network list you want your MTH800 to be registered to.

1. From the main menu, select **More > Networks > Networks Sel > Select Net**.
2. The list of the allowed networks is displayed. Scroll to the desired network.

A network may have an alias. Press  to view the network ID. Then press **Select**.

- Return to the Home display. The display shows the network ID or alias.



It is up to your Service Provider to ensure your own MTH800 identity is allowed to register on other networks in your list. Some groups may not be available on other networks.

Selecting Trunked Mode

This sub-menu allows you to select the mode your MTH800 will be operating on.

To set up your operating mode:

- From the main menu, select **More > Network > Trunked Mode**.
- The MTH800 switches to Trunked Mode.

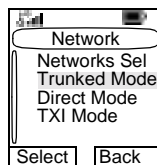

It is not possible to switch from Direct Mode to Trunked Mode, if the MTH800 is in Transmit Inhibit Mode.

Selecting Direct Mode

This sub-menu allows you to select the mode your MTH800 will be operating on.

To set up your operating mode:

- From the main menu, select **More > Networks > Direct Mode**.
- The MTH800 switches to Direct Mode.

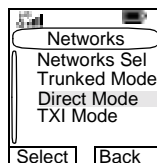

It is not possible to switch from Direct Mode to Trunked Mode, if the MTH800 is in Transmit Inhibit Mode.

Setting Transmit Inhibit (TXI) Mode

This mode should always be set before entering areas where transmission is prohibited, e.g. in hospitals or in potentially explosive areas.

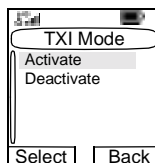

To activate the TXI Mode:

1. From the main menu, select **More > Networks > TXI Mode**.
2. Select **Activate**.

The MTH800 will sound the “Transmit Inhibit” tone. The display shows **TXI Mode** in the first row, and the solid amber LED indicates the TXI Mode.



All menu items which cause transmitting are blocked in TXI Mode. It is not possible to change the group.

To deactivate the TXI Mode, e.g. after you have left the area where transmission is prohibited:

1. From the main menu, select **More > Networks > TXI Mode**.
2. Select **Deactivate**.

The MTH800 sounds the “Transmit Inhibit” tone and exits TXI.

GPS Location Services

Refer to “GPS Location Services” on page 61 for details.

Messages

General

The messaging feature lets you:

- send short text messages (free text or according to user defined or predefined templates),
- send status messages,
- receive messages.

A status is a number corresponding to a pre-programmed message in a list your group recognises. A text message is a short text containing up to 140 characters. Each message is short text with the date and time it was left in the inbox.

Sending a Text Message

General



It is not possible to send a status or text message in TXI Mode.

You can send new messages, send messages based on user defined templates or send messages based on predefined templates.

The predefined templates are programmed into your MTH800 by your Service Provider. The user defined templates are Inbox messages or, new Outbox messages that you choose to store in your MTH800 memory. User defined messages may also be programmed into your MTH800.

You are allowed to edit your messages before sending them. You can send a message when the terminal is idle or during a Group/Emergency/Broadcast Call (if configured).

If configured, a message will alert you of an incoming Group/Emergency/Broadcast call, of your joining it, or of its end.

Sending a text message during a Group Call (if configured)

Press . One of the following might occur:

- The call started before message editing began. The terminal will leave the call and send the message. If the call is still active, the terminal will re-join it.
- The call started after message editing began. The terminal will leave the call and send the message. The terminal will return to the edit screen.
- The call started before or after message editing began. The terminal will send the message while staying in the call.

Sending a text message during Emergency/Broadcast Call (if configured)

Press . One of the following might occur:

- The call started before message editing began. The terminal will leave the call and send the message. The terminal will return to the edit screen.
- The call started after message editing began. The terminal will send the message while staying in the call.

Receiving Messages

If there is no on-going activity in your MTH800, it will enter the Inbox automatically.



You will hear the “New Mail Received” alert tone when a new message is received while your MTH800 is engaged in a call (if configured by your Service Provider).



- For message alert, see settings in the Vibrate menu option (page 81) and the Tones menu option (page 85).
- If your service provider has enabled the PTT Callback feature, then pressing PTT will initiate a call to the message originator. Otherwise, PTT will be directed to the currently selected talkgroup.

Displaying Long Text Messages

In the message view screen, press **More** to read the next page, and **Back** to return to the previous page.

Entering the Messages Sub-menu

From the main menu, select **Messages**.

The sub-menu allows you read text messages, send text messages, and send status messages.

Scroll to your selection and press **Select** to access the next display.





Your MTH800 can receive calls while in the Messages sub-menu.

New Message

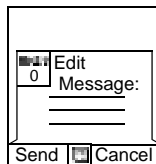

Creating a Message

1. From the main menu, select **Messages** > **New Message**. An empty screen will open.
2. Type/edit your message using the keypad. (For details on text editor use, see "Writing Text" on page 114).



Press . Select **Store** to add your message to the template list. (The number assigned to the message is the lowest free number.)

Sending the Message

1. Press **Send**, **PTT** or, , or the relevant one-touch numeric key. Select the mail recipient of your choice from the contact list or enter the address directly.
2. Select **Send**, or press **PTT** or,  to send the message.

The display will show one of the following delivery reports:

- * **Message Delivered** — to indicate that the message was successfully sent and received.
- * **Message Failed**—the message was not received.

After sending the message, your MTH800 will return to the templates list or to the message editor screen.







It is recommended to wait for the message acknowledge before sending a new message.

Using the Inbox

The inbox list contains new or old incoming text messages. The inbox list can contain 20 messages at any time.

Inbox Icons

The following icons indicate the status of messages in the Inbox.

Inbox Icon	Description
	Unread (New) Message Indicates that you have not read the message yet.
	Read (Old) Message Indicates that you have read the message.
	Sender Information in Message View Indicates sender information (name or number).
	Time and Date Stamp in Message View Indicates the time and date of message arrival.

Entering the Inbox

From the main menu, select **Messages > Inbox**.

The status of the list is displayed for a few seconds:

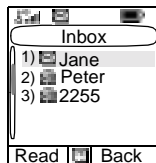

- No New or Old Messages—the screen returns to the previous display within a few seconds.
- New message(s) arrived, and the list is full. Press **Ok** to confirm.
- New message(s) arrived—press any key or wait for a few seconds. The display highlights the incoming message.

Reading a Message in the Inbox

1. Scroll to the message.
2. Press **Read**.

New Message Received

If you press **Back**, you dismiss the message. You can access the message later from the inbox.

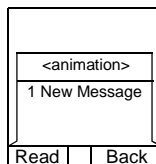



1. Select **Read** to read the entire message. Reading a new text message changes its state from New to Old. The read message is kept in the Inbox.
2. The display shows the incoming message, its number, sender, and the first line of the text message.

Handling Messages

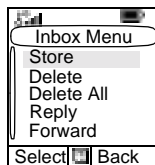
When in the inbox or after reading the message, press  and select one of the following options:







- Select **Store** and press **Select** to store the message as a template in the template list.
- Select **Delete** and press **Yes** to delete the message. When the display shows "**Deleted: Message n**", the current message is deleted from the Inbox. The display shows the next message (if any) or the message list.
- Select **Delete All** and press **Yes** to delete all the messages. When the display shows "**Deleted: All Messages**", all the messages are deleted from the Inbox. The display shows the next message (if any) or the Messages sub-menu.
- Select **Reply**. This invokes the edit screen. The old message body serves as the default message and the message originator is the destination. Press **Send**, **PTT** or , to initiate a call to the message originator.

- Select **Forward**. This invokes the edit screen. The old message body serves as the default message. Press **PTT** or , to initiate a call. Enter the recipient's number and press **PTT** or , to call.
- Select **Refresh** to re-order the inbox list and see new messages (if any).
- Press **Back** to return to the previous display.

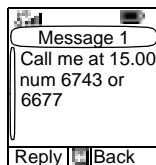
Calling a Number in a Message

You can return a voice call to the sender of a message or to any number that is embedded in the message text. Your Service Provider should configure this feature.



1. In the inbox list, highlight a message.
-Or - Read a message containing number(s).
2. Press **PTT** or .
3. The display lists the numbers (including the sender's number).
4. To call, scroll to your selection and press **PTT** or .
5. Press **CType** to select the type of call (Private, Phone, or PABX). Then press **PTT** or .

If necessary, save the entries in the contact list.

User Defined Templates

The user defined mail templates are received, new, sent or programmed messages that are stored in the templates list and may be used for sending messages.

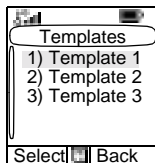



1. From the main menu, select **Messages > Templates**. The first template in the template list is displayed.



It is possible that the templates numbers are not consecutive.

2. In the templates list, scroll to the template you want to use.

Press  and select one of the following options:

- **View** to view the message in the template
 - **Edit** to edit the message in the template for your needs. (For details on text editor use, see “Writing Text” on page 114). Press  to enter the Editor Menu. Select **Store** to save the edited template.
 - **Delete** and press **Yes** to delete the template. When the display shows “**Deleted: Template n**”, the current template is deleted from the Inbox. The display shows the next template (if any) or the templates list.
3. Send the template. See “Sending the Message” on page 106.

Predefined Templates

Predefined mail templates are templates that are programmed into your MTH800 by your Service Provider. You are allowed to perform limited edit operations of the predefined template and to send it, but you will not be able to store the edited template or erase it from the predefined template list.

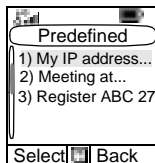

1. From the main menu, select **Messages > Predefined**. The first template in the predefined template list is displayed (if no predefined template exist, the message **No Predefined** will be displayed).
2. Scroll through the list and select the required template.

Press  to enter the Predefined Menu and select one of the following options:

- **View**
- **Edit**. (In the example, a registration message is displayed).

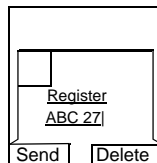

Editing a Predefined Template

Check with your Service Provider for the types of predefined templates in your terminal.

There are three types of predefined templates:

- Alphanumeric—enter characters and digits
- Numeric—enter digits
- Mixed—enter digits, *, and #.

The cursor is located before the first character. To move the cursor forward, scroll right. The editor functions in overwrite mode.

After editing a template, you can send it.

Sending a Predefined Template



A predefined message address is also defined by your Service Provider during programming and cannot be changed.

1. Press **Send**, **PTT** or , or the relevant one-touch numeric key to send the message.
2. The display will show one of the following delivery reports:
 - * **Message Delivered** — to indicate that the message was successfully sent and received.
 - * **Message Failed** — the message was not received.

3. After sending the message, your MTH800 will return to the predefined template list or to the message editor screen.





It is recommended to wait for the message acknowledge before sending a new message.

Sending a Status Message to a Group

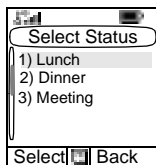
1. Switch to the desired talkgroup, to which you want to send a status message.
2. From the main menu, select **Messages > Send Status**.
3. In this example, Lunch is the last sent status. If you wish to send a different status, scroll to your selection in the list of pre-programmed statuses, or key the status number. To stop scrolling, press **Back**. The display returns to the select status list.



4. Press  to view the status message. Press Back to return to the status list.
5. Press **Select**, then press **PTT** or , or the relevant one-touch numeric key to send the status message.

Targeted Status

If your Service Provider has enabled the Targeted Status feature, the status sending display will show you the option of sending your status to a private number or to a group.

To enter the private number, either key in the recipients number or scroll through the list of numbers, or press **abc** to search the contact list. For a group, select the group within the folder. Then send the status message.

The display will show one of the following delivery reports:

- **Status Sent**—the screen exits the status screen.
- **Sts Failed**—the screen returns within a few seconds to the previous display.



Wait for the delivery report before sending a new status.

If you enter the status menu from a busy talkgroup, audio is momentarily suspended to allow transmission of your status message.

If an Emergency call is received, the MTH800 immediately joins the Emergency call.

Writing Text

Selecting the Text Entry Mode

Text entry modes make it easy for you to enter names, numbers, and messages.

In the text entry screen, select  > **Entry Mode**, and then select one of the following modes:

- **Primary**—for entering alphanumeric characters
- **Numeric**—for entering numbers only
- **Symbol**—for entering symbols only
- **Secondary**—for entering alphanumeric characters. (This mode is optional and you have to add it to the list.)

In the text entry screen, you can also press  repeatedly to change to Primary, Numeric, Symbol, or Secondary (if you have set it up).

Adding Secondary to the List of Text Entry Modes

Secondary is convenient when you use one language, and sometimes wish to switch to another one.

This mode appears in the list only if you set it up first via

 > **Entry Setup**.

None is the default programming from factory and indicates no secondary entry mode is selected.

Selecting the Text Entry Method and Language

There are two text entry methods:













- **TAP**—Enter letters, numbers and symbols by pressing an alphanumeric key one or more times.
- **iTAP**—Let the terminal predict each word as you press an alphanumeric key.



You can use these methods in the languages programmed in the terminal.

In the text entry screen, select  > **Entry Setup**, and then change to one of the methods and its related language (for example: TAP English).

Icons

In the text entry screen, icons tell you which text entry mode and method you are using. A character counter icon indicates the number of entered characters.

Primary Icons	Secondary Icons	Description
		TAP—no capitals
		TAP—capitalise next letter only
		TAP—all capitals
		iTAP—no capitals
		iTAP—capitalise next letter only
		iTAP—all capitals

Numeric Icon	Description
	Enter numbers.
	Enter numbers in iTAP method.

Symbolic Icon	Description
	Enter punctuation and symbols.

TAP Display

Press a key and the display will show the following information:

- the icon indicating the current text writing method—see icons
- the main text entry area that will hold your message after you selected the desired words

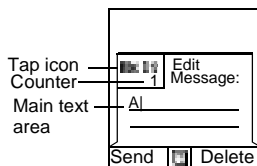

iTAP Display

Press a key and the display will show the following information:

- the icon indicating the current text writing method—see icons
- the main text entry area that will hold your message after you selected the desired words
- a row of suggested characters/ words will be displayed.

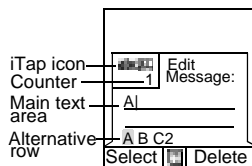

Keys Usage







Characters available for a key are examples and differ for each language setting (see “Setting the Display’s Working Language” on page 83).



List of Keys and Characters in Alphanumeric Mode (TAP/iTAP)

- Except for keys 0 and 1, the top line for each key shows numbers and upper case characters, and the lower line shows numbers and lower case characters.
- Press and hold any numeric key to enter Numeric mode.
- To exit Numeric mode in iTAP, select the word.
- To exit Numeric mode in TAP, press and hold any numeric key.



Key	Alphanumeric Mode (TAP/iTAP)
0+	Press to cycle through single shift, caps lock, and lower case.
1!	./\ _ - : ~ 1 0 ! ? , @ ' ; () & “ ” ‘ ’ % £ \$ ¥ ¢ + x * [] = > < # §
2abc	A B C 2 a b c 2
3def	D E F 3 d e f 3
4ghi	G H I 4 g h i 4
5jkl	J K L 5 j k l 5

Key	Alphanumeric Mode (TAP/iTAP)
	M N O 6 m n o 6
	P Q R S 7 p q r s 7
	T U V 8 t u v 8
	W X Y Z 9 w x y z 9

List of Keys and Characters in Numeric Mode







Key	Numeric Mode
 to 	<ul style="list-style-type: none"> • Press to enter digit at insertion point. • Press and hold any numeric key to enter TAP alphanumeric mode. • To exit TAP alphanumeric mode, press and hold any numeric key.

List of Keys and Characters in Symbol Mode

Key	Symbol Mode
	+ - x * / \ [] = > < # \$
	. ? ! , @ _ & ~ , ; " - () ' ` ; i % £ \$ ¥ ¢
	@ _ \



Key	Symbol Mode
3 ^{def}	/ , ;
4 ^{ghi}	" & '
5 ^{jkl}	() [] {}
6 ^{mno}	¿ ¡ ~
7 ^{pqrs}	< > =
8 ^{tuv}	£ \$ ¥ ¢
9 ^{wxyz}	# % *

Other Keys

Key	Description
any numeric key	<ul style="list-style-type: none"> • In TAP press any key to reject word completion and continue with text entry. A new completion will be displayed, if available, after the time-out for TAP expires. • Press and hold to enter Numeric mode from TAP or iTAP alphanumeric.
	<ul style="list-style-type: none"> • Press to insert a space. • In TAP press to dismiss a word completion and insert a space. • Enter a newly created word into the user dictionary. • Press and hold to enter a carriage return.
	<ul style="list-style-type: none"> • Press once to cycle through all entry modes (symbolic, numeric, primary and secondary if configured). • Press and hold to return to the default entry mode.
Select	Press to select the highlighted choice and place it in the main text area.
Delete	<ul style="list-style-type: none"> • Press once to delete the last entered character. • Press and hold for long to clear the entire main text area.
	<ul style="list-style-type: none"> • Press to navigate up one line in a long text (several lines). Press and hold to repeat. • In TAP press to reject word completion and scroll up.
	<ul style="list-style-type: none"> • Press to navigate down one line in a long text (several lines). Press and hold to repeat. • In TAP press to reject word completion and scroll within the text area.
	<ul style="list-style-type: none"> • Press to navigate to the left. Press and hold to repeat. • In TAP, if a word completion is available, press to reject the completion.
	<ul style="list-style-type: none"> • Press to navigate to the right. Press and hold to repeat. • In TAP if a word completion is available, press to accept the word.
	Opens the Context Sensitive Menu if a context sensitive menu is active.

Writing in iTAP Alphanumeric

For example, let's write "David 232!".

1. In the text entry screen, select  > **Entry Setup**, and then change to **iTAP English**. Press **Back** to return to the text entry screen.
2. In the text entry screen, select  > **Entry Mode**, and then select **Primary**.
3. Press . The alternative row opens up and shows D E F 3. Continue entering the letters by pressing one key for each letter. The row shows the suggested words. Scroll the alternative row to the right until you reach David.
4. Press **Select** to select the word. It is displayed in the main text area.



Automatic shift to upper case is used at the beginning of a message, after punctuation followed by space, or for the first letter of a word created as a new Contact entry.

5. Enter the numbers by pressing one key for each letter. The row shows the suggested numbers. Scroll the alternative row to the right until you reach the required combination.
6. To enter the symbol, press . The row shows the suggested symbol. Scroll the alternative row to the right until you reach the required symbol. Press **Select** to select the numbers. The numbers and symbol are displayed in the main text area.

Word Locking



You can use the partial or full word-lock feature to add words that are not in the dictionary and/or to narrow down the list of alternates to those that begin with a particular prefix.

1. Try to enter the word. Scroll the alternate line for a word option. Each option is successively highlighted and partially locked.
2. Enter the second part of the word. The first part remains unchanged (locked). The newly entered letters will be highlighted and then locked while you scroll to the next word option.
3. Press . The word is placed in the text area with a space and automatically added to the dictionary.

Writing in Numeric Mode



1. Press  to scroll to numeric mode. (OR, press and hold any numeric key to enter Numeric mode.)
2. Press the relevant numeric keys to insert the digits.

Writing in Symbol Mode

1. Press  to scroll to symbol mode.
2. Press . A series of symbols and punctuations appear on the screen.
3. Scroll to the symbol and press Select.

Writing in TAP Alphanumeric

1. In the text entry screen, select  > **Entry Setup**, and then change to TAP and its related language. Press **Back** to return to the text entry screen.

2. In the text entry screen, select  >**Entry Mode**, and then select **Primary**.
3. Press the key labelled with the desired character, once for the first character, twice for the second, and so on. For example, to enter “s”, press key  four times. To enter “7”, press the key five times. If you do not press a key for a few seconds, the character is accepted, and the cursor moves to the next position.

Adding Words to the Dictionary

Each language comes with its own dictionary. You can create words (including alphanumeric abbreviations). Once you create these words and added a space, they will be automatically stored in the dictionary and will appear as choices whenever you press the same key combination in the future.

What to do if...

Your MTH800 flashes the following messages:

Messages	Message Description
...-Rcvd	Call received but not answered, or rejected
Invalid ID	The entered number is not valid.
Invalid Shortcut position	The entered number is not valid.
List Empty	There are no programmed entries in the scrolling list. Type the entry.
Attachment Failed	The MTH800 could not perform talkgroup attachment. The MTH800 keeps on trying. If it does not succeed, try another talkgroup.
Authenticate Failure	The MTH800 could not register on an Authenticated system (for example, the Authentication key is incorrect, or Authentication is disabled in the MTH800).
Battery Flat	The battery is uncharged. Recharge the battery.
Call Canceled	Called MTH800 cancelled the call.
Call Ended	<ul style="list-style-type: none">• Faulty channel. Please try later.• Called MTH800 ended the call.
Call Preempted	Channel being used for priority.
Emgcy In Use: Wait For Mic	The Hot Microphone feature is active, but the channel transmit grant has been given to another Emergency Call on the same talkgroup. The MTH800 microphone is not active during this time, but the MTH800 will automatically try to regain talk permit after a predetermined time.
Emgcy Mic Ended	The Hot Microphone timer has automatically expired, or the user has pressed the PTT button to cancel the Hot Microphone feature.
Emgcy Mic On	The Hot Microphone feature is active, and the MTH800 is automatically transmitting hands free emergency audio.
Empty Entry	The speed number you dialed does not exist, or the number exists but the group is non-selectable.











Messages	Message Description
Faulty Unit Error...	Self-test failed. An operational fault has been detected with your MTH800. Record the error number. Turn your MTH800 off and contact service.
Group already exists	The group you are attempting to add already exists in the My Groups folder.
No Group	Attachment failed. MTH800 detached from current talkgroup. Please wait until the MTH800 attaches again to the current talkgroup.
Insufficient Visible Satellites	Your terminal is in the process of determining your location. This may take several minutes to complete.
Insufficient Visible Data	Your terminal is in the process of determining your location. This may take several minutes to complete.
Limited Service	Emergency Calls, Emergency Alarms and mobility operations (e.g.: group attachment) are allowed. All other incoming and outgoing call and data services are blocked.
List not Attached	All talkgroups in the scan list are not attached.
List Partially Attached	The scan list is active, but not all talkgroups are attached to it.
Low Battery	You have less than five minutes of talk time.
Message Delivered	Indicates mail successfully delivered.
Message Failed	Indicates mail delivery failure.
 Mode No Service	The MTH800 is outside coverage. Return to coverage.
My Groups is empty	You cannot view/delete groups when the My Groups folder is empty.
My Groups is full	You are not allowed to add a group to the My Groups folder as it already contains the maximum allowed number of groups.
Network Trouble	Network problems. Please try again later.

Messages	Message Description
No Answer	The called party does not answer.
No Entries	This message is displayed when accessing an empty list.
No Group	<ul style="list-style-type: none"> • Displayed when you are out of the normal coverage area of your selected talkgroup. Please select a new talkgroup that is valid for your working location. • Indicates a favourite group was removed from the My Groups folder.
No List	The Network List is empty.
No New or Old Messages	Indicates there are no new or old messages in the Inbox.
No Selected Scan List	You selected an empty Network List (No List).
No Service	The MTH800 is out of coverage.
Not Allowed To Transmit	Release PTT and try again later.
Only One Entry	There is only one programmed entry in the scrolling list.
Overcharging	The MTH800 turns off. Remove MTH800 from charger.
Overheating	The MTH800 turns off. Keep it turned off for five minutes.
Party Busy	The called MTH800 is busy.
Party Not Available	<ul style="list-style-type: none"> • The called MTH800 is out-of-range. Please try again later. • The called MTH800 is turned off. Please try again later.
Please Try Again	The MTH800 could not place the call.
Please Wait Connecting	A message during startup.
Registration Failure	The MTH800 could not register within the system. Please try again later.
Service Denied	Invalid number. Call your Service Provider.











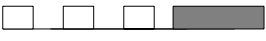

Messages	Message Description
Service Not Available	This service is not available on the current network.
Service Restricted	This service has been restricted by your Service Provider or it has not been purchased.
Talkgroup ...Added	Group name added to the favourite talkgroup folder.
TG ... cannot be deleted	You cannot delete this group from the favourite talkgroup folder. Your Service Provider has set this group to non-deletable.
Speaker/ Earpiece Volume bars	Use Rotary knob to adjust volume level. (Rotary knob is programmed to "Dual" or "Volume").
Try Again Later	The requested service is temporarily unavailable.
Unit Disabled	Check with Service Provider.
Unit is OK Warn...	Self-test error. A minor fault has been detected with your MTH800. The MTH800 is still fully operative. Should this error recur, note the error code and contact service.
Unit Not Attached	The MTH800 could not attach to the system. The talkgroup may not be defined in the system. Please try another group.

Tones

□ = High Tone; ■ = Low Tone;

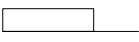
Description	Type	Repeated
Idle		
<ul style="list-style-type: none"> • Back to Home display • Back to Rotary volume use when Rotary scroll timer expires • Back to coverage • Back to full service 		Once
Clear to send		Once
<ul style="list-style-type: none"> • Bad key press 		Once
<ul style="list-style-type: none"> • Good key press • MTH800 self-test fails at power up • From out-of-service to in-service 		Once
In Call		
<ul style="list-style-type: none"> • Call clear warning • Call modified 		Once
Call waiting tone while Phone or Private Call are pending		Every 6 seconds, until a call is terminated.
Data Connected or Data Disconnected.		Once
Talk Permit sounds upon pressing the PTT.		Once (Normal Tone)
		Once (Short Tone)
Talk Permit without gateway sounds upon pressing PTT. The tone indicates the gateway is no longer available.		Twice
		Once

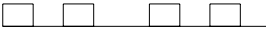
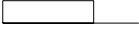
Description	Type	Repeated
<ul style="list-style-type: none"> Talk Prohibit System busy Time-out timer expire Called MTH800 not available or busy. 		Until you release the PTT
<ul style="list-style-type: none"> Call disconnected or failed due to network Wrong number dialed. 		Once
DMO Entering		Once
DMO Exiting		
Local site trunking — Entering/Exiting		Once
Phone ring back (sending)		Every three seconds, until the called user answers or call is rejected.
Phone busy		Every 0.5 seconds
Status message sent to the dispatcher or failed.		Twice
Incoming Calls		
Status message acknowledged by the dispatcher.		Four times
Your MTH800 received a Group Call without gateway. (setup only)		Once
High Priority Group Call received		Once
Emergency Alarm sent or received		Twice
Emergency Alarm failed		Four times
Emergency Call received		Once

Description	Type	Repeated
Phone ring (reception) Full-duplex Private Call		Until you answer or the call is rejected.
Private Call received		Until the call is answered
Private Call ringing to the caller		Until the call is answered
Half-duplex Private Pre-emptive Preemptive Priority Call (PPC) ring.		Every 4 seconds until the call is answered or rejected.
Full-duplex Private PPC ring.		Every 4 seconds until the call is answered or rejected.
Limited Service		Once upon entering limited service
New Mail Received		Once
New Group Call		Once
General		
Volume setting (earpiece, keypad, speaker)		Continuous
Volume setting (Ringer)		While setting the volume
Transmit Inhibit (TXI)		Once
Rotary knob tone		Once, when toggling from List to Volume.
Low battery alert		Repeated
DTMF (0-9, #, *) during the call	DTMF 	Continuous, until the user releases the key
GPS		
GPS in coverage		Once

Description	Type	Repeated
GPS out of coverage		Once

Appendix A. Accessories

Use only Motorola approved antennas and batteries. Use of non-Motorola approved antennas, batteries, accessories, and applications may result in non-compliance with RF exposure guidelines and regulatory requirements.

The table below lists the Motorola approved accessories.

Kit Number	Description
Batteries	
SNN5705	Standard battery, 800 mAh, Lilon (without battery door)
NNTN4655	Extended battery, 1500 mAh, Lilon (without extended battery door)
0102709K08	1500 mAh battery door
0102709K05	800 mAh battery door
Chargers	
NNTN4250	Travel charger (power supply only)
WALN4092	Rapid travel charger kit including UK and Euro plugs (contains NNTN4250 +SYN7456 +SYN7455)
FTN6306	Dual pocket desktop charger base (requires travel charger WALN4092)
FTN6351	Insert for dual pocket desk top charger
SYN7456	Plug adapter EU for travel charger NNTN4250
SYN7455	Plug adapter UK for travel charger NNTN4250
WPLN4175	Multi-unit Charger 6 pockets with Euro cord
WPLN4176	Multi-unit Charger 6 pockets with UK plug
WPLN4177	Multi-unit Charger 6 pockets with US Plug
RLN5643	Wall mount bracket for multi-unit charger
Vehicular Adapter	
FLN9469	Vehicle power adaptor
FTN6307	Hands-free Digital Car Kit (including cradle, junction box, remote speaker, mic, and PTT)
Audio Accessories	
FTN6388	Rx Only Earpiece for terminal (short cable)
NNTN4033	Personal Hands Free (PHF) kit with PTT
FTN6304	Mini lapel microphone kit (3 Wire kit, long cable, compatible with earshells and voicetubes)
GMLN1081	Audio jack adapter for kits NNTN4033 and FTN6304 (kit contains 10 pieces)

Kit Number	Description
WADN4223	Earshell - large
WADN4224	Earshell - small
NTN8370	Acoustic Voicetube with foam plug for extreme noise environments
NTN8371	Acoustic Voicetube with rubber ear tips for low noise environments
RMN5042	Remote Speaker Microphone
RLN4939	Rx Only for Remote Speaker Microphone
GMMN1105	Audio Bundle Kit (contains FTN6388, WADN4224, WAD4223, NTN8370, NTN8371 and black nylon bag)
Carrying Accessories	
RLN4892	Hard leather case with swivel 2.5" belt loop
RLN4891	Soft leather carry case with swivel 2.5" belt loop
HLN9767	Wrist strap
FTN6355	Shoulder wearing device with stud
FTN6302	Bracket with U-slot (for use with belt clip)
HLN9714	Belt clip (long - 2.5"). For use with above bracket with U slot
HLN9844	Belt clip (short - 1.5"). For use with above bracket with U slot
Antennas	
8586381J11	Whip wideband antenna 380-430 MHz combined GPS & TETRA
8586381J10	Helical wideband antenna 380-430 MHz combined GPS & TETRA
Data	
FKN4897	RS-232 Data cable
FLN9636	Programming cable
NNTN4007	USB Cable

Index

A

- Accessory connector 10
- adjusting volume 19
- AL (Ambience Listening) 54
- alias 21
- alphanumeric key
 - entering text (letters and digits) 10
- Ambience Listening (AL) 28, 54
- announcement talkgroup 33
- antenna attaching/detaching 8
- ATG 33
- audio
 - high/low 21, 84
- Audio Accessory connector 10

B

- Backlight Adjustment, one-touch 20
- backlight setup 85, 89
- battery charging 5, 11
- bottom microphone 10, 13, 14
 - mute/unmute 30
- Broadcast Call 28
- buttons
 - Emergency 19
 - Push-To-Talk (PTT) 11

C

- Call Dial, one-touch 20
- calls
 - full-duplex 13
 - half-duplex 13
- cleaning your unit 14
- code changing 78
- connectors
 - Accessory 10
 - Audio Accessory 10
 - External Antenna 10
- contact list 74
- Contacts sub-menu 74
- contrast setup 90

D

- data setup 83
- DGNA (Dynamic Group Number Assignment) 40
- dialed call history 96
- dialed number list 96
- dictionary 123
- direct setup 25
- display
 - contrast setup 90
 - Home 15
 - language setup 83
 - TAP/iTAP 116
 - text size setup 88
 - vertical flip setup 87
 - wallpaper setup 89
- displaying long text messages 105
- DMO 23, 42
- DMO Group Call
 - making 43
 - receiving 45
- DMO/TMO, one-touch 20
- DTMF over dial 53
- Dynamic Group Number Assignment (DGNA) 40

E

- Emergency 60
- Emergency Alarm
 - sending in TMO 56
- Emergency button 19
- Emergency Group Call 54
 - making in DMO 60
 - making in TMO 57
 - receiving in DMO 60
 - receiving in TMO 58
- Emergency Private Call 55
- encryption 79
- End-Stop Rotary Knob Scrolling 36
- External Antenna connector 10

F

- favourite group 32, 94
- Flip Display, vertical via one-touch 20
- folder 32
 - favourite group 32, 42
 - scroll to next 35
 - selection 32, 43
 - stay in 36
- forced call 39
- Four-Way Navigation key 10
- full-duplex call 13

G

- gateway 43
- GPS enable/disable 63
- GPS location Service 61
- Group Audio setup 84
- Group setup 90

H

- half-duplex call 13
- high/low audio 13, 21, 84
- history
 - dialed call 96
 - missed call 96
 - received call 96
- Home display 15
- Home Revert, one-touch 20
- hook setup 25
- Hot Microphone feature 57

I

- icons
 - contacts 74
 - Direct Mode Operation 15
 - general 16
 - GPS 63
 - Inbox 107
 - menu 70
 - status 15
 - TAP/iTAP 115
- Inbox use 107
- InterMNI call 42, 59

iTAP

- display 116
- icons 115
- selecting 114
- writing text 114, 121

K

- K Validity 80
- keypad 10
 - locking/unlocking 79
 - usage in alphanumeric mode 117
 - usage in numeric mode 118
 - usage in symbol mode 118

keys

- Four-Way Navigation 10
- Menu 17
- On-Off/End/Home 11
- programmable numeric 20
- programmable Side 19
- Send 10
- soft 17
- Speaker Control 21, 85

knob

- End-Stop Rotary Knob Scrolling 36
- Rotary 18

L

- list of menu items 71
- Local Area Service 30
 - entering 30
 - exiting 31
- Local Site Trunking 30
- locking/unlocking the keypad 79
- low/high audio 13, 21, 84

M

- menu 17
- menu item 69
- menu item list 71
- Messages sub-menu 74, 104
- microphones
 - bottom 10, 13, 14
 - bottom, mute/unmute 30
 - top 9, 13, 14
- missed call history 96

More... sub-menu 90
mute/unmute bottom microphone 30
My Info sub-menu 96

N

Network List 92
Networks sub-menu 101
notations 3
numeric key, programmable 20

O

one-touch
 Backlight Adjustment 20
 Call Dial 20
 DMO/TMO 20
 Home Revert 20
 Screen Saver 20
 Status Message 20
 Talkgroup Scan 20
 Talkgroup Switch 20
 Text Message Template 20
 TMO/DMO 20
 Transmit Inhibit (TXI) 20
 Vertical Flip Display 20
On-Off/End/Home key 11
open group 42, 59

P

PABX (Private Automatic Branch Exchange) 51
PABX Call 51
Phone Call 51
 one-touch dialing 52
 speed dial 52
phone number 21, 51
 viewing and modifying 96
Phone/PABX Call
 answering 53
 dialing via contact list 52
 direct dial 51
 making 51
PIN Protect 77
powering on/off 11

PPC

making a Private PPC 49
receiving a Private PPC during a call 27
 receiving an Emergency Group Call during a call 27
PPC (preemptive priority call) 26
Predefined Template 110
preemptive priority call (PPC) 26
presented call 39
Private Automatic Branch Exchange (PABX) 51
Private Call 47
 dialing via contact list 48
 direct dial 47
 making 47
 receiving 49
 Short Number Dial 48
private number 21
 viewing 96
programmable numeric key 20
programmable Side keys 19
PUK 78
Push-To-Talk button (PTT) 11

R

received call history 96
receiving calls 25
Recent Calls sub-menu 96
ring style of incoming call 82
Rotary knob 18
 End-StopRotary Knob Scrolling 36

S

scan list 32
scan on/off in TMO Group Call 38
Scan setup 90
scanning selection 32
SCK Validity 81
screen saver 22
screen saver setup 88
screen saver text 88
Screen Saver, one-touch 20
Scrolling
 End-Stop Rotary Knob 36

- Security sub-menu 77
- Send key 10
- Setup sub-menu 81
- Short Number Dial 48
- Shortcuts sub-menu 99
- Side keys, programmable 19
- Site Wide Trunking 30
- soft keys 17
- Speaker 10
- Speaker Control key 21, 85
- speakerphone 29
- status message 104
 - sending 112
 - targeting 112
- Status Message, one-touch 20
- T**
 - talkgroup 32
 - Talkgroup Scan, one-touch 20
 - talkgroup selection 32, 43
 - Talkgroup Switch, one-touch 20
 - TAP
 - display 116
 - icons 115
 - selecting 114
 - writing text 114
 - templates 104
 - text language 114
 - text message 104
 - receiving 105
 - sending 104
 - Text Message Template
 - one-touch 20
 - text size setup 88
 - TMO 23
 - TMO Group Call
 - making 36
 - receiving 37
 - TMO/DMO
 - one-touch 20
- tones
 - setting all tones 85
 - setting Clear to Send 86
 - setting keypad tone 85
 - setting talk permit tone 86
 - tones setup 85
 - top microphone 9, 13, 14
 - Transmit Inhibit (TXI) Mode 39
 - Transmit Inhibit (TXI), one-touch 20
 - TXI (Transmit Inhibit) Mode 39
- U**
 - unblocking the terminal 78
 - unlocking the terminal 77
 - unmute/mute bottom microphone 30
 - User Defined Template 110
- V**
 - Vertical Flip Display, one-touch 20
 - vibrate setup 81
- W**
 - wallpaper setup 89
 - writing text 114





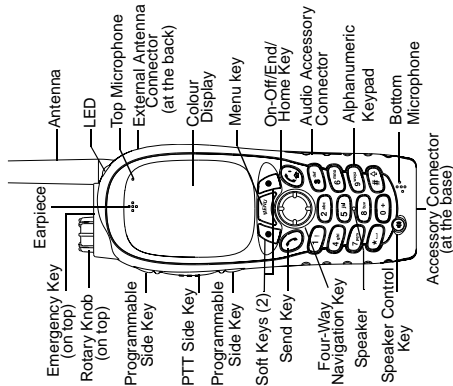

Quick Reference Guide



Turning the MTH800 On/Off

To power the MTH800 on/off, press and hold .

Using the MTH800 Menu System

- To enter the menu, press .
- To scroll through the menu, press .
- To select a menu item, press **Select** soft key or .
- To return to previous level, press **Back** or .
- To exit the menu items, press .

Selecting Trunked/Direct Mode Operation

- Your terminal may be configured with a One-touch button to switch between TMO/DMO. Contact your Service Provider for more information.
- From the Home display press **Opts.**, select **Trunked Mode/Direct Mode**.

Making a TMO Group Call

From the Home display navigate to the desired group. Press **Select** soft key (if configured). Press and hold **PTT**. Wait for the talk permit tone (if configured) and talk. Release **PTT** to listen.

Making a DMO Group Call

Enter DMO. Navigate to the desired group. Press **Select** soft key (if configured). Press and hold **PTT**. Wait for the talk permit tone (if configured) and talk. Release **PTT** to listen.



Making a TMO Emergency Group Call

Enter TMO. Press and hold the Emergency button. Emergency alarm is sent automatically. Press and hold **PTT**. Wait for the talk permit tone (if configured) and talk. Release **PTT** to listen. If using "Hot Mic" feature, wait for the **Emergency Mic On** message to appear on the display and talk without pressing **PTT**. To exit Emergency Mode, press and hold **Exit** soft key.

Making a DMO Emergency Group Call

Enter DMO. Press and hold the Emergency button. Press and hold **PTT**. Wait for the talk permit tone (if configured) and talk. Release **PTT** to listen. To exit Emergency Mode press and hold **Exit** soft key.



Making a Phone/PABX Call

From the Home display dial a number. Press **CType** to select the call type. Press  to speak and press  to terminate call.

Making a Half-duplex Private Call

From the Home display dial a number. Press **CType** to select the call type. Press and release **PTT**. Ringing sounds. Called party answers. Wait for the called party to finish speaking. Press and hold **PTT**. Wait for the talk permit tone (if configured) and talk. Release **PTT** to listen. Press  to terminate call.



Making a Full-duplex Private Call

From the Home display dial a number. Press **CType** to select the call type. Press and release . Ringing sounds. Called party answers. Press  to terminate call.



Answering a Call

Your MTH800 switches to the incoming call and alerts you of the incoming call. To answer the call, press  for Phone/PABX/Full-duplex Private calls or press **PTT** for all other calls.

Sending a Status Message

Select the desired group, then press  and select **Messages** > **Send Status**. Select status and press  or **PTT**.

Sending a New Message

Press  and select **Messages** > **New Message**. Write your message. Select **Send**, or press  or **PTT**. Select your mail recipient or enter number. Select **Send**, or press  or **PTT** to send the new message.

Tips & Tricks

Home Key



Not sure where you are? Want to get back to Home display? Press .

Backlight Control

You can either disable backlight (covered operation) or have it automatically turned on, by any key press.

You can also press the upper Side key - just to turn On/Off the backlight (if configured).

Menu Shortcuts

You can easily access any menu item, by pressing  and a numeric key. (No delay between  and the key!)

You can ask your Service Provider to program menu shortcuts.

You may also define a new shortcut: enter the menu item, press and hold , and follow the instructions in the display.

High/Low Audio Control

You can control audio routing (speaker/earpiece) for any Private or Group Call via the dedicated speaker control key. However, you can define via the menu to have all Group calls in high audio ( > **Setup** > **Group Audio**).

Unified Contact List

You can keep several numbers (Private, Mobile, Home, Work, PABX, Other) for the same person under the same contact name.

Text Size

You can see the text on the display in two sizes: **Normal** or **Zoomed** ( > **Setup** > **Display** > **Text Size**).

"My Groups" Folder

You can select any group (TMO or DMO) and add it to your personal folder. In the Home display, press  to quickly access your "My Groups" folder.