

SKANTI TRP 9250

250 Watt
Radio Transceiver
for MF/HF

Technical Manual



**SKANTI TRP 9250
250 Watt
Radio Transceiver
for MF / HF**

Technical Manual

Please note

Any responsibility or liability for loss or damage in connection with the use of this product and the accompanying documentation is disclaimed. The information in this manual is furnished for informational use only, is subject to change without notice, may contain errors or inaccuracies, and represents no commitment whatsoever. This agreement is governed by the laws of Denmark.

Doc. no.: 910 000 88

Issue: B9912

TABLE OF CONTENTS

1. INTRODUCTION

Table of Contents1-1
 General Description.....1-3
 Basic Versions1-4
 Technical Data1-6

2. OPERATION

Transceiver Control Unit Keys and Annunciators..2-3
 Symbol explanation.....2-7
 Operating instructions2-8
 Operation related 'Prog' key operations2-49
 Propagation of HF and MF Radiowaves2-55

3. INSTALLATION

Mounting The Units3-3
 Powersupply3-10
 Battery Charger3-12
 Earth Connections3-14
 Antennas3-15
 Recommended ATU Installation3-15
 Interconnection of Units3-16
 Connectors for External Equipment3-19
 Transceiver Control Unit connector panel3-19
 Transceiver Unit terminal strip panel3-23
 Final installation Check3-27
 Configuration Prom3-29
 Installation related 'Prog' key operations3-45
 Configuration3-49
 Installation Wiring Diagrams..... 3-69

4. TECHNICAL DESCRIPTION

Transceiver Control Unit 90004-3
 Transceiver Unit TU 92504-4
 Antenna Tuning Unit ATU 92504-8
 Block Diagrams4-9

5. SERVICE

Preventive Maintenance5-3
 Trouble Shooting5-7
 Power Protection5-8
 Service related 'Prog' key operations.....5-17
 Self Test5-25

6. DSC OPERATION

General6-2
 Operating instructions.....6-8
 Programming.....6-54
 Test6-68

7. DSC INSTALLATION

Description7-3
 Mounting the units7-3
 Figures and tables7-4
 Installation configuration7-18

1. INTRODUCTION Table of Contents

General Description	1-3
Basic Versions	1-4
Technical Data	1-6

GENERAL DESCRIPTION

The TRP 9250 is a general purpose HF SSB transceiver designed for maritime applications covering the frequency range 1.6 - 30 MHz. The standard version offers simplex and semiduplex radiotelephone communication in the maritime mobile bands and is intended for installation in voluntarily as well as compulsorily fitted vessels. With the optional built-in DSC and Radiotelex the TRP 9250 forms an integrated communication system ideal for simplified GMDSS installations. The TRP 9250 can be fitted in the SKANTI COMBRIDGE communication system for GMDSS.

The TRP9250 consists of a compact Transceiver Control Unit, a fully remote controlled Transceiver Unit and an automatic Antenna Tuning Unit. The Transceiver Control Unit, Transceiver Unit and Antenna Tuning Unit may be installed 100 m apart using standard screened cables.

One or two Control units are easily connected to the same transceiver unit increasing the flexibility of the installation.

The Transceiver Control Unit contains all receiver and transmitter operating controls. It is fully push-button controlled by means of a splash-proof keyboard with tactile and audible feedback. The LCD-display shows several information including receive and transmit frequencies, the mode of operation and time of day. Back-light with dimmer function is included for both LCD-display and keyboard to ease operation in any light condition. Mode, receive and transmit frequency set-ups can be stored and recalled directly from keyboard or used in conjunction with the 10 scan programs. Sweeping of a selected frequency range is also possible with the sweep function. Where required by authorities transmitter frequencies can be preprogrammed into a PROM allowing

transmission only on these frequencies. The compact Transceiver Control Unit is easily installed horizontally as well as vertically and with the optional rotatable wedge tilted to fit any installation.

The Transceiver Unit contains all receiver and transmitter circuitry and all connections for external equipment. The standard equipment has a built-in two-tone alarm generator and single key selection of 2182kHz. A squelch circuit, a low noise RF-amplifier and RF-attenuator are also included. The transceiver is fully synthesized and the receiver may be tuned in selectable steps of 1kHz, 100Hz and 10Hz.

The fully protected solid state 250W Power Amplifier, cooled by forced convection, matches a 50 ohms antenna system, but is normally used in connection with the Antenna Tuning Unit.

In the standard version, the transmitter covers the marine bands between 1.6 to 30MHz, but an optional PA-filter is available which gives continuous coverage of the frequency range 1.6 to 30MHz.

The microprocessor controlled Antenna Tuning Unit tunes automatically to all antennas between 7 and 18 meters and requires no presetting at the installation. The typical tune time is less than 0.5s.

The TRP 9250 is designed for 24V DC operation. Mains operation is possible with the optional AC Power Supply Assembly installed in the Transceiver Unit. A Battery Charger Extension enables the AC Power Supply Assembly to be used as a battery charger.

The built-in test facilities and easy-to-replace module design of the TRP 9250 simplifies the service concept.

BASIC VERSIONS**TRP 9250 Marine HF-SSB Radio System**

- 250 Watt P.E.P. Power Amplifier.
- Simplex / Semi-duplex operation.
- 896 Pre-Programmable Frequencies in the ITU Marine Bands. Free RX Frequency.
- ITU Frequencies Pre-Programmed.
- Labelling of Units. Transceiver Control Unit Type TCU 9000 S, Transceiver Unit Type TU 9250 S, Antenna Tuning Unit Type ATU 9250.

TRP 9251 Marine HF-SSB Radio System

- 250 Watt P.E.P. Power Amplifier.
- Simplex / Semi-duplex operation.
- Free TX frequency selection in the ITU Marine Bands. Free RX Frequency.
- ITU Frequencies Pre-Programmed.
- Labelling of Units. Transceiver Control Unit Type TCU 9000 S, Transceiver Unit Type TU 9251 S, Antenna Tuning Unit Type ATU 9250.

TRP 9252 Marine HF-SSB Radio System with CW facility

- 250 Watt P.E.P. Power Amplifier.
- Simplex / Semi-duplex operation.
- CW operation
- Free TX frequency selection in the ITU Marine Bands. Free RX Frequency.
- ITU Frequencies Pre-Programmed.
- Labelling of Units. Transceiver Control Unit Type TCU 9002 S, Transceiver Unit Type TU 9252 S, Antenna Tuning Unit Type ATU 9250.

TRP 9253 Marine HF-SSB Radio System

- 250 Watt P.E.P. Power Amplifier.
- Simplex / Semi-duplex Operation.
- Free TX Frequency Selection 1.6 - 30MHz. Free RX Frequency.
- ITU Frequencies Pre-Programmed.
- Labelling of Units. Transceiver Control Unit Type TCU 9000 S, Transceiver Unit Type TU 9253 S, Antenna Tuning Unit Type ATU 9250.

TRP 9254 General Purpose HF-SSB Radio System

- 250 Watt P.E.P. Power Amplifier.
- Simplex / Semi-duplex operation.
- Free TX Frequency Selection 1.6 - 30MHz. Free RX Frequency.
- Labelling of Units. Transceiver Control Unit Type TCU 9004 S, Transceiver Unit Type TU 9254 S, Antenna Tuning Unit Type ATU 9250.

TRP 9255 General Purpose HF SSB-Radio System with CW facility

- 250 Watt P.E.P. Power Amplifier.
- Simplex / Semi-duplex operation.
- CW operation
- Free TX Frequency Selection 1.6 - 30MHz. Free RX Frequency.
- Labelling of Units. Transceiver Control Unit Type TCU 9005 S, Transceiver Unit Type TU 9255 S, Antenna Tuning Unit Type ATU 9250.

TRP 9257 Marine HF-SSB Radio System with CW facility

- 250 Watt P.E.P. Power Amplifier.
- Simplex / Semi-duplex Operation.
- CW operation
- Free TX Frequency Selection 1.6 - 30MHz. Free RX Frequency.
- ITU Frequencies Pre-Programmed.
- Labelling of Units. Transceiver Control Unit Type TCU 9002 S, Transceiver Unit Type TU 9257 S, Antenna Tuning Unit Type ATU 9250.

TECHNICAL DATA**GENERAL**

Complies with the relevant IMO performance standards, the ITU Radio Regulations, the relevant ITU-R recommendations and meets the performance specifications of ETSI and CEPT. Complies with the relevant CE-marking standards.

Frequency Range:

1.6 - 30 MHz

Frequency Generation:

True digital frequency synthesis.

Frequency Selection:

Direct by the keyboard.

Up to 896 single pre-programmed frequencies with direct recall of the first 200.

All relevant ITU frequencies.

GMDSS Safety and Distress frequencies.

100 user-programmable channels (RX/TX frequency pair).

Single key selection of 2182 kHz

Scanning facility

Sweep facility

Frequency Presentation:

Backlit LCD display with simultaneous presentation of receive and transmit frequencies.

Frequency Stability:

0.35 ppm

0.1 ppm (optional)

Aging: Less than 1 ppm/year

Operating Modes:

Simplex and semiduplex

SSB: Upper sideband suppressed carrier (J3E, USB). Same as USB.

LSB: Lower sideband suppressed carrier (J3E, LSB).

R3E: Upper sideband reduced carrier (R3E).

AM: Reception/Transmission: Compatible AM single sideband full carrier (H3E).

Reception: Double sideband full carrier (A3E).

TLX: Reception/Transmission: Single sideband suppressed carrier with modulating sub-carrier (J2B).

Sub-carrier user-programmable from 1500 Hz to 2950 Hz, default 1700 Hz.

Reception: Frequency shift keyed carrier (F1B).

CW: Morse telegraphy keyed carrier(A1A)

Displayed Frequency:

Operating modes SSB (USB), LSB, R3E, AM: Carrier Frequency.

Operating mode TLX: Upconverted sub-carrier frequency

Operating mode CW: Carrier frequency

Other Facilities:

Real time clock

User-programmable Sleep Timer with up to 10 setups

Built-in selftest programme

Continuously operating Power and Protection Monitor.

Supply Voltage:

24V DC

With optional built-in AC Power Supply: 115/230 V AC (internal switch). Automatic changeover to DC in the absence of AC supply.

Operating Temperature Range:

-20 deg. C to +55 deg. C

Compass Safe Distance:

Refer to table at page 1-10

RECEIVER CHARACTERISTICS**Frequency Range:**

100 kHz to 30 MHz (10 kHz to 150 kHz with reduced performance).

Frequency Resolution:

100 Hz by keyboard entry. 10 Hz, 100 Hz or 1 kHz with the search/fine tuning facility.

Antenna Impedance:

50 ohm. Automatically matched by the Antenna Tuning Unit.

Input Protection:

30 V RMS (EMF) for up to 15 min.

IF Selectivity:

SSB: 350 Hz to 2.7 kHz

AM: +/- 3 kHz

TLX: +/- 150 Hz (optional)

CW: +/- 150 Hz, +/- 1.20 kHz and +/- 3.00 kHz
(relevant versions only)

Sensitivity:

Antenna input for 10 dB SINAD, 50 ohm antenna.

SSB: 0.6 μ V

AM: 4 μ V

TLX: 0.25 μ V

CW: 0.25 μ V with +/- 150 Hz bandwidth

When HiSens is selected, the sensitivity is increased by approx. 5 dB.

Out-of-band Intermodulation:

Two 93 dB μ V signals more than 30 kHz off tune produces less output than an equivalent input signal of 30 dB μ V.

In-band Intermodulation:

Less than -40 dB.

Cross Modulation:

Unwanted signal of 105 dB μ V/30%-400Hz more than 20 kHz offset from receiver frequency, produces cross modulation less than -30dB relative to wanted signal of 60 dB μ V/SSB.

Blocking:

With a wanted signal of 60 dB μ V, an unwanted signal 20 kHz off tune 110 dB μ V will affect the output level by less than 3 dB or cause a reduction in SINAD of less than 6 dB (SSB).

Reciprocal Mixing:

With a wanted signal giving 20 dB SINAD, an unwanted signal 20 kHz off tune and 80 dB above the wanted signal level will cause less than 6 dB reduction in SINAD (SSB).

Image Rejection:

Greater than 80 dB.

IF Rejection:

Greater than 80 dB.

Spurious Response Rejection:

Greater than 80 dB.

Internally Generated Spurious Signals:

Less than 5 dB SINAD (SSB).

Spurious Emission:

Less than 20 pW/50 ohm at antenna connector

RF-Amplifier:

HiSens selected: Gain 12 dB

HiSens not selected: Gain 0 dB

RF-Attenuator:

Att selected: Attenuation 20 dB

Att not selected: Attenuation 0 dB

Squelch:

Voice controlled squelch.

Line Output :

-10 dBm to +10 dBm, 600 ohm.

Audio Output Power:

Internal speaker: 6 W with less than 10% distortion.

External speaker: 6 W in 8 ohm with less than 10% distortion.

TRANSMITTER CHARACTERISTICS**Output Power:**

250 W PEP into 50 ohm, voice, DSC or ARQ telex,

150 W PEP into 50 ohm, FEC telex,
AC supply or min. 26 V DC.

Single Tone max. Power:

250 W CW into 50 ohm for a duty cycle less than 55% and a modulation rate greater than 3 baud.

Reduction to 100 W when continuously keyed during 1 min. Automatic full power recovery after 1 min.

Power Reduction:

Medium: 100 W, 60 W or 20 W (user-programmable, default 60 W)

Low: approx. 10 W

Frequency Range

Continuous coverage:
1.605 MHz - 30 MHz

ITU Marine Bands:

2MHz = 1.605 - 4.000 MHz

4MHz = 4.000 - 4.438 MHz

6MHz = 6.200 - 6.525 MHz

8MHz = 8.100 - 8.815 MHz

12MHz = 12.230 - 13.200 MHz

16MHz = 16.360 - 17.410 MHz

18MHz = 18.780 - 18.900 MHz

19MHz = 19.680 - 19.800 MHz

22MHz = 22.000 - 22.855 MHz

25MHz = 25.070 - 25.210 MHz

26MHz = 26.100 - 26.175 MHz

Frequency Resolution:

100 Hz step

Intermodulation:

Better than -31 dB PEP in standard two-tone test

Hum and Noise:

Less than -50 dB PEP (SSB)

Spurious Emissions:

Less than 43 dB/PEP, typical better than 60 dB/PEP

Suppression of Unwanted Sideband:

Greater than 60 dB/PEP (1 kHz, SSB)

Line Input:

-10 dBm to +10 dBm, 600 ohm

ANTENNA TUNING UNIT**Frequency Range:**

1.605 MHz - 30 MHz

Antenna Requirements:

7 - 18 m wire or whip antenna

Antenna Tuning:

Fully automatic with no presetting

Tuning Speed:

0.1 - 0.5 sec.

Input Impedance:

Nominal 50 ohm

Power Handling Capability:

250 W PEP

Output Power in Antenna:

AC supply or min. 26 V DC:
250 W PEP +/-1.4 dB in 50 ohm

21.6 V DC supply voltage:

85 W PEP +/-1.4 dB in 10 ohm, 250 pF below 4 MHz

150 W PEP +/-1.4 dB in 50 ohm above 4 MHz

REMOTE CONTROL**LINE, KEY TERMINALS****Line Input****Input Impedance:**

600 ohm, balanced with center tap
Galvanic isolated

Input Level:

-10 to +10 dBm

Line Output**Output Impedance:**

600 ohm, balanced with center tap
Galvanic isolated

Output Level:

0 dBm +/- 10 dB adjustable

COM AND PRN/RCI TERMINALS**Data Interface****Interface Type:**

RS-232-C

Interface Protocol:

T+Bus or NMEA 0183

Total System Delay in TLX mode

Ext key on to TX audio in: ≥ 5 ms

TX audio end to Ext key off: 0 ms

Ext key off to RX audio ready: typ. 9 ms

Scan Program Start/stop Input

Scan Start:

Programmable to negative or positive transition

Scan Stop

Programmable to negative or positive transition

Sweep Program Start/Stop Input

The scan start/stop input can alternatively be coupled to the sweep programme in the TRP 9250.

Sweep Start

Programmable to negative or positive transition

Sweep Stop

Programmable to negative or positive transition

POWER REQUIREMENTS

Supply Voltage:

DC: 21.6 V to 31.2 V

Output reduction below 26 V.

AC: 99-132 / 198-264 V, 50/60 Hz

Power Consumption (approx. @ 24 V DC):

RX only (TX off): 50 W

RX incl. DSC: 60 W

TX SSB unmodulated: 100 W

TX SSB 2 tones: 360 W

TX SSB 1 tone, CW: 500 W

TX FEC Telex: 360 W

TX ARQ Telex: 300 W

TX H3E unmodulated: 325 W

TX H3E Alarm: 360 W

BATTERY CHARGER EXTENSION

Charger type:

Automatic, with float charging. IE characteristic.

Nominal battery capacity:

40 - 200 Ah

Nominal charging time:

Max. 10 hours to 80% capacity (receive condition, 200 Ah battery).

Float charge voltage:

Adjustable 26.8 - 28.8 V to voltage specified by the battery manufacturer.

Main charge current:

Min. 20 A (receive condition)

Temperature compensation:

Optional external temperature sensors.

TS1: Float charge voltage compensation

TS2: High battery voltage alarm compensation

Battery Alarm output:

Make/break relay contacts.

Alarm in case of:

Battery voltage too low (<23.4)

Battery voltage too high (adjustable 27 - 32 V)

AC Mains Alarm output:

Make/break relay contacts.

External connections

Remote control (Off / Automatic), Battery alarm, AC alarm, Temperature sensors 1 and 2.

DIMENSIONS AND WEIGHTS

Transceiver Control Unit:

Width: 374 mm

Height: 213 mm

Depth: 124 mm

Weight: 3.4 kg

Transceiver Unit:

Width: 440 mm

Height: 660mm

Depth: 155 mm

Weight: 16 kg, approx.

Antenna Tuning Unit:

Width: 290 mm

Height: 504 mm

Depth: 80 mm

Weight: 3.3 kg, approx.

Compass safe distance:

Compass safe distance in accordance with ISO/R 694 are given below in metres.

Unit	Standard 5.4°/H	Steering 18°/H
TCU 9000	2.0	1.5
TU 9250	2.4	1.6
ATU 9250	1.0	0.6
DCU 9000	1.1	0.8
PC 9000	0.3	0.3
PRN 9000	0.9	0.5

All distances have been rounded up to the nearest 0.1 metres in order to allow for the maximum deviation which might be caused by the most offensive sample of all units manufactured

2. OPERATION Table of Contents

Transceiver Control Unit Keys and Annunciators	2-3	Simplex Frequency	2-25
TCU 9000 for versions TRP 9250, 9251 and 9253	2-3	Copy Rx Frequency	2-26
TCU 9002 for versions TRP 9252 and 9257.	2-4	Copy Tx Frequency	2-27
TCU 9004 for version TRP9254.	2-5	Store a Channel	2-28
TCU 9005 for version TRP 9255.	2-6	Recall A Channel	2-29
Symbol explanation	2-7	Change Mode	2-30
Operating instructions		Channel Scanning, Set Up	2-32
Power On	2-8	Channelscanning, Set Up Info	2-35
Distress Operation	2-9	Channel Scanning, Recall Program	2-38
Test of Alarm Generator	2-10	Channel Scanning,start/stop	2-39
Receiver Frequency	2-11	Frequency Sweeping, Setup	2-40
Audio Control	2-12	Frequency Sweeping, Set Up info	2-42
Receiver Tuning	2-13	Frequency Sweeping start/stop	2-43
Automatic Gain Control	2-15	Sleep Timer, Set Up	2-44
Difficult Receiver Conditions	2-17	Sleep Timer, Info	2-46
Adjust Bfo	2-18	Sleep Timer On	2-47
Change bandwidth	2-19	Operation related 'Prog' operations	2-49
Transmitter On/off	2-20	Propagation of HF and MF Radiowaves	2-55
Transmitter Frequency	2-21		
Power Level	2-22		
New Medium Power Level	2-23		
Tune the ATU	2-24		

TRANSCEIVER CONTROL UNIT KEYS AND ANNUNCIATORS

TCU 9000 for versions TRP 9250 S, 9251 S and 9253 S.

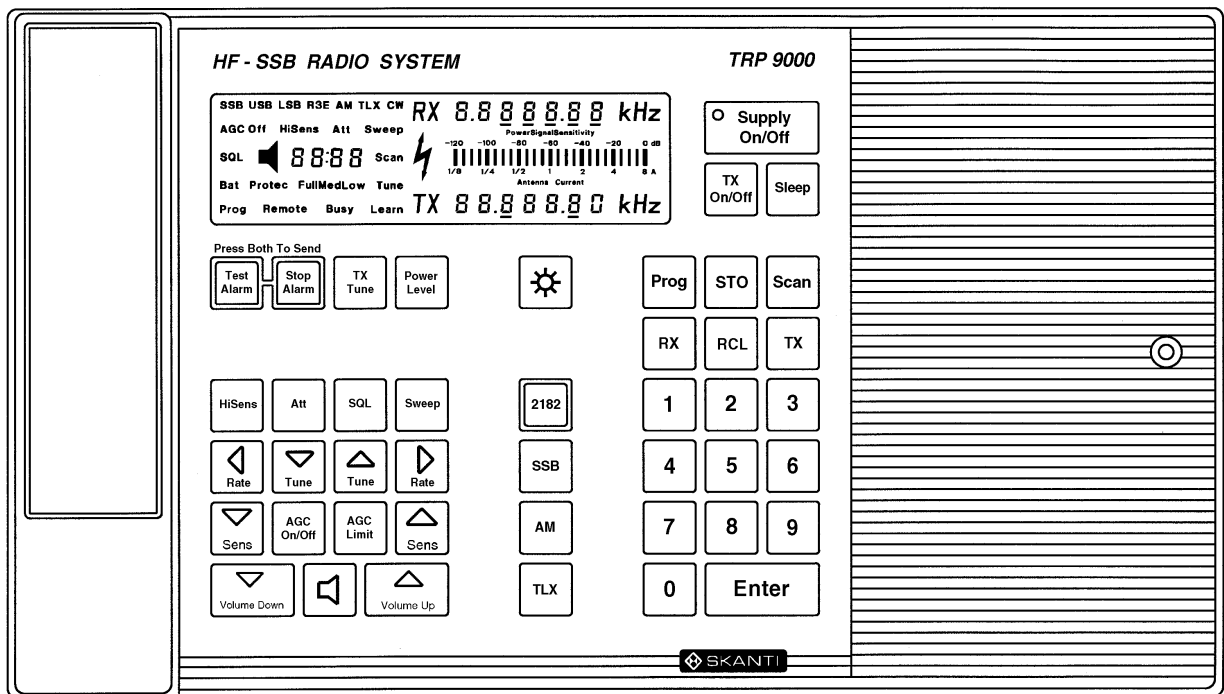

CONTROL UNIT KEYS AND ANNUNCIATORS

TCU 9002 for versions TRP 9252 S and 9257 S.

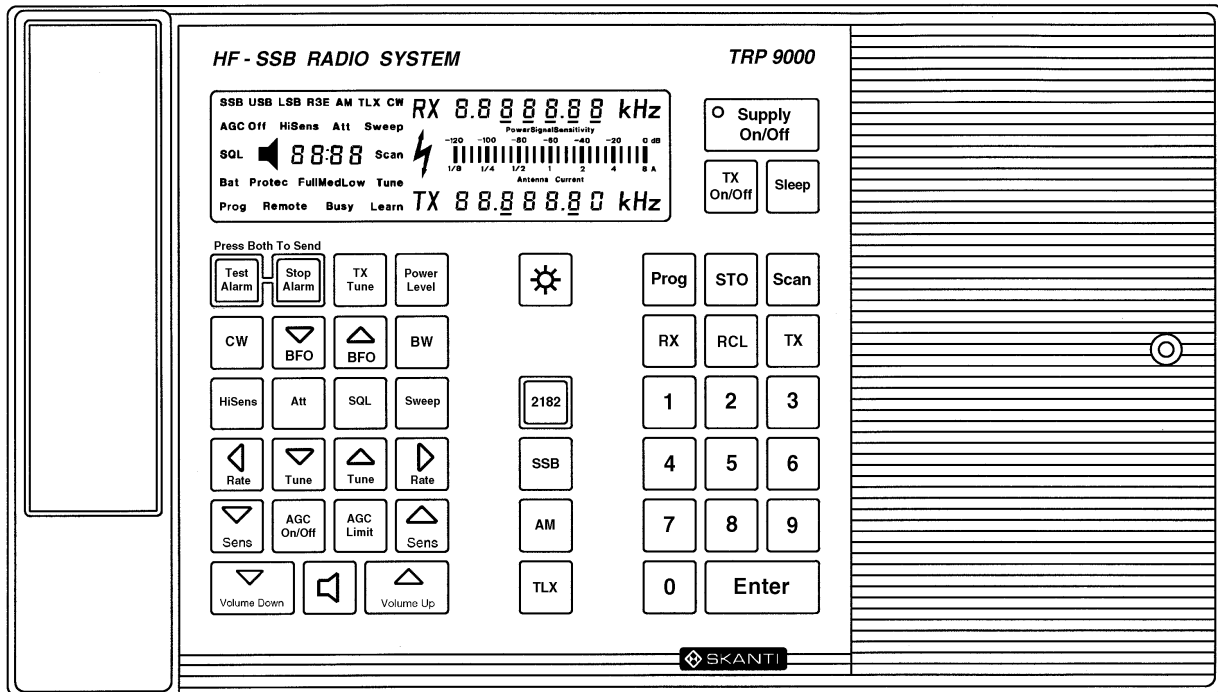

CONTROL UNIT KEYS AND ANNUNCIATORS

TCU 9004 for version TRP 9254 S.

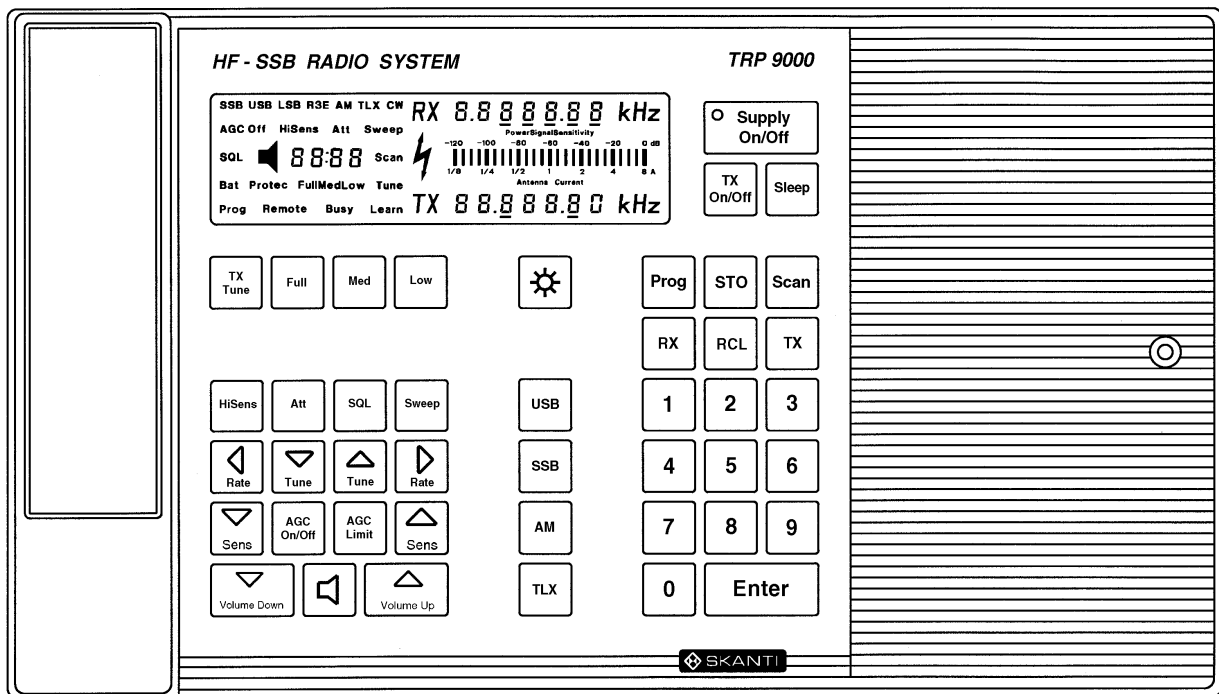

CONTROL UNIT KEYS AND ANNUNCIATORS

TCU 9005 for version TRP 9255 S.

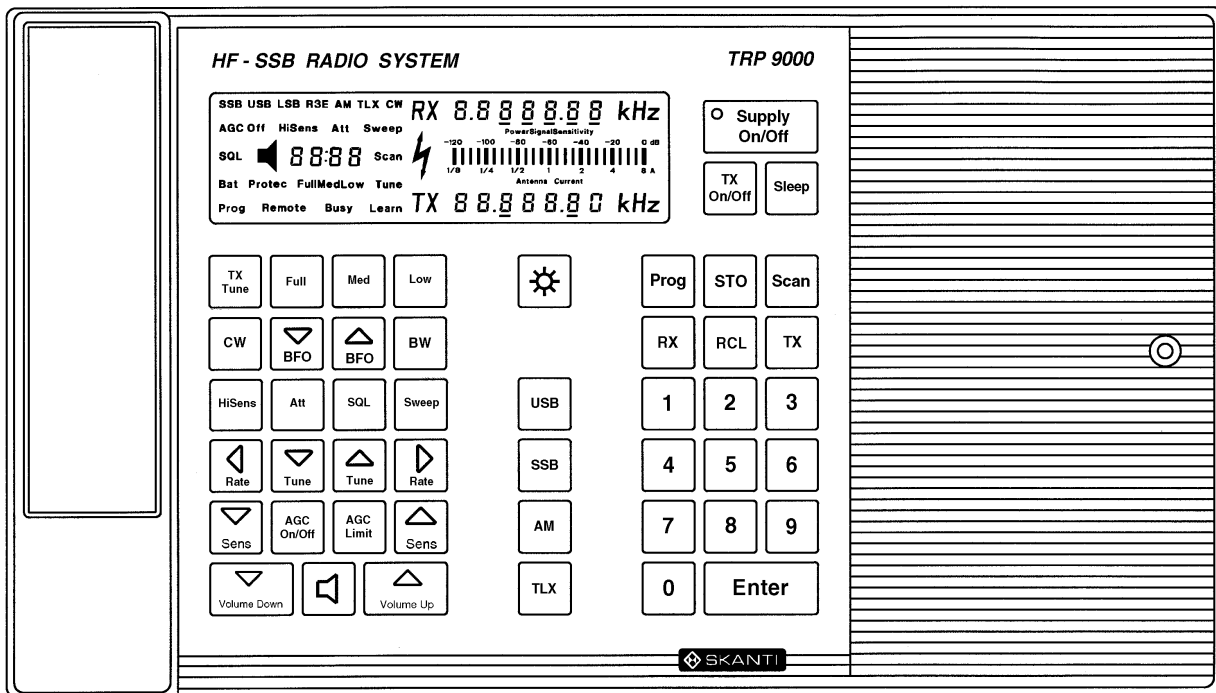

SYMBOL EXPLANATIONSymbolDescription**Keying sequence**

This symbol is printed on top of the description of the keys used to perform a given operation.

**Display guidance**

This symbol is printed on top of the pictures which will show you the annunciators that a given keying sequence will activate and in this way confirm to you that you have pressed the correct keys.

**Info**

This symbol is printed next to additional information on the operation described above it.

**Flashing annunciator**

When an annunciator (e.g. kHz) is printed in reverse it indicates that the annunciator is flashing in the Control Unit display.

POWER ON

Turning on the TRP 9250





1. Press  to turn on the TRP 9250.
The display will return the last set-up from when the transceiver was turned off.
2. Select the required illumination level for the Keyboard and Display.

The illumination has 4 different levels:

Press  to toggle the illumination level.



This example starts with no illumination.

Press  to switch to 'Day'. Maximum illumination of the display and no illumination of the keyboard..

Press  to switch to 'Twilight'. Full illumination of both display and keyboard.

Press  to switch to 'Dusk'. Medium illumination of both display and keyboard.

Press  to switch to 'Night'. Minimum illumination of both display and keyboard.

Press  to switch to no illumination, and turn on the  light.

DISTRESS OPERATION

Using the 2182 kHz Distress mode.



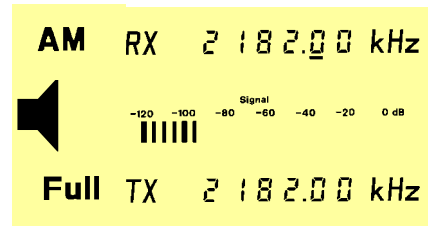

1. Press  to switch on the TRP 9250.

2. Press  to select the pre-set Distress mode.

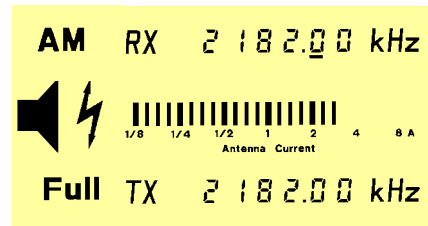

3. Press   simultaneously to transmit the Two-Tone Alarm Signal.



The Alarm Signal will continue for 45 seconds or until  is pressed.

4. Press the handset key and transmit your distress message.

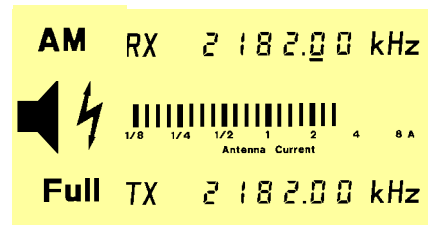

5. Release the handset key and wait for a reply.

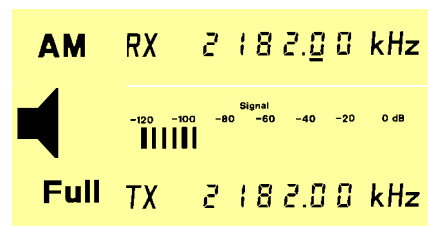

6. Repeat your distress message until a reply is received.

TEST OF ALARM GENERATOR

Without the Dummy load 741/742 installed



Keep  pressed on any transmitter frequency to test the audio part of the 2-tone Alarm Generator.

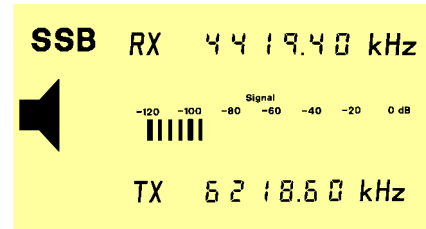

With the Dummy load 741/742 installed



Keep  pressed on any transmitter frequency in SSB mode (apart from 2182 kHz*). This will perform a complete test of the 2-tone Alarm Generator.

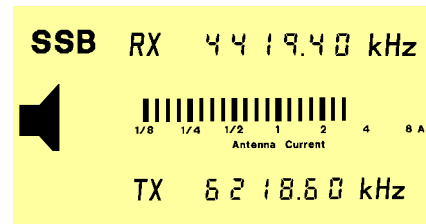

After the ATU tuning the bar-graph will display the RF current in the dummy load.



The  symbol is not displayed as no power is applied to the antenna.



* If the transmitter frequency is 2182 kHz, only the audio part of the 2-tone Alarm Generator is tested.

If TX Off is selected, only the audio part of the 2-tone Alarm Generator is tested.

In some countries it is permitted to test the 2-tone Alarm Generator into dummy load in AM mode on 2200 kHz.

RECEIVER FREQUENCY

Entering a receiver frequency



1. Press  to clear the receiver display.



2. Enter the receiver frequency that you wish to use.
e.g. **4419.4 kHz**.

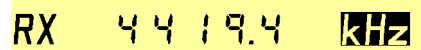

3. Press  to complete your frequency choice

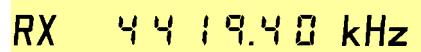

Receiver frequency range: 150 kHz to 30 MHz.

The receiver display will flash if an invalid frequency is entered .



AUDIO CONTROL

Operating Speaker, Volume and Squelch



1. Press  to switch the internal as well as the external Speaker on and off.
The Speaker annunciator will be displayed when the Speaker is on.

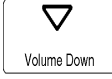

2. Press  or  to adjust the Speaker Level.
The Speaker annunciator will flash when minimum or maximum speaker level is reached.



3. Press  to turn the Squelch on and off.
The Squelch will switch on the audio in periods where a voice signal is received.
The Squelch annunciator will be displayed when the Squelch is on.

SQL

RECEIVER TUNING

Tuning the Receiver frequency.



1. Press or to select the Tune Rate. The display bar will indicate the selected rate. e.g. **1 kHz** rate.

RX 4143.62 kHz

2. Press or to tune the receiver to the required frequency. e.g. Tuning down **2 kHz** from **4143.62** to **4141.62 kHz**.

RX 4141.62 kHz

User-programmable Tune Rate

Press or and key in a Tune Rate in the range 0.01 kHz - 99.99 kHz. Press , to store the rate e.g. 3 kHz.





3.00 kHz





To select the user-programmable Tune Rate press or and the display bar is switched off to indicate that the user-programmable Tune Rate is used.

Press or to manually tune the receiver up or down in the programmed step.

Press or to return to a standard Tune Rate. The display bar will indicate which standard Tune Rate is selected.

Automatic Receiver Tuning

Press   or   to start automatic receiver tuning with the selected Tune Rate (standard- / or user-programmable- as indicated by the RX display bar).

While tuning, the Tune Rate may be changed by pressing ,  or  .

While tuning, the dwell-time (for how long the receiver stays on each receiver frequency) may be selected in the range 0.1 second - 1.0 second by pressing a numeric key. 1 corresponds to the shortest dwell-time (0.1 second) and 0 corresponds to the longest dwell-time (1.0 second).

Pressing  will stop Automatic Receiver Tuning.

Pressing  will stop Automatic Receiver Tuning and transfer current receiver frequency to the transmitter.

AUTOMATIC GAIN CONTROL

Adjusting the receiver gain.



1. For normal operation the AGC should be switched on.

2. **AGC on.**

The receiver sensitivity will automatically be adjusted to the received signal level.
The Signal strength of the received signal is displayed.
No further adjustment of the AGC is needed.

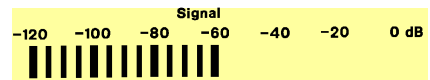



3. **AGC on / Minimum Signal Threshold.**

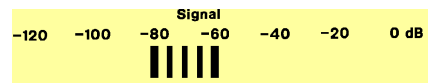

Press  to adjust the Minimum Signal Threshold.
Signals and noise below the selected Threshold will now be cut off.
Is usefull when noise keeps coming up in signal pauses.

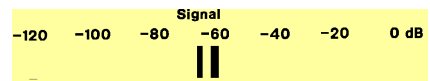

4. **AGC on / Automatic Minimum Signal Threshold.**

Press  and  to adjust the Minimum Signal Threshold automatically.



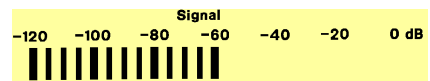

Press  and  to remove the Minimum Signal Threshold and return to normal AGC mode.



5. **AGC off**

Press  to turn the AGC off.

The Sensitivity is now adjusted to the same Signal strength level as when the AGC was on.

Press   to adjust the Sensitivity level.

Press  to switch AGC on again.

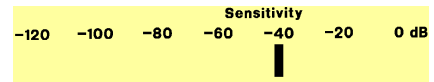
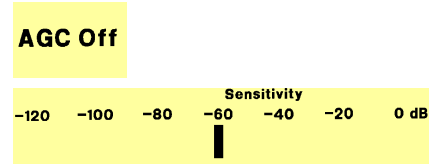

DIFFICULT RECEIVER CONDITIONS

Receiving signals under difficult conditions.





1. High Sensitivity

Press  to increase the Sensitivity by approx. 5dB. The HiSens annunciator is on when High Sensitivity is selected. The HiSens should be used if very weak signals are received.

HiSens

High Sensitivity is switched off by pressing  once more.

2. Antenna Attenuator

Press    to switch on and off the receiver Antenna Attenuator. The Att annunciator is on in the display when the Antenna Attenuator is switched on.

Att

The Antenna attenuator should be used when strong interfering signals are present at the receiver antenna input.





Strong interfering signals may distort the wanted signal by overloading the receiver input.

ADJUST BFO

For versions TRP 9255 and 9257 only.
Adjusting the BFO in CW mode .



1. Press  and  keys to adjust frequency of the received morse signal to the wanted pitch. When a BFO key is pressed the beat frequency is shortly shown in the receiver display.

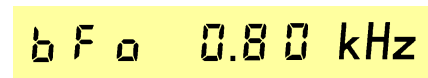

2. The display will flash when the minimum or maximum BFO frequency is reached.



The BFO keys can only be operated in CW mode.
The BFO frequency range is 0.3 kHz to 3.0 kHz.

CHANGE BANDWIDTH

For versions TRP 9255 and 9257 only.
Operating the Band Width key in CW mode.



1. Press 

b n d 0.30 kHz

2. Press 

b n d 2.40 kHz

3. Press 

b n d 6.00 kHz

The receiver bandwidth is stepped through the available bandwidths.

0.3 kHz - 2.4 kHz - 6.0 kHz - 0.3 kHz -

The actual receiver bandwidth is shown shortly in the receiver display.



The BW key can only be operated in CW mode.

TRANSMITTER ON/OFF

Turning the transmitter on or off.



1. Press  to turn the transmitter on.
The TX display will display the selected transmitter frequency.

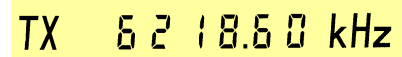

2. Press  to turn the transmitter off.
The TX display will be extinguished.



TRANSMITTER FREQUENCY

Selecting a transmitter frequency



1. Press  to clear the transmitter display

TX . kHz

2. Enter the transmitter frequency that you wish to use.
e.g. 4125 kHz.

TX 4 1 2 5 . 0 0 kHz

3. Press  to complete your frequency choice.

TX 4 1 2 5 . 0 0 kHz



Transmitter frequency range: Dependent of Transceiver version (See below).

The transmitter display will flash if an invalid frequency is entered. Pressing Enter will return to the previous selected TX frequency.

Transceiver Unit 9250: TX frequencies pre-programmed in the Configuration Prom. The corresponding mode will automatically be selected

Transceiver Unit 9251: TX frequencies in the Marine Bands (1.60 - 4.80 MHz, 6.20 - 8.95 MHz, 12.23 - 17.65 MHz, 18.78 - 27.10 MHz).

Transceiver Unit 9253, 9254, 9255, 9257: TX frequencies from 1.6 MHz to 30 MHz.

POWER LEVEL

Changing The Transmitter Power Level on versions TRP 9250, 9251, 9253 and 9257.



1. Press  to switch from Full to Medium power.

Med

2. Press  to switch from Medium to Low power.

Low

3. Press  to switch from Low back to Full power.

Full

Changing The Transmitter Power Level on versions TRP 9254 and 9255.

1. Press  for full output power.

Full

2. Press  for medium output power.

Med



3. Press  for low output power.

Low

NEW MEDIUM POWER LEVEL

Selecting a new level for Medium power on versions TRP 9250, 9251, 9253 and 9257.



1. Press   and the first option for Medium power will be displayed: **60 W**.



2. Press  and the second option for Medium power will be displayed: **100 W**.

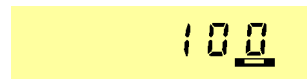



3. Press  and the third and last option for Medium power will be displayed: **20 W**.



4. When the required level for Medium power is displayed , press  to Store the new Medium power level.

Selecting a new level for Medium power on versions TRP 9254 and 9255.

Press the  key instead of the  key in the above described operation.

TUNE THE ATU

Tuning the Automatic Antenna Tuner .

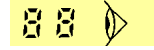

1. The Automatic Antenna Tuner will tune the antenna to the best possible transmission condition the first time that the handset key is pressed after a new transmit frequency has been selected.

The conditions might change during a transmission and a new tune up will be needed.
For example if ice is building up on the antenna or the vessel is heeling.

2. Press  to perform a new Tune procedure.



SIMPLEX FREQUENCY

Selecting the same frequency for both receiver and transmitter.



1. Press to clear both the receiver and the transmitter displays.



RX	.	kHz
TX	.	kHz

2. Enter the frequency that you wish to use for both receiving and transmitting. e.g. 2049 kHz

RX	2049.0	kHz
TX	2049.0	kHz

3. Press to complete your frequency choice.

RX	2049.00	kHz
TX	2049.00	kHz



COPY RX FREQUENCY

Copying the receiver frequency to the transmitter.



1. You start with different frequencies in the RX and the TX displays.

RX 4 1 4 3.6 0 kHz
TX 6 2 1 8.6 0 kHz

2. Press   to copy the receiver frequency. Prog and the RX Bar will flash in the display.

RX 4 1 4 3.6 0 kHz
Prog

3. Press  to transfer the RX frequency to the transmitter. The receiver frequency is now displayed in both the RX and the TX display.

RX 4 1 4 3.6 0 kHz
TX 4 1 4 3.6 0 kHz



COPY TX FREQUENCY

Copying the transmitter frequency to the receiver.

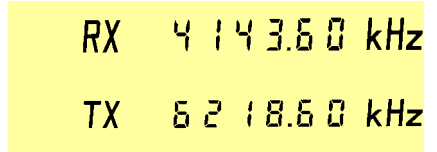

1. You start with different frequencies in the RX and the TX displays.



2. Press   to copy the transmitter frequency. Prog and the RX Bar will flash in the display.

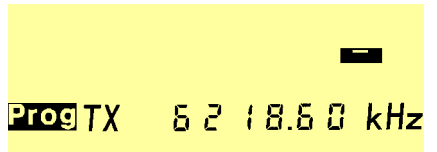

3. Press  to transfer the TX frequency to the receiver. The transmitter frequency is now displayed in both the RX and the TX display.

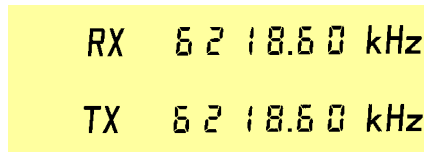

STORE A CHANNEL

Storing a channel in the User Programmable Memory



1. Enter the required Receiver and Transmitter frequencies as well as the operating mode.
e.g. RX 4143.6, TX 6218.6 and mode SSB.

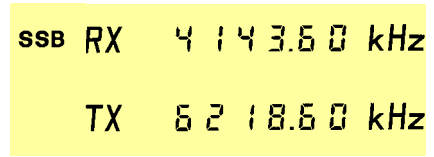

2. Press   to activate storage of the present set-up. The Prog and the RX bar will flash.

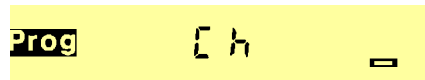

3. Enter the channel number that you wish to use as storage for the set-up.
e.g. User Programmable channel **76**.

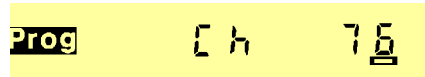

4. Press  to enter your choice of User Programmable channel.

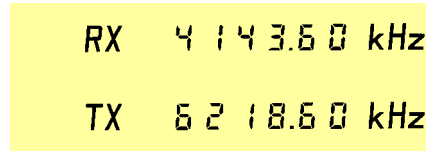

User Programmable Channels: 100 from channel no. 0 to 99.

RECALL A CHANNEL

Recalling an ITU channel or a channel stored in the User Programmable Memory.



1. Press  and the display will be cleared.



2. Enter the required channel number.
e.g. ITU channel 1221.

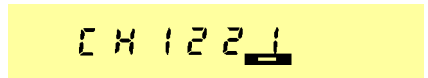

3. Press . The Receiver and the Transmitter frequencies stored in channel 1221 is now selected and will be displayed.

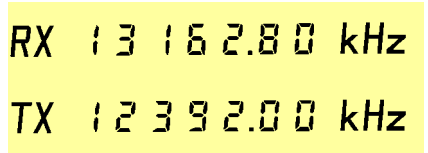

Recall Numbers:

- 0 - 99 :** User Programmable Channels.
- 100 - 129 :** GMDSS Distress and Safety Frequencies.
- 200 - 399 :** Direct Recall of the first 200 of up to 896 Pre-Programmed frequencies.
- 401 and up:** ITU Frequencies.



CHANGE MODE

Switching to a different operating mode.

**For all versions:**



Press  to switch to AM mode.

Press  to switch to TELEX mode.

Press    to switch to R3E mode.

TLX**R3E****For versions TRP 9250, 9251, 9253 and 9257:**

Press  to switch to SSB mode.

Where enabled - press    to switch to LSB mode.

SSB**LSB****For versions TRP 9254 and 9255.**

Press  to switch to USB mode.

Press  to switch to LSB mode.

USB**LSB**

For versions TRP 9255 and 9257.

Press  to switch to CW mode.



CW





As standard LSB is only enabled in the Basic version TRP 9254.

CHANNEL SCANNING, SET UP

Setting up a Channel Scanning program



1. Press   to start the programming.
The currently selected Scan Program Number is displayed. e.g. **0**.



2. Enter the Scan Program Number that you wish to programme.
e.g. **1**.



Press  to select the Program Number.

Start programming.

3. Enter the Number Of Channels that you wish to scan.
e.g. **3**.

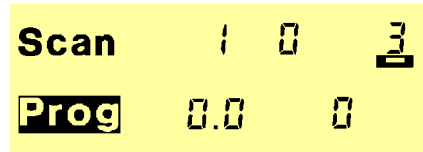

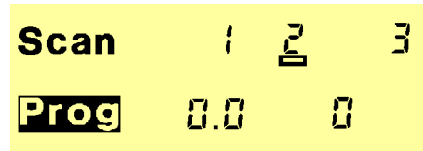

Press  to store the Number Of Channels.

4. Enter the number of the Trigger Source that you want to use : **0** = no trigger source, **1** = squelch, **2** = signal strength, **3** = squelch or signal strength, **4** = squelch and signal strength.
e.g. **2**.



Press  to store the Trigger Source.

Because signal strength is selected as Trigger Source in this example, you must set the corresponding sensitivity level now.

5. Press  Sens or  Sens to adjust the sensitivity level.
e.g. sensitivity **-80** dB

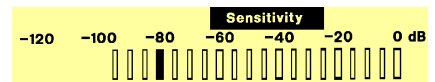

Press  to store the level.

6. Enter the Dwell Time which is the period in which the receiver will "listen" for a signal on each frequency.
e.g. **2.5** seconds.

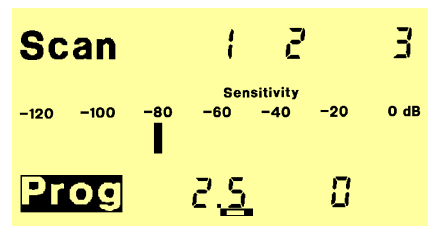

Press  to store the Dwell Time.

7. Enter the Hold Time which is the period in which the receiver will stay on a frequency if the Trigger Source has detected a signal.
e.g. **20** seconds.

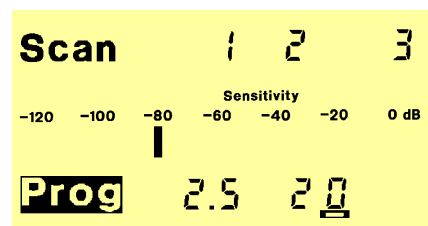

Press  to store the Hold Time.

Now the channels that you wish to scan must be stored in the Scan Table.

8. Enter the first Channel Number to be scanned.
e.g. ITU ch. **403**

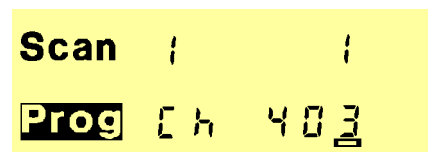

Press  to store the channel.

9. Enter the second Channel Number to be scanned.
e.g. ITU ch. **1206**

Press STO to store the channel.

Scan 1 2
Prog [h 1206]

10. Enter the third Channel Number to be scanned.
e.g. ch. **76** from the User Programmable Memory.

Press STO to store the channel.

Scan 1 3
Prog [h 76]

When the last channel is stored, the transceiver will return to normal operation.

RX 4143.60 kHz
TX 6218.60 kHz

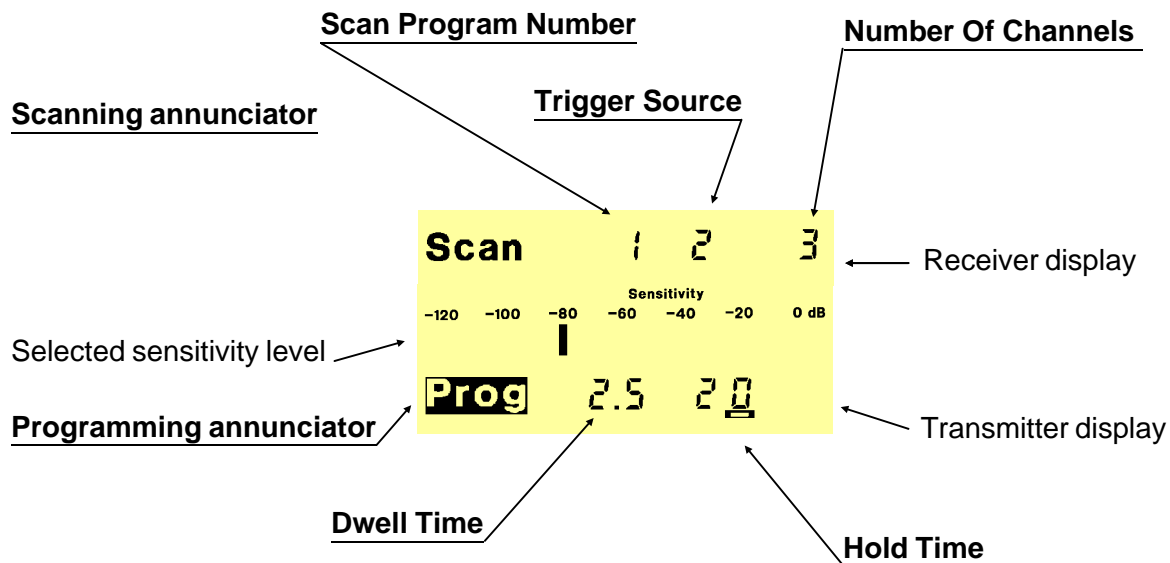
CHANNEL SCANNING, SET UP INFO**Scanning parameters:**

Scanning annunciator: Will be on during the programming.

Scan Program Number: 10 Scan Programs. Selectable from number 0 to number 9.

Trigger Source: Selectable with number 0 to 4. 0 = no trigger source, 1 = squelch, 2 = signal strength, 3 = squelch or signal strength, 4 = squelch and signal strength. (5 to 9 will be defaulted to 0).

Number Of Channels to be scanned: The maximum number is depending on the currently occupied scan memory, however not bigger than 99. Enter the required number and TRP 9250 will inform you if the available memory is too small, by flashing the number. If you store a bigger number of channels than required TRP 9250 will reduce the allocated memory to the actual need, after the scan table has been stored and then update the Number Of Channels to be scanned to the actual number.

Insert extra channels: Add the number of extra channels to the current number and store the new number as the Number Of Channels to be scanned. You may now store the new channels at the end of the Scan Table.

Delete a number of channels from the end of the scan table: Subtract the number of channels that you wish to delete from the current number and store the new number as the Number Of Channels to be scanned.

Delete a Scan Program: Store **00** as the Number Of Channels to be scanned.

Programming annunciator: Will flash during the programming.

Dwell Time: The period in which the receiver will "listen" for a signal on each frequency in the Scan Table. Selectable from **0.1** seconds to **9.9** seconds.

Hold time: The period in which the receiver will stay on a frequency in the Scan Table if the Trigger Source has detected a signal. Selectable from **1** second to **98** seconds.

No Hold Time: Store a Hold Time = **0** seconds.

Manual scanning: If you want to scan manually (press the Scan key to step to the next frequency in the Scan Table), store a Dwell Time = **0** seconds.

Automatic Stop: If you want to stop the scanning when the Trigger Source detects a signal , store a Hold Time = **99**.

Scan Table:

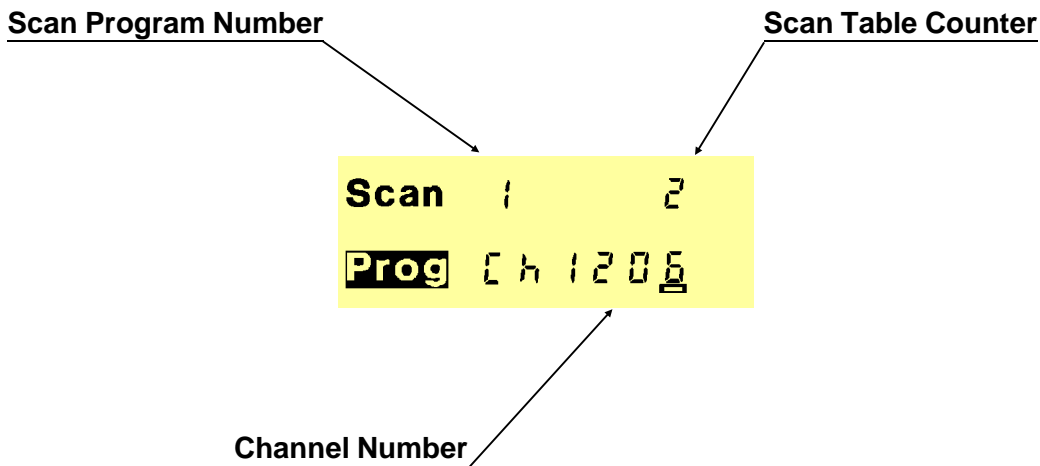

Scan Program Number: 10 Scan Programs. Selectable from number **0** to number **9**.

Scan Table Counter: Displays the current position in the Scan Table.
e.g. ITU channel 1206 will be stored as the second channel in this Scan Table.

Channel Number: An ITU channel or a channel stored in the User Programmable Memory.

View parameters and channels of a Scan Program: Press Prog Scan STO STO .

Delete a channel: Store **9999** as Channel Number in the scan table position that you wish to delete.

Replace a channel: Store the new Channel Number in the position of the channel you want to replace.

Leave a Scan Program: You may leave the programming at any time by pressing

Enter

Remote Scan start/stop facility: Is available with optional radiotelex modem "PCP717tlx" or remote control interface "Interface-A 718" installed.

CHANNEL SCANNING, RECALL PROGRAM

Recalling a Scan Program



1. Press **RCL** **Scan** to recall one of the 10 Scan Programs. The latest selected Scan Program will be displayed.
e.g. Scan Program Number 0.
Scan Programs are selected with numbers from 0 to 9.



2. Choose and enter the Scan Program Number e.g. Scan Program Number 1.

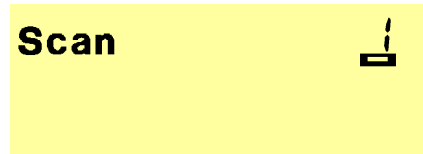

Press **Enter** to complete your choice.

3. The Scanning parameters for the selected Scan Program will now be displayed.
e.g.
Scan Program Number = 1
Trigger Source = Signal Strength (2)
Number of Channels to be scanned = 3
Dwell time = 2.5 seconds
Hold Time = 20 seconds

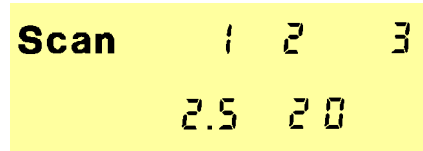

Press **Enter** to return.
The Transceiver will now return to normal operation.

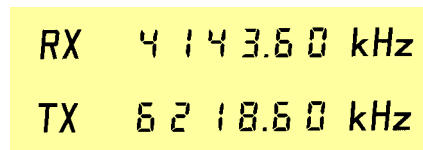

CHANNEL SCANNING, START/STOP

Operating the Channel Scanning.



1. Press  to start Channel Scanning. The Scan Program Number of the selected Scan Program will shortly be displayed. e.g. Scan Program Number 1.

Scan 1

2. Channel Scanning:

ScanRX 4363.60 kHz
CH 403

ScanRX 13116.30 kHz
CH 1206

ScanRX 4143.60 kHz
CH 76

3. Stop Channel Scanning:

- 3a. Press  to stop the Channel Scanning. Scanning will start on the next channel in the Scan

RX 4143.60 kHz
TX 6218.60 kHz

Table when you press  again.



- 3b. Press  to stop the Channel Scanning. Scanning will start on the first channel in the Scan

Table when you press  again.

Receiver and Transmitter frequency of the channel which was displayed when you stopped the scanning will now be displayed.

e.g. User Programmable channel 76: RX= 4143.6 kHz and TX= 6218.6 kHz.

FREQUENCY SWEEPING, SET UP

Setting up the Sweep Program.



1. Press **Prog** **Sweep** to start the programming.
The currently stored Sweep parameters are displayed.
e.g. No parameters are stored.



2. Enter the number of the Trigger Source that you want to use: 0 = no trigger source, 1 = squelch, 2 = signal strength, 3 = squelch or signal strength, 4 = squelch and signal strength.
e.g. 2.



Press **STO** to store the Trigger Source.

Because signal strength is selected as Trigger Source in this example, you must now set the sensitivity level.

3. Press **▲ Sens** or **▼ Sens** to adjust the sensitivity level.
e.g. Sensitivity -80 dB.
Press **STO** to store the level.

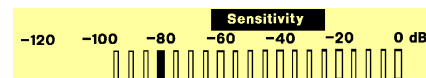

4. Enter the Dwell Time which is the period in which the receiver will "listen" for a signal on each frequency.
e.g. 2.5 seconds.

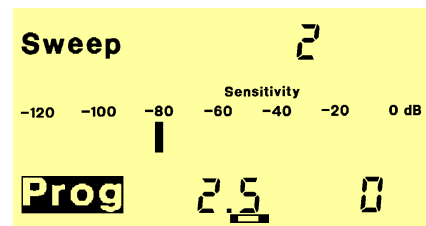

Press **STO** to store the Dwell Time.

5. Enter the Hold Time which is the period in which the receiver will stay on a frequency when the Trigger Source has detected a signal.
e.g. 20 seconds.

Press STO to store the Hold Time.

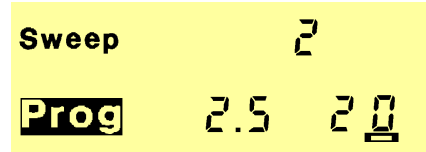

6. Enter the Step Frequency which is the frequency distance between all frequencies in the sweep.
e.g. 3.1 kHz.

Press STO to store the Step Frequency.

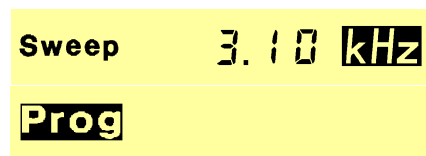

7. Enter the Start Frequency .
e.g. 8718.9 kHz.

Press STO to store the Start Frequency.

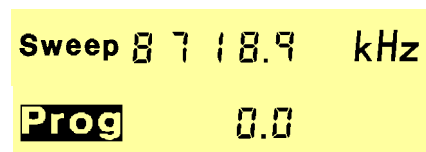

8. Enter the Stop Frequency .
e.g. 8811.9 kHz.

Press STO to store the Stop Frequency.

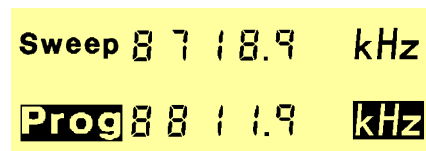



FREQUENCY SWEEPING, SET UP INFO

Sweep parameters:

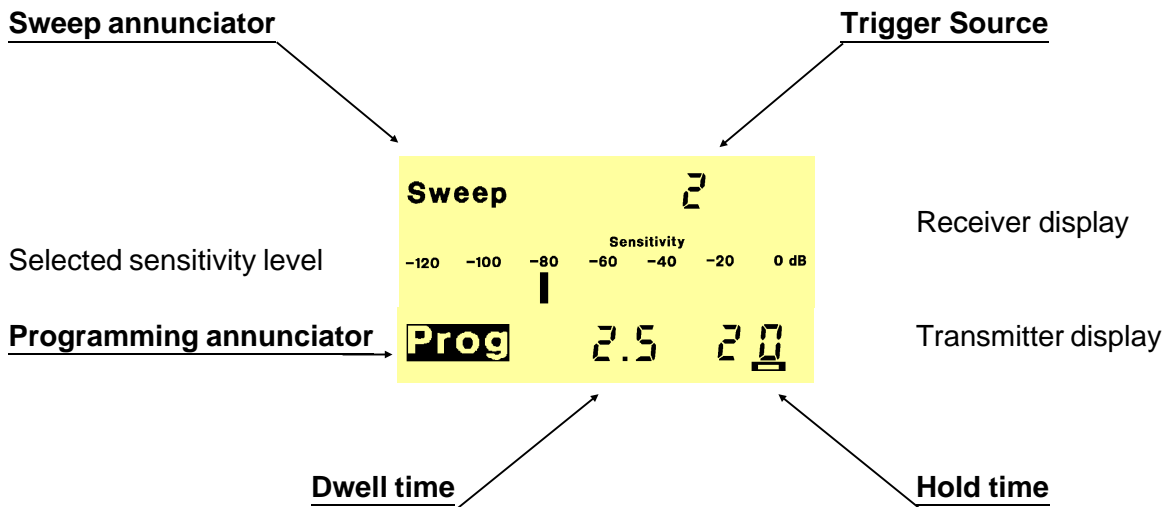

Sweep annunciator : Will be on during the programming and will flash during a frequency Sweep.

Trigger Source : Selectable with number 0 to 4. 0 = no trigger source, 1 = squelch, 2 = signal strength, 3 = squelch or signal strength, 4 = squelch and signal strength. (5 to 9 will be defaulted to 0).

Programming annunciator : Will flash during the programming.

Dwell time : The period in which the receiver will "listen" for a signal on each frequency in the Sweep Band. Selectable from 0.4 seconds to 9.9 seconds.

Hold time : The period in which the receiver will stay on a frequency in the Sweep Band if the Trigger Source has detected a signal. Selectable from 1 second to 98 seconds.

Step Frequency : The distance between the frequencies in the Sweep Band.

Start Frequency : The first frequency in the Sweep Band.

Stop Frequency : The last frequency in the Sweep Band.

Remote Sweep start/stop facility: Is available with optional radiotelex modem "PCP717tlx" or remote control interface "Interface-A 718" installed.

FREQUENCY SWEEPING, START/STOP

Operating the frequency Sweeping







1. Press  to start frequency sweeping using the stored Sweep parameters.

Sweep RX 8718.90 kHz

Sweep RX 8722.00 kHz

Sweep RX 8725.10 kHz

- 2a. Press  to stop the frequency sweep. Sweeping will start on the next frequency in the band when you press  again.

- 2b. Press  to stop the frequency sweep. Sweeping will start on the first frequency in the band when you press  again.

The Receiver frequency which was displayed when you stopped the Sweep will now be displayed.

RX 8725.10 kHz

SLEEP TIMER, SET UP

Setting up a Sleep Program.



1. Press **Prog** **Sleep** to start the programming.
The currently selected Sleep Program is displayed. e.g. 0.



2. Enter the Sleep Program Number that you wish to programme.
e.g. 9.

Press **Enter** to select the program number.



3. Enable/Disable the Sleep Program:
0 = Disable Sleep Program
1 = Enable Sleep Program
e.g. 1.

Press **STO** to store your choice.

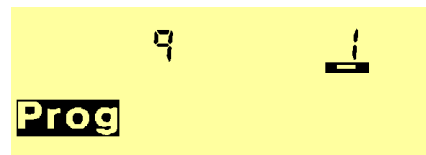

4. Enter the Channel Number that you wish to use when the Sleep Program turns on the transceiver.
e.g. ITU channel 802.

Press **STO** to store the Channel Number .

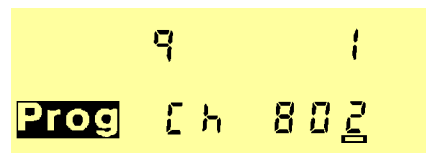

5. Enter the Wake Up Time which is the time of day that you wish this program shall turn on the transceiver. e.g. 15.00 (3.00 PM).
Press **PROG** to store the Wake Up Time.

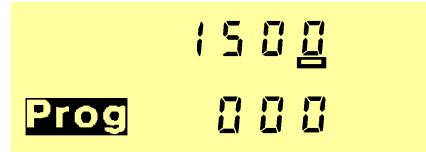

6. Enter the Fall Asleep Time which is the time of day that you wish this program shall turn off the transceiver. e.g. 15.30 (3.30 PM).
Press **PROG** to store the Fall Asleep Time.

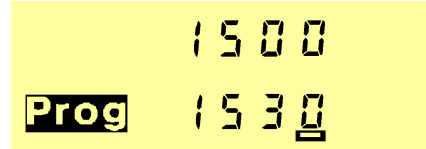

When the Fall Asleep Time is stored, the transceiver will return to normal operation.



Note:



SLEEP TIMER INFO

Timer parameters:

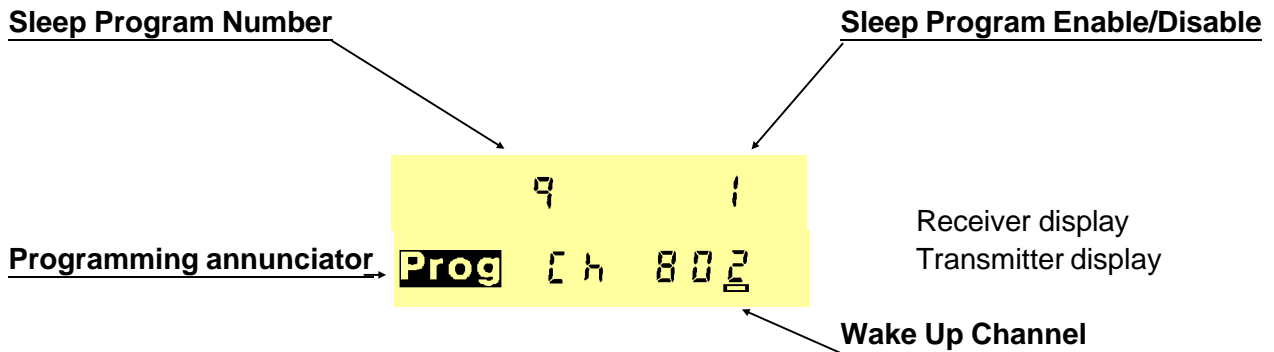

Sleep Program Number: 10 Sleep Programs. Selectable from 0 to 9.

Sleep Program Enable/Disable: 0 = Disable Sleep Program, 1 = Enable Sleep Program.

Programming annunciator: Will flash during the programming.

Wake Up Channel: The receiver and transmitter will be set to the frequencies of this channel when the Sleep Program turns on the transceiver.

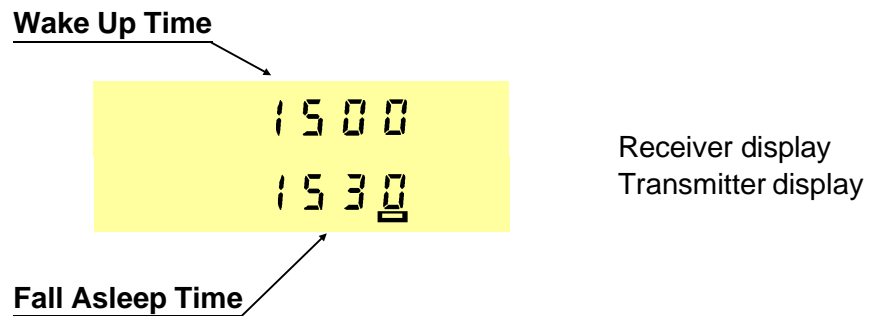

Wake Up Time: At this time the Sleep Program will switch on the transceiver.

Fall Asleep Time: At this time the Sleep Program will switch off the transceiver.

Wake Up and Stay On: If the the Fall Asleep time is set to the same time as the Wake Up time the Transceiver will switch on and stay on at this time.

SLEEP TIMER ON

Switching on the Sleep Timer.

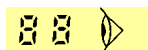

1. Press  to switch off the transceiver and activate the Sleep Programs.



2. When the Wake Up Time of one of the enabled Sleep Programs is reached the transceiver will automatically switch on.
e.g. 15:00.
The receiver and the transmitter frequency will be set up to the channel which was stored in this program.
e.g. ITU channel 802
with RX frequency 8722 kHz
and TX frequency 8198.1 KHz.

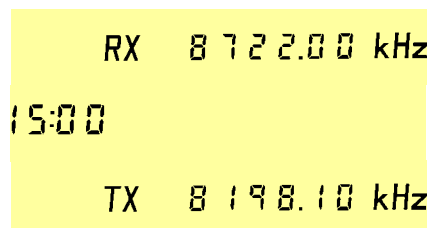

3. When the Fall Asleep Time of a Sleep Program is reached the transceiver will be switched off.

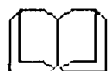
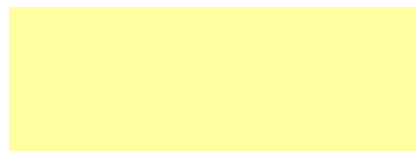

When the Sleep Timer is activated and has switched on the Transceiver, you may operate the Volume Up, Volume Down and Speaker On/Off switch. If you want to deactivate the Sleep Timer, just press any other key than the Volume and Speaker keys. If you want to activate the Sleep Timer again, it is necessary to press the Sleep key. When the transceiver is switched on by the Sleep Timer this is indicated by a flashing colon in the watch display. The colon will stop flashing if the Sleep Timer is deactivated as described above.

NOTE. Sleep and DSC/Telex operation

If TRP 9250 includes the optional built-in DSC/Telex the Sleep function is modified to a pseudo-Sleep function complying with the GMDSS requirements on DSC/Telex distress operation as follows.

Press "Sleep" to activate the pseudo-Sleep timer.

The TRP 9250 will:

- Switch TX off to save power.

- Display "Sleep" in the TX display.

- Switch all loudspeakers off (mute).

- Flash the ":" symbol of the watch

- and respond to all keying, key entries and remote control commands.

The TRP 9250 will disable the pseudo-Sleep and return to normal operation on a remote control command, keying and key entry except RX-freq./mode command, volume up/down and speaker (scanning of RX DSC or Telex frequencies via PCP 717S will not disable pseudo-Sleep).

OPERATION RELATED 'PROG' KEY OPERATIONS

By using the 'Prog' key extra functions and features may be selected, and programming of the equipment is possible.

'Prog' operations are selected by pressing:



Some functions requires further key entries where as others requires storing of parameters with the 'STO' key or stepping forward with the 'Volume Up' key.

The following is a list of the related operations which are selected by their number:

0 - 9 : Select modes and features.

10 - 19 : Select special functions.

20 - 74 : Installation and service. Refer to SERVICE section.

98 : Security Code.

99 : Select Configuration Mode. Refer to INSTALLATION section.

<u>No.</u>	<u>Function</u>
0 :	Leave System to other User.
1:	Connect TCU Remote Control port
2 :	Select LSB Mode.
3 :	Select R3E Mode.
4:	Set Side Tone frequency for CW.
5:	Set Break-in Time for CW.
6 :	Switch RF Attenuator On/Off.
7 :	Float Antenna.
8 :	Ground Antenna.
9 :	Switch "Boop" Sound On/Off.
10:	Select Intercom.
11:	Set Real Time Clock.
12:	Switch Treble Cut On/Off
13:	Tilt Viewing Angle of Display.
14:	Toggle Bar-graph Reading, Power or Amperes.

15:	Set Beep Level.
16:	Select HST mode.
20:	<i>Automatic Stepped Self-test.</i>
21:	<i>Manually Stepped Self-test.</i>
22:	<i>Read Protection Code.</i>
23:	<i>View ATU Relay Setting.</i>
25:	<i>Read CU Priority / Intercom Number.</i>
26:	<i>View CU Software Version, Release and Release Date.</i>
27:	<i>View TU Software Version, Release and Release Date.</i>
28:	<i>View TU Configuration Customer ID, Version, Release and Release Date.</i>
29:	<i>View ATU Software Version, Release and Release Date.</i>
30:	<i>Read Accumulated On Time.</i>
31:	<i>Read Frequency Error</i>
32:	<i>View RX / EX Signal Path 715 Version.</i>
33:	<i>View Option Filter.</i>
34:	<i>View Power Amplifier Version.</i>
35:	<i>View PA Filter Version.</i>
36:	<i>View ATU Status.</i>
37:	<i>View Dummy Load.</i>
39:	<i>View Optional Interface Board.</i>
40	<i>Switch all Annunciators On in Display.</i>
41	<i>Switch Beep Sound On.</i>
42	<i>Switch Boop Sound On.</i>
43	<i>Switch High-beep Sound On.</i>
45	<i>Display Customer Secified Frequencies Pre-Programmed in Configuration PROM.</i>
46	<i>Display Configuration parameters pre-programmed in Configuration PROM.</i>
74	<i>View Supply Voltage</i>
98	View and Change Security Code.
99	<i>Select Configuration Mode.</i>

Description of 'Prog' operations

<u>No.</u>	<u>Function</u>
0	Leave System to other User. Applicable with a Multi Control Unit operated transceiver .
1	Connect TCU Remote Control port. Applicable with a Multi Control Unit operated transceiver .
2	Select LSB Mode. Both Receiver and Transmitter is set to LSB (J3E) mode. "LSB" annunciator is switched on.
3	Select R3E Mode. Receiver is set to USB (J3E) mode, Transmitter to R3E (USB) mode and "R3E"annunciator is switched on.
4	Set Side Tone frequency and level for CW. When CW mode is selected the Side Tone frequency, heard during transmit, can be adjusted from 300Hz to 3kHz by using the "Volume Up"and "Volume Down" keys. Likewise the Side Tone level can be adjusted between 0 and 64 to suit the individual operator. The actual Side Tone frequency is displayed in the receiver display and the Side Tone level is displayed in the transmitter display. ton 0.80kHz LE 52 When the wanted Side Tone frequency is obtained press "STO" to store the new frequency. Now the Side Tone level can be adjusted with the volume keys. Press "STO" to store the wanted level and to return to the normal display. If "Enter" is pressed instead the old Side Tone frequency and level are retained and the transceiver will return to normal display. Both Side Tone frequency and level are adjustable during transmit condition.

5

Set Break-in Time for CW.

Break-in Time is the time elapsed from the morse key is released to the received signal is heard in the loudspeaker. To adapt the Break-in Time to the morse speed of the operator, it can be adjusted between 0.020 seconds to 1 second with the use of the "Volume Up" and "Volume Down" keys. The receiver display shows the actual Break-in Time in milliseconds.

b-t 40

When the Break-in Time is adjusted to the wanted value press "STO" to store it and to return to the normal display. If "Enter" is pressed instead the old Break-in Time is retained and the transceiver will return to normal display. The Break-in Time is adjustable during transmit condition.

6

Switch RF Attenuator On/Off.

When heavy interfering signals are present at the receiver input, reception quality can be improved by switching on the RF Attenuator. "Att" annunciator is switched on when the RF Attenuator is on.

7

Float Antenna.

When the optional Dummy Load is installed in the ATU it is possible to disconnect (Float) the antenna. When the antenna is floating the display shows:

Float**ant**

and the Transceiver can neither receive nor transmit. Press "Enter" to connect the antenna again and return to normal operation.

8

Ground Antenna.

When the optional Dummy Load is installed in the ATU it is possible to connect the antenna to ground. When the antenna is grounded the display shows:

gnd ant

and the Transceiver can neither receive nor transmit. Press "Enter" to return to normal operation.

9

Switch "Boop" sound On/Off .

If an illegal key is pressed the CU will sound a "Boop". This feature may be selected / inhibited to suit the individual operator.

1

0

Select Intercom.

When more than one Control Unit is connected the TRP 9250 can act as a normal telephone with intercommunication between any two control units. After "Prog" "10" "Enter" is pressed the display shows

Phone _

Enter "phone number" of the wanted Control Unit and press "Enter". The wanted CU will start beeping until the handset is hooked-off. Normal intercommunication in full duplex can now take place with all other control units muted. The Intercom facility is automatically disabled first time the handset of the calling CU is hooked-on, and the Transceiver returns to normal operation. Please refer to @@

1

1

Set Real Time Clock.

After "Prog" "11" "Enter" is pressed the Clock Display is cleared and the correct time of day can be entered with the numeric keys. Press "STO" and the Real Time Clock is started in the same moment.

1

2

Switch Treble Cut On/Off

During difficult atmospheric conditions and reception of weak signals, the intelligibility of the received signal may deteriorate due to high frequency noise. The Intelligibility may be greatly improved by switching Treble Cut on during these conditions. The Treble Cut may be selected individually on each TCU connected.

1

3

Tilt Viewing Angle of Display.

To obtain the best possible legibility the viewing angle of the display may be toggled between two positions by pressing "Prog" "13" "Enter".

1

4

Toggle Bar-graph Reading, Power or Amperes.

By pressing "Prog" "14" "Enter" it is possible to change the transmitter Bar-graph display between either power or antenna current.

1

5

Set Beep Level.

To adjust the keyboard Beep to a convenient level switch the loudspeaker on and press "Prog" "15" "Enter". The keyboard Beep is constantly beeping and may be adjusted to a convenient sound level by the "Volume up" and "Volume down" keys. Press "STO" to store the new Beep level. Pressing "Enter" instead will maintain the previous Beep level setting.

1

6

Select HST mode.

Pressing "Prog" "16" "Enter" will select High Speed Telex mode. This mode is indicated by both the "SSB" and "TLX" annunciators in the display.

9

8

View or change Security Code.

Once encoded the Security Code provides the equipment with a psychological barrier against theft as the equipment is not operational before the correct code is entered.

A "Security Code" sticker is supplied together with the transceiver. It must preferably be placed on a visible spot near the equipment.

As the Security Code is assigned only to the currently used Control Unit, it is necessary to store a Security Code in all CU's where more than 1 is installed. A different Security Code may be used for each Control Unit as a protection against unauthorized use.

For Security Code, numbers between "1" and "9999999" may be used providing a total of 9999999 different numbers. Factory setting is "0" which means no entry of Security Code is required to operate the transceiver.

If the Security Code feature is desired, the following syntax must be used:

"Prog" "98" "Enter"

The Receiver Display shows the current Security Code. Key-in the wanted Security Code and store it:

"Security Code" "STO"

The Security Code is now stored in the currently used CU and must be entered every time the power supply is switched on:

"Security Code"

"Enter"

NOTE

- To disable the Security Code a "0" is stored meaning no Security Code.
- The Handset must be hooked on before the Supply is switched on and the Security Code is entered.
- If a wrong Security Code is entered the equipment is not operational.
- If a wrong Security Code is entered by mistake, just press "Enter" and enter the correct Security Code.
- Write down your Security Code and keep it in a non conspicuous place.
- If the Security Code is forgotten contact the local dealer.
- If the Security Code is used as a preventive measure against theft, it is recommended to enable the Security Code only when the ship is in port and disable the Security Code when the ship is at sea, giving quick radio-access to all on board in case of an emergency situation.

PROPAGATION OF HF AND MF RADIO WAVES

Introduction

The TRP 9250 is able to operate on frequencies from 1.605 MHz to 30 MHz. This frequency span covers the upper part of the MF range (0.3 - 3 MHz) and the whole HF range (3 - 30 MHz). In this wide frequency area the propagation properties of radio waves differs markedly from one edge to the other.

The propagation in the MF and HF frequency bands takes place in two different ways, namely one in which the radio waves follows the surface of the Earth ("Groundwaves") and one in which the radio waves are reflected from the Ionosphere ("Skywaves"). Both propagation modes are influenced by many factors, the major being the Sun, the position of the vessel on Earth and the time of day.

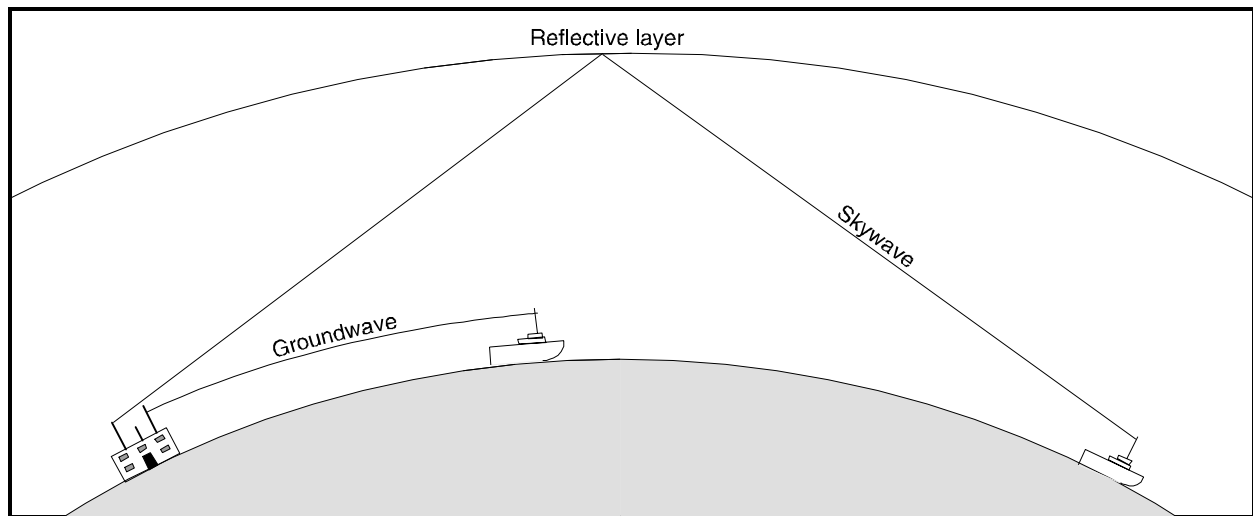

Groundwave propagation

In the MF band and the lower part of the HF band, at frequencies up to 5 MHz the predominant propagation mode is groundwave propagation.

In this mode the waves originating from the transmitter antenna will follow the Earth's curvature to the receiver antenna. It is not necessary to have direct line of sight between the antennas as it is in the case of VHF radiotelephones. Under normal conditions the range of communication can be expected to be up to 800 km at 1.6 MHz decreasing to about 500 km at 5 MHz. The reason for the shorter range on the higher frequencies is that the attenuation in the atmosphere increases with the frequency and at the same time the radio waves' ability to follow the curvature of the Earth decreases.

The time of day will also influence on the propagation. During the day, the atmosphere, due to the radiation from the Sun, will be more absorptive than during the night when a range of up to 1000 km can be expected.

MF band radio waves are radiated with the highest efficiency from a long antenna. This is due to the long wavelength of the signal.

At frequencies above 5 MHz the radio waves ability to follow the Earth's curvature decreases and at 30 MHz the propagation is almost along a straight line. Therefore if ground wave propagation is to be used on 30 MHz the range is confined to distances at which there will be optical sight between the antennas in question.

Skywave propagation

At frequencies between 5 MHz and 30 MHz long distance propagation is achieved by skywave propagation. Certain layers of the Earth's upper atmosphere, in the Ionosphere, called the E-layer and the F1- and the F2-layers are able to act as a sort of mirror to the radio waves in the above mentioned frequency range. A signal of the appropriate frequency will therefore be reflected by the mirror and will return to the Earth beyond the horizon of the transmitter antenna.

The reflection properties of the Ionosphere are strongly dependent of the state of the Ionosphere. During the day the Sun's radiation will increase the reflection, while the reflection during the night will be lower. At the same time the radiation will however, increase the attenuation of the radio waves.

The highest frequency that can be used to communication on a certain distance is called the Maximum Usable Frequency (MUF). This frequency is, however, subject to great variation in propagation. The best frequency to use is about 15 pct. lower than the MUF. This frequency is called the FOT, Frequence Optimal du Travail.

Besides the diurnal variations due to the Sun's radiation, the propagation is also dependent of the solar activity in general. During periods of high solar activity the MUF will be higher, but at the same time disturbances in the Ionosphere, due to the high activity, will be more frequent.

Tables of MUFs covering various radio paths are published monthly by many telecom administrations.

3. INSTALLATION Table of contents

Mounting The Units	3-3	Configuration	3-49
Mounting the Transceiver Control Unit	3-3	Select Configuration Mode	3-49
Mounting the Transceiver Unit	3-7	Reconfiguration of a Function with Parameters	3-49
Mounting the Antenna Tuning Unit	3-9	Directly Executable Functions	3-50
Power supply	3-10	Disable or Enable Keyboard keys	3-50
Battery Charger	3-12	TRP9250, TRP9251, TRP9253 with standard Control Unit.	3-51
Earth Connections	3-14	TRP9254 with standard Control Unit	3-52
Antenna Tuning Unit	3-14	TRP9255 with standard Control Unit	3-53
Transceiver Unit	3-14	TRP9252 and 9257 with standard Control Unit	3-54
Antennas	3-15	Enable Power Levels	3-55
Recommended ATU Installation	3-15	Input Selector versus TX Mode	3-55
Interconnection of Units	3-16	Select Transmitter Key Input versus TX Mode	3-55
Handset-to Transceiver Control Unit connections	3-16	Compressor Time Constant versus TX Mode	3-56
Transceiver Control Unit-to-Transceiver Unit connections	3-17	AGC Parameters versus RX Mode	3-56
Transceiver Unit-to-Antenna Tuning Unit connections	3-18	AF Bandwidth in telex mode	3-58
Connectors for External Equipment	3-19	Split Mode Disable/Enable tables	3-58
Transceiver Control Unit connector panel	3-19	Disable / Enable "Prog" functions	3-59
Transceiver Unit terminal strip panel	3-23	Disable / Enable "Prog" "98" function	3-59
Final installation Check	3-27	TCU backlight step mode	3-60
Configuration Prom	3-29	External "Line, key" inputs versus TX mode	3-60
Configuration PROM Map	3-30	View / change Remote Control set-up of DSC and Telex Option, Interface-A 718S or PCP 717S	3-61
Frequency Record Format	3-31	View / change Telex Audio Centre Frequency	3-63
Fixed Step Frequencies Format	3-32	View / change External Scan S/S input	3-64
Frequency Band Format	3-34	View / change TCU Priority System	3-65
Pre-programmed ITU frequencies	3-35	Assign Cu Priority / Intercom No.	3-67
System Configuration Parameters	3-40	Reset Scan, Sweep and Sleep	3-67
Standard Programming	3-44	Reset currently used Control Unit	3-67
Installation related 'Prog' key operations	3-45	Reset System Parameters to default values	3-67
		Reset total memory and system parameters to default values	3-67
		View / change Password	3-68

DESCRIPTION

General

Correct installation of the TRP 9250 is important for maximum performance and reliability. Antennas and earth connections must be installed with the greatest care using corrosion resistant materials. Cable routing shall be made so the cables are protected from physical damage. Sharp cable bends especially on coaxial cables must be avoided and a sufficient number of clips or straps should be used to secure the cables.

MOUNTING THE UNITS

Mounting the Transceiver Control Unit

One or two Transceiver Control Units may be connected to the Transceiver Unit using the build-in local area network (ScanBus). The Transceiver Control Units must be chain connected and the maximum distance from the Transceiver Unit to the most distant Transceiver Control Unit is 500m. The required type of screened multiwire cable depends on the number of Control Units and the distance between the units. See fig.1.

If the DCS option is included in Transceiver Unit one or two DSC Control Units may also be connected in the chain.

Installation examples and recommended cable specification.

Cable type: 2 x 5 screened multiwire

ScanBus termination jumper: ■

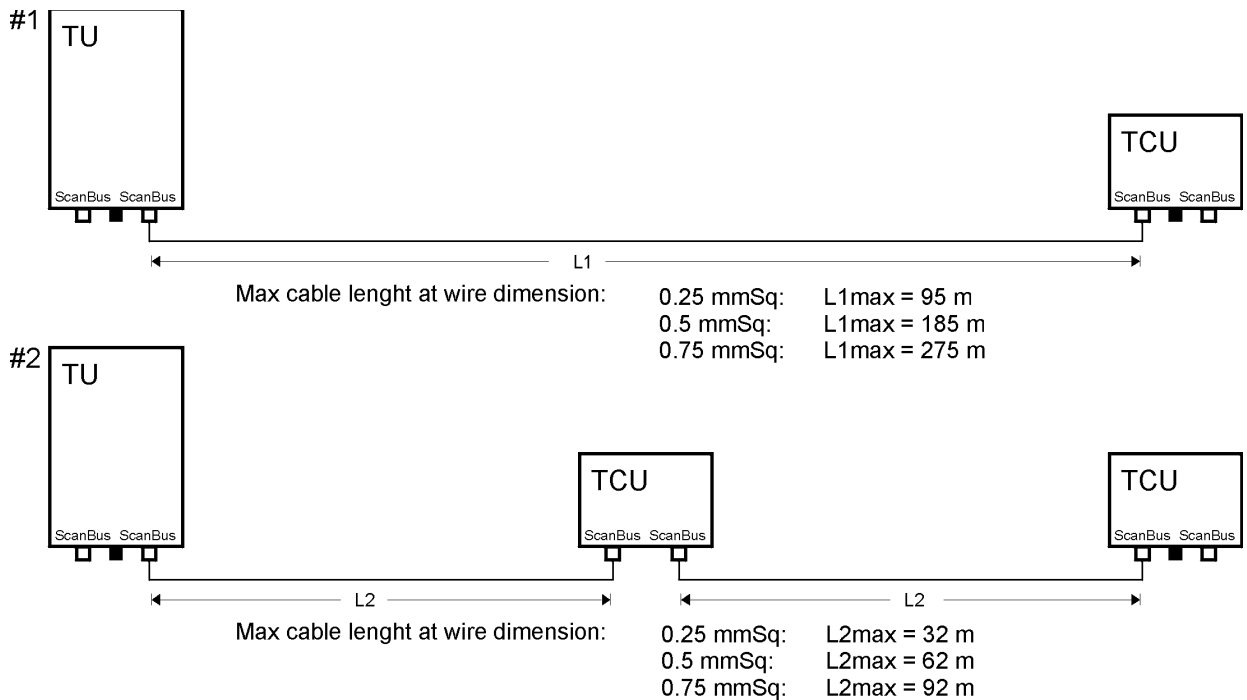
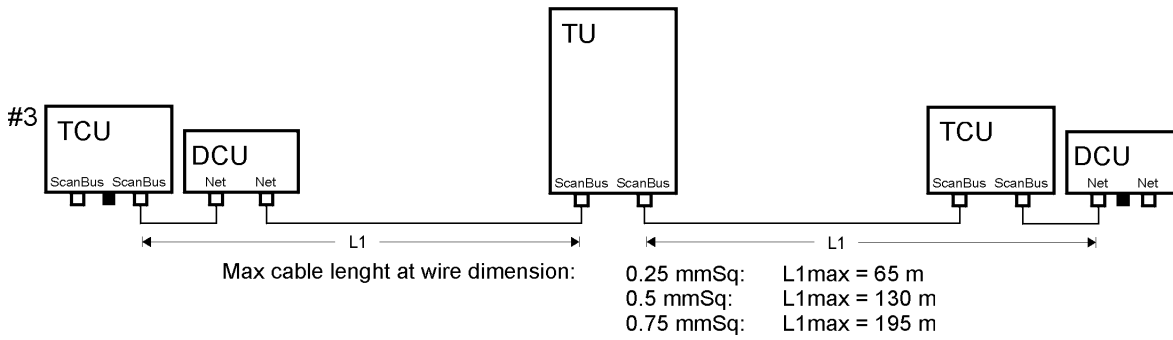
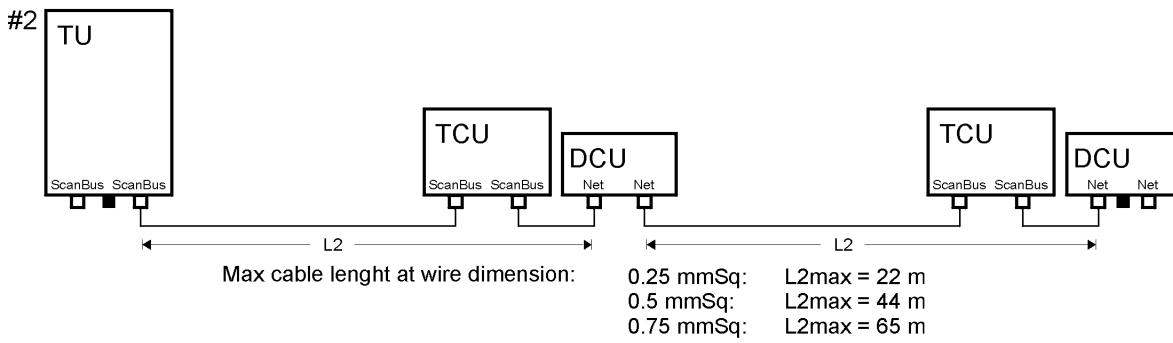
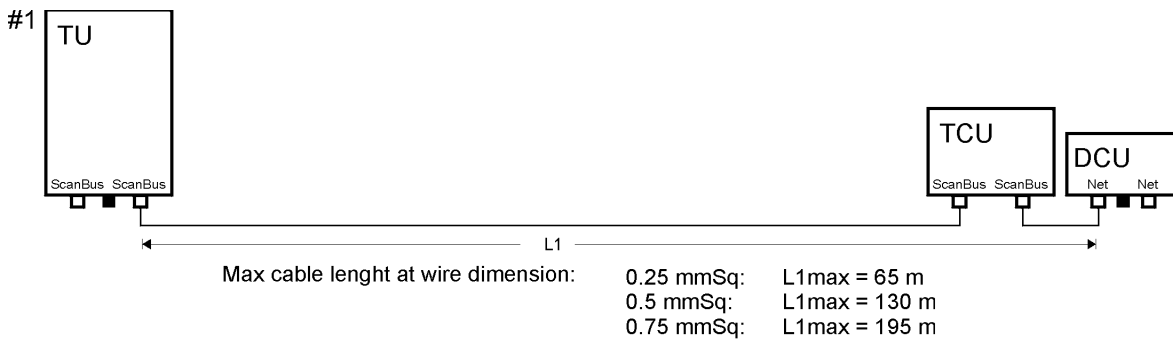

fig.1

Installation examples and recommended cable specification including the DSC option.

Cable type: 2 x 5 screened multiwire

ScanBus termination jumper: ■



The Transceiver Control Unit may be tabletop or bulkhead mounted. Fig. 2 and 3 shows different possibilities to obtain the best possible viewing and operation position and fig.3 includes the use of the optional bracket . Overall dimensions and a drilling plan for the necessary holes is also shown in fig.s 2 and 3. If the mounting surface is not sufficiently plane then apply washers between the Transceiver Control Unit and the surface.

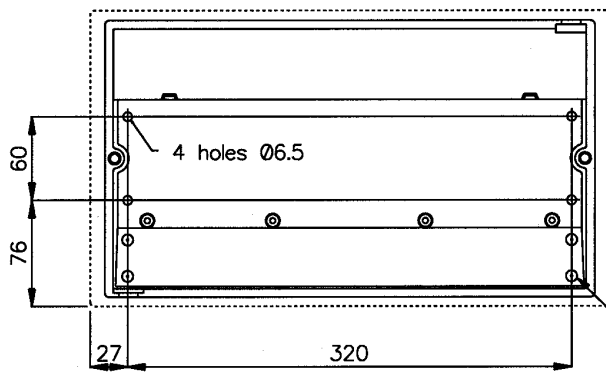
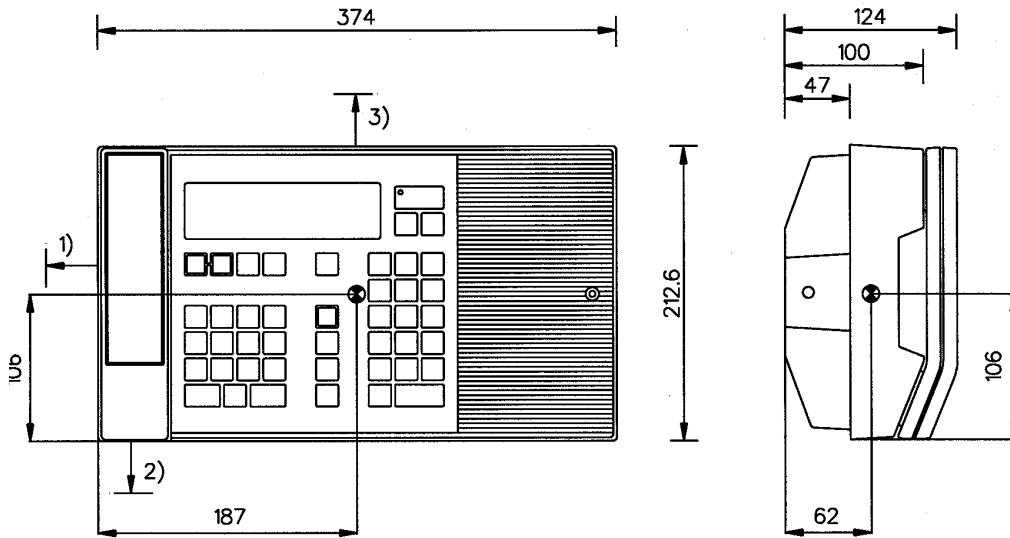

fig.3

- 1) Space for handset access min. 150
- 2) Space for cable entry and handset cable: min. 200
- 3) Space for cable entry: min 50
- 4) For tilted mounting: drill 4 holes Ø8 in bottom of cabinet

Dimensions are in mm
 Tolerance: +/- 1 mm
 Weight: 3.4 Kg
 Doc.: 4-0-31441

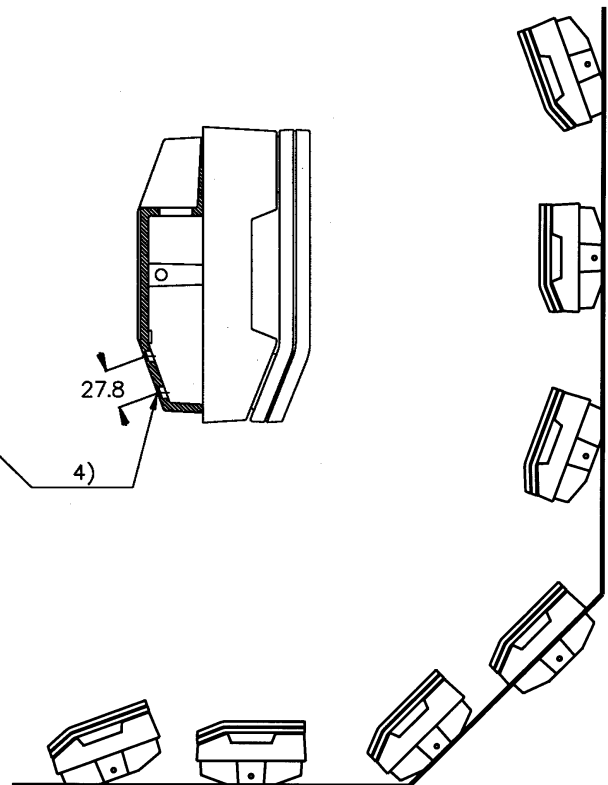

fig.2

Mounting options

Transceiver Control Unit with Mounting Bracket.

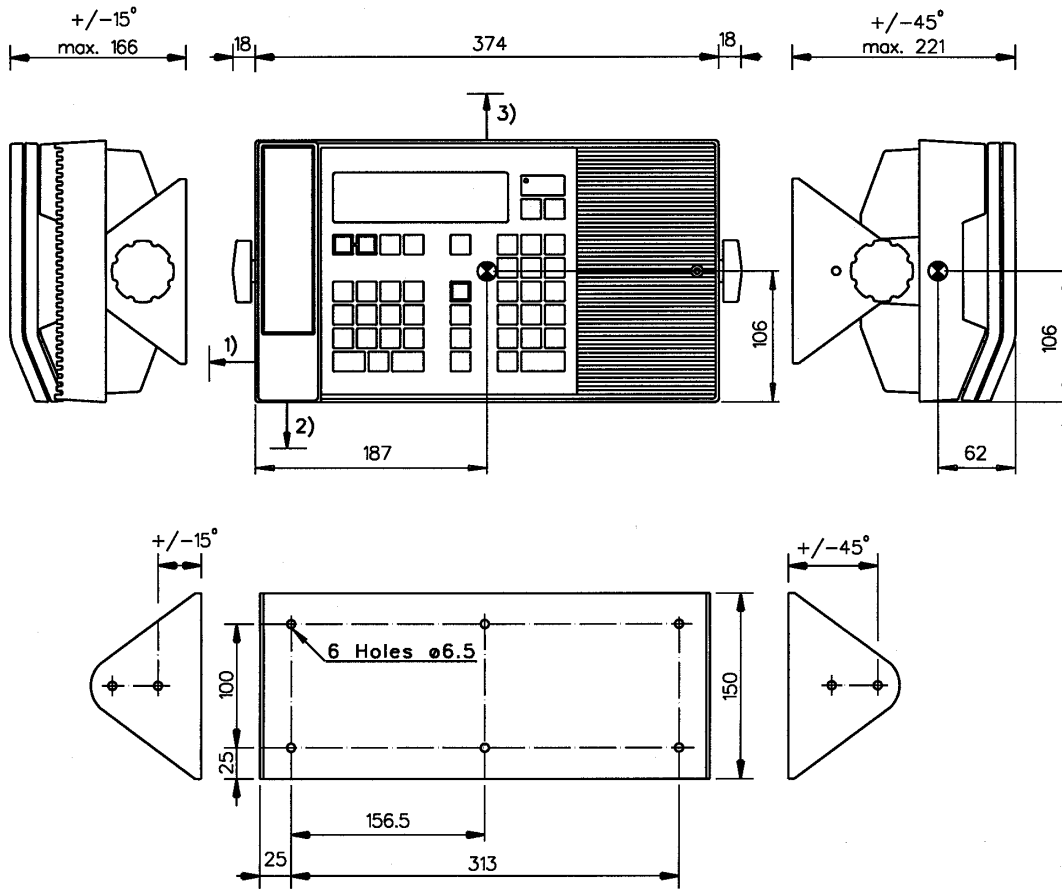

fig.5

- 1) Space for handset access min. 150
- 2) Space for cable entry and handset cable: min. 200
- 3) Space for cable entry: min 50

Dimensions are in mm
 Tolerance: +/- 1 mm
 Scale: @
 Weight TCU: 3.4 Kg
 Weight Mounting Bracket: 1.7 Kg
 Doc.: 4-0-31437

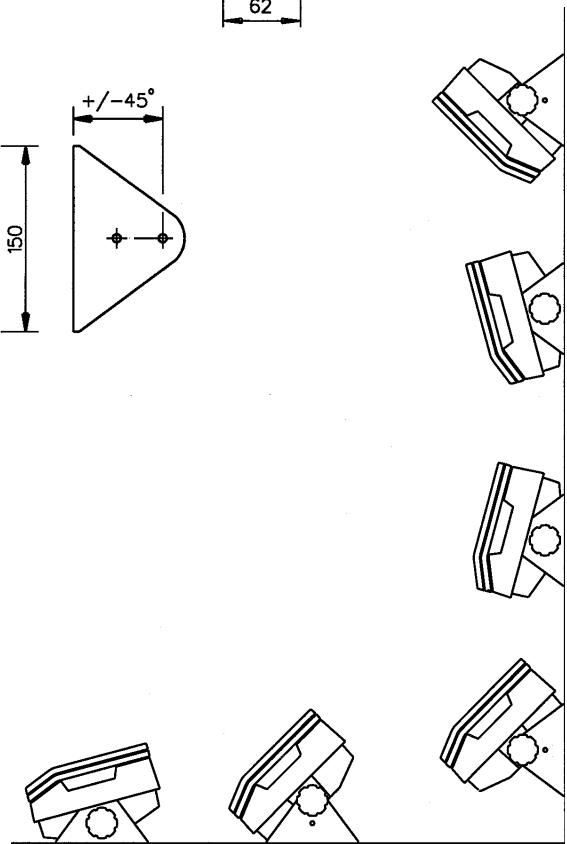

fig.4

Mounting options

The cables may enter the Transceiver Control Unit from either side. The control panel is turned 180 degrees (relative to the bottom part) to enable cable entry from the opposite side. The viewing angle of the LCD display can be optimized for best performance by using the 'Prog' '13' function. The level of the Beep sound (when pressing a key) may be adjusted by pressing 'Prog' '@' function. See description of the User Programmable Functions.

Mounting the Transceiver Unit

The Transceiver Unit should be installed in a dry place and consideration should be given to accessibility for servicing. It is important to provide plenty of airspace on the sides for adequate fan driven air circulation through the unit . Figures - shows the outer dimensions, mounting possibilities and the minimum distances to other objects ensuring good cooling, as well as a drilling plan.

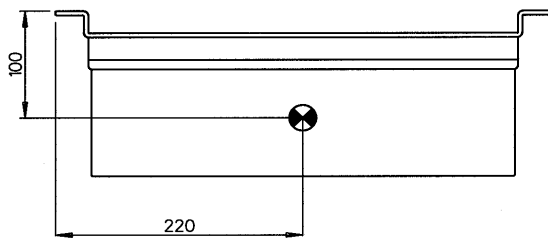
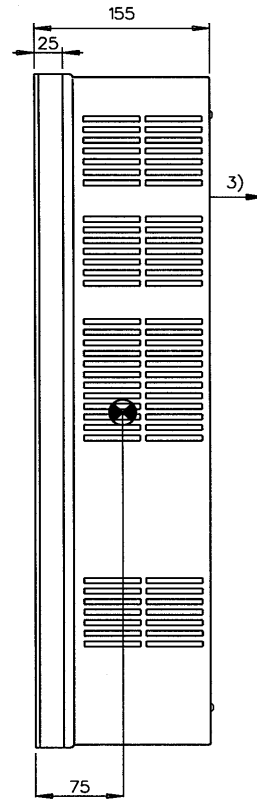
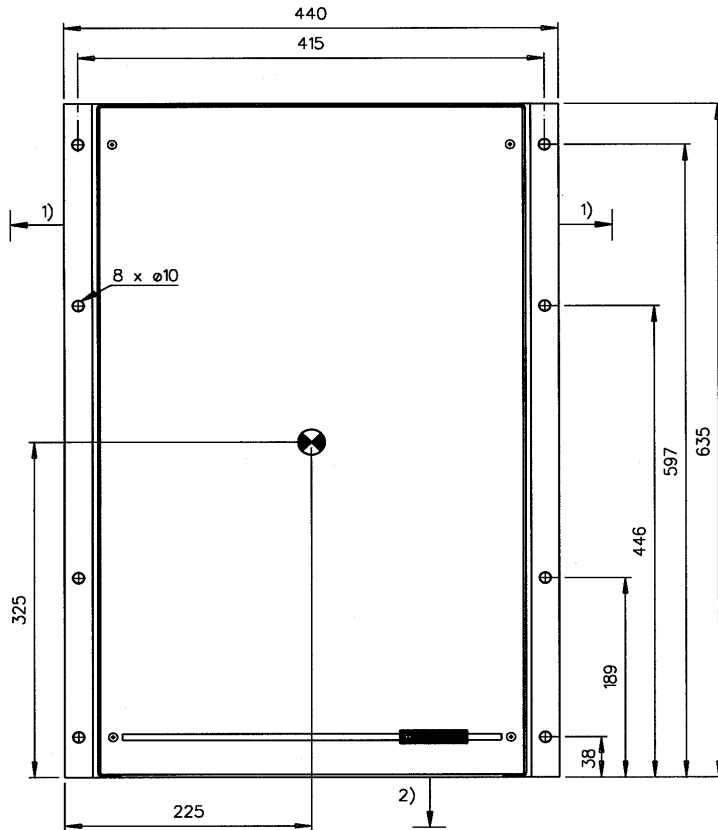

fig.7

Bulkhead mounting

- 1) Space for airflow: min. 200
- 2) Space for cable and airflow: min. 25
- 3) Space for service access: min. 1000

Dimensions are in mm
 Tolerance: +/- 1 mm
 Weight without optional AC power supply: 19.5 Kg
 Weight with optional AC power supply: 21 Kg

☉ Centre of gravity
 Doc.: 4-0-34091

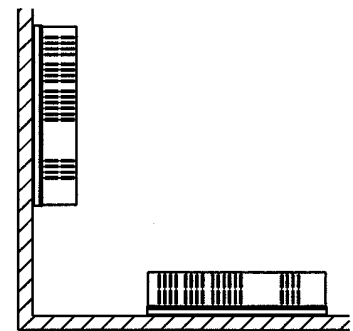

fig.6

Mounting options

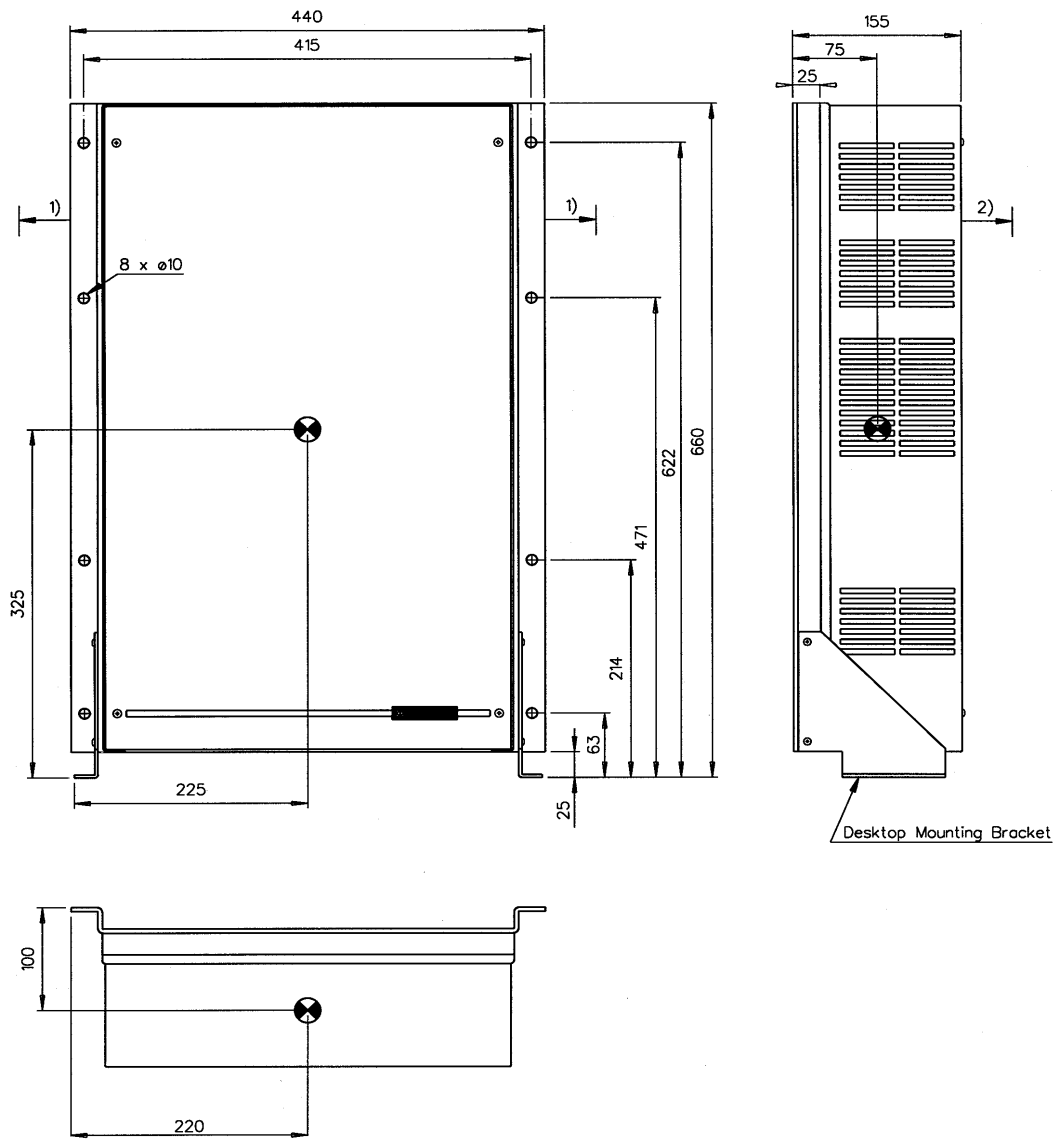

fig.8

Desktop mounting

- 1) Space for airflow: min. 200
- 2) Space for service access: min. 1000

Dimensions are in mm
 Tolerance: +/- 1 mm
 Weight without optional AC power supply: 19.5 Kg
 Weight with optional AC power supply: 21 Kg

☉ Centre of gravity
 Doc.: 4-0-34088

Mounting the Antenna Tuning Unit

The Antenna Tuning Unit may be mounted up to 100 metres from the Transceiver Unit using just one RG-213/U coaxial cable and a 4 x 0.5 mm² screened multiwire cable for interconnection. The unit should be installed near the antenna feed point. Fig.14 shows mounting details.

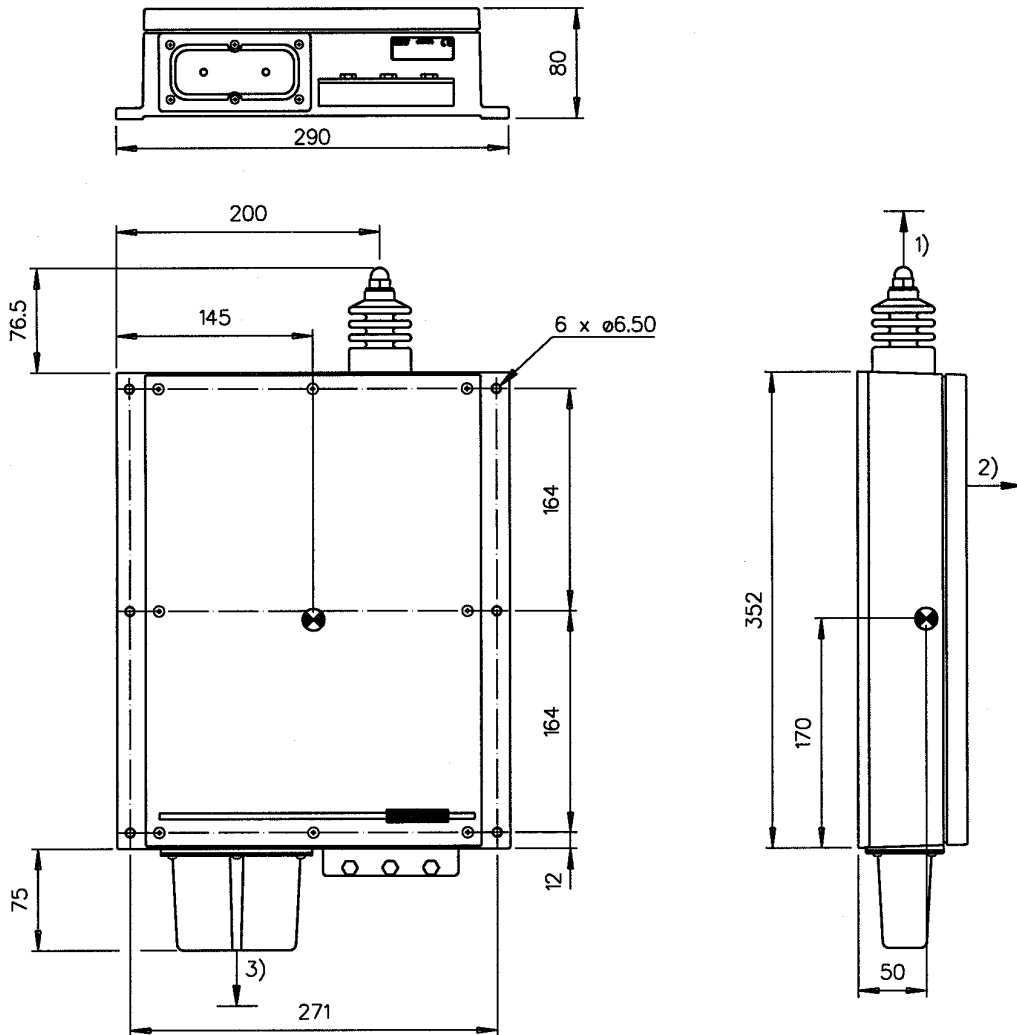

fig.10

- 1) Space to nearest overhang: min. 50
- 2) Space for service access: min. 500
- 3) Space for cable and service access: min. 200

Dimensions are in mm
 Tolerance: +/- 1 mm
 Weight: 3.3 Kg
 Doc.: 4-0-34106

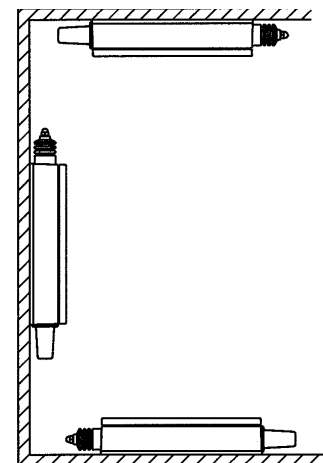

fig.9

Mounting options

POWER SUPPLY

DC SUPPLY ONLY

This section applies if the optional built-in AC Power Supply Assembly P 9250 is not installed.

The supply leads are connected to the 24 V DC supply terminals of the Transceiver Unit located on the Connection Board. Screened power supply cable may be used as required by some administrations. The screen of the cable is connected to chassis by a cable clamp. Attention should be paid to CCIR Rec. 218-1 which recommends that cables in the vicinity of the receiving antennas or the radio receiving room, and cables within the radio room, are screened by enclosing them in metal conduits, unless the cables themselves are effectively screened.

The earth connection of the equipment will not cause the battery to be earthed. Maximum permissible peak voltage between the battery terminals and earth is 100 V. Note that fuses must be provided in the supply leads. Table below shows the necessary cable cross sections and external fuse ratings.

Max. cable length to battery *	Recommended cable Screened multiwire	External fuses
7 m	2 x 10 mm ²	40 A
11 m	2 x 16 mm ²	50 A
17 m	2 x 25 mm ²	63 A

AC / DC SUPPLY

This section applies if the optional built-in AC Power Supply Assembly P 9250 is installed.

Before connecting the AC mains, check that the voltage selector switch on the AC Power supply assembly is set to the correct voltage and that the fuse rating corresponds to the setting used.

The voltage selector is located at the AC Power Supply Assembly below the Connection Board. The selected voltage is indicated by an arrow in the outer ring. The equipment is normally dispatched with the selector set to 220 V. To select a different voltage, insert a screwdriver in the slot and turn the switch to the correct setting.

Setting	Voltage range
110	99 - 132 V
220	198 - 264 V

Caution: **Incorrect setting of the mains voltage selector may damage the AC Power Supply Assembly**

The AC mains fuse holder is an integral part of the AC terminal block which is located to the left of the Connection Board. The fuse is accessed by pulling out the black handle, The correct fuse rating for each voltage setting is as follows

Setting	Fuse rating
110	8 A Slow
220	4 A Slow

Fuses are cartridge type measuring 20 x 5 mm.

The AC supply leads are connected as indicated to the terminal block. Screened power supply cable may be used as required by some administrations. The cable is fastened and the screen connected by the cable clamp on the main chassis below the terminal block.

L	Live
N	Neutral
	Protective earth

Recommende cable type: 3 x 1.5 mm²

The 24 V DC supply leads are connected to the Battery terminals located to the right of the Connection Board. Cable screen is connected to the chassis by means of the cable clamp on the main chassis below the terminals. The earth connection of the equipment will not cause the battery to be earthed. Maximum possible peak voltage between the battery terminals and earth is 100 V. Note that fuses must be provided in the supply leads. A table on the previous page shows the necessary cable cross sections and external fuse ratings.

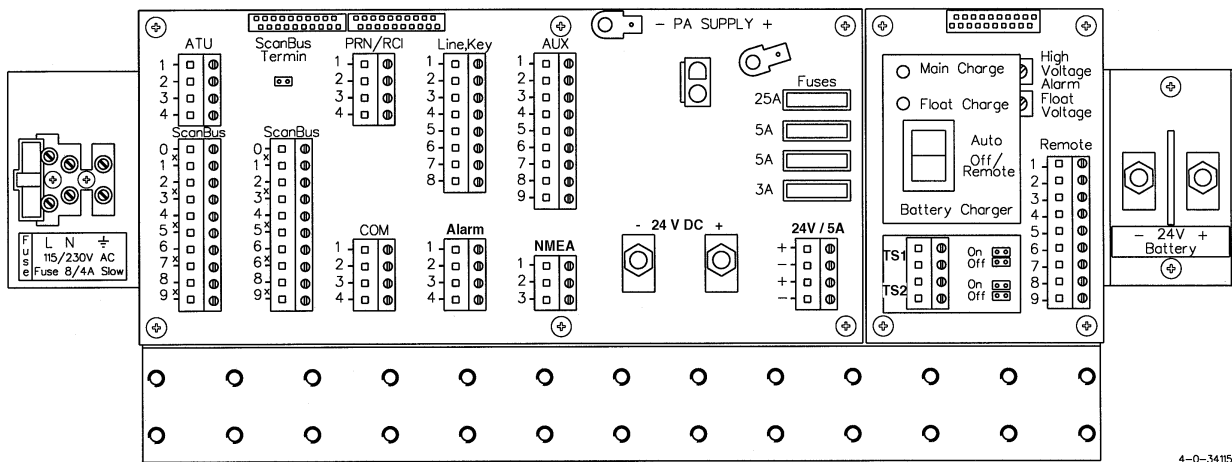

BATTERY CHARGER

This section applies if the optional Battery Charger Extension CH 2420 is installed.

The Charger Control Board contains a switch for local selection of automatic charging (**Auto**). In the **Off / Remote** position the charging function may be controlled remotely. Remote control cable is connected to the terminal strip marked **Remote** which also contains alarm outputs as indicated in the table below.

Remote

9-way terminal strip.

Battery charger alarm / control interface

Terminal	Designation	Description
1	DC-	Reference, battery -. Galvanically isolated from system ground.
2	VR	Output 26-28 V DC (battery +) when AC and battery voltage are both present. Max. 200 mA, internally protected. Galvanically isolated from system ground.
3	Auto	Input. Charger off when open, charger on when connected to DC+
4	AC Alarm O	Galvanically isolated AC alarm output. Relay contacts, max. 0.5 A 32 V
5	AC Alarm C	Alarm condition: AC supply missing (terminals 5 and 6 are closed, terminals 4 and 6 are open in alarm condition)
6	AC Alarm	
7	Bat Alarm O	Galvanically isolated battery alarm output. Relay contacts, max. 0.5 A 32 V
8	Bat Alarm C	Alarm conditions: Battery voltage <23.4 V or
9	Bat Alarm	Battery voltage > 27 - 32 V (adjustable) (terminals 8 and 9 are closed, terminals 7 and 9 are open in alarm condition)

Where the ambient temperature of the battery is expected to be very variable, the life of the battery may be increased by controlling the charging voltage as a function of the temperature.

Two temperature sensors may be connected to the Charger Control Board for temperature compensation, one for the float charging voltage, the other for the independent High Voltage Alarm

Circuit. The temperature sensors should be installed in close proximity to the battery.

TS1

2-way terminal strip

Temperature Sensor input for float charging voltage.

Terminal	Designation	Description
1	TS+	Temperature sensor input for battery temperature compensation. Jumper must be moved to
2	TS-	TS1 ON when used.

TS2

2-way terminal strip

Temperature Sensor input for high voltage alarm.

Terminal	Designation	Description
1	TS+	Temperature sensor input for battery temperature compensation. Jumper must be moved to
2	TS-	TS2 ON when used.

Important: When temperature sensors are not installed, jumpers must be in Off position.

EARTH CONNECTIONS

Antenna Tuning Unit

As the earth connection of a transmitter is a very important part of the antenna system, it is of the utmost importance to keep in mind that the earth connection of the Antenna Tuning Unit must have the lowest possible RF-impedance. Losses in the earth connection will result in a decrease in radiated power which means that the range of the transmitter will be reduced. In steel ships a 100 x 0.5 mm copper strap as short as possible is connected between the earth terminal at the bottom of the Antenna Tuning Unit and two or three 1/2" or M12 bolts welded to the superstructure. Vessels constructed of non-conducting materials must be equipped with a copper earth plate having a minimum area of 1 square metre mounted below the water line. From a copper earth bolt hard soldered to the earth plate a 100 x 0.5 mm copper strap is run, preferably uninterrupted to the earth terminal at the bottom of the Antenna Tuning Unit.

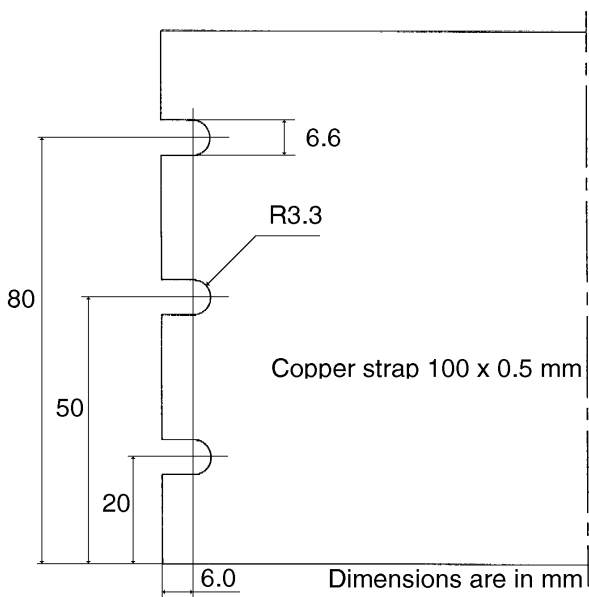

fig.11

Should it be necessary to break the copper strap, for example to pass through a deck, two or three 1/2" or M12 bolts should be used for this feed through.

On wooden ships having a superstructure of metal, this superstructure should also be effectively connected to the copper strap by using stainless steel bolts and preferably pieces of stainless steel strips between the metal parts.

On fibre glass boats, such as yachts and sailing boats, it may be difficult to install a sufficiently good earth. Short copper straps are bolted to conducting parts on the engine, the keel and other conducting objects. Many copper straps can be glued to the inner surface of the hull below the water line to produce a large capacitance to the water. It is important that the total area of copper is large and that the distance between the copper surface and the water is as small as possible. The copper straps are connected directly to the ATU.

Transceiver Unit

The Transceiver Unit is preferably grounded separately to the ships metal in the shortest possible way. A 10 to 16mm sq. ground wire is connected to the ground terminal (cable clamp) at the bottom of the unit. On vessels with no metallic superstructure the ground connection may be omitted.

ANTENNAS

The standard equipment is used with common transmitting and receiving antenna. The antenna should be erected in the open, away from conducting object such as derricks etc. which may cause reduction of the radiated power. Insulators should be of the best type having low leakage even when wet. Stays, wires, steel masts etc. should be either effectively earthed or insulated. The antenna should also be kept as far away as possible from electrical equipment in order to minimize noise. Electrical installation such as cable braiding (screens) and instruments in the vicinity of the antenna should be earthed effectively, and the instruments in question should be fitted with noise-interference suppression devices, effective in the range 0.1 MHz to 30 MHz to avoid malfunction of these instruments. The Antenna Tuning Unit will tune on any frequency in the range 1.6 to 30 MHz to wire and/or whip antennas of 7 to 18 metres total length. If possible long antenna should be installed to avoid reduction of the radiated power in the lower frequency bands. Short antennas of 7 metres length should therefore only be installed where it is impossible to install a longer and more efficient antenna.

The antenna is terminated at the insulator at the top of the Antenna Tuning Unit. The insulator must be relieved from mechanical stress by using max. 1 metre flexible wire between the insulator and a support (fig.15). To maximize the radiated power and avoid flash over keep distance to metal parts as long as possible. All wire junctions in the antenna system must be made with cable lugs of correct size according to the wire gauge. This will prevent bad connections due to corrosion. For further corrosion proofing silicone grease may be applied to the cable joints.

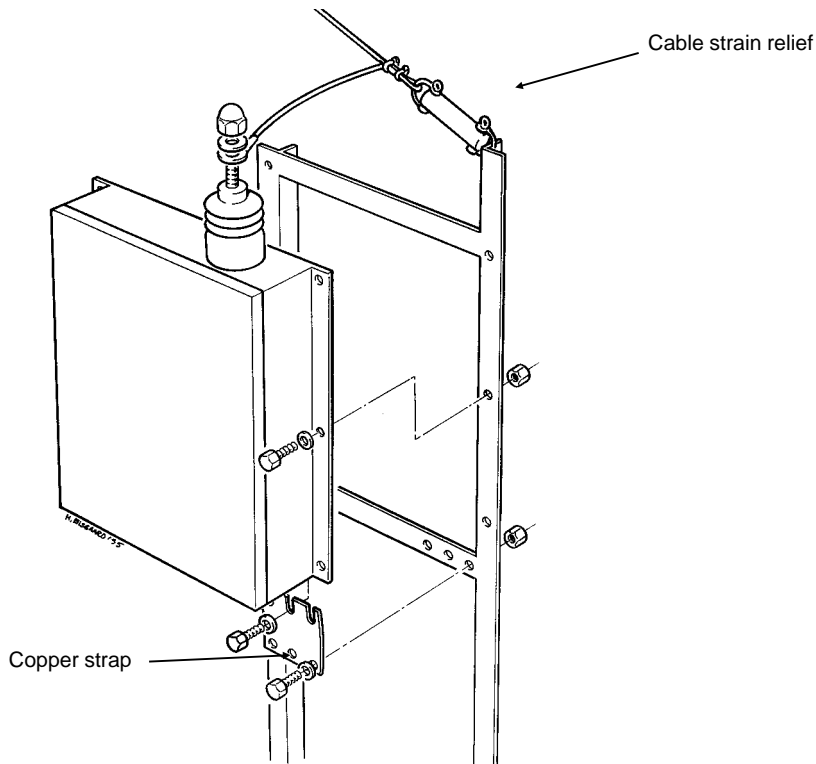
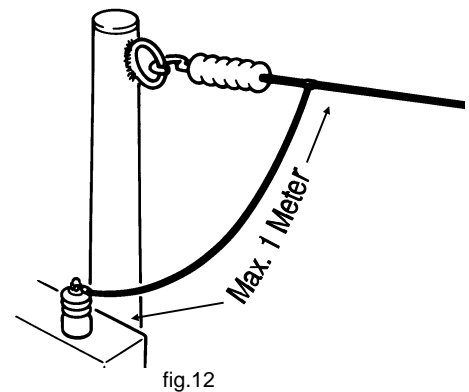

fig.13
Mount the ATU on a custom-built bracket made from iron angle bars

INTERCONNECTION OF UNITS

Handset-to-Transceiver Control Unit connection

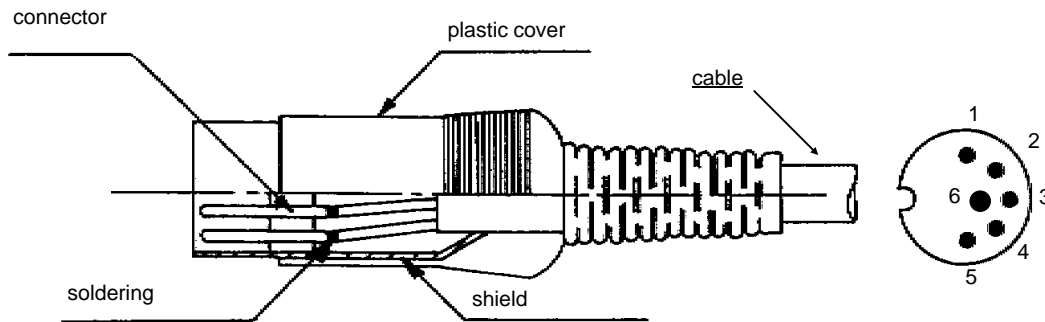

fig.14

HANDSET CON Terminal no.	Designation	Remarks
1	HOOK ON	Low when handset is placed in the holder
2	HANDSET KEY	Low when handset key is pressed
3	+12V	
4	MIC	0-1.6Vpp Adjustable +/-8dB.
5	EARPIECE	Max. 2.1Vpp
6	GND	

Transceiver Control Unit-to-Transceiver Unit connections

The cable at the Transceiver Control Unit is prepared by soldering D-sub connectors at both ends as described below.

At the Transceiver Unit the cable is connected to one of the terminal strips marked "ScanBus".

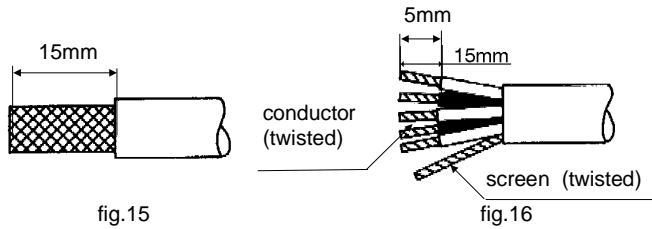

Before contacts of plug are soldered: slide the plastic cover over the cable.

Contact arrangement
(viewed from solder side)

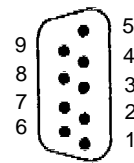

fig.18

After the contacts are soldered: latch the inner and outer shields into the connectors from the rear and snap in. Finally slide the plastic cover over the shield and fix the two jack screws into the plastic cover.

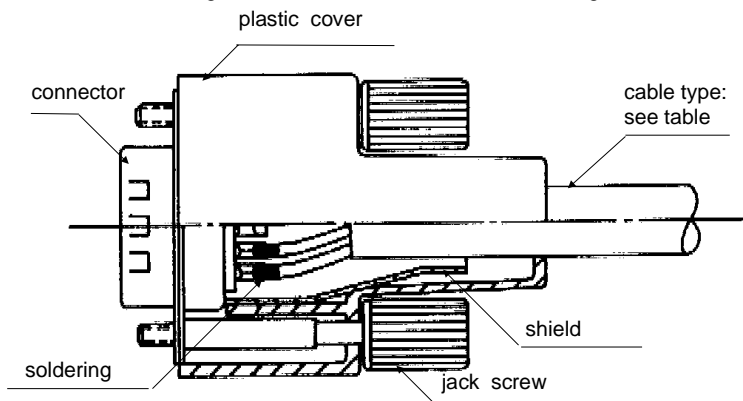

fig.17

'ScanBus'			
TU Terminal no.	TCU Connector pin no.	Designation	Remarks
0	6	GND	System GND
1	1	Supply On	Common 'supply on' signal for all xCUs on the 'ScanBus'. Active when connected to ground
2	2	Data+	Data communication between units. CAN Net. Baud rate: 76.8 kb/s. Spec.: ISO/DIS 11898
3	3	Data-	
4	4	AF+	TX AF modulation including CW/TLX Tone Key. Vnom = 0.775 Vrms diff.. Vmax= 12V Vpp diff.
5	5	AF-	
6	6	GND	System GND
7	7	+24V	Supply voltage for all xCUs on the 'ScanBus'
8	8	RXAF+	RX AF signal. Vnom = 0.775 Vrms diff.. Vmax= 12V Vpp diff.
9	9	RXAF-	
Cable clamp	Shield	Screen	Screen connected to System GND.

The ScanBus termination jumper must be inserted (pos. 1) if the unit is at the end of the chain - or removed (pos.2) if the unit is not at the end of the chain.

Transceiver Unit-to-Antenna Tuning Unit connection

The units are interconnected by an RG-213/U coaxial cable and a 4 x 0.5 mm² screened multiwire cable with a maximum length of 100 metres. The coaxial cable is terminated in a UHF-connector (PL 259 type) at the Transceiver Unit and connected to the socket marked "TX/RX". The multiwire cable is connected to the terminal strip marked ATU on the connection board.

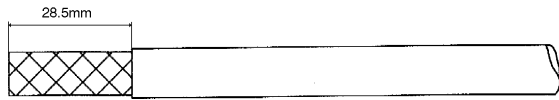

fig.20

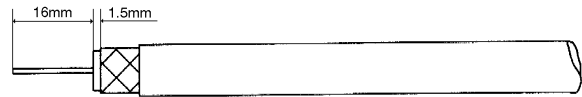

fig.21

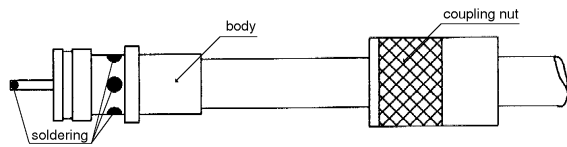

fig.22

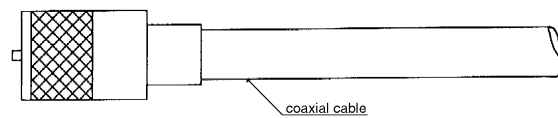

fig.23

At the Antenna Tuning Unit both cables are connected to terminal strips. Remember to fit the rubber gasket on the cables before connecting.

fig.19

'ATU'			
TU TS no.	ATU TS no.	Designation	Description
1	1	+24V	+24V supply voltage to ATU
2	2	TX/RX, PROTEC	TX/RX signalling from TU and protection signalling from ATU
3	3	-TU-ATU DATA	Bi-directional serial data communication, 0/24V
4	4	GND	System GND

Use a second wrench for backstop when fastening the Antenna Horn nut

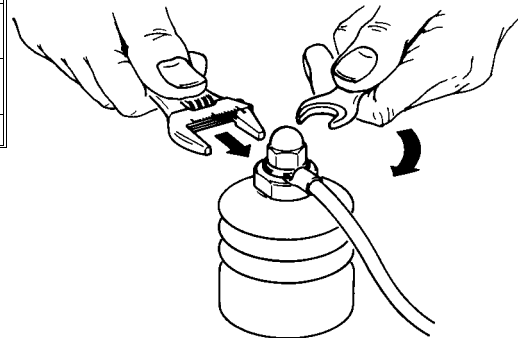

NOTE:

TRP 9250 may be operated without the ATU 9250. Just connect the 50 ohms antenna system to the coaxial socket marked "TX/RX" at the Transceiver Unit .

Important:

In installations with long earth straps to the Antenna Tuning Unit, high RF voltages may be present on the ATU ground terminal. To avoid this voltage being coupled to the Transceiver Unit the coaxial cable must be run from the Transceiver Unit to the point where the copper strap from the Antenna Tuning Unit is connected to earth. From this point the coaxial cable must follow the copper strap to the Antenna Tuning Unit. The coaxial cable should be placed upon the centre of the copper strap to ensure good coupling. The part of the cable-run between earth and the Transceiver Unit must not be run in parallel with the earth strap within a distance of at least 1 metre.

CONNECTORS FOR EXTERNAL EQUIPMENT

Transceiver Control Unit connector panel

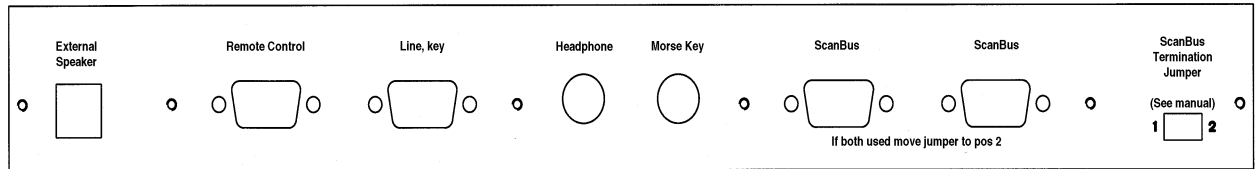

Remote Control

Control signals from a computer system or a external telex/DSC modem.
Protocol is NMEA or T-Bus

The cable is prepared at TCU end by soldering a D-sub connector as described below.

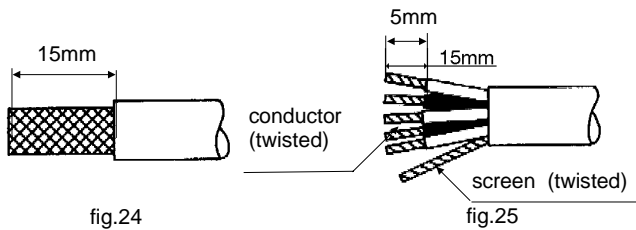

Before contacts of plug are soldered: slide the plastic cover over the cable.

Contact arrangement
(viewed from solder side)

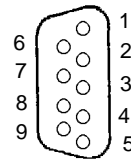

After the contacts are soldered: latch the inner and outer shields into the connectors from the rear and snap in. Finally slide the plastic cover over the shield and fix the two jack screws into the plastic cover.

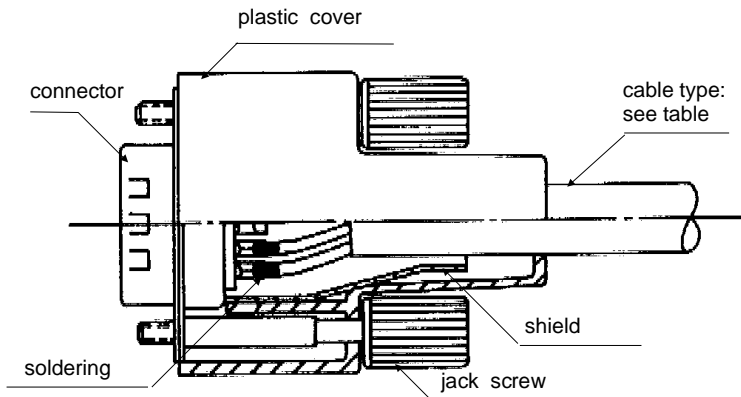

fig.26

'Remote Control'. Equipment connector 9 way D-sub male.		
Pin	Designation	Description
1	DCD	Input. Data Carrier Detected or Scan S/S
2	RXD	Input. Receive Data.
3	TXD	Output. Transmit Data.
4	nc	No connection.
5	RCI-GND	Galvanic isolated ground return for Remote Control Interface. Not connected to system ground
6	nc	No connection.
7	nc	
8	nc	
9	RI	Input. Ring indicator.
-	Screen	Cable screen. Connected to system ground.

Line, Key

The Remote Control audio and key signals.

The cable is prepared at TCU end by soldering a D-sub connector as described below.

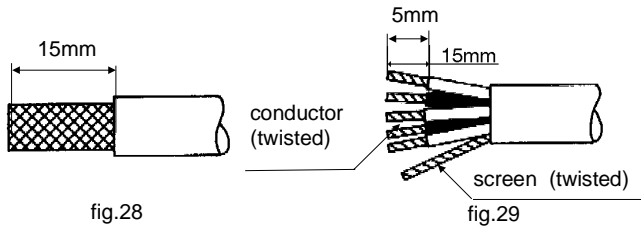

Before contacts of plug are soldered: slide the plastic cover over the cable.

Contact arrangement
(viewed from solder side)

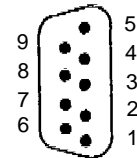
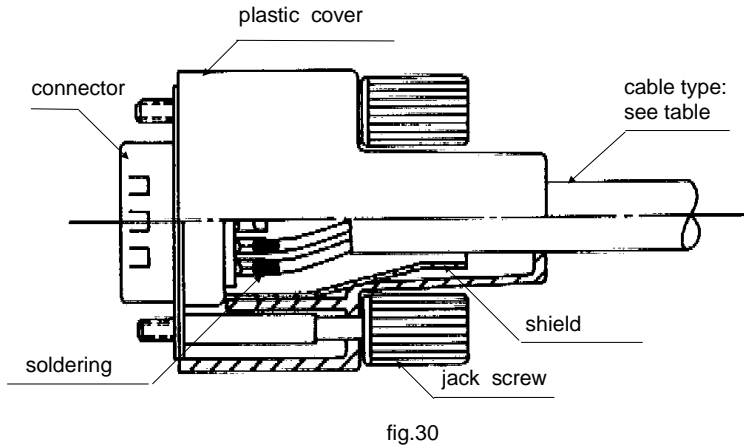

fig.31

, +, +
, +, +
, +, +
, +, +

, +, +

'Line, Key'. Equipment connector 9 way D-sub female.		
Pin	Designation	Description
1	Line In +	Balanced 600 Ohm 0 dBm line input. Accepts -15 dBm to +10 dBm.
6	Line In C	
2	Line In -	Balanced 600 Ohm 0 dBm line output. Adjustable from -15 dBm to +10 dBm.
3	Line Out +	
8	Line Out C	
4	Line Out -	Galvanic isolated external key input. Pulled up to +12V. Active when pulled down to RCI-GND.
5	'Key'	
9	RCI-GND	No connection.
7	nc	
-	Screen	Cable screen. Connected to system ground.

External Speaker

Pluggable Terminal strip

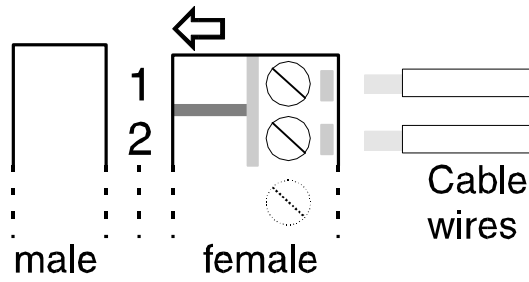

'External Speaker'. Equipment connector 2 way pluggable terminal strip male.		
Pin	Designation	Description
1	SPK+	Output. 5 watt into 8 ohms. 4 ohms speaker may be connected.
2	SPK-	

Headphone
for CW operation

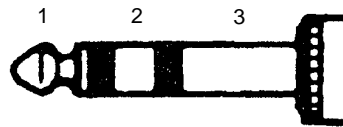

'Headphone'. Stereo jack female .		
Pin	Designation	Description
1	H-phone+	Output. Hot left and right headphone drive signal.
2	H-phone+	
3	H-phone-	Output. Common left and right headphone drive signal.

Morse Key
for CW operation

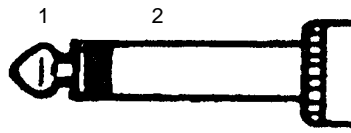

'Morse Key'. Mono jack female		
Pin	Designation	Description
1	Morse Key	Input. Pulled up to +12v. Activated when connected
2	GND	to system ground

Transceiver Unit Connection Board

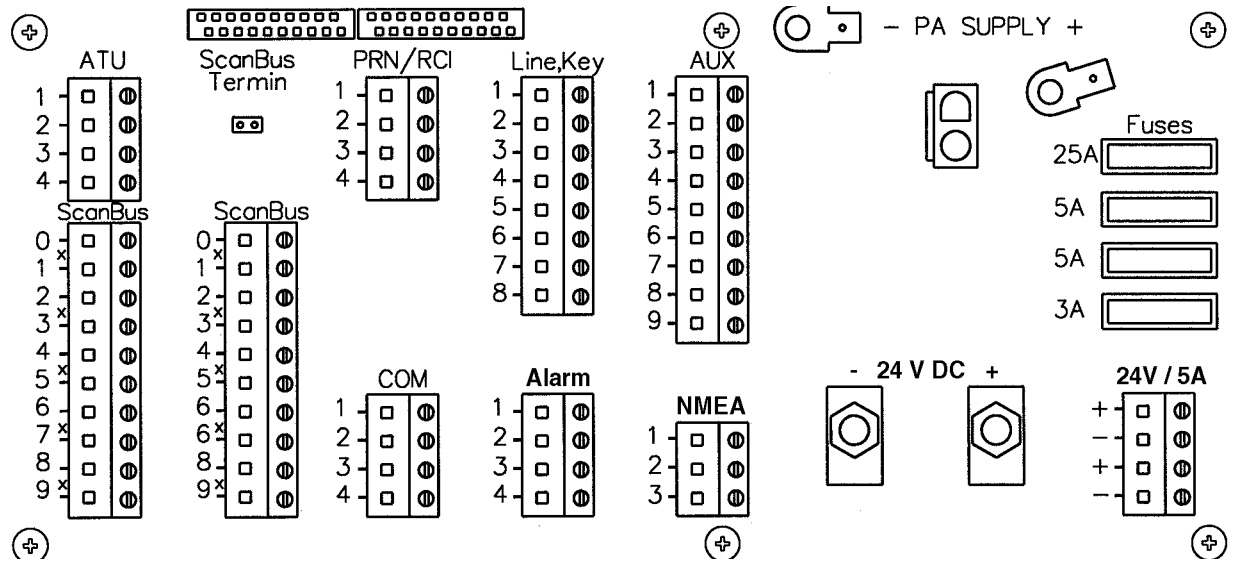

COM

4 way terminal strip
 Serial interface compatible with RS-232 for
 SCANCOMM control (PC - PCP protocol, Internal Telex modem)
 Baud rate 9600 bps
 PCB 717S must be installed**

COM		
Terminal	Designation	Description
1	PC TX	Galvanically isolated output. Transmit Data
2	PC RX	Galvanically isolated input. Receive Data
3	PC DTR	Galvanically isolated input. Data Terminal Ready*
4	PC GND	Galvanically isolated ground return

*) The interface is opto-isolated with driver power delivered from PC DTR, 5 - 15 V.
 (Non-isolated: Insert jumpers J8, J9 and J13 on PCB 717S)

***) PCB 718S installed:
 Remote control interface for radio control using T+Bus or NMEA protocol.

PRN / RCI

4 way terminal strip.

RS-232 com-port for controlling a serial interface DSC printer.

Baud rate: 300, 600, 1200, 2400, 4800 or 9600 pbs

or

Remote Control Interface for radio control using T+Bus Protocol.

Baud rate: 2400 bps

PCB 717S must be installed.

PRN/RCI.		
Terminal	Designation	Description
1	RXD	Input. Receive Data
2	TXD	Output. Transmit Data
3	DTR	Output. Data Terminal Ready.
4	GND	Ground return. Connected to system ground.

Line, Key

8 way terminal strip.

AF line input/output and external key interface.

PCB 717S must be installed.

Line, Key		
Terminal	Designation	Description
1	Line In +	Balanced 600 Ohm 0 dBm AF line input with centre tap. Galvanically isolated. Accepts -15 dBm to +10 dBm.
2	Line In C	
3	Line In -	
4	Line Out +	Balanced 600 Ohm 0 dBm AF line output with centre tap. Galvanically isolated. Adjustable from -15 dBm to +10 dBm.
5	Line Out C	
6	Line Out -	
7	'Ext Key'	Transmitter key input. Active when connected to GND. Internal pull-up, 12V / 1.8kohm (RS-410N).
8	GND	

Alarm

4 way terminal strip.

DSC Distress Alarm Box interface.

PCB 717S must be installed.

ALARM		
Terminal	Designation	Description
1	'Alarm In'	Distress button input. Internal pull-up, 12V / 1.8kohm (RS-410N). Active when connected to GND. Distress call (undesignated) is initiated when activated for 5 seconds and released within 10 seconds.
2	GND	
3	'Alarm 1'	Distress Lamp output. Open collector (RS-410N). Max 50 mA, 32 V. Connects to GND when active. Output. Max 50 mA. Internally protected.
4	+24V	

NMEA

3 way terminal strip

NMEA 0183 interface for navigation equipment.

Baud rate: 4800 bps

PCB 717S must be installed.

NMEA		
Terminal	Designation	Description
1	NMEA RX+	Galvanically isolated input.
2	NMEA RX-	
3	Screen	Not connected.

Navigation equipment complying with the NMEA 0183/IEC 1162 standard may be connected for automatic updating of the position information used by the DSC/Telex modem.

The NMEA receive circuit consists of an opto-isolator with a 3.3 kohms series resistor to insure current mode operation and a shunt diode to limit reverse bias. The circuit is isolated from earth. The circuit operates with a minimum differential input voltage of 2 volts. The maximum voltage is 15 volts, compatible with RS-232 levels.

Interconnection between devices may be by means of two-conductor shielded twisted-pair wire. Multiple listeners may be connected to a single talker. The receivers are connected in parallel. The shield should be connected to the navigator chassis and should not be connected at any listener. However the shield should be continuous (unbroken) between all listeners.

Following NMEA 0183/IEC 1162 sentences are recognized by the equipment for extraction of position and associated time information: GGA, GLL, GXP, GDP, GLP, GOP.

AUX

9 way terminal strip
 Auxiliary input / output

AUX		
Terminal	Designation	Description
1	On-Hook	Output. Connects to GND when handset is off the hook. Open collector (RS-410N). Max 50 mA, 32 V.
2	Scan S/S	Scan Start/Stop input for user-programmable Scan and Sweep programmes. PCB 717/718S required. Internal pull-up, 12V / 1.8kohm (RS-410N).
3	GND	
4	'2182 SEL'	Output. Connects to GND when 2182 kHz is selected. Open collector (RS-410N). Max 50 mA, 32 V.
5	'TX KEYED'	Output. Connects to GND when transmitter is keyed. Delay setting by jumper J3 on DC Power Supply / Interface Board Open collector (RS-410N). Max 50 mA, 32 V.
6	'Alarm 2' (Telex Alarm)	Output. Connects to GND when alarm is on. Open collector (RS-410N). Max 50 mA, 32 V.
7	+24V	Output. Max 200 mA. Internally protected.
8	'RX Mute' / 'TX Inhibit'	Input. Function setting by jumper J2 on DC Power Supply / Interface Board. Receiver muted or transmitter inhibited when connected to GND. Internal pull-up, 12V / 1.8kohm (RS-410N).
9	GND	

24 V / 5A

2 way terminal strip (2 pcs)
 24 V supply output for printer, PC or VHF equipment.

24 V / 5 A		
Terminal	Designation	Description
1	+	21.6 - 31.2 v output. Max 5 A total for both terminal strips. Protected by 5 A fuses in both + and -. Galvanically connected to battery
2	-	Must not be connected to GND

Final Installation Check

For operation of the equipment please refer to chapter 2. Note that an appropriate programmed Configuration PROM must be installed in the Transceiver Unit, see section on page 3-xx.

The Antenna Tuning Unit will tune automatically to the antenna first time the equipment is keyed on a new frequency or when the "TX Tune" button is pressed. During the tune sequence and normal transmission all transmitter circuits are monitored to ensure safe operating conditions. If transmission conditions are bad (bad antenna installation, high temperatures, etc.) the transmitted power will be reduced to a safe limit. If the transmission condition is improved automatic recovery to full power takes place.

The reason for the protection can be investigated by pressing "Prog" "22" "Enter" (Read Protection Code). The displayed protection code(s) is described on page @ of this manual.

If transmission conditions becomes too severe (a broken antenna, too high temperature, etc.) or a fault occurs in the equipment the "Protec" annunciator will flash in the display, indicating that radiated power no longer can be maximized. The output power will be reduced or totally switched off. When such a condition occurs, read the Protection Code as described above to investigate the nature of the fault.

Installation of optional Telex Filter

To enable telex/DSC operation a receiver crystal filter must be installed in position 'Option Filter' on PCB 'RX/EX Signal Path 715' in the Transceiver Unit. The centre frequency of the filter must be 455kHz and the bandwidth must be in accordance with baud rate and frequency shift of the transmission. The centre audio input/output frequency is adapted to the associated telex modem by programming of Telex Subcarrier. See 2-62 Configuration.

To install the filter remove the cover of the Transceiver Unit and unplug the ribbon cables and the coaxial cables from PCB 715S. Loosen the two screws from the module and remove it.

Locate position 'Option Filter' on the PCB. Mount the telex filter in that position and solder the terminations. Reassemble the Transceiver Unit. Fitting the filter in position 'OptionFilter' along with either the PCP 717S or the Interface-A 718S automatically enables the "TLX" key on the Transceiver Control Unit front panel and telex/DSC operation may now be tested.

Installation of Master Oscillator

Higher frequency stability is obtained by installing a different type of Master Oscillator. To install a new Master Oscillator remove the cover of the Transceiver Unit and unplug the ribbon cables and the coaxial cables from the Synthesizer Board 911. Loosen the two screws of the module and remove it. Locate the shielding box on the PCB containing the Master Oscillator. Remove the box lid and exchange Master Oscillators. Reassemble the Transceiver in the reverse order.

CONFIGURATION PROM

The TRP 9250 series Configuration PROM contains frequencies, frequency bands and system configuration parameters for customizing the equipment.

Legal frequencies with corresponding legal mode and frequency bands are programmed in the PROM address area from 256d/0100h to 7167d/1BFFh. The PROM area is divided into three sub-areas, each with a specific frequency information and representation.

256d/0100h to 4095d/0FFFh:

PROM area reserved for customer specified frequencies. Up to 959 single or simplex frequencies or up to 479 duplex frequencies may be programmed in the 4-byte **Frequency Record Format**. The first 200 single, simplex or duplex frequencies including their corresponding mode can be recalled directly via the keyboard as successively short-numbers (200 to 399) are assigned. If a limited transmitter frequency range is wanted one or more frequency bands may be programmed in this PROM area, using the 8-byte **Frequency Band Format**. A **Limitier Byte** containing 255d/FFh must be programmed to indicate the end of frequency information.

4096d/1000h to 5119d/13FFh:

PROM area reserved for GMDSS Distress and Safety Frequencies and other safety frequencies. The frequencies and their corresponding mode can be recalled with short-numbers from 100 to 199, which are successively assigned. The PROM area will contain up to 256 single or simplex frequencies or 128 duplex frequencies represented in the 4-byte **Frequency Record Format**. If the whole PROM area is not filled, a **Limitier Byte** containing 255d/FFh must be programmed to indicate the end of frequency information.

5120d/1400h to 7167d/1BFFh:

This PROM area contains all ITU SSB channels and DSC and Telex TX frequencies. All ITU SSB channels can be recalled directly with the mode automatically set to SSB by using the ITU channel number as short-number. SSB ITU channels without number can also be recalled as successively higher numbers are assigned. The frequencies are represented in the 11-byte **Fixed Step Frequencies Format**. A **Limitier Byte** containing 255d/FFh must always be programmed to indicate the end of frequency information.

7168d/1C00h to 8191d/1FFFh:

System configuration parameters are programmed in the higher part of the PROM from 8191d/1FFFh and downwards.

PROM Type: 27C64, 200nS, 8K x 8

PROM Location: Transceiver Unit, TU Control Board 910

Configuration PROM Map:

Address		Contents
dec	hex	
0	0000	Not usable
255	00FF	
256	0100	
		Customer Specified Frequencies TX Band Limits. Versions 9500, 01, 02
xxxx	xxxx	Limiter Byte 255d / FFh
4095	0FFF	GMDSS Distress and Safety Frequencies
4096	1000	
xxxx	xxxx	Limiter Byte 255d / FFh
5119	13FF	ITU Channels (SSB) ITU DSC and Telex TX Frequencies
5120	1400	
xxxx	xxxx	Limiter Byte 255d / FFh
7167	1BFF	System Configuration Parameters
7168	1C00	
8191	1FFF	

Frequency Record Format

	D7	D6	D5	D4	D3	D2	D1	D0
Addr n	RX	TX	S-F	0	Modulation			
n+1	BCD X 10MHz				BCD X 1MHz			
n+2	BCD X 100kHz				BCD X 10kHz			
n+3	BCD X 1kHz				BCD X 100Hz			

Single-, Simplex- and Duplex-frequencies can be mixed and recalled with the short-numbers 100 to 199 and 200 to 399 if their relative position in the tables do not exceed 100 and 200 respectively.

RX, TX and S-F bits:

RX and TX bits indicates receiver and transmitter frequency respectively.

S-F bit indicates a Single Frequency (RX or TX) which may be recalled with a short-number.

Examples:

D7	D6	D5
RX	TX	S-F

1	0	0	Receiver part of duplex frequency
0	1	0	Transmitter part of duplex frequency
1	1	0	Simplex frequency
1	0	1	Single receiver frequency which can be recalled with a short-number
0	1	1	Single transmitter frequency which can be recalled with a short-number
0	0	1	Empty channel which occupy a short-number

D4: Always set to 0.

Modulation nibble:

- 0: SSB (USB)
- 1: LSB
- 2: R3E
- 3: AM
- 4: CW
- 5: TLX (Telex, DSC)
- 6: Reserved for future use
- 7: SSB + R3E
- 8: Reserved for future use
- 9: Reserved for future use
- A: Reserved for future use
- B: Reserved for future use
- C: Reserved for future use
- D: Reserved for future use
- E: Reserved for future use
- F: Don't care

Fixed Step Frequencies Format

		D7	D6	D5	D4	D3	D2	D1	D0
Addr	n	RX	TX	ITU	0	Modulation			
	n+1	Start Channel							
	n+1	BCD X 1000				BCD X 100			
	n+2	BCD X 10				BCD X 1			
	n+3	Number Of Channels							
	n+3	BCD X 1000				BCD X 100			
	n+4	BCD X 10				BCD X 1			
	n+5	Start Frequency							
	n+5	BCD X 10MHz				BCD X 1MHz			
	n+6	BCD X 100kHz				BCD X 10kHz			
	n+7	BCD X 1kHz				BCD X 100Hz			
	n+8	BCD X 10Hz							
	n+9	Step Frequency							
	n+9	BCD X 10kHz				BCD X 1kHz			
	n+10	BCD X 100Hz				BCD X 10Hz			

A large group of frequencies with uniform channel spacing are easily represented by programming the 11-byte Fixed Step Frequencies Format.

RX and TX bits:

- 0: Frequencies do not apply to RX or TX respectively.
 - 1: Frequencies apply to RX or TX respectively.
- Both bits are set to "1" for simplex frequencies.

ITU bit:

- 0: The programmed frequencies are not ITU channels.
- 1: The programmed frequencies are ITU channels and if the mode is SSB (Modulation nibble: 0 or 7) they can be recalled with the ITU short-number.

D4:

Always set to 0.

Modulation nibble:

- 0: SSB (USB)
- 1: LSB
- 2: R3E
- 3: AM
- 4: CW
- 5: TLX (Telex, DSC)
- 6: Reserved for future use
- 7: SSB + R3E
- 8: Reserved for future use
- 9: Reserved for future use
- A: Reserved for future use
- B: Reserved for future use
- C: Reserved for future use
- D: Reserved for future use
- E: Reserved for future use
- F: Don't care

Start Channel:

The start channel number for the group.
E.g. 401 for the ITU channel 401.

Number Of Channels:

The total number of frequencies or channels in the group. Legal numbers: 1 to 9998.

Start Frequency:

The first frequency in the group.

Step Frequency:

The fixed frequency- or channel-spacing for the group.

Frequency Band format

		D7	D6	D5	D4	D3	D2	D1	D0
Addr	n	Always 0				Always 0			
	n+1	BCD X 10MHz				BCD X 1MHz			
	n+2	BCD X 100kHz				BCD X 10kHz			
	n+3	BCD X 1kHz				BCD X 100Hz			
	n+4	Always 0				Always 0			
	n+5	BCD X 10MHz				BCD X 1MHz			
	n+6	BCD X 100kHz				BCD X 10kHz			
	n+7	BCD X 1kHz				BCD X 100Hz			

By programming a Frequency Band the transmitter frequency range may be limited to the specified band and transmission outside the band is inhibited. The first 4 bytes specifies the lower legal frequency limit and the next 4 bytes specifies the upper legal frequency limit. Several bands may be programmed.

Limiter byte

If the programmed Frequencies and possible Frequency Bands do not use all the available bytes in the relevant PROM areas a Limiter Byte must be programmed to indicate the end of frequency information.

The Limiter Byte contains the value 255d / FFh.

Pre-programmed ITU frequencies

GMDSS Distress and Safety Frequencies

Freq. kHz	Designation	Mode	Type	RCL
2182.0	J3E Distress Safety	SSB	Simplex	100
2174.5	NBDP Distress Safety	TLX	Simplex	101
2187.5	DSC Distress Safety	TLX	Simplex	102
4125.0	J3E Distress Safety	SSB	Simplex	103
4177.5	NBDP Distress Safety	TLX	Simplex	104
4207.5	DSC Distress Safety	TLX	Simplex	105
6215.0	J3E Distress Safety	SSB	Simplex	106
6268.0	NBDP Distress Safety	TLX	Simplex	107
6312.0	DSC Distress Safety	TLX	Simplex	108
8291.0	J3E Distress Safety	SSB	Simplex	109
8376.5	NBDP Distress Safety	TLX	Simplex	110
8414.5	DSC Distress Safety	TLX	Simplex	111
12290.0	J3E Distress Safety	SSB	Simplex	112
12520.0	NBDP Distress Safety	TLX	Simplex	113
12577.0	DSC Distress Safety	TLX	Simplex	114
16420.0	J3E Distress Safety	SSB	Simplex	115
16695.0	NBDP Distress Safety	TLX	Simplex	116
16804.5	DSC Distress Safety	TLX	Simplex	117
5680.0	J3E Coordinated SAR	SSB	RX freq	118
490.0	NBDP Meteorology Nav	TLX	RX freq	119
518.0	NBDP Navtex	TLX	RX freq	120
4209.5	NBDP Navtex	TLX	RX freq	121
4210.0	NBDP Safety	TLX	RX freq	122
6314.0	NBDP FC Safety Info	TLX	RX freq	123
8416.5	NBDP FC Safety Info	TLX	RX freq	124
12579.0	NBDP FC Safety Info	TLX	RX freq	125
16806.5	NBDP FC Safety Info	TLX	RX freq	126
19680.5	NBDP FC Safety Info	TLX	RX freq	127
22376.0	NBDP FC Safety Info	TLX	RX freq	128
26100.5	NBDP FC Safety Info	TLX	RX freq	129

May be recalled directly by entering the relevant number from 100 to 129. Mode will automatically be set according to the table.

TRP 9250: Subsequent selection of other modes will disable the transmitter except when the mode is SSB and R3E is selected.

Ship station RX and TX frequencies for SSB duplex operation in the Maritime Mobile Bands between 4 and 27.5MHz.

ITU Radio Regulations Appendix 16, Section A.

HF Duplex Telephony Channels:

Ch. 401 - 427	Ch. 428 - 429
Ch. 601 - 608	
Ch. 801 - 833	Ch. 834 - 837
Ch. 1201 - 1241	
Ch. 1601 - 1656	
Ch. 1801 - 1815	
Ch. 2201 - 2253	
Ch. 2501 - 2510	

243 RX/TX frequency pairs

6 RX frequencies

May be recalled directly by entering ITU channel number. Mode will automatically be set to SSB.

TRP 9250: Subsequent selection of other modes except R3E will disable the transmitter.

Inter-ship SSB Simplex frequencies in the Maritime Mobile Bands between 4 and 27.5MHz.

Successive channel numbers are assigned.

ITU Radio Regulations Appendix 16, Section B.

HF Simplex Telephony Frequencies.

Ch. 430 - 431
Ch. 609 - 611
Ch. 838 - 839
Ch. 1242 - 1246
Ch. 1657 - 1663
Ch. 1816 - 1822
Ch. 2254 - 2260
Ch. 2511 - 2517

40 Simplex frequencies

May be recalled directly by entering channel number. Mode will automatically be set to SSB.

TRP 9250: Subsequent selection of other modes except R3E will disable the transmitter.

Ship station SSB TX frequencies in the 4000 - 4063kHz band. Successive channel numbers are assigned.

ITU Radio Regulations Appendix 16, Section C-1.

HF TX Telephony Frequencies

Ch. 432 - 452

21 TX frequencies

May be recalled directly by entering channel number. Mode will automatically be set to SSB.

TRP 9250: Subsequent selection of other modes except R3E will disable the transmitter.

Ship station SSB TX frequencies in the 8100 - 8195kHz band. Successive channel numbers are assigned.

ITU Radio Regulations Appendix 16, Section C-2.

HF TX Telephony Frequencies

Ch. 840 - 870

31 TX frequencies

May be recalled directly by entering channel number. Mode will automatically be set to SSB.

TRP 9250: Subsequent selection of other modes except R3E will disable the transmitter.

Extra frequencies for TRP 9250:

International ship station DSC TX frequencies for purposes other than distress and safety.

2177.0	2189.5	kHz
4208.0	4208.5	4209.0 kHz
6312.5	6313.0	6313.5 kHz
8415.0	8415.5	8416.0 kHz
12577.5	12578.0	12578.5 kHz
16805.0	16805.5	16806.0 kHz
18898.5	18899.0	18899.5 kHz
22374.5	22375.0	22375.5 kHz
<u>25208.5</u>	<u>25209.0</u>	<u>25209.5 kHz</u>

26 TX frequencies

For verification of TX frequency only. TX frequencies are only selectable in Telex mode. Subsequent selection of other modes will disable the transmitter.

Extra frequencies for TRP 9250:

National ship station MF DSC TX frequencies for purposes other than distress and safety.

2156.0	2156.5 kHz
2157.0	2157.5 kHz
2158.0	2158.5 kHz
<u>2159.0</u>	<u>2159.5 kHz</u>

8 TX frequencies

For verification of TX frequency only. TX frequencies are only selectable in Telex mode. Subsequent selection of other modes will disable the transmitter.

Extra frequencies for TRP 9250:

Ship station paired NBDP frequencies in the Maritime Mobile Bands between 4 and 27.5MHz. ITU Radio Regulations Appendix 32.

Paired Telex Frequencies.

4	MHz	Band	Ch.	1 - 19
6	MHz	Band	Ch.	1 - 34
8	MHz	Band	Ch.	1 - 40
12	MHz	Band	Ch.	1 - 156
16	MHz	Band	Ch.	1 - 193
18/19	MHz	Band	Ch.	1 - 45
22	MHz	Band	Ch.	1 - 135
<u>25/26</u>	<u>MHz</u>	<u>Band</u>	<u>Ch.</u>	<u>1 - 40</u>

662 frequency pair

For verification of TX frequency only. TX frequencies are only selectable in Telex mode. Subsequent selection of other modes will disable the transmitter.

Extra frequencies for TRP 9250:

Ship station non-paired NBDP frequencies in the Maritime Mobile Bands between 4 and 27.5MHz.
ITU Radio Regulations Apendix 33.

Non-paired Telex Frequencies.

4MHz Band	Ch.	1 - 10
6MHz Band	Ch.	1 - 23
8MHz Band	Ch.	1 - 36
12MHz Band	Ch.	1 - 34
16MHz Band	Ch.	1 - 39
18/19MHz Band	Ch.	1 - 11
22MHz Band	Ch.	1 - 45
<u>25/26MHz Band</u>	<u>Ch.</u>	<u>1 - 31</u>

229 TX frequencies

For verification of TX frequency only. TX frequencies are only selectable in Telex mode.
Subsequent selection of other modes will disable the transmitter.

Total number of frequencies: 1539

System Configuration Parameters

The System Configuration Parameters programmed in the higher part of the prom (reserved area 5120d/1400h to 8191d/1FFFh) determines the function of the equipment. The most important parameters for customizing the equipment are listed below. The parameters are global and cannot be changed by programming via the keyboard.

Designation

**Cold Boot Frequency
+ Mode Set-up**

Address	Data								Description
	D7	D6	D5	D4	D3	D2	D1	D0	
7593d/1DA9h	Always 0				RX Modulation				RX frequency
7594d/1DAAh	BCD X 10MHz				BCD X 1MHz				
7595d/1DABh	BCD X 100kHz				BCD X 10kHz				
7596d/1DACH	BCD X 1kHz				BCD X 100Hz				
7597d/1DADh	Always 0				TX Modulation				TX frequency
7598d/1DAEh	BCD X 10MHz				BCD X 1MHz				
7599d/1DAFh	BCD X 100kHz				BCD X 10kHz				
7600d/1DB0h	BCD X 1kHz				BCD X 100Hz				

Data for the Modulation nibble
see description of the Single
Frequency Format

Designation

Address Data
(decimal / hexadecimal)

Description

Max TX Power

7601d/1DB1h

Pm:

Maximum TX power = 20 x Pm W
Pm = values from 1d/01h to 25d/19h
corresponds to 20Watt to 500Watt

Security Code Enable

7602d/1DB2h

0d/00h:
1d/01h:

Disable Security Code
Enable Security Code
All other data are defaulted to 1d/01h

<u>Designation</u>	<u>Address</u> (decimal / hexadecimal)	<u>Data</u>	<u>Description</u>
Customer ID	7603d/1DB3h	ID:	Customer identification number ID: 0d/00h to 99d/63h
Power reduction by TX inhibit	7604d/1DB4h	0d/00h Pinh:	TX inhibit TX power by TX inhibit= 20 x Pinh W Pinh=values from 1d/01h to 25d/19h corresponds to 20Watt to 500Watt
Enable HST mode	7605d/1DB5h	0d/00h: 1d/01h:	Disable HST mode Enable HST mode All other data are defaulted to 1d/01h
Enable SSB mode	7606d/1DB6h	0d/00h: 1d/01h:	Disable SSB mode Enable SSB mode All other data are defaulted to 1d/01h
Enable LSB mode	7607d/1DB7h	0d/00h: 1d/01h:	Disable LSB mode Enable LSB mode All other data are defaulted to 1d/01h
Enable R3E mode	7608d/1DB8h	0d/00h: 1d/01h:	Disable R3E mode Enable R3E mode All other data are defaulted to 1d/01h
Enable CW mode	7609d/1DB9h	0d/00h: 1d/01h:	Disable CW mode Enable CW mode All other data are defaulted to 1d/01h

<u>Designation</u>	<u>Address</u> (decimal / hexadecimal)	<u>Data</u>	<u>Description</u>
Enable TLX mode	7610d/1DBAh	0d/00h: 1d/01h:	Disable TLX mode Enable TLX mode All other data are defaulted to 1d/01h
Reduce TX power below 4MHz	7611d/1DBBh	0d/00h: 1d/01h: 2d/02h:	Disable reduction 400 W 150 W All other data are defaulted to 0d/00h
Alarm test in Dummy Load	7612d/1DBCh	0d/00h: 1d/01h:	Disable test in Dummy Load Enable test in Dummy Load All other data are defaulted to 0d/00h
Enable RX in AM mode	7613d/1DBDh	0d/00h: 1d/01h:	Disable RX in AM mode Enable RX in AM mode All other data are defaulted to 1d/01h
Enable TX in AM mode	7614d/1DBEh	0d/00h: 1d/01h: 2d/02h: 255d/FFh:	Disable TX in AM mode Enable TX on 2182kHz only Enable TX on 2182 + 2200kHz only Free TX in AM mode All other data are defaulted to 255d/FFh
Distress mode	7615d/1DBFh	0d/00h: 3d/03h:	SSB mode when 2182 is pressed AM mode when 2182 is pressed All other data are defaulted to 3d/03h
Receiver frequency status	7616d/1DC0h	0d/00h: 1d/01h:	RX on PROM frequencies only Free RX frequency All other data are defaulted to 1d/01h

<u>Designation</u>	<u>Address</u> (d ecimal / h exadecimal)	<u>Data</u>	<u>Description</u>
Transmitter frequency status	7617d/1DC1h	0d/00h: 1d/01h:	TX on PROM frequencies only Free TX frequency All other data are defaulted to 1d/01h
Single sideband mode display	7618d/1DC2h	0d/00h: 1d/01h:	Display upper-sideband as USB Display upper-sideband as SSB All other data are defaulted to 1d/01h

Standard Programming

The Standard Programming shows how the different standard types are programmed unless otherwise agreed. Only the above described parameters are shown. A total PROM listing and Master PROM's are available on request.

Address	Data					
	TRP 9250	TRP 9251	TRP 9253	TRP 9254	TRP 9255	TRP 9257
7593d/1DA9h	0d/00h	0d/00h	0d/00h	0d/00h	0d/00h	0d/00h
7594d/1DAAh	2d/02h	2d/02h	2d/02h	17d/11h	17d/11h	2d/02h
7595d/1DABh	24d/18h	24d/18h	24d/18h	80d/50h	80d/50h	24d/18h
7596d/1DACH	32d/20h	32d/20h	32d/20h	0d/00h	0d/00h	32d/20h
7597d/1DADh	0d/00h	0d/00h	0d/00h	0d/00h	0d/00h	0d/00h
7598d/1DAEh	2d/02h	2d/02h	2d/02h	17d/11h	17d/11h	2d/02h
7599d/1DAFh	24d/18h	24d/18h	24d/18h	80d/50h	80d/50h	24d/18h
7600d/1DB0h	32d/20h	32d/20h	32d/20h	0d/00h	0d/00h	32d/20h
7601d/1DB1h	25d/19h	25d/19h	25d/19h	25d/19h	25d/19h	25d/19h
7602d/1DB2h	1d/01h	1d/01h	1d/01h	1d/01h	1d/01h	1d/01h
7603d/1DB3h	0d/00h	1d/01h	3d/03h	4d/04h	5d/05h	7d/07h
7604d/1DB4h	0d/00h	0d/00h	0d/00h	0d/00h	0d/00h	0d/00h
7605d/1DB5h	0d/00h	0d/00h	0d/00h	0d/00h	0d/00h	0d/00h
7606d/1DB6h	1d/01h	1d/01h	1d/01h	1d/01h	1d/01h	1d/01h
7607d/1DB7h	0d/00h	0d/00h	0d/00h	1d/01h	1d/01h	0d/00h
7608d/1DB8h	1d/01h	1d/01h	1d/01h	1d/01h	1d/01h	1d/01h
7609d/1DB9h	0d/00h	0d/00h	0d/00h	0d/00h	1d/01h	1d/01h
7610d/1DBAh	1d/01h	1d/01h	1d/01h	1d/01h	1d/01h	1d/01h
7611d/1DBBh	1d/01h	1d/01h	1d/01h	1d/01h	1d/01h	1d/01h
7612d/1DBCh	1d/01h	1d/01h	1d/01h	0d/00h	0d/00h	1d/01h
7613d/1DBDh	1d/01h	1d/01h	1d/01h	1d/01h	1d/01h	1d/01h
7614d/1DBEh	1d/01h	1d/01h	1d/01h	255d/FFh	255d/FFh	1d/01h
7615d/1DBFh	3d/03h	3d/03h	3d/03h	3d/03h	3d/03h	3d/03h
7616d/1DC0h	1d/01h	1d/01h	1d/01h	1d/01h	1d/01h	1d/01h
7617d/1DC1h	0d/00h	1d/01h	1d/01h	1d/01h	1d/01h	1d/01h
7618d/1DC2h	1d/01h	1d/01h	1d/01h	0d/00h	0d/00h	1d/01h

CONFIGURATION

TRP9250 has a pre-programmed Configuration PROM containing the necessary parameters to control the function of the equipment. Some of these parameters are also contained in the non-volatile memory and may therefore be changed by simple programming via the keyboard to suit the individual user.

As the non-volatile memory has battery back-up, all changes in the configuration together with other user-programmable functions and channels will be preserved with a good back-up battery.

To change the configuration of a function, select Configuration Mode and enter the number of the function in question. Some functions requires only to be selected by their number to execute the change, but most functions has several parameters with values which must be changed and stored with the "STO" key to store the change.

To prevent unauthorized programming of the configuration, the Configuration Mode may be protected with a Password. As default the Password is equal to 0 which requires no confirmation when selecting Configuration Mode. The Password may be changed by selecting Function Number 99 in the Configuration Mode. Next time Configuration Mode is selected the correct Password must be entered to get access to the mode. Passwords from 1 to 9999999 may be used.

Select Configuration Mode

Press

If no Password has been programmed (Password = 0) the transceiver is ready for changing configurable functions.

If a Password has been programmed (Password: 1 - 9999999) it is necessary to enter the correct Password to get access to the Configuration Mode.



Press "*Password*"

Reconfiguration of a Function with Parameters

To make a reconfiguration of a Function with parameters enter the number of the Function in the Transmitter Display.

Press "*Function No.*"

The current corresponding parameters are displayed in the Receiver Display with a flashing bar below the first parameter to be changed.

Use  to store the same value again if no change is wanted, or use the numeric keys to change the value and  to store a change. If the Function has more than one parameter the flashing bar will shift right to the next parameter. When the last parameter has been stored another Function Number may be entered as described above. If  is pressed instead, the Transceiver will return to normal operation.

Some functions requires to be activated once, after a change has been made, in order to invoke the reconfiguration. For example if Power Level is "Full" and Full Power is disabled by configuration, the transmitter will stay on Full Power and next time Power Level is changed, only Medium and Low are available.

Directly Executable Functions

Some Functions are directly executable and requires no storing of parameters.

Press "Function No." 

The Function will be executed immediately and another Function Number may be entered. If  is pressed instead, the Transceiver will return to normal operation.

Functions:

Disable / Enable of keys

When a key is disabled no change will take place when pressed.

If the key has a toggle function (TX On/Off, "Light", etc.) select the wanted state with the key before going to the Configuration Mode, disable the key by storing a "0" as the value of the parameter.

Press  to return to normal operation. The key is now disabled and the state is stable and not changeable.

Disabled keys can be enabled again by storing a "1" as a value of the parameter.

Keyboard keys: TRP9250, TRP9251 and TRP9253 all with standard Transceiver Control Unit.

No. 1 to 28. "1" will enable the key.

"0" will disable the key.

Double keys (Tune, Rate, Sensitivity, Volume and AGC) are displayed simultaneously with a position in the display corresponding to the keyboard layout.

Default values shown.

<u>No.</u>	<u>Function</u>	<u>Parameter</u>	<u>Value</u>
1	RX key	Disable/Enable	1
2	TX key	Disable/Enable	1
3	RCL key	Disable/Enable	1
4	STO key	Disable/Enable	1
5	TX On/Off key	Disable/Enable	1
6	Power Level key	Disable/Enable	1
7	TX Tune key	Disable/Enable	1
8	SSB key	Disable/Enable	1
9	AM key	Disable/Enable	1
10	TLX key	Disable/Enable	1
11	2182 key	Disable/Enable	1
12	Alarm Keys	Disable/Enable	1
13	HiSens key	Disable/Enable	1
14	SQL key	Disable/Enable	1
15	Tune keys	Disable/Enable	1 1
16	Rate keys	Disable/Enable	1 1
17	AGC On/Off , AGC limit keys	Disable/Enable	1 1
18	Sensitivity keys	Disable/Enable	1 1
19	"Loudspeaker" key	Disable/Enable	1
20	Volume keys	Disable/Enable	1 1
21	Scan key	Disable/Enable	1
22	Sweep key	Disable/Enable	1
23	Sleep key	Disable/Enable	1
24	"Light" key	Disable/Enable	1
28	Att key	Disable/Enable	1

"Hidden keys":

26	"Prog 2" (LSB)	Disable/Enable	1
27	"Prog 3" (R3E)	Disable/Enable	1
35	"Prog 16" (HST)	Disable/Enable	1

Keyboard keys: TRP 9254 with standard Transceiver Control Unit.

No. 1 to 32. "1" will enable the key.

"0" will disable the key.

Double keys (Tune, Rate, Sensitivity, Volume and AGC) are displayed simultaneously with a position in the display corresponding to the keyboard layout.

Default values shown.

<u>No.</u>	<u>Function</u>	<u>Parameter</u>	<u>Value</u>
1	RX key	Disable/Enable	1
2	TX key	Disable/Enable	1
3	RCL key	Disable/Enable	1
4	STO key	Disable/Enable	1
5	TX On/Off key	Disable/Enable	1
7	TX Tune key	Disable/Enable	1
8	USB key	Disable/Enable	1
9	AM key	Disable/Enable	1
10	TLX key	Disable/Enable	1
13	HiSens key	Disable/Enable	1
14	SQL key	Disable/Enable	1
15	Tune keys	Disable/Enable	1 1
16	Rate keys	Disable/Enable	1 1
17	AGC On/Off , AGC limit keys	Disable/Enable	1 1
18	Sensitivity keys	Disable/Enable	1 1
19	"Loudspeaker" key	Disable/Enable	1
20	Volume keys	Disable/Enable	1 1
21	Scan key	Disable/Enable	1
22	Sweep key	Disable/Enable	1
23	Sleep key	Disable/Enable	1
24	"Light" key	Disable/Enable	1
26	LSB key	Disable/Enable	1
28	Att key	Disable/Enable	1
30	Full key	Disable/Enable	1
31	Med key	Disable/Enable	1
32	Low key	Disable/Enable	1

"Hidden keys":

27	"Prog 3" (R3E)	Disable/Enable	1
35	"Prog 16" (HST)	Disable/Enable	1

Keyboard keys: TRP 9255 with standard Transceiver Control Unit.

No. 1 to 32. "1" will enable the key.

"0" will disable the key.

Double keys (Tune, Rate, Sensitivity, Volume and AGC) are displayed simultaneously with a position in the display corresponding to the keyboard layout.

Default values shown.

<u>No.</u>	<u>Function</u>	<u>Parameter</u>	<u>Value</u>
1	RX key	Disable/Enable	1
2	TX key	Disable/Enable	1
3	RCL key	Disable/Enable	1
4	STO key	Disable/Enable	1
5	TX On/Off key	Disable/Enable	1
7	TX Tune key	Disable/Enable	1
8	USB key	Disable/Enable	1
9	AM key	Disable/Enable	1
10	TLX key	Disable/Enable	1
13	HiSens key	Disable/Enable	1
14	SQL key	Disable/Enable	1
15	Tune keys	Disable/Enable	1 1
16	Rate keys	Disable/Enable	1 1
17	AGC On/Off , AGC limit keys	Disable/Enable	1 1
18	Sensitivity keys	Disable/Enable	1 1
19	"Loudspeaker" key	Disable/Enable	1
20	Volume keys	Disable/Enable	1 1
21	Scan key	Disable/Enable	1
22	Sweep key	Disable/Enable	1
23	Sleep key	Disable/Enable	1
24	"Light" key	Disable/Enable	1
26	LSB key	Disable/Enable	1
28	Att key	Disable/Enable	1
29	CW key	Disable/Enable	1
30	Full key	Disable/Enable	1
31	Med key	Disable/Enable	1
32	Low key	Disable/Enable	1
33	BW key	Disable/Enable	1
34	BFO keys	Disable/Enable	1 1

"Hidden keys":

27	"Prog 3" (R3E)	Disable/Enable	1
35	"Prog 16" (HST)	Disable/Enable	1

Keyboard keys: TRP 9252 and TRP9257 with standard Transceiver Control Unit.

No. 1 to 34."1" will enable the key.

"0" will disable the key.

Double keys (Tune, Rate, Sensitivity, Volume and AGC) are displayed simultaneously with a position in the display corresponding to the keyboard layout.

Default values shown.

<u>No.</u>	<u>Function</u>	<u>Parameter</u>	<u>Value</u>	
1	RX key	Disable/Enable	1	
2	TX key	Disable/Enable	1	
3	RCL key	Disable/Enable	1	
4	STO key	Disable/Enable	1	
5	TX On/Off key	Disable/Enable	1	
6	Power Level key	Disable/Enable	1	
7	TX Tune key	Disable/Enable	1	
8	SSB key	Disable/Enable	1	
9	AM key	Disable/Enable	1	
10	TLX key	Disable/Enable	1	
11	2182 key	Disable/Enable	1	
12	Alarm Keys	Disable/Enable	1	
13	HiSens key	Disable/Enable	1	
14	SQL key	Disable/Enable	1	
15	Tune keys	Disable/Enable	1	1
16	Rate keys	Disable/Enable	1	1
17	AGC On/Off , AGC limit keys	Disable/Enable	1	1
18	Sensitivity keys	Disable/Enable	1	1
19	"Loudspeaker" key	Disable/Enable	1	
20	Volume keys	Disable/Enable	1	1
21	Scan key	Disable/Enable	1	
22	Sweep key	Disable/Enable	1	
23	Sleep key	Disable/Enable	1	
24	"Light" key	Disable/Enable	1	
28	Att key	Disable/Enable	1	
29	CW key	Disable/Enable	1	
33	BW key	Disable/Enable	1	
34	BFO keys	Disable/Enable	1	1

"Hidden keys":

26	"Prog 2" (LSB)	Disable/Enable	1
27	"Prog 3" (R3E)	Disable/Enable	1
35	"Prog 16" (HST)	Disable/Enable	1

Enable Power Levels

No. 50. Enable/Disable Power Level.

If all levels are disabled the transmitter will stay on the current power level.

"1" enables the Power Level.

"0" disables the Power Level.

Default values	Receiver Display		
	Power Level		
	Full	Med	Low
Parameter			
Enable/Disable	1	1	1

Input Selector versus TX Mode

No. 51. Select Transmitter AF Input Source versus transmitter mode.

External Line input is available only when 717S is installed and not engaged with DSC/telex or Interface-A 718 is installed.

"0": AF is taken from "Line, Key" input on TU or TCU according to function no. 73.

"1": Handset microphone input.

"2": Key-selected input. AF input follows active key input.

Default values	Receiver Display	
	TX Mode	
	SSB	AM
Parameter		
AF Input	1	1

Select Transmitter Key Input versus TX Mode

No. 52. Select Transmitter Key Input versus transmitter mode.

"0": External Key active. See function no. 73.

"1": Handset Key active.

"2": Both key inputs active. The keying Key excludes the other.

Default values	Receiver Display	
	TX Mode	
	SSB	AM
Parameter		
Key Input	1	1

Compressor Time Constant versus TX Mode

No. 53. Select Time Constant for the transmitter AF compressor versus transmitter mode.

"1" corresponds to a normal time constant.

"0" corresponds to a long time constant.

Default values	Receiver Display			
Parameter	TX Mode			
	SSB	AM	TLX	HST
Time Constant	1	1	0	1

AGC Parameters versus RX Mode

Select receiver AGC Parameters versus receiver mode.

No. 54. "Hang" the AGC during transmit.

"1": The AGC action is disabled during transmit.

"0": The AGC action continues during transmit.

Default values	Receiver Display				
Parameter	RX Mode				
	SSB	AM	CW	TLX	HST
Hang	1	1	0	0	1

No. 55. Select Hang AGC function versus receiver mode.

"1": The AGC operates with disabled Hang function.

"0": The AGC operates with enabled Hang function.

Default values	Receiver Display				
Parameter	RX Mode				
	SSB	AM	CW	TLX	HST
Hang AGC	0	1	0	1	0

No. 56. Select AGC Decay Time versus receiver mode.

"1" corresponds to Slow Decay Time.

"0" corresponds to Fast Decay Time.

Default values	Receiver Display				
Parameter	RX Mode				
	SSB	AM	CW	TLX	HST
Decay Time	1	1	0	0	1

No. 57. Select AGC Hang Time versus receiver mode.

"1" corresponds to Long Hang Time.

"0" corresponds to Short Hang Time.

If Hang AGC (see No. 55) is disabled the AGC Hang Time has no influence.

Default values	Receiver Display				
Parameter	RX Mode				
	SSB	AM	CW	TLX	HST
Hang Time	1	1	0	0	1

No. 58. Select AGC Suppressor function versus receiver mode.

"1": Activate the AGC Suppressor.

"0": Disable the AGC Suppressor.

Default values	Receiver Display				
Parameter	RX Mode				
	SSB	AM	CW	TLX	HST
Suppressor	0	0	0	1	0

No. 59. Select additional AGC Filter.

"1": Disable the additional AGC Filter.

"0": Enable the additional AGC Filter.

Default values	Receiver Display				
Parameter	RX Mode				
	SSB	AM	CW	TLX	HST
AGC Filter	1	0	1	1	1

AF Bandwidth

No. 60. Select AF Bandwidth in telex mode.

"1" corresponds to a large AF bandwidth.

"0" corresponds to the normal AF bandwidth.

Default value is "0".

Default values	Receiver Display				
Parameter	RX Mode				
	SSB	AM	CW	TLX	HST
AF Bandwidth	0	1	0	0	1

Split Mode Disable/Enable tables

Disable/Enable receiver transmitter Split Mode.

"1": Enable Split Mode.

"0": Disable Split Mode.

No. 61. RX mode = USB versus TX modes.

Default values	Receiver Display	
Parameter	TX Mode	
	LSB	AM
RX Mode USB	1	1

No. 62. RX mode = LSB versus TX modes.

Default values	Receiver Display	
	TX Mode	
	USB	AM
Parameter		
RX Mode LSB	1	1

No. 63. RX mode = AM versus TX modes.

Default values	Receiver Display	
	TX Mode	
	USB	LSB
Parameter		
RX Mode AM	1	1

Disable / Enable "Prog" functions

"1" enables the "Prog" function.
 "0" disables the "Prog" function.
 Default value shown below.

<u>No.</u>	<u>Function</u>	<u>Parameter</u>	<u>Value</u>
65	Prog Scan	Disable/Enable	1
66	Prog Sweep	Disable/Enable	1
67	Prog Sleep	Disable/Enable	1
68	Prog Power Level	Disable/Enable	1
69	Prog STO	Disable/Enable	1

Disable / Enable "Prog" "98" function

No. 70. Disable/Enable view and change of the Security Code.

"1" makes it possible to view and change Security Code.
 "0" makes it impossible to view or change Security Code.
 Default value is "1".

TCU backlight step mode

No. 71. Select TCU backlight step mode

"0" Selects sawtooth shaped backlight step mode.

"1" Selects triangle shaped backlight step mode.

External "Line, key" input versus TX mode

See also functions no. 51 and 52

No. 73 View/change External key input versus telephony mode

"0" Enables external key input in the TU "Line. key" socket.

"1" Enables external key input in the TCU "Line. key" socket.

Default values	Receiver Display	
	TX Mode	
	SSB	AM
Parameter		
External key input	1	1

No. 74 View/change External "Line, key" audio / key inputs versus TLX and HST mode

"0" Enables external audio/key inputs in the TU "Line. key" socket.

"1" Enables external audio/key inputs in the TCU "Line. key" socket.

Default values	Receiver Display	
	TX Mode	
	TLX	HST
Parameter		
External "Line, key" input	0	1

View / change Remote Control set-up of DSC and Telex Option Interface-A 718S or PCP 717S

Interface-A 718S is the remote control interface for operation with external equipment. With the optional Interface-A 718S installed in the Transceiver Unit one of the below listed Remote Control modes is selected to obtain the required operation for the installation.

No. 75. View / change set-up of DSC/Telex and HST mode interaction and Control Protocol.

Store the wanted 3 values to select:

One out of seven possible interaction configurations and the protocol for remote control of TU and TCU.

Default values "6 0 0". Must be used with PCP 717S installed.

<u>Parameter</u>	<u>Interaction</u>	<u>Remote Control Protocol</u>	
TELEX with local frequency control	0		
REMOTE FREQUENCY CONTROL	1		
AUTOTELEX	2		
AUTOTELEX with telephony option	3		
MARITEX	4		
MARITEX with telephony option	5		
DSC/Telex	6		
		<u>TUTCU</u>	
T-Bus protocol		0	0
NMEA protocol		1	1

TELEX with local frequency control: Value = 0

When "TELEX with local frequency control" is enabled all control of TRP9250 must be carried out manually. When "TLX" on the keyboard is pressed TRP9250 will enter telex mode and respond to keying signals on the "EXT KEY" input in the "Line, key" connector. All RX/TX frequencies are changed via the keyboard.

Controlled scanning of RX frequencies is possible. Programming one of the TRP9250 scanning programs and the external Scan S/S (Scan Start/Stop) input enables remote control of the scanning. See "Setting up a scan program" in the 'Operation' section and the description of Function no. 77 "Scan S/S input" .

REMOTE FREQUENCY CONTROL: Value = 1

"REMOTE FREQUENCY CONTROL" enables remote set-up of RX and TX frequencies. Sending frequency commands to the "PC RX" input in the 2COM" connector, TRP9250 will change frequency and indicate the remote controlled status by flashing the "Remote" annunciator in the display. TRP9250 will at all time respond to all manual key entries. The "Remote" annunciator is then switched off indicating that the last entry was made manually.

AUTOTELEX: Value = 2

If "AUTOTELEX" is enabled automatic frequency and scanning control from the Radio-Telex modem is possible. When TRP9250 is in the normal state (last keying sequence terminated) it will respond to commands on the "PC RX" input in the "COM" connector by selecting telex mode and flashing the "Remote" annunciator in the display indicating remote control. Control is now transferred to the Radio-Telex modem and only the "Volume Up/Down", "Speaker On/Off", "Back- light key" and "Supply On/Off" keys can be operated.

The "AUTOTELEX" mode can temporarily be terminated by pressing the "TLX" or the "Enter" key. The "Remote" annunciator is switched off in the display and TRP9250 may be operated manually. TRP9250 will reenter "AUTOTELEX" mode immediately when a new Radio-Telex modem command is received.

When the "2182" key is pressed, TRP7000 will return to manual control from the keyboard and normal operation is possible. All control commands from the Radio-Telex modem are blocked until the "TLX" key is pressed.

AUTOTELEX with telephony option: Value = 3

If it is desirable to interrupt the Radio-Telex modem ARQ scanning temporarily while making a phone call "AUTOTELEX with telephony option" should be enabled. It has the same features as "AUTOTELEX" but with the following additional facilities.

Pressing the wanted telephony mode-key on TRP9250 the scanning is interrupted and normal operation of the keyboard is possible. To reenter control from the Radio-Telex modem and hence allow scanning again, press the "TLX" key. TRP 9250 will automatically return to "Autotelex with telephony option" if a transmitter frequency command is received from the Radio-Telex modem.

While TRP9250 is controlled by the Radio-Telex modem the "Remote" annunciator is flashing in the display and only the "Volume Up/Down", "Speaker On/Off", "Back-light key", "Supply On/Off" and mode-keys can be operated.

MARITEX: Value = 4

When "MARITEX" is enabled all the features of "AUTOTELEX" are retained. Additionally, TRP9250 will protect against erroneous continuous keying in more than half a minute by un-keying the transmitter and sounding the beeper. Beeping will continue until a key is pressed.

MARITEX with telephony option: Value = 5

If "MARITEX with telephony option" is enabled all the features of "AUTOTELEX with telephony option" and the continuous keying protection of "MARITEX" are combined.

DSC/Telex: Value = 6

Automatic control of the TRP9250 MF/HF receiver and transmitter is possible with the optional built-in DSC/Telex Controller-Receiver (PCP 717S and additional boards). TRP9250 will at all time respond to commands from PCP 717S by entering "DSC/Telex" mode and flashing the "Remote" annunciator in the display. In this state only the "Volume Up/Down", "Speaker On/Off" and "Back-light key" can be operated.

The "DSC/Telex" mode can temporarily be terminated by pressing the "TLX" or the "Enter" key.

The "Remote" annunciator is switched off in the display and TRP9250 may be operated manually. TRP9250 will reenter "DSC/Telex" mode immediately when a new command from PCP 717S is received.

NOTE: 2182 distress operation

When the "2182" key is pressed, TRP9250 will enter the distress mode and ignore all commands except a transmitter frequency command, which will make the TRP 9250 return to remote controlled mode. A return from distress mode to remote controlled mode may also be performed by pressing the "TLX" key.

On-Hook:

When the installation includes an external DSC Controller and the TRP9250 receiver is used for DSC scanning, an On-Hook signal is needed. The On-Hook signal shows if the handset is operated and is available in the AUX connector (pin 1) of the Transceiver Unit.

Handset hooked on: On-Hook = high
Handset hooked off: On-Hook = low

The On-Hook signal is available in all modes (value = 0 through 6 programmed).

More Control Units

When TRP9250 includes the optional built-in DSC/Telex Controller-Receiver, TRP9250 will react on any control command received, regardless of the Priority System state and current programming. Control commands will even overrule all programmed Security Codes and enable normal operation securing transmission of a DSC message.

When a handset is lifted off-hook on a TCU an Off-Hook signal is generated and is available to the optional built-in DSC/Telex Controller-Receiver. The DSC/Telex Controller-Receiver will on reception of this signal stop scanning control of the TRP9250 MF/HF receiver, and thus enable manual control of the transceiver. To transfer control to the TCU in question press any key, preferably the "Enter" key.

View / change Telex Audio Centre Frequency

No. 76. View / change Telex Audio Centre Frequency.

$$\text{Centre Freq.} = 1500\text{Hz} + N2 \times 500\text{Hz} + N1 \times 50\text{Hz}$$

N1 values: 0 to 9

N2 values: 0 to 2

Default Audio Centre Frequency = 1700Hz

Default values	Receiver Display	
	Multipliers	
Parameter	N2	N1
Centre Frequency	0	4

View / change External Scan S/S input

With the optional board, Interface-A 718S, installed the available Scan S/S (Scan Start/Stop) input can be used to control the scanning of the 10 build-in user-programmable scan programs or the user-programmable sweep program. The Scan S/S input transition must be enabled to one out of four possibilities, and the input coupled to either Scan or Sweep.

No. 77. View / change External Scan S/S input

Scan S/S Input Transition:

<u>Parameter</u>	<u>Value</u>
Disable	0
Start/Stop on positive/negative transition	1
Start/Stop on negative/positive transition	2
Start/Stop on positive/positive transition	3
Start/Stop on negative/negative transition	4

If a step function is wanted select value = 1 or 2 and store a Dwell Time = 0 during the programming of the scan or sweep program. See "Channel Scanning, Set Up" or "Frequency Sweeping, Set Up".

Scan S/S Coupling:

<u>Parameter</u>	<u>Value</u>
Coupled to Scan	0
Coupled to Sweep	1

Store the wanted values to select the required transition and coupling.

Default values	Receiver Display	
	Transition	Coupling
Parameter		
Scan Start/Stop	0	0

View / change TCU Priority System

No.: 90 View / Change TCU Priority System

Enable/Disable Master Priority, Privacy and Exclusive Access in Multi-Control Unit system.

"1" enables the parameter

"0" disables the parameter

Default values shown below

Default values	Receiver Display		
Parameter	TX Mode		
	Master Priority	Privacy	Exclusive Access
Enable/Disable	0	0	0

The Priority System is adapted to various needs by configuration of three parameters:

EXCLUSIVE ACCESS

PRIVACY

MASTER PRIORITY

EXCLUSIVE ACCESS

By enabling/disabling this parameter it is selected whether the currently used TCU has Exclusive Access to the transceiver with no interruption from other TCU's possible, or that control can take place from any CU at any time.

Exclusive Access Enabled:

Only key entries on the currently used TCU are executed. The "Busy" annunciator is flashing in the display of all other TCU's to indicate that the transceiver is in use.

When control from the currently used TCU no longer is needed, it is necessary to press "Prog" "0" "Enter" (Leave System To Other User) to enable control transfer to another TCU. The "Busy" annunciators is then switched off to indicate that the transceiver is no longer in use.

When the "Busy" annunciator is switched off in the display of a TCU, control can be transferred to that TCU simply by pressing any key (preferably the "Enter" key). All other TCU's are immediately locked out and "Busy" is flashing in all other displays, indicating that the transceiver is now in use.

Exclusive Access Disabled:

Control is automatically transferred to the TCU where the last key entry was made. The "Busy" annunciator is switched off in all TCU's indicating that operation can take place on any TCU. (Busy switched off in all TCU's except when a Master Priority TCU is in use).

PRIVACY

By enabling/disabling Privacy the received signal and information displayed in the TCU's can be controlled. This enables either normal use where the communication can be followed in another room, or private conversation. When Privacy is disabled all key entries are reflected in all displays and the received signal is led to all TCU's. Enabled Privacy shuts down all displays and switches off the received signal except for the currently used TCU.

Privacy Enabled:

Only the TCU in use shows the current status in the display. All other TCU's shows only the time of day and the "Busy" annunciator, which is updated according to the Exclusive Access parameter. The received signal is only led to the currently used TCU securing privacy. If the external speaker is assigned to the currently used TCU, it can be switched on/off by pressing "Prog" "1" "Enter", else it is switched off.

When the equipment is switched on only Time Of Day is displayed. Press any key (preferably the "Enter" key) on a TCU and the last frequency set-up is shown. If the Exclusive Access parameter is enabled, "Busy" is flashed in all other displays.

Privacy Disabled:

All displays shows the same information and are updated simultaneously, except for the "Busy" annunciators which are updated according to the Exclusive Access parameter. The received signal is led to all TCU's, and all internal speakers may locally be switched on/off. The external speaker may be switched on/off according to it's configuration. See description below.

MASTER PRIORITY

If it is desirable to have one TCU with higher priority than the rest, Master Priority (1st Priority) should be enabled. When Master Priority is enabled the TCU with Priority/Intercom number equal to "1" gets the Master Priority.

From the TCU with Master Priority, it is always possible to break in and take over the control of the transceiver just by pressing any key (preferably the "Enter" key) on the TCU. Having taken over, no other TCU can interrupt the Master TCU.

Master Priority Disabled:

All TCU's have equal priority and the system set-up is determined by the Exclusive Access and Privacy parameters alone.

Master Priority Enabled:

The TCU with Priority/Intercom number = "1" is given Master Priority. The Master TCU can at all time break in and take over control of the transceiver. All other TCU's are updated according to the Privacy parameter, and "Busy" is flashed.

When the Master TCU has taken over no other TCU can interrupt the Master.

When control from the Master is finished press "Prog" "0" "Enter" (Leave System To Other User). Displays are updated according to the Privacy parameter and "Busy" is switched off in all TCU's.

Assign TCU Priority / Intercom No.

The Priority/Intercom number is common for both the Priority System and the Intercom facility. Each Transceiver Control Unit connected to the ScanBus must have different numbers to enable selective data communication. The numbers range from 1 to 5.

The assigned Priority/Intercom number can be read by pressing "Prog" "25" "Enter" (Read TCU Priority/Intercom Number) on each TCU. In some installations it might be necessary to change the numbers, for example if Master Priority is enabled.

No. 91 Assign TCU Priority / Intercom Number.

The current TCU Priority/Intercom Number is displayed in the receiver frequency display. Change the number with the numeric keys and store it with the "STO" key. Press "Enter" to return to normal operation.

Repeat the above procedure on each TCU, storing the individual Priority/Intercom numbers. When the last number is stored the whole system is updated.

Reset Scan, Sweep and Sleep

No. 95 When function number 95 is selected all parameters and frequency tables of Scan, Sweep and Sleep programmes are deleted and reset to factory setting.

Reset currently used Transceiver Control Unit

No. 96 When function number 96 is selected on a Transceiver Control Unit connected to the ScanBus, the contents of its EEPROM is reset to factory setting. The EEPROM contains information about ScanBus, Keyboard parameters, Security Code and Priority/Intercom number. If this function is selected, especially in installations where more than one Transceiver Control Unit is connected, the set-up made by the user may be changed.

Reset System Parameters to default values

No. 97 When function number 97 is selected, all System Parameters are reset to default values. The System Parameters are those listed under function number 1 to 94.

Reset total memory and system parameters to default values

No. 98 Function number 98 deletes the total user-programmable channel memory, executes function number 95 and 97, and resets the Password for the Configuration Mode.

View / change Password

No. 99 To prevent unauthorized programming of the configuration, the Configuration Mode may be protected with a Password. As default the Password is 0 which requires no confirmation when selecting Configuration Mode. The Password may be viewed or changed by selecting Function Number 99. Next time Configuration Mode is selected the correct Password must be entered to get access to the mode. Passwords from 1 to 9 999 999 may be used.

When function number 99 is selected the current Password is displayed. To change the

Password key-in the new Password and press to store it.

If no change is wanted press .

Press to get back to normal operation.

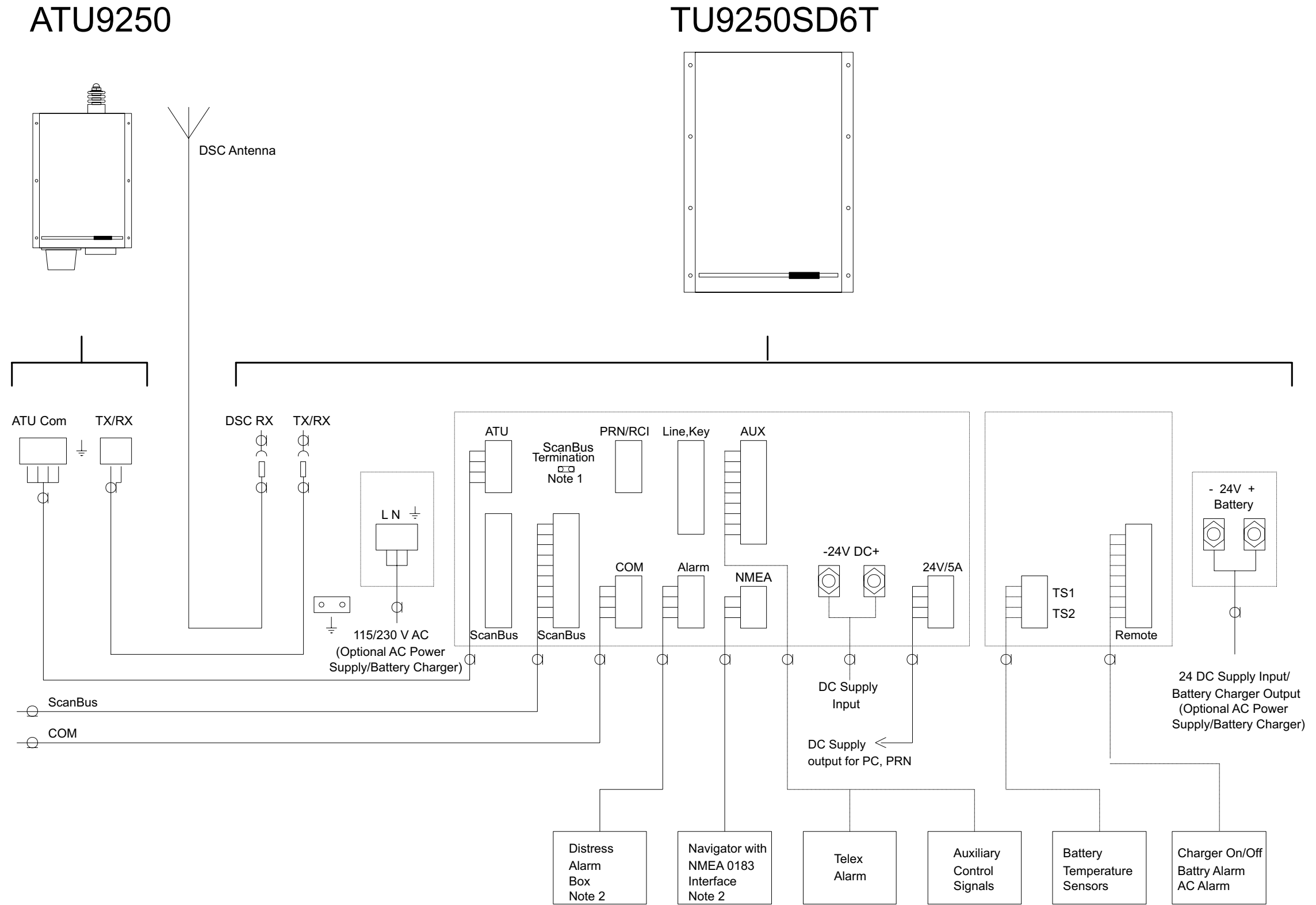

Note 1: If both Scanbus connections are used remove jumper.
 Note 2: May alternatively be connected to DCU9000.

DCU9000

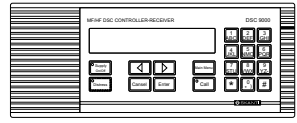

TCU9000

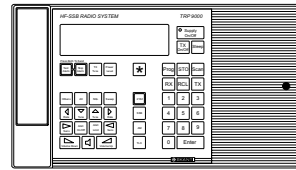

PC9000

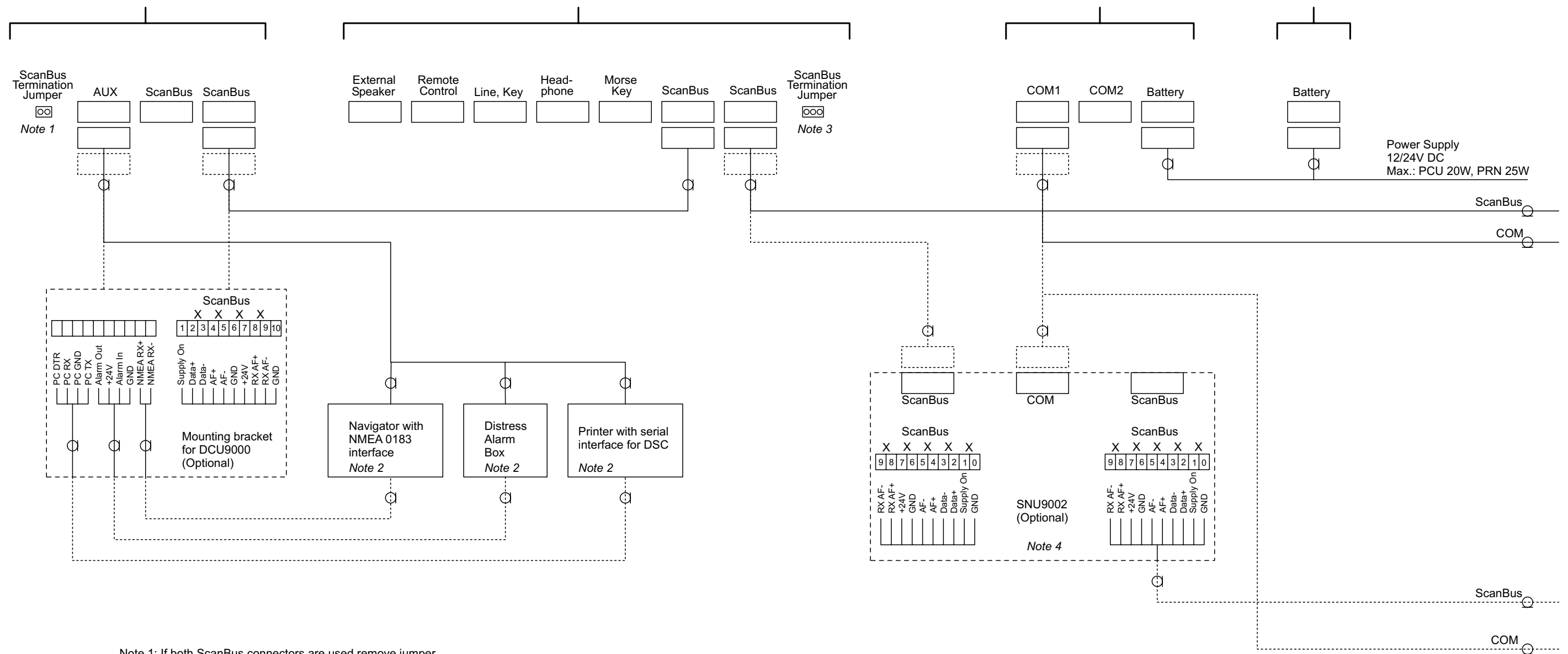
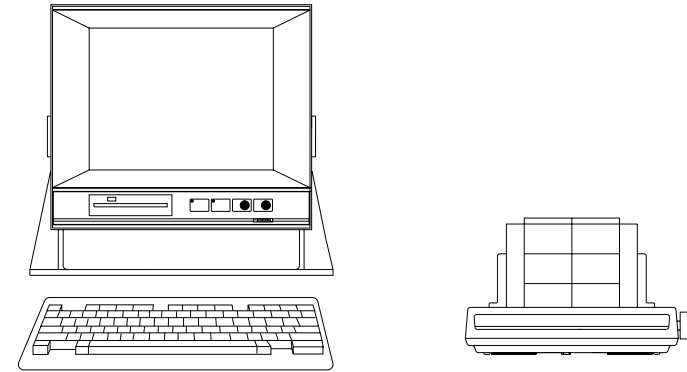

- Note 1: If both ScanBus connectors are used remove jumper.
- Note 2: May alternatively be connected to Transceiver Unit.
- Note 3: If both ScanBus connectors are used move jumper to position 2.
- Note 4: If SNU9002 is installed TU - PC data communication is transferred via the ScanBus making the TU-COM to PC-COM1 connection obsolete.

4. TECHNICAL DESCRIPTION Table of Contents

Transceiver Control Unit 9000	4-3	Programmable Communication Processor 717 (option)	4-7
Microphone Board 908	4-3	Single Channel Receiver Board 914 (option)	4-7
AF Amplifier Board 907	4-3	Synthesizer Board 912 (option)	4-7
TCU Control Board 904	4-3	Receiver Signal Path 915 (option)	4-7
TCU Audio Board 905	4-3		
Transceiver Unit TU 9250	4-4	Antenna Tuning Unit ATU 9250	4-8
TU Control Board 910	4-4	ATU Board 945	4-8
Synthesizer Board 911	4-4	Dummy Load 741 (option)	4-8
Master Oscillator 713	4-4	Dummy Load / Antenna Amp 742 (option)	4-8
RX / EX Signal Path 715	4-4		
Power Amplifier 721	4-5	Block Diagrams	4-9
Marine Filters 726 / Continuous Filters 927	4-5		
DC Power Supply/Interface Board 935	4-5		
Connection Board 936	4-6		
AC Power Supply Board 958 (optional)	4-6		
Charger Control Board 959	4-6		
Interface-A 718 (option)	4-6		

TRANSCEIVER CONTROL UNIT 9000

The Transceiver Control Unit TCU 9000 consists of a handset and a control box and operates like a terminal connected to a computer meaning that all operations which are entered on the Transceiver Control Unit will be performed by the Transceiver Unit. The Transceiver Control Unit contains the following PCBs including the described circuits:

Microphone Board 908:

Microphone Board 908: The board is located inside the handset and includes Microphone and HOOK ON detector Microphone and HOOK ON detector

AF Amplifier Board 907:

The board is located inside the handset and includes OP-AMPs to amplify the earpiece signal and to add gain to the microphone signal. The microphone signal level can be adjusted here. AF Amplifier Board 707:

TCU Transceiver Control Board 904:

The Transceiver Control Board includes Display, Keyboard and a microprocessor. The microprocessor performs the keyboard scanning, display driving, data communication with the Transceiver Unit as well as controlling the Display and Keyboard Backlight. The beep tone is generated on this board and the connectors for the handset and internal loudspeaker are also located on this board.

TCU Audio Board 905:

The Transceiver Audio Board includes AF receiver/driver, AF amplifier and volume control. It performs the handling of the bidirectional AF lines, amplifying AF signals for the earpiece, the internal and external speaker and the line output. The connector for external speaker, phone and morse key is located on this board.

TRANSCEIVER UNIT TU 9250

The Transceiver Unit in its basic version consists of a transceiver control module, a synthesizer including master oscillator, a receiver/exciter module, a power amplifier module, a filter bank module covering either marine frequencies only or the complete range 1,6 to 30 MHz, a power supply/interface module, and a connection board. The main wiring is by ribbon cables with Micro MaTch connectors on front of the 'plug-in' modules. RF signals are routed in coaxial cables using MCX connectors.

With the optional AC power supply assembly included, the equipment may be supplied from 115/230 V AC with automatic switch-over to 24 V DC supply in the absence of AC supply voltage. An optional battery charger board enables the AC power supply to be used as a battery charger.

The transceiver unit may include one of five different DSC/telex options, either an interface board enabling connection of an external modem to the transceiver unit, a telex modem, a DSC/telex modem, the latter in connection with either a 2187.5 kHz single channel DSC watch receiver or a scanning DSC watch receiver. The scanning receiver consists of two modules, a synthesizer and a receiver signal path.

TU Control Board 910:

The digital part includes the micro controller, address decoder, program PROM, configuration PROM, non volatile RAM, real time clock, ScanBus data communication driver, ATU interface, digital TU-bus driver, remote interface and drivers for the analog circuits. The analog part includes voltage regulators, analog interface circuits and analog output drivers. The TU Control Board performs the digital and analog control of the transceiver functions requested by the control unit or the built-in or external modem.

Synthesizer Board 911:

The synthesizer board includes synthesizers, dividing/multiplication circuits and check detectors. The 1st, 2nd and 3rd local oscillator receive their reference signal from the master oscillator PCB 713. The 1. local oscillator covers the frequency range from 45 MHz to 75 MHz and generates the injection signal for the 1. mixer on RX/EX signal path 715. The 2. local oscillator generates by division and multiplication a 44.544 MHz signal for the 2. mixer. The 3. local oscillator generates a 456.5 kHz signal for the modulation/demodulation process.

Master Oscillator 713:

The master oscillator includes a highly stable Oven Controlled Crystal Oscillator (OCXO). The master oscillator generates the accurate 17.8176 MHz reference signal for the synthesizers and sets the 10 Hz frequency stability of the equipment.

RX / EX Signal Path 715:

The RX signal path includes protection, antenna attenuator, RF- and IF amplifiers, mixers, filter bank, demodulator, squelch and audio line drivers. The RX signal path performs the handling of the received antenna signal and delivers an AF signal to the control unit via DC Power Supply/Interface

Board 935 where the AF-signal is converted from an unbalanced to a balanced signal. The EX signal path includes the AF compressor, modulator, filter bank, mixers and EX amplifier. The EX signal path generates the modulated RF signal for the power amplifier. The RX / EX signal path is controlled by the TU Control Board 910 and receives its injection signals from the Synthesizer Board 911.

Power Amplifier 721:

The Power Amplifier includes input attenuator, PA drivers, PA-stage, fan circuit, self protection, key circuit and SWR detector. The Power Amplifier receives the modulated RF input signal from the RX/EX Signal Path 715 and delivers the amplified output signal to the low-pass filters, PCB 726 or 727. The SWR detector output is a monitor signal for the TU Control Board 910. The fan circuit drives the fan in accordance with the temperature signal monitored on the Power Amplifier and the DC power supply/Interface Board 935.

Marine Filters 726 / Continuous Filters 727:

The PA filters includes low-pass filters, relay drivers and a peak detector. The PA Filters removes the unwanted harmonic frequencies from the PA signal received from the Power Amplifier. The output of the PA Filters is connected to the input of the ATU via RX/TX Relay on the DC power supply/Interface Board 935. The selection of low-pass filter is controlled by the TU Control Board 910. The Peak Detector monitors the output power and the Peak Detector output is used for power level adjustments and for displaying the power level in the control unit.

Marine filters 726 covers the frequency ranges

1.6 - 4.8 MHz

6.2 - 8.95 MHz

12.23 - 17.65 kHz

18.78 - 27.1 kHz

Continuous Filters 727 covers the frequency range 1.6 - 30 MHz

DC Power Supply/Interface Board 935:

The DC switched mode power supply generates all internal the voltages needed in the equipment galvanically isolated from the battery, only the Power amplifier is supplied directly from the battery.

The SMPS is switched on from the control unit via the Scanbus SUPPLY ON wire and switched off under software control via the SUPPLY ON/OFF connection from the TU Control Board or the PCP Board 717. A protection circuit switches the SMPS off in the event of an output overload and switches on again when the overload condition has been removed. The DC supply voltage is sensed by a BAT INFO detector circuit and fed to the TU Control Board for automatic RF output power adjustment.

The interface part includes Rx/Tx relay shift, balanced AF line driver for the ScanBus connection to the control unit, and digital interface for auxiliary input/output.

Connection Board 936:

The connection board contains the DC supply input terminals and terminal strips for connection of other units. Fuses and diodes for protection against supply voltage reversal and over-voltage are also located on this board.

AC Power Supply Board 958 (optional):

The AC power supply board contains an input filter followed by a rectifier (230V)/voltage doubler (115V) circuit producing an unregulated DC voltage which is converted to 28 V in a full bridge Hy-bridge converter with soft switching and integrated magnetics. The output voltage is adjusted by a regulator circuit optically isolated from the driver circuit. Power for the driver circuit is supplied from a separate winding on the main transformer. A temperature controlled fan contribute to cooling if necessary.

The output is connected to the DC supply input terminals of Connection Board 935. A 24 V battery connected to the battery terminals will by means of a relay be connected to the output in case of mains failure.

An over-voltage/over-temperature protection circuit disables the SMPS by triggering a failure lock circuit in case of excessive output voltage or temperature. If the failure lock has been triggered it is necessary to disconnect the mains for min. 7 minutes to allow the primary capacitors to discharge before the SMPS can be switched on again.

Charger Control Board 959 (optional):

The charger control board enables the AC power supply to be used as a battery charger. With the switch set to position 'Auto' the battery relay in the AC power supply connects the output to the battery terminals, provided a battery is connected and the voltage of the battery exceeds approx. 17 V.

The power supply operates as a constant current/constant voltage charger. The output current capability is min. 24 A. The float voltage is adjustable by means of a potentiometer on the charger control board. Constant current mode is indicated by a yellow 'Main charge' LED while constant voltage is indicated by a green 'Float charge' LED. The board also contains alarm circuits for low and high battery voltage and terminals for AC alarm output. Temperature sensor inputs are provided for compensating the float voltage and the high voltage alarm setting.

Interface-A 718 (optional):

PCB 718 consists of data drivers and receivers, AF line drivers and receivers, and general purpose input/output circuits. The optically isolated data drivers/receivers are for control of the transceiver from an external modem. Galvanically isolated balanced 600 ohms input and output lines are available for transfer of the AF signals with a +/- 10 dB adjustment possibility of the AF output.

Programmable Communication Processor 717 (optional):

This board constitutes a combined DSC/Telex modem with two demodulators and one modulator. It contains a 16-bit microprocessor with its peripherals, a real time clock, interface circuits for alarm, handset hook, and key input signals, interface circuits for alarm and key output signals, four asynchronous communication interface adaptors for serial communication with the TU Control board, navigational equipment (NMEA), printer/remote control, and PC. The driver/receivers for PC and NMEA are opto-isolated with driver power delivered from the equipment connected. The modem communicates with the control unit via the ScanBus using a dedicated CAN controller chip. The modulator generates an FSK signal at 1.7 kHz which is routed to the exciter. The input signals for the two demodulators are coming from the dedicated DSC watch receiver and the RX/EX Signal Path 715 respectively.

Single Channel Receiver Board 914 (optional):

The single channel receiver is fixed tuned to the DSC distress frequency 2187.5 kHz. It includes antenna input protection, pre-selection filter, 1. mixer where the input signal is mixed with a 1.7325 MHz signal originating from an oven controlled oscillator, a narrow-band 455 kHz crystal filter, IF amplifier, and 2. mixer. The local oscillator signal for the 2. mixer is generated by a 7.2528 MHz crystal oscillator the output of which is divided by 16 to produce a frequency of 453.3 kHz. The output from the mixer is low-pass filtered and the AF signal centred around 1.7 kHz is finally amplified in AF amplifier.

Synthesizer Board 912 (optional):

The Synthesizer Board 912 is similar to PCB 911 but without master oscillator and gets the reference signal from PCB 911. The Synthesizer Board 912 is used together with the optional PCB 915 to constitute a built-in DSC Scanning Receiver.

Receiver Signal Path 915 (optional):

The receiver signal path includes antenna input protection, pre-selection filters, 1. mixer where the input signal is mixed with the 1. local oscillator signal of the synthesizer, a 45 MHz crystal filter, 1. IF amplifier, and 2. mixer. The local oscillator frequency for the 2. mixer is 44.544 MHz corresponding to a 2. IF frequency of 455 kHz. The 2. IF filter is a narrow-band crystal filter. In the 3. mixer the IF signal is mixed with 456.7 kHz producing an AF signal centred around 1.7 kHz.

ANTENNA TUNING UNIT ATU 9250

ATU Board 945:

The ATU board comprises tuning network, measuring system and micro-controller circuits. The ATU board matches the impedance of the antenna to 50 ohm in order to gain the best possible SWR. The ATU board communicates tuning process and frequency information with the transceiver unit. The tuning network consists of Capacitor Bank 1, Capacitor Bank 2, and an Inductor Bank. With these it is possible to form either an L-network or a π -network. The capacitor banks and inductor bank are built up by binary related capacitors respectively binary related coils. The setting of capacitance and inductance is accomplished by high current, high voltage RF reed relays. A current detector at the antenna output terminal is used for measuring the antenna current for display at the control unit. To prevent overload of the relays, current detectors are incorporated in the Inductor Bank and in Capacitor Bank 2 and information fed back to the transceiver unit to decrease the output power if maximum permissible current is exceeded. To prevent overheating a temperature sensor is incorporated which at excessive temperatures commands the transceiver to reduce the output power.

Dummy Load 741 (option):

The Dummy Load includes relays and load resistors. It permits two-tone alarm generator test into dummy load to be performed as well as grounding or floating the antenna.

Dummy Load/Antenna Amp 742 (option):

The Dummy Load/Antenna Amp 942 includes relays, load resistors, and an RX-amplifier for frequencies below 1.6 MHz. It permits two-tone alarm generator test into Dummy Load to be performed as well as grounding or floating the antenna.

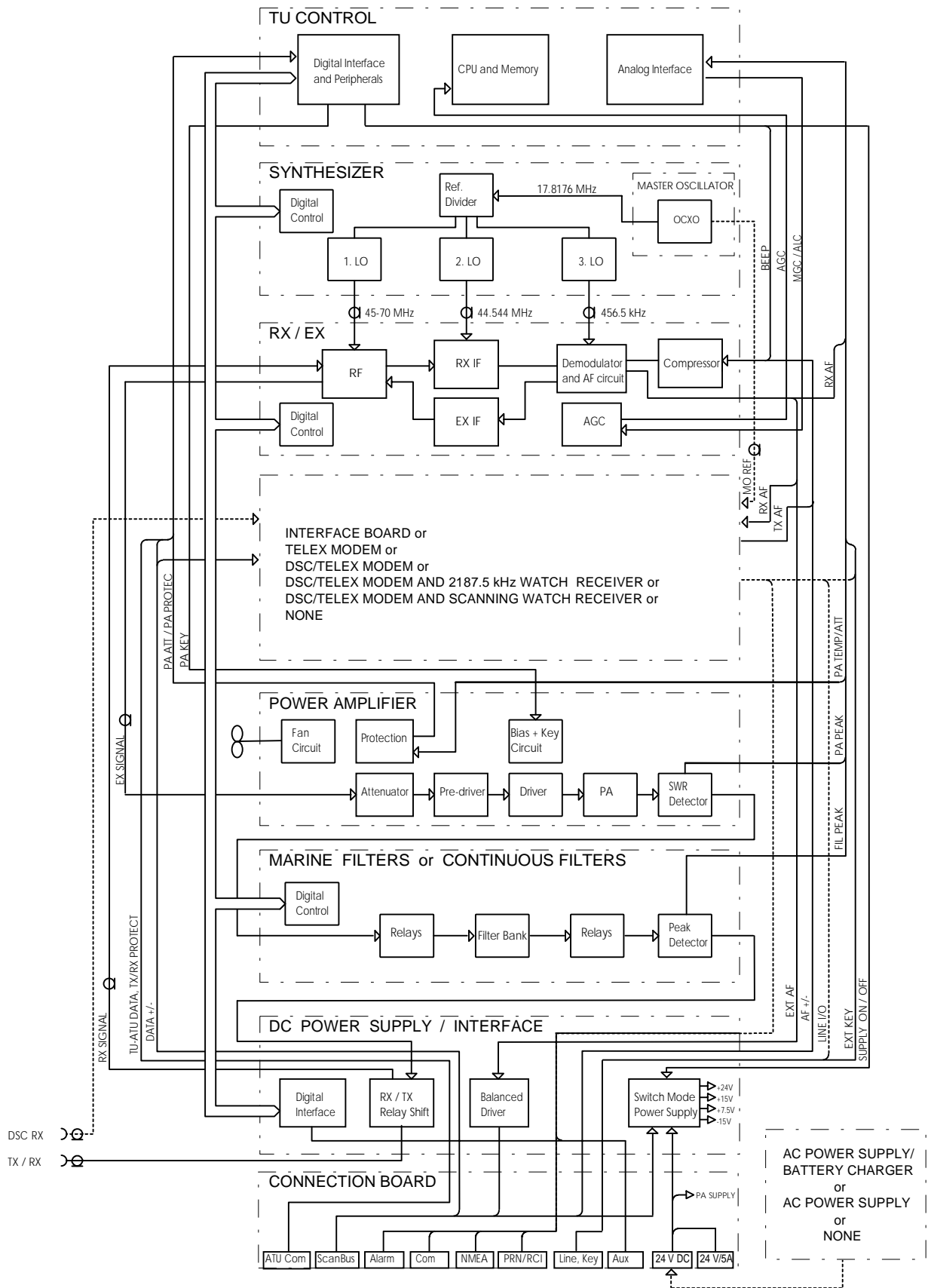

TRANSCEIVER UNIT BLOCK DIAGRAM

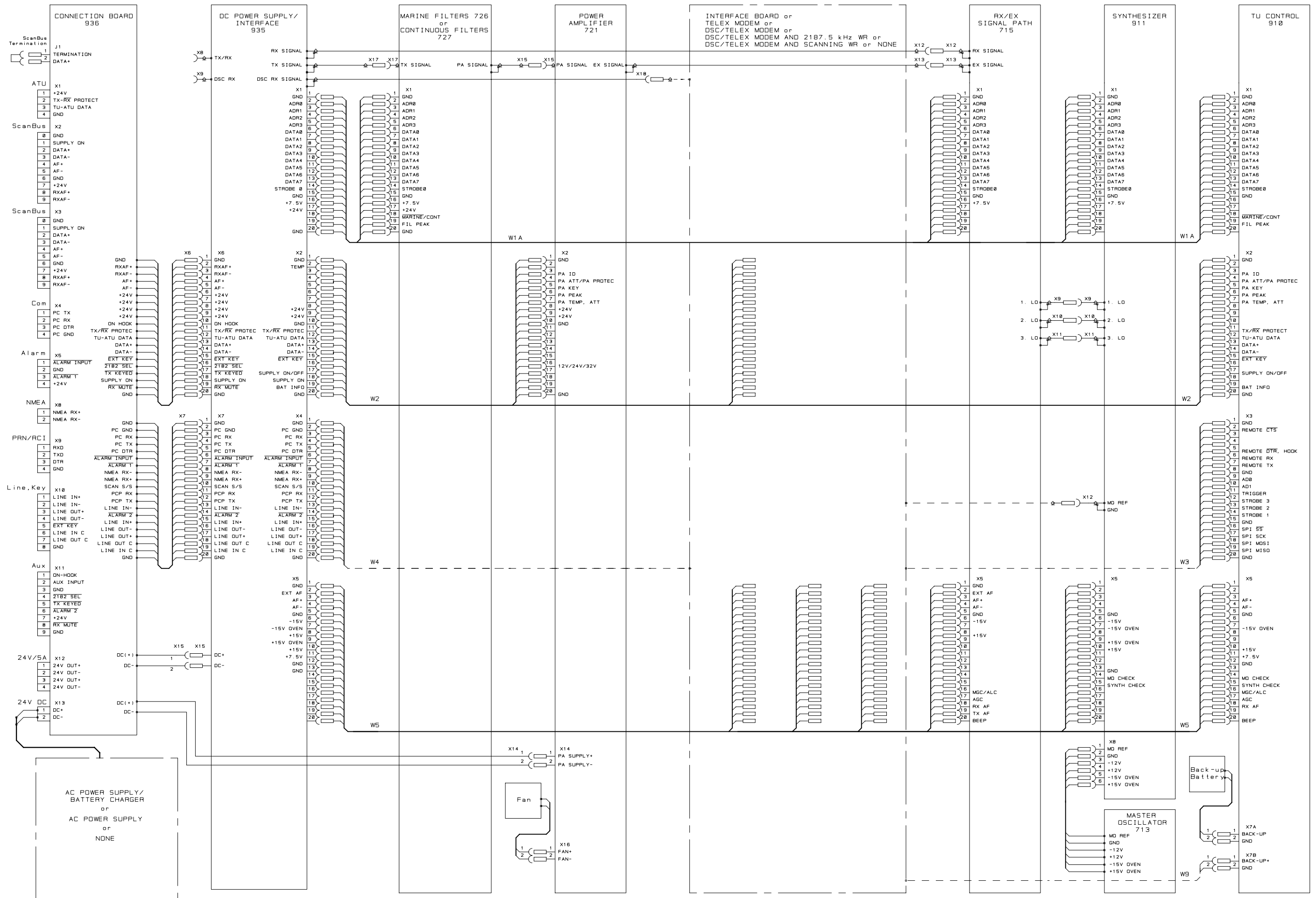

TRANSCIVER UNIT WIRING DIAGRAM

Issue H, 11/3-97 KK

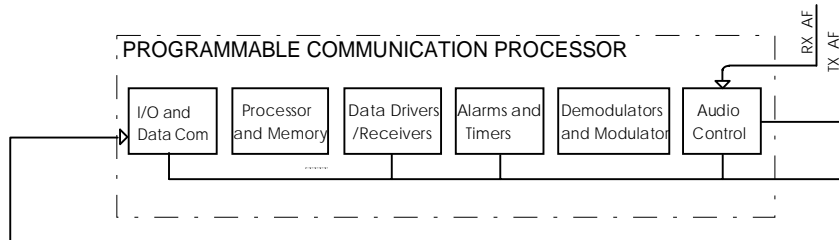

TELEX MODEM - DSC/TELEX MODEM BLOCK DIAGRAM

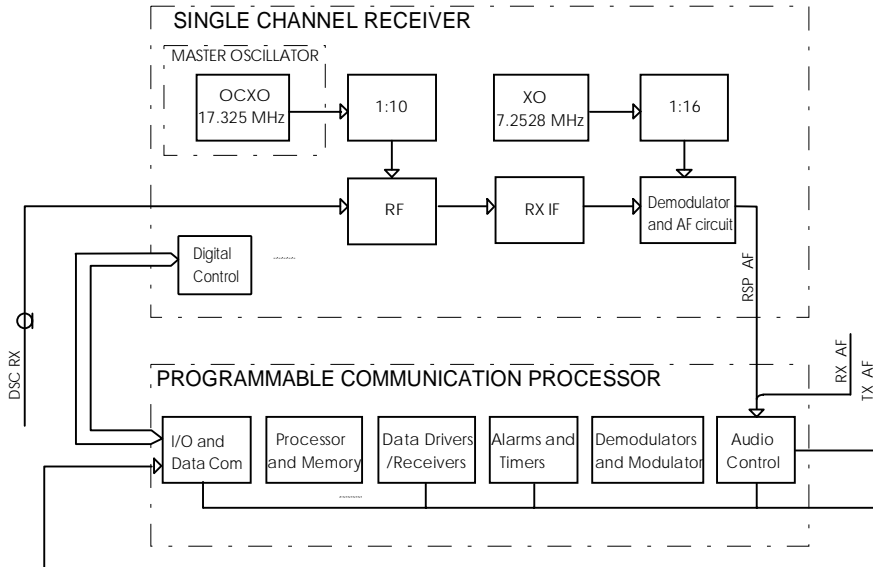

DSC/TELEX MODEM AND 2187.5 kHz WATCH RECEIVER BLOCK DIAGRAM

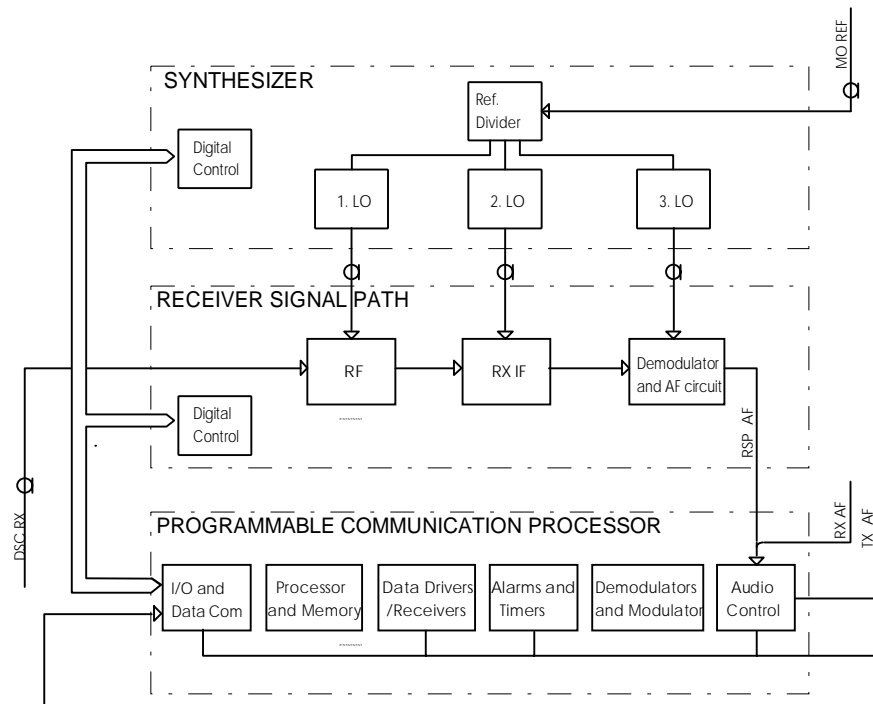

DSC/TELEX MODEM AND SCANNING WATCH RECEIVER BLOCK DIAGRAM

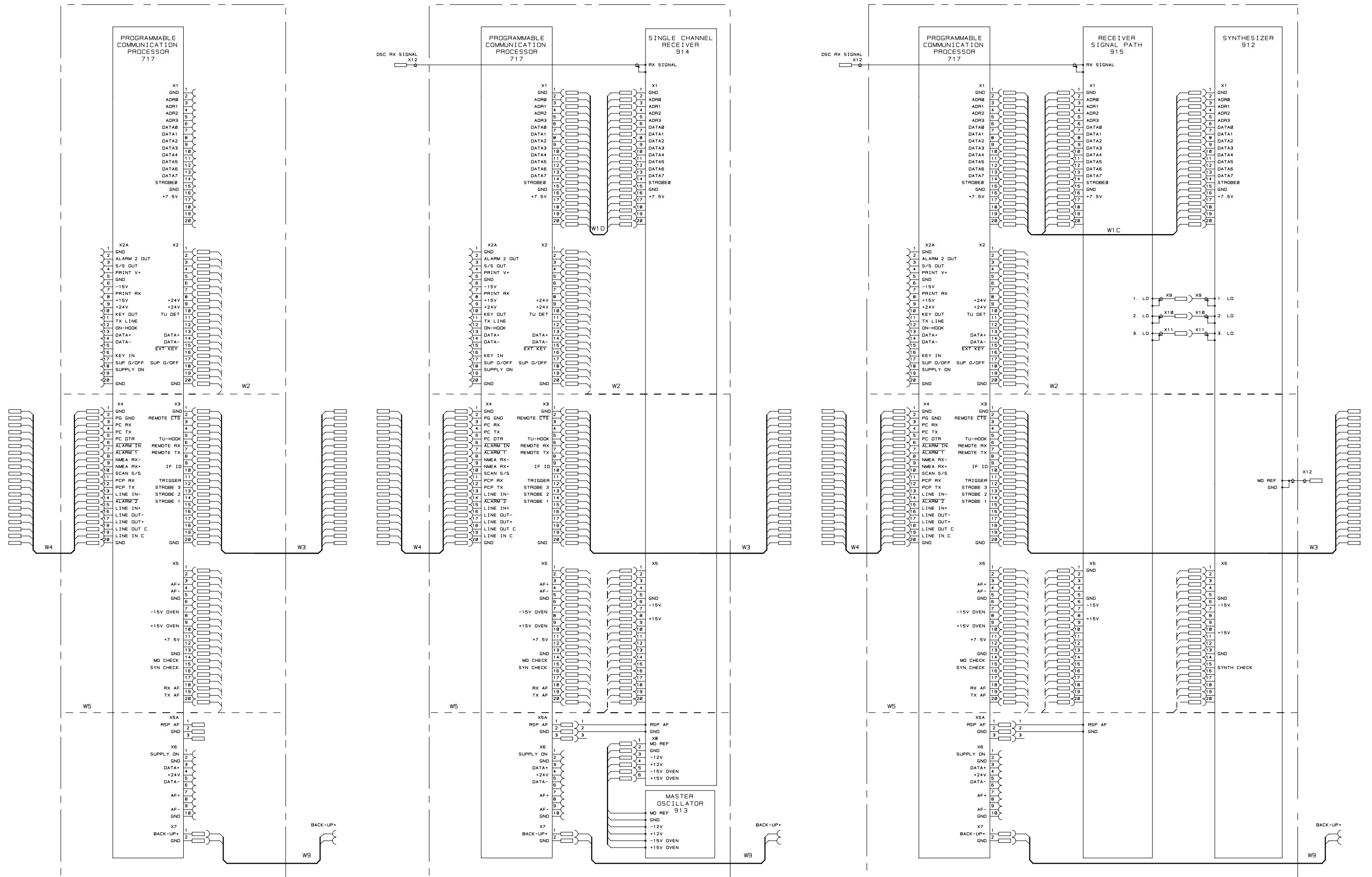

TELEX MODEM - DSC/TELEX MODEM
WIRING DIAGRAM

2187.5 kHz DSC WATCH RECEIVER
WIRING DIAGRAM

SCANNING DSC WATCH RECEIVER
WIRING DIAGRAM

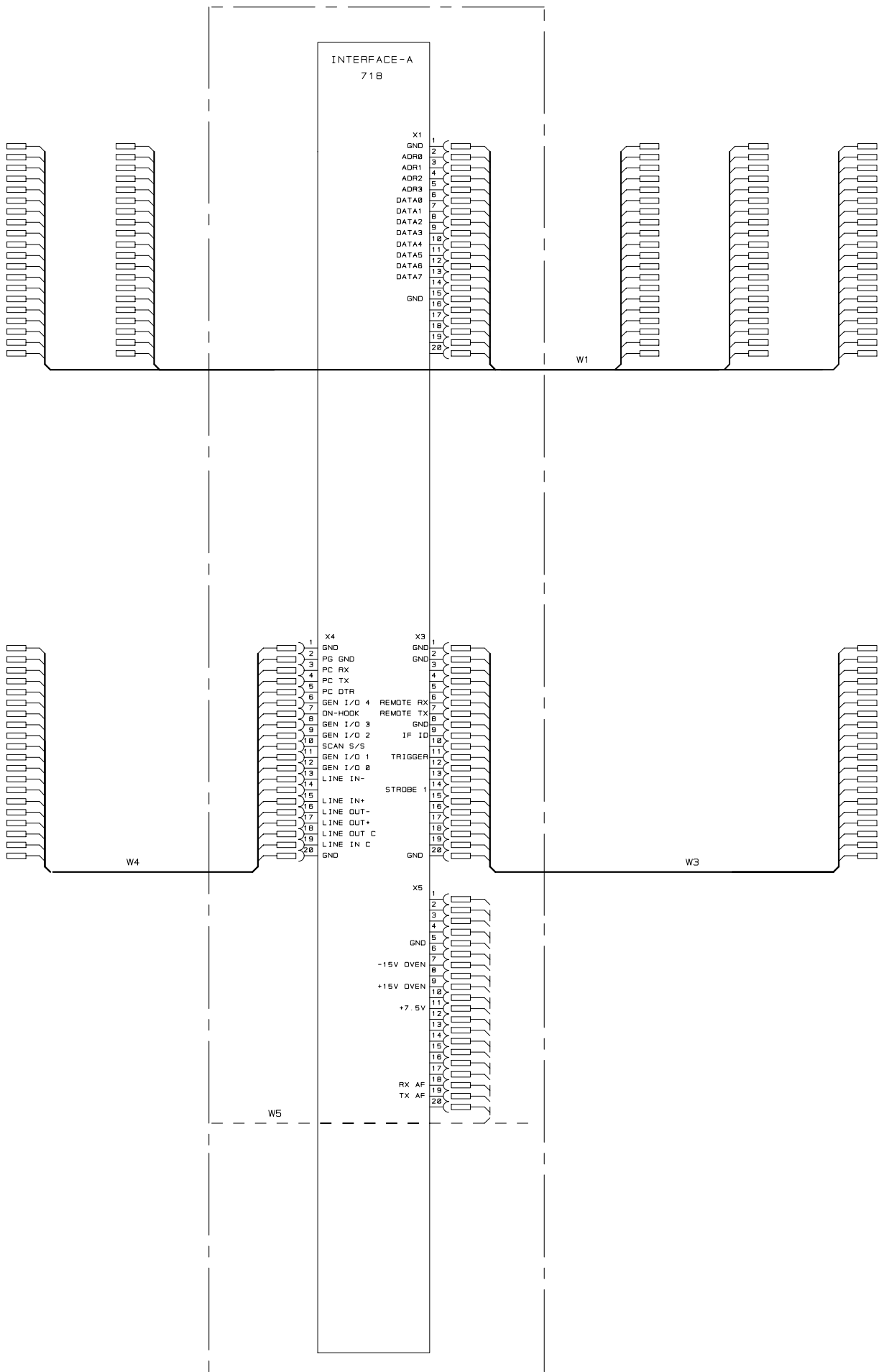

INTERFACE BOARD WIRING DIAGRAM

5. SERVICE Table of contents

Preventive Maintenance	5-3	Self Test	5-25
Realignment of Master Oscillator 713	5-3	Self Test Introduction	5-25
Method 1: Realignment using a frequency counter.	5-3	Self Test Description	5-25
Method 2: Realignment using the built-in 'Frequency Error' test	5-4	Execution Of The Automatic Stepped Selftest	5-26
Replacement of Backup Battery	5-5	Execution Of The Manual Stepped Selftest	5-27
Cleaning the Air Filter	5-6	Description Of Test Steps	5-28
Trouble Shooting	5-7		
Power Protection	5-8		
Service related 'Prog' key operations	5-17		

PREVENTIVE MAINTENANCE

Due to the modern design of the TRP 9250 preventive maintenance can be reduced to a minimum provided the equipment is correctly installed. To ensure maximum performance and minimum repair trouble we recommend you to follow the below stated headlines for preventive maintenance.

1. The condition of the battery should be checked at frequent intervals. The battery must always be fully charged and should be topped up frequently with distilled water (liquid should be 5 to 10 mm above the plates).
2. Check the condition of antenna installation, groundconnection and cables at regular intervals.
3. Keep antenna feed-through insulators clean and dry.
4. Ensure that no objects are obstructing the free airflow through the cooling channels of the Transceiver Unit and keep the units free of dust accumulation to prevent overheating.
5. For cleaning use a damp cloth. Sticky dirt may be removed using a cloth with a weak soap solution. Wipe off with a clean cloth.

Realignment of Master Oscillator 713

The Master Oscillator frequency should be checked at least once a year. The Master Oscillator determines the exact transmit and receive frequencies of the equipment. All oscillators age very slowly with time, typically with the highest drift rate the first year, approaching zero drift after some years.

There are two methods to realign the Master Oscillator. The first method is the most accurate and utilize a frequency counter. The adjustment should be performed by a qualified technician with the necessary test equipment at his disposal. The second method is based on the reception of an AM broadcast station or a CW signal with known good frequency accuracy. By using the User Programmable function: "Prog" "31" "Enter" (Show Frequency Error) TRP 9250 is able to display its own frequency error, which may be reduced to zero by simple adjustment of the Master Oscillator frequency. This method eliminates the need for an accurate frequency counter.

Method 1: Realignment using a frequency counter.

1. Measuring Equipment:

- | | | |
|-----|--------------------|-------------------------------|
| 1.1 | Frequency Counter: | Frequency range 100 MHz |
| | | Input impedance = 50 ohm |
| | | Sensitivity at least 0.2 Vrms |
| | | Accuracy better than 0.01ppm |

2. Preparations:

- 2.1 Switch on the power at least 30 minutes before adjustment.

- 2.2 Remove the front cover of the Transceiver Unit.
- 2.3 Locate and disconnect X10 carrying the 2. Local Oscillator signal from the Synthesizer Board 911 to RX/EX Signal Path 715S. Connect the frequency counter to the X10 socket on the synthesizer.
- 2.4 The ambient temperature should be within 10 to 30 deg. Celsius. Do not adjust the Master Oscillator shortly after long keying sequences of the transmitter. Be sure that thermal equilibrium has taken place before adjustment.

3. Realignment of Master Oscillator:

- 3.1 Locate the Master Oscillator adjustment hole in the metal shield of Synthesizer Board 911. Use a small screwdriver to gently adjust the frequency.
- 3.2 Adjust the frequency as close as possible to 44.544 000 MHz. Adjustment tolerance +/-1Hz.
- 3.3 Connect X10 and refit the top cover.

Method 2: Realignment using the built-in 'Frequency Error' test.

Note: A telex- or a narrow CW-filter must be installed before this method can be used.

Most AM broadcast stations have a frequency error in the order for 1 to 3 Hz and some have extremely high accuracy as they are frequency locked to atomic standards.

As the necessary measurement time is shorter on higher receiver frequencies choose higher frequencies for quick adjustment. The displayed frequency error of the equipment will be updated every 4 seconds when frequencies above 16 MHz are received. Below 500 kHz the displayed frequency error is updated every 256 seconds.

If the frequency accuracy of the received station is not known use the "Prog" "31" "Enter" feature on several stations to get a general picture of the frequency error.

This function can also be used frequently to check the frequency error of the equipment.

1. Preparations:

- 1.1 Switch on the power at least 30 minutes before adjustment.
- 1.2 The ambient temperature should be within 10 to 30 deg. Celsius. Do not adjust the Master Oscillator shortly after long keying sequences of the transmitter. Be sure that thermal equilibrium has taken place before adjustment.
- 1.3 Remove the top cover of the Transceiver Unit.
- 1.4 Choose a strong AM or CW signal with know good frequency stability.
- 1.5 Enter as receiver frequency the exact carrier frequency of the station to be used.
- 1.6 If an AM broadcast station is used, select AM mode and observe that the signal is received with not too strong fading and a reasonable signal to noise ratio. If these requirements are not fulfilled choose another station.

- 1.7 Press "Prog" "31" "Enter". The frequency error on the actual receiver frequency is shown in the receiver display and a clean 300 Hz tone should be heard in the loudspeaker. After each error measurement, at intervals depending on the magnitude of the receiver frequency, the display is updated and a short beep is heard in the loudspeaker.

2. Realignment of Master Oscillator:

- 2.1 Locate the Master Oscillator adjustment hole in the metal shield of Synthesizer Board 911. Use a small screwdriver to gently adjust the frequency.
- 2.2 Adjust the Master Oscillator until the displayed frequency error is as close as possible to zero. A clean 300 Hz tone should be heard in the loudspeaker.
- 2.3 If the bar-graph in the display, indicating the received signal strength, is changing rapidly by a large amount or the 300 Hz tone heard in the loudspeaker is not clean choose another station with better reception quality.
- 2.4 Refit the top cover.

Replacement of Backup Battery

TRP 9250 uses standard 1.5 V alkaline batteries to back-up the memory when the power supply is switched off. Use only the best quality for replacement to avoid leakage.

Skanti recommends:

DURACELL
Alkaline
1.5 V
MN1500 / LR6 / Size AA
3 pieces

The battery life time depends especially on temperature and working conditions, but is estimated to 3 to 4 years.

Every time the power supply is switched on the capacity of the back-up batteries is checked. When the capacity is becoming low the "Bat" annunciator in the display is switched on, showing that it is time to replace batteries. If the capacity becomes critically low the "Bat" annunciator will flash, indicating that memory contents may be lost when the power supply is switched off.

Note that only last set-up, user-programmable memory, Scan, Sweep and Sleep programs and user-configurable parameters are lost with a low voltage back-up battery, and that TRP 9250 is fully operational even without a back-up battery.

Battery Replacement:

Switch on the power supply to ensure no loss of memory contents when the battery pack is removed. Remove the front cover of the Transceiver Unit. The back-up battery pack is located at the left side of the chassis. Remove the battery pack. Change all three batteries and be sure to replace with correct polarity. Refit the cover. The power supply may now be switched off.

Cleaning the Air Filter

TRP 9250 uses a fan to cool the circuitry inside the Transceiver Unit. To keep the cooling air clean an Air Filter is placed behind the fan. The Air Filter should be cleaned frequently, especially under dusty working conditions. A dusty Air Filter will block efficient cooling and the transmitter output power is hence reduced to avoid over-heating.

Remove the Front Cover of the Transceiver Unit. Take out the Air Filter located between the fan and the Power Amplifier. Clean the Air Filter, refit it and re-assemble the unit.

TROUBLE SHOOTING

If a malfunction should occur in the TRP 9250, the following instructions should be followed in order to locate the module which is causing the malfunction :

1. If possible execute the built in selftest. An 'Error Code' for the failing module will be displayed. A description of the 'Error codes' is included on the following pages..
2. If an execution of the selftest failed, check that all cables and plugs are correctly connected, and that the supply voltage is correct. At this point the fuses should be checked.
3. If the Control Unit display is flashing all annunciators, it indicates missing data communication between the Control Unit and the Transceiver Unit. This could be caused by a bad cable connection on the data wire between the 2 units.
4. The next step is to open the Transceiver Unit and :
 - a. Check internal fuses, cables and plugs.
 - b. Check that the left LED (Light Emitting Diode) on the SMPS assembly is constantly on; indicating that the Switch Mode Power Supply is on and able to produce +7.5 V DC.
 - c. Check that the second left LED on TU Control Board 910 is flashing twice a second, indicating that the microcomputer is operating properly.
 - d. Check that the LED on the optional PCP 717S is flashing once every 2 seconds, indicating that the microprocessor is operating properly.
5. If the above steps did not help, please contact your local SKANTI Service Agent. A list of SKANTI Service Agents is found in the rear part of this chapter.

POWER PROTECTION

The TRP 9250 Power and Protection system is monitoring the transmitter circuits during transmission and will automatically maximize the radiated power to safe limits. If a problem occurs the flashing 'Protec' annunciator on the Control Unit display shows that protection is activated. The current status of the Power and Protection monitor is presented in form of protection codes and may be requested at any time by pressing:



The Receiver Display will show the Protection Code. If more than one Protection Code is set, successively pressing "Enter" will show the rest and finally make a return to normal operation. Protection is automatically reset when the transmit conditions are normalized.

Protection Code Groups:

<u>No.</u>	<u>Group</u>
00	No protection set
10 - 17	TU power regulation problems. Perform a Self Test.
20 - 23	TU hardware protection.
40 - 51	ATU protection.

Protection Code explanation:

0**No protection**

Protection codes 10 - 17 in general: Failure in power regulation loop

Perform an Automatic Self Test for tests 1 -33 and a Step Mode Self Test for tests 34 and 35.

10**Tune Power Low**

Measurement:	TU Control Board measures too low power output. Tune power < 30W.
Protection made:	ATU selects feed through setting after "TU Failure" command. Power regulation inhibited
Display:	Flash "Protec".
Possible error source:	TU - ATU coaxial cable open.

11**Tune Power High**

Measurement:	TU Control Board measures too high power output. Tune power > 40W.
Protection made:	ATU selects feed through setting after "TU Failure" command.
Display:	Flash "Protec".

12**ALC Power High**

Measurement:	TU Control Board measures too high power output. ALC power was too high.
Protection made:	Exciter level set to ~+12dBm.
Display:	Flash "Protec".

13**Supply failure**

Measurement:	Supply voltage high.
Protection made:	TX key inhibit.
Display:	Flash "Protec".

14**ALC Power Low**

Measurement: TU Control Board measures too low power output.
ALC power was too low.

Protection made: Exciter level set to ~+12dBm.

Display: Flash "Protec".

15**TU-ATU Failure**

Measurement: TU Control Board measures too high power output.
TX power was too high.

Protection made: Automatic power regulation inhibited.

Display: Flash "Protec".

16**Med/Low High**

Measurement: TU Control Board measures too high power output.
Medium or Low Power was too high.

Protection made: Power set as Low as possible.

Display: Flash "Protec".

17**Full High**

Measurement: TU Control Board measures too high power output.
Full Power was too high.

Protection made: Automatic power regulation inhibited.

Display: Flash " Protec".

20 - 23: TU protection by TU hardware**20****PA Temp**

Measurement:	PA temperature too high. PA/Temp Att = 1 and PA Att/PA Protect = 1.
Protection made:	Output power decreased by 14 dB.
Display:	Flash "Protec".
Possible cause:	Air filter blocked.

21**PA SWR high**

Measurement:	PA SWR was too high. Reflected power was detected. PA Temp Att = 0 and PA Att PA Protect = 1.
Protection made:	Output power decreased by 14 dB.
Display:	Flash "Protec".
Possible cause:	TU - ATU coaxial cable or antenna.
Note:	It is necessary to select low power or to switch off the equipment to reset the protection

22**High Average**

Measurement:	Average power reduced to 100W.
Possible cause:	CW keyed for more than 1 minute.

23**PA Hot**

Measurement:	PA temperature continuously high. PA/Temp Att = 1 and PA At/ PA Protect = 1 in more than 5 min.
Protection made:	Key inhibit for 5 min.
Display:	Flash "Protec".
Possible cause:	Fan failure or air filter blocked.

24**TX Inhibit**

Measurement:	External "TX Inhibit" input is activated.
Action made:	TX key inhibit.

25**PA SWR**

Measurement:	PA SWR was high.
Protection made:	Output power reduced to safe limits.
Possible cause:	High SWR or change in antenna impedance.

40 - 51: ATU protection**40****Not Tuned**

Measurement:	ATU failed tuning the antenna.
Protection made:	ATU selects feed through setting.
Display:	Flash "Protec".
Possible cause:	Antenna installation.

41**No Tune Power**

Measurement:	ATU measured no tune power.
Protection made:	ATU selects feed through setting.
Display:	Flash "Protec".
Possible cause:	TU - ATU coaxial cable shorted.

42**Bad SWR**

Measurement:	ATU measured SWR>8 during Tune Procedure.
Protection made:	ATU selects feed through setting.
Display:	Flash "Protec".
Possible cause:	Bad antenna impedance on the selected frequency.

43**High SWR**

Measurement:	ATU measured SWR >3 but <8 during Tune Procedure.
Possible cause:	Poor antenna impedance on the selected frequency.

44**V or I**

- Measurement: ATU measured that the maximum voltage or current rating is reached during ALC adjustment.
- Possible cause: A short antenna and a low frequency.

45**Temp**

- Measurement: ATU requests for lower power during TX.
- Possible cause: Temperature inside ATU cabinet is too high.

46**Bad SWR TX**

- Measurement: ATU measured SWR>8 during transmission.
- Display: Flash "Protec".
- Possible cause: Bad antenna impedance on the selected frequency.

47**High SWR TX**

- Measurement: ATU measured SWR >3 but <8 during transmission.
- Possible cause: Poor antenna impedance on the selected frequency.

48**V or I high TX**

- Measurement: ATU measured that the maximum voltage or current rating is reached during transmission.
- Possible cause: A short antenna and a low frequency.

50**V or I high**

Measurement: ATU measured that the maximum voltage or current rating is reached during ALC adjustment and the power had to be reduced more than 6 dB.

Possible cause: A bad antenna and a low frequency.

51**TU-ATU com bad**

Measurement: TU - ATU communication is not operating.

Protection made: Key inhibit.

Display: Flash "Protec".

Possible cause: TU - ATU communication problem.

SERVICE RELATED 'PROG' KEY OPERATIONS

By using the 'Prog' key extra functions and features may be selected, and programming of the equipment is possible.

'Prog' operations are selected by pressing:



Some functions requires further key entries where as others requires storing of parameters with the 'STO' key or stepping forward with the 'Volume Up' key.

The following is a list of the Functions which are selected by their number:

0 - 9 : Select modes and features. Refer to OPERATION section.

10 - 19 : Select special functions. Refer to OPERATION section.

20 - 74 : Service or installation.

98 : Security Code. Refer to OPERATION section.

99 : Select Configuration Mode. Refer to INSTALLATION section.

<u>No.</u>	<u>Function</u>
0 :	Leave System to other User.
1:	Connect TCU Remote Control port
2 :	Select LSB Mode.
3 :	Select R3E Mode.
4:	Set Side Tone frequency for CW.
5:	Set Break-in Time for CW.
6 :	Switch RF Attenuator On/Off.
7 :	Float Antenna.
8 :	Ground Antenna.
9 :	Switch "Boop" Sound On/Off.
10:	Select Intercom.
11:	Set Real Time Clock.
12:	Switch Treble Cut On/Off
13:	Tilt Viewing Angle of Display.
14:	Toggle Bar-graph Reading, Power or Amperes.
15:	Set Beep Level.

- 16: *Select HST mode.*
- 20: **Automatic Stepped Self-test.**
- 21: **Manually Stepped Self-test.**
- 22: **Read Protection Code.**
- 23: **View ATU Relay Setting.**
- 25: **Read CU Priority / Intercom Number.**
- 26: **View CU Software Version, Release and Release Date.**
- 27: **View TU Software Version, Release and Release Date.**
- 28: **View TU Configuration Customer ID, Version, Release and Release Date.**
- 29: **View ATU Software Version, Release and Release Date.**
- 30: **Read Accumulated On Time.**
- 31: **Read Frequency Error**
- 32: **View RX / EX Signal Path 715 Version.**
- 33: **View Option Filter.**
- 34: **View Power Amplifier Version.**
- 35: **View PA Filter Version.**
- 36: **View ATU Status.**
- 37: **View Dummy Load.**
- 38: **View ATU Fan.**
- 39: **View Optional Interface Board.**
- 40 **Switch all Annunciators On in Display.**
- 41 **Switch Beep Sound On.**
- 42 **Switch Boop Sound On.**
- 43 **Switch High-beep Sound On.**
- 45 **Display Customer Secified Frequencies Pre-Programmed in Configuration PROM.**
- 46 **Display Configuration parameters pre-programmed in Configuration PROM.**
- 74 **View Supply Voltage**
- 98 *View and Change Security Code.*
- 99 **Select Configuration Mode.**

Description of related 'Prog' operationsNo.Function

2

0

Automatic Stepped Self-test.

The Automatic Stepped Self-test is started and the step number together with the error code is shown in the Display. The Self-test may be interrupted by pressing the "Enter" key. If an error is detected the Self-test is stopped with step number and error code constantly displayed, until "Enter" is pressed which makes a return to normal operation. See description of the Self-test.

2

1

Manually Stepped Self-test.

The Manually Stepped Self-test is started from a user selectable step number.

Press: "Prog" "21" "Enter" "Step Number" "Enter"

The step number and error code is displayed as under Automatic Stepped Self-test. To perform the same step number once more press: "Volume Down". To perform the next step number press: "Volume Up". Pressing "Enter" will make a return to normal operation. See description of the Self-test.

2

2

Read Protection Code.

Press "Prog" "22" "Enter" and the Protection Code will be shown in the Receiver Display if protection is activated. If more than one Protection Code is set, successively pressing "Enter" will show all codes and finally make a return to the normal operation.

If environmental or installational conditions, such as too high temperature or bad antenna installation is encountered, protection automatically takes place. The radiated power is adjusted to the best possible performance under the deteriorated operating conditions.

If operating conditions becomes too bad forcible protection takes place in order not to destroy the equipment. This condition is shown by flashing the "Protec" annunciator in the Display. See description of the Protection Codes.

2

3

View ATU Relay Setting.

This function starts the ATU tuning the antenna on the displayed transmitter frequency. After tuning, the ATU relay setting is displayed as 0's and 1's. The first 12 relay settings are displayed and then by successively pressing "Enter" the following are displayed: the next 12 relay settings, the remaining 3 relay settings and finally the current limit values in amperes, obtained from one of the three current detectors.

Pressing "Enter" once more will make a return to normal operation.

2

5

Read CU Priority / Intercom Number.

The Receiver Display will show the Priority / Intercom Number of the Control Unit in use.

Pressing "Enter" will make a return to normal operation.

2

6

View CU Software version, release and release date.

Displays CU Software version, release and release date.

Receiver Display: Version and Release number as **VV.RR**.

Transmitter Display: Release date as **YY MM DD**.

Pressing "Enter" will make a return to normal operation.

2

7

View TU Software version, release and release date.

Displays TU Software version, release and release date.

Receiver Display: Version and Release number as **VV.RR**.

Transmitter Display: Release date as **YY MM DD**.

Pressing "Enter" will make a return to normal operation.

2

8

View TU Configuration version, release, customer ID and release date.

Displays TU Configuration version, release, customer ID and release date.

Receiver Display: Customer ID, Version and Release number as **II VV.RR**

Transmitter Display: Release date as **YY MM DD**.

Pressing "Enter" will make a return to normal operation.

2

9

View ATU Software version, release and release date.

Displays ATU software version and release date.

Receiver Display: Version and Release number as **VV.RR**.

Transmitter Display: Release date as **YY MM DD**.

Pressing "Enter" will make a return to normal operation.

3

0

Read Accumulated On Time.

The Accumulated On Time in hours is displayed in the Receiver Display. Pressing "Enter" will make a return to normal state.

If the build-in back-up battery is removed while the supply is switched off, the total user-programmable memory will be erased and the Accumulated On Time will be set to "0".

3

1

Show Frequency Error.

For Master Oscillator check/realignment without a frequency counter. Please refer to Preventive Maintenance description at page 5-4.

3

2

View RX / EX Signal Path 715.

The Receiver Display shows version number.

"7" is the standard version.

Pressing "Enter" will make a return to normal operation.

3

3

View Option Filter used for telex/DSC or CW reception.

The Receiver Display shows if an optional filter is installed on RX / EX Signal Path 715:

"0" if no Option Filter is installed.

"1" if the Option Filter is installed

Pressing "Enter" will make a return to normal operation.

3

4

View Power Amplifier Version.

The Receiver Display shows the PCB number of the installed Power Amplifier Assembly.

Power Amplifier 721

Pressing "Enter" will make a return to normal operation.

3

5

View PA Filter Version.

The Receiver Display shows the PCB number of the installed PA Filter.

Marine Filters 726

Continuous Filters 727

Pressing "Enter" will make a return to normal operation.

3

6

View ATU Status.

The Receiver Display shows the status of the ATU:

"0" if the ATU is not installed.

"1" if the ATU is installed.

"3" if the TU - ATU data communication has failed.

Pressing "Enter" will make a return to normal operation.

3

7

View Dummy Load.

The Receiver Display shows if the optional Dummy Load / Antenna amp.941 is installed in the ATU:

"0" if no optional board is installed in the ATU.

"741" if the Dummy Load/Antenna amp. 741 is installed.

Pressing "Enter" will make a return to normal operation.

3

9

View Optional Interface Board

The PCB number will be displayed in the Receiver Display.

4

0

Switch All Annunciators On in display.

All annunciators in the display are switched on.

Pressing "Enter" will make a return to normal operation.

4

1

Switch Beep Sound On.

The Beep is sounded constantly.

Pressing "Enter" will make a return to normal operation.

4

2

Switch Boop Sound On.

The Boop is sounded constantly.

Pressing "Enter" will make a return to normal operation.

4

3

Switch High-beep Sound On.

The High-beep is sounded constantly.

Pressing "Enter" will make a return to normal operation.

4

5

Display Customer Specified Frequencies pre-programmed in Configuration PROM.

By pressing "Volume Up" all the frequencies and their corresponding modes are successively displayed. If "RX" / "TX" is pressed the displayed frequency will be transferred to the Receiver / Transmitter respectively.

Pressing "Enter" while the pre-programmed frequencies are displayed will make a return to normal operation.

4

6

Display Configuration parameters pre-programmed in Configuration PROM.

By pressing "Volume up" the address and corresponding data are successively shown in the receiver and transmitter display e.g.:

```
RX a    7593
```

```
TX d      0
```

Pressing "Volume down" will display the data on the previous address.

Pressing "Enter" will make a return to normal operation.

7

4

View Supply Voltage

Displays the actual TU supply voltage at the moment the function is executed. e.g. 24.7 Volt is displayed as "24.7" in the receiver display.

Pressing "Enter" will make a return to normal operation.

SELF TEST INTRODUCTION

The 'SELF TEST' BITE (Built-In Test Equipment) of the TRP 9250 is used as a fault diagnosing tool for the service technician. It may also be used by the operator to obtain additional information on a problem when ordering service.

The 'SELF TEST' checks the vital functions of the TRP 9250 by performing and monitoring a sequence of operations. The program controls the analog and digital set ups necessary to perform each test step in the line of tests executed during the 'SELF TEST'. These set ups will result in a digital feed back from the 'Check Detectors' located on most of the PCBs in the TRP 9250. The test-result from each test step will be displayed on the Receiver display of the Transceiver Control Unit

SELF TEST DESCRIPTION

The self test is performed in two different modes : 'Automatic Mode' and 'Manual Mode'.

'Automatic Mode' is used for verification of all functions, except the ones where PA power is applied. All tests will automatically be performed succesively until the last test has passed or an error condition has occurred.

The 'Manual Mode' is used to test the transmitter or for service purposes. In this mode the tests are performed one by one. Tests may be repeated several times giving a technician the opportunity to make measurements.

A 'Self Test' should always be initiated in 'Automatic Mode' as this will start the test at 'Test 1' and automatically proceed until an error is encountered. Note. If a 'Self Test' is started in 'Manual Mode' on an arbitrary test number this may provide false indication to where the problem lies as the 'Self Test' assumes that all previous test numbers has been performed and found OK.

During the 'Self Test' the test number is displayed in the 'RX' display and the test result is displayed in the 'TX' display. "Passed" is displayed when the test has passed and "Bypass" is displayed if the module to test is optional and not installed. If an error is encountered the 'TX' display shows an 'Error Code'. Explanations to the 'Error Codes' are listed on the following pages.

STEP 8 RX display

3 types of test result may be displayed for each test step:

1. This test is OK.

PASSED TX display

2. This test has failed.
Refer to Error Code description.

err 1

3. This test is not performed because the module to be tested is not installed.

bypass

EXECUTION OF THE AUTOMATIC STEPPED SELFTEST

The automatic stepped test sequence is started by pressing :

Prog

2

0

Enter

. Test numbers **1 to 33** will be performed.

When this test mode is chosen, the display will show "auto test" a few seconds.



```

auto
test

```

Then all tests except transmitter test, will be carried out, until an error condition occurs, or all tests are finished.

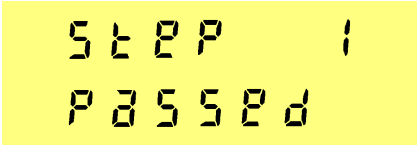

```

STEP 1
PASSED

```

If an error is detected, please refer to descriptions of 'Error Codes' where a possible error source is listed.

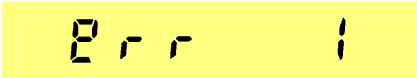

```

err 1

```

When the 'Automatic Stepped Self Test' has stopped, the test result is displayed for a few seconds, whereupon the transceiver returns to normal operation.

It is possible to interrupt the automatic test, by pressing

Enter

EXECUTION OF THE MANUAL STEPPED SELFTEST

This test is carried out by entering :

Prog

2

1

Enter

. Test numbers **1 to 35** may be performed.

The display will now show "step test" a few seconds.



STEP
TEST

Enter the number of the test you want to performe.

and press

Enter

:



STEP
TEST

The selected test number is now performed.

There are three options to proceed , either press



to perform the next test or press



to perform the same test again.

Enter

If is pressed, the transceiver will return to normal operation.

This will happen too, if



is pressed after test number 35 has been performed.

DESCRIPTION OF TEST STEPS**TEST 1**

Test 1 tests the output voltages (+15V, +30V, - 15V) of the SMPS PCB 932 and the temperature of the SMPS PCB 931/932. TU 9500 only, bypassed for TU 9250.

<u>Error code</u>	<u>Possible error source</u>	<u>PCB</u>
00	OK	
01	Output voltage Cabling 932 - 933	932/933
02	Hot SMPS SMPS fans or air filters	931/932

TEST 2

Test 2 tests the AF path on PCB 715 and PCB 935/937. The test is carried out, by turning off the microprocessor controlled tone generator and turning RXAF on. AF check and RXAF check are both checked for silence.

<u>Error code</u>	<u>Possible error source</u>	<u>PCB</u>
00	OK	
01	AF line, tone shape, volume Cabling 910 - 715	715
02	AF output amplifier Cabling 910 - 935/937	935/937

TEST 3

Test 3 tests the AF path on PCB 715 and PCB 935/936. The test is carried out, by turning on the microprocessor controlled tone generator and RXAF on. A 1 kHz tone is generated during this test. AF check and RXAF check are both checked for tone.

<u>Error code</u>	<u>Possible error source</u>	<u>PCB</u>
00	OK	
01	AF line, tone shape, volume, tone generator Cabling 910 - 715	715
02	AF output amplifier ScanBus RXAF+, RXAF- shortcircuit Cabling 910 - 935/936	730

TEST 4

Test 4 tests the volume control on RX/EX Signal Path PCB 715. The test is carried out, by turning on the microprocessor controlled tone generator, and verifying that AF check toggles condition, and keeps it with increasing volume level. Mute is checked in a similar way.

<u>Error code</u>	<u>Possible error source</u>	<u>PCB</u>
00	OK	
01	Volume control Cabling 910 - 715	715
02	AF mute Cabling 910 - 715	715

TEST 7

Test 7 tests Master Oscillator PCB 712/713.
Tests if the MO is oscillating, using MO check.

<u>Error code</u>	<u>Possible error source</u>	<u>PCB</u>
00	OK	
01	Master oscillator Cabling 910 - 911 or 911 - 712/713	712/713

TEST 8

Test 8 tests Synthesizer PCB 911, all local oscillators.
Tests that the synthesizer is able to lock in midrange .
Band : 45 - 52.5 MHz
1.LO : 50.00000 MHz
3.LO : 456.50 kHz.
The test is OK if SYNCHECK = 1.

<u>Error code</u>	<u>Possible error source</u>	<u>PCB</u>
00	OK	
01	Synthesizer Cabling 910 - 911	911

TEST 9

Test 9 tests Synthesizer PCB 911, 1. LO.

Tests if 1. LO is able to get out of lock to check that the microprocessor can control synthesizer.

Band : 45 - 52.5 MHz.

1.LO : 75.00000 MHz

3.LO : 456.50 kHz.

The test is OK if SYNCHECK = 0.

<u>Error code</u>	<u>Possible error source</u>	<u>PCB</u>
00	OK	
01	Synthesizer Cabling 910 - 911	911

TEST 10

Test 10 tests Synthesizer PCB 911, 1. LO.

Tests if 1. LO is able to lock in band 0, low border.

Band : 45 - 52.5 MHz

1.LO : 45.00000 MHz

3.LO : 456.50 kHz

The test is OK if SYNCHECK = 1.

<u>Error code</u>	<u>Possible error source</u>	<u>PCB</u>
00	OK	
01	Synthesizer Cabling 910 - 911	911

TEST 11

Test 11 tests Synthesizer PCB 911, 1. LO.

Tests if 1. LO is able to lock in band 0, high border.

Band : 45 - 52.5 MHz

1.LO : 52.50000 MHz

3.LO : 456.50 kHz

The test is OK if SYNCHECK = 1.

<u>Error code</u>	<u>Possible error source</u>	<u>PCB</u>
00	OK	
01	Synthesizer Cabling 910 - 911	911

TEST 12

Test 12 tests Synthesizer PCB 711, 1. LO.
 Tests if 1. LO is able to lock in band 1, low border.
 Band : 52.5 - 60 MHz
 1.LO : 52.50000 MHz
 3.LO : 456.50 kHz
 The test is OK if SYNCHECK = 1.

<u>Error code</u>	<u>Possible error source</u>	<u>PCB</u>
00	OK	
01	Synthesizer Cabling 910 - 911	911

TEST 13

Test 13 tests Synthesizer PCB 911 1. LO.
 Tests if 1. LO is able to lock in band 1, high border.
 Band : 52.5 - 60 MHz
 1.LO : 60.00000 MHz
 3.LO : 456.50 kHz
 The test is OK if SYNCHECK = 1.

<u>Error code</u>	<u>Possible error source</u>	<u>PCB</u>
00	OK	
01	Synthesizer Cabling 910 - 911	911

TEST 14

Test 14 tests Synthesizer PCB 911, 1. LO.
 Tests if 1. LO is able to lock in band 2, low border.
 Band : 60 - 67.5 MHz
 1.LO : 60.00000 MHz
 3.LO : 456.50 kHz
 The test is OK if SYNCHECK = 1.

<u>Error code</u>	<u>Possible error source</u>	<u>PCB</u>
00	OK	
01	Synthesizer Cabling 910 - 911	911

TEST 15

Test 15 tests Synthesizer PCB 911, 1. LO.
 Tests if 1. LO is able to lock in band 2, high border.
 Band : 60 - 67.5 MHz
 1.LO : 67.50000 MHz
 3.LO : 456.50 kHz
 The test is OK if SYNCHECK = 1.

<u>Error code</u>	<u>Possible error source</u>	<u>PCB</u>
00	OK	
01	Synthesizer Cabling 910 - 911	911

TEST 16

Test 16 tests Synthesizer PCB 911, 1. LO.
 Tests if 1. LO is able to lock in band 3, low border.
 Band : 67.5 - 75 MHz
 1.LO : 67.50000 MHz
 3.LO : 456.50 kHz
 The test is OK if SYNCHECK = 1.

<u>Error code</u>	<u>Possible error source</u>	<u>PCB</u>
00	OK	
01	Synthesizer Cabling 910 - 911	911

TEST 17

Test 17 tests Synthesizer PCB 911, 1. LO.
 Tests if 1. LO is able to lock in band 3, high border.
 Band : 67.5 - 75 MHz
 1.LO : 75.00000 MHz
 3.LO : 456.50 kHz
 The test is OK if SYNCHECK = 1.

<u>Error code</u>	<u>Possible error source</u>	<u>PCB</u>
00	OK	
01	Synthesizer Cabling 910 - 911	911

TEST 18

Test 18 tests Synthesizer PCB 911, 3. LO.

Tests if 3. LO is able to get out of lock to check that the microprocessor can control the synthesizer.

Band : 67.5 - 75 MHz

1.LO : 75.00000 MHz

3.LO : 400.00 kHz

The test is OK if SYNCHECK = 0.

<u>Error code</u>	<u>Possible error source</u>	<u>PCB</u>
00	OK	
01	Synthesizer Cabling 910 - 911	911

TEST 19

Test 19 tests Synthesizer PCB 911, 3. LO.

Tests if the synthesizer is able to lock 3. LO, low border.

Band : 67.5 - 75 MHz

1.LO : 70.00000 MHz

3.LO : 452.50 kHz

The test is OK if SYNCHECK = 1.

<u>Error code</u>	<u>Possible error source</u>	<u>PCB</u>
00	OK	
01	Synthesizer Cabling 910 - 911	911

TEST 20

Test 20 tests Synthesizer PCB 911, 3. LO.

Tests if the synthesizer is able to lock 3. LO, high border.

Band : 67.5 - 75 MHz

1.LO : 70.00000 MHz

3.LO : 460.50 kHz

The test is OK if SYNCHECK = 1.

<u>Error code</u>	<u>Possible error source</u>	<u>PCB</u>
00	OK	
01	Synthesizer Cabling 910 - 911	911

TEST 21

Test 21 performs receiver test on RX/EX Signal Path PCB 715 in SSB mode and with SSB filter. By choosing the right synthesizer frequency the signal passes the 45 MHz filter and is mixed to a 1 kHz tone in the audio part. This makes the Automatic Gain Control lower the sensitivity and the AF check indicating AF. RX mute is also checked.

Band : 45 - 52.5 MHz

1.LO : 44.99900 MHz

3.LO : 456.00 kHz

<u>Error code</u>	<u>Possible error source</u>	<u>PCB</u>
00	OK	
01	Receiving signal path Cabling 910 - 715 or 911 - 715	715
02	AGC Cabling 910 - 715 or 911 - 715	715
03	RX mute	715

TEST 22

Test 22 performs receiver test on RX/EX Signal Path PCB 715 in AM mode and with AM filter. By choosing the right synthesizer frequency the signal passes the 45 MHz filter and is mixed to generate an unmodulated carrier . This makes the Automatic Gain Control lower the sensitivity and the AF check indicating no AF. Band : 45 - 52.5 MHz

1.LO : 44.99900 MHz

3.LO : 456.00 kHz

<u>Error code</u>	<u>Possible error source</u>	<u>PCB</u>
00	OK	
01	Receiving signal path, AM detector Cabling 910 - 715 or 911 - 715	715
02	AGC Cabling 910 - 715 or 911 - 715	715

TEST 23

Test 23 performs receiver test on RX/EX Signal Path PCB 715 in Telex mode and with Telex filter, if a such is mounted. By choosing the right synthesizer frequency the signal passes the 45 MHz filter and is mixed to a 1 kHz tone in the audio part. This makes the Automatic Gain Control lower the sensitivity and the AF check indicating AF.

Band : 45 - 52.5 MHz

1.LO : 44.99900 MHz

3.LO : 456.00 kHz

<u>Error code</u>	<u>Possible error source</u>	<u>PCB</u>
00	OK	
01	Receiving signal path, option filter Cabling 910 - 715 or 911 - 715	715
02	AGC Cabling 910 - 715 or 911 - 715	715
99	No optional filter installed	715

TEST 24

Test 24 tests squelch on RX/EX Signal Path PCB 715.

By choosing the right synthesizer frequency the signal passes the 45 MHz filter and is mixed to a 500 Hz tone in the audio part. This makes the squelch open. Then a 2 kHz is generated making the squelch close. Squelch hold time is also checked.

Band : 45 - 52.5 MHz

1.LO : 44.99900 MHz

3.LO : 456.00 kHz

3.LO : 457.00 kHz

<u>Error code</u>	<u>Possible error source</u>	<u>PCB</u>
00	OK	
01	Squelch circuit not able to open Cabling 910 - 715 or 911 - 715	715
02	Squelch circuit not able to close Cabling 910 - 715 or 911 - 715	715
03	Squelch hold time	715

TEST 25

Test 25 tests manual Gain Control on RX/EX Signal Path PCB 715. By choosing the right synthesizer frequency the signal passes the 45 MHz filter and is mixed to a 1 kHz tone in the audio part. By controlling the Manual Gain Control to low sensitivity the AF check indicates no AF. High sensitivity shows AF present.

Band : 45 - 52.5 MHz

1.LO : 44.99900 MHz

3.LO : 456.00 kHz

<u>Error code</u>	<u>Possible error source</u>	<u>PCB</u>
00	OK	
01	Not able to lower MGC Cabling 910 - 715 or 911 - 715	715
02	Not able to rise MGC Cabling 910 - 715 or 911 - 715	715

TEST 26

Test 26 tests Automatic Gain Control Hang facility on RX/EX Signal Path PCB 715.

Examine hang function in three steps:

- 1) Check normally AGC (with 1 kHz tone)
- 2) Check that AGC hangs (without signal)
- 3) Check that AGC hang has ended (without signal)

Band : 45 - 52.5 MHz

1.LO : 44.99900 MHz

3.LO : 456.00 kHz

Band : 67.5 - 75 MHz

1.LO : 80.00000 MHz

3.LO : 456.00 kHz

<u>Error code</u>	<u>Possible error source</u>	<u>PCB</u>
00	OK	
01	AGC Cabling 910 - 715 or 911 - 715	715
02	AGC hang facility	715

TEST 27

Test 27 performs exciter test on RX/EX Signal Path PCB 715 in SSB mode and with SSB filter and no input. The exciter is set up to produce 15 MHz SSB signal. With input grounded; no RF is detected at RF check.

Band : 60 - 67.5 MHz

1.LO : 60.00000 MHz

3.LO : 455.00 kHz

<u>Error code</u>	<u>Possible error source</u>	<u>PCB</u>
00	OK	
01	Exciter signal path Cabling 910 - 715 or 911 - 715	715

TEST 28

Test 28 performs exciter test on RX/EX Signal Path PCB 715 in SSB with SSB filter and tone input. The exciter is set up to produce 15 MHz SSB signal. With tone input; RF is detected at RF check. Shape key is also checked.

Band : 60 - 67.5 MHz

1.LO : 60.00000 MHz

3.LO : 456.00 kHz

<u>Error code</u>	<u>Possible error source</u>	<u>PCB</u>
00	OK	
01	Exciter signal path Cabling 910 - 715 or 911 - 715	715
02	Shape key	715

TEST 29

Test 29 performs exciter test on RX/EX Signal Path PCB 715 in R3E with SSB filter and tone input. The exciter is set up to produce 15 MHz R3E signal. With tone input; RF is detected at RF check.

Band : 60 - 67.5 MHz

1.LO : 60.00000 MHz

3.LO : 455.00 kHz

<u>Error code</u>	<u>Possible error source</u>	<u>PCB</u>
00	OK	
01	Exciter signal path Cabling 910 - 715 or 911 - 715	715

TEST 30

Test 30 performs exciter test on RX/EX Signal Path PCB 715 in AM with SSB filter and no input. The exciter is set up to produce 15 MHz AM carrier. With input grounded; RF is detected at RF check.

Band : 60 - 67.5 MHz

1.LO : 60.00000 MHz

3.LO : 455.00 kHz

<u>Error code</u>	<u>Possible error source</u>	<u>PCB</u>
00	OK	
01	Exciter signal path Cabling 910 - 715 or 911 - 715	715

TEST 31

Test 31 performs exciter test on RX/EX Signal Path PCB 715 in CW mode with SSB filter and no input. The exciter is set up to produce 15 MHz carrier. With input grounded; RF is detected at RF check.

Band : 60 - 67.5 MHz

1.LO : 60.00000 MHz

3.LO : 455.00 kHz

<u>Error code</u>	<u>Possible error source</u>	<u>PCB</u>
00	OK	
01	Exciter signal path Cabling 910 - 715 or 911 - 715	715

TEST 32

Test 32 tests Automatic Level Control on RX/EX Signal Path PCB 715. The exciter is set up to produce 15 MHz CW carrier. With input grounded and low ALC level; no RF is detected at RF check. With high ALC level RF is present.

Band : 60 - 67.5 MHz

1.LO : 60.00000 MHz

3.LO : 455.00 kHz

<u>Error code</u>	<u>Possible error source</u>	<u>PCB</u>
00	OK	
01	Not able to lower ALC Cabling 910 - 715 or 911 - 715	715
02	Not able to rise ALC Cabling 910 - 715 or 911 - 715	715

TEST 33

Test 33 tests Antenna Tuning Unit without power.

The TU checks that an ATU is connected and if so, if it is in manual mode and able to communicate with the TU.

The ATU tests: RAM, Vforward-, Vreflected-, 0 degrees-, 90 degrees-, and temperature-detector.

<u>Error code</u>	<u>Possible error source</u>	<u>PCB</u>
00	OK	
01	ATU in manual mode Cabling 935/937 - 910 or 935 - 740	740/937
02	ATU - TU communication failure Cabling 935/937 - 910 or 935/937 - 740/940	740/940 937/937 910
03	ATU ram error	740/940
04	Vforward detector	740/940
05	Vreflected detector	740/940
06	0 deg. detector	740/940
07	90 deg. detector	740/940
08	Temperature sensor	740/940
99	No ATU connected	

TEST 34

Test 34 tests battery voltage and power amplifier module. Supply voltage is read from PCB 933/935 and compared with PA module ID. PA ID is performed by a voltage divider and read by the A/D converter.

<u>Error code</u>	<u>Possible error source</u>	<u>PCB</u>
00	OK	
01	Supply voltage too low or voltage measuring circuit Cabling 910 - 933/935	933/935
02	Supply voltage too high on 12 V PA module	
03	Supply voltage too low on 24 V PA module	
04	Supply voltage too high on 24 V PA module	

05	Supply voltage too low on 32 V PA module
06	Supply voltage too high on 32 V PA module
07	Unidentified PA module Cabling 910 - 720/721/722/723/724

TEST 36

Test 35 tests PA-module PCB 720/721/722/723/724/920, PA-filters PCB 726/727/926/927 and ATU PCB 740/940. A full tune and ALC procedure is performed on the set frequency. Then a transmission with full power is carried out for 10 seconds, followed by a transmission in low power mode also lasting 10 seconds. It should be insured, that the selected test frequency is vacant, before the transmitter test is carried out.

<u>Error code</u>	<u>Possible error source</u>	<u>PCB</u>
00	OK	
01	PA Attenuator Relay Cabling 910 - 720*	720*
10	Tune Power Low Coax 715 - 720*, 720* - 726**, 726** - 935/937 or TU - ATU Cabling 910 - 715 or 910 - 726**	
11	Tune Power High Cabling 910 - 715 or 910 - 726**	
12	ALC Power High Cabling 910 - 715 or 910 - 726**	
13	Supply failure Cabling 910 - 715 or 910 - 726**	
14	ALC Power Low Cabling 910 - 715 or 910 - 726**	
15	TU - ATU Failure Cabling 910 - 935/937 or 935/937 - 740/940 Antenna installation or ATU	
16	Med/Low High Cabling 910 - 720* or 910 - 726**	
17	Full High Cabling 910 - 720* or 910 - 726**	
20	PA Temp	720*

	Check Blower & Blower Filter	
21	PA SWR Coax 720* - 726** Antenna installation	720*
40	Not Tuned Antenna installation or ATU	740/940
41	No Tune Power RX/TX relay PCB 935/937 or coax connectors Coax cables 726** - 935/937 or TU - ATU shorted. ATU	740/940
42	Bad SWR Antenna installation or ATU	740/940
46	Bad SWR TX Antenna installation or ATU	740/940
51	TU-ATU com bad TU - ATU multiwire cable.	

*) 720/721/722/723/724/920

**) 726/727/926/927

SKANTI SERVICE AGENTS

Please refer to the list of agents at the SKANTI homepage on this Internet address:

<http://www.skanti.dk>

6. DSC OPERATION Table of Contents**General**

DSC 9000 front panel	6-2
Keys and indicators	6-3
Aural alarm signals	6-5
Remote alarms	6-5
Remote activation of distress alert	6-5
Multiple Control Units	6-6
Menu tree	6-7

Operating instructions

Distress alert, info	6-8
Distress alert	6-9
Editing a distress alert, info	6-10
Editing a distress alert	6-11
Editing a distress alert, info	6-12
Editing a distress alert cont'd	6-13
Sending distress alert, info	6-14
Sending distress alert	6-15
Receiving distress acknowledgement, info	6-16
Receiving distress acknowledgement	6-17
Sending distress relay call, info	6-18
Sending distress relay call	6-19
Sending distress relay call, info	6-20
Sending distress relay call cont'd	6-21
Receiving distress relay acknowledgement, info	6-22
Receiving distress relay acknowledgement	6-23
Sending a call, info	6-24
Sending a call	6-25
Sending a call, info	6-26
Sending a call cont'd	6-27
Receiving acknowledgement, info	6-28
Receiving acknowledgement	6-29
Sending a direct-dial call, info	6-30
Sending a direct-dial call	6-31
Sending a direct-dial call, info	6-32
Sending a direct-dial call cont'd	6-33
Sending a direct-dial call, info	6-34
Sending a direct-dial call cont'd	6-35
Receiving distress alert, info	6-36
Receiving distress alert	6-37

Acknowledging a distress alert, info	6-38
Acknowledging a distress alert	6-39
Relaying a received distress alert, info	6-40
Relaying a received distress alert	6-41
Receiving distress relay, info	6-42
Receiving distress relay	6-43
Receiving a call, info	6-44
Receiving a call	6-45
Sending an acknowledgement, info	6-46
Sending an acknowledgement	6-47
Receiving a direct-dial call, info	6-48
Receiving a direct-dial call	6-49
Status display	6-50
Change status	6-52

Programming

Programming: Automatic acknowledgement	6-54
Programming: position	6-56
Programming: printer	6-58
Printer status	6-58
Print lists	6-58
Programming: clock setting	6-59
Programming: sound setting	6-60
Distress-alarm sound	6-60
Call-alarm sound	6-60
Key-beep sound	6-61
Programming: light setting	6-62
Programming: contrast setting	6-63
Programming: dsc-frequency list	6-64
Pre-programmed dsc frequencies	6-65
Programming: MMSI list	6-66
Programming: telephone list	6-67

Test

Test: info	6-68
Accumulated on-time	6-68
Version	6-68
Test: self-test	6-69
Test: RX-audio	6-70
Test: TX-test	6-71

DSC 9000 FRONT PANEL

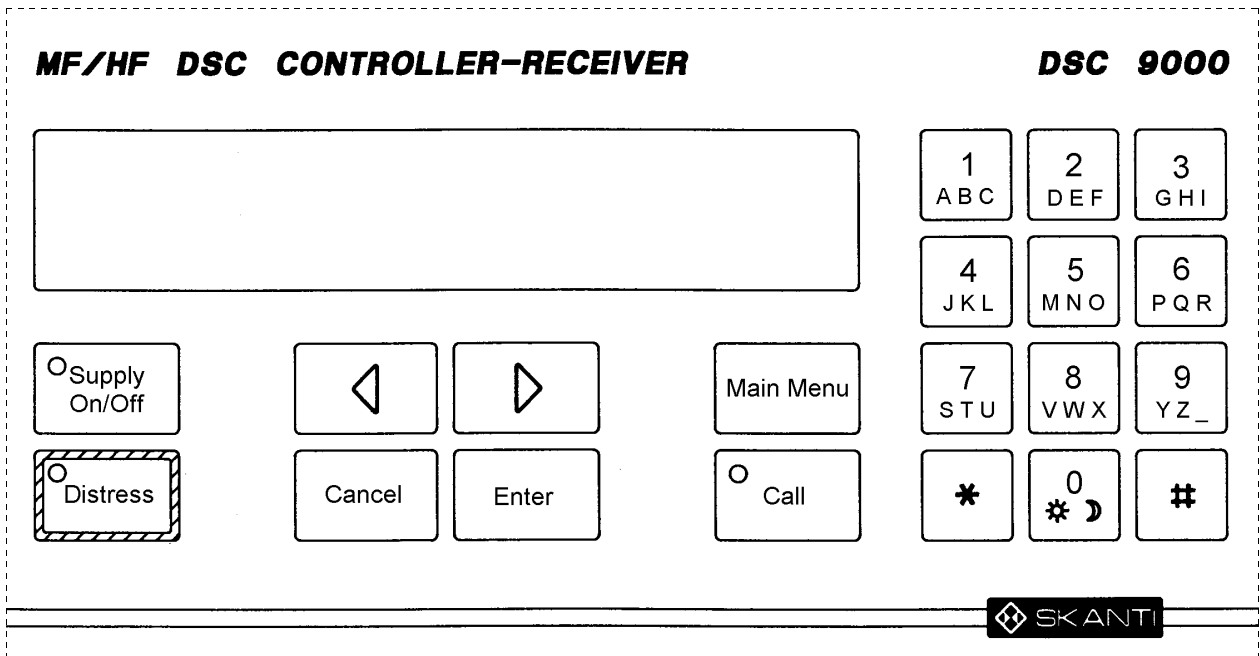

KEYS AND INDICATORS

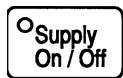

Switches DSC 9000 on.
Switches DSC 9000 off when pressed for 6 seconds.



Selects DISTRESS mode.
Starts transmission of a distress alert if pressed for 6 seconds.

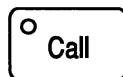

Selects TX-CALL menu.
Completes a composition of a TX-CALL using the information from the last call in the selected Format.
Starts transmission of a composed call if so is indicated.
Starts transmission of an acknowledgement if a call requiring acknowledgement is displayed.



Change the content of a selection field.
Move between commands.



Change list numbers.
Change between numbers and letters in alpha-numeric fields.



Enters the content of a selection or entry field and moves to the next step.
Executes a selected command.

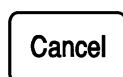

Moves to the previous step.
Deletes the character at the cursor when keying in a value.
Interrupts transmission of a call in progress.
Stops an aural alarm signal.

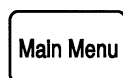

Selects the MAIN-MENU.

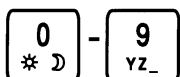

Enter numbers or letters in entry fields.



Switches illumination of display and keyboard backlight between "day" and "night" settings (unless a numeric entry is expected).

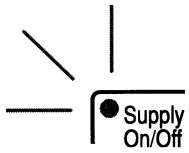

Steady green light

Indicates that the supply is on.

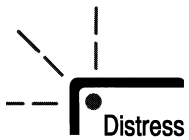

Slow flashing red light

A distress call (distress format or category) has been received .
The lamp remains flashing until the call has been read out.

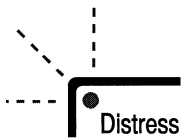

Quick flashing red light

A distress alert will be transmitted if the Distress key is kept pressed for 5 seconds.

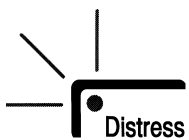

Steady red light

A distress alert transmission is in progress.
Distress alert will be automatically retransmitted.

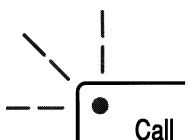

Slow flashing yellow light

A call other than distress has been received. The lamp remains flashing until the call has been read out.

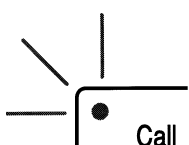

Steady yellow light

Transmission of a call (other than distress) is in progress.

AURAL ALARM SIGNALS

Distress Alarm: User-programmable sound indicating that a distress or urgency call has been received. Remain activated until a key is pressed

Call alarm: User-programmable sound indicating that a call (other than distress or urgency) has been received. Remain activated for 1/4 - 4 minutes (programmable) or until a key is pressed or, for Direct-dial and Selective telephony calls, the handset of the radiotelephone is lifted off-hook.

REMOTE ALARMS

External alarm devices may be connected to DSC 9000 and configured to be active when

- the aural distress alarm sounds, or
- the aural call alarm sounds, or
- either alarm sounds *), or
- the distress lamp is illuminated and when the aural distress alarm sounds

*)Different on/off patterns so it is possible to distinguish between distress alarm and call alarm.

REMOTE ACTIVATION OF DISTRESS ALERT

An external push button may be connected to the equipment for remote initiation of a distress alert.

The external push button may be combined with a lamp configured to follow the distress lamp.

The external push button is operated in the same way as the Distress key on DCU 9000. To initiate a distress alert press the push-button for 6 sec (until the distress lamp stops quick-flashing and shows steady light). Then release. If not released within 5 s transmission does not start.

MULTIPLE CONTROL UNITS

Up to 5 DCU 9000 control units may be connected simultaneously to a DU 9000. One of the control units may be given priority (by configuration).

Only one control unit can be *active* at a time while all others are *passive*. When switching on, the control unit on which the SUPPLY ON/OFF button was pressed becomes *active*. After an interruption in external power supply all control units will be *passive*.





If the active control unit is in the MAIN-MENU, STATUS or RX-CALL states or if all control units are passive, the display of a passive control unit shows:

STAND-BY
>STATUS<

If the active control unit is in any other state the display of a passive control unit shows:

BUSY

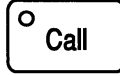
Only a passive control unit with higher priority can interrupt the active control unit in this case.

Only the keys , , ,  and  are functioning on a passive control unit.

An incoming call activates the visual and audible indicators of all control units. Light and sound levels are individually adjustable.

The RX-CALL is displayed only on the active control unit.

MENU TREE

MAIN MENU
>STATUS< TX-CALL RX-CALLS TEST
PROGRAMMING CONFIGURATION

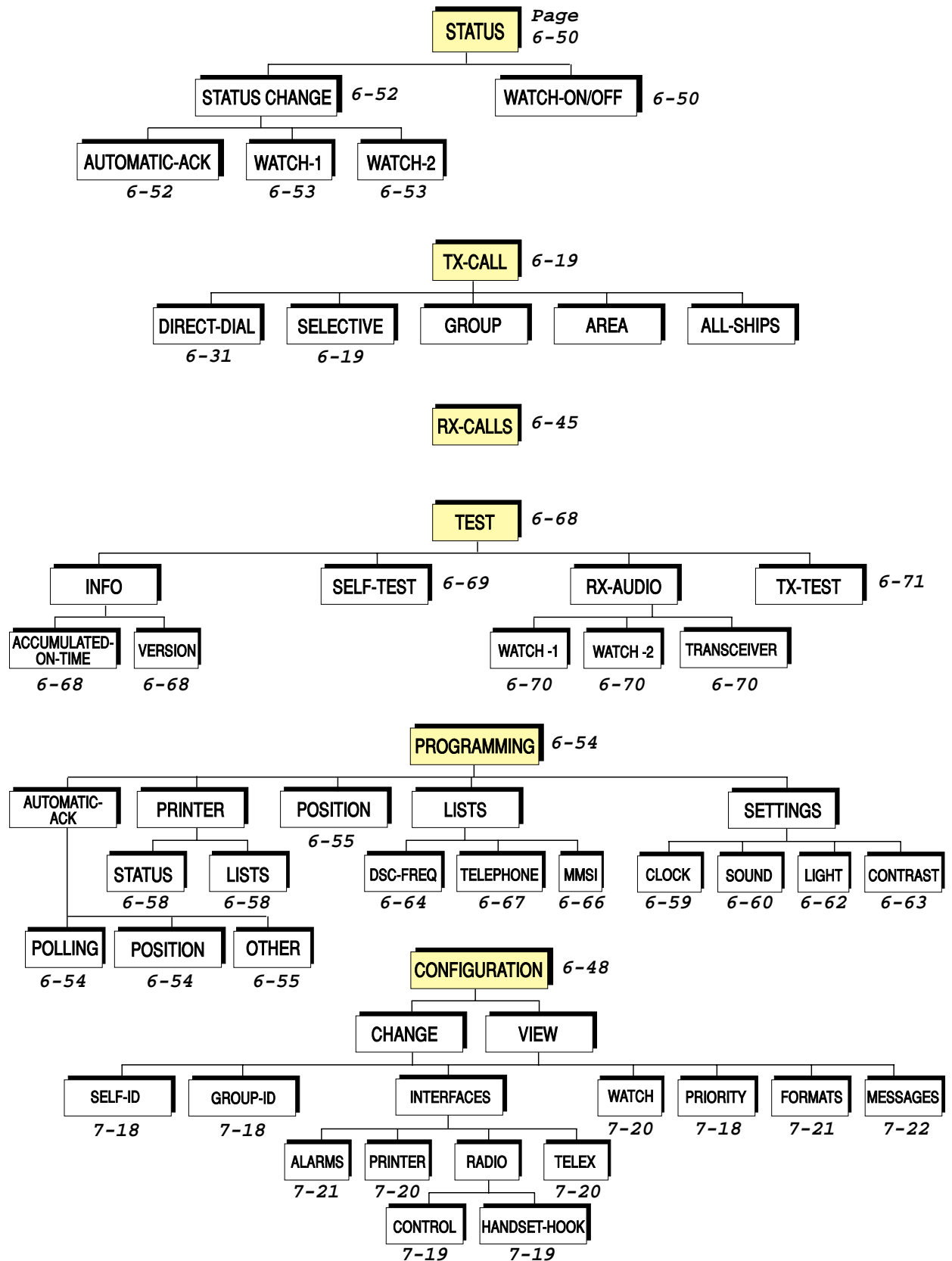



DISTRESS ALERT, INFO

To edit the Information, release
immediately.

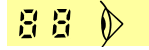

DISTRESS ALERT

1. Press  for 6 seconds.

The displayed distress alert information will be transmitted when the key is released after the 6 seconds has elapsed.

Example:

DISTRESS

Position: 55°59'N 133°22'W at 1229 UTC

Undesignated distress USB telephony

- Keep pressing 5 sec to send message -



EDITING A DISTRESS ALERT, INFO

Position

The position is updated automatically by the ships navigational equipment or it may have been keyed in manually, see PROGRAMMING POSITION.

Automatic updated position information is 'frozen' at the moment the Distress button is pressed and may be corrected manually by selecting >EDIT<.

Nature of Distress

Selectable Options:

- Fire, explosion
- Flooding
- Collision
- Grounding
- Danger of capsizing
- Sinking
- Disabled and adrift
- Undesignated distress
- Abandoning ship

Type of Subsequent Distress Communication

Selectable Options:

- USB telephony
- AM telephony
- FEC telex

EDITING A DISTRESS ALERT



1. Press and release .

2. Accept the **Position** if ok.

Press .

DISTRESS
Position: (55°59'N 133°22'W at 1229 UTC)

>POSITION OK< EDIT UNKNOWN

3. Select the **Nature of Distress** using the   keys.

Press .

DISTRESS
Position: 55°59'N 133°22'W at 1229 UTC
<Undesignated distress> USB telephony
-- Change by [<] [>] or press [Enter] --

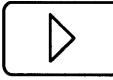
4. Select the **Type of Subsequent Distress Communication** using the   keys.

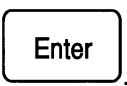
Press .

DISTRESS
Position: 55°66'N 133°22'W at 1229 UTC
Undesignated distress <USB telephony>
-- Change by [<] [>] or press [Enter] --

5. To send on one DSC distress frequency select >SINGLE<.

Press .

DISTRESS
Position: 55°59'N 133°22'W at 1229 UTC
Undesignated distress USB telephony
DSC distress freq: ALL >SINGLE<



EDITING A DISTRESS ALERT, INFO

DSC Distress frequency

If >ALL< is selected, the distress alert will be sent on all six DSC Distress frequencies in turn.

Note: The Frequency is preset to 2187.5 kHz if watch receiver 1 is set to 'Distress watch MF' (DSC 9001).

If a single frequency is selected the Distress Alert will be sent on that frequency 5 times, in each transmission.

EDITING A DISTRESS ALERT Cont'd



6. Select a DSC Distress Frequency using

the   keys.

Press .

DSC FREQUENCY SELECTION

<97 DISTRESS Tx: 8414.5 Rx: 8414.5 kHz>

-- Change by [<] [>] or press [Enter] --

7. Press  for 6 seconds to transmit the Distress Alert immediately or

press  to return to the Main Menu.

DISTRESS

Position: 55°59'N 133°22'W at 1229 UTC

Undesignated distress USB telephony

- Press [Distress] 6 sec to send message



SENDING DISTRESS ALERT, *INFO*

If the transmitter is off the light in the distress lamp does not turn into steady light and the last line shows "-- Switch transmitter on --".

If the distress alert was transmitted on a single frequency, the transceiver is set automatically to telephony or telex mode as indicated in the call and to the appropriate distress frequency in the same band as the call.

After 3 minutes, if a single frequency was selected, the last line shows "-Press [Enter] to select DSC frequency-". Another DSC frequency may then be selected and the distress alert repeated on this frequency.

Automatic transmission if [Enter] is not pressed.

SENDING DISTRESS ALERT



1. Press  for 6 seconds.
The Distress key lamp flashes quickly.
The display shows the Distress Message.

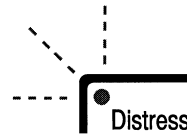

DISTRESS
Position: 55°59'N 133°22'W at 1229 UTC
Undesignated distress USB telephony
- Keep pressing 5 sec to send message -

2. The display shows the remaining number of seconds

DISTRESS
Position: 55°59'N 133°22'W at 1229 UTC
Undesignated distress USB telephony
- Keep pressing 1 sec to send message -

When the time is out the Distress lamp will light steady.

DISTRESS
Position: 55°59'N 133°22'W at 1229 UTC
Undesignated distress USB telephony
----- Release button -----

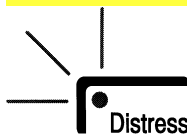

3. Release  to start the transmission..

DISTRESS
Position: 55°59'N 133°22'W at 1229 UTC
Undesignated distress USB telephony
----- Tuning transmitter -----
----- Transmitting -----

4. The Distress Alert Transmission is automatically repeated at intervals of 3.5 - 4.5 minutes.

DISTRESS
Position: 55°59'N 133°22'W at 1229 UTC
Undesignated distress USB telephony
- Awaiting acknowledgement -

5. The Distress Alert repetition continues until: the Distress Acknowledgement is received

or  is pressed.



RECEIVING DISTRESS ACKNOWLEDGEMENT, *INFO*

If SET UP is entered, the transceiver is set automatically to telephony or telex mode as indicated , and to the appropriate distress and safety frequency in the same band as the acknowledgement call.

END should be entered when communication is completed. The display returns to STATUS display or to RX-CALL if not all received calls have been read out and scanning is resumed on the transceiver if so selected.

The Distress Acknowledgement is an All Ships Call and therefore received not only by the ship in distress.

RECEIVING DISTRESS ACKNOWLEDGEMENT



1. The Distress Acknowledgement is received.
The Distress lamp flashes slowly.

The display shows which station has acknowledged the Distress Alert.

Press .

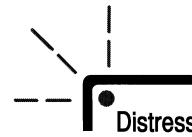

RX-CALL All ships from: 001234567
Category: Distress Distress ack

Received on 8414.5 kHz [> MORE <](#)

2. The display shows the Distress message acknowledged.

DISTRESS-ACKNOWLEDGEMENT TO:123456789
Position: 55°66'N 133°22'W at 1229 UTC
Undesignated distress USB telephony
[>SET UP<](#) [QUIT](#)

3. Enter SET UP and hook off the Transceiver handset to commence the Distress traffic by telephony.

The Transceiver is automatically set to the Distress traffic frequency.

DISTRESS-ACKNOWLEDGEMENT TO:123456789
Position: 55°66'N 133°22'W at 1229 UTC
Undesignated distress USB telephony
[>END<](#)

4. When communication is completed, enter END.



SENDING DISTRESS RELAY CALL, INFO

To relay a received distress alert please refer to page 2-41

SENDING DISTRESS RELAY CALL

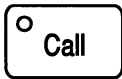

1. Press  **Call**
Select the format e.g. Selective call.

TX-CALL Saved call: Enter number 0-9

DIRECT-DIAL
>SELECTIVE< GROUP AREA ALL-SHIPS

Press  **Enter**.

2. Key in the Maritime Mobile Service Identity number of the coast station.

TX-CALL Selective to: **(001234567)**

Press  **Enter**.

- Enter maritime mobile service identity -

3. Select Distress Category.

TX-CALL Selective to: 001234567
Category: **<Distress>**

Press  **Enter**.

-- Change by [<**] [**>**] or press [**Enter**] --**

4. Select Distress Relay.

TX-CALL Selective to: 001234567
Category: Distress **<Distress relay>**

Press  **Enter**.

-- Change by [<**] [**>**] or press [**Enter**] --**

5. Key in the Maritime Mobile Service Identity of the ship in distress if known.

DISTRESS-RELAY Ship: **(123456789)**

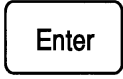
Press  **Enter**.

- Enter maritime mobile service identity -

6. Key in the position.

DISTRESS-RELAY Ship:123456789
Position: **55°59'N 133°22'W at 1229 UTC**

Press  **Enter**.

>POSITION-OK< EDIT



SENDING DISTRESS RELAY CALL, INFO

Nature of Distress

Selectable Options: Fire, explosion
 Flooding
 Collision
 Grounding
 Danger of capsizing
 Sinking
 Disabled and adrift
 Undesignated distress
 Abandoning ship

Type of Subsequent Distress Communication

Selectable Options: USB telephony
 AM telephony
 FEC telex

The distress relay call is automatically transmitted 5 times, total duration approx. 50 sec.

Following transmission of a selective call the receiver is set to the DSC RX frequency and awaits an acknowledgement within 5 minutes.

For All ships, Group or Area calls no acknowledgement is expected. In this case the transceiver is set automatically to telephony or telex mode as indicated in the call and to the appropriate distress and safety frequency in the same band as the call.

SENDING DISTRESS RELAY CALL Cont'd



7. Select the nature of distress.

Press .

DISTRESS-RELAY Ship:123456789
 Position: 55°59'N 133°22'W at 1229 UTC
 <Undesignated distress>
 -- Change by [<] [>] or press [Enter] --

8. Select the type of subsequent distress communication.

Press .

DISTRESS-RELAY Ship:123456789
 Position: 55°59'N 133°22'W at 1229 UTC
 Undesignated distress <USB telephony>
 -- Change by [<] [>] or press [Enter] --

9. Press .

DISTRESS-RELAY Ship:123456789
 Position: 55°59'N 133°22'W at 1229 UTC
 Undesignated distress USB telephony
 - Press [Enter] to select DSC frequency -

10. Select one of the DSC Distress Frequencies (94-99).

Press .

DSC FREQUENCY SELECTION
 <97 DISTRESS Tx:8414.5 Rx:8414.5 kHz>
 -- Change by [<] [>] or press [Enter] --

11. Press to transmit the message.

TX-CALL Selective to: 001234567
 Category: Distress Distress relay
 - Press [Call] to send on 8414.5 kHz -
 ----- Tuning transmitter -----
 ----- Checking for free channel -----
 ----- Transmitting -----
 ----- Awaiting ack on 8414.5 kHz -----

If no acknowledgement has been received when the time expires, the display shows.

The call may be repeated on another frequency by selecting REPEAT.

No acknowledgement received
 REPEAT >QUIT<



RECEIVING DISTRESS RELAY ACKNOWLEDGEMENT, *INFO*

If SET UP is entered, the appropriate transmitter and receiver are set automatically to telephony or telex mode as indicated in the acknowledgement, and to the appropriate distress and safety frequency in the same band as the acknowledgement call. (If not configured for automatic control of telex receiver and transmitter, the telephony receiver and transmitter are set to USB at the telephony distress frequency in the same band.)

If the handset is lifted off-hook while the acknowledgement is displayed, the telephony transmitter and receiver are set automatically to the telephony distress and safety frequency in the same band as the acknowledgement call.

END should be entered when communication is completed. The display returns to STATUS or to RX-CALL if not all received calls have been read out and scanning is resumed on the transceiver if so selected.

RECEIVING DISTRESS RELAY ACKNOWLEDGEMENT



1. The Distress Acknowledgement is received.
The Distress lamp flashes slowly.

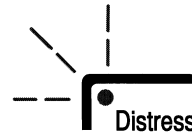

RX-ACKNOWLEDGEMENT from: 001234567
Category: Distress Distress relay

Received on 8414.5 kHz [> MORE <](#)

Press .

2. The display shows the Distress relay message acknowledged.

DISTRESS-RELAY Ship:123456789
Position: 55°59'N 133°22'W at 1229 UTC
Undesignated distress USB telephony
[>SET UP<](#) [QUIT](#)

3. Enter SET UP or hook off the Transceiver handset to commence the Distress traffic by telephony.
The Transceiver is automatically set to the Distress traffic frequency.

DISTRESS-RELAY Ship:123456789
Position: 55°59'N 133°22'W at 1229 UTC
Undesignated distress USB telephony
[>END<](#)

4. When communication is completed, enter END.



SENDING A CALL, INFO

Note: Some formats may be disabled by configuration.

Categories

Selectable options:

All ships call

Distress

Urgency

Safety

Area / Group / Selective

Distress

Urgency

Safety

Ship's business

Routine

Type of subsequent communication / Telecommand.

Selectable options:

USB telephony

FEC telex

ARQ telex

For distress category additionally:

Distress relay

Note: Telecommands may be added dependent on configuration.

SENDING A CALL

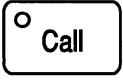

1. Press .
2. Select the format. e.g. Selective call .

Press .

3. Key in the Maritime Mobile Service Identity of the station you want to call.

Press .

4. Select the Category.

Press .

5. Select the type of subsequent communication/telecommand.

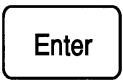
Press .

TX-CALL Saved call: 0-9

DIRECT-DIAL
>SELECTIVE< GROUP AREA ALL-SHIPS

TX-CALL Selective to: (001234567)

- Enter maritime mobile service identity -

TX-CALL Selective to: 001234567
Category: <Routine>

-- Change by [<] [>] or press [Enter] --

TX-CALL Selective to: 001234567
Category: Routine < USB telephony >

-- Change by [<] [>] or press [Enter] --



SENDING A CALL, INFO

Additional information

When calling a coast station select NONE.

When calling another ship select FERQUENCY and key-in the proposed working frequencies.

Note: Transmission is prevented until the channel is free. This feature may be overruled by pressing Call again.

The duration of an MF/HF DSC call is approx. 10 sec. Following transmission of selective or direct-dial calls the receiver is set to the DSC RX frequency and awaits an acknowledgement within 5 minutes for selective calls and 25 seconds for direct-dial calls.

All ships, group and area calls require no acknowledgement. When the transmission is completed the transceiver is set to the mode and frequencies indicated in the call by pressing ENTER or, for telephony calls, lifting the handset off hook within 1 minute.

END should be entered when communication is completed. For telephony calls just place the handset on-hook. The display returns to STATUS or to RX-CALL if not all received calls have been read out and scanning is resumed on the transceiver if so selected.

SENDING A CALL Cont'd

- 6. Select the Additional information.
e.g. "NONE"

Press  .

Press  .

TX-CALL Selective to: 001234567
Category: Routine USB telephony
Additional information:
>NONE< POSITION FREQUENCY CHANNEL

TX-CALL Selective to: 001234567
Category: Routine USB telephony

- Press [Enter] to select DSC frequency -

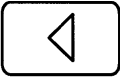
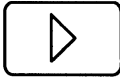
- 7. Select the DSC Frequency using
the   keys or
by entering a List number.

Press  .

DSC FREQUENCY SELECTION
<08 NATIONAL Tx: 2159.5 Rx 1624.5>

-- Change by [<] [>] or press [Enter] --

- 8. Select SEND.

Press  .

TX-CALL Selective to: 001234567
Category: Routine USB telephony

DSC Tx: 2159.5 kHz EDIT SAVE >SEND<

- 9. Press  to send
the Selective call.

TX-CALL Selective to: 001234567
Category: Routine USB telephony

- Press [Call] to send on 2159.5 kHz -

----- Tuning transmitter -----
----- Checking for free channel -----
----- Transmitting -----
----- Awaiting ack on 1624.5 kHz -----

If no acknowledgement has been received when the time expires, the display shows.

The call may be repeated on the same or another DSC frequency .Further call attempts to the same coast station should be delayed at least 15 minutes, if acknowledge is still not received.

No acknowledgement received

REPEAT >QUIT<



RECEIVING ACKNOWLEDGEMENT, *INFO*

If SET UP is entered the mode and frequency of the transceiver is set as indicated in the call.

If the handset is lifted off-hook while an RX-call indicating telephony mode is displayed, the mode and frequency is set as indicated in the call.

END should be entered when communication is completed. For telephony calls just place the handset on hook. The display returns to STATUS or to RX-CALL if not all received calls have been read out and scanning is resumed on the transceiver if so selected.

RECEIVING ACKNOWLEDGEMENT



1. The Acknowledgment is received.
The Call lamp flashes.

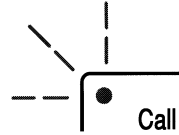

RX-ACKNOWLEDGEMENT from: 001234567
 Category: Routine USB telephony
 Working freq. Tx: 2076.0 Rx: 1813.0 kHz
 >SET UP< QUIT

2. Enter SET UP or hook off the Transceiver handset to commence the communication by telephony.
The Transceiver is automatically set to the mode and frequencies indicated in the acknowledgement.

RX-ACKNOWLEDGEMENT from: 001234567
 Category: Routine USB telephony
 Working freq. Tx: 2076.0 Rx: 1813.0 kHz
 >END<

3. When communication is completed, enter END.



SENDING A DIRECT-DIAL CALL, INFO

Direct-dial calls are used for direct telephone dialling of a land subscriber through an appropriate coast station providing automatic connection with the public switched telephone network.

Note: Not all coast stations provide this service.

To recall a saved call press the short-dial number (0-9).

To repeat a call press the call button.

Alternatively the MMSI list number (0-99) may be entered if the coast station has been programmed into the MMSI list. When Enter is pressed the programmed name of the coast station will be shown next to the 9-digit MMSI number.

Alternatively the telephone list number (0-99) may be entered if the number has been programmed into the telephone list. When Enter is pressed the programmed name of the coast station will be shown next to the telephone number.

The name of the coast station or the country may be used instead of NATIONAL, please refer to page 2-64 PROGRAMMING DSC-FREQUENCY LIST for further information.

SENDING A DIRECT-DIAL CALL



1. Press .

TX-CALL Saved call: 0-9 Repeat: Call
 >DIRECT-DIAL<
 SELECTIVE GROUP AREA ALL-SHIP

2. Select Direct-dial.

To edit the call

Press .

3. Key in the Maritime Mobile Service Identity of the coast station.

TX-CALL Direct-dial to: (002192000)
 - Enter Maritime Mobile Service Identity -

Press .



4. Key in the telephone no. of the land subscriber

TX-CALL Direct-dial to: 002192000
 Tel:(42482544)
 ----- Enter telephone number -----

Press .

TX-CALL Direct-dial to: 002192000
 Tel: 42482544
 -- Press [Enter to select DSC frequency--

Press .

5. Select the DSC frequency of the coast station using the   keys or by entering a List number.

DSC FREQUENCY SELECTION
 <08 NATIONAL Tx: 2159.5 Rx 1624.5>
 -- Change by [<] [>] or press [Enter] --

Press .



SENDING A DIRECT-DIAL CALL, INFO

To save the call select SAVE and press the Enter button.

Acknowledgement from the coast station is normally received within 25 sec.

If the coast station cannot comply immediately with the call request due to the appropriate working frequencies being busy or for other reasons, this will be indicated in the acknowledgement.

The coast station evaluates the working channel quality during the DSC call. If quality is satisfactory the acknowledgement contains the same working frequencies. The coast station then starts dialling the subscriber.

If the working channel quality evaluation indicates that quality is not satisfactory the coast station may suggest other working frequencies. In this case the DSC calls are repeated on the new working frequencies.

If the working channel quality evaluation again indicates that quality is not satisfactory and no other channels are available the coast station sends an acknowledgement indicating -Cannot use Channel-.

SENDING A DIRECT-DIAL CALL Cont'd



5. Select SEND



6. Press

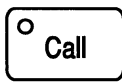

TX-CALL Direct-dial to: 002192000
Tel: 42482544
DSC tx: 2159.5 kHz EDIT SAVE > SEND<

TX-CALL Direct-dial to: 002192000
Tel: 42482544
-- Press [Call] to send on 2159.5 kHz --
----- Tuning transmitter -----
----- Checking for free channel -----
----- Transmitting -----
---- Awaiting ack on 1624.5 kHz ----

When acknowledgement is received and the coast station can comply immediately the call is automatically repeated on the working frequency contained in the acknowledgment.

TX-CALL Direct-dial to: 002192000
Tel: 42482544
Working freq. Tx: 2076.0 Rx: 1813.0 kHz
----- Setting-up transceiver -----
----- Tuning transmitter -----
----- Transmitting -----
---- Awaiting ack on 1813.0 kHz ----

Lift the handset off hook and wait for the called subscriber to answer the telephone

RX-ACKNOWLEDGEMENT from: 002192000
Tel: 42482544 USB telephony
Working freq. Tx: 2076.0 Rx: 1813.0 kHz
Received on 1813.0 kHz >END<

When the call is completed or in case of no answer, place the handset on-hook. An 'End of call' DSC message is then sent to the coast station to stop call timing.

TX-CALL Direct-dial to: 002192000
Tel: 42482544 End of call
----- Tuning transmitter -----
----- Transmitting -----
---- Awaiting ack on 1813.0 kHz ----



SENDING A DIRECT-DIAL CALL, *INFO*

SENDING A DIRECT-DIAL CALL Cont'd



The acknowledgement from the coast station may contain information on the chargeable duration of the call.



RX-ACKNOWLEDGEMENT from: 002192000
Tel: 42482544 End of call
Duration: 0 hours 6 min 35 sec
>QUIT<



RECEIVING DISTRESS ALERT, *INFO*

If SET UP is entered, the transceiver is set automatically to telephony or telex mode as indicated in the call, and to the appropriate distress and safety frequency in the same band as the call.

If received on an HF Distress frequency ACK is replaced by RELAY.
See page 2-39 for acknowledging a Distress Alert and page 2-41 for Relaying a Distress Alert.

END should be entered when communication is completed. The display returns to STATUS or to RX-CALL if not all received calls have been read out and scanning is resumed on the transceiver if so selected.

Note: A Distress Alert may be received on more frequencies.

RECEIVING DISTRESS ALERT



1. A Distress Alert is received.
2. Enter SET UP. The transceiver is now automatically set to the Distress traffic frequency.

Hook off the transceiver handset to acknowledge the receipt of the Distress alert by telephony.

3. When communication is completed, enter END.

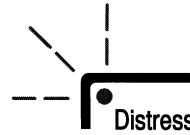

RX-CALL Distress from: 123456789
 Position: 55°59'N 133°22'W at 1229 UTC
 Undesignated distress USB telephony
 Received on 2187.5 kHz > SET UP < END

RX-CALL Distress from: 123456789
 Position: 55°59'N 133°22'W at 1229 UTC
 Undesignated distress USB telephony
 Received on 2187.5 kHz ACK > END <



ACKNOWLEDGING A DISTRESS ALERT, *INFO*

Ships receiving a DSC distress alert from another ship should defer the acknowledgement of the distress alert for a short interval, if the ship is within an area covered by one or more coast stations, in order to give the coast station time to acknowledge the DSC distress alert first.

Start of transmission is automatically delayed until 1 minute has passed since receipt of the Distress Alert. In this period the display shows ' Call in progress '.

END should be entered when communication is completed. The display returns to STATUS or to RX-CALL if not all received calls have been read out and scanning is resumed on the transceiver if so selected.

ACKNOWLEDGEING A DISTRESS ALERT



1. A distress alert is received on 2187.5 kHz and SET UP is selected

2. Select ACK.



RX-CALL Distress from: 123456789
 Position: 55°59'N 133°22'W at 1229 UTC
 Undesignated distress USB telephony
 Received on 2187.5 kHz >ACK< END

3. Select Continue.



DSC distress acknowledgements are normally made by coast stations only.

>CONTINUE< RETURN

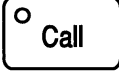
4. Press  to transmit the Distress Acknowledgement.

DISTRESS-ACKNOWLEDGEMENT TO:987654321
 Position: 55°59'N 133°22'W at 1229 UTC
 Undesignated distress USB telephony
 - Press [Call] to send on 2187.5 kHz -

----- Call in progress -----
 ----- Tuning transmitter -----
 ----- Checking for free channel -----
 ----- Transmitting -----

5. When communication is completed, enter END.

DISTRESS-ACKNOWLEDGEMENT TO:987654321
 Position: 55°59'N 133°22'W at 1229 UTC
 Undesignated distress USB telephony
 > END <



RELAYING A RECEIVED DISTRESS ALERT, *INFO*

The distress relay call is automatically transmitted 5 times.

Regarding receiving distress relay acknowledgement, please refer to page 2-23

RELAYING A RECEIVED DISTRESS ALERT

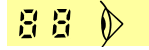

1. A Distress Alert is received on an HF frequency and SET UP is selected. Select RELAY.

Press  .

RX-CALL: Distress from:123456789
 Position: 55°59'N 133°22'W at 1229 UTC
 Undesignated distress USB telephony
 Received on 8414.5 kHz RELAY >END<

2. Key in the Maritime Mobile Service Identity number of the coast station.

Press  .

TX-CALL Selective to: (001234567)

- Enter maritime mobile service identity -

3. The Distress message is displayed.

Press  .

DISTRESS-RELAY Ship:123456789
 Position: 55°59'N 133°22'W at 1229 UTC
 Undesignated distress USB telephony
 - Press [Enter] to select DSC frequency -

4. Select the DSC distress frequency using

the   keys.

Press  .

DSC FREQUENCY SELECTION
 <97 DISTRESS Tx:8414.5 Rx:8414.5 kHz>

-- Change by [<] [>] or press [Enter] --

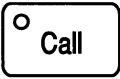
5. Press  to transmit the message.

TX-CALL Selective to: 001234567
 Category: Distress Distress relay

- Press [Call] to send on 8414.5 kHz -

----- Tuning transmitter -----

----- Checking for free channel -----

----- Transmitting -----

----- Awaiting ack on 8414.5 kHz -----

**RECEIVING DISTRESS RELAY, INFO**

If SET UP is entered, the transceiver is set automatically to telephony or telex mode as indicated in the call, and to the appropriate distress and safety frequency in the same band as the call.

END should be entered when communication is completed. The display returns to STATUS or to RX-CALL if not all received calls have been read out and scanning is resumed on the transceiver if so selected.

RECEIVING DISTRESS RELAY



1. A Distress Relay is received.

Press 

2. Enter SET UP. The transceiver is now automatically set to the Distress traffic frequency.

Hook off the transceiver handset to acknowledge the receipt of the call by telephony.

3. When communication is completed, enter END.

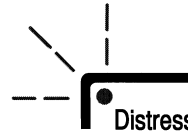
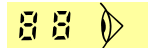

RX-CALL All ships from: 001234567
Category: Distress Distress relay

Received on 8414.5 kHz >MORE<

DISTRESS-RELAY Ship:123456789
Position: 55°59'N 133°22'W at 1229 UTC
Undesignated distress USB telephony
>SET UP< QUIT

DISTRESS-RELAY Ship:123456789
Position: 55°59'N 133°22'W at 1229 UTC
Undesignated distress USB telephony
> END<



RECEIVING A CALL, INFO

For calls requiring acknowledgement, please refer to page 2-47.

An incoming call will be displayed immediately if the equipment is in the MAIN-MENU or STATUS states. From other states the display returns to the last received RX-CALL instead of STATUS display if a call has been received.

The visual and audible indicators will signal that a call has been received. The visual indicator remains activated until the call has been read out.

If the call does not contain mode information ACCEPT is omitted.

If SET UP is entered the mode and frequency of the transceiver is set as indicated in the call.

END should be entered when communication is completed. The display returns to STATUS or to RX-CALL if not all received calls have been read out and scanning is resumed on the transceiver if so selected.

All-ships, Group and Area calls, not having Distress or Urgency category, are considered obsolete when 5 minutes have passed since the reception of the call. The call is then treated as 'read-out'.

RECEIVING A CALL



1. A Call is received.

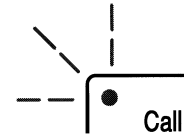

RX-CALL All ships to: 001234567
 Category: Safety USB telephony
 Working freq. TX: ----- RX: 1734.0
 Received on 2187.5 kHz >SET UP< QUIT

2. Enter SET UP.
 The transceiver is now automatically set to the mode and frequencies indicated in the call.

RX-CALL All ships to: 001234567
 Category: Safety USB telephony
 Working freq. TX: ----- RX: 1734.0
 Received on 2187.5 kHz >END<

3. When communication is completed, enter END.

All incoming calls are stored. The store has capacity for storing 20 different Distress calls and 20 different other calls. The oldest call in the group in question is deleted when the capacity is exceeded.

To see the content of the store,

press Main Menu >RX-CALLS< Enter

RX-CALLS 1229 UTC 1 JUL 1992
 Distress call from: 123456789
 Received on 2187.5 kHz
 - Change by [<] [>] or [Enter] to view --



selects next or previous call,



displays the complete call.



SENDING AN ACKNOWLEDGEMENT, INFO

Selective calls and Direct-dial calls require acknowledgement.

If the call contains Polling, Ship position, or legal mode and Frequency information, transmission of acknowledgement may be initiated by just pressing [Call]. Steps 2 to 5 are then automatically performed.

If the call is a telephony call the same is obtained by just lifting the handset off hook.

When transmission is completed and if the acknowledgement contains mode information, the transceiver is set to the mode and frequencies indicated in the acknowledgement call by pressing [Enter] or, for telephony calls, lifting the handset off-hook within one minute..

END should be entered when communication is completed. For telephony calls just place the handset on hook. The display returns to STATUS or to RX-CALL if not all received calls have been read out and scanning is resumed on the transceiver if so selected.

Note: If the call is not acknowledged within 4.5 minutes ACK is replaced by >TX-CALL<. If this is entered the information in the received call is transferred to a TX-CALL.

SENDING AN ACKNOWLEDGEMENT



1. A CALL requiring acknowledgement is received.
2. Select ACK

Press 

RX-CALL Selective to: 001234567
 Category: Routine USB telephony
 Working freq. TX: 8222.0 RX: 8746.0
 Received on 8436.5 kHz >ACK< END

3. Information is transferred from the received call.
 If able to answer the call, select
 ABLE TO COMPLY

Press 

TX-ACKNOWLEDGEMENT to: 001234567
 Category: Routine USB telephony
 Working freq. TX: 8222.0 RX: 8746.0
 UNABLE TO COMPLY >ABLE TO COMPLY<

4. If frequencies are ok, select OK

Press 

TX-ACKNOWLEDGEMENT to: 001234567
 Category: Routine USB telephony
 Working freq. TX: 8222.0 RX: 8746.0
 >OK< EDIT

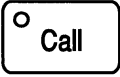
5. Press  to send the acknowledgement.

or
 provided the call is a telephony call:
 Just hook off the Transceiver handset.
 Steps 2 to 5 are then automatically
 performed.

TX-ACKNOWLEDGEMENT to: 001234567
 Category: Routine USB telephony
 Working freq. TX: 8222.0 RX: 8746.0
 - Press [Call] to send on 8415 kHz -



RECEIVING A DIRECT-DIAL CALL, INFO

Direct-dial calls are used for direct telephone dialling of the ship by a land subscriber through an appropriate coast station providing automatic connection with the public switched telephone network.

If incoming telephone calls cannot be answered for a period, the automatic acknowledgement status of the DSC 9000 should be changed to 'Unable to comply with telephony calls'. In this case the acknowledgement will contain the message 'Unable to comply', and the coast station will after receipt of that message transmit a busy signal to the calling subscriber.

The coast station evaluates the working channel quality during the DSC call. If quality is satisfactory the acknowledgement contains the same working frequencies. The coast station then starts dialling the subscriber.

If the working channel quality evaluation indicates that quality is not satisfactory the coast station may suggest other working frequencies. In this case the DSC calls are repeated on the new working frequencies.

If the working channel quality evaluation again indicates that quality is not satisfactory and no other channels are available the coast station sends an acknowledgement indicating -Cannot use Channel-.

RECEIVING A DIRECT-DIAL CALL



1. A call is received and an acknowledgement is initiated automatically.

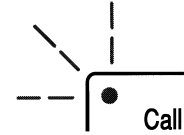

```

TX-ACKNOWLEDGEMENT   to: 002192000
Tel : --              USB telephony
Working freq. TX: 2076.0  RX: 1813.0
----- Tuning transmitter -----
----- Checking for free channel -----
----- Transmitting -----
                                     > SET UP <
    
```

2. Lift handset off-hook
or



press within one minute.
A DSC call is then sent on the working frequency.

```

TX-CALL   Direct-dial   to: 002192000
Tel : --   USB telephony
Working freq. TX: 2076.0  RX: 1813.0
----- Setting-up transceiver -----
----- Tuning transmitter -----
----- Transmitting -----
----- Awaiting ack on 1813.0 kHz -----
    
```

The coast station evaluates channel quality. If satisfactory no acknowledgement is sent and communication with the land subscriber may begin. After 15 sec the bottom line changes to

```

                                     > END <
    
```

When the call is completed place the handset on-hook. An 'End of call' DSC message is sent to the coast station to stop call timing.

```

TX-CALL   Direct-dial   to: 002192000
Tel : --   USB telephony
Working freq. TX: 2076.0  RX: 1813.0
----- Tuning transmitter -----
----- Checking for free channel -----
----- Transmitting -----
----- Awaiting ack on 1813.0 kHz -----
    
```

The acknowledgement from the coast station may contain information on the chargeable duration of the call.

```

RX-ACKNOWLEDGEMENT   to: 123456789
Tel: --              End of call
Duration: 0 hours 6 min 35 sec
                                     >QUIT<
    
```

STATUS DISPLAY

The STATUS display comes up when power is switched on or when selected from the MAIN-MENU by selecting STATUS and pressing "Enter". The equipment automatically returns to STATUS display after 10 minutes unless an RX-CALL is displayed or if in Distress Transmit mode.

```
STATUS 1107 UTC
Distress watch: 2 4 6 8 12 16 MHz
Calling watch: 08 09 11 17 20
>WATCH ON/OFF< STATUS CHANGE
```

Status display example.

WATCH ON/OFF is omitted if DSC watch-receiver 2 is an additional DU 9006 configured as a DSC watch receiver.

The STATUS display shows the present status of:

- Time**
- Automatic acknowledgement**
- DSC watch-receiver 1**
- DSC watch-receiver 1's watch frequency or frequencies**
- DSC watch-receiver 2**
- DSC watch-receiver 2's watch frequency or frequencies**

Time (UTC) may be set in the programming menu.

Automatic acknowledgement status:

(Empty)
Aut ack: Unable

The Automatic ack display field is empty if automatic acknowledgement is set to able to comply. May be changed by selecting >STATUS CHANGE<.

DSC watch-receiver 1 status:

Distress watch
Calling watch
none

Watch-receiver 1 is the built-in receiver of DSC 9001/6. Its status is selected in the configuration menu.

DSC watch-receiver 1 frequency status:

Distress watch MF	2187.5 kHz
Distress watch MF/HF	2, 4, 6, 8, 12, 16 MHz (DSC 9006 only,example)
Calling watch	08, 09, 10, 11, 17, 20 (DSC 9006 only,example)

Shows the frequency(ies) watched by watch-receiver 1.

Calling watch frequencies may be changed by selecting >STATUS CHANGE<.

DSC watch-receiver 2 status:

Distress watch	
Calling watch	
none	

Watch-receiver 2 is either the receiver of the associated MF/HF transceiver (WATCH ON/OFF displayed) or an additional DU 9006 configured as a DSC watch receiver (continuously on). Its status is selected in the configuration menu.

Note: The STATUS line is empty if 'None' is selected by configuration.

DSC watch-receiver 2 frequency status:

Distress watch MF	2187.5 kHz
Distress watch MF/HF	2, 4, 6, 8, 12, 16 MHz (example)
Calling watch	08, 09, 10, 11, 17, 20 (example)

Shows the frequency(ies) watched by watch-receiver 2.

Shows 'Off' if the receiver is switched off.

Calling watch frequencies may be changed by selecting >STATUS CHANGE<.

Watch on the associated MH/HF transceiver may be interrupted/restarted by selecting >WATCH ON/OFF<.

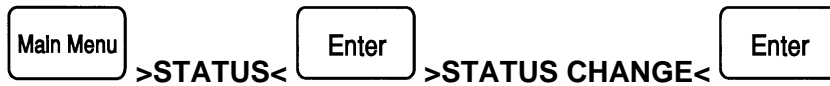
CHANGE STATUS

The change status menu allows selection of:

- Automatic acknowledgement**
- DSC watch-receiver 1's watch frequencies**
- DSC watch-receiver 2's watch frequencies**

Automatic acknowledgement may be set to

- Able to comply
- Unable to comply with telephony calls

For 'Unable to comply with telephony calls' the reason may be set to

- No reason given
- Congestion
- Station barred
- No operator
- Temporarily no operator
- Equipment disabled

When set to 'Unable to comply with telephony calls' automatic acknowledgement transmissions in response to calls containing a telephony telecommand will contain 'Unable to comply' and the additional message selected.

Automatic acknowledgement transmission takes place only if enabled by automatic ack programming. Automatic acknowledgement of direct-dial calls takes place if Direct-dial format is enabled by configuration. If Direct-dial format is enabled automatic ack of polling calls from coast stations is automatically enabled.

Automatic acknowledgement transmissions does not take place if the handset is off-hook or the equipment is not in STATUS, MAIN-MENU, or RX-CALL state.

Automatic acknowledgement transmissions does not take place if the call is received with error or has distress category.

DSC watch-receiver frequency may be changed as follows:

Distress watch

No change possible.

Calling watch

Frequencies may be selected from the DSC frequency list. The arrow keys will switch between the selected frequency numbers. The Enter key will display the frequencies selected and the arrow keys will now move between the frequencies of the DSC frequency list or a list number may be entered. Pressing Enter will select the displayed frequency pair.

PROGRAMMING: AUTOMATIC ACKNOWLEDGEMENT



Polling calls

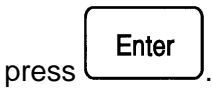

PROGRAMMING Automatic acknowledgement
 >POLLING< POSITION OTHER

Select between: Off
 All stations
 Specific stations only



PROGRAMMING Aut ack of polling calls
 < Specific stations only>
 -- Change by [<] [>] or press [Enter] --

If 'Specific stations only' is selected, enter the MMSI number of the stations.

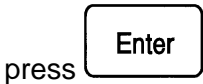

PROGRAMMING Aut ack of polling calls
 Specific stations only (002191000)
 (-)
 -- Enter MMSI; use # for any digit --

Position calls



PROGRAMMING Automatic acknowledgement
 POLLING >POSITION< OTHER

Select between: Off
 All stations
 Specific stations only

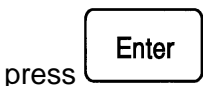

PROGRAMMING Aut ack of position calls
 < Specific stations only>
 -- Change by [<] [>] or press [Enter] --

If 'Specific stations only' is selected, enter the MMSI number of the stations.

press

PROGRAMMING Aut ack of position calls
 Specific stations only (002191000)
 ()
 -- Enter MMSI; use # for any digit --

Other calls

press

PROGRAMMING Automatic acknowledgement
 POLLING POSITION > OTHER<

Select between: Off
 All stations
 Specific stations only

press

PROGRAMMING Aut ack of other calls
 < Specific stations only >
 -- Change by [<] [>] or press [Enter] --

If 'Specific stations only' is selected, enter the MMSI number of the stations.

press

PROGRAMMING Aut ack of other calls
 Specific stations only (002191000)
 ()
 -- Enter MMSI; use # for any digit --

PROGRAMMING: POSITION

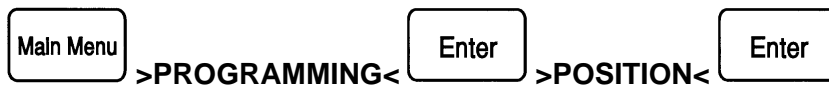

Automatic updating

If automatic updating from the NMEA input is used the actual position is displayed,  will return to the STATUS display

If not automatically updated, the DSC 9000 should be regularly updated manually in order to be able to receive Area calls correctly.

Manual updating

Select >EDIT< .

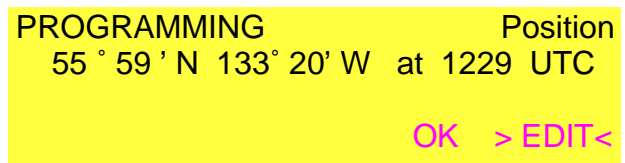

Enter the latitude.



Select S or N using an arrow key.

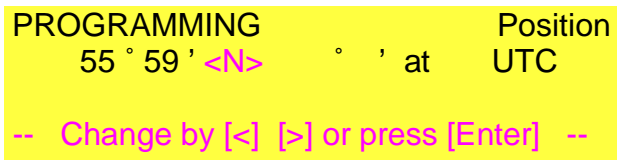

Enter the longitude.

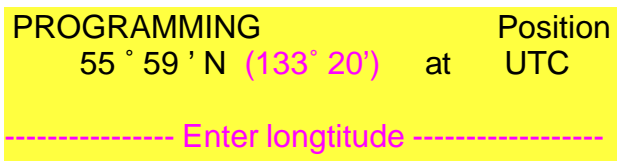

Select E or W using an arrow key.

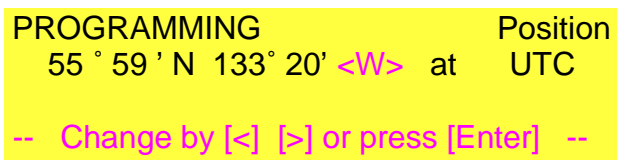

Enter the time.

Press 

PROGRAMMING Position
55 ° 59 ' N 133 ° 20' W at (1229) UTC
--- Enter the time of the position ---

Press  to return to the STATUS display.

PROGRAMMING Position
55 ° 59 ' N 133 ° 20' W at 1229 UTC
>END<



If more than 12 hours have elapsed since the last updating, the time will be deleted.

PROGRAMMING: PRINTER**Printer Status**

The **Printer Status** menu allows selection of:

- Print all calls**
- Print all distress and safety calls**
- Print all RX calls**
- Print distress and safety RX calls**
- Print all RX calls with symbols**
- No print-out**

The arrow key switches between the above options and Enter selects the displayed option and returns to STATUS menu.

Print Lists

The **Print Lists** menu allows selection of:

- Print short-dial list**
- Print DSC frequency list**
- Print Channel list**
- Print MMSI number list**
- Print telephone list**
- Print configuration settings**

The arrow key switches between the above options and Enter selects the displayed option, starts print-out and returns to STATUS menu.

PROGRAMMING: CLOCK SETTING



Enter the UTC time



PROGRAMMING Clock setting
(1229) UTC
----- Enter UTC time -----

Enter the day of month



PROGRAMMING Clock setting
1229 UTC (12)
----- Enter day of month-----

Select the month using an arrow key



PROGRAMMING Clock setting
1229 UTC 12 <Jun>
-- Change by [<] [>] or press [Enter] --

Enter the year



PROGRAMMING Clock setting
1229 UTC 12 Jun (1992)
----- Enter year -----

Press to return to the STATUS display.

PROGRAMMING Clock setting
1229 UTC 12 Jun 1992
>END<

PROGRAMMING: SOUND SETTING



Distress-alarm sound



Select sound type A or B using an arrow key.



```

PROGRAMMING  Distress-alarm sound
Type <A >    Volume *****
-- Change by [<] [>] or press [Enter] --
  
```

Select the volume level using the arrow keys.



```

PROGRAMMING  Distress-alarm sound
Type A       < Volume **.....>
-- Change by [<] [>] or press [Enter] --
  
```

Press [Enter] to return to the STATUS display.

>CHANGE< will return to the beginning of distress-alarm sound programming.

>TEST< will generate the selected sound in the loudspeaker.

```

PROGRAMMING  Distress-alarm sound
Type A       Volume **.....
CHANGE TEST >END<
  
```

Call-alarm sound



Select for how long the call-alarm shall last using the arrow keys.



```

PROGRAMMING  Call-alarm sound
Duration <.5> Type    Volume *****
-- Change by [<] [>] or press [Enter] --
  
```

Select sound type C or D using an arrow key.



```

PROGRAMMING  Call-alarm sound
Duration .5  Type <C> Volume *****
-- Change by [<] [>] or press [Enter] --
  
```

Select the volume level using the arrow keys.

Press

```
PROGRAMMING      Call-alarm sound
Duration .5     Type C < Volume**.....>
```

Press to return to the STATUS display.
 >CHANGE< will return to the beginning of call-alarm sound programming.
 >TEST< will generate the selected sound in the loudspeaker.

```
PROGRAMMING      Call-alarm sound
Duration .5     Type C Volume **.....
                CHANGE TEST >END<
```

Key-beep sound

>KEY-BEEP<

Select the volume level using the arrow keys.

Press to return to the STATUS display.

```
PROGRAMMING      Key-beep sound
Illegal key volume < Volume**.....>
-- Change by [<] [>] or press [Enter] --
```

PROGRAMMING: LIGHT SETTING



Select the "Day" setting for the display backlight using the arrow keys.



Select the "Day" setting for the indicators using the arrow keys.



Select the "Night" setting for the display backlight using the arrow keys.



Select the "Night" setting for the indicators using the arrow keys.

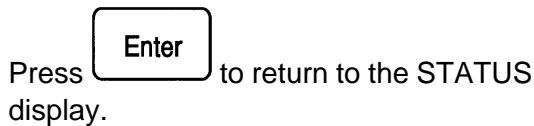

The light in the Distress and Call indicators cannot be reduced completely.

PROGRAMMING: CONTRAST SETTING



Select the contrast setting using the arrow keys.

Press  to return to the STATUS display.

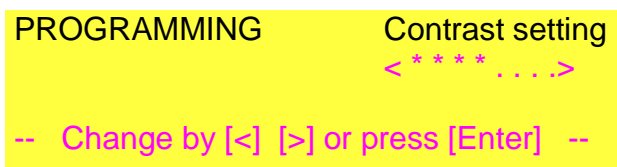

PROGRAMMING: DSC-FREQUENCY LIST



The DSC-frequency list is pre-programmed but can be changed as described below.

Use the arrow key to change between the DSC-frequency numbers or enter the DSC-frequency number of the the frequency pair that you want to change and press



```

PROGRAMMING      DSC frequency list
<01 NATIONAL TX: 2156.0 RX: 1621.0 kHz>
-- Change by [<] [>] or press [Enter] --

```

Press  to edit the displayed frequency pair.

Enter a name for this frequency number.

Press 

```

PROGRAMMING      DSC frequency list
01 (NATIONAL) TX: 2156.0 RX: 1621.0 kHz
----- Enter name -----

```

Enter the DSC transmit frequency.

Press 

```

PROGRAMMING      DSC frequency list
01 NATIONAL (TX: 2156.0) RX: 1621.0 kHz
---- Enter own DSC transmit frequency ----

```

Enter the DSC receive frequency.

Press 

```

PROGRAMMING      DSC frequency list
01 NATIONAL TX: 2156.0 (RX: 1621.0) kHz
---- Enter own DSC receive frequency ----

```



If all fields are empty or "0" the number is deleted from the list. The distress and safety frequencies (94-99) cannot be edited. The pre-programmed DSC frequency list is printed on the next page.

PRE-PROGRAMMED DSC FREQUENCIES

01	NATIONAL	Tx:	2156.0	Rx:	1621.0 kHz
02	NATIONAL		2156.5		1621.5
03	NATIONAL		2157.0		1622.0
04	NATIONAL		2157.5		1622.5
05	NATIONAL		2158.0		1623.0
06	NATIONAL		2158.5		1623.5
07	NATIONAL		2159.0		1624.0
08	NATIONAL		2159.5		1624.5
09	SHIP		2177.0		2177.0
10	INTER		2189.5		2177.0
11	INTER 1		4208.0		4219.5
12	INTER 2		4208.5		4220.0
13	INTER 3		4209.0		4220.5
14	INTER 1		6312.5		6331.0
15	INTER 2		6313.0		6331.5
16	INTER 3		6313.5		6332.0
17	INTER 1		8415.0		8436.5
18	INTER 2		8415.5		8437.0
19	INTER 3		8416.0		8437.5
20	INTER 1		12577.5		12657.0
21	INTER 2		12578.0		12657.5
22	INTER 3		12578.5		12658.0
23	INTER 1		16805.0		16903.0
24	INTER 2		16805.5		16903.5
25	INTER 3		16806.0		16904.0
26	INTER 1		18898.5		19703.5
27	INTER 2		18899.0		19704.0
28	INTER 3		18899.5		19704.5
29	INTER 1		22374.5		22444.0
30	INTER 2		22375.0		22444.5
31	INTER 3		22375.5		22445.0
32	INTER 1		25208.5		26121.0
33	INTER 2		25209.0		26121.5
34	INTER 3		25209.5		26122.0
35	INTER		458.5		455.5
94	DISTRESS		2187.5		2187.5
95	DISTRESS		4207.5		4207.5
96	DISTRESS		6312.0		6312.0
97	DISTRESS		8414.5		8414.5
98	DISTRESS		12577.0		12577.0
99	DISTRESS		16804.5		16804.5

PROGRAMMING: MMSI LIST



Use the arrow key to change between the MMSI list numbers or enter the MMSI list number that you want to program and press



```
PROGRAMMING MMSI list
<01 Name: LYNGBY MMSI: 002191000>
-- Change by [<] [>] or press [Enter] --
```

Press



Enter a name for the vessel or coast station.

Press



```
PROGRAMMING MMSI list
01 Name: (LYNGBY) MMSI: 002191000
----- Enter name -----
```

Enter the MMSI number of the vessel or coast station.

Press



```
PROGRAMMING MMSI list
01 Name: LYNGBY MMSI: (002191000)
- Enter maritime mobile service identity -
```



If all fields are empty or "0" the number is deleted from the list.

Either the nine-digit MMSI number or the MMSI list number (0-99) may be entered when composing a TX-CALL.

When [Enter] is pressed the name and the nine-digit MMSI number is displayed.

When entering an unprogrammed list number the illegal-key sound is given and the number is deleted.

If, when receiving a call, the MMSI number of the calling station is found in the MMSI list, the name of the station will be displayed along with the nine-digit MMSI number.

PROGRAMMING: TELEPHONE LIST



Use the arrow key to change between the telephone list numbers or enter the telephone list number that you want to program and

press

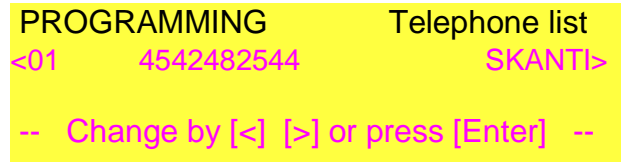

Press to edit the displayed telephone list number.

Enter the telephone number.

Press

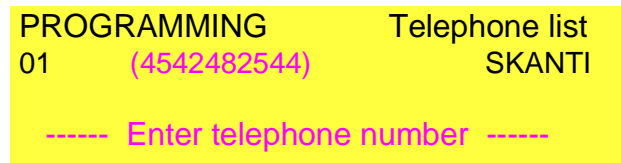

Enter the name of the subscriber.

Press

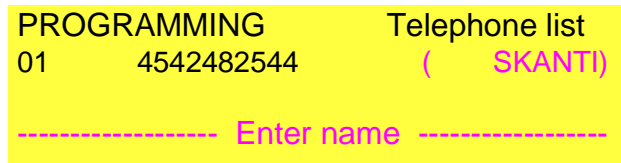

If all fields are empty or "0" the number is deleted from the list.

Either the telephone number or the telephone list number (1-99) may be entered when composing a Direct-dial call.

When [Enter] is pressed the telephone number and the name is displayed.

When entering an unprogrammed list number the illegal-key sound is given and the number is deleted.

TEST: INFO

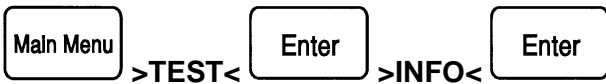

Accumulated ON-time



Press  to return to the STATUS display.

TEST Accumulated ON-time
 Operating hours: 128
 >END<

Version

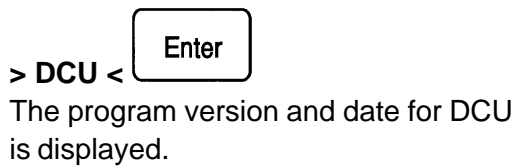

Press  to return to the STATUS display.

TEST Version
 DCU > DU <

TEST Version
 DCU program: 01.07.00 Date: 930621
 >END<



The program version and date is displayed if selecting DU.
 If an additional DU is connected the program version and date for both units are shown. DU 2 denotes the additional unit.

TEST: SELF-TEST

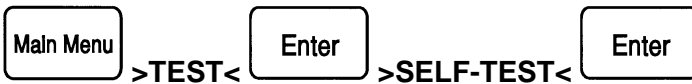

The test starts immediately and will continue until all test are completed and found ok.

Press  to end the test and return to status display.

```
TEST           Automatic Self-test
Completed      19 steps ok
                0 bypassed
                0 failed      >END<
```

If a test fails the self-test will stop and display:
 test step no.
 name of the failing test
 error code

Press  to continue.

```
TEST           Automatic Self-test
03 Synthesizer test:      Failed
Error code: 0301      >CONTINUE< END
```

If any the self test will stop on the next failure.

Press  to continue.

```
TEST           Automatic Self-test
04 Synthesizer test:      Failed
Error code: 0411      >CONTINUE< END
```

When all test are completed a test status is displayed.

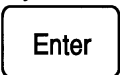
Press  to end the test and return to status display.

```
TEST           Automatic Self-test
Completed      19 steps ok
                0 bypassed
                2 failed      >END<
```



The error code consists of step number (2 digits), indication of previous faults (1 digit: 0=no, 1=yes) and failure type (1 digit).

If an additional DU is connected a selftest on that is included in the sequence. The display will indicate that DU 2 is tested.

TEST: RX-AUDIO



Select which receiver to test using the arrow keys.

Press  to performe the audio test.

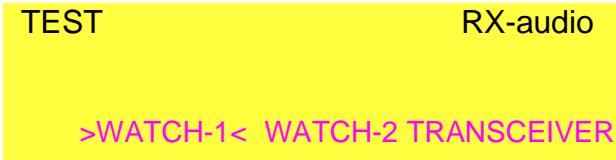

Adjust the volume level using the arrow keys.

Press  to end the test and return to the status display.

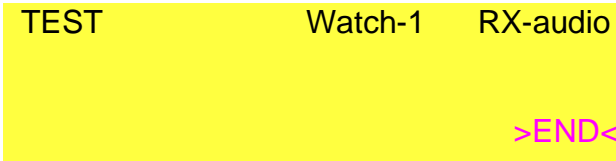

TEST: TX-TEST



A message of warning is displayed.

Press  to continue with the test.

TEST TX-test
A test message is transmitted on a
distress frequency in this test
>CONTINUE< END

Enter the MMSI number of the coast station
to receive the test call.

Press .

TX-CALL Selective to: (00123456)
-Enter the maritime mobile service identity-

Press  to select the DSC frequency.

TX-CALL Selective to: (00123456)
- Press [Enter] to select DSC frequency -

Select a DSC distress frequency
using the arrow keys.

Press .

DSC FREQUENCY SELECTION
<94 DISTRESS Tx: 2187.5 Rx 2187.5>
-- Change by [<] [>] or press [Enter] --

Press  to transmit the test.

TX-CALL Selective to: 00123456
Category: Safety Test
- Press [Call] to send on 2187.5 kHz -
----- Tuning transmitter -----
----- Checking for free channel -----
----- Transmitting -----
---- Awaiting ack on 2187.5 kHz ----

Press  to return to status display.

RX-ACKNOWLEDGEMENT from: 00123456
Category: Safety Test
No additional information
Received on 2187.5 kHz >END<

7. DSC INSTALLATION Table of Contents

Description	7-3	Connectors	7-13
Mounting the units	7-3	Earth connections	7-13
		Net connector, DCU 9000	7-14
Figures and tables		Mounting bracket terminal board	7-15
DCU 9000 with mounting bracket	7-4	Aux connector, DCU 9000	7-16
DCU 9000 installation with mounting bracket	7-5	Installation configuration	7-18
DCU 9000 installation with mounting bracket "Low profile mounting"	7-6	Configuration of self-id	7-18
DCU 9000 installation with mounting bracket "Flush mounting"	7-7	Configuration of group-id	7-18
DCU 9000 installation with mounting bracket 19 inch panel mounting	7-8	Configuration of control unit priority	7-18
Terminal board mounting options	7-9	Configuration of radio interface	7-19
DCU 9000 without mounting bracket	7-10	Configuration of handset hook-switch interface	7-19
DCU 9000 without mounting bracket 19 inch panel mounting	7-11	Configuration of DSC-watch	7-20
Cable connections for DCU without mounting bracket	7-12	Configuration of telex interface	7-20
		Configuration of printer interface	7-20
		Configuration of external alarms	7-21
		Configuration of formats	7-21
		Configuration of messages	7-22
		Accessories included	7-23

DESCRIPTION

General

Correct installation of the DSC 9000 is important for maximum performance and reliability. This chapter provides specific information about the installation of each unit, their interconnection and connection to other equipment.

Mounting the Units

DCU 9000 Control Unit

The DCU 9000 control unit is adaptable to a variety of mounting methods and should be placed with convenient operation in mind. It is installed separately with or without the mounting bracket.

DCU 9000 with Mounting Bracket

The mounting bracket (fig. 5 at page 7-4) is used for table mounting of the DCU 9000, and may also be used for bulkhead and console mounting as shown in fig.6 at page 7-5 and fig.7 at page 7-6. Fig.7 shows how the mounting bracket may be installed behind a bulkhead or a console panel for low profile mounting. Fig.8a and 8b at page 7-7 and fig.9a and 9b at page 7-8 shows how flush mounting may be obtained and gives the dimensions for the necessary hardware.

External connections to the DCU 9000 are made to the terminal strips of the mounting bracket. For top side cable entry the Terminal Board may be dismantled and turned 180 degrees as illustrated in fig.10b at page 7-9.

DCU 9000 without Mounting Bracket

The DCU 9000 without mounting bracket may be bulkhead or console mounted as shown in fig.11 at page 7-10. Fig.12a and 12b at page 7-11 shows how flush mounting may be obtained and gives the dimensions for the necessary hardware.

External connections to the DCU 9000 are made to the connectors at the back of the unit as illustrated in fig.13 at page 7-12.

DCU 9000 WITH MOUNTING BRACKET

Fig.5

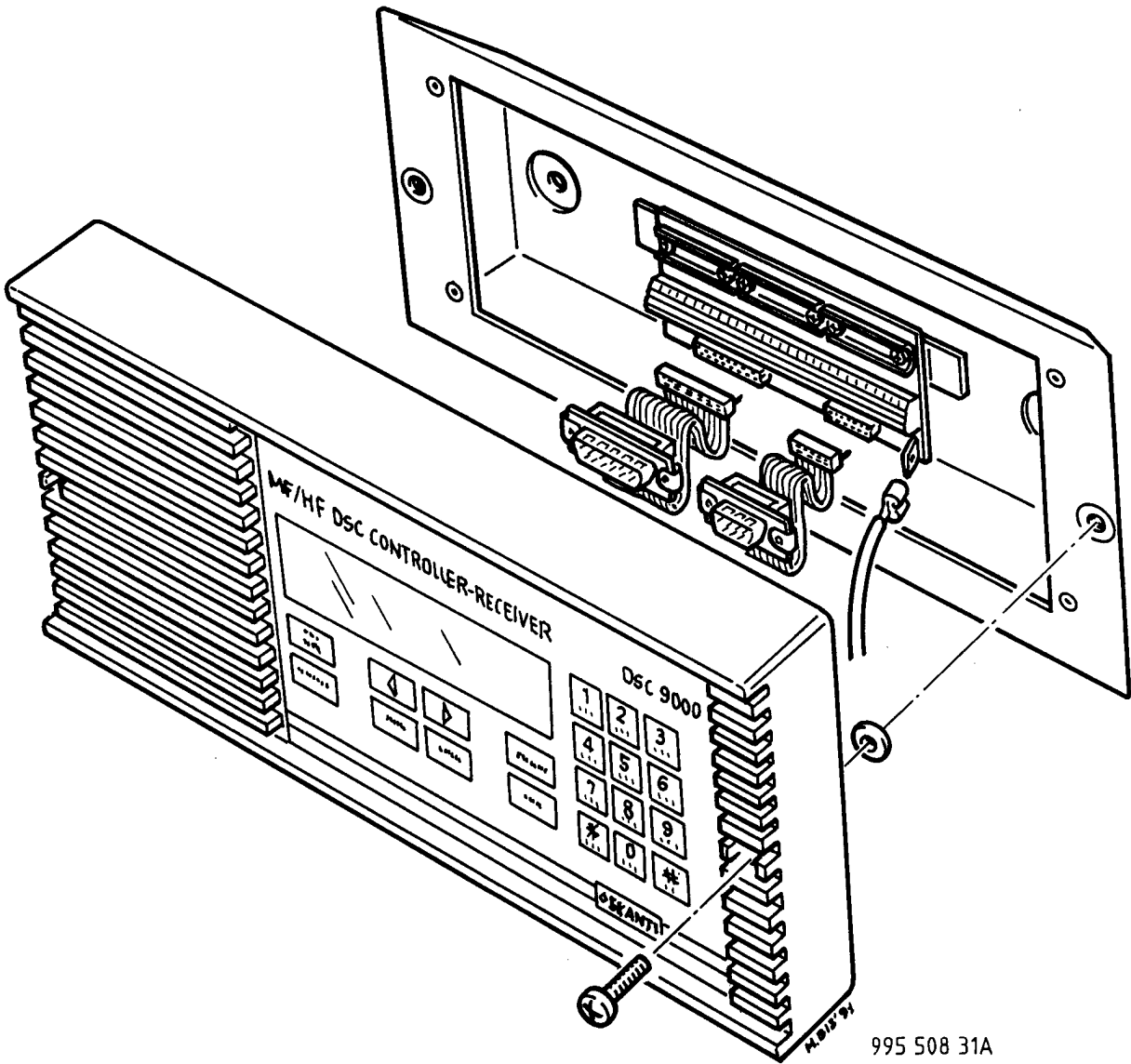

DCU 9000 INSTALLATION WITH MOUNTING BRACKET

Fig.6

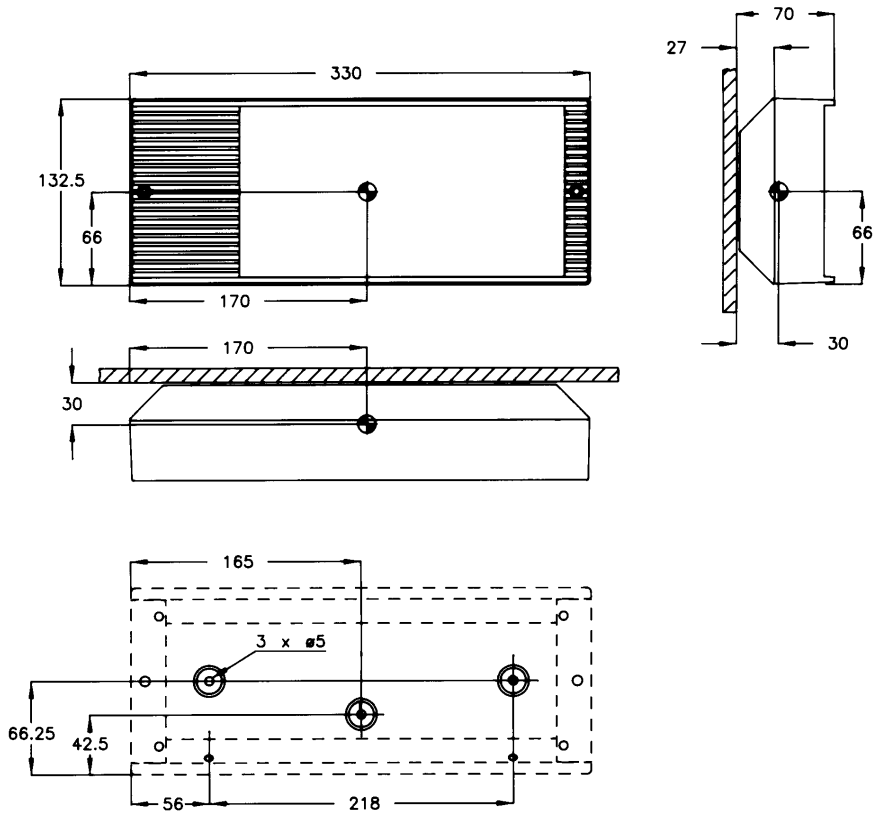

1) Space for cable entry min. 50

Dimensions are in mm

Tolerance: +/- 1 mm

● Centre of Gravity

Weight: DCU 1.2 Kg

Weight: Mounting Bracket 0.7 Kg

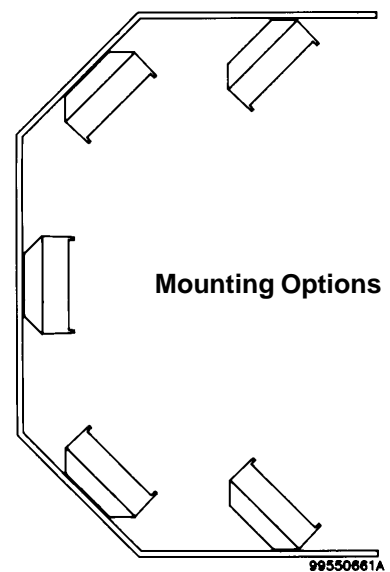

DCU 9000 INSTALLATION WITH MOUNTING BRACKET
"LOW PROFILE MOUNTING" Fig.7

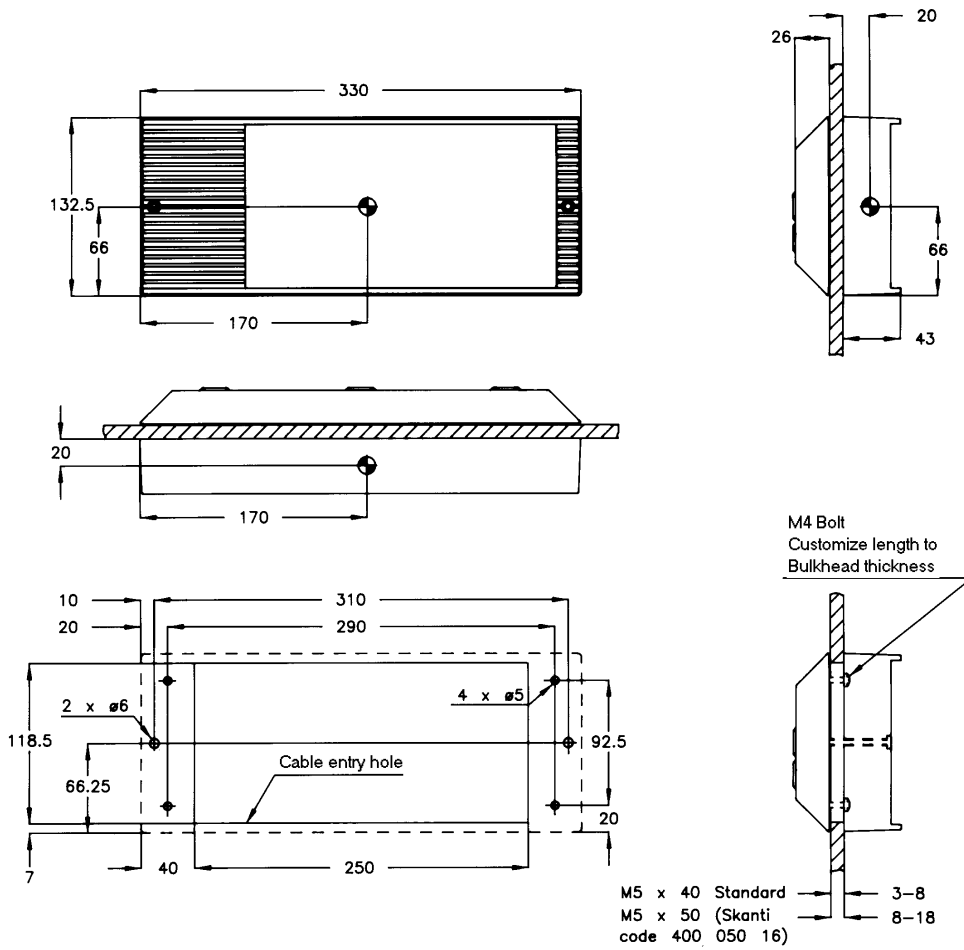

1) Space for cable entry min. 50

Dimensions are in mm
 Tolerance: +/- 1 mm
 ● Centre of Gravity
 Weight: DCU 1.2 Kg
 Weight: Mounting Bracket 0.7 Kg

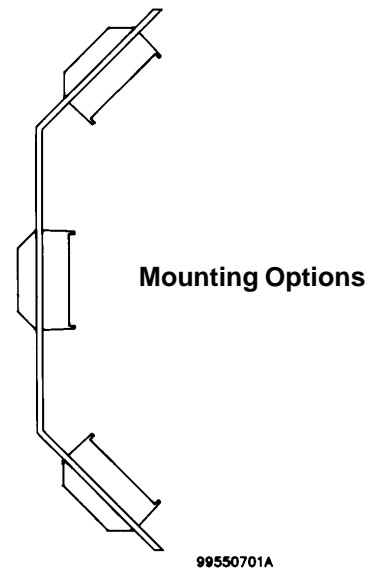

DCU 9000 INSTALLATION WITH MOUNTING BRACKET

"FLUSH MOUNTING" Fig.8a

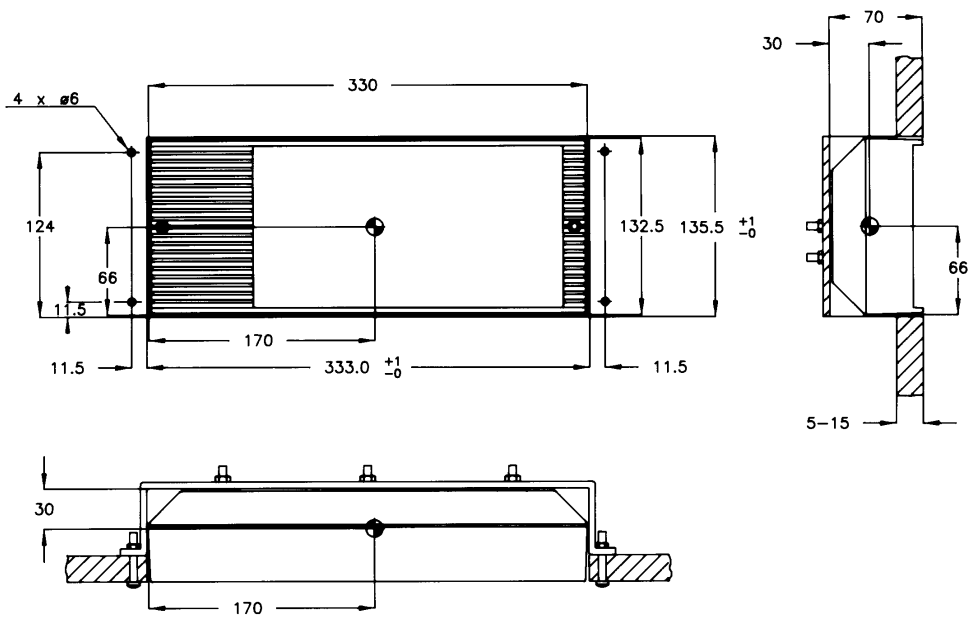

Dimensions are in mm Weight: DCU 1.2 Kg
 Tolerance: +/- 1 mm Weight: Mounting Bracket 0.7 Kg
 ● Centre of Gravity

Construction drawing for Fixture. Fig.8b

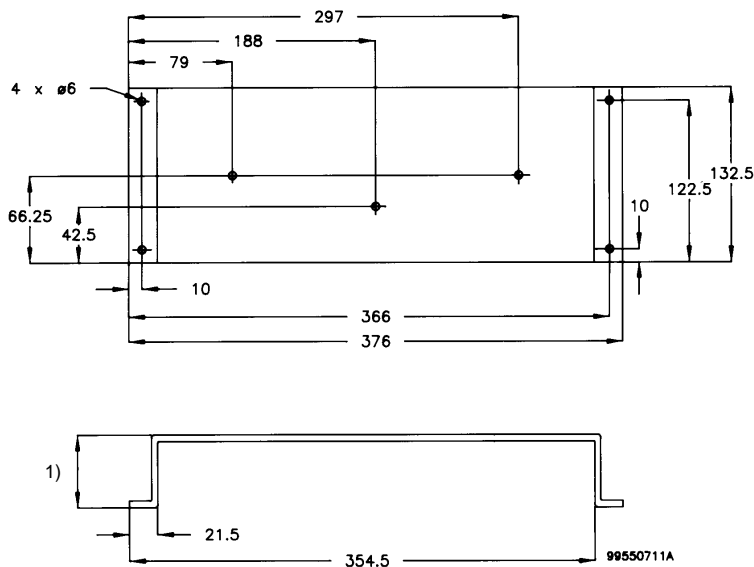

1) Customize to Bulkhead thickness.
 Dimensions are in mm
 Tolerance: +/- 0.2 mm

DCU 9000 INSTALLATION WITH MOUNTING BRACKET

19 INCH PANEL MOUNTING Fig.9a

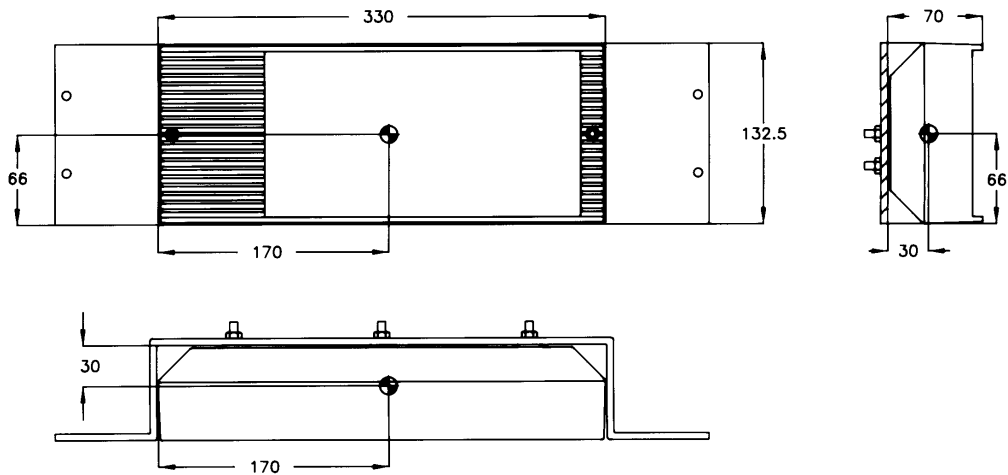

Dimensions are in mm Weight: DCU 1.2 Kg
 Tolerance: +/- 1 mm Weight: Mounting Bracket 0.7 Kg

☉ Centre of Gravity

Construction drawing for Fixture. Fig.9b

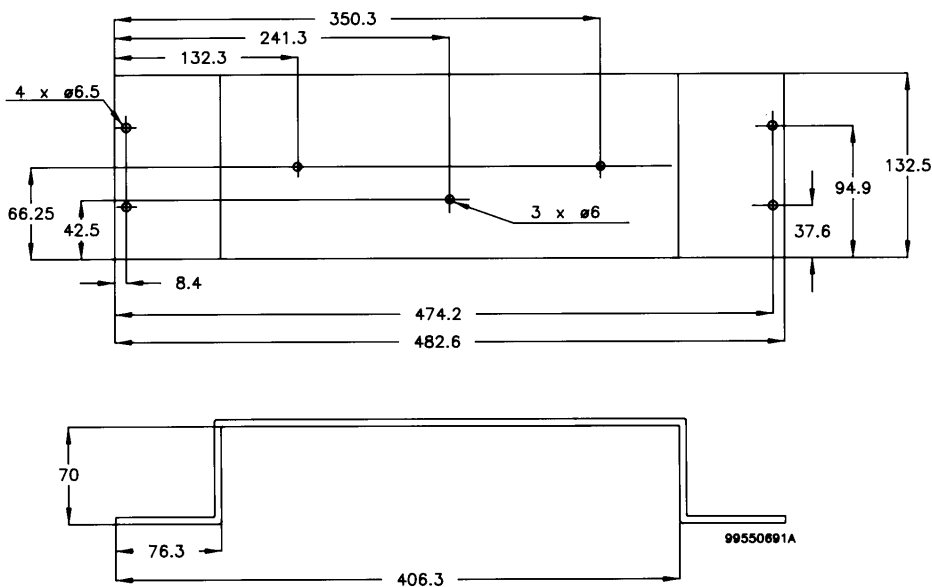

Dimensions are in mm
 Tolerance: +/- 0.2 mm

TERMINAL BOARD MOUNTING OPTIONS

NORMAL MOUNTING OF TERMINAL BOARD

Fig.10a

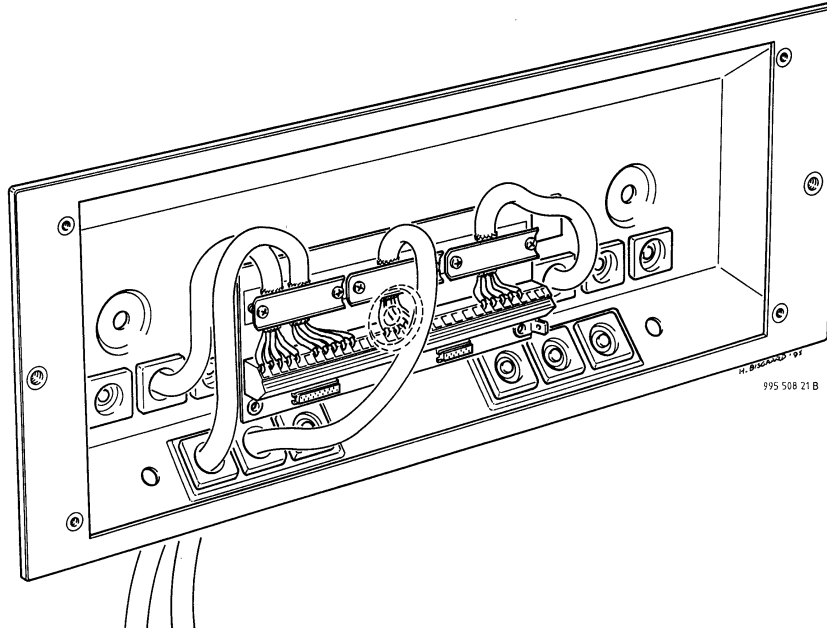

180 ° MOUNTING OF TERMINAL BOARD

Fig.10b

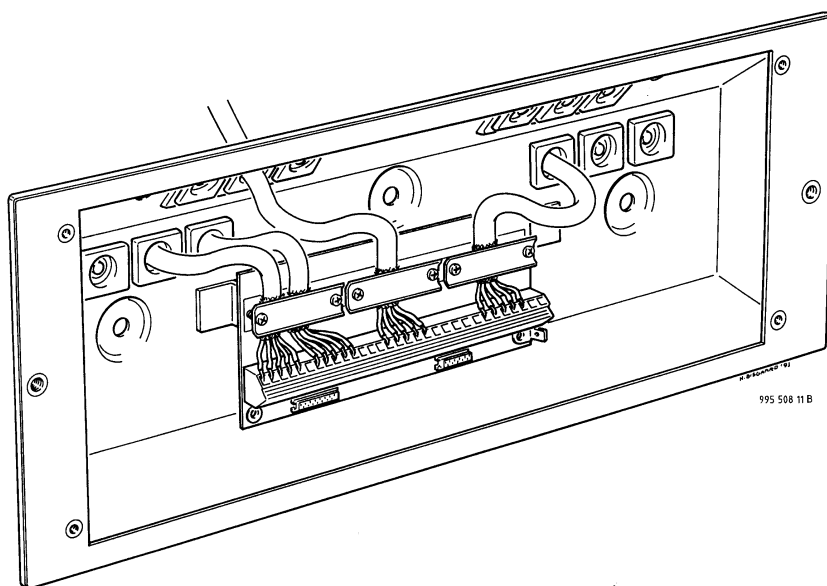

DCU 9000 WITHOUT MOUNTING BRACKET

Fig.11

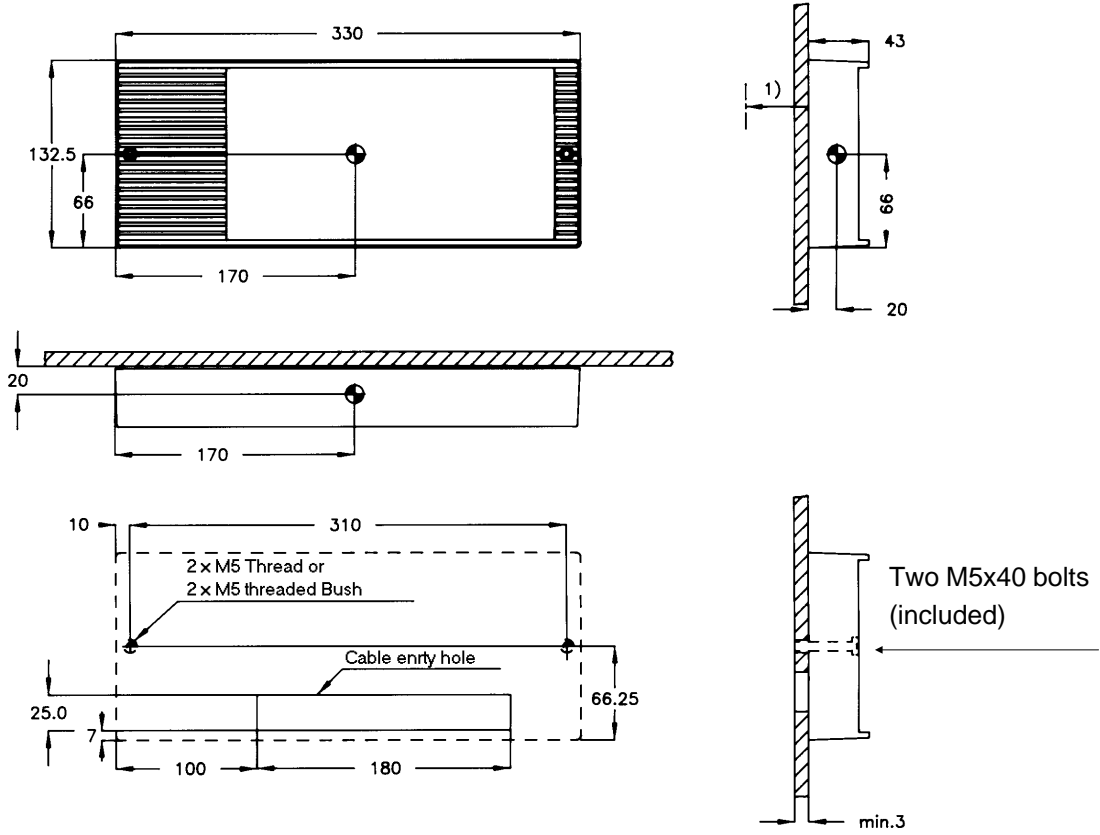

1) Space for cable entry min. 100

Dimensions are in mm
Tolerance: +/- 1 mm
● Centre of Gravity
Weight: 1.2 Kg

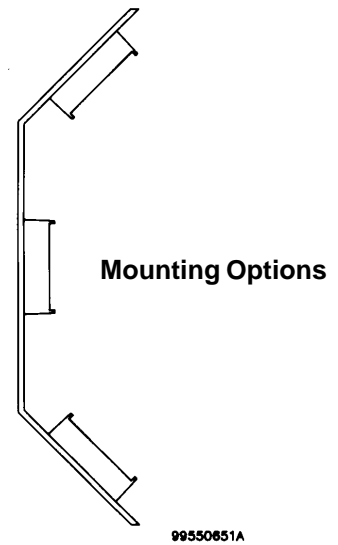

DCU 9000 WITHOUT MOUNTING BRACKET

19 INCH PANEL MOUNTING Fig.12a

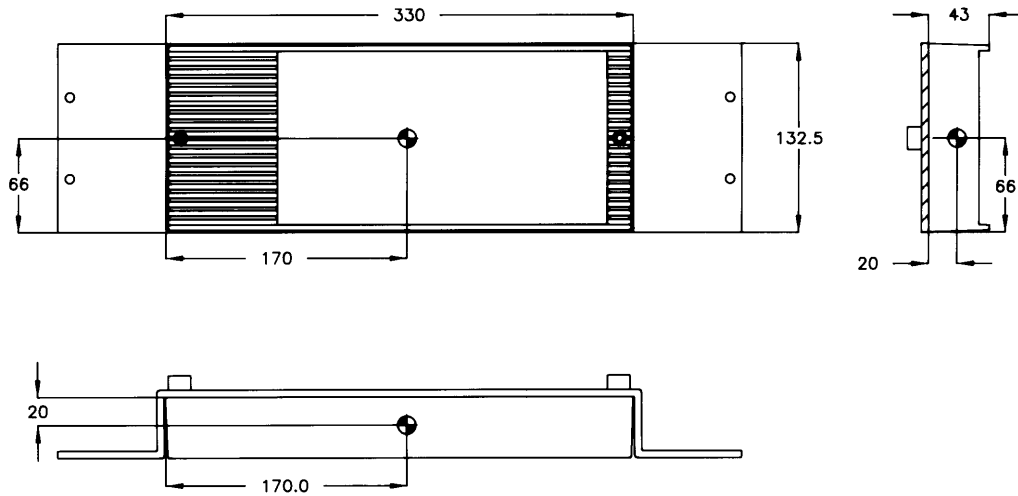

Dimensions are in mm Weight: DCU 1.2 Kg

Tolerance: +/- 1 mm

● Centre of Gravity

Construction drawing for Fixture. Fig.12b

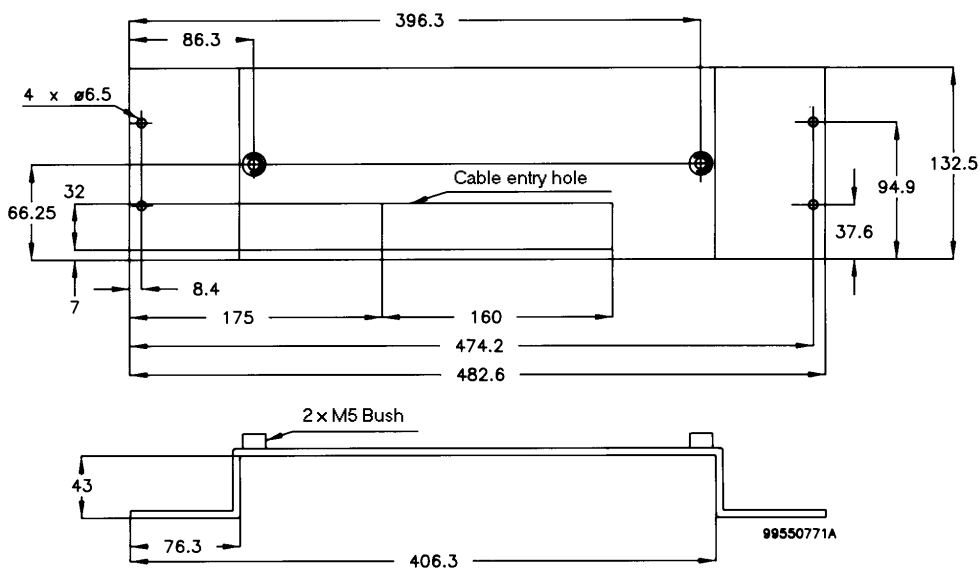

Dimensions are in mm

Tolerance: +/- 0.2 mm

CABLE CONNECTIONS FOR DCU WITHOUT MOUNTING BRACKET

Fig.13

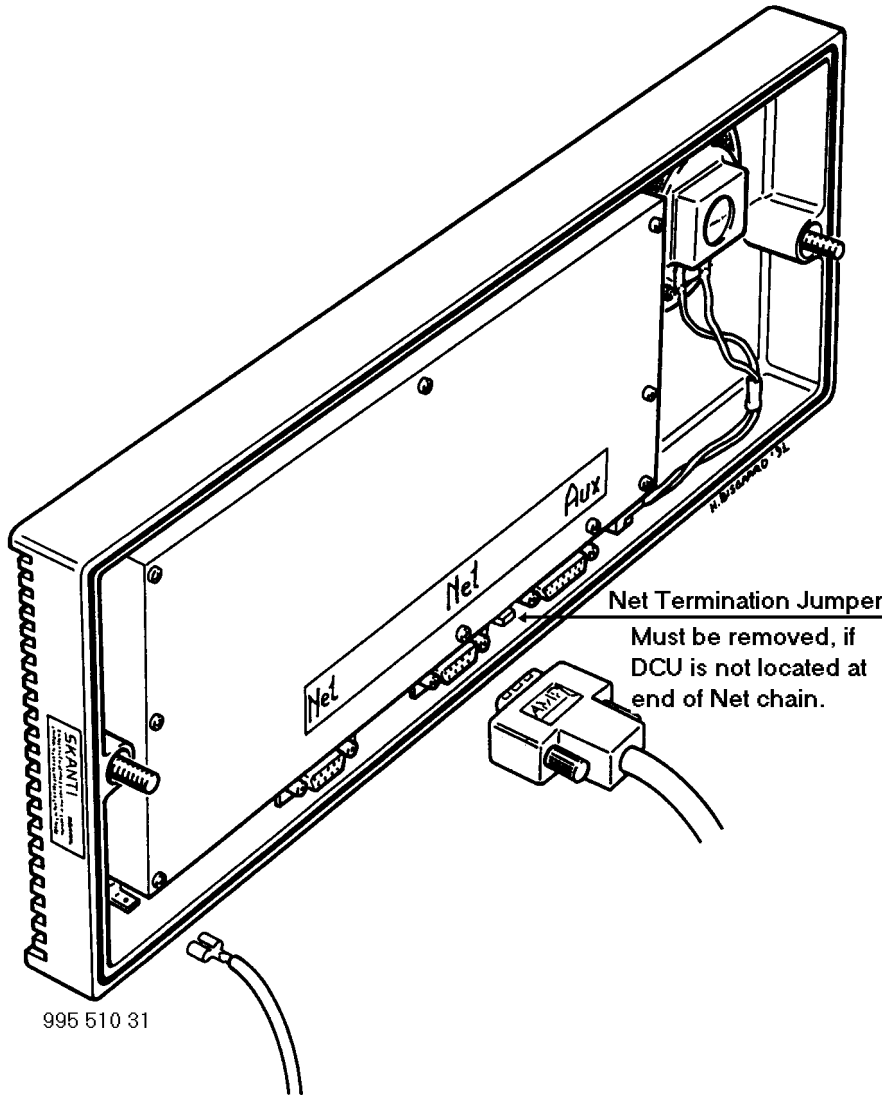

EARTH CONNECTIONS

Fig.18

DCU 9000, EARTH CONNECTION

Skanti part no. 772 000 17

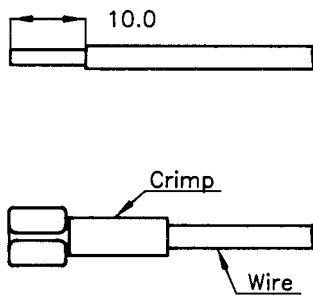
**Wire specification**

Recommended wire dimension: min. 2.5 mm Sq .

Wire length as short as possible.

NET CONNECTOR, DCU 9000

Fig.21

SKANTI part no. 751 000 64.

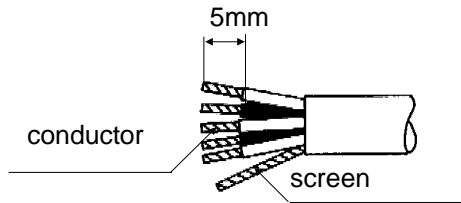
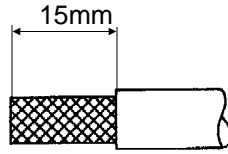

Identify twisted pairs.
 Before contacts of plug are soldered: slide the plastic cover over the cable .
 After the contacts are soldered: latch the inner and outer shields into the connectors from the rear and snap in.
 Finally slide the plastic cover over the shield and fix the two jack screws into the plastic cover.

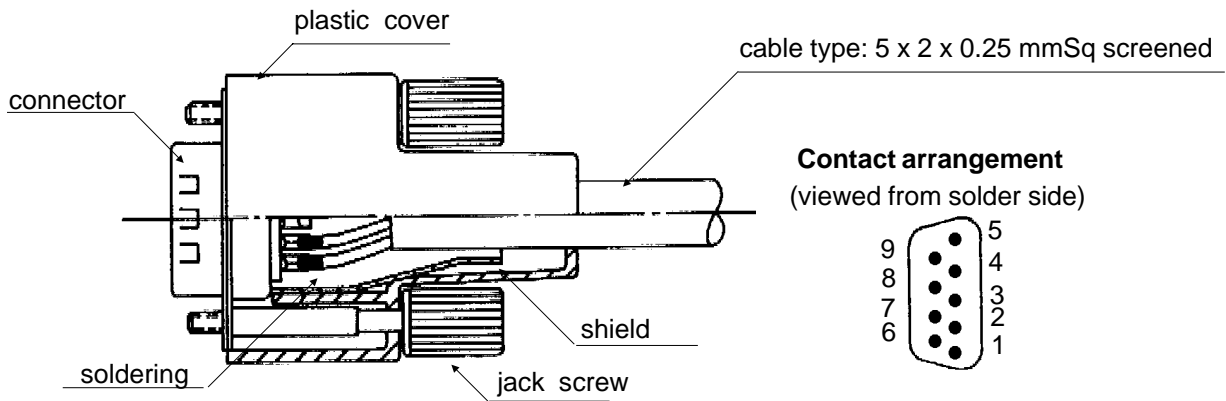

Pin no.	Designation	Remarks
1	Supply On	For switching-on power supply
2	Data+	For data communication between units
3	Data-	For data communication between units
4	AF+	Balanced audio signals
5	AF-	Balanced audio signals
6	GND	Ground reference
7	+24V	Supply voltage to control units
8	RXAF+	Not used in DSC 9000
9	RXAF-	Not used in DSC 9000
Shield	Cable screen	

Table 3

Twisted pairs:
 1 and 6
 2 and 3
 4 and 5
 6 and 7
 8 and 9

MOUNTING BRACKET TERMINAL BOARD

Fig.22

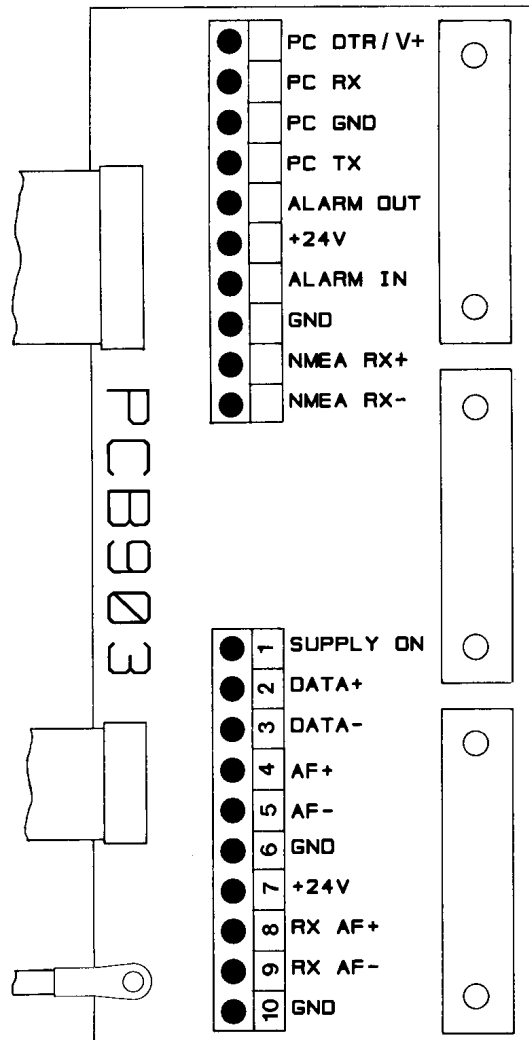

995 509 91 A

AUX CONNECTOR, DCU 9000

Fig.23

SKANTI part no. 751 000 65.

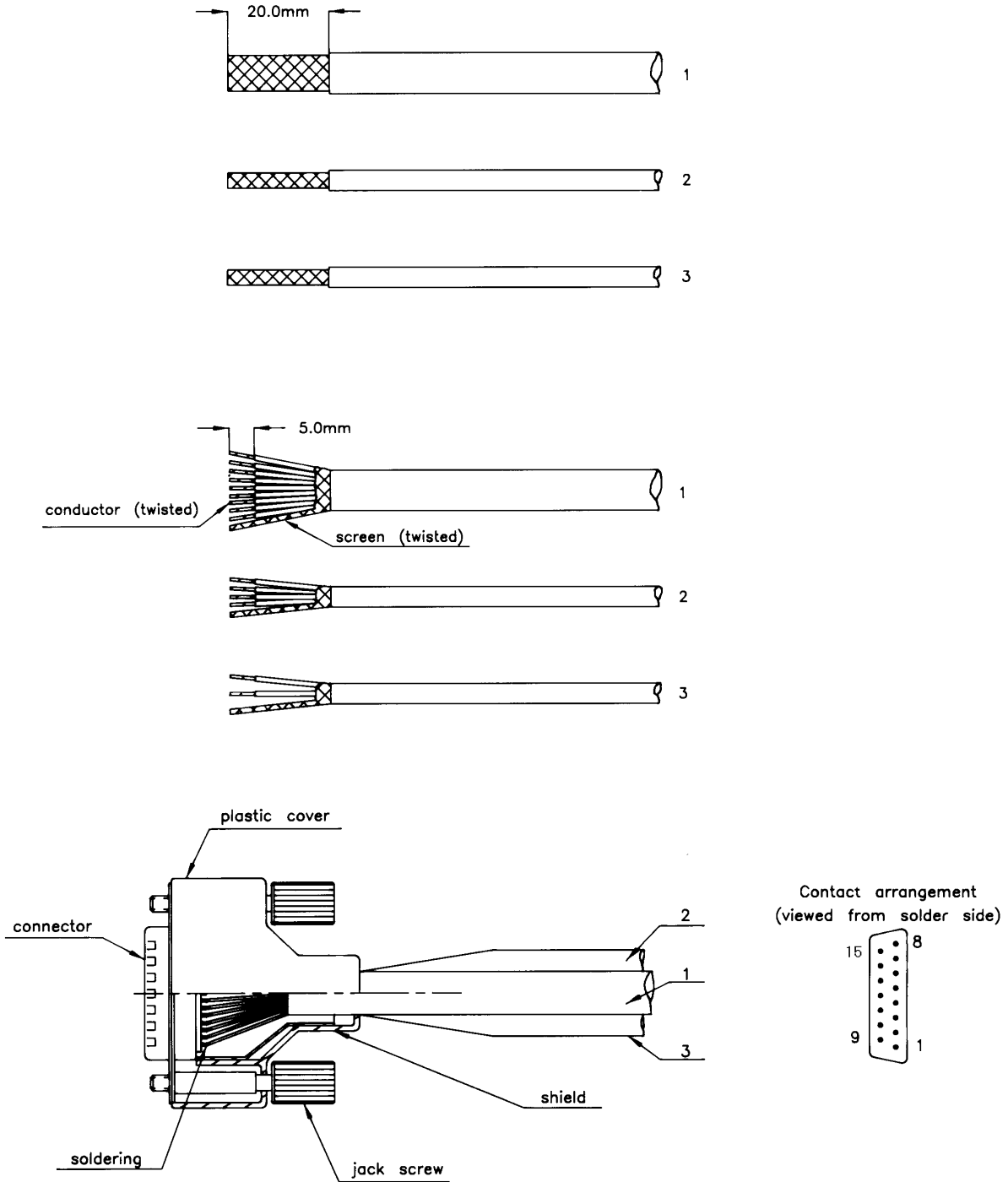

Cable specification

Acommodate cable outer diameter from 4.4 to 11.0 mm

Pin no.	Designation	Direction	Remarks
1	PC DTR / V+	Input	+5V/+15V supply for opto-isolated serial data interface for printer (RS-232) *)
2	PC GND		Power supply reference for serial data interface for printer (RS-232) *)
3	Alarm Out	Output	Open collector (RS-410N) for external alarm. Max 50mA, 32V. Active Low
4	Alarm In	Input	For external distress alarm button. Internal pull-up to 15V through 2.5kohm.
5	NMEA Rx+	Input	Opto-isolated serial interface for navigation equipment (NMEA 0183)
6	n.c.		
7	n.c.		
8	n.c.		
9	PC Rx	Input	Serial data input or busy input for printer (RS-232) *)
10	PC Tx	Output	Serial data output for printer (RS-232) *)
11	+24 V	Output	+24V for use with 'Alarm Out'. Max 100 mA. Internally protected.
12	GND		
13	NMEA Rx-	Input	Opto-isolated serial interface for navigation equipment (NMEA 0183)
14	n.c.		
15	n.c.		

Table 4

*) The printer interface is opto-isolated with driver power delivered from the printer. Most printers deliver a High (+5V to +15V) signal on one of the connector pins when the printer is operational. Opto-isolation may be disabled by connecting the terminals PC GND and GND and connecting a 2.2 kohm resistor between the terminals +24V and PC DTR/V+.

The terminal 'PC RX' is used for handshake signal input:

If Xon/Xoff handshake is used, the terminal must be connected to the outgoing serial data pin of the printer.

If Busy (High/Low) handshake is used, the terminal must be connected to the printer Ready/Busy signal output.

See page 3-20 for configuration of printer interface.

INSTALLATION CONFIGURATION

The DSC 9000 is factory configured to standard settings, stored in a non-volatile EEPROM. Change of these settings is possible from the front panel of the DCU 9000.

To view or change configuration settings, switch the equipment on, press [Main Menu], select CONFIGURATION and press [Enter]. Select VIEW or CHANGE and press [Enter].

To protect against unintentional changes a password must be entered if CHANGE is selected. The figures are not displayed while keyed-in.

Note: Following any change in configuration setting the supply must be switched off-on to implement the changes.

Configuration of Self-ID

The Maritime Mobile Service Identity assigned to the station must be stored in the DSC 9000 before it can be used.

Select SELF-ID in the CONFIGURATION menu and press [Enter]. Key-in the MMSI and press [Enter].

To prevent the operator from changing the self-ID, it must be protected by entering PROTECT. *Please note that once PROTECT has been entered, change of self-ID is not possible (only after a factory resetting. See page 3-47).* Therefore, check the numbers carefully for correctness before pressing [Enter].

Configuration of Group-ID

One or more group call identities may be assigned to the station. Group call identity numbers always contains a leading zero. The group call identities assigned to the station must be stored in the DSC 9000 before it is able to respond to group calls. Up to six group call identity numbers may be stored.

Select GROUP-ID in the CONFIGURATION menu and press [Enter]. Key-in the group call identities and press [Enter]. Check that the self-ID is correct after having switched the equipment off and on.

Configuration of Control Unit Priority

Where more control units are connected to a DU 9000 each control unit may be given a priority.

Only a control unit with higher priority can interrupt a control unit which is in any other state than MAIN-MENU or STATUS states.

To change the priority level select PRIORITY in the CONFIGURATION menu and press [Enter]. Select the desired priority level (1. priority is the highest level) and press [Enter].

Note: If an external distress alarm button is connected to a control unit, this control unit should be given priority

Configuration of Radio Interface

The DSC 9000 may be configured for different protocols for control of the associated radio equipment:

T+Bus (default)
T+Bus, one way
NMEA

Baudrate 2400 bps for T+Bus and 4800 bps for NMEA is implicitly selected.

Following NMEA sentences are used to set frequency, mode of operation and transmitter power level of the radio equipment.

RX frequency:

```
$CDFSI, ,xxxxxx,c,*hh<CR><LF>
      - Mode of operation1
      - Receiving frequency2
```

TX frequency:

```
$CDFSI, ,xxxxxx, ,c,9*hh<CR><LF>
      - Power level (9=highest)
      - Mode of operation1
      - Transmitting frequency2
```

Notes:

1) Mode of operation:

m = J3E, telephone
o = H3E, telephone
w = F1B/J2B, teleprinter/DSC
{ = A1A Morse, morse key/headset

2) Frequency in 100 Hz increments.

To change configuration select INTERFACES in the CONFIGURATION menu and press [Enter]. Select RADIO in the Interfaces menu and press [Enter]. Select CONTROL in the Radio interface menu and press [Enter]. Select the desired option and press [Enter].

Configuration of Handset Hook-Switch Interface

The handset hook interface may be configured for either polarity of the input signal or for ignoring the input, i.e. if no hook-switch is connected.

To change configuration select INTERFACES in the CONFIGURATION menu and press [Enter]. Select RADIO in the Interfaces menu and press [Enter]. Select HANDSET-HOOK in the Radio interface menu and press [Enter]. Select the correct option Normal, Reverse or Ignore. 'Normal' corresponds to off-hook = low input signal. Press [Enter].

TRP 7000: Normal

TRP 8000 handset with built-in hook switch: Reverse

The handset hook signal is utilized as follows:

When the receiver of the radiotelephone is used for scanning controlled from the DSC 9000 or radiotelex equipment, scanning is interrupted while the handset is off-hook. At the same time automatic DSC acknowledgement transmissions are disabled. Scanning is automatically resumed when the handset is placed on-hook.

When a Selective or Direct-dial telephony call is received, lifting the handset off-hook will stop the acoustic alarm, start transmission of an acknowledgement, and set the radiotelephone to the appropriate working frequencies.

Configuration of DSC-watch

The DSC 9000 enables two DSC watch receivers to be used simultaneously. The status display contains a line for each receiver/demodulator, indicating the DSC watch frequencies.

It is possible by configuration to select between different DSC watch lay-outs in the status display:

Distress watch MF

Distress watch MF/HF

Calling watch

None

One of the lay-outs may be selected for each watch receiver.

To change the configuration, select WATCH in the CONFIGURATION menu and press [Enter]. Select the desired configuration for each watch receiver and press [Enter].

Note: When the TRP 7000 or TRP 8000 is intended to be used for automated radiotelex and no additional DU configured as a DSC watch receiver is connected (see page 3-7 'Connection of an additional DU'), 'None' should be selected for 'watch receiver 2'.

Configuration of Telex Interface

Select INTERFACES in the CONFIGURATION menu and press [Enter]. Select TELEX in the Interfaces menu and press [Enter]. Select 'External modem' if an external radiotelex modem is used and press [Enter].

Configuration of Printer Interface

Select INTERFACES in the CONFIGURATION menu and press [Enter]. Select PRINTER in the Interfaces menu and press [Enter]. Select between connection to

This DCU, None/other DCU, or DU*

and press [Enter]. Select between Baud rates of

300, 600, 1200, 2400, 4800*, or 9600

and press [Enter]. Select between Parity/data bits

None/7, None/8*, Even/7, Even/8, Odd/7, or Odd/8

and press [Enter]. Select between handshake types

Xon/xoff, Busy High, Busy Low, None*

and press [Enter]. Select between paper feed

Up* or Down

and press [Enter].

*) Default

Configuration of External Alarms

Select INTERFACES in the CONFIGURATION menu and press [Enter]. Select ALARMS in the Interfaces menu and press [Enter]. Select for each output in turn the desired activation conditions:

Distress alarm only

Call alarm only

Distress + Call alarm

Distress alarm + lamp

Configuration of Formats

Certain call formats may be omitted. This enables the DSC 9000 to be adapted to specific applications where it is desirable to avoid unintended use of these formats.

The formats that can be disabled are:

Distress

Group + Area

Direct-dial

To change the configuration, select FORMAT in the CONFIGURATION menu and press [Enter]. Select 'Yes' to include a format, or 'No' to disable a format, and press [Enter].

All formats can be received and displayed in RX-calls irrespective of the configuration settings.

Configuration of Messages

It is possible to select between the full set of telecommands or a reduced set. The reduced set may be selected where it is desirable to avoid unintended use of the telecommands.

Full set of telecommands:

- Polling
- Unable to comply
- Congestion
- Busy
- Queue
- Station barred
- No operator
- Temporarily no opr
- Equipment disabled
- Cannot use channel
- Cannot use mode
- Data V.21
- Data V.22
- Data V.22 bis
- Data V.23
- Data V.26 bis
- Data V.26 ter
- Data V.27 ter
- Data V.32
- USB telephony
- AM telephony
- Distress relay
- FEC telex
- ARQ telex
- RTTY receive
- RTTY
- A1A/CW tape
- Ship position
- A1A/CW Morse
- Facsimile
- No information

Reduced set of telecommands:

- USB telephony
- Distress relay
- FEC telex
- ARQ telex

Only messages enabled by configuration are selectable in TX-calls. All messages may be displayed in RX-calls and TX-acknowledgements, irrespective of the configuration.

ACCESSORIES INCLUDED

DCU 9000:

<u>DESIGNATION</u>	<u>QUANTITY</u>	<u>SKANTI PART NUMBER</u>
Mounting bracket for DCU 9000	1	107 810 40
D-sub connector, 9 pole, male	2	751 000 64
D-sub connector, 15 pole, male	1	751 000 65
Tab connector, female	1	772 000 17



Skandinavisk Teleindustri SKANTI A/S
4 Lautrupvang
DK-2750 Ballerup, Denmark
Phone: +45 44 74 84 00
Fax: +45 44 74 84 01
Telex 37292 skanti dk
E-mail skanti@skanti.dk
<http://www.skanti.dk>