

Introduction

This manual provides technical information necessary for servicing the VX-2500V Transceiver.

Servicing this equipment requires expertise in handling surface-mount chip components. Attempts by non-qualified persons to service this equipment may result in permanent damage not covered by the warranty, and may be illegal in some countries.

Two PCB layout diagrams are provided for each double-sided circuit board in the transceiver. Each side of the board is referred to by the type of the majority of components installed on that side ("leaded" or "chip-only"). In most cases one side has only chip components, and the other has either a mixture of both chip and leaded components (trimmers, coils, electrolytic capacitors, ICs, etc.), or leaded components only.

While we believe the technical information in this manual to be correct, Vertex Standard assumes no liability for damage that may occur as a result of typographical or other errors that may be present. Your cooperation in pointing out any inconsistencies in the technical information would be appreciated.

Contents

Specifications	2	Alignment	11
DSUB 9-pin Accessory Connector	3	RF Unit Jumper Information	16
Exploded View & Miscellaneous Parts	4	Board Unit (Schematics, Layouts & Parts)	
Block Diagram	5	RF Unit	17
Interconnection Diagram	7	Panel Unit	31
Circuit Description	9		

Specifications

General

Frequency range:	134-160 MHz (Type A) 148-174 MHz (Type C)
Number of Systems:	32
Number of Groups:	250
Number of Channels :	250 channels (Conventional) <i>640 channels (Trunking)</i>
PLL Steps:	5.0 kHz/6.25kHz
Power Supply Voltage:	13.8V DC ±15 %
Channel Spacing:	12.5 /25.0 kHz
Current Consumption (Approx.):	TX: 6 A RX: 700 mA STBY: 250 mA
Operating Temperature range:	-22 °F to 140 °F (-30 °C to +60 °C)
Frequency Stability:	Better than ±2.5 ppm
RF Input-Output Impedance:	50 ohms
Audio Output Impedance:	4 ohms
Dimensions:	6.3 x 1.6 x 4.3 inch (160 x 40 x 110 mm)
Weight (Approx.):	1.87 lb (0.85 kg)

Receiver (Typical Values)

Circuit type:	Double conversion Super-heterodyne
Sensitivity:	0.25 uV (12 dB SINAD)
Adjacent Channel Selectivity:	80/70 dB
Intermodulation:	75 dB
Spurious and Image Rejection:	90 dB
Audio Output:	4 W @ 4 ohms 5% THD
Audio Distortion:	<3 % @1 kHz

Transmitter (Typical Values)

Power Output:	25 W (low: 5W)
Modulation:	16K0F3E, 11K0F3E
Max Deviation:	5.0/2.5 kHz
Conducted Spurious Emission:	70 dB below carrier
Audio Distortion:	<3 % @ 1 kHz
Microphone type:	Dynamic
Microphone impedance:	600 ohms

DSUB 9-pin Accessory Connector

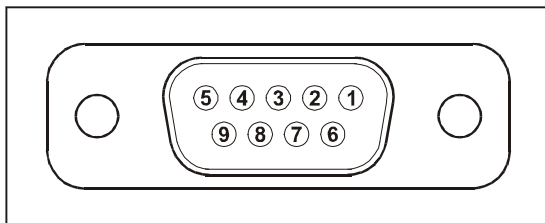

Pin 1: Output Logic squelch

High: Radio receiving the signal with the correct CTCSS, DCS, or LTR ID.

Low: Radio not receiving the signal with the correct CTCSS, DCS, or LTR ID.

Pin 2: Output Rx discriminator

JP3 (JP1503) - Flat: 10 Hz to 3.0 kHz (140 mVrms /STD deviation with 600 ohm termination)

or

JP4 (JP1504) - Filtered 300 Hz to 3.0 kHz (70 mVrms /STD deviation with 600 ohm termination)

* Note: JP3 is closed from the factory, and JP4 is not closed from the factory.

Pin 3: Input TX data to the radio modulator. (Flat: 10 Hz to 3.0 kHz)

(40 mVrms /STD deviation)

Pin 4: Input DTR (to switch the radio operation between dispatch operation and Data mode)

[DTR Low: Turn on the Data transmission, less than 0.5 V]

[DTR High: Turn off the Data transmission, more than 4.0 V]

Pin 5: Ground

Pin 6: Output Horn alert signal (Open collector with maximum 16.0 V, 100 mA sink).

Pin 7: Input external PTT

[Low: Request the transmission]

[High: Request the Receiving]

Pin 8: Output supply voltage (Need to set the solder short on the PCB)

JP1 (JP1501) Output 5.0 V (Maximum 100 mA output)

or

JP2(JP1502) Output 13.8 V (Maximum 100 mA output)

* Both JP1 and JP2 are not closed from the factory.

Pin 9: Input the ignition signal of the CAR.

This signal is for the following operation,

(1) Disable the Horn alert during the ignition is turned on.

(2) Turn on and off the radio. This function requires the solder short JP8 (JP1508).

Exploded View & Miscellaneous Parts

REF.	VXSTD P/N	DESCRIPTION	QTY.
①	U20206002	BINDING HEAD SCREW M2.6 x 6 NI	1
②	U20306002	BINDING HEAD SCREW M3 x 6 NI	2
③	U20308002	BINDING HEAD SCREW M3 x 8 NI	2
④	U24306002	TAPTITE SCREW M3 x 6 NI	4
⑤	U24308001	TAPTITE SCREW M3 x 8	1
⑥	U31206007	OVAL HEAD SCREW M2.6 x 6 B	7

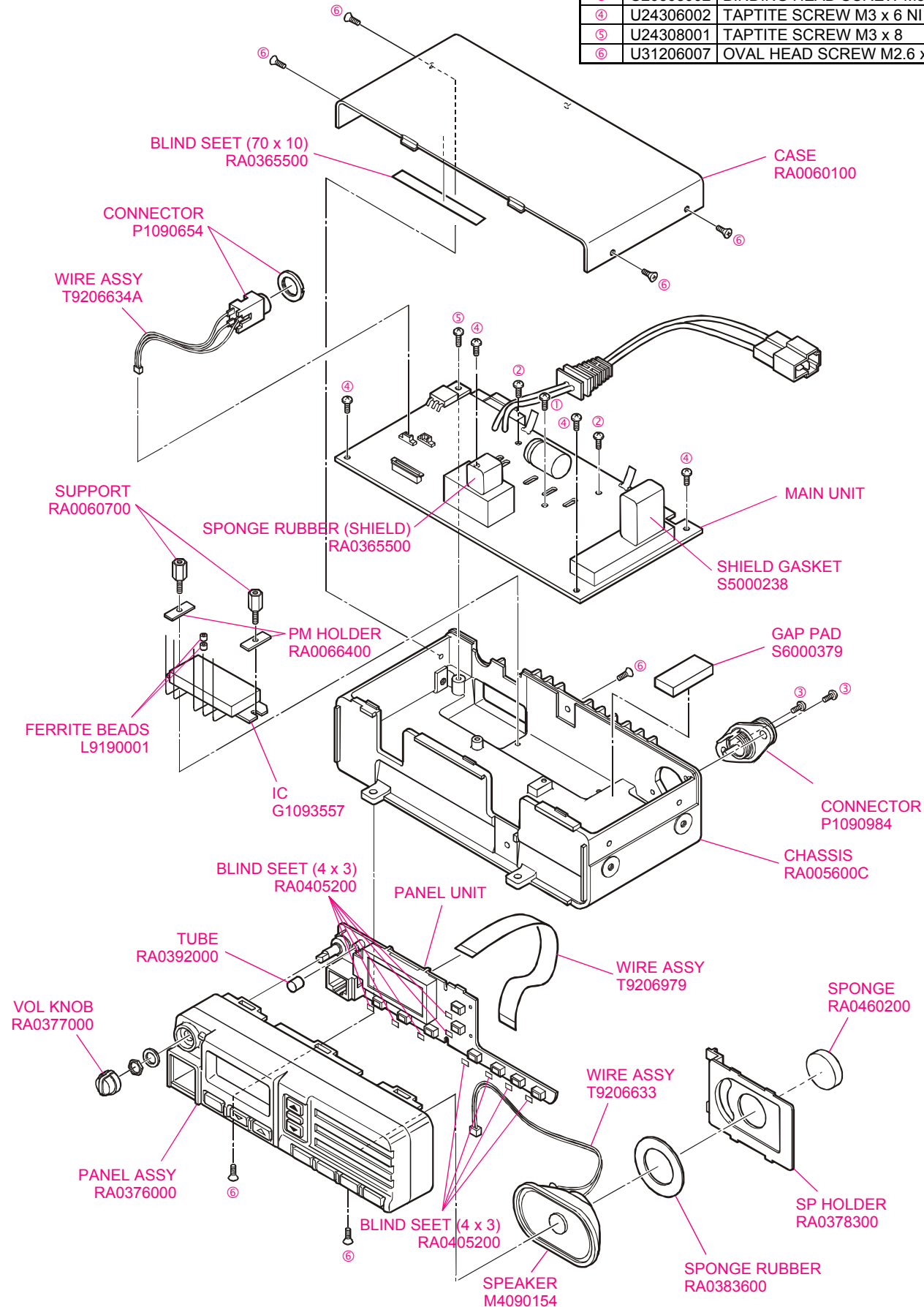

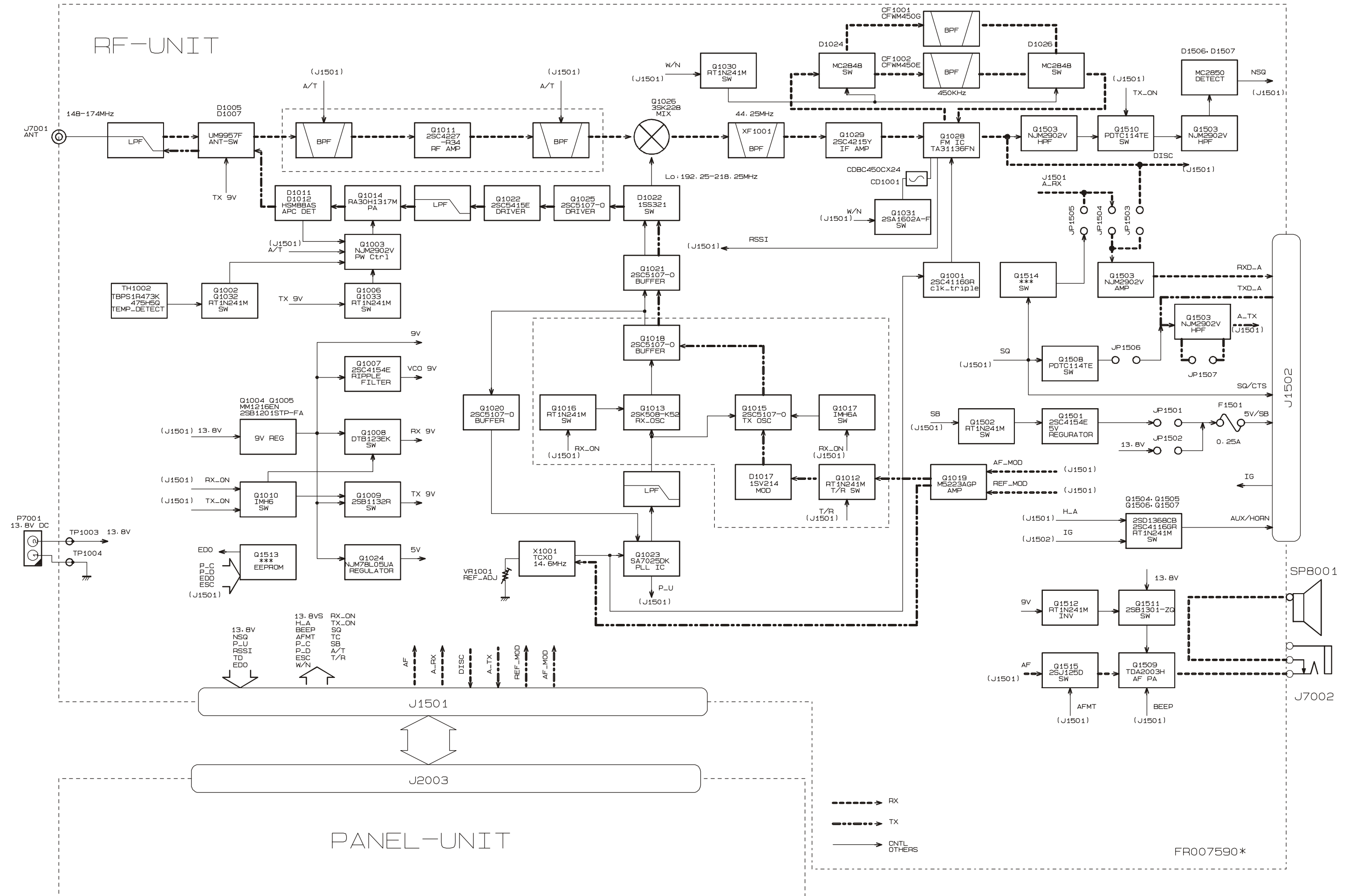

Block Diagram (2)

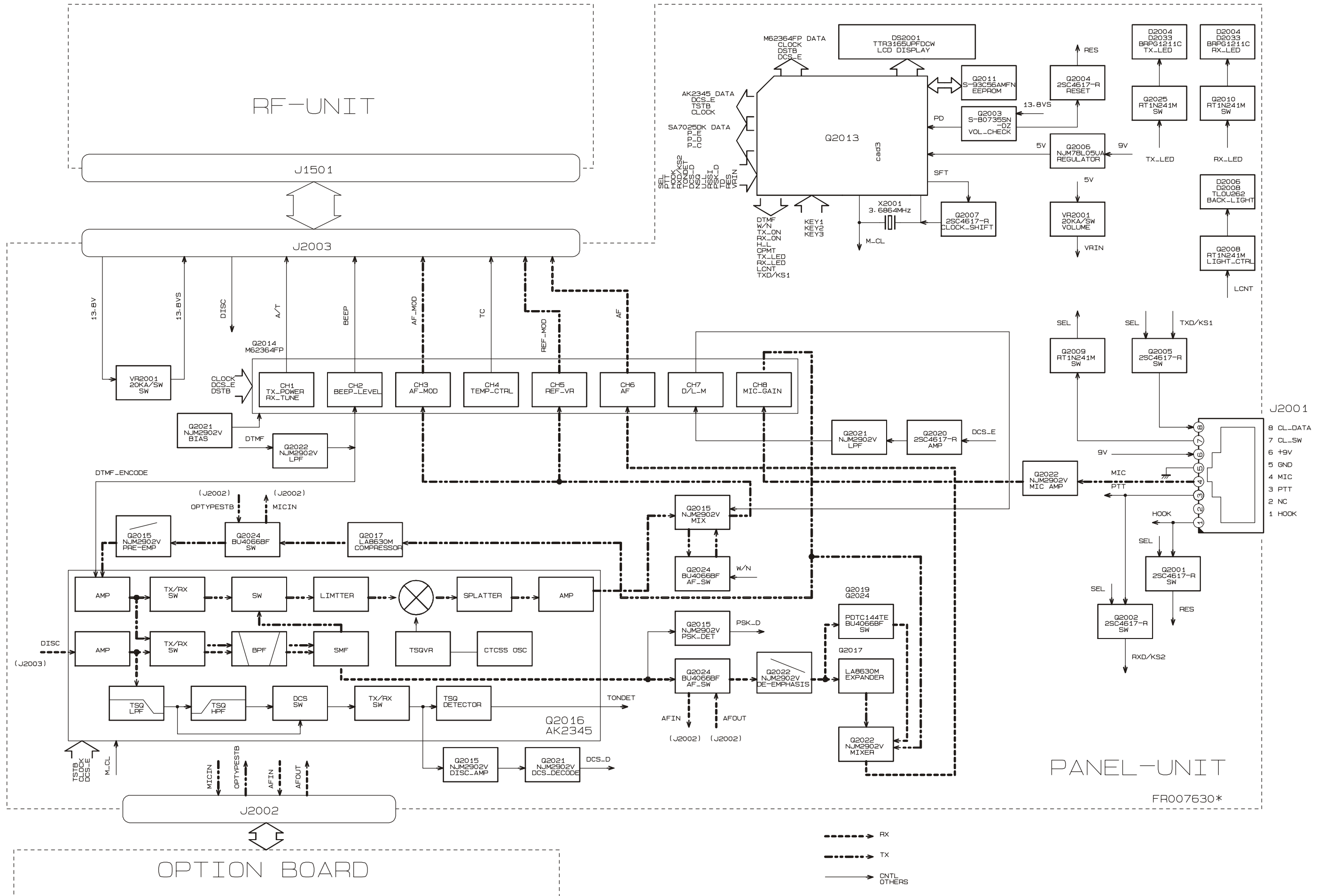

Interconnection Diagram

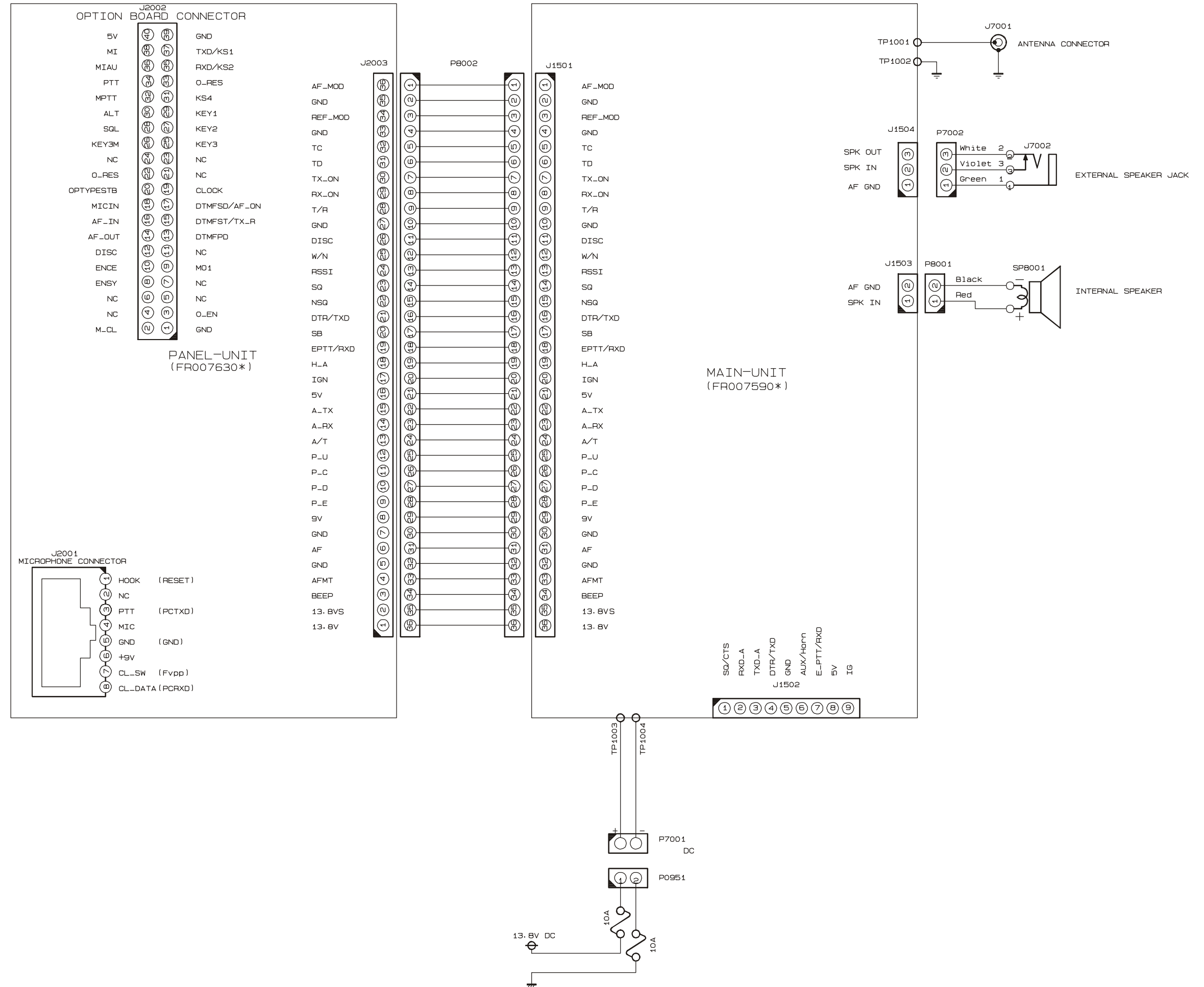

1. Overview

The **VX-2500V** is a VHF FM mobile transceiver designed to operate in the frequency range of 134 to 174MHz.

2. Circuit Configuration by Frequency

The receiver is a double-conversion superheterodyne with a first intermediate frequency (IF) of 44.25MHz and a second IF of 450kHz. Incoming signals from the antenna are mixed with the local signal from PLL to produce the first IF of 44.25MHz.

This is then mixed with the 43.8MHz second local oscillator (using the 14.6MHz reference crystal) output to produce the 450kHz second IF. This is detected to give the demodulated signal.

The transmit signal frequency is generated by PLL VCO, and modulated by the signal from the microphone. It is then amplified and sent to the antenna.

3. Receive Signal Path

Incoming RF signals from the antenna connector are delivered to the RF Unit, and pass through a low-pass filter (LPF) antenna switching network consisting of coils L1001, L1002, L1003, L1005, and L1007, capacitors C1004, C1009, C1016, C1019, and C1025, and antenna switching diodes **D1005** and **D1007** (both **UM9957F**) for delivery to the receiver front end.

Signals within the frequency range of the transceiver are then passed through a varactor-tuned bandpass filter consisting of L1008, L1009 before RF amplification by **Q1011 (2SC4226)**.

The amplified RF is then band-pass filtered again by varactor-tuned resonators L1019, L1023 to ensure pure in-band input to 1st mixer **Q1026 (3SK228)**.

Buffered output from the VCO Unit is amplified by **Q1021 (2SC5107)** and low-pass filtered by L1030/L1032 and C1184/C1188/C1192, to provide a pure 1st local signal between 178.25 and 218.25MHz to the 1st mixer.

The 44.25MHz 1st mixer product then passes through dual monolithic crystal filters XF1001 and XF1002, and is amplified by **Q1029 (2SC4215Y)** and delivered to the input of the FM IF subsystem IC **Q1028 (TA31136FN)**.

This IC contains the 2nd mixer, 2nd local oscillator, limiter amplifier, FM detector, noise amplifier, and squelch gates.

The 2nd LO in the IF-IC is produced from crystal X1001 (14.600MHz), and the 1st IF is converted to 450kHz by the 2nd mixer and stripped of unwanted components by ceramic filter CF1001 or CF1002. After passing through a limiter amplifier, the signal is demodulated by the FM detector **CD1001 (CDBC450CX24)**.

Detected audio from **Q1029** is applied to **Q2016 (AK2345)**

and audio low-pass filter. After volume adjustment by **Q2014 (M62364FP)**, the audio signal is amplified by the AF power amplifier **Q1509 (TDA2003H)** and passed to speaker jack.

4. Transmit Signal Path

Voice audio from the microphone is delivered via the **MIC** (Jack) Unit to the **PANEL** Unit, after passing through amplifier **Q2022 (NJM2902V)**, Mic gain-volume **Q2014 (M62364FP)** pre-emphasis **Q2015 (NJM2902V)**, and limiter **Q2016** (IDC instantaneous deviation control), is adjusted for optimum deviation level and delivered to the next stage.

Voice input from the microphone and CTCSS are FM-modulated to the VCO of the synthesizer, while DCS audio is modulated by the reference frequency oscillator of the synthesizer.

Synthesizer output, after passing through diode switch **D1022 (1SS321)**, is amplified by driver **Q1022 (2SC5415E)**, **Q1025 (2SC5107)** and power module **Q1014 (RA30H1317M)** to obtain full RF output. The RF energy then passes through antenna switch **D1005/D1007** and a low-pass filter circuit and finally to the antenna connector.

RF output power from the final amplifier is sampled by CM coupler and is rectified by **D1011, D1012** (both **HSM88AS**). The resulting DC is fed through Automatic Power Controller **Q1003 (M5223AGP)**, **Q1002 (2SC4154E)**, **Q1032 (2SC4254E)**, and TH1003 to transmitter RF amplifier and thus the power output.

Generation of spurious products by the transmitter is minimized by the fundamental carrier frequency being equal to the final transmitting frequency, modulated directly in the transmit VCO. Additional harmonic suppression is provided by a low-pass filter consisting of L1002, L1003, L1005, C1004, C1009, C1016, C1019, and C1025, resulting in more than 60dB of harmonic suppression prior to delivery to the RF energy to the antenna.

5. PLL Frequency Synthesizer

PLL frequency synthesizer consists of the VCO **Q1013 (2SK508-K52: RX)** and **Q1015 (2SC4226-R24: TX)**, VCO buffers **Q1018, Q1020, Q1021** (all **2SC5107-0**), PLL subsystem IC **Q1023 (SA7025DK)** and 14.6MHz reference crystal X1001.

The frequency stability is ± 2.5 ppm within temperature range of -30 to $+60$ degree. The output of the 14.6MHz reference is applied to pin 8 of the PLL IC.

While receiving, VCO **Q1013** oscillates between 178.25 and 218.25MHz according to the transceiver version and the programmed receiving frequency. The VCO generates 355.75 to 467.75MHz for providing to the first local signal. In TX, the VCO generates 134 to 174MHz.

Circuit Description

The output of the VCO is amplified by the **Q1020** and routed to the pin 5 of the PLL IC. Also the output of the VCO is amplified by the **Q1021** and routed first local/Power Module according to **D1022**.

The PLL IC consists of a prescaler, fractional divider, reference divider and phase comparator and charge pump. This PLL IC is fractional-N type synthesizer and performs in the 40 or 50 kHz reference signal, which is eighth of the channel step (5 or 6.25 kHz). The input signal from pin 5 and 8 of the PLL IC is divided down to the 20 kHz and compared at phase comparator. The pulsed output signal of the phase comparator is applied to the charge pump and transformed into DC signal in the loop filter. The DC signal is applied to the VCO and locked to keep the VCO frequency constant.

PLL data is output from "DCS_E" (pin100), "CLOCK" (pin2) and "PLL_E" (pin98) of the microprocessor **Q2013**. The data are input to PLL IC when the channel is changed or when transmission is changed to reception and vice versa. A PLL lock condition is always monitored by the pin20 of the **Q2013**. When the PLL is unlocked, the UL goes low.

6. Miscellaneous Circuits

6-1 DCS/LTR Demodulator

DCS signals are demodulated on the PANEL-UNIT, It is demodulated by **Q2116 (AK2345)**, amplifier **Q2015**, and comparator **Q2021**.

6-2 CTCSS encoder/decoder

The CTCSS code is generation and encoding by CTCSS encoder/decoder IC **Q2016 (AK2345)**.

6-3 MPU

Operation is controlled by 8-bit MPU IC **Q2013 (LC87F72C8A)**. The system clock uses a 3.6864MHz crystal for a time base. IC **Q2003 (S-80735SN)** resets the MPU when the power is on, and monitors the voltage of the regulated 5V power supply line.

6-4 DCS/LTR Encoder

The DCS code is generation and encoding by MPU IC **Q2013 (LC87F72C8A)**. It is filtered by **Q2021 (NJM2902V)** and adjusted the level by **Q2014 (M62364FP)**.

6-5 Compandor

The Compandor is active when Pin90 of **Q2013 (LC87F72C8A)** is "High". When the Compandor is active, MIC Audio is compressed, and detected audio is expanded by **Q2017 (LA8630M)**.

7. Power Supply Circuits

7-1 All 13.8V

13.8V is always supplied to Power AMP **Q1014 (RA30H4452M)**. Switched 13.8V is supplied to AF Power AMP **Q1509 (TDA2003H)** and 9V Regulator **Q1004 (MM1216EN)** and **Q1005 (2SB1201STP)**.

7-2 All 9V

9V regulated from 13.8V by **Q1004 (MM1216EN)** and **Q1005 (2SB1201STP)**.

7-3 VCO 9V

9V is filtered by Ripple Filter and is supplied to VCO Oscillator **Q1013 (2SK508-K52)**, **Q1015 (2SC5107-O)**, and VCO BUFFER AMP **Q1015 (2SC5107-O)**.

7-4 5V (RF-UNIT)

5V in RF-UNIT is regulated by REGULATOR IC **Q1024 (NJM78L05UA)**. 5V is supplied to PLL IC **Q1023 (SA7025DK)**, FM IC **Q1028 (TA31136FN)**, and Reference Oscillator **Q1027 (23C4116GR)**.

7-5 TX 9V

TX 9V is active on transmit. TX 9V is supplied to ANT SW **D1005**, **D1007 (UM9957F)** and TX DRIVER **Q1022 (2SC5415E)**, **Q1025 (2SC5107-O)**.

7-6 RX 9V

RX 9V is active on receive. RX 9V is supplied to RX RF AMP **Q1026 (3SK228)** and MIXER **Q1011 (2SC4227-R34)**.

7-7 5V (RF-UNIT)

9V from RF-UNIT is regulated to 5V by REGULATOR IC **Q2006 (NJM78L05UA)** in PANEL-UNIT.

Introduction

The **VX-2500V** is carefully aligned at the factory for the specified performance across the frequency range specified for each version. Realignment should therefore not be necessary except in the event of a component failure, or altering version type. All component replacement and service should be performed only by an authorized Vertex Standard representative, or the warranty policy may be void.

The following procedures cover the sometimes critical and tedious adjustments that are not normally required once the transceiver has left the factory. However, if damage occurs and some parts subsequently are placed, realignment may be required. If a sudden problem occurs during normal operation, it is likely due to component failure; realignment should not be done until after the faulty component has been replaced.

We recommend that servicing be performed only by authorized Vertex Standard service technicians who are experienced with the circuitry and fully equipped for repair and alignment. Therefore, if a fault is suspected, contact the dealer from whom the transceiver was purchased for instructions regarding repair. Authorized Vertex Standard service technicians realign all circuits and make complete performance checks to ensure compliance with factory specifications after replacing any faulty components.

Those who do undertake any of the following alignments are cautioned to proceed at their own risk. Problems caused by unauthorized attempts at realignment are not covered by the warranty policy. Also, Vertex Standard reserves the right to change circuits and alignment procedures in the interest of improved performance, without notifying owners.

Under no circumstances should any alignment be attempted unless the normal function and operation of the transceiver are clearly understood, the cause of the malfunction has been clearly pinpointed and any faulty components replaced, and realignment determined to be absolutely necessary.

The following test equipment (and thorough familiarity with its correct use) is necessary for complete realignment. Correction of problems caused by misalignment resulting from use of improper test equipment is not covered under the warranty policy. While most steps do not require all of the equipment listed, the interactions of some adjustments may require that more complex adjustments be performed afterwards.

Do not attempt to perform only a single step unless it is clearly isolated electrically from all other steps. Have all test equipment ready before beginning, and follow all of the steps in a section in the order presented.

Required Test Equipment

- RF Signal Generator with calibrated output level at 500MHz
- Deviation Meter (linear detector)
- In-line Wattmeter with 5% accuracy at 1000MHz
- 50Ω RF Dummy Load with power rating 100W at 500MHz
- 4Ω AF Dummy Load
- Regulated DC Power Supply (standard 13.8V DC, 15A)
- Frequency Counter with 0.1ppm accuracy at 500MHz
- AC Voltmeter
- DC Voltmeter
- VHF Sampling Coupler
- IBM PC/compatible Computer
- Oscilloscope
- Vertex Standard **VPL-1** Connection Cable & Alignment program

Alignment Preparation & Precautions

A 50Ω RF Dummy Load and in-line wattmeter must be connected to the main antenna jack in all procedures that call for transmission, except where specified otherwise. Correct alignment is not possible with an antenna.

After completing one step, read the following step to determine whether the same test equipment will be required. If not, remove the test equipment (except dummy load and wattmeter, in connected) before proceeding.

Correct alignment requires that the ambient temperature be the same as that of the transceiver and test equipment, and that this temperature be held constant between 68°F and 86°F (20°C ~ 30°C). When the transceiver is brought into the shop from hot or cold air, it should be allowed time to come to room temperature before alignment.

Whenever possible, alignments should be made with oscillator shields and circuit boards firmly affixed in place.

Also, the test equipment must be thoroughly warmed up before beginning.

Note: Signal levels in dB referred to in the alignment procedure are based on $0dBm$ $EMF = 0.5mV$.

Alignment

Setup the test equipment as shown below, apply 13.8V DC power to the transceiver.

The transceiver must be programmed for use in the intended system before alignment is attempted. The RF parameters are loaded from the file during the alignment process.

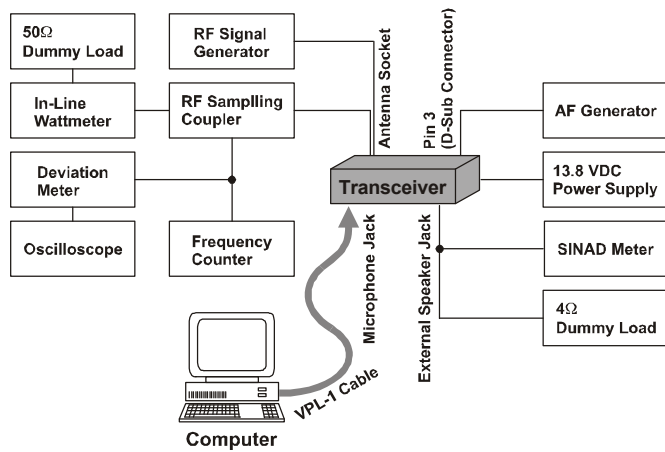

Important

In order to facilitate alignment over the complete switching range of the equipment it is recommended that the channel data in the transceiver is preset as the chart below.

CHANNEL	CHANNEL SPACE	FREQUENCY (SIMPLEX)	
		Version A	Ver. C
CH 1	Wide	147.100 MHz	161.100 MHz
CH 2	Narrow	147.100 MHz	161.100 MHz
CH 3	Wide	134.100 MHz	148.100 MHz
CH 4	Wide	159.900 MHz	173.900 MHz

The alignment mode is accessed by “Alignment mode” command from the computer whilst switching on. And it is operated by the alignment tool automatically.

During the alignment mode, normal operation is suspended. Use the alignment tool program running on PC.

PLL VCV

- Connect the positive lead of the DC voltmeter to the test point **TP1007** (VCV) on the RF-Unit, as indicated in the figure, and the negative lead to chassis ground.
- Set the transceiver to the high band edge frequency channel, then adjust coil **L1017** on the Unit for 7.25V on the voltmeter.
- Key the transmitter, and adjust coil **L1020** on the Unit for 7.25V on the voltmeter.
- Next select to the low edge frequency channel and confirm above 2.00V to 3.00V on the voltmeter.
- Key the transmitter, and confirm above 2.00V to 3.00V on the voltmeter.

PLL Reference Frequency

With the wattmeter, dummy load and frequency counter connected to the antenna jack, and select band center frequency channel, key the transmitter and adjust **VR1001** on the RF-Unit, if necessary, so the counter frequency is within 100 Hz of the channel center frequency for the transceiver version.

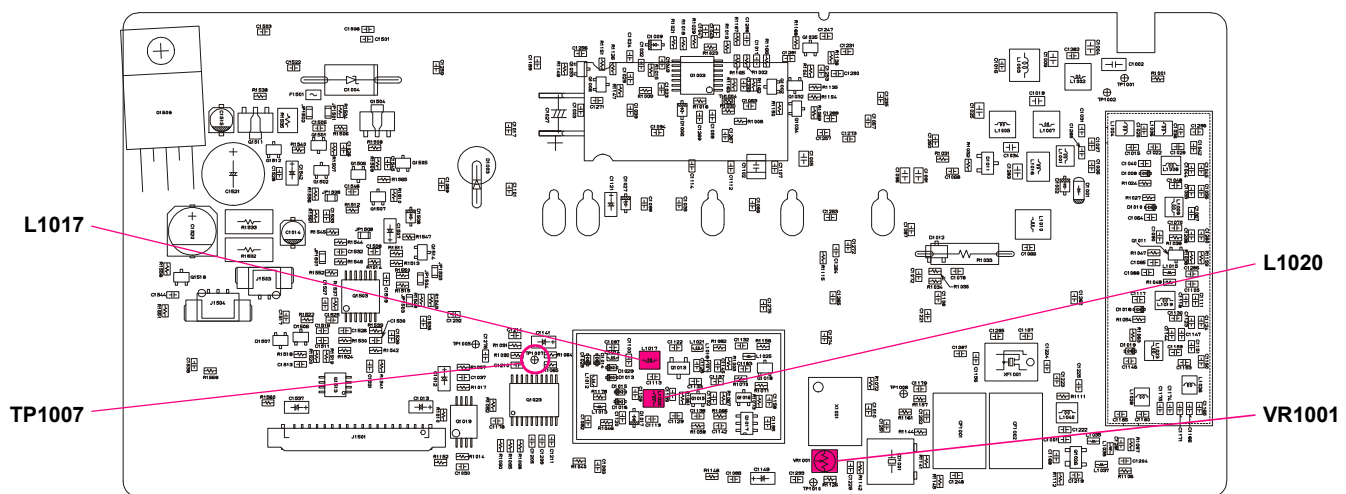

RF Unit Test & Alignment Points

The alignment tool outline

Installation the tool

This alignment tool consists, MS-DOS based, only one execute file "svc47.exe." You make a directly as you think fit, and copy this file. That is all of the installation process.

Boot the tool

Change directly and input in command line, "svc47 [enter]," and boot the alignment tool.

Preparation

Setup the test equipment as "Alignment Preparation & Precautions."

Set the RF Ch. List to Table 1 on the CE47 Clone editor software.

Enter to the alignment mode

To enter the alignment mode, press "[0] Alignment Mode" on the personal computer Key board. You turn off the power of the transceiver, and turn on the transceiver. If entry succeed, the alignment tool display as follows.

[0]Common TX

[1]Common RX

Action of the switches

When the transceiver is in alignment mode, the action of [PTT], [MON], [UP], and [DOWN] is ignored. All of the action is remote controlled by PC.

Menu of the tool

[0] Common TX

- [0] Tx Power High

This parameter is used to align TX High power (25W).

- Press [Enter] on "[0] Tx Power High" to align TX High power.
- Select the Channel "1" in alignment range.
- Press the [Space] key on the keyboard to activate the transmitter.
- Press the [UP] or [DWN] key, as needed, to set the power output to the following specification, as indicated on the external wattmeter.
Tx Power High: 25 W ($\pm 0.5W$)
- When the 25 Watt level is attained, press [Enter] to lock in the new data.

- [1] Tx Power Low

This parameter is used to align TX Low power (5W).

- Press [Enter] on "[1] Tx Power Low" to align TX Low power.
- Select the Channel "1" in alignment range.
- Press the [Space] key on the keyboard to activate the transmitter.
- Press the [UP] or [DWN] key, as needed, to set the power output to the following specification, as indicated on the external wattmeter.
Tx Power Low: 5 W ($\pm 0.1W$)
- When the 5 Watt level is attained, press [Enter] to lock in the new data.

- [2] VCO Deviation

This parameter is used to align the VCO Deviation.

- Press [Enter] on "[2] VCO Deviation" to align VCO Deviation.
- Select the Channel "1" in alignment range.
- Adjust the AF generator output level to 38mVrms ($-26dBm$) at 2 kHz to the pin 3 of the J1502 (D-sub 9pin).
- Press the [Space] key on the keyboard to activate the transmitter.
- Press the [UP] or [DWN] key, as needed, to set the VCO Deviation (Wide) to the following specification, as indicated on the deviation meter.
- When the desired deviation level is attained, press [Enter] to lock in the new data.
- Select the Channel 2, and set the VCO Deviation (Narrow), same as Channel "1."
VCO Deviation (Wide): 3.0 kHz (± 0.1 kHz)
VCO Deviation (Narrow): 1.5 kHz (± 0.1 kHz)

Alignment

- [3] REF Deviation

This parameter is used to align the REF Deviation.

- Press **[Enter]** on “[3] REF Deviation” to align REF Deviation.
- Select the Channel “1” in alignment range.
- Adjust the AF generator output level to 776mVrms(0dBm) at 300Hz to the pin 3 of the J1502.
- Press the **[Space]** key on the keyboard to activate the transmitter.
- Press the **[UP]** or **[DWN]** key, as needed, to set the modulation wave as follows.
- Press **[Enter]** to lock in the new data.
- Select the Channel “2,” and set the modulation wave, same as Channel “1.”

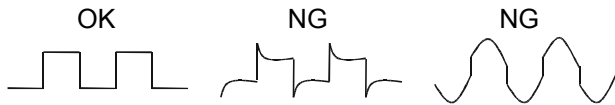

- [4] CTCSS Deviation

This parameter is used to align the CTCSS deviation.

- Press **[Enter]** on “[4] CTCSS Deviation” to align CTCSS Deviation.
- Select the Channel “1” in alignment range.
- Press the **[Space]** on the keyboard to activate the transmitter, and injects a CTCSS test tone.
- Press the **[UP]**/**[DWN]** key, as need, to set the CTCSS Deviation (Wide) to the following specification.
- Press **[Enter]** to lock in the new data.
- Select the Channel “2,” and set the CTCSS Deviation (Narrow), same as Channel “1.”
 - CTCSS Deviation (Wide): 0.70 kHz (± 0.1 kHz)
 - CTCSS Deviation (Narrow): 0.35 kHz (± 0.1 kHz)

- [5] DCS Deviation

This parameter is used to align the DCS deviation.

- Press **[Enter]** on “[5] DCS Deviation” to align DCS Deviation.
- Select the Channel “1” in alignment range.
- Press the **[Space]** key on the keyboard to activate the transmitter, and injects a DCS test tone.
- Press the **[UP]** or **[DWN]** key, as needed, to set the DCS deviation (Wide) to the following specification.
- Press **[Enter]** to lock in the new data.
- Select the Channel “2,” and set the DCS deviation (Narrow), same as Channel “1.”
 - DCS Deviation (Wide): 0.60 kHz (± 0.1 kHz)
 - DCS Deviation (Narrow): 0.30 kHz (± 0.1 kHz)
- The actual DCS deviation will increase around 20% based on the above alignment as follows,
 - Actual DCS Deviation (Wide): 0.70 kHz
 - Actual DCS Deviation (Narrow): 0.35 kHz

- [6] LTR Deviation

This parameter is used to align the LTR deviation.

- Press **[Enter]** on “[6] LTR Deviation” to align LTR Deviation.
- Select the Channel “1” in alignment range.
- Press the **[Space]** key on the keyboard to activate the transmitter, and injects a LTR test tone.
- Press the **[UP]** or **[DWN]** key, as needed, to set the LTR Deviation (Wide) to the following specification.
- Press **[Enter]** to lock in the new data.
- Select the Channel “2,” and set the LTR deviation (Narrow), same as Channel “1.”
 - LTR Deviation (Wide): 0.80 kHz (± 0.1 kHz)
 - LTR Deviation (Narrow): 0.60 kHz (± 0.1 kHz)
- The actual LTR deviation will increase around 20% based on the above alignment as follows,
 - Actual LTR Deviation (Wide): 1.00 kHz
 - Actual LTR Deviation (Narrow): 0.70 kHz

[1] Common RX

- [0] Tight NSQL

This parameter is used to align the noise level in squelch Tight. It adjusts this alignment RX Tuning after ending.

- Select the MID frequency channel in alignment range.
- Set the SG output level to 0dBm EMF, and obey the message.

- [1] Threshold NSQL

This parameter is used to align the noise level in squelch Threshold. It adjusts this alignment RX Tuning after ending.

- Select the MID frequency channel in alignment range.
- Set the SG output level to -7dBm EMF, and obey the message.

- [2] RX Tune

This parameter is used to align RX Tune.

- Select the MID frequency channel in alignment range.
- Set the SG output level to -6dBm EMF.
- Pressing the [DWN] key, reduce the RX Tune Level and set the SINAD above 12dB.

RF Unit Jumper Information

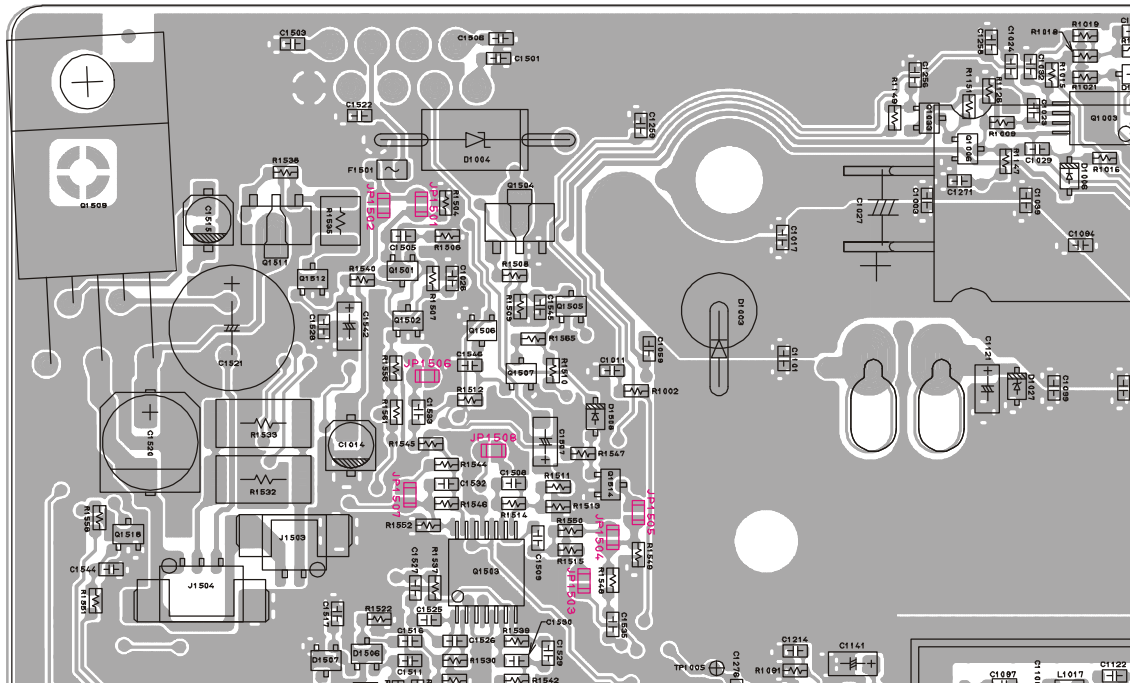

- JP1501 (JP1):** Determine the output supply voltage at pin 8 of DSUB 9-pin Accessory Connector.
Close: +5.0 V (Maximum 100 mA)
Open: No Action
- JP1502 (JP2):** Determine the output supply voltage at pin 8 of DSUB 9-pin Accessory Connector.
Close: +13.8 V (Maximum 100 mA)
Open: No Action
- JP1503 (JP3):** Determine the Rx discriminator output characteristic at pin 2 of DSUB 9-pin Accessory Connector.
Close: Flat 10 Hz to 3.0 kHz (140 mVrms /STD deviation with 600 ohm termination)
Open: No Action
- JP1504 (JP4):** Determine the Rx discriminator output characteristic at pin 2 of DSUB 9-pin Accessory Connector.
Close: Filtered 300 Hz to 3.0 kHz (70 mVrms /STD deviation with 600 ohm termination)
Open: No Action
- JP1505 (JP5):** No Action (Spare Jumper).
- JP1506 (JP6):** Define whether the TX Data Input at pin 3 of DSUB 9-pin Accessory Connector shall be "on" or "off" according to the external PTT Input signal signal (pin 7 of DSUB 9-pin Accessory Connector).
Close: on (Enabled)
Open: off (Disabled)
- JP1507 (JP7):** Determine the TX Data Input level at pin 3 of DSUB 9-pin Accessory Connector.
Close: 400 mVrms /STD deviation with 600 ohm termination
Open: 40 mVrms /STD deviation with 600 ohm termination
- JP1508 (JP8):** Define whether the Transceiver's power shall be "on" or "off" according to the Ignition Signal Input (pin 9 of DSUB 9-pin Accessory Connector).
Close: Turn the transceiver on when the Ignition Signal Input (pin 9 of DSUB 9-pin Accessory Connector) is turned to "High" while the VOL/PWR knob is set to the "ON" position (out of the click-stop position).
Open: No Action

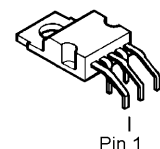
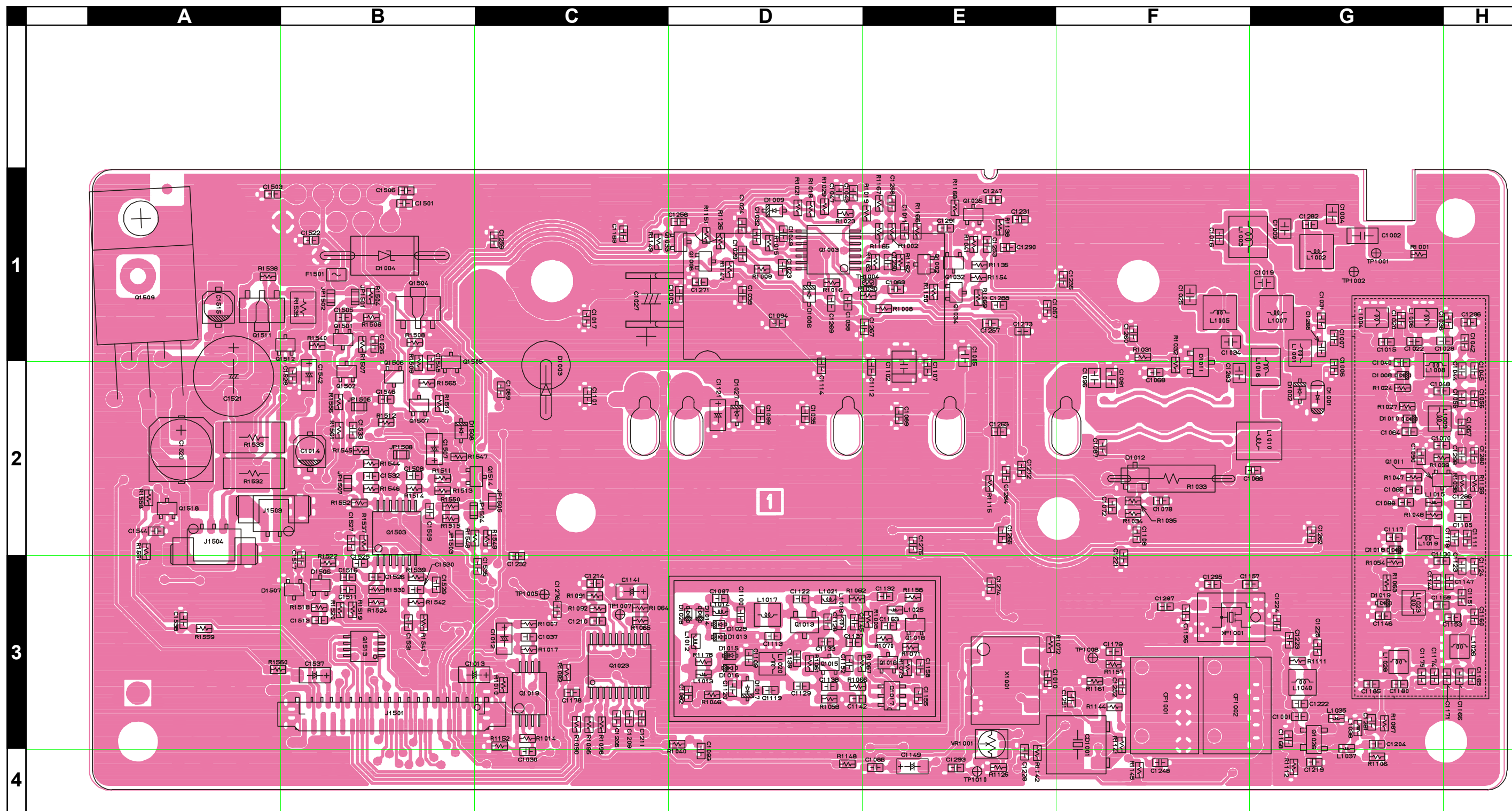

TDA2003H
(Q1509)

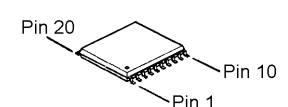

SA7025DK
(Q1023)

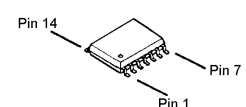

NJM2902V
(Q1003, 1503)

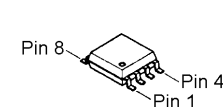

M5223
(Q1019)

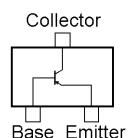

2SA1602A (MF)
(Q1505)

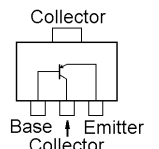

2SB1301 (ZQ)
(Q1511)
2SD1368CB (CB)
(Q1504)

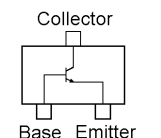

2SC4154 (LE)
(Q1501)
2SC4226 (R22)
(Q1011, 1015)
2SC5107 (MF0)
(Q1518)

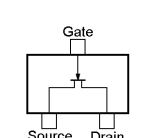

2SK508 (K52)
(Q1013)

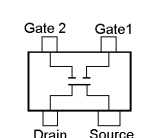

3SK228 (XR)
(Q1026)

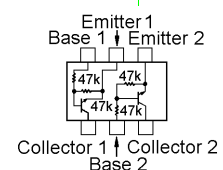

IMH6A (H6)
(Q1017)

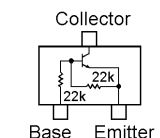

RT1N241M (N2)
(Q1002, 1006,
1034, 1035, 1502,
1506, 1507, 1512,
1518)

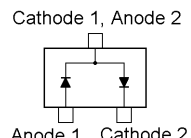

HSM88AS (C1)
(D1011, 1012)
MC2850 (A7)
(D1506, 1507)

RF Unit

Parts Layout (Side B)

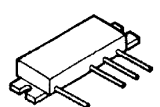
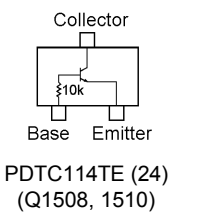
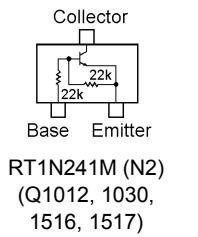
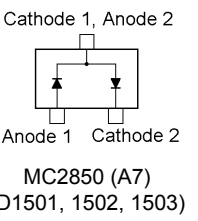
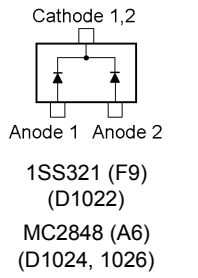
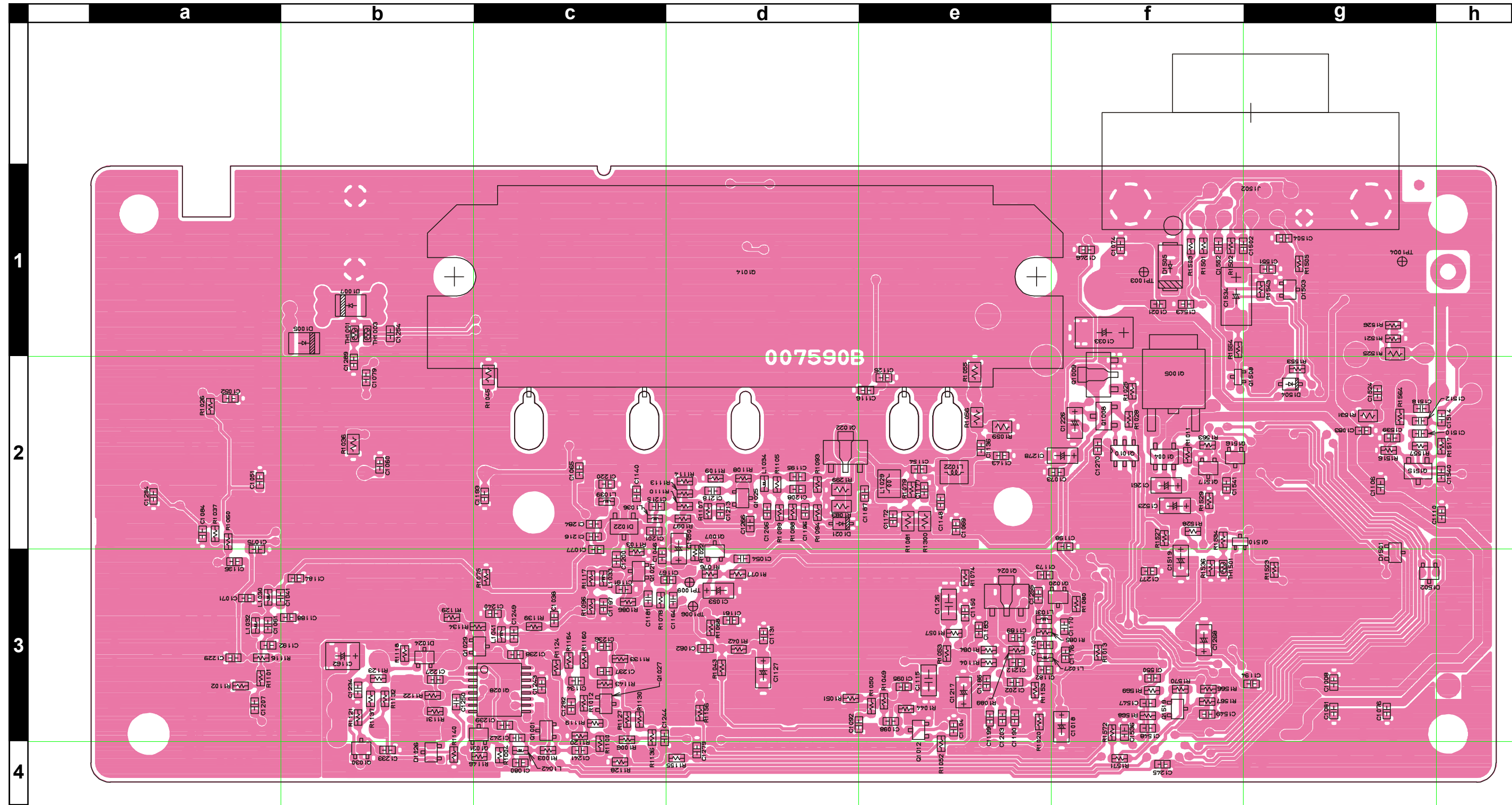

RA30H1317M
(Q1014)

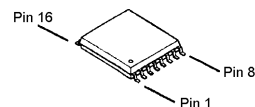

TA31136FN
(Q1028)

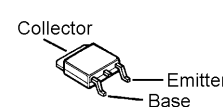

2SB1201S
(Q1005)

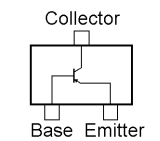

2SA1602A (MF)
(Q1031)

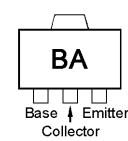

2SB1132 (BA)
(Q1009)

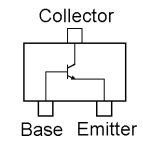

2SC4116 (LG)
(Q1001)

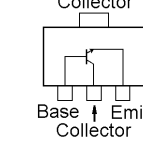

2SC5415E (EA)
(Q1022)
2SC4154 (LE)
(Q1007, 1519)
2SC4215Y (QY)
(Q1029)
2SC5107 (MFO)
(Q1020, 1021, 1025)

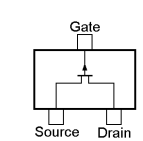

2SJ125D (JD)
(Q1515)

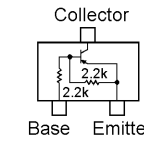

DTB123EK (F12)
(Q1008)

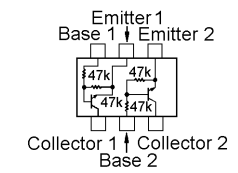

IMH6A (H6)
(Q1010)

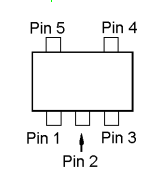

MM1216ENRE
(Q1004)

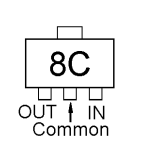

NJM78L05
(Q1024)

REF	DESCRIPTION	VALUE	V/W	TOL.	MFR'S DESIG	VXSTD P/N	VERS.	LOT	SIDE	LAY ADR
PCB with Component						CB1724001				
Printed Circuit Board						FR0075900				
AC031N000						1-				
C 1001	CHIP CAP.	470pF	50V	CH	GRM39CH471J50PT	K22174249		1-	A	G3
C 1002	CHIP CAP.	0.001uF	630V	R	GHM1030R102K630PT	K22281801		1-	A	G1
C 1003	CHIP CAP.	220pF	50V	CH	GRM39CH221J50PT	K22174243		1-	A	D1
C 1004	CHIP CAP.	15pF	200V	CH	GRM40CH150J200PT	K22230218		1-	A	G1
C 1005	CHIP CAP.	0.1uF	25V	B	GRM40B104M25PT	K22140811		1-	A	E1
C 1006	CHIP CAP.	15pF	50V	CH	GRM39CH150J50PT	K22174215		1-	A	G2
C 1007	CHIP CAP.	15pF	50V	CH	GRM39CH150J50PT	K22174215		1-	A	G1
C 1008	CHIP CAP.	0.001uF	50V	B	GRM39B102K50PT	K22174821		1-	B	g3
C 1009	CHIP CAP.	27pF	200V	CH	GRM40CH270J200PT	K22230221		1-	A	G1
C 1011	CHIP CAP.	0.01uF	50V	B	GRM39B103M50PT	K22174823		1-	A	E1
C 1012	CHIP TA.CAP.	6.8uF	6.3V		TEMSVA0J685M-8R	K78080025		1-	A	C3
C 1013	CHIP TA.CAP.	6.8uF	6.3V		TEMSVA0J685M-8R	K78080025		1-	A	B3
C 1014	AL.ELECTRO.CAP.	10uF	16V		RV2-16V100MB55-R	K48120014		1-	A	B2
C 1015	CHIP CAP.	12pF	50V	CH	GRM39CH120J50PT	K22174213		1-	A	G1
C 1016	CHIP CAP.	9pF	50V	CH	GRM39CH090D50PT	K22174210		1-	A	F1
C 1017	CHIP CAP.	0.001uF	50V	B	GRM39B102K50PT	K22174821		1-	A	C1
C 1019	CHIP CAP.	33pF	200V	CH	GRM40CH330J200PT	K22230222		1-	A	G1
C 1020	CHIP CAP.	10pF	50V	CH	GRM39CH100D50PT	K22174211		1-	A	G1
C 1021	CHIP CAP.	100pF	50V	CH	GRM39CH101J50PT	K22174235		1-	B	f1
C 1022	CHIP CAP.	12pF	50V	CH	GRM39CH120J50PT	K22174213		1-	A	G1
C 1023	CHIP CAP.	0.047uF	16V	B	GRM39B473K16PT	K22124804		1-	A	D1
C 1025	CHIP CAP.	5pF	200V	CH	GRM40CH050C200PT	K22230207		1-	A	F1
C 1026	CHIP CAP.	0.001uF	50V	B	GRM39B102K50PT	K22174821		1-	A	B1
C 1027	AL.ELECTRO.CAP.	3300uF	16V		RE3-16V332M 3300UF	K40129065		1-	A	C1
C 1028	CHIP CAP.	15pF	50V	CH	GRM39CH150J50PT	K22174215		1-	A	G1
C 1029	CHIP CAP.	0.0022uF	50V	B	GRM39B222K50PT	K22174822		1-	A	D1
C 1030	CHIP CAP.	22pF	50V	CH	GRM39CH220J50PT	K22174219		1-	A	C4
C 1031	CHIP CAP.	33pF	50V	CH	GRM39CH330J50PT	K22174223		1-	A	G1
C 1032	CHIP CAP.	0.0047uF	50V	B	GRM39B472K50PT	K22174833		1-	A	D1
C 1033	CHIP TA.CAP.	47uF	16V		TEMSVC1C476M12R	K78120057		1-	B	f1
C 1034	CHIP CAP.	22pF	200V	CH	GRM40CH220J200PT	K22230220		1-	A	F1
C 1035	CHIP CAP.	0.001uF	50V	B	GRM39B102K50PT	K22174821		1-	A	D2
C 1036	CHIP CAP.	33pF	50V	CH	GRM39CH330J50PT	K22174223		1-	A	G1
C 1037	CHIP CAP.	47pF	50V	CH	GRM39CH470J50PT	K22174227		1-	A	C3
C 1038	CHIP CAP.	470pF	50V	CH	GRM39CH471J50PT	K22174249		1-	B	c3
C 1039	CHIP CAP.	0.001uF	50V	B	GRM39B102K50PT	K22174821		1-	A	D1
C 1040	CHIP CAP.	7pF	50V	CH	GRM39CH070D50PT	K22174208		1-	A	G1
C 1041	CHIP CAP.	2pF	50V	CK	GRM39CK020C50PT	K22174203		1-	B	b3
C 1042	CHIP CAP.	18pF	50V	CH	GRM39CH180J50PT	K22174217		1-	A	G1
C 1043	CHIP CAP.	0.001uF	50V	B	GRM39B102K50PT	K22174821		1-	A	D1
C 1044	CHIP CAP.	12pF	50V	CH	GRM39CH120J50PT	K22174213		1-	A	G2
C 1046	CHIP CAP.	0.001uF	50V	B	GRM39B102K50PT	K22174821		1-	B	c3
C 1047	CHIP CAP.	0.001uF	50V	B	GRM39B102K50PT	K22174821		1-	A	D1
C 1048	CHIP CAP.	47pF	50V	CH	GRM39CH470J50PT	K22174227		1-	A	G2
C 1049	CHIP CAP.	0.1uF	16V	B	GRM39B104K16PT	K22124805		1-	A	D1
C 1050	CHIP TA.CAP.	10uF	10V		TEMSVA1A106M-8R	K78100028		1-	B	d2
C 1051	CHIP CAP.	470pF	50V	CH	GRM39CH471J50PT	K22174249		1-	B	b2
C 1052	CHIP CAP.	0.001uF	50V	B	GRM39B102K50PT	K22174821		1-	B	b2
C 1053	CHIP TA.CAP.	10uF	10V		TEMSVA1A106M-8R	K78100028		1-	B	d3
C 1054	CHIP CAP.	0.001uF	50V	B	GRM39B102K50PT	K22174821		1-	B	d3
C 1055	CHIP CAP.	12pF	50V	CH	GRM39CH120J50PT	K22174213		1-	A	G2
C 1057	CHIP CAP.	0.01uF	50V	B	GRM39B103M50PT	K22174823		1-	A	E1
C 1058	CHIP CAP.	470pF	50V	CH	GRM39CH471J50PT	K22174249		1-	A	D1
C 1059	CHIP CAP.	0.01uF	50V	B	GRM39B103M50PT	K22174823		1-	A	C2
C 1060	CHIP CAP.	0.001uF	50V	B	GRM39B102K50PT	K22174821		1-	B	b2
C 1061	CHIP CAP.	0.5pF	50V	CK	GRM39CK0R5C50PT	K22174201		1-	B	b3
C 1062	CHIP CAP.	470pF	50V	CH	GRM39CH471J50PT	K22174249		1-	B	d3
C 1063	CHIP CAP.	470pF	50V	CH	GRM39CH471J50PT	K22174249		1-	A	E1
C 1064	CHIP CAP.	6pF	50V	CH	GRM39CH060D50PT	K22174207		1-	A	G2
C 1065	CHIP CAP.	0.01uF	50V	B	GRM39B103M50PT	K22174823		1-	B	c2
C 1066	CHIP CAP.	470pF	50V	CH	GRM39CH471J50PT	K22174249		1-	A	F2
C 1067	CHIP CAP.	15pF	50V	CH	GRM39CH150J50PT	K22174215		1-	A	G2
C 1068	CHIP CAP.	470pF	50V	CH	GRM39CH471J50PT	K22174249		1-	A	F2
C 1069	CHIP CAP.	470pF	50V	CH	GRM39CH471J50PT	K22174249		1-	B	e2
C 1070	CHIP CAP.	47pF	50V	CH	GRM39CH470J50PT	K22174227		1-	A	G2
C 1071	CHIP CAP.	470pF	50V	CH	GRM39CH471J50PT	K22174249		1-	B	b3
C 1072	CHIP CAP.	0.01uF	50V	B	GRM39B103M50PT	K22174823		1-	A	F2
C 1073	CHIP CAP.	0.001uF	50V	B	GRM39B102K50PT	K22174821		1-	A	f2
C 1074	CHIP CAP.	470pF	50V	CH	GRM39CH471J50PT	K22174249		1-	B	f1
C 1075	CHIP CAP.	470pF	50V	CH	GRM39CH471J50PT	K22174249		1-	B	b2
C 1076	CHIP CAP.	470pF	50V	CH	GRM39CH471J50PT	K22174249		1-	B	g3
C 1078	CHIP CAP.	470pF	50V	CH	GRM39CH471J50PT	K22174249		1-	A	F2
C 1079	CHIP CAP.	0.001uF	50V	B	GRM39B102K50PT	K22174821		1-	B	b2
C 1080	CHIP CAP.	0.001uF	50V	B	GRM39B102K50PT	K22174821		1-	B	c4

RF Unit

Parts List

REF	DESCRIPTION	VALUE	V/W	TOL.	MFR'S DESIG	VXSTD P/N	VERS.	LOT	SIDE	LAY ADR
C 1081	CHIP CAP.	470pF	50V	CH	GRM39CH471J50PT	K22174249		1-	B	g3
C 1082	CHIP CAP.	220pF	50V	CH	GRM39CH221J50PT	K22174243		1-	A	D3
C 1083	CHIP CAP.	470pF	50V	CH	GRM39CH471J50PT	K22174249		1-	B	g2
C 1084	CHIP CAP.	0.1uF	16V	B	GRM39B104K16PT	K22124805		1-	B	b2
C 1085	CHIP CAP.	0.001uF	50V	B	GRM39B102K50PT	K22174821		1-	A	G2
C 1087	CHIP CAP.	0.001uF	50V	B	GRM39B102K50PT	K22174821		1-	A	F2
C 1088	CHIP CAP.	0.01uF	50V	B	GRM39B103M50PT	K22174823		1-	A	G2
C 1090	CHIP CAP.	0.1uF	16V	B	GRM39B104K16PT	K22124805		1-	A	G2
C 1092	CHIP CAP.	0.001uF	50V	B	GRM39B102K50PT	K22174821		1-	B	e3
C 1093	CHIP CAP.	220pF	50V	CH	GRM39CH221J50PT	K22174243		1-	A	D4
C 1096	CHIP CAP.	220pF	200V	CH	GRM40CH221J200PT	K22230232		1-	A	F2
C 1097	CHIP CAP.	0.0022uF	50V	B	GRM39B222K50PT	K22174822		1-	A	D3
C 1098	CHIP CAP.	0.1uF	16V	B	GRM39B104K16PT	K22124805		1-	B	e3
C 1100	CHIP CAP.	7pF	50V	CH	GRM39CH070D50PT	K22174208		1-	A	D3
C 1101	CHIP CAP.	0.001uF	50V	B	GRM39B102K50PT	K22174821		1-	A	C2
C 1102	CHIP CAP.	1uF	50V	B	GRM42-2B105K50PT	K22175801		1-	A	E2
C 1103	CHIP CAP.	3pF	50V	CJ	GRM39CJ030C50PT	K22174204		1-	B	e3
C 1104	CHIP CAP.	0.001uF	50V	B	GRM39B102K50PT	K22174821		1-	B	e3
C 1105	CHIP CAP.	47pF	50V	CH	GRM39CH470J50PT	K22174227		1-	A	G2
C 1107	CHIP CAP.	0.001uF	50V	B	GRM39B102K50PT	K22174821		1-	A	E2
C 1108	CHIP CAP.	470pF	50V	CH	GRM39CH471J50PT	K22174249		1-	A	F2
C 1109	CHIP CAP.	1pF	50V	CK	GRM39CK010C50PT	K22174202		1-	A	D3
C 1111	CHIP CAP.	47pF	50V	CH	GRM39CH470J50PT	K22174227		1-	A	G2
C 1112	CHIP CAP.	0.001uF	50V	B	GRM39B102K50PT	K22174821		1-	A	E2
C 1113	CHIP CAP.	18pF	50V	CH	GRM39CH180J50PT	K22174217		1-	A	D3
C 1114	CHIP CAP.	470pF	50V	CH	GRM39CH471J50PT	K22174249		1-	A	D2
C 1115	FILM CAP.	0.022uF	16V		ECHU1C223JB5	K57120011		1-	B	e3
C 1116	CHIP CAP.	0.001uF	50V	B	GRM39B102K50PT	K22174821		1-	B	e2
C 1117	CHIP CAP.	7pF	50V	CH	GRM39CH070D50PT	K22174208		1-	A	G2
C 1118	CHIP CAP.	18pF	50V	CH	GRM39CH180J50PT	K22174217		1-	A	G2
C 1119	CHIP CAP.	1pF	50V	CK	GRM39CK010C50PT	K22174202		1-	A	D3
C 1120	CHIP CAP.	2pF	50V	CK	GRM39CK020C50PT	K22174203		1-	A	D3
C 1121	CHIP TA.CAP.	0.1uF	35V		TESVA1V104M1-8R	K78160025		1-	A	D2
C 1122	CHIP CAP.	22pF	50V	CH	GRM39CH220J50PT	K22174219		1-	A	D3
C 1123	CHIP CAP.	12pF	50V	CH	GRM39CH120J50PT	K22174213		1-	A	G3
C 1125	CHIP CAP.	0.001uF	50V	B	GRM39B102K50PT	K22174821		1-	B	e2
C 1126	FILM CAP.	0.022uF	16V		ECHU1C223JB5	K57120011		1-	B	e3
C 1127	CHIP TA.CAP.	4.7uF	10V		TEMSVA1A475M-8R	K78100022		1-	B	d3
C 1128	CHIP CAP.	22pF	50V	CH	GRM39CH220J50PT	K22174219		1-	A	D3
C 1129	CHIP CAP.	15pF	50V	CH	GRM39CH150J50PT	K22174215		1-	A	D3
C 1130	CHIP CAP.	47pF	50V	CH	GRM39CH470J50PT	K22174227		1-	A	G3
C 1131	CHIP CAP.	220pF	50V	CH	GRM39CH221J50PT	K22174243		1-	B	d3
C 1132	CHIP CAP.	0.01uF	50V	B	GRM39B103M50PT	K22174823		1-	A	E3
C 1133	CHIP CAP.	0.001uF	50V	B	GRM39B102K50PT	K22174821		1-	A	D3
C 1134	CHIP CAP.	22pF	50V	CH	GRM39CH220J50PT	K22174219		1-	B	c3
C 1135	CHIP CAP.	0.001uF	50V	B	GRM39B102K50PT	K22174821		1-	B	b3
C 1136	CHIP CAP.	15pF	50V	CH	GRM39CH150J50PT	K22174215		1-	B	e2
C 1137	CHIP CAP.	0.001uF	50V	B	GRM39B102K50PT	K22174821		1-	A	D3
C 1138	CHIP CAP.	39pF	50V	CH	GRM39CH390J50PT	K22174225		1-	A	D3
C 1139	CHIP CAP.	39pF	50V	CH	GRM39CH390J50PT	K22174225		1-	A	D3
C 1140	CHIP CAP.	8pF	50V	CH	GRM39CH080D50PT	K22174209		1-	B	c2
C 1141	CHIP TA.CAP.	1uF	16V		TESVA1C105M1-8R	K78120009		1-	A	C3
C 1142	CHIP CAP.	0.001uF	50V	B	GRM39B102K50PT	K22174821		1-	A	D3
C 1143	CHIP CAP.	10pF	50V	CH	GRM39CH100D50PT	K22174211		1-	B	e2
C 1145	CHIP CAP.	1pF	50V	CK	GRM39CK010C50PT	K22174202		1-	A	D3
C 1146	CHIP CAP.	7pF	50V	CH	GRM39CH070D50PT	K22174208		1-	A	G3
C 1147	CHIP CAP.	12pF	50V	CH	GRM39CH120J50PT	K22174213		1-	A	G3
C 1148	CHIP CAP.	10pF	50V	CH	GRM39CH100D50PT	K22174211		1-	B	e2
C 1149	CHIP TA.CAP.	2.2uF	6.3V		TESVA0J225M1-8R	K78080009		1-	A	E4
C 1150	CHIP CAP.	0.01uF	50V	B	GRM39B103M50PT	K22174823		1-	B	e3
C 1151	CHIP CAP.	18pF	50V	CH	GRM39CH180J50PT	K22174217		1-	A	G3
C 1152	CHIP CAP.	2pF	50V	CK	GRM39CK020C50PT	K22174203		1-	A	D3
C 1153	CHIP CAP.	15pF	50V	CH	GRM39CH150J50PT	K22174215		1-	A	G3
C 1154	CHIP CAP.	15pF	50V	CH	GRM39CH150J50PT	K22174215		1-	B	e2
C 1155	CHIP CAP.	0.1uF	16V	B	GRM39B104K16PT	K22124805		1-	A	E3
C 1157	CHIP CAP.	10pF	50V	CH	GRM39CH100D50PT	K22174211		1-	A	F3
C 1158	CHIP CAP.	0.01uF	50V	B	GRM39B103M50PT	K22174823		1-	A	E3
C 1159	CHIP CAP.	22pF	50V	CH	GRM39CH220J50PT	K22174219		1-	A	G3
C 1160	CHIP CAP.	15pF	50V	CH	GRM39CH150J50PT	K22174215		1-	A	G3
C 1161	CHIP CAP.	0.001uF	50V	B	GRM39B102K50PT	K22174821		1-	B	d3
C 1162	CHIP TA.CAP.	33uF	10V		TEMSVB21A336M-8R	K78100047		1-	B	b3
C 1163	CHIP CAP.	220pF	50V	CH	GRM39CH221J50PT	K22174243		1-	A	E3
C 1164	CHIP CAP.	22pF	50V	CH	GRM39CH220J50PT	K22174219		1-	B	d3
C 1165	CHIP CAP.	1pF	50V	CK	GRM39CK010C50PT	K22174202		1-	A	G3
C 1166	CHIP CAP.	12pF	50V	CH	GRM39CH120J50PT	K22174213		1-	A	G3
C 1167	CHIP CAP.	18pF	50V	CH	GRM39CH180J50PT	K22174217		1-	B	d3

REF	DESCRIPTION	VALUE	V/W	TOL.	MFR'S DESIG	VXSTD P/N	VERS.	LOT	SIDE	LAY ADR
C 1168	CHIP CAP.	470pF	50V	CH	GRM39CH471J50PT	K22174249		1-	A	G3
C 1169	CHIP CAP.	0.01uF	50V	B	GRM39B103M50PT	K22174823		1-	A	C1
C 1170	CHIP CAP.	22pF	50V	CH	GRM39CH220J50PT	K22174219		1-	B	f3
C 1171	CHIP CAP.	10pF	50V	CH	GRM39CH100D50PT	K22174211		1-	A	G3
C 1172	CHIP CAP.	0.1uF	16V	B	GRM39B104K16PT	K22124805		1-	B	e2
C 1173	CHIP CAP.	15pF	50V	CH	GRM39CH150J50PT	K22174215		1-	B	e3
C 1174	CHIP CAP.	1pF	50V	CK	GRM39CK010C50PT	K22174202		1-	A	G3
C 1175	CHIP CAP.	12pF	50V	CH	GRM39CH120J50PT	K22174213		1-	A	G3
C 1176	CHIP CAP.	12pF	50V	CH	GRM39CH120J50PT	K22174213		1-	B	f3
C 1177	CHIP CAP.	0.01uF	50V	B	GRM39B103M50PT	K22174823		1-	B	e2
C 1178	CHIP CAP.	0.001uF	50V	B	GRM39B102K50PT	K22174821		1-	A	C3
C 1179	CHIP CAP.	0.01uF	50V	B	GRM39B103M50PT	K22174823		1-	A	F3
C 1180	CHIP CAP.	15pF	50V	CH	GRM39CH150J50PT	K22174215		1-	A	G3
C 1181	CHIP CAP.	47pF	50V	CH	GRM39CH470J50PT	K22174227		1-	B	c3
C 1182	CHIP CAP.	12pF	50V	CH	GRM39CH120J50PT	K22174213		1-	B	e3
C 1183	CHIP CAP.	0.1uF	16V	B	GRM39B104K16PT	K22124805		1-	B	e3
C 1184	CHIP CAP.	4pF	50V	CH	GRM39CH040C50PT	K22174205		1-	B	b3
C 1185	CHIP CAP.	15pF	50V	CH	GRM39CH150J50PT	K22174215		1-	A	G3
C 1186	CHIP CAP.	220pF	50V	CH	GRM39CH221J50PT	K22174243		1-	B	e3
C 1187	CHIP CAP.	0.001uF	50V	B	GRM39B102K50PT	K22174821		1-	B	e2
C 1188	CHIP CAP.	12pF	50V	CH	GRM39CH120J50PT	K22174213		1-	B	b3
C 1189	CHIP CAP.	220pF	50V	CH	GRM39CH221J50PT	K22174243		1-	B	e3
C 1190	CHIP CAP.	100pF	50V	CH	GRM39CH101J50PT	K22174235		1-	B	e3
C 1191	CHIP CAP.	0.01uF	50V	B	GRM39B103M50PT	K22174823		1-	B	c3
C 1192	CHIP CAP.	6pF	50V	CH	GRM39CH060D50PT	K22174207		1-	B	b3
C 1193	CHIP CAP.	0.01uF	50V	B	GRM39B103M50PT	K22174823		1-	B	c2
C 1194	CHIP CAP.	220pF	50V	CH	GRM39CH221J50PT	K22174243		1-	B	g3
C 1195	CHIP CAP.	12pF	50V	CH	GRM39CH120J50PT	K22174213		1-	B	d2
C 1196	CHIP CAP.	0.01uF	50V	B	GRM39B103M50PT	K22174823		1-	B	d2
C 1197	CHIP CAP.	0.01uF	50V	B	GRM39B103M50PT	K22174823		1-	B	c3
C 1198	CHIP CAP.	220pF	50V	CH	GRM39CH221J50PT	K22174243		1-	B	f2
C 1199	CHIP CAP.	100pF	50V	CH	GRM39CH101J50PT	K22174235		1-	B	e3
C 1200	CHIP CAP.	47pF	50V	CH	GRM39CH470J50PT	K22174227		1-	B	c3
C 1201	CHIP CAP.	0.001uF	50V	B	GRM39B102K50PT	K22174821		1-	B	c2
C 1202	CHIP CAP.	27pF	50V	CH	GRM39CH270J50PT	K22174221		1-	B	e3
C 1203	CHIP CAP.	33pF	50V	CH	GRM39CH330J50PT	K22174223		1-	B	e3
C 1204	CHIP CAP.	0.001uF	50V	B	GRM39B102K50PT	K22174821		1-	A	G3
C 1205	CHIP CAP.	0.001uF	50V	B	GRM39B102K50PT	K22174821		1-	A	C3
C 1206	CHIP CAP.	0.01uF	50V	B	GRM39B103M50PT	K22174823		1-	B	d2
C 1207	CHIP CAP.	2pF	50V	CK	GRM39CK020C50PT	K22174203		1-	B	b3
C 1208	CHIP CAP.	0.001uF	50V	B	GRM39B102K50PT	K22174821		1-	B	d2
C 1209	CHIP CAP.	0.001uF	50V	B	GRM39B102K50PT	K22174821		1-	A	C3
C 1210	CHIP CAP.	0.1uF	16V	B	GRM39B104K16PT	K22124805		1-	A	C3
C 1211	CHIP CAP.	220pF	50V	CH	GRM39CH221J50PT	K22174243		1-	A	C3
C 1212	CHIP CAP.	0.001uF	50V	B	GRM39B102K50PT	K22174821		1-	B	e3
C 1213	CHIP CAP.	0.01uF	50V	B	GRM39B103M50PT	K22174823		1-	B	d2
C 1214	CHIP CAP.	0.1uF	16V	B	GRM39B104K16PT	K22124805		1-	A	C3
C 1215	CHIP CAP.	18pF	50V	CH	GRM39CH180J50PT	K22174217		1-	B	c2
C 1216	CHIP CAP.	0.001uF	50V	B	GRM39B102K50PT	K22174821		1-	B	c2
C 1217	CHIP TA.CAP.	10uF	6.3V		TEMSVA0J106M-8R	K78080027		1-	B	e3
C 1218	CHIP CAP.	0.001uF	50V	B	GRM39B102K50PT	K22174821		1-	B	d2
C 1219	CHIP CAP.	0.01uF	50V	B	GRM39B103M50PT	K22174823		1-	A	G4
C 1220	CHIP CAP.	470pF	50V	CH	GRM39CH471J50PT	K22174249		1-	B	c2
C 1221	CHIP CAP.	0.001uF	50V	B	GRM39B102K50PT	K22174821		1-	A	F3
C 1222	CHIP CAP.	15pF	50V	CH	GRM39CH150J50PT	K22174215		1-	A	G3
C 1223	CHIP CAP.	0.001uF	50V	B	GRM39B102K50PT	K22174821		1-	A	G3
C 1224	CHIP CAP.	3pF	50V	CJ	GRM39CJ030C50PT	K22174204		1-	A	G3
C 1225	CHIP CAP.	0.01uF	50V	B	GRM39B103M50PT	K22174823		1-	A	G3
C 1226	CHIP TA.CAP.	4.7uF	10V		TEMSVA1A475M-8R	K78100022		1-	B	f2
C 1227	CHIP CAP.	0.01uF	50V	B	GRM39B103M50PT	K22174823		1-	B	b3
C 1228	CHIP CAP.	470pF	50V	CH	GRM39CH471J50PT	K22174249		1-	A	E4
C 1229	CHIP CAP.	0.01uF	50V	B	GRM39B103M50PT	K22174823		1-	B	b3
C 1230	CHIP CAP.	0.1uF	16V	B	GRM39B104K16PT	K22124805		1-	A	E1
C 1231	CHIP CAP.	0.1uF	16V	B	GRM39B104K16PT	K22124805		1-	A	E1
C 1232	CHIP CAP.	470pF	50V	CH	GRM39CH471J50PT	K22174249		1-	A	C2
C 1233	CHIP CAP.	0.01uF	50V	B	GRM39B103M50PT	K22174823		1-	B	b4
C 1234	CHIP CAP.	0.01uF	50V	B	GRM39B103M50PT	K22174823		1-	B	b3
C 1235	CHIP CAP.	0.01uF	50V	B	GRM39B103M50PT	K22174823		1-	A	F1
C 1238	CHIP CAP.	0.001uF	50V	B	GRM39B102K50PT	K22174821		1-	B	c3
C 1239	CHIP CAP.	22pF	50V	CH	GRM39CH220J50PT	K22174219		1-	B	c3
C 1240	CHIP CAP.	0.1uF	16V	B	GRM39B104K16PT	K22124805		1-	B	c3
C 1241	CHIP CAP.	15pF	50V	CH	GRM39CH150J50PT	K22174215		1-	B	c4
C 1242	CHIP CAP.	39pF	50V	CH	GRM39CH390J50PT	K22174225		1-	B	c3
C 1243	CHIP CAP.	0.01uF	50V	B	GRM39B103M50PT	K22174823		1-	B	c3
C 1244	CHIP CAP.	100pF	50V	CH	GRM39CH101J50PT	K22174235		1-	B	d3
C 1245	CHIP CAP.	0.001uF	50V	B	GRM39B102K50PT	K22174821		1-	B	f4

RF Unit

Parts List

REF	DESCRIPTION	VALUE	V/W	TOL.	MFR'S DESIG	VXSTD P/N	VERS.	LOT	SIDE	LAY ADR
C 1246	CHIP CAP.	0.01uF	50V	B	GRM39B103M50PT	K22174823		1-	B	f1
C 1247	CHIP CAP.	0.001uF	50V	B	GRM39B102K50PT	K22174821		1-	A	E1
C 1248	CHIP CAP.	0.1uF	16V	B	GRM39B104K16PT	K22124805		1-	A	F4
C 1249	CHIP CAP.	12pF	50V	CH	GRM39CH120J50PT	K22174213		1-	B	c3
C 1250	CHIP CAP.	0.01uF	50V	B	GRM39B103M50PT	K22174823		1-	B	b3
C 1251	CHIP CAP.	68pF	50V	CH	GRM39CH680J50PT	K22174231		1-	A	F3
C 1252	CHIP CAP.	0.1uF	16V	B	GRM39B104K16PT	K22124805		1-	A	F3
C 1253	CHIP CAP.	0.001uF	50V	B	GRM39B102K50PT	K22174821		1-	A	E1
C 1254	CHIP CAP.	0.01uF	50V	B	GRM39B103M50PT	K22174823		1-	B	b1
C 1255	CHIP CAP.	100pF	50V	CH	GRM39CH101J50PT	K22174235		1-	B	e3
C 1256	CHIP CAP.	0.1uF	16V	B	GRM39B104K16PT	K22124805		1-	A	D1
C 1257	CHIP CAP.	470pF	50V	CH	GRM39CH471J50PT	K22174249		1-	A	E1
C 1258	CHIP CAP.	470pF	50V	CH	GRM39CH471J50PT	K22174249		1-	A	E1
C 1260	CHIP CAP.	470pF	50V	CH	GRM39CH471J50PT	K22174249		1-	A	F1
C 1261	CHIP TA.CAP.	4.7uF	16V		TEMSVA1C475M-8R	K78120031		1-	B	f2
C 1268	CHIP TA.CAP.	10uF	10V		TEMSVA1A106M-8R	K78100028		1-	B	f3
C 1269	CHIP CAP.	470pF	50V	CH	GRM39CH471J50PT	K22174249		1-	A	D1
C 1270	CHIP CAP.	470pF	50V	CH	GRM39CH471J50PT	K22174249		1-	B	f2
C 1271	CHIP CAP.	470pF	50V	CH	GRM39CH471J50PT	K22174249		1-	A	D1
C 1272	CHIP CAP.	470pF	50V	CH	GRM39CH471J50PT	K22174249		1-	A	E2
C 1273	CHIP CAP.	470pF	50V	CH	GRM39CH471J50PT	K22174249		1-	A	E1
C 1274	CHIP CAP.	220pF	50V	CH	GRM39CH221J50PT	K22174243		1-	A	E3
C 1277	CHIP CAP.	220pF	50V	CH	GRM39CH221J50PT	K22174243		1-	B	f3
C 1279	CHIP CAP.	0.1uF	16V	B	GRM39B104K16PT	K22124805		1-	B	d4
C 1280	CHIP CAP.	3pF	50V	CJ	GRM39CJ030C50PT	K22174204		1-	A	G2
C 1283	CHIP CAP.	10pF	200V	CH	GRM40CH100D200PT	K22230216		1-	A	F2
C 1286	CHIP CAP.	0.01uF	50V	B	GRM39B103M50PT	K22174823		1-	A	G2
C 1287	CHIP CAP.	0.001uF	50V	B	GRM39B102K50PT	K22174821		1-	A	F3
C 1288	CHIP CAP.	0.001uF	50V	B	GRM39B102K50PT	K22174821		1-	A	E1
C 1289	CHIP CAP.	0.01uF	50V	B	GRM39B103M50PT	K22174823		1-	B	b2
C 1291	CHIP CAP.	0.1uF	16V	B	GRM39B104K16PT	K22124805		1-	A	E1
C 1292	CHIP CAP.	10pF	50V	CH	GRM39CH100D50PT	K22174211		1-	B	c3
C 1293	CHIP CAP.	0.01uF	50V	B	GRM39B103M50PT	K22174823		1-	A	E4
C 1294	CHIP CAP.	0.01uF	50V	B	GRM39B103M50PT	K22174823		1-	B	b2
C 1295	CHIP CAP.	1pF	50V	CK	GRM39CK010C50PT	K22174202		1-	A	F3
C 1296	CHIP CAP.	15pF	50V	CH	GRM39CH150J50PT	K22174215		1-	A	G1
C 1298	CHIP CAP.	220pF	50V	CH	GRM39CH221J50PT	K22174243		1-	A	G2
C 1299	CHIP CAP.	15pF	50V	CH	GRM39CH150J50PT	K22174215		1-		
C 1501	CHIP CAP.	100pF	50V	CH	GRM39CH101J50PT	K22174235		1-	A	B1
C 1502	CHIP CAP.	100pF	50V	CH	GRM39CH101J50PT	K22174235		1-	B	g1
C 1503	CHIP CAP.	100pF	50V	CH	GRM39CH101J50PT	K22174235		1-	A	A1
C 1504	CHIP CAP.	100pF	50V	CH	GRM39CH101J50PT	K22174235		1-	B	g1
C 1505	CHIP CAP.	0.1uF	16V	B	GRM39B104K16PT	K22124805		1-	A	B1
C 1506	CHIP CAP.	100pF	50V	CH	GRM39CH101J50PT	K22174235		1-	A	B1
C 1507	CHIP TA.CAP.	10uF	10V		TEMSVA1A106M-8R	K78100028		1-	A	B2
C 1508	CHIP CAP.	100pF	50V	CH	GRM39CH101J50PT	K22174235		1-	A	B2
C 1509	CHIP CAP.	1uF	10V	F	GRM39F105Z10PT	K22105001		1-	A	B2
C 1510	CHIP CAP.	1uF	10V	F	GRM39F105Z10PT	K22105001		1-	B	g2
C 1511	CHIP CAP.	0.01uF	50V	B	GRM39B103M50PT	K22174823		1-	A	B3
C 1512	CHIP CAP.	0.001uF	50V	B	GRM39B102K50PT	K22174821		1-	B	g2
C 1513	CHIP CAP.	0.01uF	50V	B	GRM39B103M50PT	K22174823		1-	A	B3
C 1515	AL.ELECTRO.CAP.	10uF	16V		RV2-16V100MB55-R	K48120014		1-	A	A1
C 1516	CHIP CAP.	0.1uF	16V	B	GRM39B104K16PT	K22124805		1-	A	B3
C 1517	CHIP CAP.	0.1uF	16V	B	GRM39B104K16PT	K22124805		1-	A	B3
C 1518	CHIP CAP.	0.001uF	50V	B	GRM39B102K50PT	K22174821		1-	B	g2
C 1519	CHIP TA.CAP.	4.7uF	10V		TEMSVA1A475M-8R	K78100022		1-	B	f3
C 1520	AL.ELECTRO.CAP.	100uF	16V		ECEV1CA101WPT	K48120012		1-	A	A2
C 1521	AL.ELECTRO.CAP.	470uF	16V		RE3-16V471M 470UF	K40129066		1-	A	A1
C 1523	CHIP TA.CAP.	10uF	10V		TEMSVA1A106M-8R	K78100028		1-	B	f2
C 1524	CHIP CAP.	0.1uF	16V	B	GRM39B104K16PT	K22124805		1-	B	g2
C 1525	CHIP CAP.	120pF	50V	CH	GRM39CH121J50PT	K22174237		1-	A	B3
C 1526	CHIP CAP.	470pF	50V	CH	GRM39CH471J50PT	K22174249		1-	A	B3
C 1527	CHIP CAP.	0.1uF	16V	B	GRM39B104K16PT	K22124805		1-	A	B2
C 1528	CHIP CAP.	0.1uF	16V	B	GRM39B104K16PT	K22124805		1-	A	B2
C 1529	CHIP CAP.	470pF	50V	CH	GRM39CH471J50PT	K22174249		1-	A	B3
C 1530	CHIP CAP.	470pF	50V	CH	GRM39CH471J50PT	K22174249		1-	A	B3
C 1531	CHIP CAP.	0.0047uF	50V	B	GRM39B472K50PT	K22174833		1-	A	B3
C 1532	CHIP CAP.	6pF	50V	CH	GRM39CH060D50PT	K22174207		1-	A	B2
C 1533	CHIP CAP.	1uF	10V	F	GRM39F105Z10PT	K22105001		1-	A	B2
C 1534	CHIP TA.CAP.	68uF	10V		TEMSVC1A686M12R	K78100048		1-	B	f1
C 1535	CHIP CAP.	1uF	10V	F	GRM39F105Z10PT	K22105001		1-	A	B3
C 1536	CHIP CAP.	470pF	50V	CH	GRM39CH471J50PT	K22174249		1-	B	f3
C 1537	CHIP TA.CAP.	2.2uF	10V		TESVA1A225M1-8R	K78100021		1-	A	B3
C 1538	CHIP CAP.	0.0047uF	50V	B	GRM39B472K50PT	K22174833		1-	A	A3
C 1539	CHIP CAP.	0.001uF	50V	B	GRM39B102K50PT	K22174821		1-	B	g2
C 1540	CHIP CAP.	1uF	10V	F	GRM39F105Z10PT	K22105001		1-	B	h2

REF	DESCRIPTION	VALUE	V/W	TOL.	MFR'S DESIG	VXSTD P/N	VERS.	LOT	SIDE	LAY ADR
C 1541	CHIP CAP.	0.1uF	16V	B	GRM39B104K16PT	K22124805		1-	B	f2
C 1543	CHIP CAP.	0.1uF	16V	B	GRM39B104K16PT	K22124805		1-	B	f1
C 1544	CHIP CAP.	0.1uF	16V	B	GRM39B104K16PT	K22124805		1-	A	A2
C 1545	CHIP CAP.	0.1uF	16V	B	GRM39B104K16PT	K22124805		1-	A	B1
C 1546	CHIP CAP.	0.1uF	16V	B	GRM39B104K16PT	K22124805		1-	A	B2
C 1549	CHIP CAP.	0.1uF	16V	B	GRM39B104K16PT	K22124805		1-	B	f3
C 1550	CHIP CAP.	470pF	50V	CH	GRM39CH471J50PT	K22174249		1-	B	f3
CD1001	CERAMIC DISC				CDBC450CX24-TC	H7901340		1-	A	F3
CF1001	CERAMIC FILTER				CFWM450E	H3900466		1-	A	F3
CF1002	CERAMIC FILTER				CFWM450G	H3900435		1-	A	F3
D 1001	DIODE				RLS135 TE-11	G2070128		1-	A	G2
D 1002	DIODE				BAS316	G2070716		1-	A	G2
D 1003	DIODE				DSA3A1	G2090445		1-	A	C2
D 1004	SURGE ABSORBER				P6KA18	Q9000721		1-	A	B1
D 1005	DIODE				UM9957F/TR	G2070562		1-	B	b1
D 1006	DIODE				BAS316	G2070716		1-	A	D1
D 1007	DIODE				UM9957F/TR	G2070562		1-	B	b1
D 1008	DIODE				HVC306B TRF	G2070918		1-	A	G2
D 1009	DIODE				BAS316	G2070716		1-	A	D1
D 1010	DIODE				HVC306B TRF	G2070918		1-	A	G2
D 1011	DIODE				HSM88AS TR	G2070170		1-	A	F1
D 1012	DIODE				HSM88AS TR	G2070170		1-	A	F2
D 1013	DIODE				HVC306B TRF	G2070918		1-	A	D3
D 1014	DIODE				HVC306B TRF	G2070918		1-	A	D3
D 1015	DIODE				HVC306B TRF	G2070918		1-	A	D3
D 1016	DIODE				HVC306B TRF	G2070918		1-	A	D3
D 1017	DIODE				1SV214 TPH	G2070356		1-	A	D3
D 1018	DIODE				HVC306B TRF	G2070918		1-	A	G2
D 1019	DIODE				HVC306B TRF	G2070918		1-	A	G3
D 1021	DIODE				BAS316	G2070716		1-	B	d2
D 1022	DIODE				1SS321 TE85R	G2070076		1-	B	c2
D 1024	DIODE				MC2848-T11-1	G2070694		1-	B	b3
D 1026	DIODE				MC2848-T11-1	G2070694		1-	B	b4
D 1028	DIODE				HVC306B TRF	G2070918		1-	A	D3
D 1029	DIODE				HVC306B TRF	G2070918		1-	A	D3
D 1501	DIODE				MC2850-T11-1	G2070704		1-	B	g3
D 1502	DIODE				MC2850-T11-1	G2070704		1-	B	g3
D 1503	DIODE				MC2850-T11-1	G2070704		1-	B	g1
D 1504	DIODE				BAS316	G2070716		1-	B	g2
D 1505	DIODE				D1F20-4063	G2070474		1-	B	f1
D 1506	DIODE				MC2850-T11-1	G2070704		1-	A	B3
D 1507	DIODE				MC2850-T11-1	G2070704		1-	A	B3
F 1501	CHIP FUSE	0.25A			KAB-2402-251NA31	Q0000085		1-	A	B1
J 1501	CONNECTOR				IL-FPR-36S-VF-E1500	P1091126		1-	A	B3
J 1502	CONNECTOR				AE0031-00	P1090998		1-	B	g1
J 1503	CONNECTOR				53398-0290	P0091191		1-	A	A2
J 1504	CONNECTOR				53398-0390	P0091192		1-	A	A2
L 1001	COIL				E2 0.35-1.6-5.5T-L	L0022616		1-	A	G1
L 1002	COIL	0.044uH			AS050535-44N	L0022812		1-	A	G1
L 1003	COIL	0.033uH			AS0804-33NK	L0022538		1-	A	F1
L 1004	COIL				E2 0.25-1.9-5.5T-R	L0022610		1-	A	G1
L 1005	COIL	0.044uH			AS050535-44N	L0022812		1-	A	F1
L 1006	COIL				E2 0.25-1.9-5.5T-R	L0022610		1-	A	G1
L 1007	COIL	0.044uH			AS050535-44N	L0022812		1-	A	G1
L 1008	COIL				E2 0.25-1.9-8T-L	L0022550		1-	A	G2
L 1009	COIL				E2 0.25-1.9-8T-L	L0022550		1-	A	G2
L 1010	COIL	0.11uH			AS050647-110N	L0022817		1-	A	G2
L 1012	M.RFC	0.39uH		2%	C1608CA-R39G	L1691107		1-	A	D3
L 1013	M.RFC	33uH			LK1608 330M-T	L1690690		1-	A	D3
L 1014	M.RFC	0.39uH		2%	C1608CA-R39G	L1691107		1-	A	D3
L 1015	M.RFC	0.15uH			HK1608 R15J-T	L1690938		1-	A	G2
L 1016	COIL	0.038uH			AS050630-38N	L0022818		1-	A	G2
L 1017	COIL				E2 0.35-1.6-5.5T-L	L0022616		1-	A	D3
L 1018	M.RFC	0.39uH		2%	C1608CA-R39G	L1691107		1-	A	D3
L 1019	COIL				E2 0.25-1.9-8T-L	L0022550		1-	A	G2
L 1020	COIL				E2 0.35-2.0-4.5T-L	L0022686		1-	A	D3
L 1021	M.RFC	0.39uH		2%	C1608CA-R39G	L1691107		1-	A	D3
L 1022	COIL				E2 0.25-1.9-8.5T-L	L0022611		1-	B	e2
L 1023	COIL				E2 0.25-1.9-8T-L	L0022550		1-	A	G3
L 1025	M.RFC	0.056uH			HK1608 56NJ-T	L1690525		1-	A	E3
L 1026	COIL				E2 0.25-1.9-5.5T-R	L0022610		1-	A	G3
L 1027	M.RFC	0.056uH			HK1608 56NJ-T	L1690525		1-	B	e3
L 1028	COIL				E2 0.25-1.9-5.5T-R	L0022610		1-	A	G3
L 1029	COIL				E2 0.25-1.9-8.5T-L	L0022611		1-	B	e2
L 1030	M.RFC	0.082uH			HK1608 82NJ-T	L1690527		1-	B	b3
L 1031	M.RFC	0.082uH			HK1608 82NJ-T	L1690527		1-	B	e3

RF Unit

Parts List

REF	DESCRIPTION	VALUE	V/W	TOL.	MFR'S DESIG	VXSTD P/N	VERS.	LOT	SIDE	LAY ADR
L 1032	M.RFC	0.082uH			HK1608 82NJ-T	L1690527		1-	B	b3
L 1033	M.RFC	0.22uH			HK1608 R22J-T	L1690940		1-	B	c3
L 1034	M.RFC	0.082uH			HK1608 82NJ-T	L1690527		1-	B	d2
L 1035	M.RFC	0.22uH			HK1608 R22J-T	L1690940		1-	A	G3
L 1036	M.RFC	0.068uH			HK1608 68NJ-T	L1690526		1-	B	c2
L 1037	M.RFC	0.068uH			HK1608 68NJ-T	L1690526		1-	A	G3
L 1038	M.RFC	0.039uH			HK1608 39NJ-T	L1690523		1-	A	G3
L 1039	M.RFC	0.22uH			HK1608 R22J-T	L1690940		1-	B	c2
L 1040	CHIP COIL	0.82uH			C2520C-R82J	L1690555		1-	A	G3
L 1041	M.RFC	0.82uH			LK1608 R82K-T	L1690417		1-	B	c3
L 1042	M.RFC	0.33uH			LK1608 R33K-T	L1690412		1-	B	c4
Q 1001	TRANSISTOR				2SC4116GR TE85R	G3341167G		1-	B	c3
Q 1002	TRANSISTOR				RT1N241M-T11-1	G3070249		1-	A	E1
Q 1003	IC				NJM2902V-TE1	G1091679		1-	A	D1
Q 1004	IC				MM1216ENRE	G1092432		1-	B	f2
Q 1005	TRANSISTOR				2SB1201S-TL	G3070195		1-	B	f2
Q 1006	TRANSISTOR				RT1N241M-T11-1	G3070249		1-	A	D1
Q 1007	TRANSISTOR				2SC4154-T11-1E	G3341548E		1-	B	d3
Q 1008	TRANSISTOR				DTB123EK T146	G3070022		1-	B	f2
Q 1009	TRANSISTOR				2SB1132 T100 R	G3211327R		1-	B	f2
Q 1010	TRANSISTOR				IMH6A T108	G3070066		1-	B	f2
Q 1011	TRANSISTOR				2SC4226-T2B R24	G3342267D		1-	A	G2
Q 1012	TRANSISTOR				RT1N241M-T11-1	G3070249		1-	B	e3
Q 1013	FET				2SK508-T2B K52	G3805087B		1-	A	D3
Q 1014	IC				RA30H1317M	G1093639		1-	B	e1
Q 1015	TRANSISTOR				2SC4226-T2B R24	G3342267D		1-	A	D3
Q 1016	TRANSISTOR				RT1N241M-T11-1	G3070249		1-	A	E3
Q 1017	TRANSISTOR				IMH6A T108	G3070066		1-	A	E3
Q 1018	TRANSISTOR				2SC5107-O(TE85R)	G3351077O		1-	A	E3
Q 1019	IC				M5223AGP 600C	G1093020		1-	A	C3
Q 1020	TRANSISTOR				2SC5107-O(TE85R)	G3351077O		1-	B	f3
Q 1021	TRANSISTOR				2SC5107-O(TE85R)	G3351077O		1-	B	c3
Q 1022	TRANSISTOR				2SC5415E-TD	G3354158E		1-	B	d2
Q 1023	IC				SA7025DK	G1093014		1-	A	C3
Q 1024	IC				NJM78L05UA TE1	G1091325		1-	B	e3
Q 1025	TRANSISTOR				2SC5107-O(TE85R)	G3351077O		1-	B	d2
Q 1026	FET				3SK228XR-TR	G4802287		1-	A	G3
Q 1028	IC				TA31136FN(EL)	G1091605		1-	B	c3
Q 1029	TRANSISTOR				2SC4215Y TE85R	G3342157Y		1-	B	c3
Q 1030	TRANSISTOR				RT1N241M-T11-1	G3070249		1-	B	b4
Q 1031	TRANSISTOR				2SA1602A-T11-1F	G3116028F		1-	B	c3
Q 1032	TRANSISTOR				RT1N241M-T11-1	G3070249		1-	A	E1
Q 1033	TRANSISTOR				RT1N241M-T11-1	G3070249		1-	A	D1
Q 1034	TRANSISTOR				RT1N241M-T11-1	G3070249		1-	A	E1
Q 1035	TRANSISTOR				RT1N241M-T11-1	G3070249		1-	A	E1
Q 1501	TRANSISTOR				2SC4154-T11-1E	G3341548E		1-	A	B1
Q 1502	TRANSISTOR				RT1N241M-T11-1	G3070249		1-	A	B2
Q 1503	IC				NJM2902V-TE1	G1091679		1-	A	B2
Q 1504	TRANSISTOR				2SD1368CB TL	G3413688B		1-	A	B1
Q 1505	TRANSISTOR				2SA1602A-T11-1F	G3116028F		1-	A	B1
Q 1506	TRANSISTOR				RT1N241M-T11-1	G3070249		1-	A	B2
Q 1507	TRANSISTOR				RT1N241M-T11-1	G3070249		1-	A	B2
Q 1508	TRANSISTOR				PDTC114TE	G3070238		1-	B	f2
Q 1509	IC				TDA2003H	G1090815		1-	A	A1
Q 1510	TRANSISTOR				PDTC114TE	G3070238		1-	B	f2
Q 1511	TRANSISTOR				2SB1301-T2 ZQ	G3213017Q		1-	A	A1
Q 1512	TRANSISTOR				RT1N241M-T11-1	G3070249		1-	A	A1
Q 1515	FET				2SJ125D-T12-1D	G3701257D		1-	B	g2
Q 1516	TRANSISTOR				RT1N241M-T11-1	G3070249		1-	B	f2
Q 1517	TRANSISTOR				RT1N241M-T11-1	G3070249		1-	B	f2
Q 1518	TRANSISTOR				RT1N241M-T11-1	G3070249		1-	A	A2
Q 1519	TRANSISTOR				2SC4154-T11-1E	G3341548E		1-	B	f3
R 1001	CHIP RES.	47k	1/16W	5%	RMC1/16 473JATP	J24185473		1-	A	G1
R 1002	CHIP RES.	22k	1/16W	5%	RMC1/16 223JATP	J24185223		1-	A	E1
R 1003	CHIP RES.	820k	1/16W	5%	RMC1/16 824JATP	J24185824		1-	B	c4
R 1004	CHIP RES.	1k	1/16W	5%	RMC1/16 102JATP	J24185102		1-	B	c4
R 1005	CHIP RES.	15	1/16W	5%	RMC1/16 150JATP	J24185150		1-	A	E3
R 1006	CHIP RES.	680	1/16W	5%	RMC1/16 681JATP	J24185681		1-	B	c3
R 1007	CHIP RES.	33k	1/16W	5%	RMC1/16 333JATP	J24185333		1-	A	C3
R 1008	CHIP RES.	470	1/16W	5%	RMC1/16 471JATP	J24185471		1-	A	E1
R 1009	CHIP RES.	1k	1/16W	5%	RMC1/16 102JATP	J24185102		1-	A	D1
R 1010	CHIP RES.	150k	1/16W	5%	RMC1/16 154JATP	J24185154		1-	A	C3
R 1011	CHIP RES.	10k	1/16W	5%	RMC1/16 103JATP	J24185103		1-	B	f2
R 1012	CHIP RES.	0	1/16W	5%	RMC1/16 000JATP	J24185000		1-	B	c3
R 1013	CHIP RES.	0	1/16W	5%	RMC1/16 000JATP	J24185000		1-	B	f3
R 1014	CHIP RES.	470k	1/16W	5%	RMC1/16 474JATP	J24185474		1-	A	C3

REF	DESCRIPTION	VALUE	V/W	TOL.	MFR'S DESIG	VXSTD P/N	VERS.	LOT	SIDE	LAY ADR
R 1015	CHIP RES.	100k	1/16W	5%	RMC1/16 104JATP	J24185104		1-	A	D1
R 1016	CHIP RES.	100k	1/16W	5%	RMC1/16 104JATP	J24185104		1-	A	D1
R 1017	CHIP RES.	150k	1/16W	5%	RMC1/16 154JATP	J24185154		1-	A	C3
R 1018	CHIP RES.	4.7k	1/16W	5%	RMC1/16 472JATP	J24185472		1-	A	D1
R 1019	CHIP RES.	4.7k	1/16W	5%	RMC1/16 472JATP	J24185472		1-	A	D1
R 1020	CHIP RES.	1.2k	1/16W	5%	RMC1/16 122JATP	J24185122		1-	B	e3
R 1021	CHIP RES.	0	1/16W	5%	RMC1/16 000JATP	J24185000		1-	A	D1
R 1022	CHIP RES.	1.2k	1/16W	5%	RMC1/16 122JATP	J24185122		1-	B	d3
R 1023	CHIP RES.	150k	1/16W	5%	RMC1/16 154JATP	J24185154		1-	A	D1
R 1024	CHIP RES.	100k	1/16W	5%	RMC1/16 104JATP	J24185104		1-	A	G2
R 1025	CHIP RES.	100k	1/16W	5%	RMC1/16 104JATP	J24185104		1-	B	f2
R 1026	CHIP RES.	100k	1/16W	5%	RMC1/16 104JATP	J24185104		1-	B	b2
R 1027	CHIP RES.	100k	1/16W	5%	RMC1/16 104JATP	J24185104		1-	A	G2
R 1028	CHIP RES.	1.2k	1/16W	5%	RMC1/16 122JATP	J24185122		1-	B	f2
R 1029	CHIP RES.	120k	1/16W	5%	RMC1/16 124JATP	J24185124		1-	A	D1
R 1030	CHIP RES.	220k	1/16W	5%	RMC1/16 224JATP	J24185224		1-	A	E1
R 1031	CHIP RES.	4.7k	1/16W	5%	RMC1/16 472JATP	J24185472		1-	A	F1
R 1032	CHIP RES.	4.7k	1/16W	5%	RMC1/16 472JATP	J24185472		1-	A	F2
R 1033	METAL FILM RES.	100	1W	5%	ERG-1SJ101P 100	J22309010		1-	A	F2
R 1034	CHIP RES.	4.7k	1/16W	5%	RMC1/16 472JATP	J24185472		1-	A	F2
R 1035	CHIP RES.	4.7k	1/16W	5%	RMC1/16 472JATP	J24185472		1-	A	F2
R 1036	CHIP RES.	100	1/10W	5%	RMC1/10T 101J	J24205101		1-	B	b2
R 1037	CHIP RES.	47	1/16W	5%	RMC1/16 470JATP	J24185470		1-	B	b2
R 1038	CHIP RES.	10k	1/16W	5%	RMC1/16 103JATP	J24185103		1-	A	G2
R 1039	CHIP RES.	10k	1/16W	5%	RMC1/16 103JATP	J24185103		1-	A	G2
R 1040	CHIP RES.	22k	1/16W	5%	RMC1/16 223JATP	J24185223		1-	A	D3
R 1041	CHIP RES.	330k	1/16W	5%	RMC1/16 334JATP	J24185334		1-	A	E1
R 1042	CHIP RES.	100	1/16W	5%	RMC1/16 101JATP	J24185101		1-	B	d3
R 1043	CHIP RES.	100	1/16W	5%	RMC1/16 101JATP	J24185101		1-	B	d3
R 1044	CHIP RES.	3.9k	1/16W	5%	RMC1/16 392JATP	J24185392		1-	B	e3
R 1045	CHIP RES.	100	1/10W	5%	RMC1/10T 101J	J24205101		1-	B	c2
R 1046	CHIP RES.	100k	1/16W	5%	RMC1/16 104JATP	J24185104		1-	A	D3
R 1047	CHIP RES.	100	1/16W	5%	RMC1/16 101JATP	J24185101		1-	A	G2
R 1048	CHIP RES.	1k	1/16W	5%	RMC1/16 102JATP	J24185102		1-	A	G2
R 1049	CHIP RES.	100k	1/16W	5%	RMC1/16 104JATP	J24185104		1-	B	e3
R 1050	CHIP RES.	470k	1/16W	5%	RMC1/16 474JATP	J24185474		1-	B	e3
R 1051	CHIP RES.	470k	1/16W	5%	RMC1/16 474JATP	J24185474		1-	B	d3
R 1052	CHIP RES.	10k	1/16W	5%	RMC1/16 103JATP	J24185103		1-	B	e4
R 1053	CHIP RES.	4.7k	1/16W	5%	RMC1/16 472JATP	J24185472		1-	B	e3
R 1054	CHIP RES.	100k	1/16W	5%	RMC1/16 104JATP	J24185104		1-	A	G3
R 1055	CHIP RES.	120	1/10W	5%	RMC1/10T 121J	J24205121		1-	B	e2
R 1056	CHIP RES.	2.7	1/10W	5%	RMC1/10T 2R7J	J24205279		1-	B	e2
R 1057	CHIP RES.	4.7k	1/16W	5%	RMC1/16 472JATP	J24185472		1-	B	e3
R 1058	CHIP RES.	10k	1/16W	5%	RMC1/16 103JATP	J24185103		1-	A	D3
R 1059	CHIP RES.	120	1/10W	5%	RMC1/10T 121J	J24205121		1-	B	e2
R 1060	CHIP RES.	100k	1/16W	5%	RMC1/16 104JATP	J24185104		1-	B	b2
R 1061	CHIP RES.	4.7k	1/16W	5%	RMC1/16 472JATP	J24185472		1-	A	D3
R 1062	CHIP RES.	150	1/16W	5%	RMC1/16 151JATP	J24185151		1-	A	D3
R 1063	CHIP RES.	100k	1/16W	5%	RMC1/16 104JATP	J24185104		1-	A	G3
R 1064	CHIP RES.	2.7k	1/16W	5%	RMC1/16 272JATP	J24185272		1-	A	C3
R 1065	CHIP RES.	270	1/16W	5%	RMC1/16 271JATP	J24185271		1-	A	C3
R 1066	CHIP RES.	680	1/16W	5%	RMC1/16 681JATP	J24185681		1-	A	D3
R 1067	CHIP RES.	4.7k	1/16W	5%	RMC1/16 472JATP	J24185472		1-	A	D3
R 1068	CHIP RES.	100	1/16W	5%	RMC1/16 101JATP	J24185101		1-	B	d3
R 1069	CHIP RES.	8.2k	1/16W	5%	RMC1/16 822JATP	J24185822		1-	A	E1
R 1070	CHIP RES.	4.7k	1/16W	5%	RMC1/16 472JATP	J24185472		1-	A	E3
R 1071	CHIP RES.	4.7k	1/16W	5%	RMC1/16 472JATP	J24185472		1-	A	E3
R 1072	CHIP RES.	0	1/16W	5%	RMC1/16 000JATP	J24185000		1-	A	E3
R 1073	CHIP RES.	220	1/16W	5%	RMC1/16 221JATP	J24185221		1-	A	E3
R 1074	CHIP RES.	120	1/16W	5%	RMC1/16 121JATP	J24185121		1-	B	e3
R 1075	CHIP RES.	470	1/16W	5%	RMC1/16 471JATP	J24185471		1-	B	c3
R 1076	CHIP RES.	120	1/16W	5%	RMC1/16 121JATP	J24185121		1-	B	d3
R 1077	CHIP RES.	120	1/16W	5%	RMC1/16 121JATP	J24185121		1-	B	d3
R 1078	CHIP RES.	10	1/16W	5%	RMC1/16 100JATP	J24185100		1-	B	c3
R 1079	CHIP RES.	820	1/16W	5%	RMC1/16 821JATP	J24185821		1-	B	e2
R 1080	CHIP RES.	180k	1/16W	5%	RMC1/16 184JATP	J24185184		1-	B	f3
R 1081	CHIP RES.	47	1/10W	5%	RMC1/10T 470J	J24205470		1-	B	e2
R 1082	CHIP RES.	10k	1/16W	5%	RMC1/16 103JATP	J24185103		1-	A	C3
R 1083	CHIP RES.	39	1/10W	5%	RMC1/10T 390J	J24205390		1-	B	d2
R 1084	CHIP RES.	22	1/16W	5%	RMC1/16 220JATP	J24185220		1-	B	e3
R 1085	CHIP RES.	1k	1/16W	5%	RMC1/16 102JATP	J24185102		1-	B	e3
R 1086	CHIP RES.	82k	1/16W	5%	RMC1/16 823JATP	J24185823		1-	B	c3
R 1087	CHIP RES.	0	1/16W	5%	RMC1/16 000JATP	J24185000		1-	A	G3
R 1088	CHIP RES.	2.2k	1/16W	5%	RMC1/16 222JATP	J24185222		1-	B	d2
R 1089	CHIP RES.	100	1/16W	5%	RMC1/16 101JATP	J24185101		1-	B	e3
R 1090	CHIP RES.	1k	1/16W	5%	RMC1/16 102JATP	J24185102		1-	A	C3

RF Unit

Parts List

REF	DESCRIPTION	VALUE	V/W	TOL.	MFR'S DESIG	VXSTD P/N	VERS.	LOT	SIDE	LAY ADR
R 1091	CHIP RES.	39k	1/16W	5%	RMC1/16 393JATP	J24185393		1-	A	C3
R 1092	CHIP RES.	2.2k	1/16W	5%	RMC1/16 222JATP	J24185222		1-	A	C3
R 1093	CHIP RES.	56	1/16W	5%	RMC1/16 560JATP	J24185560		1-	B	d2
R 1094	CHIP RES.	680	1/16W	5%	RMC1/16 681JATP	J24185681		1-	B	d2
R 1095	CHIP RES.	1k	1/16W	5%	RMC1/16 102JATP	J24185102		1-	A	C3
R 1096	CHIP RES.	100	1/16W	5%	RMC1/16 101JATP	J24185101		1-	B	c3
R 1097	CHIP RES.	1k	1/16W	5%	RMC1/16 102JATP	J24185102		1-	B	d2
R 1098	CHIP RES.	1k	1/16W	5%	RMC1/16 102JATP	J24185102		1-	A	C3
R 1099	CHIP RES.	47	1/16W	5%	RMC1/16 470JATP	J24185470		1-	B	d2
R 1100	CHIP RES.	680	1/16W	5%	RMC1/16 681JATP	J24185681		1-	B	c4
R 1101	CHIP RES.	0	1/16W	5%	RMC1/16 000JATP	J24185000		1-	B	b3
R 1102	CHIP RES.	68	1/16W	5%	RMC1/16 680JATP	J24185680		1-	B	b3
R 1103	CHIP RES.	1k	1/16W	5%	RMC1/16 102JATP	J24185102		1-	B	c3
R 1104	CHIP RES.	22	1/16W	5%	RMC1/16 220JATP	J24185220		1-	B	e3
R 1105	CHIP RES.	220	1/16W	5%	RMC1/16 221JATP	J24185221		1-	B	d2
R 1107	CHIP RES.	180	1/16W	5%	RMC1/16 181JATP	J24185181		1-	B	d2
R 1108	CHIP RES.	10k	1/16W	5%	RMC1/16 103JATP	J24185103		1-	B	d2
R 1109	CHIP RES.	10k	1/16W	5%	RMC1/16 103JATP	J24185103		1-	B	d2
R 1110	CHIP RES.	220	1/16W	5%	RMC1/16 221JATP	J24185221		1-	B	d2
R 1111	CHIP RES.	560	1/16W	5%	RMC1/16 561JATP	J24185561		1-	A	G3
R 1112	CHIP RES.	56	1/16W	5%	RMC1/16 560JATP	J24185560		1-	A	G4
R 1113	CHIP RES.	15	1/16W	5%	RMC1/16 150JATP	J24185150		1-	B	d2
R 1114	CHIP RES.	220	1/16W	5%	RMC1/16 221JATP	J24185221		1-	B	d2
R 1115	CHIP RES.	1k	1/16W	5%	RMC1/16 102JATP	J24185102		1-	A	E2
R 1116	CHIP RES.	15	1/16W	5%	RMC1/16 150JATP	J24185150		1-	B	b3
R 1117	CHIP RES.	1k	1/16W	5%	RMC1/16 102JATP	J24185102		1-	B	c3
R 1118	CHIP RES.	12k	1/16W	5%	RMC1/16 123JATP	J24185123		1-	B	b3
R 1121	CHIP RES.	2.2k	1/16W	5%	RMC1/16 222JATP	J24185222		1-	B	b3
R 1122	CHIP RES.	12k	1/16W	5%	RMC1/16 123JATP	J24185123		1-	B	b3
R 1123	CHIP RES.	12k	1/16W	5%	RMC1/16 123JATP	J24185123		1-	B	b3
R 1124	CHIP RES.	1k	1/16W	5%	RMC1/16 102JATP	J24185102		1-	B	c3
R 1125	CHIP RES.	6.8k	1/16W	5%	RMC1/16 682JATP	J24185682		1-	A	E4
R 1126	CHIP RES.	1.8k	1/16W	5%	RMC1/16 182JATP	J24185182		1-	A	D1
R 1127	CHIP RES.	220k	1/16W	5%	RMC1/16 224JATP	J24185224		1-	B	c3
R 1129	CHIP RES.	470	1/16W	5%	RMC1/16 471JATP	J24185471		1-	B	b3
R 1130	CHIP RES.	22k	1/16W	5%	RMC1/16 223JATP	J24185223		1-	B	c3
R 1131	CHIP RES.	12k	1/16W	5%	RMC1/16 123JATP	J24185123		1-	B	b3
R 1132	CHIP RES.	12k	1/16W	5%	RMC1/16 123JATP	J24185123		1-	B	b3
R 1134	CHIP RES.	220k	1/16W	5%	RMC1/16 224JATP	J24185224		1-	B	c3
R 1135	CHIP RES.	0	1/16W	5%	RMC1/16 000JATP	J24185000		1-	A	E1
R 1136	CHIP RES.	22k	1/16W	5%	RMC1/16 223JATP	J24185223		1-	B	c3
R 1137	CHIP RES.	2.2k	1/16W	5%	RMC1/16 222JATP	J24185222		1-	B	b3
R 1138	CHIP RES.	0	1/16W	5%	RMC1/16 000JATP	J24185000		1-	A	E1
R 1139	CHIP RES.	100	1/16W	5%	RMC1/16 101JATP	J24185101		1-	B	c3
R 1140	CHIP RES.	12k	1/16W	5%	RMC1/16 123JATP	J24185123		1-	B	b4
R 1141	CHIP RES.	2.2k	1/16W	5%	RMC1/16 222JATP	J24185222		1-	A	F3
R 1142	CHIP RES.	100	1/16W	5%	RMC1/16 101JATP	J24185101		1-	A	E4
R 1144	CHIP RES.	2.2k	1/16W	5%	RMC1/16 222JATP	J24185222		1-	A	F3
R 1145	CHIP RES.	10k	1/16W	5%	RMC1/16 103JATP	J24185103		1-	A	F4
R 1146	CHIP RES.	2.2k	1/16W	5%	RMC1/16 222JATP	J24185222		1-	B	c4
R 1147	CHIP RES.	100	1/16W	5%	RMC1/16 101JATP	J24185101		1-	A	D1
R 1148	CHIP RES.	22k	1/16W	5%	RMC1/16 223JATP	J24185223		1-	A	D4
R 1149	CHIP RES.	10k	1/16W	5%	RMC1/16 103JATP	J24185103		1-	A	C1
R 1150	CHIP RES.	10k	1/16W	5%	RMC1/16 103JATP	J24185103		1-	A	E1
R 1151	CHIP RES.	10k	1/16W	5%	RMC1/16 103JATP	J24185103		1-	A	D1
R 1152	CHIP RES.	1.2k	1/16W	5%	RMC1/16 122JATP	J24185122		1-	A	C3
R 1153	CHIP RES.	22	1/16W	5%	RMC1/16 220JATP	J24185220		1-	B	e3
R 1154	CHIP RES.	4.7k	1/16W	5%	RMC1/16 472JATP	J24185472		1-	A	E1
R 1156	CHIP RES.	4.7k	1/16W	5%	RMC1/16 472JATP	J24185472		1-	B	d3
R 1157	CHIP RES.	4.7	1/16W	5%	RMC1/16 4R7JATP	J24185479		1-	A	F3
R 1158	CHIP RES.	1k	1/16W	5%	RMC1/16 102JATP	J24185102		1-	A	E3
R 1159	CHIP RES.	1k	1/16W	5%	RMC1/16 102JATP	J24185102		1-	A	G2
R 1161	CHIP RES.	2.7k	1/16W	5%	RMC1/16 272JATP	J24185272		1-	A	F3
R 1162	CHIP RES.	10k	1/16W	5%	RMC1/16 103JATP	J24185103		1-	A	E1
R 1163	CHIP RES.	6.8k	1/16W	5%	RMC1/16 682JATP	J24185682		1-	A	E1
R 1164	CHIP RES.	10k	1/16W	5%	RMC1/16 103JATP	J24185103		1-	B	c3
R 1165	CHIP RES.	0	1/16W	5%	RMC1/16 000JATP	J24185000		1-	A	E1
R 1167	CHIP RES.	10k	1/16W	5%	RMC1/16 103JATP	J24185103		1-	A	E1
R 1168	CHIP RES.	0	1/16W	5%	RMC1/16 000JATP	J24185000		1-	A	E1
R 1178	CHIP RES.	4.7k	1/16W	5%	RMC1/16 472JATP	J24185472		1-	A	D3
R 1299	CHIP RES.	39	1/10W	5%	RMC1/10T 390J	J24205390		1-	B	d2
R 1300	CHIP RES.	47	1/10W	5%	RMC1/10T 470J	J24205470		1-	B	e2
R 1501	CHIP RES.	330	1/16W	5%	RMC1/16 331JATP	J24185331		1-	B	f1
R 1502	CHIP RES.	330	1/16W	5%	RMC1/16 331JATP	J24185331		1-	B	f1
R 1503	CHIP RES.	4.7k	1/16W	5%	RMC1/16 472JATP	J24185472		1-	B	f1
R 1504	CHIP RES.	4.7k	1/16W	5%	RMC1/16 472JATP	J24185472		1-	A	B1

REF	DESCRIPTION	VALUE	V/W	TOL.	MFR'S DESIG	VXSTD P/N	VERS.	LOT	SIDE	LAY ADR
R 1505	CHIP RES.	330	1/16W	5%	RMC1/16 331JATP	J24185331		1-	B	g1
R 1506	CHIP RES.	2.2k	1/16W	5%	RMC1/16 222JATP	J24185222		1-	A	B1
R 1507	CHIP RES.	1.2k	1/16W	5%	RMC1/16 122JATP	J24185122		1-	A	B1
R 1508	CHIP RES.	4.7k	1/16W	5%	RMC1/16 472JATP	J24185472		1-	A	B1
R 1509	CHIP RES.	100k	1/16W	5%	RMC1/16 104JATP	J24185104		1-	A	B1
R 1510	CHIP RES.	47k	1/16W	5%	RMC1/16 473JATP	J24185473		1-	A	B2
R 1511	CHIP RES.	560	1/16W	5%	RMC1/16 561JATP	J24185561		1-	A	B2
R 1512	CHIP RES.	4.7k	1/16W	5%	RMC1/16 472JATP	J24185472		1-	A	B2
R 1513	CHIP RES.	2.2k	1/16W	5%	RMC1/16 222JATP	J24185222		1-	A	B2
R 1514	CHIP RES.	150k	1/16W	5%	RMC1/16 154JATP	J24185154		1-	A	B2
R 1515	CHIP RES.	82k	1/16W	5%	RMC1/16 823JATP	J24185823		1-	A	B2
R 1516	CHIP RES.	100k	1/16W	5%	RMC1/16 104JATP	J24185104		1-	B	g2
R 1517	CHIP RES.	1.5k	1/16W	5%	RMC1/16 152JATP	J24185152		1-	B	h2
R 1518	CHIP RES.	220k	1/16W	5%	RMC1/16 224JATP	J24185224		1-	A	B3
R 1519	CHIP RES.	1M	1/16W	5%	RMC1/16 105JATP	J24185105		1-	A	B3
R 1520	CHIP RES.	100k	1/16W	5%	RMC1/16 104JATP	J24185104		1-	A	B3
R 1521	CHIP RES.	12	1/16W	5%	RMC1/16 120JATP	J24185120		1-	B	g1
R 1522	CHIP RES.	47k	1/16W	5%	RMC1/16 473JATP	J24185473		1-	A	B3
R 1523	CHIP RES.	47k	1/16W	5%	RMC1/16 473JATP	J24185473		1-	B	g3
R 1524	CHIP RES.	2.2k	1/16W	5%	RMC1/16 222JATP	J24185222		1-	A	B3
R 1525	CHIP RES.	470	1/10W	5%	RMC1/10T 471J	J24205471		1-	B	g1
R 1526	CHIP RES.	12	1/16W	5%	RMC1/16 120JATP	J24185120		1-	B	g1
R 1527	CHIP RES.	47	1/16W	5%	RMC1/16 470JATP	J24185470		1-	B	f2
R 1528	CHIP RES.	15k	1/16W	5%	RMC1/16 153JATP	J24185153		1-	B	f2
R 1529	CHIP RES.	12k	1/16W	5%	RMC1/16 123JATP	J24185123		1-	B	f2
R 1530	CHIP RES.	270k	1/16W	5%	RMC1/16 274JATP	J24185274		1-	A	B3
R 1531	CHIP RES.	1	1/10W	5%	RMC1/10T 1R0J	J24205010		1-	B	g2
R 1532	CHIP RES.	4.7	1W	5%	RMC1 4R7JTE	J24305479		1-	A	A2
R 1533	CHIP RES.	4.7	1W	5%	RMC1 4R7JTE	J24305479		1-	A	A2
R 1534	CHIP RES.	180	1/16W	5%	RMC1/16 181JATP	J24185181		1-	B	f2
R 1535	CHIP RES.	1k	1/4W	5%	RMC1/4 102JATP	J24245102		1-	A	B1
R 1536	CHIP RES.	0	1/16W	5%	RMC1/16 000JATP	J24185000		1-	B	f3
R 1537	CHIP RES.	2.2k	1/16W	5%	RMC1/16 222JATP	J24185222		1-	A	B2
R 1538	CHIP RES.	4.7k	1/16W	5%	RMC1/16 472JATP	J24185472		1-	A	A1
R 1539	CHIP RES.	150k	1/16W	5%	RMC1/16 154JATP	J24185154		1-	A	B3
R 1540	CHIP RES.	4.7k	1/16W	5%	RMC1/16 472JATP	J24185472		1-	A	B1
R 1541	CHIP RES.	180	1/16W	5%	RMC1/16 181JATP	J24185181		1-	A	B3
R 1542	CHIP RES.	2.2k	1/16W	5%	RMC1/16 222JATP	J24185222		1-	A	B3
R 1543	CHIP RES.	680	1/16W	5%	RMC1/16 681JATP	J24185681		1-	B	g1
R 1544	CHIP RES.	220k	1/16W	5%	RMC1/16 224JATP	J24185224		1-	A	B2
R 1545	CHIP RES.	18k	1/16W	5%	RMC1/16 183JATP	J24185183		1-	A	B2
R 1546	CHIP RES.	1.8M	1/16W	5%	RMC1/16 185JATP	J24185185		1-	A	B2
R 1548	CHIP RES.	47k	1/16W	5%	RMC1/16 473JATP	J24185473		1-	A	B2
R 1549	CHIP RES.	100k	1/16W	5%	RMC1/16 104JATP	J24185104		1-	A	C2
R 1550	CHIP RES.	33k	1/16W	5%	RMC1/16 333JATP	J24185333		1-	A	B2
R 1551	CHIP RES.	4.7k	1/16W	5%	RMC1/16 472JATP	J24185472		1-	A	A2
R 1553	CHIP RES.	47k	1/16W	5%	RMC1/16 473JATP	J24185473		1-	B	g2
R 1554	CHIP RES.	22k	1/16W	5%	RMC1/16 223JATP	J24185223		1-	B	f1
R 1556	CHIP RES.	4.7k	1/16W	5%	RMC1/16 472JATP	J24185472		1-	A	B2
R 1557	CHIP RES.	10k	1/16W	5%	RMC1/16 103JATP	J24185103		1-	B	g2
R 1558	CHIP RES.	100k	1/16W	5%	RMC1/16 104JATP	J24185104		1-	A	A2
R 1559	CHIP RES.	22k	1/16W	5%	RMC1/16 223JATP	J24185223		1-	A	A3
R 1560	CHIP RES.	0	1/16W	5%	RMC1/16 000JATP	J24185000		1-	A	A3
R 1561	CHIP RES.	10k	1/16W	5%	RMC1/16 103JATP	J24185103		1-	A	B2
R 1563	CHIP RES.	10k	1/16W	5%	RMC1/16 103JATP	J24185103		1-	B	f2
R 1564	CHIP RES.	47k	1/16W	5%	RMC1/16 473JATP	J24185473		1-	B	g2
R 1565	CHIP RES.	4.7k	1/16W	5%	RMC1/16 472JATP	J24185472		1-	A	B2
R 1566	CHIP RES.	100	1/16W	5%	RMC1/16 101JATP	J24185101		1-	B	f3
R 1567	CHIP RES.	1k	1/16W	5%	RMC1/16 102JATP	J24185102		1-	B	f3
R 1568	CHIP RES.	270	1/16W	5%	RMC1/16 271JATP	J24185271		1-	B	f3
R 1569	CHIP RES.	22k	1/16W	5%	RMC1/16 223JATP	J24185223		1-	B	f3
R 1570	CHIP RES.	47k	1/16W	5%	RMC1/16 473JATP	J24185473		1-	B	f3
R 1571	CHIP RES.	15k	1/16W	5%	RMC1/16 153JATP	J24185153		1-	B	f4
R 1573	CHIP RES.	0	1/16W	5%	RMC1/16 000JATP	J24185000		1-		
TH1001	THERMISTOR				TBPS1R104K475H5Q	G9090069		1-	B	b1
TH1003	THERMISTOR				TBPS1R473K475H5Q	G9090068		1-	B	b1
TH1004	THERMISTOR				TBPS1R473K475H5Q	G9090068		1-	A	E1
VR1001	POT.	4.7k			RH03A3AS3X 4.7K	J51807472		1-	A	E3
X 1001	XTAL OSC	14.6MHz			TTS05VS-P2 14.6MHZ	H9500740		1-	A	E3
XF1001	XTAL FILTER				MFT44P2 44.25MHZ	H1102359		1-	A	F3
	SHIELD CASE				(A)	RA0073900		1-		
	LEAF SPRING				(F/E)	R0140031		1-		
	SHIELD CASE				STG17-10 W=10	RA0392400		1-		
	GASKET				(¼"ÜÄÞ)	S5000238		1-		
	SPONGE RUBBER					RA0365500		1-		

RF Unit

Note

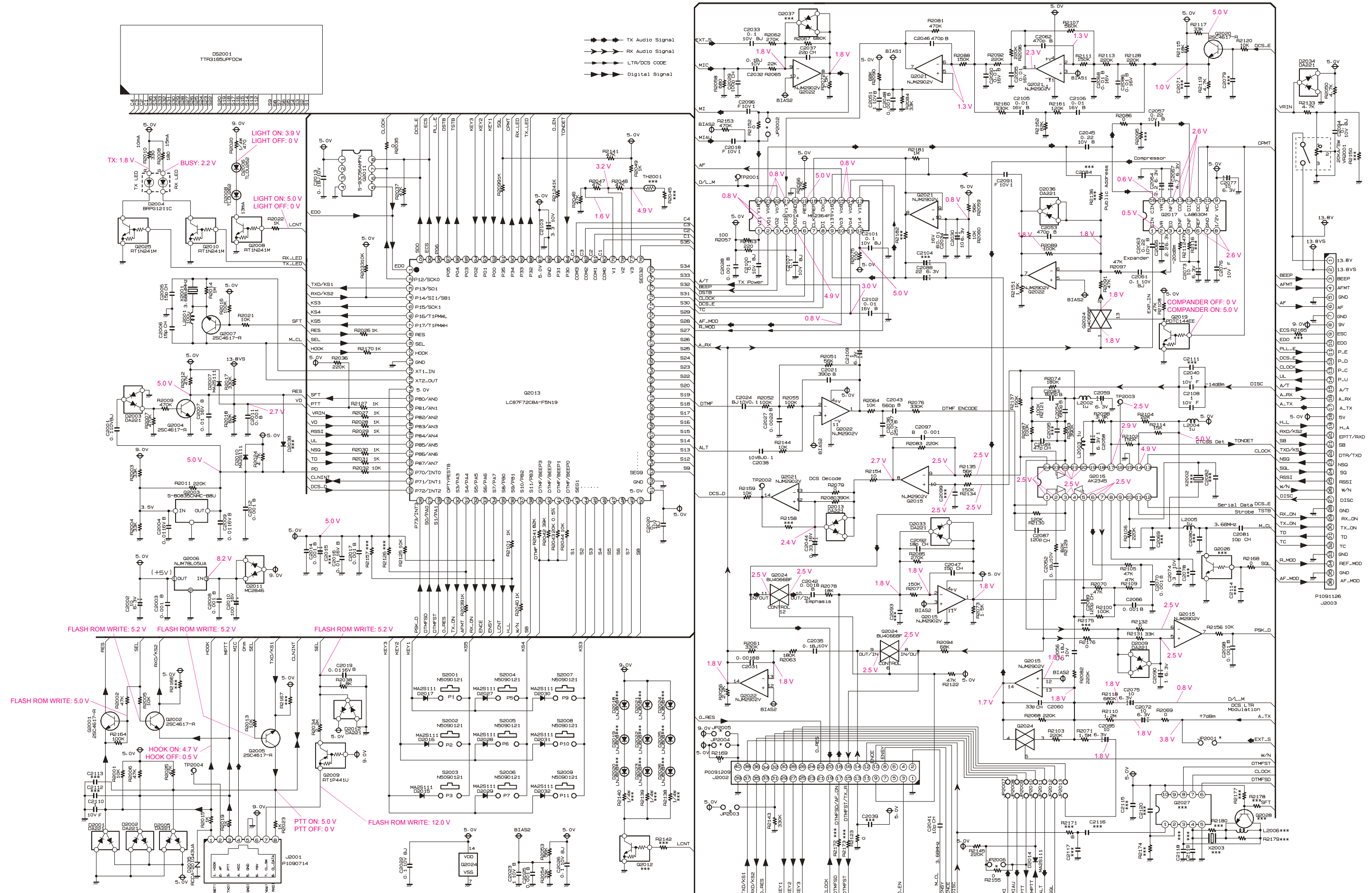

PANEL Unit

Note

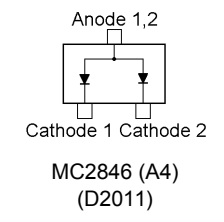
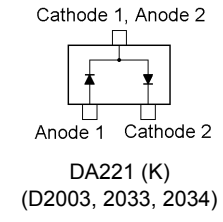
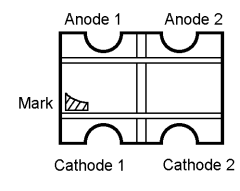
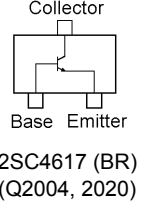
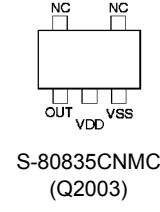
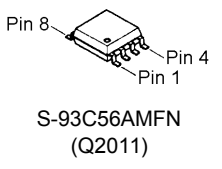
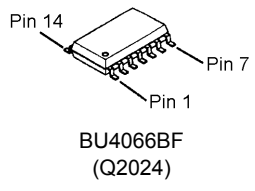
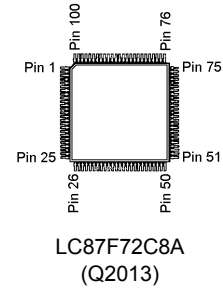
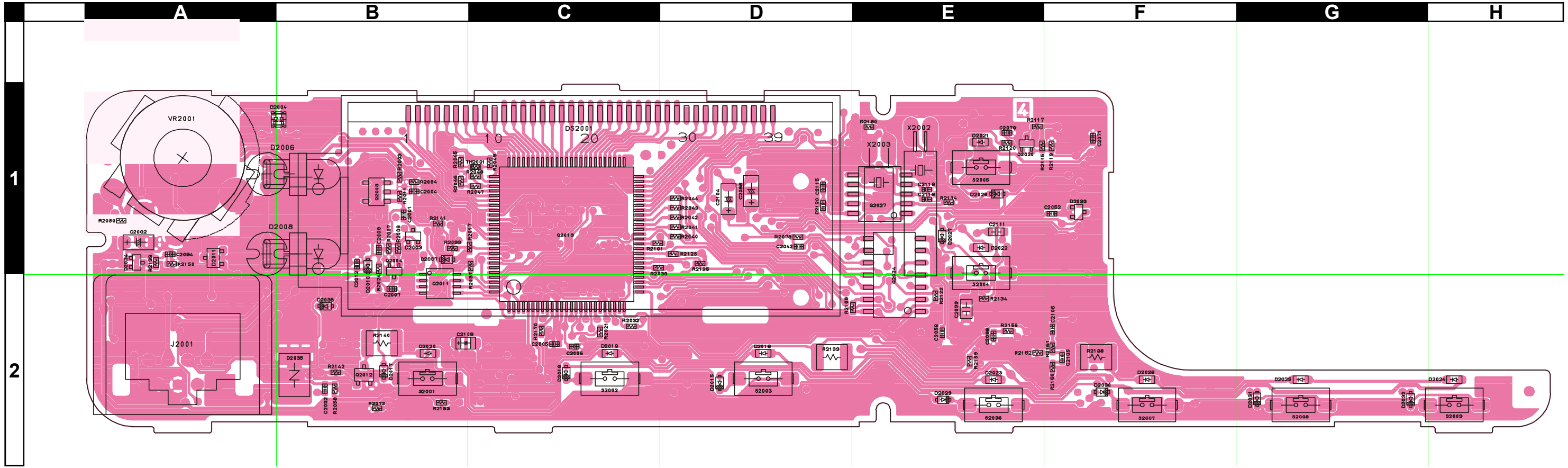

PANEL Unit

Parts Layout (Side B)

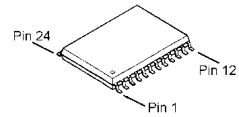
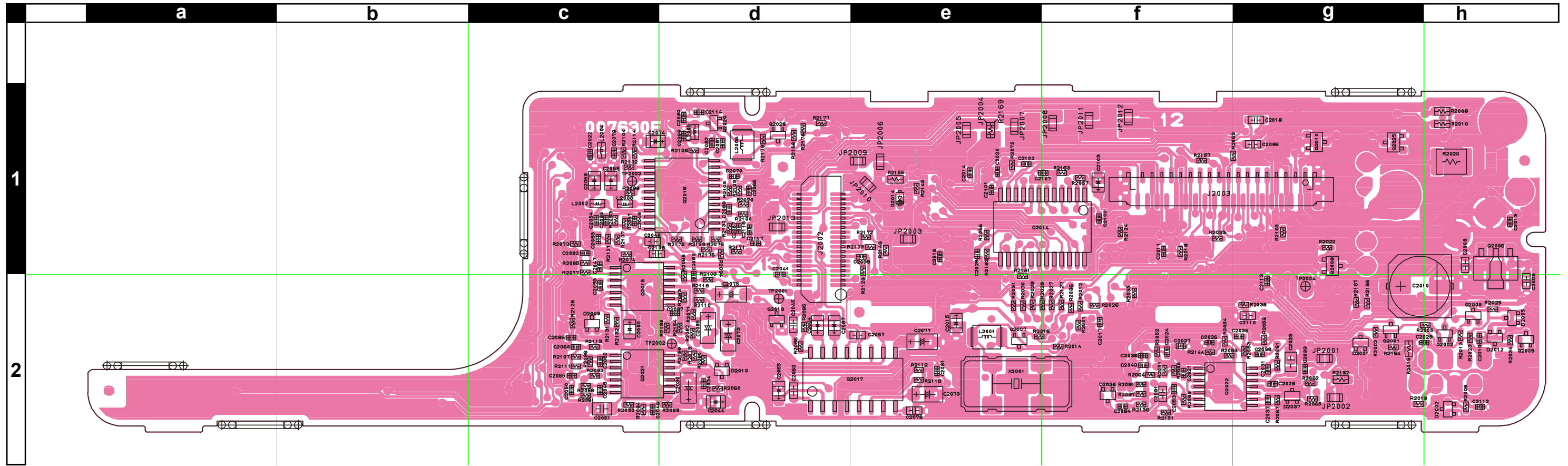

AK2345
(Q2016)
M62364FP
(Q2014)

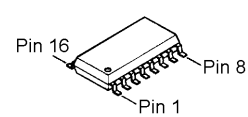

LA8630M
(Q2017)

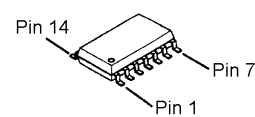

NJM2902V
(Q2015, 2021, 2022)

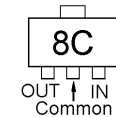

NJM78L05
(Q2006)

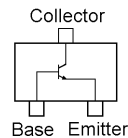

2SC4617 (BR)
(Q2001, 2002,
2005, 2007)

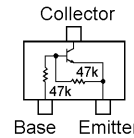

PDK144EE (08)
(Q2019)

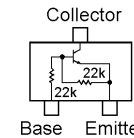

RT1N241M (N2)
(Q2008, 2010, 2025)

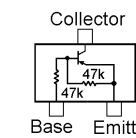

RT1P441U (P3)
(Q2009)

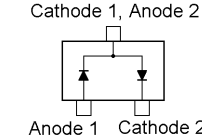

DA221 (K)
(D2001, 2002, 2005,
2009, 2012, 2013,
2036)

REF	DESCRIPTION	VALUE	V/W	TOL.	MFR'S DESIG	VXSTD P/N	VERS.	LOT	SIDE	LAY ADR
PCB with Component						CB1725001				
Printed Circuit Board						FR0076300				
						AC031U000				
C 2001	CHIP CAP.	0.1uF	10V	BJ	LMK105BJ104KV-F	K22108806		1-	A	B1
C 2002	CHIP TA.CAP.	10uF	6.3V		TEMSVA0J106M-8R	K78080027		1-	A	A1
C 2003	CHIP CAP.	0.001uF	50V	B	GRM39B102K50PT	K22174821		1-	B	h2
C 2004	CHIP CAP.	0.01uF	16V	B	GRM36B103K16PT	K22128804		1-	A	B1
C 2005	CHIP CAP.	15pF	50V	CH	UMK105CH150JW-F	K22178262		1-	A	C2
C 2006	CHIP CAP.	15pF	50V	CH	UMK105CH150JW-F	K22178262		1-	A	C2
C 2007	CHIP CAP.	0.01uF	16V	B	GRM36B103K16PT	K22128804		1-	A	B2
C 2008	CHIP CAP.	0.001uF	50V	B	GRM39B102K50PT	K22174821		1-	B	h1
C 2009	CHIP CAP.	0.01uF	16V	B	GRM36B103K16PT	K22128804		1-	A	B1
C 2010	AL.ELECTRO.CAP.	100uF	16V		ECEV1CA101WP	K48120012		1-	B	g2
C 2011	CHIP CAP.	0.001uF	50V	B	UMK105B102KW-F	K22178829		1-	B	f1
C 2012	CHIP CAP.	0.001uF	50V	B	UMK105B102KW-F	K22178829		1-	A	B1
C 2013	CHIP CAP.	0.1uF	10V	BJ	LMK105BJ104KV-F	K22108806		1-	B	h1
C 2014	CHIP CAP.	0.001uF	50V	B	UMK105B102KW-F	K22178829		1-	B	e1
C 2016	CHIP CAP.	0.01uF	16V	B	GRM36B103K16PT	K22128804		1-	B	e1
C 2017	CHIP CAP.	0.001uF	50V	B	UMK105B102KW-F	K22178829		1-	B	f2
C 2018	CHIP CAP.	1uF	10V	F	GRM39F105Z10PT	K22105001		1-	B	g1
C 2019	CHIP CAP.	0.01uF	16V	B	GRM36B103K16PT	K22128804		1-	B	h2
C 2020	CHIP CAP.	0.1uF	10V	BJ	LMK105BJ104KV-F	K22108806		1-	B	e1
C 2021	CHIP CAP.	390pF	50V	B	UMK105B391KW-F	K22178824		1-	B	f2
C 2022	CHIP CAP.	0.1uF	10V	BJ	LMK105BJ104KV-F	K22108806		1-	B	c1
C 2023	CHIP CAP.	1uF	10V	B	GRM40B105K10PT	K22100802		1-	B	g2
C 2024	CHIP CAP.	0.1uF	10V	BJ	LMK105BJ104KV-F	K22108806		1-	B	f2
C 2025	CHIP CAP.	0.001uF	50V	B	UMK105B102KW-F	K22178829		1-	B	g2
C 2026	CHIP CAP.	0.1uF	10V	BJ	LMK105BJ104KV-F	K22108806		1-	B	f2
C 2027	CHIP CAP.	0.0022uF	50V	B	UMK105B222KW-F	K22178833		1-	B	f2
C 2028	CHIP CAP.	0.001uF	50V	B	UMK105B102KW-F	K22178829		1-	B	e1
C 2029	CHIP CAP.	100pF	50V	CH	UMK105CH101JW-F	K22178282		1-	B	g2
C 2030	CHIP TA.CAP.	10uF	6.3V		TEMSVA0J106M-8R	K78080027		1-	B	d2
C 2031	CHIP CAP.	0.0018uF	50V	B	UMK105B182KW-F	K22178832		1-	B	g2
C 2032	CHIP CAP.	0.1uF	10V	BJ	LMK105BJ104KV-F	K22108806		1-	A	B2
C 2033	CHIP CAP.	0.1uF	10V	BJ	LMK105BJ104KV-F	K22108806		1-	B	g2
C 2034	CHIP CAP.	0.01uF	16V	B	GRM36B103K16PT	K22128804		1-	B	d2
C 2035	CHIP CAP.	0.1uF	10V	BJ	LMK105BJ104KV-F	K22108806		1-	B	g2
C 2036	CHIP CAP.	0.0047uF	25V	B	TMK105B472KW-F	K22148831		1-	B	f2
C 2037	CHIP CAP.	22pF	50V	CH	UMK105CH220JW-F	K22178266		1-	B	g2
C 2038	CHIP CAP.	0.1uF	10V	BJ	LMK105BJ104KV-F	K22108806		1-	B	g2
C 2040	CHIP CAP.	1uF	10V	F	GRM39F105Z10PT	K22105001		1-	B	c1
C 2041	CHIP CAP.	10pF	50V	CH	UMK105CH100DW-F	K22178258		1-	B	d1
C 2042	CHIP CAP.	0.0018uF	50V	B	UMK105B182KW-F	K22178832		1-	A	D1
C 2043	CHIP CAP.	560pF	50V	B	UMK105B561KW-F	K22178826		1-	B	f2
C 2044	CHIP TA.CAP.	0.33uF	16V		TESVSP1C334M-8R	K78120029		1-	B	d2
C 2045	CHIP CAP.	0.22uF	10V	B	GRM39B224K10PT	K22104801		1-	B	d2
C 2046	CHIP CAP.	470pF	50V	B	UMK105B471KW-F	K22178825		1-	B	c2
C 2047	CHIP CAP.	15pF	50V	CH	UMK105CH150JW-F	K22178262		1-	B	c1
C 2048	CHIP CAP.	0.001uF	50V	B	UMK105B102KW-F	K22178829		1-	B	c2
C 2049	CHIP CAP.	47pF	50V	CH	UMK105CH470JW-F	K22178274		1-	B	c1
C 2050	CHIP CAP.	0.01uF	16V	B	GRM36B103K16PT	K22128804		1-	B	c2
C 2051	CHIP CAP.	1uF	10V	B	GRM40B105K10PT	K22100802		1-	B	c2
C 2052	CHIP CAP.	0.1uF	10V	BJ	LMK105BJ104KV-F	K22108806		1-	A	F1
C 2053	CHIP CAP.	470pF	50V	B	UMK105B471KW-F	K22178825		1	B	f2
C 2053	CHIP CAP.	220pF	50V	B	UMK105B221KW-F	K22178821		2-	B	f2
C 2054	CHIP CAP.	680pF	50V	B	UMK105B681KW-F	K22178827		1-	B	c1
C 2055	CHIP CAP.	0.01uF	16V	B	GRM36B103K16PT	K22128804		1-	B	c2
C 2056	CHIP CAP.	0.1uF	10V	BJ	LMK105BJ104KV-F	K22108806		1-	A	E2
C 2057	CHIP CAP.	0.22uF	10V	B	GRM39B224K10PT	K22104801		1-	B	e2
C 2058	CHIP TA.CAP.	1uF	6.3V		TMCP0J105MTR	K78080071		1-	B	c1
C 2059	CHIP TA.CAP.	1uF	6.3V		TMCP0J105MTR	K78080071		1-	B	c1
C 2060	CHIP CAP.	33pF	50V	CH	GRM36CH330J50PT	K22178224		1-	B	d2
C 2061	CHIP CAP.	0.1uF	10V	BJ	LMK105BJ104KV-F	K22108806		1-	B	e2
C 2062	CHIP CAP.	470pF	50V	B	UMK105B471KW-F	K22178825		1-	B	c2
C 2063	CHIP CAP.	0.22uF	10V	B	GRM39B224K10PT	K22104801		1-	B	d2
C 2064	CHIP TA.CAP.	2.2uF	6.3V		TESVSP0J225M-8R	K78080051		1-	B	d2
C 2065	CHIP TA.CAP.	2.2uF	6.3V		TESVSP0J225M-8R	K78080051		1-	B	d2
C 2066	CHIP CAP.	0.001uF	50V	B	UMK105B102KW-F	K22178829		1-	B	d1
C 2067	CHIP TA.CAP.	4.7uF	6.3V		TESVSP0J475M-8R	K78080053		1-	B	d2
C 2068	CHIP CAP.	0.01uF	16V	B	GRM36B103K16PT	K22128804		1-	B	c2
C 2070	CHIP CAP.	0.001uF	50V	B	UMK105B102KW-F	K22178829		1-	B	d1
C 2072	CHIP TA.CAP.	10uF	6.3V		TEMSVA0J106M-8R	K78080027		1-	B	d2
C 2073	CHIP TA.CAP.	10uF	6.3V		TEMSVA0J106M-8R	K78080027		1-	B	e2
C 2074	CHIP TA.CAP.	3.3uF	10V		SKF-1A335M-RP	K78100051		1-	B	c1
C 2075	CHIP TA.CAP.	10uF	6.3V		TEMSVA0J106M-8R	K78080027		1-	B	d2
C 2076	CHIP CAP.	1uF	10V	F	GRM39F105Z10PT	K22105001		1-	B	e2
C 2077	CHIP TA.CAP.	10uF	6.3V		TEMSVA0J106M-8R	K78080027		1-	B	e2

PANEL Unit

Parts List

REF	DESCRIPTION	VALUE	V/W	TOL.	MFR'S DESIG	VXSTD P/N	VERS.	LOT	SIDE	LAY ADR
C 2081	CHIP CAP.	10pF	50V	CH	UMK105CH100DW-F	K22178258		1-	B	d1
C 2083	CHIP CAP.	820pF	50V	B	UMK105B821KW-F	K22178828		1-	B	c1
C 2085	CHIP TA.CAP.	10uF	6.3V		TEMSVAOJ106M-8R	K78080027		1-	B	d2
C 2086	CHIP CAP.	0.01uF	16V	B	GRM36B103K16PT	K22128804		1-	B	c2
C 2087	CHIP CAP.	120pF	50V	CH	UMK105CH121JW-F	K22178284		1-	B	d1
C 2088	CHIP TA.CAP.	22uF	6.3V		TEMSVAOJ226M-8R	K78080047		1-	A	D1
C 2089	CHIP CAP.	120pF	50V	CH	UMK105CH121JW-F	K22178284		1-	B	d1
C 2090	CHIP TA.CAP.	1uF	6.3V		TMCP0J105MTR	K78080071		1-	B	c2
C 2091	CHIP CAP.	1uF	10V	F	GRM39F105Z10PT	K22105001		1-	B	f2
C 2092	CHIP CAP.	18pF	50V	CH	UMK105CH180JW-F	K22178264		1-	B	c1
C 2094	CHIP CAP.	0.1uF	10V	BJ	LMK105BJ104KV-F	K22108806		1-	A	A1
C 2096	CHIP CAP.	1uF	10V	F	GRM39F105Z10PT	K22105001		1-	B	g1
C 2097	CHIP CAP.	0.001uF	50V	B	GRM36B102K50PT	K22178809		1-	B	d2
C 2098	CHIP CAP.	0.001uF	50V	B	UMK105B102KW-F	K22178829		1-	A	E2
C 2100	CHIP CAP.	0.1uF	10V	BJ	LMK105BJ104KV-F	K22108806		1-	B	f1
C 2101	CHIP CAP.	0.1uF	10V	BJ	LMK105BJ104KV-F	K22108806		1-	B	e1
C 2102	CHIP CAP.	0.01uF	16V	B	GRM36B103K16PT	K22128804		1-	B	e1
C 2103	CHIP TA.CAP.	3.3uF	10V		SKF-1A335M-RP	K78100051		1-	B	f1
C 2105	CHIP CAP.	0.01uF	16V	B	GRM36B103K16PT	K22128804		1-	A	F2
C 2106	CHIP CAP.	0.01uF	16V	B	GRM36B103K16PT	K22128804		1-	A	F2
C 2107	CHIP CAP.	0.1uF	10V	BJ	LMK105BJ104KV-F	K22108806		1-	B	e1
C 2108	CHIP CAP.	1uF	10V	F	GRM39F105Z10PT	K22105001		1-	B	c1
C 2109	CHIP TA.CAP.	1uF	6.3V		TMCP0J105MTR	K78080071		1-	A	B2
C 2110	CHIP CAP.	1uF	10V	F	GRM39F105Z10PT	K22105001		1-	B	g2
D 2001	DIODE				DA221 TL	G2070178		1-	B	g2
D 2002	DIODE				DA221 TL	G2070178		1-	B	h2
D 2003	DIODE				DA221 TL	G2070178		1-	A	B1
D 2004	LED				BRPG1211C-TR	G2070654		1-	A	B1
D 2005	DIODE				DA221 TL	G2070178		1-	B	h2
D 2006	LED				TLOU262	G2090763		1-	A	B1
D 2007	DIODE				MA2S111-(TX)	G2070614		1-	A	B1
D 2008	LED				TLOU262	G2090763		1-	A	B1
D 2009	DIODE				DA221 TL	G2070178		1-	B	c2
D 2010	DIODE				MA2S111-(TX)	G2070614		1-	A	B1
D 2011	DIODE				MC2846-T11-1	G2070702		1-	A	A1
D 2012	DIODE				DA221 TL	G2070178		1-	B	h2
D 2013	DIODE				DA221 TL	G2070178		1-	B	d2
D 2014	DIODE				MA2S111-(TX)	G2070614		1-	B	e1
D 2015	DIODE				MA2S111-(TX)	G2070614		1-	A	D2
D 2016	DIODE				MA2S111-(TX)	G2070614		1-	A	C2
D 2017	DIODE				MA2S111-(TX)	G2070614		1-	A	B2
D 2027	DIODE				MA2S111-(TX)	G2070614		1-	A	E1
D 2028	DIODE				MA2S111-(TX)	G2070614		1-	A	E1
D 2029	DIODE				MA2S111-(TX)	G2070614		1-	A	E2
D 2030	DIODE				MA2S111-(TX)	G2070614		1-	A	F2
D 2031	DIODE				MA2S111-(TX)	G2070614		1-	A	G2
D 2032	DIODE				MA2S111-(TX)	G2070614		1-	A	G2
D 2033	DIODE				DA221 TL	G2070178		1-	A	F1
D 2034	DIODE				DA221 TL	G2070178		1-	A	A1
D 2035	SURGE ABSORBER				RCCA-201Q43UA	Q9000755		1-	A	B2
D 2036	DIODE				DA221 TL	G2070178		1-	B	f2
DS2001	LCD				TTR3165UPFDCW	G6090134		1-	A	C1
J 2001	CONNECTOR				R41-2509H	P1090714		1-	A	A2
J 2002	CONNECTOR				AXK6S40535P	P0091209		1-	B	d1
J 2003	CONNECTOR				IL-FPR-36S-VF-E1500	P1091126		1-	B	f1
L 2001	M.RFC	100uH			FLC32T-101J	L1690227		1-	B	e2
L 2002	M.RFC	1uH			LK1608 1R0K-T	L1690687		1-	B	c1
L 2003	M.RFC	1uH			LK1608 1R0K-T	L1690687		1-	B	c1
L 2004	M.RFC	1uH			LK1608 1R0K-T	L1690687		1-	B	c1
L 2005	M.RFC	1uH			LK1608 1R0K-T	L1690687		1-	B	d1
Q 2001	TRANSISTOR				2SC4617 TL R	G3346178R		1-	B	g2
Q 2002	TRANSISTOR				2SC4617 TL R	G3346178R		1-	B	h2
Q 2003	IC				S-80835CNMC-B8U-T2	G1093606		1-	A	B1
Q 2004	TRANSISTOR				2SC4617 TL R	G3346178R		1-	A	B1
Q 2005	TRANSISTOR				2SC4617 TL R	G3346178R		1-	B	h2
Q 2006	IC				NJM78L05UA TE1	G1091325		1-	B	h1
Q 2007	TRANSISTOR				2SC4617 TL R	G3346178R		1-	B	e2
Q 2008	TRANSISTOR				RT1N241M-T11-1	G3070249		1-	B	g1
Q 2009	TRANSISTOR				RT1P441U-T11-1	G3070248		1-	B	h2
Q 2010	TRANSISTOR				RT1N241M-T11-1	G3070249		1-	B	g1
Q 2011	IC				S-93C56AMFN-TB	G1093348		1-	A	B2
Q 2013	IC				LC87F72C8A-F5N19*	G1093185		1-	A	C1
Q 2014	IC				M62364FP 600D	G1093033		1-	B	e1
Q 2015	IC				NJM2902V-TE1	G1091679		1-	B	c2
Q 2016	IC				AK2345(TAPE)	G1093184		1-	B	d1
Q 2017	IC				LA8630M-TE-R	G1093452		1-	B	e2

*: Requires Firmware, CE47, and VPL-1

PANEL Unit

Parts List

REF	DESCRIPTION	VALUE	V/W	TOL.	MFR'S DESIG	VXSTD P/N	VERS.	LOT	SIDE	LAY ADR
Q 2019	TRANSISTOR				PDTC144EE	G3070244		1-	B	d2
Q 2020	TRANSISTOR				2SC4617 TL R	G3346178R		1-	A	E1
Q 2021	IC				NJM2902V-TE1	G1091679		1-	B	c2
Q 2022	IC				NJM2902V-TE1	G1091679		1-	B	f2
Q 2024	IC				BU4066BF-E2	G1092593		1-	A	E1
Q 2025	TRANSISTOR				RT1N241M-T11-1	G3070249		1-	B	g1
R 2001	CHIP RES.	10k	1/16W	5%	RMC1/16S 103JTH	J24189037		1-	B	f2
R 2002	CHIP RES.	47k	1/16W	5%	RMC1/16S 473JTH	J24189045		1-	B	g2
R 2003	CHIP RES.	33k	1/16W	5%	RMC1/16S 333JTH	J24189043		1-	A	B1
R 2004	CHIP RES.	33k	1/16W	5%	RMC1/16S 333JTH	J24189043		1-	A	B1
R 2005	CHIP RES.	10k	1/16W	5%	RMC1/16S 103JTH	J24189037		1-	B	g2
R 2006	CHIP RES.	47k	1/16W	5%	RMC1/16S 473JTH	J24189045		1-	B	h2
R 2007	CHIP RES.	470k	1/16W	5%	RMC1/16S 474JTH	J24189057		1-	A	B1
R 2008	CHIP RES.	180	1/16W	5%	RMC1/16 181JATP	J24185181		1-	B	h1
R 2009	CHIP RES.	470k	1/16W	5%	RMC1/16S 474JTH	J24189057		1-	A	B1
R 2010	CHIP RES.	330	1/16W	5%	RMC1/16 331JATP	J24185331		1-	B	h1
R 2011	CHIP RES.	220k	1/16W	5%	RMC1/16S 224JTH	J24189053		1-	A	B1
R 2012	CHIP RES.	47k	1/16W	5%	RMC1/16S 473JTH	J24189045		1-	B	f2
R 2013	CHIP RES.	10k	1/16W	5%	RMC1/16S 103JTH	J24189037		1-	B	h2
R 2014	CHIP RES.	1M	1/16W	5%	RMC1/16S 105JTH	J24189061		1-	B	f2
R 2015	CHIP RES.	1k	1/16W	5%	RMC1/16 102JATP	J24185102		1-	B	g2
R 2016	CHIP RES.	100k	1/16W	5%	RMC1/16S 104JTH	J24189049		1-	B	e2
R 2017	CHIP RES.	330k	1/16W	5%	RMC1/16S 334JTH	J24189055		1-	A	B1
R 2018	CHIP RES.	82k	1/16W	5%	RMC1/16S 823JTH	J24189048		1-	B	f1
R 2019	CHIP RES.	1k	1/16W	5%	RMC1/16S 102JTH	J24189025		1-	B	g2
R 2020	CHIP RES.	470	1/4W	5%	RMC1/4 471JATP	J24245471		1-	B	h1
R 2021	CHIP RES.	10k	1/16W	5%	RMC1/16S 103JTH	J24189037		1-	A	C2
R 2022	CHIP RES.	1k	1/16W	5%	RMC1/16S 102JTH	J24189025		1-	B	g1
R 2023	CHIP RES.	1k	1/16W	5%	RMC1/16S 102JTH	J24189025		1-	B	h2
R 2024	CHIP RES.	4.7k	1/16W	5%	RMC1/16S 472JTH	J24189033		1-	A	B1
R 2025	CHIP RES.	47k	1/16W	5%	RMC1/16S 473JTH	J24189045		1-	B	h2
R 2026	CHIP RES.	1k	1/16W	5%	RMC1/16S 102JTH	J24189025		1-	B	f2
R 2027	CHIP RES.	1k	1/16W	5%	RMC1/16S 102JTH	J24189025		1-	B	f2
R 2028	CHIP RES.	1k	1/16W	5%	RMC1/16S 102JTH	J24189025		1-	B	e2
R 2029	CHIP RES.	1k	1/16W	5%	RMC1/16S 102JTH	J24189025		1-	B	e2
R 2030	CHIP RES.	1k	1/16W	5%	RMC1/16S 102JTH	J24189025		1-	B	e2
R 2031	CHIP RES.	1k	1/16W	5%	RMC1/16S 102JTH	J24189025		1-	B	e2
R 2032	CHIP RES.	10k	1/16W	5%	RMC1/16S 103JTH	J24189037		1-	A	C2
R 2033	CHIP RES.	10k	1/16W	5%	RMC1/16S 103JTH	J24189037		1-	B	f1
R 2034	CHIP RES.	2.2k	1/16W	5%	RMC1/16S 222JTH	J24189029		1-	B	h2
R 2035	CHIP RES.	0	1/16W	5%	RMC1/16S JPTH	J24189070		1-	B	f2
R 2036	CHIP RES.	220k	1/16W	5%	RMC1/16S 224JTH	J24189053		1-	B	f2
R 2037	CHIP RES.	47k	1/16W	5%	RMC1/16S 473JTH	J24189045		1-	A	C1
R 2038	CHIP RES.	1.8k	1/16W	5%	RMC1/16S 182JTH	J24189028		1-	B	g2
R 2039	CHIP RES.	1k	1/16W	5%	RMC1/16S 102JTH	J24189025		1-	A	C1
R 2040	CHIP RES.	1k	1/16W	5%	RMC1/16S 102JTH	J24189025		1-	A	D1
R 2041	CHIP RES.	82k	1/16W	5%	RMC1/16S 823JTH	J24189048		1-	A	D1
R 2042	CHIP RES.	39k	1/16W	5%	RMC1/16S 393JTH	J24189044		1-	A	D1
R 2043	CHIP RES.	20k	1/16W	0.5%	RR0510R-203-D	J24189150		1-	A	D1
R 2044	CHIP RES.	10k	1/16W	5%	RMC1/16S 103JTH	J24189037		1-	A	D1
R 2046	CHIP RES.	47k	1/16W	5%	RMC1/16S 473JTH	J24189045		1-	A	B1
R 2047	CHIP RES.	47k	1/16W	5%	RMC1/16S 473JTH	J24189045		1-	A	C1
R 2048	CHIP RES.	47k	1/16W	5%	RMC1/16S 473JTH	J24189045		1-	A	C1
R 2049	CHIP RES.	1k	1/16W	5%	RMC1/16S 102JTH	J24189025		1-	A	C1
R 2050	CHIP RES.	4.7k	1/16W	5%	RMC1/16S 472JTH	J24189033		1-	A	A1
R 2051	CHIP RES.	56k	1/16W	5%	RMC1/16S 563JTH	J24189046		1-	B	f2
R 2052	CHIP RES.	100k	1/16W	5%	RMC1/16S 104JTH	J24189049		1-	B	f2
R 2053	CHIP RES.	56k	1/16W	5%	RMC1/16S 563JTH	J24189046		1-	B	f2
R 2054	CHIP RES.	33k	1/16W	5%	RMC1/16S 333JTH	J24189043		1-	B	f2
R 2055	CHIP RES.	100k	1/16W	5%	RMC1/16S 104JTH	J24189049		1-	B	f2
R 2056	CHIP RES.	2.2k	1/16W	5%	RMC1/16S 222JTH	J24189029		1-	B	g2
R 2057	CHIP RES.	100	1/16W	5%	RMC1/16S 101JTH	J24189013		1-	B	f1
R 2058	CHIP RES.	680	1/16W	5%	RMC1/16S 681JTH	J24189023		1-	A	B2
R 2059	CHIP RES.	56k	1/16W	5%	RMC1/16S 563JTH	J24189046		1-	B	d2
R 2060	CHIP RES.	10k	1/16W	5%	RMC1/16S 103JTH	J24189037		1-	B	d2
R 2061	CHIP RES.	330k	1/16W	5%	RMC1/16S 334JTH	J24189055		1	B	g2
R 2061	CHIP RES.	1.5M	1/16W	5%	RMC1/16S 155JTH	J24189063		2-	B	g2
R 2062	CHIP RES.	270k	1/16W	5%	RMC1/16S 274JTH	J24189054		1-	B	g2
R 2063	CHIP RES.	180k	1/16W	5%	RMC1/16S 184JTH	J24189052		1-	B	g2
R 2064	CHIP RES.	10k	1/16W	5%	RMC1/16S 103JTH	J24189037		1-	B	f2
R 2065	CHIP RES.	22k	1/16W	5%	RMC1/16S 223JTH	J24189041		1-	B	g2
R 2066	CHIP RES.	47k	1/16W	5%	RMC1/16S 473JTH	J24189045		1-	B	e1
R 2067	CHIP RES.	680k	1/16W	5%	RMC1/16S 684JTH	J24189059		1-	B	g2
R 2068	CHIP RES.	220k	1/16W	5%	RMC1/16S 224JTH	J24189053		1-	B	d2
R 2069	CHIP RES.	0	1/16W	5%	RMC1/16S JPTH	J24189070		1-	B	f1
R 2070	CHIP RES.	47k	1/16W	5%	RMC1/16S 473JTH	J24189045		1-	B	d1

PANEL Unit

Parts List

REF	DESCRIPTION	VALUE	V/W	TOL.	MFR'S DESIG	VXSTD P/N	VERS.	LOT	SIDE	LAY ADR
R 2071	CHIP RES.	1.5M	1/16W	5%	RMC1/16S 155JTH	J24189063		1-	B	d2
R 2072	CHIP RES.	1.5k	1/16W	5%	RMC1/16S 152JTH	J24189027		1-	A	B2
R 2073	CHIP RES.	1.5k	1/16W	5%	RMC1/16S 152JTH	J24189027		1-	B	c1
R 2074	CHIP RES.	180k	1/16W	5%	RMC1/16S 184JTH	J24189052		1-	B	c1
R 2075	CHIP RES.	100	1/16W	5%	RMC1/16S 101JTH	J24189013		1-	B	e1
R 2076	CHIP RES.	330k	1/16W	5%	RMC1/16S 334JTH	J24189055		1-	B	d1
R 2077	CHIP RES.	150k	1/16W	5%	RMC1/16S 154JTH	J24189051		1-	B	c1
R 2078	CHIP RES.	18k	1/16W	5%	RMC1/16S 183JTH	J24189040		1-	A	D1
R 2079	CHIP RES.	0	1/16W	5%	RMC1/16S JPTH	J24189070		1-	B	d2
R 2080	CHIP RES.	390k	1/16W	5%	RMC1/16S 394JTH	J24189056		1-	B	d2
R 2081	CHIP RES.	470k	1/16W	5%	RMC1/16S 474JTH	J24189057		1-	B	c2
R 2082	CHIP RES.	220k	1/16W	5%	RMC1/16S 224JTH	J24189053		1-	B	d2
R 2083	CHIP RES.	220k	1/16W	5%	RMC1/16S 224JTH	J24189053		1-	B	d2
R 2084	CHIP RES.	33k	1/16W	5%	RMC1/16S 333JTH	J24189043		1-	B	c2
R 2085	CHIP RES.	270k	1/16W	5%	RMC1/16S 274JTH	J24189054		1-	B	c1
R 2086	CHIP RES.	0	1/16W	5%	RMC1/16S JPTH	J24189070		1-	B	d2
R 2087	CHIP RES.	100k	1/16W	5%	RMC1/16S 104JTH	J24189049		1-	B	c1
R 2088	CHIP RES.	150k	1/16W	5%	RMC1/16S 154JTH	J24189051		1-	B	c2
R 2089	CHIP RES.	100k	1/16W	5%	RMC1/16S 104JTH	J24189049		1-	B	f2
R 2090	CHIP RES.	68k	1/16W	5%	RMC1/16S 683JTH	J24189047		1-	B	c2
R 2091	CHIP RES.	47k	1/16W	5%	RMC1/16S 473JTH	J24189045		1-	B	f2
R 2092	CHIP RES.	220k	1/16W	5%	RMC1/16S 224JTH	J24189053		1-	B	c2
R 2093	CHIP RES.	390k	1/16W	5%	RMC1/16S 394JTH	J24189056		1-	B	c1
R 2094	CHIP RES.	68k	1/16W	5%	RMC1/16S 683JTH	J24189047		1-	B	d1
R 2096	CHIP RES.	220k	1/16W	5%	RMC1/16S 224JTH	J24189053		1-	B	c2
R 2097	CHIP RES.	47k	1/16W	5%	RMC1/16S 473JTH	J24189045		1-	B	f2
R 2098	CHIP RES.	3.9k	1/16W	5%	RMC1/16S 392JTH	J24189032		1-	B	c1
R 2099	CHIP RES.	1k	1/16W	5%	RMC1/16S 102JTH	J24189025		1-	A	B1
R 2100	CHIP RES.	100k	1/16W	5%	RMC1/16S 104JTH	J24189049		1-	B	d1
R 2101	CHIP RES.	1k	1/16W	5%	RMC1/16S 102JTH	J24189025		1-	A	C1
R 2102	CHIP RES.	150k	1/16W	5%	RMC1/16S 154JTH	J24189051		1-	B	c1
R 2103	CHIP RES.	220k	1/16W	5%	RMC1/16S 224JTH	J24189053		1-	B	d2
R 2104	CHIP RES.	22k	1/16W	5%	RMC1/16S 223JTH	J24189041		1-	B	c1
R 2105	CHIP RES.	47k	1/16W	5%	RMC1/16S 473JTH	J24189045		1-	B	d1
R 2106	CHIP RES.	220k	1/16W	5%	RMC1/16S 224JTH	J24189053		1-	B	d1
R 2107	CHIP RES.	560k	1/16W	5%	RMC1/16S 564JTH	J24189058		1-	B	c2
R 2108	CHIP RES.	47k	1/16W	5%	RMC1/16S 473JTH	J24189045		1-	A	D2
R 2109	CHIP RES.	47k	1/16W	5%	RMC1/16S 473JTH	J24189045		1-	B	d1
R 2110	CHIP RES.	1.2M	1/16W	5%	RMC1/16S 125JTH	J24189062		1-	B	d2
R 2111	CHIP RES.	150k	1/16W	5%	RMC1/16S 154JTH	J24189051		1-	B	c2
R 2112	CHIP RES.	47k	1/16W	5%	RMC1/16S 473JTH	J24189045		1-	B	e2
R 2113	CHIP RES.	220k	1/16W	5%	RMC1/16S 224JTH	J24189053		1-	B	c2
R 2114	CHIP RES.	15k	1/16W	5%	RMC1/16S 153JTH	J24189039		1-	B	c1
R 2115	CHIP RES.	18k	1/16W	5%	RMC1/16S 183JTH	J24189040		1-	A	E1
R 2117	CHIP RES.	33k	1/16W	5%	RMC1/16S 333JTH	J24189043		1-	A	E1
R 2118	CHIP RES.	680k	1/16W	5%	RMC1/16S 684JTH	J24189059		1-	B	d2
R 2119	CHIP RES.	4.7k	1/16W	5%	RMC1/16S 472JTH	J24189033		1-	A	F1
R 2120	CHIP RES.	10k	1/16W	5%	RMC1/16S 103JTH	J24189037		1-	A	E1
R 2121	CHIP RES.	100k	1/16W	5%	RMC1/16S 104JTH	J24189049		1-	B	c1
R 2122	CHIP RES.	47k	1/16W	5%	RMC1/16S 473JTH	J24189045		1-	A	E2
R 2123	CHIP RES.	0	1/16W	5%	RMC1/16S JPTH	J24189070		1-	B	e1
R 2124	CHIP RES.	1k	1/16W	5%	RMC1/16S 102JTH	J24189025		1-	B	f1
R 2125	CHIP RES.	10k	1/16W	5%	RMC1/16S 103JTH	J24189037		1-	A	D1
R 2127	CHIP RES.	1k	1/16W	5%	RMC1/16S 102JTH	J24189025		1-	B	f2
R 2128	CHIP RES.	220k	1/16W	5%	RMC1/16S 224JTH	J24189053		1-	B	c2
R 2129	CHIP RES.	82k	1/16W	5%	RMC1/16S 823JTH	J24189048		1-	B	d1
R 2130	CHIP RES.	120k	1/16W	5%	RMC1/16S 124JTH	J24189050		1-	B	d1
R 2131	CHIP RES.	33k	1/16W	5%	RMC1/16S 333JTH	J24189043		1-	B	c2
R 2132	CHIP RES.	0	1/16W	5%	RMC1/16S JPTH	J24189070		1-	B	c2
R 2133	CHIP RES.	4.7k	1/16W	5%	RMC1/16S 472JTH	J24189033		1-	A	A1
R 2134	CHIP RES.	150k	1/16W	5%	RMC1/16S 154JTH	J24189051		1-	A	E2
R 2135	CHIP RES.	56k	1/16W	5%	RMC1/16S 563JTH	J24189046		1-	B	d2
R 2137	CHIP RES.	150k	1/16W	5%	RMC1/16S 154JTH	J24189051		1-	B	c1
R 2141	CHIP RES.	47k	1/16W	5%	RMC1/16S 473JTH	J24189045		1-	A	B1
R 2143	CHIP RES.	330k	1/16W	5%	RMC1/16S 334JTH	J24189055		1-	B	e1
R 2144	CHIP RES.	10k	1/16W	5%	RMC1/16S 103JTH	J24189037		1-	B	f2
R 2145	CHIP RES.	220k	1/16W	5%	RMC1/16S 224JTH	J24189053		1-	B	e1
R 2151	CHIP RES.	1.5k	1/16W	5%	RMC1/16S 152JTH	J24189027		1-	B	f2
R 2152	CHIP RES.	0	1/16W	5%	RMC1/16 000JATP	J24185000		1-	B	g2
R 2153	CHIP RES.	470k	1/16W	5%	RMC1/16S 474JTH	J24189057		1-	A	B2
R 2154	CHIP RES.	10	1/16W	5%	RMC1/16S 100JTH	J24189001		1-	B	d2
R 2155	CHIP RES.	0	1/16W	5%	RMC1/16 000JATP	J24185000		1-	B	e1
R 2156	CHIP RES.	10k	1/16W	5%	RMC1/16S 103JTH	J24189037		1-	A	E2
R 2159	CHIP RES.	10k	1/16W	5%	RMC1/16S 103JTH	J24189037		1-	A	E2
R 2160	CHIP RES.	330k	1/16W	5%	RMC1/16S 334JTH	J24189055		1-	A	F2
R 2161	CHIP RES.	120k	1/16W	5%	RMC1/16S 124JTH	J24189050		1-	A	F2

PANEL Unit

Parts List

REF	DESCRIPTION	VALUE	V/W	TOL.	MFR'S DESIG	VXSTD P/N	VERS.	LOT	SIDE	LAY ADR
R 2162	CHIP RES.	82k	1/16W	5%	RMC1/16S 823JTH	J24189048		1-	A	E2
R 2163	CHIP RES.	220	1/16W	5%	RMC1/16S 221JTH	J24189017		1-	B	f1
R 2164	CHIP RES.	100k	1/16W	5%	RMC1/16S 104JTH	J24189049		1-	B	g2
R 2168	CHIP RES.	0	1/16W	5%	RMC1/16S JPTH	J24189070		1-	B	d1
R 2169	CHIP RES.	0	1/16W	5%	RMC1/16 000JATP	J24185000		1-	B	e1
R 2170	CHIP RES.	1k	1/16W	5%	RMC1/16S 102JTH	J24189025		1-	A	C2
R 2172	CHIP RES.	0	1/16W	5%	RMC1/16S JPTH	J24189070		1-	B	e1
R 2173	CHIP RES.	0	1/16W	5%	RMC1/16S JPTH	J24189070		1-	B	e1
R 2176	CHIP RES.	0	1/16W	5%	RMC1/16S JPTH	J24189070		1-	B	d1
R 2181	CHIP RES.	1M	1/16W	5%	RMC1/16S 105JTH	J24189061		1-	B	e2
S 2001	TACT SWITCH				SKQMAQE010	N5090121		1-	A	B2
S 2002	TACT SWITCH				SKQMAQE010	N5090121		1-	A	C2
S 2003	TACT SWITCH				SKQMAQE010	N5090121		1-	A	D2
S 2004	TACT SWITCH				SKQMAQE010	N5090121		1-	A	E1
S 2005	TACT SWITCH				SKQMAQE010	N5090121		1-	A	E1
S 2006	TACT SWITCH				SKQMAQE010	N5090121		1-	A	E2
S 2007	TACT SWITCH				SKQMAQE010	N5090121		1-	A	F2
S 2008	TACT SWITCH				SKQMAQE010	N5090121		1-	A	G2
S 2009	TACT SWITCH				SKQMAQE010	N5090121		1-	A	H2
VR2001	POT.				V12M4-20A20K-1	J60800260		1-	A	A1
X 2001	XTAL SX-2204	3.6864MHz			3.6864MHZ	H0103249		1-	B	e2
	LCD HOLDER				(LCD)	RA0377100		1-		
	LIGHT GUIDE					RA0376600		1-		
	REFLECTOR SHEET					RA0381800		1-		
	DIFFUSER SHEET					RA0013600		1-		
	RUBBER CONNECTOR					RA0383700		1-		
	SPONGE RUBBER				(IC)	RA0384100		1-		
	LED SPACER				LH-5-5	S6000238		1-		
	BLIND SHEET				(4X3)	RA0405200		1-		

PANEL Unit

Note



Copyright 2003
VERTEX STANDARD CO., LTD.
All rights reserved.

No portion of this manual
may be reproduced
without the permission of
VERTEX STANDARD CO., LTD.