

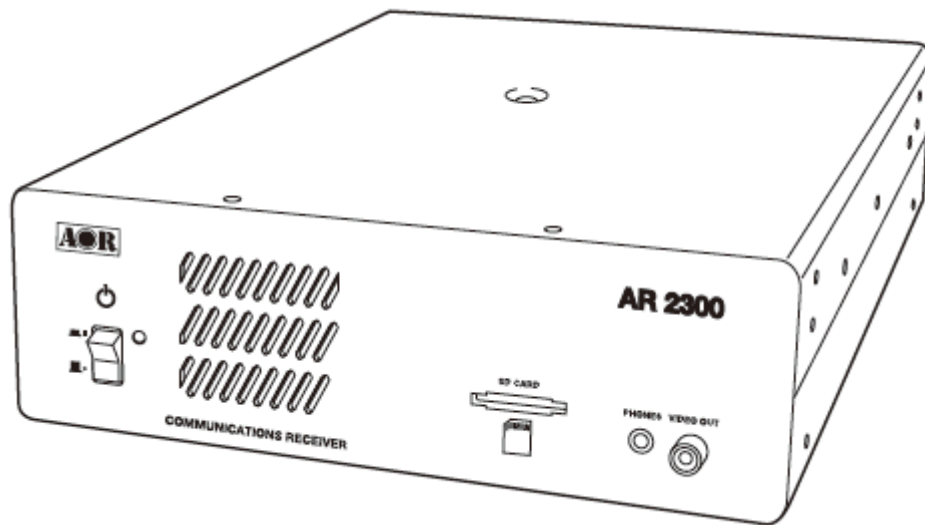

AR2300

Black-Box Receiver



Operating manual

AOR, LTD.

Table of contents

1.	Introduction -----	5
	1-1 Introduction -----	5
	1-2 Caring for your radio -----	7
	1-3 Included in this package -----	8
	1-4 Front panel -----	12
	1-5 Rear -----	13
2.	PC control -----	14
	2-1 System requirements -----	14
	2-2 USB (Universal Serial Bus) -----	14
	2-2-1 USB Driver installation -----	14
	2-3 AR2300 control software installation -----	17
	2-3-1 Starting the program -----	17
	2-3-2 In case of difficulty -----	18
	2-4 LAN (optional) -----	19
3.	Control commands -----	20
	3-1 Command format -----	20
	3-2 Response format -----	20
	3-3 Power on the AR2300 -----	21
	3-3-1 Wake up -----	21
	3-3-2 Wake up ID set up -----	21
	3-4 Power off the AR2300 -----	21
	3-4-1 Standby mode -----	21
	3-4-2 Sleep timer -----	21
	3-5 Audio gain -----	21
	3-6 Frequency/memory channel up/down -----	21
	3-7 Step frequency -----	21
	3-8 Receive modes, IF bandwidth, AUTO mode -----	22
	3-8-1 Command description -----	22
	3-8-2 Simple mode -----	22
	3-8-3 Advanced mode -----	22
	3-8-4 Auto mode -----	23
	3-8-5 Destination setting -----	23
	3-9 Decode assist function -----	23
	3-9-1 Auto notch (Notch) -----	23
	3-9-2 Noise reduction (NR) -----	24
	3-9-3 Noise blanker (NB) -----	24
	3-9-4 Voice inversion descrambler -----	24
	3-9-5 IF shift -----	24
	3-9-6 CW pitch frequency -----	25

3-9-7	Automatic gain control (AGC)	-----	25
3-9-8	Automatic frequency control (AFC)	-----	25
3-9-9	Tone squelch (CTCSS)	-----	25
3-9-10	Digital code squelch (DCS)	-----	26
3-9-11	DTMF code	-----	26
3-9-12	De-emphasis	-----	26
3-10	Squelch	-----	27
3-10-1	Level squelch	-----	27
3-10-2	Voice squelch	-----	27
3-11	RF amplifier, attenuator	-----	27
3-12	Antenna select	-----	27
3-12-1	Antenna select programming	-----	28
3-13	S-meter	-----	28
3-13-1	Signal level	-----	28
3-13-2	Auto signal level	-----	29
3-14	Audio recorder control	-----	29
3-14-1	Control relay status	-----	29
3-14-2	Control relay status report	-----	29
3-15	Manual RF gain	-----	29
3-16	RF filter bandwidth for A/D converter	-----	30
3-17	RF band pass filter (for below 25MHz reception)	-----	30
4.	Receive commands	-----	30
4-1	VFO mode	-----	30
4-2	Search mode (normal search mode)	-----	31
4-2-1	Search bank	-----	31
4-2-2	Pass frequency	-----	32
4-2-3	Normal search setting format	-----	33
4-2-4	Search frequency list	-----	33
4-3	FFT Search	-----	33
4-4	Memory Channel	-----	34
4-4-1	Memory read mode	-----	34
4-4-2	Memory data setting	-----	35
4-4-3	Memory bank resizing	-----	35
4-4-4	Delete memory channel	-----	35
4-4-5	Delete memory bank	-----	36
4-5	Scan	-----	36
4-5-1	Start scan	-----	36
4-5-2	Memory data setting	-----	36
4-5-3	Memory pass	-----	36
4-6	Select scan	-----	37

	4-6-1	Start select scan	-----	37
	4-6-2	Select scan setting	-----	37
4-7		Duo frequency / tri frequency receive	-----	37
	4-7-1	Duo frequency receive (duo band receive)	-----	37
	4-7-2	Duo frequency receive (frequency offset receive mode)	-----	38
	4-7-3	Tri frequency receive	-----	39
5		Other receive commands	-----	39
	5-1	Priority receive	-----	39
		5-1-1 Priority setup	-----	39
		5-1-2 Starting priority	-----	39
	5-2	Step adjust	-----	40
6		Spectrum display commands	-----	40
	6-1	Start frequency	-----	40
	6-2	End frequency	-----	40
	6-3	Center frequency	-----	40
	6-4	Span frequency	-----	40
	6-5	Spectrum step frequency	-----	40
	6-6	Marker frequency	-----	41
		6-6-1 Marker frequency setup	-----	41
		6-6-2 Marker frequency / level auto output	-----	41
		6-6-3 Transfer the marker frequency to receive frequency	-----	41
	6-7	Spectrum data output	-----	41
	6-8	High speed spectrum data output	-----	41
7		Video monitor commands	-----	42
	7-1	Activate the video monitor function	-----	42
	7-2	Frequency shift reverse	-----	42
8		I/Q output commands	-----	42
	8-1	I/Q bandwidth	-----	42
9		Data editor commands	-----	43
10		Configuration commands of other parameters	-----	44
	10-1	Selecting interface	-----	44
	10-2	Communication speed	-----	44
	10-3	Flow control	-----	44
11		LAN (Local Area Network) control commands	-----	45
	11-1	Readout settings from the optional LAN-box	-----	45
	11-2	Write settings to the LAN-box	-----	45
	11-3	IPv4 address	-----	45
	11-4	Mask address	-----	45
	11-5	Gateway address	-----	45
	11-6	DHCP client function	-----	46

11-7	PING response	-----	46
11-8	TCP port number	-----	46
11-9	UDP port number	-----	46
11-10	MAC address	-----	46
11-11	Username	-----	46
11-12	Password	-----	47
12	SD (SDHC) card commands	-----	47
12-1	Property of SD card	-----	47
12-2	Display file directory	-----	47
12-3	Delete data file	-----	47
12-4	Format card	-----	47
12-5	Write data to SD card	-----	47
12-6	Read data from SD card	-----	47
12-7	Squelch skip	-----	48
12-8	Start/Stop recording	-----	48
12-9	Start/Stop playback	-----	48
12-10	Recording status	-----	48
13	Other control commands	-----	49
13-1	Receiver status	-----	49
	13-1-1 Receiver status	-----	49
	13-1-2 Receiver status auto report	-----	49
13-2	Product version	-----	49
13-3	Reset	-----	50
13-4	Flash memory	-----	50
14.	Specifications	-----	51
15.	I/Q digital output in details for developers	-----	52
16.	Reset	-----	58
17.	Firmware upgrade	-----	59
18.	Optional accessories	-----	62
19.	Limited warranty (USA only)	-----	64

1. Introduction

1-1 Introduction

Thank you for purchasing the AR2300 Digital Processing Communications receiver.

As the successor to the SR2200 “black box” receiver, the AR2300 is designed using the very latest technology to ensure the highest levels of performance and reliability. To obtain the best possible results from your AR2300, we strongly recommend that you read this manual and familiarize yourself with the receiver.

Although carefully designed, this receiver (like all receivers) suffers from a degree of internal noises known as spurious emission. They are a product of the receiver’s circuitry, and therefore, their presence does not represent a problem. Other apparent problems may be due to accidental misoperation of the receiver. If you believe there is a problem, carefully read the manual before deciding to contact your dealer for advice or service.

It is acknowledged that sections of this manual are repetitive, this is to enable the manual to be used as a reference book.

Every effort has been made to make this manual correct and up to date. Due to continuous development of the receiver, errors or omission anomalies may be found in the manual and this is acknowledged.

© This manual is protected by copyright AOR, LTD. 2011. No information contained in this manual may be copied or transferred by any means without the prior written consent of AOR, LTD. AOR and the AOR logo are trademarks of AOR, LTD. All other trademarks and names are acknowledged.

Main features:

- Wide frequency coverage: 40kHz to 3.15 GHz, with no interruptions (cellular blocked for US consumer version)
- PC controllable
- DDS (direct digital synthesizer) local oscillator
- Analog TV reception in both NTSC and PAL formats
- IF signal output (45.05MHz, +/- 7.5MHz for a total of 15MHz bandwidth) 25MHz to 3.15GHz only.
- Multi-mode unit capable of receiving AM (synchronous), ISB, USB, LSB, CW, AIQ (AF-IQ), WFM including FM stereo (optional headphone or stereo speakers required), NFM and APCO25 digital (optional)
- Composite video output on the front panel of the unit
- SD/SDHC card interface
- Selectable IF bandwidths: 200Hz, 500Hz, 1kHz, 3kHz, 6kHz, 15kHz, 30kHz, 100kHz, and 200 kHz along with the ability to shift the IF
- CTCSS and DCS selectable squelch functions
- DTMF tone decode
- Built-in voice-inversion descrambling (Not available for the US consumer version)
- CW pitch control, AGC, AFC
- Auto-notch, noise reduction (NR), noise blanker (NB) features
- Fast Fourier Transform (FFT) analyzer for fast spectrum display processing
- 12kHz I/Q output for DRM PC receiver
- USB 2.0 interface
- Two antenna ports (type N)
- Five VFO's, 2,000 alphanumeric memories
- Trio frequency receive (receive 3 frequencies simultaneously)
- Digital voice recording (requires SD or SDHC card)
- I/Q output with 1MHz bandwidth (optional) 25MHz to 3.15GHz only
- Frequency coherent (with optional GPS receiver unit)
- LAN (Local Area Network) control (with optional LAN interface)

1-2 Caring for your radio

There are no internal operator adjustments. In the unlikely event of service being required, please contact your dealer for technical assistance.

Do not use or leave the receiver in direct sunlight. It is best to avoid locations where excessive heat, humidity, dust and vibration are present. Always keep the AR2300 free from dust and moisture. Use a soft, dry cloth to gently wipe external surfaces clean, never use abrasive cleaners or organic solvents which may damage certain parts.

Treat the AR2300 with care, avoid spilling or leaking liquids into the receiver and associated power supply. Special care should be taken to avoid liquid entering the area around the controls, through the speaker grill or via the connection jacks.

The AR2300 is designed for operation from a good quality regulated DC power supply of 12 to 14 V, which should be capable of supplying 2 A. Never connect the AR2300 directly to an AC power outlet.

The polarity of the DC input jack is clearly marked, the chassis of the receiver is at negative ground.

SAFETY NOTICE – Always disconnect the power supply from the AC outlet when the receiver is not in use. If used mobile, it should be noted that the AR2300 has NOT been manufactured or tested to meet any specific mobile safety requirements.

The AR2300 has no user adjustable internal parts.

If using the AR2300 as a base station, the best short wave reception is usually achieved through the use of a separate external earth (or ground) rod,. However, consider the implications carefully if your AC building supply uses a Protective Multiple Earth (PME) system. If in doubt, consult a qualified electrician. Never earth (ground) to a gas pipe!

The AR2300 has two antenna connectors. These are intended for connection to a 50 Ω (unbalanced) coaxial fed antenna such as a discone, dipole, unipole, Yagi, etc.

When installing an antenna, avoid power cables. Ensure that you do not confuse the antenna and the IF output connector as they are located close to each other.

1-3 Included in this package

The following items are provided in this package:

- One AR2300 receiver

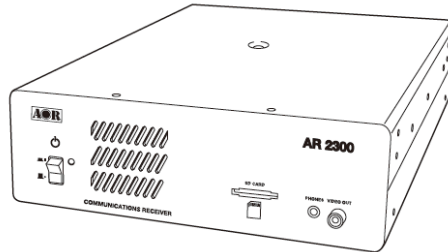

- One AC power adapter

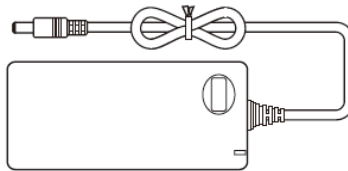

- One operating manual (this booklet)
- One CD disk (contains Windows® based control software, USB driver, firmware update program, manual in pdf format)
- One USB cable

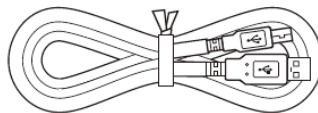

- One 2GB SD card (The supplied card does not need to be formatted. If you really need to format this or another card, please insert the card in the AR2300 receiver and use the supplied control software to format, as explained in chapter 12-4.

Formatting through Windows by using a common card reader can lead to recording data errors!

Terminology

Search & Scan

If you have not used a wide band receiver before or are not familiar with the terminology used, it is very important to understand the difference between **SEARCH** and **SCAN** modes.

SEARCH: The AR2300 provides several operations where transmissions (active frequencies) may be automatically located by sweeping the receiver over a wide frequency range, either from the currently displayed frequency traveling upwards (or downwards) in a specified tuning increment (step) or by sweeping over-and-over between two specified frequency limits. This process is known as **SEARCHING**, as the name implies, can take a long time to find transmissions due to their 'often intermittent' and brief nature. For this reason, it is best to slice large frequency ranges into smaller, more manageable pieces where they may be intensely monitored.

When examining large frequency segments, it is common to find that 90% of the frequencies are inactive and only a small number of the remaining constitute what you really want. Searching still remains the best way to initially locate active and interesting transmissions (in conjunction with a good frequency listing and band plan).

SCAN: Once active transmissions have been identified (either by searching or by using a good frequency guide), it is more efficient to store the data into memories which can be rapidly and automatically monitored in succession, stopping when activity is encountered. This is a much more efficient means of monitoring the most wanted frequencies as you have targeted 100% of what you most want to hear.

By contrast, searching is very inefficient for day-to-day monitoring.

Note: For the search & scan functions to operate properly, it is very important to advance the squelch to cancel background noise. This is because the AR2300 believes that it has found an active frequency when the squelch opens. Advance the squelch control until the background noise is just cancelled, this is known as the "threshold" position. If the squelch control is advanced too far, weaker signals may be missed.

More details about the remarkable features of the AR2300

High frequency (45.05MHz) IF output (25MHz to 3.15GHz only)

The AR2300 has a 45.05MHz IF output with 15MHz bandwidth. The input signal to the 45.05MHz IF stage is directly sent to the A/D converter for digital processing. This IF output signal may be suitable as an RF front end for radio signal analysis applications. By utilizing this feature, no image signal will be present. With an optional interface unit, a USB 2.0 interface digital I/Q output (25MHz to 3.15GHz only) is also available. The raw data of the I/Q output may be recorded on a PC for future analysis.

High Stability Frequency Standard

When a GPS receiver is connected, the internal reference oscillator (10MHz) will be locked by the GPS receiver, and the highest stability reference signal (0.01ppm) will be obtained. This is ideal for frequency coherent operation and DF (Direction Finding) applications.

DDS (Direct Digital Synthesizer)

The AR2300 uses a high speed DDS for the 1st local oscillator. Unlike a standard PLL (Phased Locked Loop) circuit for the local oscillator, the DDS enables very high speed scanning as it generates signals instantaneously, controlled by the CPU (Micro Processor).

I/Q Digital Output (25MHz to 3.15GHz only)

The I/Q stands for In-Phase/Quadrature -Phase.

In the 45.05MHz IF stage, an I/Q output is available as an optional feature. The I/Q digital signal consists of two (2) different digital signals with phases shifted 90 degrees.

The I/Q output is provided through a continuously isochronous USB 2.0 standard interface.

By using the I/Q digital output, the streamed data can be stored on a PC hard disk for future signal analysis.

The I/Q digital output of the AR2300 has a wide dynamic range (without AGC processing) floating point data format.

FFT (Fast Fourier Transform)

The AR2300 utilizes FFT (Fast Fourier Transform) technology for high speed spectrum scanning.

FFT enables refreshment of the spectrum display more than 10 times per second for a 10MHz span (at 500Hz RBW). The AR2300 scans a span up to 10MHz (+/- 5MHz from the center frequency.).

LAN (Local Area Network) connection

When an optional (external) LAN interface is connected, the AR2300 can be remotely controlled through the internet.

Triple frequency reception (Receive 3 frequencies simultaneously)

- Set two separate frequencies above 25MHz as a main band, separated by maximum +/-5MHz.
- Set another frequency below 25MHz as a sub band.

Receive mode / additional features

WFM (Wide FM)

- Stereo sound (auto detected), Selectable de-emphasis 50 uS/75 uS
- Stereo output is from the 3.5mm stereo jack on the front panel. (Optional stereo headphones or speakers required to monitor stereo transmissions.)

NFM (Narrow FM)

- Built-in DCS (Digital Coded Squelch)
- Built-in CTCSS (Continuous Tone Coded Squelch System)
- Built-in Voice Inversion Descrambler (2,000Hz ~ 7,000Hz in 50Hz step) (Not available on US consumer version)
- APCO25 (P-25) decode (with optional APCO25 board) (conventional non-encrypted mode only)
- Built-in AFC (Automatic Frequency Control)

AM (Amplitude Modulation)

- Envelope Detection (Normal AM decoder)
- Synchronous Detection
 1. DSB (Double Side Band) synchronous
 2. SSB (Single Side Band) USB/LSB (Upper Side Band/Lower Side Band) selectable synchronous
- AGC (Automatic Gain Control) mode/Manual RF gain mode

SSB (Single Side Band)

- USB/LSB selectable
- AGC mode/Manual RF gain mode

ISB (Independent Side Band)

- Simultaneously decoded LSB and USB (stereo output)
- AGC mode/Manual RF gain mode

CW (Continuous Wave)

- Built-in narrow band IF filter 200Hz/500Hz
- Adjustable tone pitch 300 ~ 900Hz (50Hz step)

NB (Noise Blanker)

- Operates in AM, SSB, and ISB modes

Auto Notch Filter

- Effective to suppress a cyclic noise signal.

IF Shift

- Operates in SSB, AM, and CW mode.
- Shift width: -1200Hz ~ +1200Hz (50Hz step)

Selectable Squelch mode

- VSQ (Voice Squelch) or LSQ (Level Squelch) can be selected.

DVR (Digital Voice Recorder)

- Received audio can be recorded on an optional SD/SDHC card in WAV format. (Max.2GB file size per recording)

Analog output for DRM (Digital Radio Mondiale)

- 12kHz IF (I/Q) analog output for DRM PC receiver

1-4 Front panel

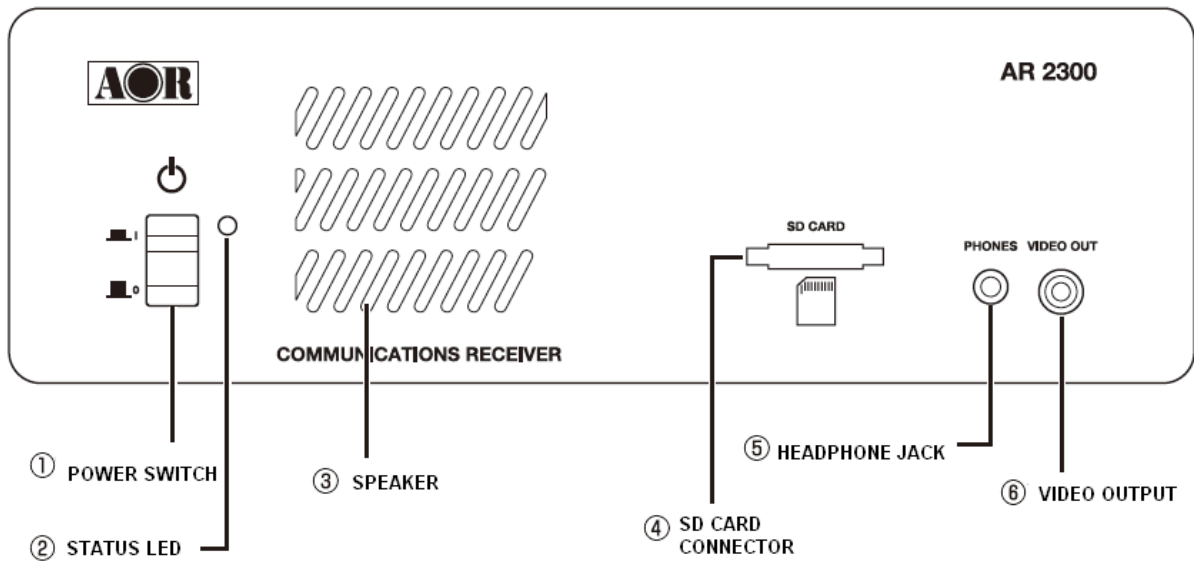

1. Power On/Off switch
2. Status LED indicator (Green: Power on, orange: Stand by, not lit : Off)
3. Speaker
4. SD/SDHC card connector
5. Stereo headphone jack (3.5mm stereo type)

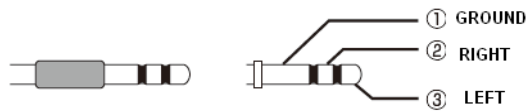

6. Video Output jack (RCA type : 75Ω, 1V p-p)

1-5 Rear panel

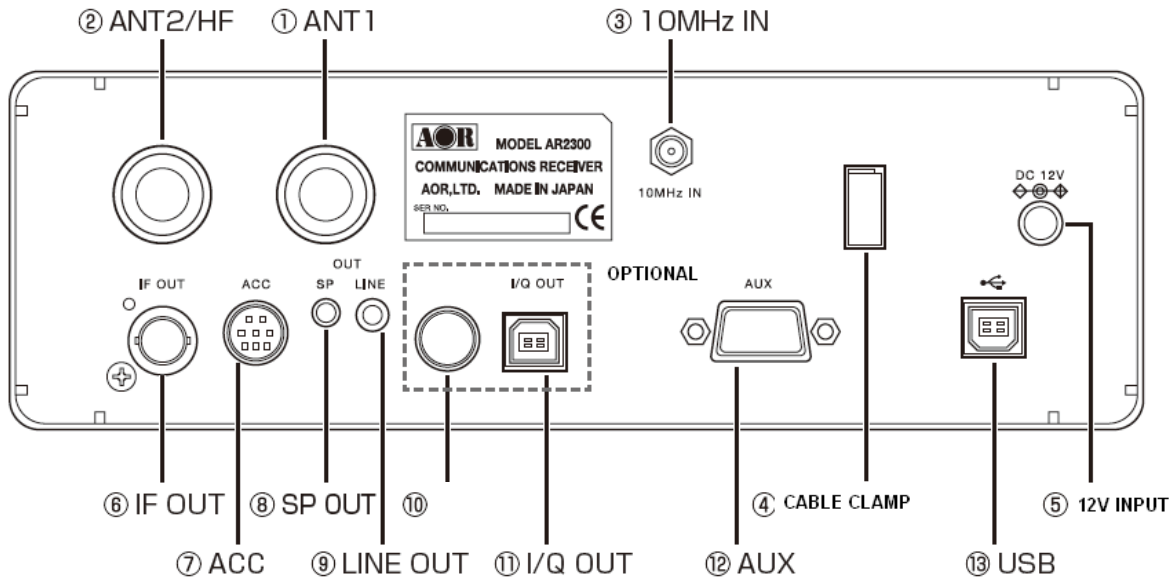

1. Antenna connector 1 (N type) for above 25MHz
2. Antenna connector 2 (N type) for all frequencies
3. External 10MHz reference signal input connector (SMA type) (2dBm +/- 2dB)
4. Cable clamp
5. Power input connector (10.7~16V DC, 2A @ 12V)
6. 45.05MHz IF output connector (BNC type) (25MHz to 3.15GHz only)
7. ACC (Accessory) connector

Pin #	Description	Pin #	Description
1	12V DC output (30mA max.)	5	Control 2
2	Detector output	6	GPS 1 second input
3	Audio input	7	Audio output (2.5mV/600Ω)
4	Control 1	8	Ground

When a GPS receiver is connected, the internal reference oscillator (10MHz) will be locked by the GPS receiver, and the highest stability reference signal (0.01ppm) will be obtained. This is ideal for frequency coherent operation and DF (Direction Finding) applications.

8. External speaker output connector (3.5mm monaural)
9. Line output connector (3.5mm stereo, -10dBm/600Ω). Can be selected as 12kHz I/Q output
10. N/A (for future use)
11. I/Q output connector (Optional, USB type B connector) (25MHz to 3.15GHz only)
12. AUX (Auxiliary connector) Interface for an optional LAN interface
13. USB connector (USB type B connector)

2. PC CONTROL

2-1 System requirements

Hardware:

- PC with 2GHz Dual Core CPU, 1GB RAM
- USB Port (USB 2.0)
- 16 bit AC-97 compatible audio board
- 1024 x 768 (minimum) resolution video board and monitor
- 2 button mouse with wheel
- CD-ROM drive

Operating System:

Windows® 2000 SP4, XP SP2 (32 bit version), Vista or Windows 7.

2-2 USB (Universal Interface Bus)

The USB (type B) connector is designed to connect directly to the USB port of a PC.

All functions of the AR2300 can be controlled by a PC by means of the USB interface using either the supplied AOR control software, or a terminal software.

2-2-1 USB driver installation

To control AR2300 with a PC, the USB driver for the AR2300 needs to be installed.

For your convenience, the USB driver is included on the supplied CD program disk.

To avoid any driver conflict, please UNINSTALL ANY OLDER VERSION OF THE VCP DRIVER.

To check if you have such a driver already in your system, go to START > CONTROL PANEL > ADD OR REMOVE PROGRAMS > search for “Windows driver package – FTDI CDM Driver Package”

If you wish to obtain the latest version of the driver, you can download from the manufacturer’s website.

<http://www.ftdichip.com/ftdrivers.htm>

Click “VCP Drivers”, then select the device name “FT232B”.

1. Place the supplied driver CD into your CD drive.
2. Plug the supplied AC adapter into the DC power input connector of the AR2300. Connect the AC adapter to an electrical outlet and then turn on the power switch.
3. Plug the square end of the USB cable (supplied) into the USB connector on the rear panel of the AR2300.
4. Plug the other end of the USB cable into an available USB port on the PC.
5. The new hardware is found and starts the installation procedure.

Note: Sample screen instructions or messages shown may differ depending the version of Windows® operating system of your PC.



6. Check the “No, not this time” and click “Next”.



7. Check the “Install from a list or specific location [Advanced]” and click “Next”.

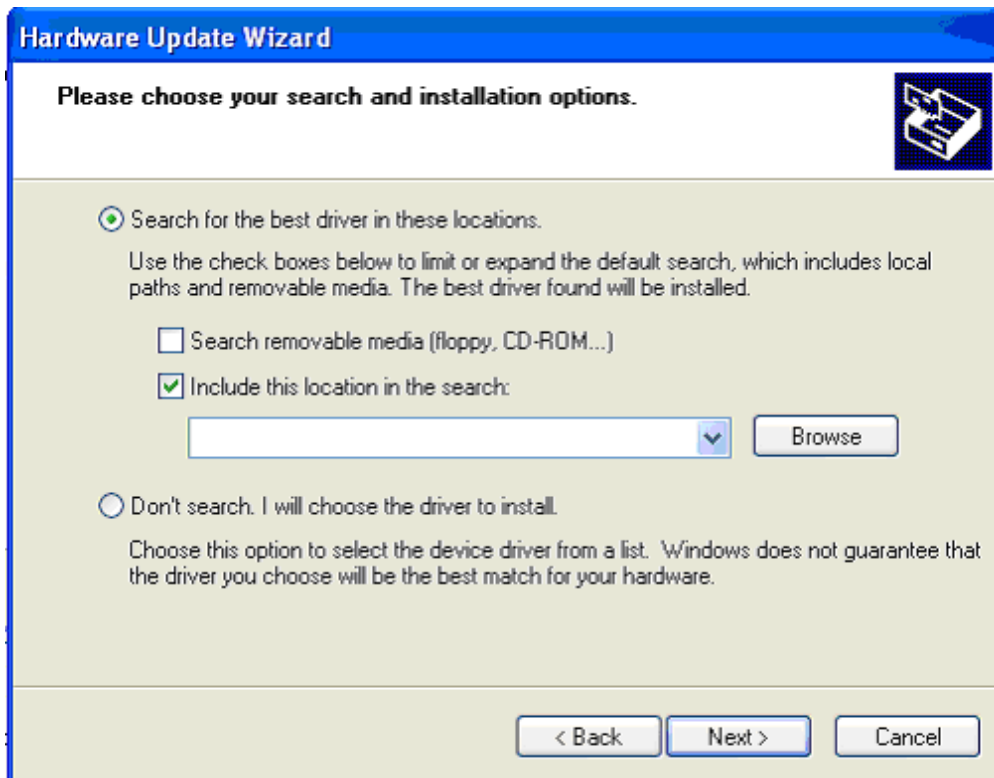

8. Check the “Search for the best driver in these locations.”, “Include this location in the search:”.

Select the path “D:\USB DRIVER” (or change the letter “D” with the one of the CD-ROM drive where the CD-ROM is located.)

If you download the driver, select the folder you copied.

9. Click “Next”.

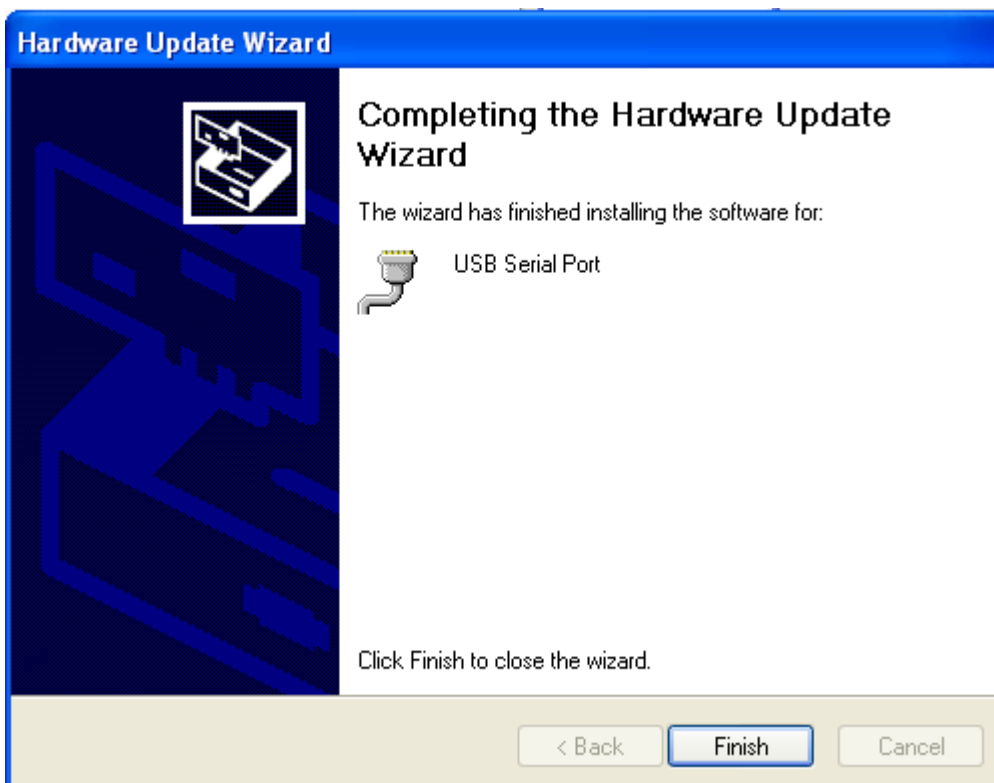

10. When the installation is completed, click “Finish”.
11. In order to find the assigned serial port for the USB port, click the “**Start**”, “**Control Panel**”, “**System**”, “**Hardware**”, “**Device Manager**”, “**Ports (COM&LPT)**” on the PC monitor screen.. USB Serial port (COM x) will be indicated. (Note: “x” varies from your PC configuration.) Below screen shows the COM8 has been assigned for the USB port.

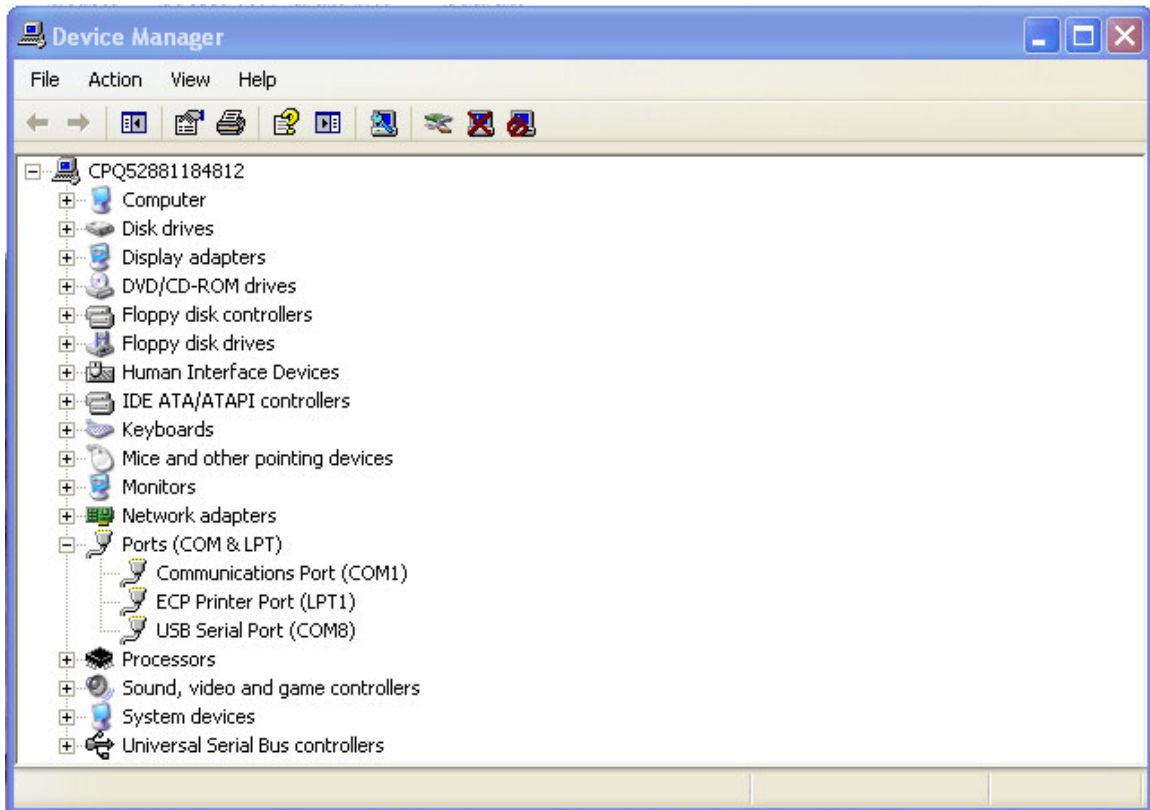

2-3 AR2300 control software installation

Place the supplied program CD into your CD drive. Copy the program folder from CD to any location (such as desktop) on the hard drive.

2-3-1 Starting the program

Double click the “AR2300ControlSoft.exe” in the program folder.

The following screen (or similar) will appear on the monitor screen of the PC.

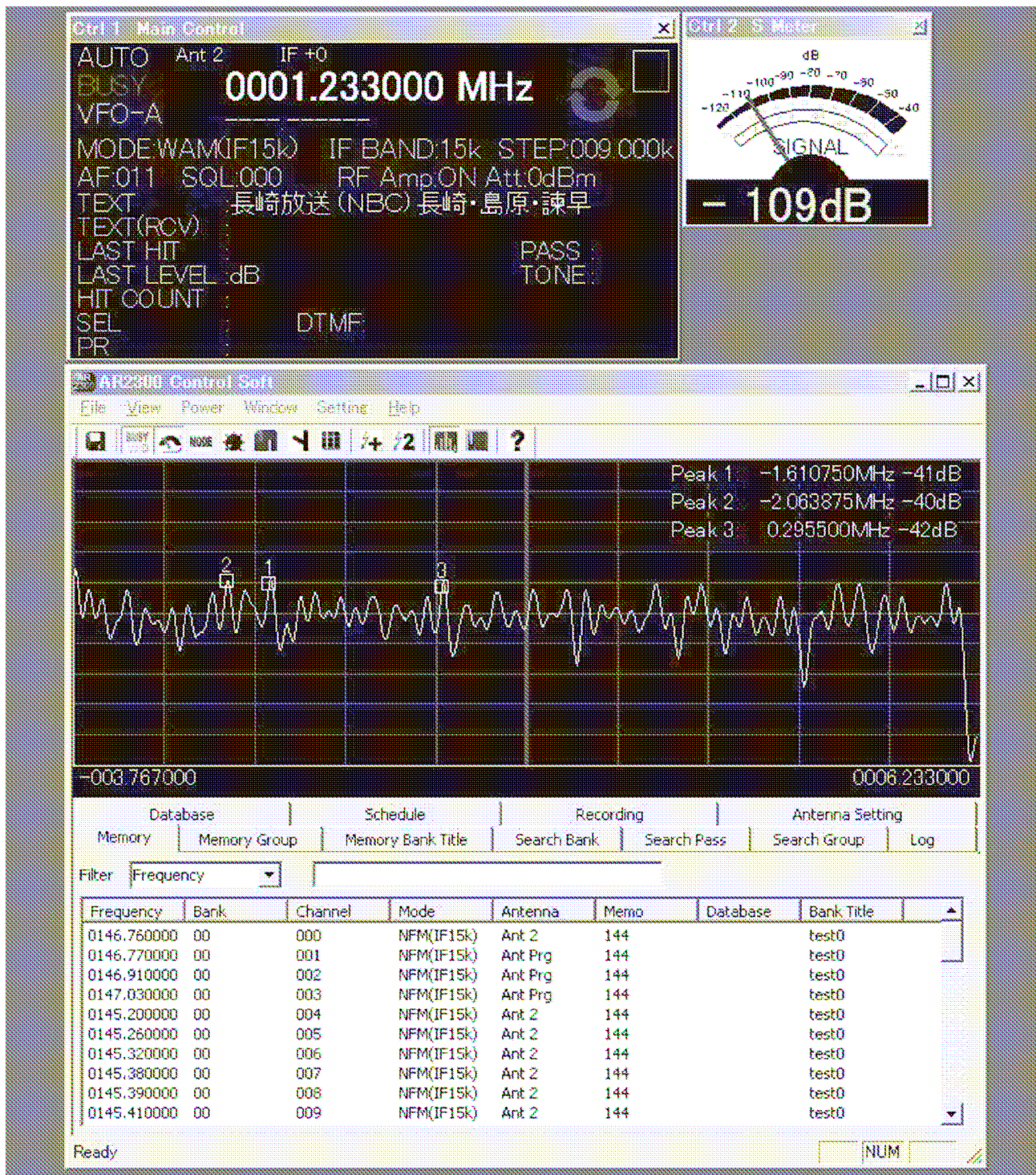

For detailed operation of the control program, please refer to the separate operation sheet or click the **HELP** tab.

2-3-2 In case of difficulty

If one of following error message is displayed on the monitor screen while starting the control program, perform the following steps:

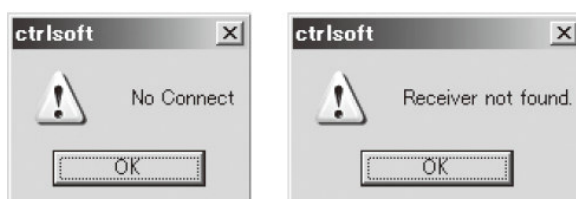

1. On the main screen, click the “File” tab, then click the “Select Device” tab.

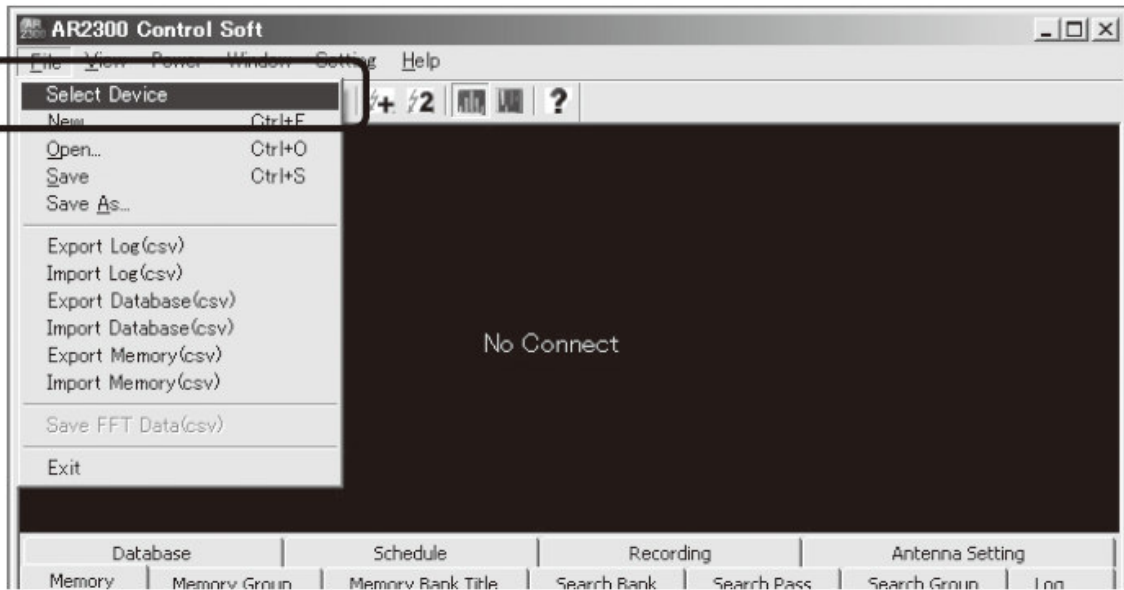

2. Wait for several seconds until the following screen is displayed.



3. If the number (may vary) in the Detect box is displayed, then click “OK”.

4. If no number is displayed, check the following:

- The power switch of the AR2300 is turned on.
- The AR2300 and the PC are connected through the USB cable.
- Check the COM port number (refer to 2-3-1 #11 COM port setting) and enter the COM port number in the Detect Box. Then click “OK”.

2-4 LAN

With an optional USB to LAN interface unit, the AR2300 can be controlled via the internet. All the control commands for the LAN interface are the same as the USB control commands.

3. Control commands (for terminal software)

The following are the specifications for the communication protocol used:

Communication speed: 115,200bps (default), 57,600bps, 38,400bps, 19,200bps, 9,600bps

Data: 8 bit

Stop bit: 1

Parity: None

Flow control: None or RTS/CTS

Echo: Off

Return Code: (PC→ AR2300): <CR><0x0d> <LF> ignore

Return Code: (AR2300→ PC): <CR><LF>(0x0d, 0x0a)

3-1 Command format

<command><CR>

<command><parameter><CR>

<command><parameter 1><SP><parameter 2><SP><parameter 3><CR>

Each command is completed with a <CR>(0x0d).

3-2 Response format

Although there is no local echo, a specified response should come back from the AR2300 after confirming the correct command.

If an invalid command is sent to the AR2300, ? <CR><LF> (0x3f, 0x0d, 0x0a) will be returned as an unrecognized command.

<SP><CR><LF> (0x20, 0x0d, 0x0a) to a valid command (without parameter).

<command><value><CR><LF> to a valid command (with parameter.)

3-3 Power on the AR2300

3-3-1 Wake up

ZP	Power on	Wake up from stand-by mode (QP command) or sleep mode (SP command). ZPnn : 00 ~ 99, wake up ID Note: The power switch must be in the ON position.
-----------	----------	--

3-3-2 Wake up ID set up

ZI	Set up wake up ID	ZInn : 00 ~ 99 (default: 00)
To read: ZI <CR>		
Response: ZInn		

3-4 Power off the AR2300

3-4-1 Standby mode

QP	Switches the AR2300 to standby mode	The front power switch must remain in the ON position.
-----------	-------------------------------------	--

3-4-2 Sleep timer

SP	Sleep Timer	SPnn : 00 ~ 99 (unit: minute) (default: 00 : Off)
TR	Sleep Timer Display (Displays remaining time)	TR0 : display off TR1 : display on (default)

3-5 Audio gain

AG	AGnnn (nnn: 000 ~255) (default: 00)
To read: AG <CR>	
Response: AG nnn	

3-6 Frequency/memory channel up/down

ZK	ZK	Change upward
ZJ	ZJ	Change downward

3-7 Step frequency

ST	STnnn.nnn (entry in kHz format)	Default: 100.000 (kHz)
To read: ST <CR>		
Response: STnnn.nnn (kHz)		

3-8 Receive modes, IF bandwidth, AUTO mode

3-8-1 Command description

MD --- Receive mode setting (default: 21)

IF ---- IF bandwidth setting (default: 07)

AU --- Auto mode setting (default: 1)

AZ --- Destination setting (default: 0)

(Note: Some functions below 25MHz are not available due to its configuration.)

3-8-2 Simple mode

Command	Description	Mode	IF bandwidth (Hz)	Remarks
MD21	WFM1	FM	100K	N/A below 25MHz
MD22	WFM2	FM	200K	N/A below 25MHz
MD23	FMST	FM Stereo	200K	N/A below 25MHz
MD24	NFM	FM	15K	N/A below 25MHz
MD25	SFM	FM	6K	N/A below 25MHz
MD26	WAM	AM	15K	
MD27	AM	AM	6K	
MD28	NAM	AM	3K	
MD29	SAM	Synchronous AM	6K	
MD30	USB	USB	3K	
MD31	LSB	LSB	3K	
MD32	CW1	CW	500	
MD33	CW2	CW	200	
MD34	ISB	ISB	6K	N/A below 25MHz
MD35	AIQ	AIQ	15K	AF-IQ output
AU0	-	-		AUTO mode off
AU1	-	-		AUTO mode on

3-8-3 Advanced mode

Command	Description	Mode	IF bandwidth (Hz)	Remarks
MD00	FM	FM		N/A below 25MHz
MD01	FMST	FM Stereo		N/A below 25MHz
MD02	AM	AM		
MD03	SAM	Synchronous AM		
MD04	USB	USB		
MD05	LSB	LSB		
MD06	CW	CW		

MD07	ISB	ISB		N/A below 25MHz
MD08	AIQ	AIQ		AF-IQ output
AU0	-	-		AUTO mode off
AU1	AUTO	AUTO		AUTO mode on
IF00	200		200	N/A below 25MHz
IF01	500		500	N/A below 25MHz
IF02	1K		1K	N/A below 25MHz
IF03	3K		3K	
IF04	6K		6K	
IF05	15K		15K	
IF06	30K		30K	
IF07	100K		100K	N/A below 25MHz
IF08	200K		200K	N/A below 25MHz

3-8-4 Auto mode

The following parameters are automatically set in the AUTO mode:

- Step frequency
- Step frequency adjust
- Receive mode
- IF bandwidth
- Offset frequency (for dual frequency receive)

3-8-5 Destination setting

AZ0 --- U.S.A.

AZ1 --- Japan

AZ2 --- Europe

The frequency band plan and receive mode are properly set according to its destination.

3-9 Decode assist function

3-9-1 Auto notch (notch)

The auto notch function is effective to suppress cyclic noise.

LS	LSn	n: 0 ~ 3 0: Off (default) 1: Low 2: Medium 3: High
To read: LS <CR>		
Response: LSn		

3-9-2 Noise reduction (NR)

The noise reduction function is effective to suppress random noise.

NR	NRn	n: 0, 1 0: Off (default: 0) 1: On
To read: NR <CR>		
Response: NRn		

3-9-3 Noise blanker (NB)

The noise blanker function is effective to suppress pulse noise.

NB	NBn	n: 0, 1 0: Off (default) 1: On
To read: NB <CR>		
Response: NBn		

3-9-4 Voice inversion descrambler (VI)

*** NOTE: This function is not available for the US consumer version.***

Available in FM mode.

SC	SCnnn	n: 0, 200 ~ 700 (2000Hz ~ 7000Hz) incremental 5 (50Hz) 0: Off (default)
To read: SC <CR>		
Response: SCnnn		

3-9-5 IF shift

Not available in FM mode.

IS	ISxnnn	X: +, - (shift direction) n: -120 ~ +120 (-1200Hz ~ +1200Hz) Incremental 5 (50Hz) n: +0 Off (default)
To read: IS <CR>		
Response: ISxnnn		

3-9-6 CW pitch frequency

Available in CW mode only.

CP	CPnn	nn: 30 ~ 90 (300Hz ~ 900Hz) Incremental 5 (50Hz) (default: 80)
To read: CP<CR>		
Response: CPnn		

3-9-7 Automatic gain control (AGC)

Not available in FM mode.

AC	ACn	n: 0 ~ 3
		n=0 AGC - FAST
		n=1 AGC - MEDIUM
		n=2 AGC - SLOW (default)
		n=3 AGC - MANUAL
To read: AC <CR>		
Response: Can		

3-9-8 Automatic frequency control (AFC)

AF	AFn	n: 0, 1 0: Off (default) 1: On
To read: AF<CR>		
Response: AFn		

- 1) AFC does only work in NFM mode with a filter setting up to 30kHz.
- 2) It does NOT automatically retune the receiver to the nearest strong signal.
- 3) *Real function of AFC:* It tunes the IF filter's frequency automatically when an unstable frequency is received. It does not change the receive frequency. Since only IF is changed, there is no "visual" change on the control program's spectrum or frequency display. The change can only be heard on "audio".
- 4) It only works if the sending station's frequency shifts are within the selected IF filter's bandwidth. Example: IF=15kHz >> +/-7kHz, IF=30kHz >> +/-15kHz

3-9-9 Tone squelch (CTCSS)

CN	CNnn	nn: 00 ~ 52 00: Off (default)								
Below is a chart of the CTCSS frequency.										
	n0	n1	n2	n3	n4	n5	n6	n7	n8	N9
0n	-	60.0	67.0	69.3	71.9	74.4	77.0	79.7	82.5	85.4
1n	88.5	91.5	94.8	97.4	100.0	103.5	107.2	110.9	114.8	118.8
2n	120.0	123.0	127.3	131.8	136.5	141.3	146.2	151.4	156.7	159.8
3n	162.2	165.5	167.9	171.3	173.8	177.3	179.9	183.5	186.2	189.9
4n	192.8	196.6	199.5	203.5	209.5	210.7	218.1	225.7	229.1	233.6
5n	241.8	250.3	254.1	-	-	-	-	-	-	-
(Example) nn: 13 → 97.4Hz										
To read: CN <CR>										
Response : CNnn										

Note: When the AR2300 is detecting a CTCSS tone, it will display the frequency.

If the decoded tone frequency is the same as the set frequency, the AR2300 will display its frequency followed by an asterisk (*).

(Example) CN15 103.5* The set CTCSS frequency matches the decoded tone frequency.

3-9-10 Digital code squelch (DCS)

DS	DSnnn									nnn: see below chart	000: Off (default)
Below is a chart of the DCS codes.											
017	023	025	026	031	032	036	043	047	050		
051	053	054	065	071	072	073	074	114	115		
116	122	125	131	132	134	143	145	152	155		
156	162	165	172	174	205	212	223	225	226		
243	244	245	246	251	252	255	261	263	265		
266	271	274	306	311	315	325	331	332	343		
346	351	356	364	365	371	411	412	413	423		
431	432	445	446	452	454	455	462	464	465		
466	503	506	516	523	526	532	546	565	606		
612	624	627	631	632	654	662	664	703	712		
723	731	732	734	743	754	-	-	-	-		
To read: DS <CR>											
Response : DSnnn											

Note:When the AR2300 is detecting a DCS code, it will display the code.

If the decoded code is the same as the set code, the AR2300 will display its code followed by an asterisk (*).

(Example) DS131 131* The set DCS code matches the decoded DCS code.

3-9-11 DTMF code

DT	DTn	n: 0, 1 0: Off (default) 1: On
DX	DX DX%	Displays decoded tones Clear displayed decode tones
To read: DT<CR> or DX<CR>		
Response: DTn or DX cccc.....		

3-9-12 De-emphasis

EN	ENn (n: 0, 1)	0: 50uS (default) 1: 75uS
To read: EN <CR>		
Response: ENn		

3-10 Squelch

3-10-1 Level squelch

LQ	LQnnn	nnn: 000 ~ 255 (default: 000)
HQ	HQnnn mmm	nnn:000 ~ 255 (for receive frequency above 25MHz) (default: 000) mmm: 000 ~ 255 (for receive frequency below 25MHz) (default: 000)
To read: LQ <CR> or HQ<CR>		
Response: LQnnn or HQnnn mmm		

3-10-2 Voice squelch

VQ	VQn	n: 0, 1 0: Off (default) 1: On
VT	VTnnn	nnn:000 ~ 255 Delay time (default: 008)
VL	VLnn	nn: 0 ~ 7 Squelch level (default: 3)
To read: VQ <CR> or VT<CR> or VL<CR>		
Response: VQn or VTnnn or VLnn		

3-11 RF amplifier, attenuator

AT	ATn	n: 0 ~ 4 (default: 0)
	n=0	RF AMP = On, Attenuator = 0 dB, Auto attenuator = Off
	n=1	RF AMP = Off, Attenuator = 0 dB, Auto attenuator = Off
	n=2	RF AMP = Off, Attenuator = -10 dB, Auto attenuator = Off
	n=3	RF AMP = Off, Attenuator = -20 dB, Auto attenuator = Off
	n=2	Auto attenuator = On
To read: ATy <CR>		
Response: ATmn m : 0, 1 0: Auto attenuator On 1: Auto attenuator Off n : 0 ~ 3 See above		

3-12 Antenna select

AN	ANn	n: 0 ~ 2 (default: 1)
	n=0	Auto select
	n=1	Antenna connector 1
	n=2	Antenna connector 2
To read: AN <CR>		
Response: ANmn m : Antenna select setting n : 1, 2 Antenna connector		

Note: When the receive frequency is below 25MHz, antenna connector 2 is automatically selected.

3-12-1 Antenna Select programming

Up to 10 receive frequency ranges can be programmed and assigned to an antenna input.

If the above programming is not made, antenna 1 is selected.

AP	<p>To <u>add</u> new frequency range, use APn xxxx.xxxxxx yyyy.yyyyyy n: 1, 2 (antenna connector) xxxx.xxxxxx low end frequency (MHz) yyyy.yyyyyy high end frequency (MHz)</p> <p>To <u>assign</u> new frequency range in a specific location, use APnmm xxxx.xxxxxx yyyy.yyyyyy n: 1, 2 (antenna connector) mm: memory location (00 ~ 09) xxxx.xxxxxx low end frequency (MHz) yyyy.yyyyyy high end frequency (MHz)</p> <p>AP% --- Display programmed frequency range for both antenna connectors. (Frequency below 25MHz cannot be set.)</p>
AD	<p>To <u>delete</u> specific programmed frequency ranges, use ADnm. n: 1, 2 (antenna connector) m: memory location (0 ~ 9)</p> <p>To delete all programmed frequency ranges on a specific antenna connector, use ADn%. n: 1, 2 (antenna connector)</p> <p>To delete entire programmed memory contents, use AD%%.</p>

3-13 S-meter

3-13-1 Signal level

LM	To read: LM <CR>
Response	<p style="text-align: center;">LMnnn.nc</p> <p>nnn.n: Relative level in dB c: Squelch status no display : squelch closed P: squelch open V: voice squelch open A: APCO25 mode E: APCO25 (encrypted) D: CTCSS / CTS squelch</p>

3-13-2 Auto signal level

LT	LTnnnn	n: 0 or 1 ~ 6000 (in approximately 10 mS) 0: Off (default)
	When n is set to 1 or higher, the AR2300 sends s meter level in above preset interval.	
To read: LT <CR>		
Response:	LTnnnn	

3-14 Audio recorder control

3-14-1 Control relay status

TP	TPn	n: 0 , 1 0: Off (Relay contact open) (default) 1: On (relay contact closed)
	The relay contact is available at the ACC1 connector to control an external audio recorder device. When the squelch is open, the relay contact will close. When squelch is closed, then the relay contact will open.	
To read: TP <CR>		
Response:	TPn	

3-14-2 Control relay status report

TC	TCn	n: 0 , 1 0: Off (No report) (default) 1: On (Report by the TP command)
	When the control relay opens or close during receive, the relay operation status will be output by the TP command if the TC command is set to on. No report will be made if the TC command is set to 0.	
To read: TC <CR>		
Response:	TCn	

3-15 Manual RF gain

This command is available only when the AGC is set to 3 (manual mode).

RG	RGnnn	(nnn: 000 – 110) (in dB) (default::110)
To read: RG <CR>		
Response:	RG nnn	

3-16 RF filter bandwidth for A/D converter

AB	ABn	n: 0 , 1 0: 10MHz (recommended) (default) 1: 30kHz
	This command is used to select the bandwidth of analog filter for the A/D converter. Normally, it should be set to 10MHz. However, in case of a strong signal in adjacent frequency, it can be set to 30kHz. This setting does not affect spectrum display function or FFT search.	
To read: AB<CR>		
Response:	ABn	

3-17 RF band pass filter (for below 25MHz reception)

HN	HNn	n: 0 , 1 0: Off (No filter) (default) 1: On (Filtered)
	This command is to select to use or not use a Band Pass Filter (BPF) for 25MHz signal. This function is available only to receive 25MHz of frequency.	
To read: HN <CR>		
Response:	HNn	

4. Receive commands

4-1 VFO mode

VF	VFm	m: A ~ E (default: A)
RF	RFnnnn.nnnnnn	nnnn.nnnnnn (MHz) Frequency set (default:0082.500000) (MHz)
	The VF command is to select VFO A ~ VFO E. To set the frequency, use the RF command after selecting the VFO. The VFO-E is used to set receive frequency below 25MHz in the duo receive mode.	
To read: VF <CR>, RF<CR>		
Response:	VFm, RFnnnn.nnnnnn (MHz)	

4-2 Search mode (normal search mode)

SS	SS	Start normal search
	SSnn	nn : 00 ~ 39 Search in the selected search bank.
ZJ, ZK,	ZJ	Search frequency downward
	ZK	Search frequency upward
LC	LCn	n: 0, 1
		0: Frequency data output disabled (default)
		1: Frequency data output enabled
To read: SS<CR>, LC<CR>		
Response:	SSnn, LCn	

4-2-1 Search bank

SE SR	SEnn	(nn: 00 ~ 39) Search Bank number
	SLnnnn.nnnnnn	(Lower Frequency, MHz)
	SUnnnn.nnnnnn	(Upper Frequency, MHz)
	STnnn.nnn	(Search frequency step, kHz)
	AUn	(n: 0, 1)
		0: Auto mode Off 1: Auto mode On
	MDnn	Receive mode
	ATn	RF amplifier, attenuator
TTxxxxxxxxxxx	(Enter text as needed, up to 12 characters)	
Format: SEnn SLnnnn.nnnnnn SUnnnn.nnnnnn STnnn.nnn AUn MDnn ATn TTxxxxxxxxxxx		
Note: Refer to individual command for details of each field		
To read: SRnn<CR>		
Response:	SEnn SLnnnn.nnnnnn SUnnnn.nnnnnn STnnn.nnn AUn MDnn ATn TTxxxxxxxxxxx	

4-2-2 Pass frequency

PW	1. Send PW command while search stops during search mode. → Register a current freq. to the current Pass bank.
	2. Send PWnn command while search stops during search mode. → Register a current freq. to the specified (nn) Pass bank.
	3. Send PW:mmmm.mmmmmm (MHz) command during search mode. → Register the above frequency to the current Pass bank. Send PW:mmmm.mmmmmm nnnn.nnnnnn (MHz) command during search mode. → Register above frequency range to the current Pass bank.
	4. Send PWnn mmmmm.mmmmmm command in normal receive mode. → Register above frequency to the specified (nn) Pass bank.
	5. Send PW%% command while search stops during search mode. → Register a current frequency to all Pass banks.
	6. Send PW%% mmmmm.mmmmmm (MHz) command PWnnnnnnnnnnnn in normal receive mode. → Register above frequency to all Pass banks. Send PW:mmmm.mmmmmm nnnn.nnnnnn (MHz) command during search mode. → Register above frequency range to all Pass banks.
	After PW command is sent, search function will resume.
PR	Displays a list of pass frequencies
	PRnnxx mmmmm.mmmmmm (MHz) (nn: search bank number) Or, PRnnxx mmmmm.mmmmmm nnnn.nnnnnn (MHz) (if the pass frequency range is known.) (xx: the number from the top of the search bank)
PD	PDnnxx (nn: 00 ~ 39) (xx: number from the top of the search bank) Delete search data and pass frequency on designated search bank
	PD%% Delete all search data and pass frequencies on all search banks

4-2-3 Normal search setting format

SG	SGnn DLnn FRnn ASn BKxxxxxx...xx
	1. SGnn nn: 00 ~ 19 (Search group number) (00: default) <i>(Note: The SG00 is not available for search link.)</i>
	2. DLnn nn: 01 ~ 99 (Search delay time, in 0.1 sec.) (default: 20) When a signal is lost, it will resume search after the preset delay time.
	3. FRnn nn: 00 ~ 60 (Timer search, in 1 sec.) (default: 00 → Off) When a signal is received, it will resume search after the preset time.
	4. ASn n: 0, 1 0: Auto store Off (default) 1: Auto store On When Auto store is set to On, the received frequency will be registered to Search bank #40.
5. BKxxxxxx...xx Search bank link (Example) To link 02 → 05 → 11, then BK020511 To delete search bank link, BK<CR> .	
(Note: The DL, FR, AS, and BK commands cannot be used alone independently. They must always be used in conjunction with the SG command.)	
To read: SGnn<CR>	
Response:	SGnn DLnn FRnn ASn BKxxxxxx...xx

4-2-4 Search frequency list

FL	There are 1024 channels of search memory in the AR2300. By executing the FL command, 40 channel data can be displayed.
	<p>FLn n: 0 ~ 4</p> <p>n: 0 Displays the latest 40 channels (frequencies may duplicate.)</p> <p>1 Displays the latest 40 channels (frequency not duplicated)</p> <p>2 Displays 40 channels with the strongest signal (frequency may duplicate).</p> <p>3 Displays 40 channels with the strongest signal (frequency not duplicated.)</p> <p>4 Displays most frequently detected signals.</p> <p>FL% Clear search list</p>

4-3 FFT search

FFT search differs from regular scanning methods (one frequency / step after the other) in that it provides a spectrum [image] up to 10MHz wide, sampled 15 times per second. Although the search bank basic settings for normal search and FFT search are done the same way (for Low Frequency, High Frequency, and text settings), in FFT search the following parameters must also be set.

FFT frequency step

Threshold level (signal detection level)

FF	FFnn FSnn FT-<i>nnn</i>
	<p>FFnn Search bank (two digits) select to access. nn: 00 ~ 39 (default: 00)</p> <p>FSnn Frequency step select nn: 00 ~ 10</p> <p style="padding-left: 40px;">00: 5kHz 01: 6.25kHz 02: 8.33kHz 03: 9kHz 04: 10kHz 05: 12.5kHz 06: 20kHz (default) 07: 25kHz 08: 30kHz 09: 50kHz 10: 100kHz</p> <p>FT-<i>nnn</i> Set the threshold level. Once set, only signals over this level will be detected by the FFT search. -<i>nnn</i>: (dB) (default: -80) (dB)</p>
LC	<p>LCn n: 0, 1</p> <p style="padding-left: 40px;">0: Disable search result frequency report 1: Enable search result frequency report</p>
<p>(Note: The FS, FT commands cannot be used alone. They must always be used in conjunction with the FF command.)</p>	

4-4 Memory channel

The AR2300 features 2,000 memory channels (50 channels in each of the 40 banks).

The number of memory banks can be reconfigured between 5 ~ 95 (in 5 incremental).

4-4-1 Memory read mode

MR	<p>MRnmm nn: 00 ~ 39 (Memory bank) (default: 00) mm: 00 ~ 49 (Memory channel) (default: 00)</p>
ZK	Go to next memory channel
ZJ	Go to previous memory channel
To read: MRnmm<CR>	

4-4-2 Memory data setting

MX	MXnnmm GAn MPn MFnnnn.nnnnnn MDnn ATn ANn MTxxxxxxxxxxxx
	<p>MXnnmm: nn: 00 ~ 39 (Memory bank) mm: 00 ~ 49 (Memory channel)</p> <p>GAn: n: 0, 1 (Memory select, de-select) 0: de-select 1: select (default)</p> <p>MPn: n: 0, 1 (Memory pass) 0: no 1: yes</p> <p>MFnnnn.nnnnnn Frequency (MHz)</p> <p>MDnn: receive mode</p> <p>ATn: RF attenuator / amplifier</p> <p>ANn: Antenna select</p> <p>MTxxxxxxxxxxxx: Memory tag (up to 12 characters)</p>
	<p>Note: Refer to individual command for details of each field.</p> <p>The MF, MT commands cannot be used alone.</p> <p>They must always be used in conjunction with the MX command.</p>
	To read: MAnmm<CR>
	Response: MFnnnn.nnnnnn MTxxxxxxxxxxxx

4-4-3 Memory bank resizing

The AR2300 features 2,000 memory channels (50 channels in each of the 40 banks). If you resize a memory which currently contains 50 channels to a new size of 10 channels, the last 40 channels will be deleted and data will be lost. Therefore, it is suggested that you need to carefully organize your memory data before resizing memory channels.

MW	MWnn MCnn TT xxxxxxxxxxxx
	<p>MWnn: Select memory bank</p> <p>MCnn: Resizing value nn: 05 ~ 95 (5 incremental)</p> <p>TT xxxxxxxxxxxx: Memory tag (up to 12 characters)</p>
	To read: MWnn<CR>
	Response: MWnn MCnn TT xxxxxxxxxxxx
	<p>Note: The MC, TT commands cannot be used alone.</p> <p>They must always be used in conjunction with the MW command.</p>

4-4-4 Delete memory channel

MQ	MQnnmm:	nn: Bank number mm: Memory channel
-----------	----------------	---------------------------------------

4-4-5 Delete memory bank

MB	MBnn: nn: Bank number
-----------	------------------------------

4-5 SCAN

4-5-1 Start scan

MS	MSnn nn: Memory channel If the memory frequency is registered to pass frequency lit, it will be skipped.
LC	LCn: n : 0, 1 0: No report (default) 1: Output detected frequency information

4-5-2 Memory data setting

MG	MGnn DLnn FRnn BKxxxxxx...xxxx
	The AR2300 features 20 scan groups. MGnn: nn: 00 ~ 19 (Scan bank number) (default: 00) DLnn: nn: 01 ~ 99 (Squelch delay time) (in 0.1 sec.) (between squelch closing and scan restart) (default: 20) FRnn: nn: 00 ~ 60 (Free scan) (in 1 second) (default: 00 → Off) (duration is how long the AR2300 will remain on active frequency before resuming scan even when the frequency is still active).
BK	BKxxxxxx...xxxx: Linked bank number (Example: Link 02 → 05 → 11, then BK020511.) (Note: Scan bank 00 cannot be linked.) To <u>delete bank</u> , enter BK<CR> .
Note: The DL, FR, BK commands cannot be used alone. They must always be used in conjunction with the MG command.	
To read: MGnn<CR>	
Response: MGnn DLnn FRnn BKxxxxxx...xxxx	

4-5-3 Memory pass

MP	MPn: n: 0, 1 0: Pass Off 1: Pass MPnn: nn: 00 ~ 39 (memory bank) Memory pass cancel on the selected bank
To read: MP<CR>	
Response: MPn	

4-6 Select scan

4-6-1 Start select scan

The Select scan function allows you to scan only a selection of the frequencies that were previously saved as memory channels. A maximum of 100 channels within a bank can be scanned.

SM	SM (direct command)
LC	LCn: n: 0, 1 0: No report (default) 1: Output detected frequency information

4-6-2 Select scan setting

GA	GAn: n: 0, 1 0: Select scan Off 1: Select scan On (default)
GD	GD Clear select memory (direct command)
To read: GR<CR>	
Response: GRnnnn (Displays select scan memory list)	

4-7 Duo frequency / tri frequency receive

The Duo frequency / Tri frequency receive functions allow you to monitor two or three separate frequencies simultaneously.

4-7-1 Duo frequency receive (duo band receive mode)

With this function, one frequency below 25MHz set on the VFO-E (as a sub band) and another frequency above 25MHz set on the VFO (other than VFO-E, as a main band) can be received simultaneously.

The received audio for both frequencies are available at the headphone jack independently. Mixed audio for both signals is available at the external speaker jack.

Below are the requirements for Duo frequency receive function:

(For main band)

- Frequency must be above 25MHz.
- The FM stereo mode is not available in this mode.
- The receiver must be in the VFO mode and it must be set other than VFO-E.
- The antenna input must use number 1.

(For sub band)

- Frequency must be below 25MHz.
- The VFO must be set to VFO-E.

4-7-1-1 Starting duo frequency receive

VW	VWnm: n: @, A ~ D (VFO mode) @: Duo receive off (default) m: 0, 1 0: VFO-n (main band) (default) 1: VFO-E (sub band)
To read: VW<CR>	
Response: VWnm	

4-7-1-2 Audio output balance

VH	VHnnn: n: 000 ~ 255 128: default (equal balance between main band audio and sub band audio) (Note: 000 --- Main band only, 255 --- Sub band only)
To read: VH<CR>	
Response: VHnnn	

4-7-2 Duo frequency receive (frequency offset receive mode)

With this function, one frequency above 25MHz is set as a main frequency and another frequency which is within +/- 5MHz from the main frequency set as an offset frequency can be received simultaneously.

The received audio for both frequencies is available at the headphone jack independently. Mixed audio for both signals is available at the external speaker jack.

Either VFO mode or Memory mode can be used in the function.

Below are the requirements for Duo frequency receive function:

- The main frequency must be above 25MHz.
- The offset frequency must be within +/- 5MHz from the main frequency.
- Both frequencies must be in the same receive modes.
- FM stereo is not available in this mode.

4-7-2-1 Frequency offset

WF	WFpnnnnn.nnnnnn: (MHz) p: +, - (Offset direction) nnnn.nnnnnn: 0 ~ 5MHz (default: 0)
To read: WF<CR>	
Response: WFpnnnn.nnnnnn	

4-7-2-2 Starting duo frequency receive

WR	WRn:	n: 0, 1	
			0: Duo receive Off (default)
			1: Duo receive On
To read: WR<CR>			
Response: WRn			

4-7-2-3 Audio output balance

WV	WVnnn:	n: 000 ~ 255	
			128: default (equal balance between main frequency audio and offset frequency audio)
			(Note: 000 --- Main frequency only, 255 --- Offset frequency only)
To read: WV<CR>			
Response: WVnnn			

4-7-3 Tri frequency receive

Below is the procedure to activate the Tri frequency receive function:

- Set two separate frequencies as the main band according to the instructions on (4-7-2 Duo frequency receive (Frequency offset receive))
- Set another frequency below 25MHz as a sub band.

5. Other receive commands

5-1 Priority receive

5-1-1 Priority setup

PP	PPnmmm		
			n: 00 ~ 39 (Memory bank) (default: 00)
			mm: 00 ~ 49 (Memory channel) (default:00)
TI	TInn		
			nn: 01 ~ 99 (second) (Time interval)
			(default: 10)
To read: PP<CR>, TI<CR>			
Response: PPnmmm, TInn			

5-1-2 Starting priority

PO	POn:	n: 0, 1	
			0: Priority Off (default)
			1: Priority On
To read: PO<CR>			
Response: POn			

5-2 Step adjust

SH	SHnnn.nnn: nnn.nnn (kHz) (default: 000.000)
To read: SH<CR>	
Response: SHnnn.nnn	

6. Spectrum display commands

6-1 Start frequency

TF	TFnnnn.nnnnnn: nnnn.nnnnnn (MHz) (default: 0077.500000) (MHz)
To read: TF<CR>	
Response: TFnnnn.nnnnnn	

6-2 End frequency

EF	EFnnnn.nnnnnn: nnnn.nnnnnn (MHz) (default: 0087.500000) (MHz)
To read: EF<CR>	
Response: EFnnnn.nnnnnn	

6-3 Center frequency

CF	CFnnnn.nnnnnn: nnnn.nnnnnn (MHz) (default: 0082.500000) (MHz)
To read: CF<CR>	
Response: CFnnnn.nnnnnn	

6-4 Span frequency

FP	FPnnnn.nnnnnn: nnnn.nnnnnn (MHz) (default: 0010.000000) (MHz)
To read: FP<CR>	
Response: FPnnnn.nnnnnn	

6-5 Spectrum step frequency

FE	FEnnn.nnn: nnn.nnn (kHz) (default: 062.500) (kHz) The value is equal to 1/160 of the frequency span.
To read: FE<CR>	
Response: FEnnn.nnn	

6-6 Marker frequency

6-6-1 Marker frequency setup

KF	<p>KFnnnn.nnnnnn: nnnn.nnnmmm (MHz) (default: 0082.500000) (MHz)</p> <p>The entered value may be changed according to the frequency span and frequency range.</p>
To read: KF<CR>	
Response: KFnnnn.nnnnnn -mmm -mmm: signal level (in dB)	

6-6-2 Marker frequency/ level auto output

KC	<p>KCn n: 0, 1</p> <p>0: Disable data output (default) 1: Enable data output</p>
To read: KC<CR>	
Response: MKnnnn.nnnnnn -mmm -mmm: signal level (in dB)	

6-6-3 Transfer the marker frequency to receive frequency

KG	<p>KG (Direct command)</p>
-----------	---------------------------------------

6-7 Spectrum data output

GL	<p>Output the level data of each frequency on the screen.</p> <p>GL<CR><LF>/<SP><CR><LF></p> <p>(Note: The separator (/<CR><LF>) has 160 lines.</p>
To read: GL<CR>	
Response: GL<CR><LF>/<SP><CR><LF>	

6-8 High speed spectrum data output

FD	<p>Output the level data of each frequency on the screen in high speed.</p> <p>Convert the signal strength data of one horizontal dot into 1 byte character. Then repeat this step for a total of 160 characters and output these data followed by the OK response (<SP><CR><LF>).</p> <p>To convert the output data to a signal strength level, subtract 0x20 (in hexadecimal), then add -100dB.</p> <p>FD<SP><CR><LF></p>
To read: FD<CR>	
Response: FD<SP><CR><LF>	

7. Video Monitor commands

7-1 Activate the video monitor function

VS	VS_n	n: 0, 1 0: Deactivate video monitor function (default) 1: Activate video monitor function (Note: Video output signal is only available at the video output connector on the front panel.)
To read: VS<CR>		
Response: VS _n		

7-2 Frequency shift reverse

VD	Some video transmitters utilize reversed frequency shift modulation in order to scramble the signal.	
	VD_n	n: 0, 1 0: Normal shift (default) 1: Reverse shift direction
To read: VD<CR>		
Response: VD _n		

8. I/Q output commands

When an optional Digital I/Q output unit is installed, USB 2.0 compatible I/Q data output is available.
25MHz to 3.15GHz only

The separate AOR IQ driver must be installed before using this function.

8-1 I/Q bandwidth

In order to use the I/Q output function, you must have an operating system that is compatible with Isochronous mode and USB 2.0 format.

(Note: A Windows® XP compatible PC is required to use I/Q function.)

IQ	IQ_n	n: 0, 1 0: 300kHz (default) 1: 1MHz
To read: IQ<CR>		
Response: IQ _n		

9. Data editor commands

DE	DEnn xxxx yyyy	
	nn: Process number (see below) xxxx: Channel origin (see below) yyyy: Channel destination (see below)	
	nn	Process
	00	Transfer contents of memory bank xx to memory bank yy.
	02	Copy contents of memory bank xx to memory bank yy.
	04	Transfer contents of search bank xx to search bank yy.
	06	Copy contents of search bank xx to search bank yy.
	08	Transfer contents of memory channel xxxx to memory channel yyyy.
	10	Copy contents of memory channel xxxx to memory channel yyyy.
	12	Transfer contents of scan group xx to scan group yy.
	14	Copy contents of scan group xx to scan group yy.
	16	Transfer contents of search group xx to search group yy.
	18	Copy contents of search group xx to search group yy.
	21	Delete contents of memory bank xx.
	22	Delete contents of search bank xx.
	23	Delete contents of memory channel xxxx.
	(24)	Cancel Pass setting of all channels on memory bank xx. (Note: Recommend use of MPnn command. Refer to 4-5-3 section of this manual)
	(25)	Cancel Pass setting of all channels on search bank xx. (Note: Recommended use of PDnn%% command. Refer to 4-2-3 section of this manual.)
	26	Delete all contents of memory banks.
	27	Delete all contents of search banks.

10. Configuration commands of other parameters

10-1 Selecting interface

CL	CLn	n: 0 ~ 3 0: USB 1: AUX (optional LAN box) 2: USB or AUX (AUX will be selected if USB is not connected) (default) 3: AUX or USB (USB will be selected if AUX is not connected.)
To read: CL<CR>		
Response:	CLmn	m: 0, 1 0: USB 1: AUX n: 0 ~ 3 (see above)

10-2 Communication speed

SB	SBn	n: 0 ~ 4 0: 115,200 bps (default) 1: 57,600 bps 2: 38,400 bps 3: 19,200 bps 4: 9,600 bps
To read: SB<CR>		
Response:	SBn	

10-3 Flow control

SF	SFn	n: 0, 1 0: None 1: Hardware
To read: SF<CR>		
Response:	SFn	

11. LAN (Local Area Network) control commands

Below is a command format for LAN control:

IP sub command parameter

(Note: No space must be inserted between the sub command and parameter.)

11-1 Readout settings from the optional LAN-box

IP RED	IP RED
	(Note: Each sub command will display all its stored data value on the AR2300 until data readout is completed. Therefore, it is recommended to use this command before changing /displaying the LAN settings.)

11-2 Write settings to the LAN-box

IP WRT	IP WRT
	(Note: This command is to write parameters to the LANBox. Beware that using this command will write all parameters stored on the AR2300 to the LANBox before executing the IP RED command. This may result in the loss of parameters on the LANBox.)

11-3 IPv4 address

IP IPF	IP IPFx.x.x.x x: 0 ~ 255 (IP address) (default: 192.168.0.234)
To read: IP IPF<CR>	
Response: IP IPFx.x.x.x	

11-4 Mask address

IP MSK	IP MSKx.x.x.x x: 0 ~ 255 (Mask address) (default: 255.255.255.0)
To read: IP MSK<CR>	
Response: IP MSKx.x.x.x	

11-5 Gateway address

IP GAT	IP GATx.x.x.x x: 0 ~ 255 (Gateway address) (default: 192.168.0.1)
To read: IP GAT<CR>	
Response: IP GATx.x.x.x	

11-6 DHCP client function

IP DHC	IP DHCn	n: 0, 1 0: Disable (default) 1: Enable
To read: IP DHC<CR>		
Response: IP DHCn		

11-7 Ping response

IP PIN	IP PINn	n: 0, 1 0: Disable 1: Enable (default)
To read: IP PIN<CR>		
Response: IP PINn		

11-8 TCP port number

IP TCP	IP TCPnnnnn	nnnnn: 10000 ~ 65535 (default: 50002)
To read: IP TCP<CR>		
Response: IP TCPnnnnn		

11-9 UDP port number

IP UDP	IP UDPnnnnn	nnnnn: 10000 ~ 65535 (default: 10002)
To read: IP UDP<CR>		
Response: IP UDPnnnnn		

11-10 MAC address

IP MAC	IP MAC	(Read only) (default: 0.0.0.0.0.0)
To read: IP MAC<CR>		
Response: IP MACx.x.x.x.x.x		

11-11 Username

IP USR	IP USRccccccc	ccccccc:username (up to 8 characters including numbers, underscores) (default: username)
To read: IP USR<CR>		
Response: IP USRccccccc		

11-12 Password

IP PAS	IP PAScccccccccccccccc ccccccccccccccc: Password (6 ~ 15 characters including ! # \$ % & - = ^ : @ + * ? _) (default: password) (Note: Password MUST be set.)
To read: IP PAS<CR>	
Response: IP PAScccccccccccccccc	

12. SD (SDHC) card commands

SD sub command parameter

12-1 Property of SD card

SD INF	SD INF (Direct command) Displays the card's total size and its usage. Note: After deleting files, remove the SD card from the slot once. Then re-insert the card to display the free space.
---------------	--

12-2 Display file directory

SD DIR	SD DIR (Direct command) Displays the card's file directory, recorded time and file size.
To read: SD DIR<CR>	

12-3 Delete data file

SD DEL	SD DEL xxxxxxxx xxxxxxxx:file name
---------------	--

12-4 Format card

SD FMT	Format the card
---------------	-----------------

12-5 Write data to SD card

SD MMW (for debug only)	SD MMW (file name) (Direct command) Saves the receivers current state & settings (internal memory content only) (Note: File name: up to 8 characters. The file extension will be automatically set to .mmd).
------------------------------------	---

12-6 Read data from SD card

SD MMR (for debug only)	SD MMR (file name) (Direct command) Loads a receivers's current state & settings (internal memory only)
------------------------------------	---

12-7 Squelch skip

SD RSQ	<p>SD RSQ n n:0, 1</p> <p>0: recording audio even while squelch is closed. 1: recording audio only while squelch is open. (default:: 0)</p>
To read: SD RSQ<CR>	
Response: SD RSQ n	

12-8 Start/stop recording

SD REC	<p>SD REC (file name) (Direct command)</p> <p>Execute the command to start/stop recording audio onto the designated file. (Note: 1. File name: up to 8 characters. English letters (capital) and some selected characters can be used as a file name. The file extension will be automatically set to .wav. If the file name already exists, it will be automatically overwritten. 2. To stop recording, use the "/" as a file name. 3. If the file size exceeds 2GB, it will stop recording.</p>
---------------	--

12-9 Start/stop playback

SD PLY	<p>SD PLY (file name) (Direct command)</p> <p>Execute the command to start/stop playback audio from the designated file. (Note: 1. File name: up to 8 characters. English letters (capital) and some selected characters can be used as a file name. The file extension will be automatically set to .wav. 2. To stop playback, use the "/" as a file name.</p>
---------------	--

Note: Following characters cannot be used as a file name:

¥ / , ; : * ? " < > | .

12-10 Recording status

SD PST	SD PST
(Commands can be sent even during playback or recording)	
Response:	<p>0: stand-by mode 1: recording audio even while squelch is closed. 2: Playback mode 3. recording audio while squelch is open or stand-by mode.</p>

13. Other control commands

13-1 Receiver status

13-1-1 Receiver status

RX	RX<CR>
<p>Response:</p> <p>In VFO mode: VX RFnnnn.nnnnnn STnnn.nnnn(+) AUn MDnn ATnm ANnn</p> <p>In Memory receive mode: MXnnmm GAn MPn RFnnnn.nnnnnn STnnn.nnnn(+) AUn MDnn ATnm ANnn TMxxxxxxxxxxxx</p> <p>In Memory scan mode: MS MXnnmm GAn MPn RFnnnn.nnnnnn STnnn.nnnn(+) AUn MDnn ATnm ANnn TMxxxxxxxxxxxx</p> <p>In Select scan mode: SM MXnnmm GAn MPn RFnnnn.nnnnnn STnnn.nnnn(+) AUn MDnn ATnm ANnn TMxxxxxxxxxxxx</p> <p>In Normal search mode: SRnn RFnnnn.nnnnnn STnnn.nnnn(+) AUn MDnn ATnm ANnn TMxxxxxxxxxxxx</p> <p>In FFT search mode: FFnn FSnn FT- nnn</p> <p style="text-align: center;">(Note: The (+) sign for the ST command will appear when the step adjust function is activated.)</p>	

13-1-2 Receiver status auto report

RT	RTnnnn n: 0, 1~ 6000 (in 10 mS) 0: Disabled
To read: RT<CR>	
Response: RTnnnn	

13-2 Product version

VR	VR (Direct command)
To read: VR<CR>	
<p>Response: Cxxxxxxxxxxx Dxxxxxxxxxxx C: Main board D: Decoder board</p>	
VRF	VRF (Direct command)
To read: VRF<CR>	
<p>Response: F:xxxxxxxxxxx D:xxxxxxxxxxx F: FPGA version D:DSP version</p>	

13-3 Reset

RS	RS (Direct command)
Response:	This command reinitializes the system configuration, however, contents of VFO and/or memory channels will be saved.
RS2	RS2 (Direct command)
Response:	This command reinitializes the system configuration and VFO data, however, contents of memory channels will be saved.
RS!	RS! (Direct command)
Response:	This command reinitializes the receiver and returns it to factory's default settings.

13-4 Flash memory

MM	MM (Direct command)
Response:	Save current settings to flash memory.

14.

GENERAL

Frequency range	40kHz to 3.15GHz
Frequency resolution	1Hz
Tuning steps - program	1Hz to 999.999kHz in 0.001kHz increments
Receiving mode	USB/LSB(J3E), CW(A1A), AM(A3E), FM(F3E), WFM(F3E), FM-Stereo(F8E), APCO P-25(D3E) Optional
Number of VFO	5 (A through E)
Memory channel	2,000 channels (50 channels x 40 Memory banks)
Memory bank	40 banks (each bank can be customized between 5 to 95 channels)
Pass frequencies	1,200 frequencies or 1,200 frequency ranges 30 frequencies(ranges) x 40 banks
Priority channel	1 (one)
Selected memory channel	100 channels through memory banks
Typical scanning speed	Approx. 100 channels/steps per second
Antenna impedance	50W
Operating temperature range	0°C to +50°C / 32°F to 122°F
Frequency stability	Less than ±1ppm after warm-up (5 minutes). Less than ±0.01ppm with optional GPS unit.
Power supply requirement	DC 10.7V to 16V, 2.0A @ 12V
Audio output	> 2W into 8W load
Power consumption*	Stand-by : 200mA, Max. Audio : 1.5A
Ground system	Negative ground
Dimensions*	285mm(D) x 220mm(W) x 70mm(H) 11¼" (D) x 8½" (W) x 2¾" (H)
Weight*	3kg. (6.6 lb.)

RECEIVER

Receiver system	40kHz - 25MHz	Direct conversion
	25MHz - 220MHz	Double super-heterodyne
	220MHz - 360MHz	Triple super-heterodyne
	360MHz - 3.15GHz	Double super-heterodyne
Intermediate frequencies	1st -	294.5MHz / 1.7045GHz
	2nd -	45.05MHz / 294.5MHz
	3rd -	45.05MHz
Third-order IMD	> +20 dBm	at 14.1MHz
	> +9 dBm	at 50MHz
	> +5 dBm	at 620MHz
Spurious and image rejection	> 70dB :	40kHz - 25MHz
	> 50dB :	25MHz - 2GHz
	> 40dB :	2.0GHz - 3.15GHz
Digital IF filter bandwidth	200Hz, 500Hz, 1kHz, 3kHz, 6kHz, 15kHz, 30kHz, 100kHz, 200kHz - Receiving mode depended	
Selectivity	CW - 500Hz	-3dB: > 380Hz -80dB: > 500Hz
	AM - 6kHz	-3dB: > 5.5kHz -80dB: > 6.9kHz
	SSB - 3kHz	-3dB: > 2.7kHz -80dB: > 3.1kHz
	NFM - 15kHz	-3dB: > 14.2kHz -80dB: > 15.6kHz
	WFM - 200kHz	-3dB: > 200kHz -80dB: > 250kHz

Sensitivity

Mode	SSB, CW	AM	FM	WFM
Test Method	10dB S/N	10dB S/N	12dB SINAD	12dB SINAD
Filter B/W	3kHz	6kHz	15kHz	200kHz
40kHz to 100kHz	2.0µV	4.0µV	/	
100kHz to 1.8MHz	1.2µV	2.0µV		
1.8MHz to 25MHz	1.0µV	2.0µV	/	
25MHz to 1GHz	0.25µV	1.0µV		
1GHz to 2.4GHz	0.3µV	1.0µV	0.5µV	1.5µV
2.4GHz to 3GHz	0.5µV	1.7µV	0.5µV	2.5µV
3GHz to 3.15GHz	1.0µV	2.0µV	0.8µV	3.5µV

AUXILIARY FUNCTIONS

Simultaneous reception	Two types of simultaneous reception (dual-watch) are possible.
2 band reception	One HF (40kHz-25MHz) frequency plus one VHF/UHF(25MHz and above) frequency.
Offset reception	Main frequency plus sub-frequency (within ±5MHz from the center frequency) Offset reception is possible only for VHF/UHF.
Triple reception	Triple receptions are possible by combining simultaneous reception mode. I.E. One HF frequency plus offset reception.
Squelch system	CTCSS, DCS
Demodulation Aid	Auto Notch Filter(NOTCH), De-Noise(NR), Noise Blanker, IF Shift, CW Pitch, AGC, AFC, DTMF APCO P-25 Digital voice decoder (option)

AUDIO RECORDING

Type of recording	Record/Playback function through SD or SDHC
SD card type	SD or SDHC card per SD Card Association More than 256MB is required. Use card adapter for miniSD and microSD cards. FAT16 and 32 only.
File Format	Windows compatible WAV file format. RIFF (little-endian) data, WAVE audio, Microsoft PCM, 16-bit mono 17.578kHz
Recording time	Approximately 8 hours of continuous recording by 1GB SD Card. Squelch synchronization is possible to eliminate inactive time.

INPUT & OUTPUT

Antenna Input	ANT 1: 25MHz - 3.15GHz, N-J connector ANT 2: 40kHz - 3.15GHz, N-J connector
10MHz reference input	SMA-J connector, Typical input: -2dBm±2dBm for 50Ω
45.05MHz Analog IF output	BNC-J connector, 45.05MHz±7.5MHz Typical output: Antenna input +10dBm for 50Ω Frequency range 25MHz - 3.15GHz only.
Digital I/Q output (Option)	USB2.0 compatible isochronous transfer Digital I/Q output through USB Type-A Jack. Frequency range 25MHz - 3.15GHz only.
12kHz offset output	12kHz offset analog I/Q through 3.5mmΦ stereo-phone jack.
Line output	3.5mmΦ stereo-phone jack. (3-wire)
Accessory	8-pin miniature DIN
DC Power Input	EIAJ MP-121C (5.5 x 2.1mm) plug. Positive center.
External speaker	3.5mmΦ miniature phone jack (2-wire)
RS-232C	9-pin D-subminiature type (Male) - Firmware update and remote control by PC.
USB	USB Type-A; USB 1.1/2.0 Jack for PC control.
VIDEO output (Front Panel)	RCA Jack, 75Ω 1V p-p

Specifications subject to change without prior notice for product improvement or modification. * Power consumptions, size and dimensions are only approximate value. Dimensions does not include projections. E. & O. E.

15. I/Q DIGITAL OUTPUT DETAILS FOR DEVELOPPERS

1 GENERAL

The I/Q digital output of the AR2300 represents the actual signal used after digital processing in the receiver. The digital I/Q output interface streams I/Q data to the PC through USB2.0 isochronous mode, with nearly 72Mbps wide bandwidth.

A Windows XP/VISTA/7 device driver is provided free of charge for software developers, to allow them to develop their own I/Q software, or to integrate the AR2300 I/Q acquisition feature to their existing software..

2 SIGNAL FLOW

In the AR2300 circuitry, 45.05MHz of intermediate frequency (IF) is being sampled directly at 36MHz. No AGC is applied at the preceding stage in order to obtain a digital signal with wider dynamic range.

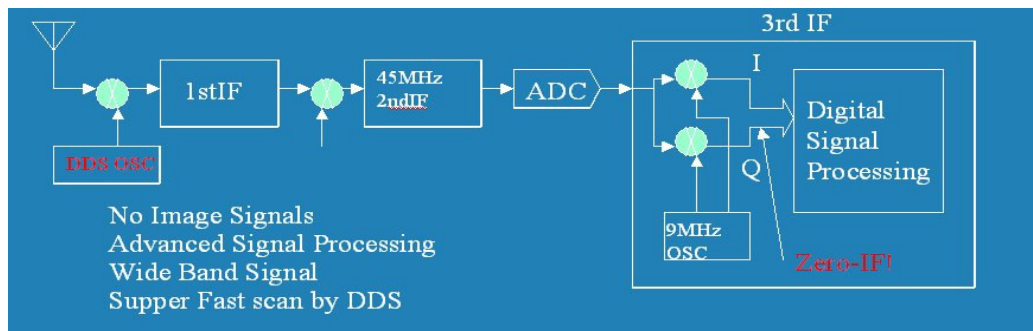

The output of the ADC is digitally heterodyned to ZERO frequency to obtain an I/Q signal. Thereafter, the I/Q signal is being filtered to limit the bandwidth and further down sampling for DSP processing.

The USB2.0 is running at a top speed of approx. 100Mbps in isochroous mode in order to obtain the continuous signal flow.

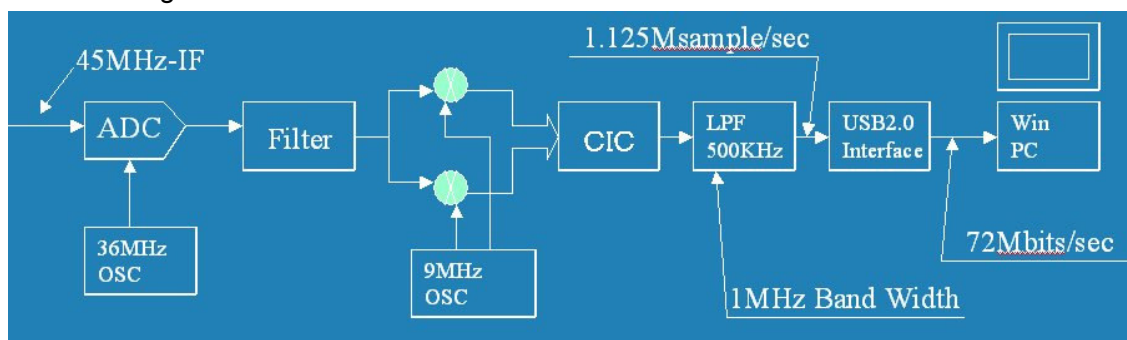

The I/Q output utilizes a CIC filter to simplify the circuit. And the signal flows through FIR Low Pass filter for getting rid of the alias produced by the CIC filter. The signal is processed into 1MHz bandwidth and 1.125Msamples/sec.

3. DATA FORMAT

- 1) Sampling Rate: 1.125Msample/Sec
- 2) USB: 72Mbit/sec., Isochronous (USB2.0)
- 3) Data Format:

Fix Point(2's compliment)

I: = (29..0): 30bits

Q:= (29..0): 30bits

USB data Stream One Sample = (16bitsWord x4)

MSB	LSB
I-High(29..15) 15bits	1 1 st Word
I-Low (14..0) 15bits	0 2 nd Word
Q-High(29..15) 15bits	0 3 rd Word
Q-Low(14..0) 15bits	0 4 th Word

4)USB Interface: ENDPOINT 6

5) USB driver for Windows XP/VISTA/7

4.USB DRIVER INSTALLATION

To install the driver, the following files are required.

- AORAlpha.sys AR-ALPHA USB Client Driver
It will be copied in the Windows directory system32\drivers"
- AORAlpha.inf AR-ALPHA USB client driver inf file
- AORAlphaDD.h IoControl type / Structure / Includes the files that defines GUID etc...

5.NOTE FOR PC SOFTWARE DESIGN

To read the I/Q data, the client driver needs to be interfaced for data acquisition.

The data acquisition is easily accomplished by a simple setup. The test program "AR-ALPHA TestAPP", written by C++ can be supplied by AOR. (Sample code is supplied with this software.)

5.1 Get the device path

The supplied client driver needs to obtain the device using **SetupDiXXX()** API functions before opening driver by **CreateFile()** API. This is because the driver interface uses GUID for the application.

Following is an example to get the device.

(a) OPEN DEVICE SET

Obtain device information by SetupDiGetClassDevs() API

(b) LIST AVAILABLE DEVICES

Call SetupDiEnumInterfaceDevice() API with loop.

(c) GET DEVICE PATH

detailData (Device Information of Structurer) ->devicePath (Set member)

(d) OPENING DEVICE THAT HAS ACQUIRED

It can be opened by CreateFile() API

The GUID of the driver is defined under GUID_CLASS_ALPHA of the included file of AORAlphaDD.h

5.2 FUNCTIONS REFERENCE

The following table describes the functions and arguments in DeviceIoControl()API that are unique to the AR-ALPHA client driver. The structure and control code described here are defined in the AORAlphaDD.h.

NOTE: Receiving the Isochronous data is handled by ReadFile()API.

5.2.1 ALPHA_BULKOUT

CONTROL CODE	ALPHA_BULKOUT
PROPTO-TYPE	<pre> BOOL DeviceIoControl(HANDLE hDevice, // = DEVICE HANDLE DWORD dwIoControlCode, // = ALPHA_BULKOUT LPVOID pInBuffer, // = PALPHA_BULKOUT_PRM DWORD nInBufferSize // = sizeof(ALPHA_BULKOUT_PRM)-1+DATA SIZE LPVOID lpOutBuffer, // = NULL DWORD nOutBufferSize, // = 0 LPDWORD lpBytesReturned, // = POINTER LPOVERLAPPED lpOverlapped // = Overlapped POINTER); </pre>
FUNCTION	OUTPUT TO THE END-POINT OF BULK-OUT OF AR-ALPHA
STRUCTURE	<pre> typedef struct _ALPHA_BULKOUT_PRM { UCHAR ucEndPoint; // OUTPUT END^POINT ULONG ulSize; // OUTPUT DATA SIZE (BYTE) UCHAR ucaData[1]; // OUTPUT DATA POINTER } ALPHA_BULKOUT_PRM, *PALPHA_BULKOUT_PRM; </pre>
NOTE	Include header : AORAlphaDD.h

5.2.2 ALPHA_BULKIN

CONTROL CODE	ALPHA_BULKIN
PROPTO-TYPE	<pre> BOOL DeviceIoControl(HANDLE hDevice, // = DEVICE HANDLE DWORD dwIoControlCode, // = ALPHA_BULKIN LPVOID lpInBuffer, // = PALPHA_BULKIN_PRM DWORD nInBufferSize, // = sizeof(ALPHA_BULKIN_PRM) LPVOID lpOutBuffer, // = POINTER FOR INPUT BUFFER DWORD nOutBufferSize, // = INPUT BUFFER SIZE (BYTE) LPDWORD lpBytesReturned, // = POINTER FOR VARIABLES TO RECEIVE TRANSFER BYTE. LPOVERLAPPED lpOverlapped // = Overlapped POINTER); </pre>
FUNCTION	Input data from the end-point of the BULK-IN for AR-ALPHA
STRUCTURER	<pre> typedef struct _ALPHA_BULKIN_PRM { UCHAR ucEndPoint; // INPUT END-POINT ULONG ulSize; // INPUT DATA SIZE (BYTE) } ALPHA_BULKIN_PRM, *PALPHA_BULKIN_PRM; </pre>
REMARK	AORAlphaDD.h (INCLUDE HEDAER)

5.2.3 ALPHA_START_CAPTURE

CONTROL CODE	ALPHA_START_CAPTURE
PROPTO-TYPE	<pre> BOOL DeviceIoControl(HANDLE hDevice, // = DEVICE HANDLE DWORD dwIoControlCode, // = ALPHA_START_CAPTURE LPVOID lpInBuffer, // = PALPHA_CAPTURE_PRM DWORD nInBufferSize, // = sizeof(ALPHA_CAPTURE_PRM) LPVOID lpOutBuffer, // = NULL DWORD nOutBufferSize, // = 0 LPDWORD lpBytesReturned, // = POINTER FOR VARIABLES TO RECEIVE TRANSFER BYTE. LPOVERLAPPED lpOverlapped // = Overlapped POINTER); </pre>
FUNCTION	Start data acquisition from the end-point of ISOCHRONOUS-IN of the AR-ALPHA.
STRUCTURER	<pre> typedef struct _ALPHA_CAPTURE_PRM { UCHAR ucIsoInEndPoint; // DATA END POINT } ALPHA_CAPTURE_PRM, *PALPHA_CAPTURE_PRM; </pre>
NOTE	INCL. HEADER AORAlphaDD.h

5.2.4 ALPHA_STOP_CAPTURE

CONTROL CODE	ALPHA_STOP_CAPTURE
PROTO-TYPE	<pre> BOOL DeviceIoControl(HANDLE hDevice, // = DEVICE HANDLE DWORD dwIoControlCode, // = ALPHA_STOP_CAPTURE LPVOID lpInBuffer, // = PALPHA_CAPTURE_PRM DWORD nInBufferSize, // = sizeof(ALPHA_CAPTURE_PRM) LPVOID lpOutBuffer, // = NULL DWORD nOutBufferSize, // = 0 LPDWORD lpBytesReturned, // = POINTER FOR VARIABLES TO RECEIVE TRANSFER BYTE. LPOVERLAPPED lpOverlapped // = Overlapped POINTER); </pre>
FUNCTION	Start data acquisition from the end-point of ISOCHRONOUS-IN of the AR-ALPHA.
STRUCTURER	<pre> typedef struct _ALPHA_CAPTURE_PRM { UCHAR uclsolnEndPoint; // DATA END-POINT } ALPHA_CAPTURE_PRM, *PALPHA_CAPTURE_PRM; </pre>
REMARK	INCLUDE HEADER AORAlphaDD.h

APPLICATION NOTE

CALLING PROCEDURE

Typical driver calling procedure is as follows:

Opening DRIVER	Get the device handle through CreatFile API.
Starting isochronous reception	DeviceIoControl API(ALPHA_START_CAPTURE)
Capturer Start	Send DeviceIoControl API(ALPHA_BULKOUT)
Acquiring Captured Data	Call ReadFile API to acquire captured data
Capturer End	Send DeviceIoControl API(ALPHA_BULKOUT)
Ending isochronous reception	DeviceIoControl API(ALPHA_STOP_CAPTURE)
Closing Device	CloseHandle() API to close device

NOTE:; Set size above 512x3x1024 to read with ReadFile()

Size is defined as kMinReadSize in AORAlphaDD.h

REGISTRY INFORMATION

The registry information for the driver is as follows:

NOTE: Initial values are described in INI file.

REGISTRY PATH:

:¥HKEY_LOCAL_MACHINE¥SYSTEM¥CurrentControlSet¥Services¥ALPHA

Value Type	Default (hex)	DESCRIPTION
	Range (hex)	
Type	1	Service type is a kernel driver.
	Fixed Value	
Start	3	This driver will be loaded at the time of PnP.
	Fixed Value	
ErrorControl	1	Error message will be generated when driver encounter the error.
	Fixed Value	
Group	Extended Base	“Extended Base” is a group to load at the time of boot.
	Fixed Value	
DebugInfo	101	Debugging control flag for kernel debugger.
	0~ffffff	

16. RESET

Should the AR2300 appear to behave strangely, normal operation may be easily achieved by resetting the microprocessor. Two scenarios may be encountered due to power transients etc:

- Symptom:** No control of the receiver from a PC.
Action: Turn off the power switch on the front panel. Leave it off for approximately 30 seconds. Turn the power switch back on again.
Normal operation should be restored but the last used frequency will be lost. The AR2300 will restore the second-last frequency to display.
- Symptom:** The PC screen freezes.
Action: Reboot your PC and run the control program again.

Should AR2300 still behave strangely, (while the receiver is ON) push the internal reset button "S3" which is accessible through the bottom case as illustrated:
(the case does not need to be opened)

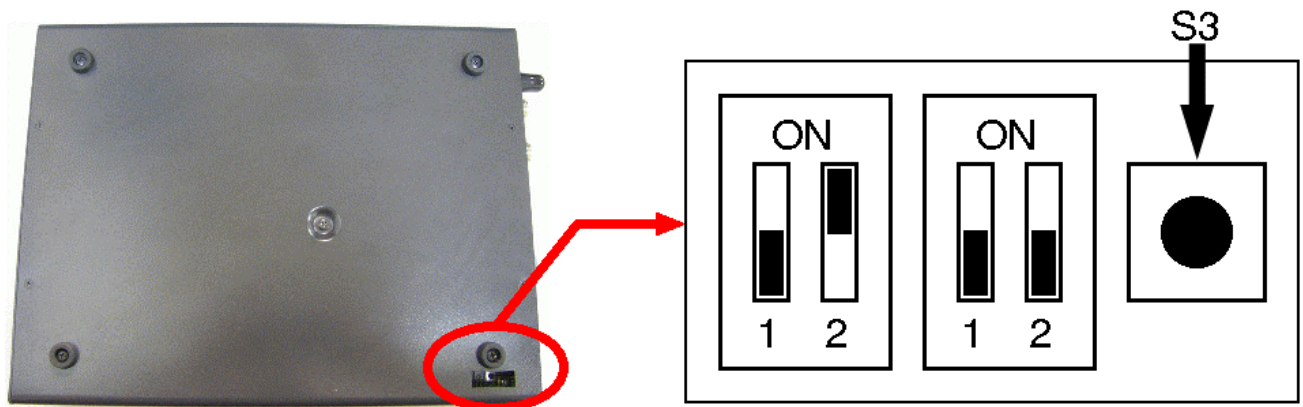

17. FIRMWARE UPGRADE

FIRMWARE VERSION CHECK

Switch AR2300 on, start the AR2300 Control software and go to:

SETTING > OPTION

The firmware version appears at the bottom of the window, as follows:

C2300_Main_XXXX DYYYY (for example C2300_Main_001G D001D)

Where XXXX is the “Main” (controller-board) firmware version, and YYYY the decoder board firmware version.

If a firmware newer than the version in your AR2300 is available, proceed as described below.

SOFTWARE & HARDWARE REQUIRMENTS

3. AOR’s original software “SHBOOT”.
4. PC running Windows 2000 or XP SP2, or newer, with a vacant serial communication port (COM port).
5. Serial cable (female-female). **UPDATE DOES NOT WORK THROUGH USB!**
6. 2 boot files and 3 firmware files supplied by AOR

Do not perform an update if the firmware version is already the newest available.

HOW TO ACCESS

Power OFF AR2300.

Access the DIP SWITCH area as illustrated. You do not need to open the receiver!

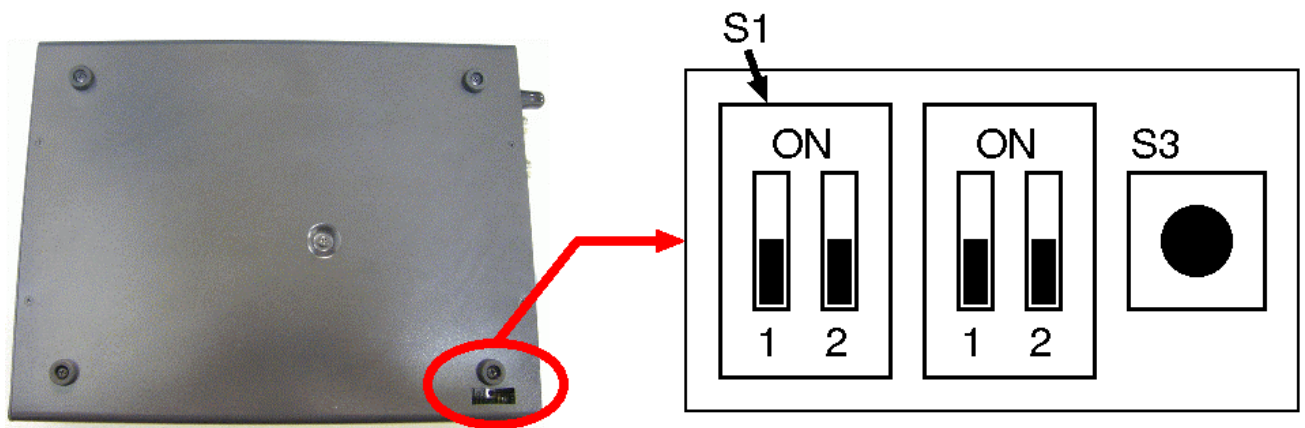

These are the default dip switch positions

To update the firmware, DIP switches need to be repositioned. The previous illustration shows the location of the DIP switches, and their default (factory setting) position.

Only the area labeled **S1** needs to be repositioned. Do not touch the other dip switches and button.

LOADING DATA

Start the flash writer program (SHBoot) by double clicking the SHboot icon. The following screen should be seen.

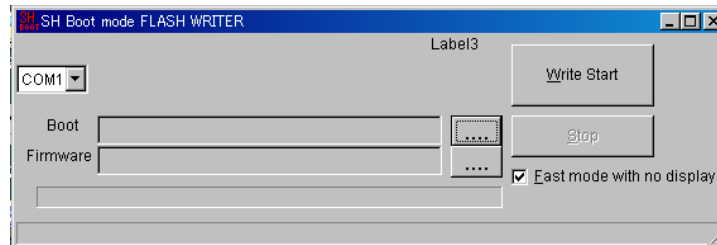

Each block must be updated one at a time.

Do not perform an update if the firmware version is already the newest available.

Proceed in the following order:

AR2300 is OFF.

- ① Set the dip switches properly
- ② Power on AR2300
- ③ Load the BOOT file
- ④ Load the FIRMWARE
- ⑤ Click on WRITE START
- ⑥ Power OFF AR2300 and start again from STEP 1 if you need to update another block.

To load the data, click the button  to choose the appropriate data file as summarized in the following table.

Between these 2 updates it is necessary to boot the receiver once during 30 seconds, with the dip switches in their default position!

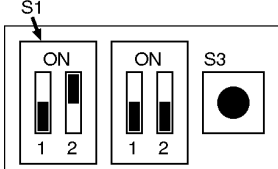
UPDATE BLOCK	DATA FILE NAME		DIP SWITCHES
	Boot	Firmware	
MAIN (controller) BOARD	boot_AR2300_Control.mot	AR2300_CT_init_XXXXXX.mot	
		BB_CT_01_XXXXXXXXXXXX.mot	
DECODER BOARD	boot_AR2300_Decoder.mot	ar2300-dec-XXXX.mot	

When all updates are done, do not forget to set the dip switches into their DEFAULT position.

CHECK IF THE NEW FIRMWARE HAS BEEN CORRECTLY LOADED

Switch AR2300 on, start the AR2300 Control software and go to:

SETTING > OPTION

The firmware version appears at the bottom of the window, as follows:

C2300_Main_XXXX DYYYY (for example C2300_Main_001G D001D)

Where XXXX is the “Main” (controller-board) firmware version, and YYYY the decoder board firmware version.

18. OPTIONAL ACCESSORIES

- **I/Q board & I/Q software**

With this optional internal I/Q unit, a full 1 MHz of bandwidth activity (25MHz to 3.15GHz) can be stored to the hard drive of a computer for later analysis and review, without loss of quality



- **APCO P-25 board**



With this optional internal board, APCO25 digital voice communication (non-encrypted, conventional mode) may be decoded.

Format popular in North-America for government and public safety communications.

- **USB to LAN interface box**

With this optional external LAN interface unit, the AR2300 can be controlled via the internet. All the control commands for the LAN interface are the same as the USB control commands.

- **GPS receiver**



With this optional external GPS unit, the internal reference oscillator of the AR2300 will be locked with the GPS frequency standard signal and provide a 0.01 ppm of accuracy for the 10MHz internal master oscillator.

(3rd party product, design might change)

● ANTENNAS

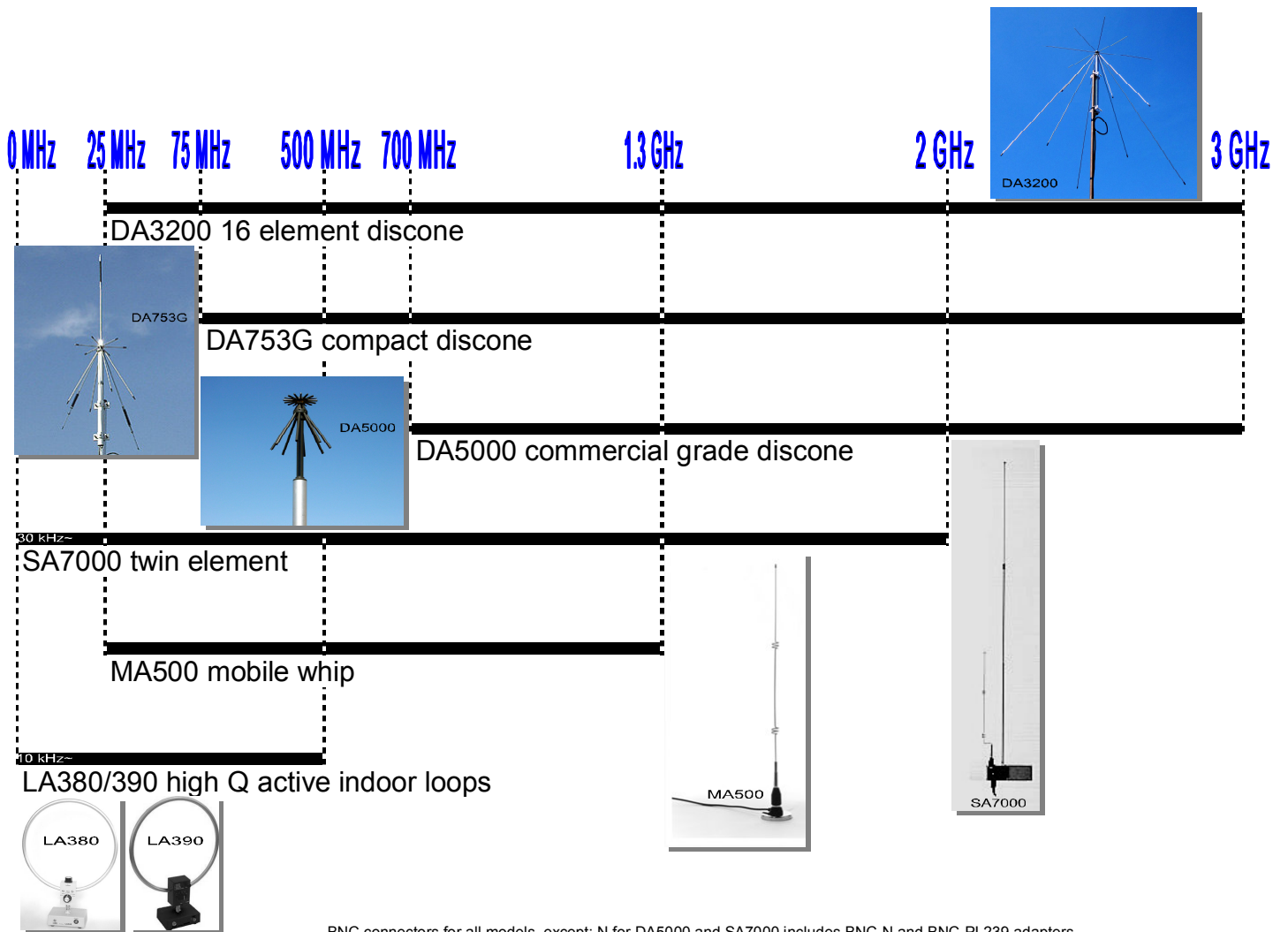

BNC connectors for all models, except: N for DA5000 and SA7000 includes BNC-N and BNC-PL239 adapters

Note: DA753G is sold under the name DS3000A in the U.S

19. LIMITED WARRANTY (USA only)

AOR USA, Inc. (AOR) warrants its receivers as described below:

AOR will repair or exchange equipment as a result of defects in parts or workmanship for a period of one year from the date of original retail purchase from an authorized AOR dealer.

Exclusions

The following items are not covered by the AOR limited warranty:

1. Products that are damaged through accident, abuse, misuse, neglect, or user modifications.
2. Problems that arise through failure to follow directions in the owner's manual.
3. Exposure of the product to adverse or severe weather conditions, including lightening, temperature extremes or water, including rainfall or immersion.
4. Exposure to toxic materials, biohazards, radioactive materials or other contamination.
5. Repairs attempted by parties other than AOR or its authorized personnel.
6. Damage that results from improper installation, including improper voltage and/or reversed polarity, or exposure of a receiver to signal levels exceeding specifications.
7. Damage resulting through the use of accessories from manufacturers other than AOR.
8. Equipment that has had serial numbers removed or altered in any way.
9. Damage that occurred as a result of shipment. Claims must be presented to the carrier.
10. AOR is not responsible for any costs arising from installation or reinstallation of the equipment, nor for any consequential (such as loss of use) damage claims.

Obtaining Warranty Service

1. You are responsible for shipping the product to AOR and any related costs.
2. Warranty claim must be accompanied by a legible copy of the original product purchase receipt.
3. You must include a description of the problem(s) encountered with the product.
4. You must include your name, a valid ground shipping address (including zip code) and telephone contact information.
5. AOR will ship the repaired (or replaced) product by ground transport.

Limitations

Any and all implied warranties, including those pertaining to merchantability and utility for a specific purpose are limited to the duration of this limited warranty.

AOR's limits on warranty pertain only to the repair or, at its option, replacement of defective products. AOR shall not be liable for any other damages, including consequential, incidental or otherwise, arising from any defect.

Some states do not allow limitations on how long an implied warranty lasts and may not allow the exclusion of incidental or consequential damages. As such, the above limitations may not apply in every case. This warranty gives you specific legal rights and you may have other rights that apply in your state.

If you have questions about this limited warranty, or the operation of your AOR product, contact AOR at (310) 787-8615 during normal business hours (9 am ~ 5 pm Pacific Time Zone), or write to AOR, 20655 S. Western Ave., Suite 112, Torrance, CA 90501. You may also send a fax to AOR at (310) 787-8619. Additional information is available at the AOR web site: www.aorusa.com

We suggest attaching your purchase receipt to this half of the warranty card and keeping this information in a secure location.

AOR Model Number _____

Serial Number _____

Dealer Name _____

Purchase Date _____

Manufacturer: **AOR, LTD.**
 2-6-4, Misuji, Taito-Ku,
 Tokyo, 111-0055, Japan
 URL: www.aorja.com
 e-mail: mail@aorja.com

US distributor: **AOR USA, INC.**
 20655 S. Western Ave. Suite 112
 Torrance, CA 90501
 Phone: 310-787-8615
 Fax: 310-787-8619
 URL: www.aorusa.com
 e-mail: info@aorusa.com