

C.CRANE CC SKYWAVE SSB

INSTRUCTION MANUAL

PLEASE READ ALL THE INSTRUCTIONS
COMPLETELY BEFORE USE AND SAVE
THIS MANUAL FOR FUTURE REFERENCE



Introduction/Safety Instructions

The CC Skywave SSB radio opens the door to a fantastic world of information and entertainment at home or on the go. The standard AM and FM bands allow for listening to local radio stations near your home, or around the world when traveling. In the USA, Canada and parts of northern Mexico local weather information, forecasts and warnings are available at the touch of a button on the WX (weather) band. The AIR band enables reception of both aircraft and air traffic control (ATC) at or near airports, or just about anywhere on or near land within about 200 miles. For long distance listening, the Skywave SSB covers the international shortwave bands (SW). In addition to standard SW broadcast stations such as BBC, VOA, Radio Japan and many others, the Skywave SSB can, using the special built-in SSB (single sideband) mode, receive ham radio operators, long-range aviation (commercial and military), maritime, space and even spy transmissions from all over the world, no satellites or Internet required! Have fun and enjoy the amazing tool of adventure and discovery you now have in your hands!

If you have any questions about your radio, please give us a call or check out ccrane.com

READ BEFORE OPERATING EQUIPMENT - SAVE THESE SAFETY INSTRUCTIONS

1. Read and understand all safety and operating instructions before the radio is operated.
2. Heat: Never put the radio in direct sunlight in an unventilated area or behind glass like a car's interior. The appliance should be away from heat sources such as radiators, heat registers, stoves, or other appliances that produce heat.
3. If the radio is left unattended and unused for long periods of time, remove the batteries. The batteries may leak and damage furniture or your radio.
4. The user should not attempt to service the appliance beyond that described in the operating instructions.
5. Although very high quality parts were used in the manufacturing of your radio, buttons, knobs, and dials should be operated with a light touch for best longevity.
6. All other servicing should be referred to qualified service personnel.

WARNING: DO NOT CHARGE ALKALINE BATTERIES. Use only the recommended power adapter that we supply for recharging NiMH batteries.

CAUTION

- Before turning the unit on, set your volume control to a low setting.
- Slowly increase the sound until you can hear it comfortably and clearly without distortion.
- Long-term exposure to loud sounds may cause hearing damage. It is best to avoid high volume levels when using headphones/earbuds, especially for extended periods.

For your future reference:

Serial No. _____ (Found inside battery compartment) Date of purchase _____

Name & address of dealer _____

The box should contain the CC Skywave SSB, CC Buds earphones, Carry Case, Shortwave Antenna, warranty card, and this manual. If anything is missing or damaged, please contact your dealer immediately. We recommend you keep the packaging in the unlikely event your radio will need servicing.

Table of Contents

Introduction/Safety Instructions.....	3-4	Setting Narrow AM/SW/Air Bandwidth Filter.....	14
Getting Started.....	6	Battery Charging.....	15
Installing the Batteries.....	6	Setting the Fine Tuning For SSB.....	15
Radio Identification - Display.....	7-8	Setting the Alarm.....	15-16
Quickstart guide for SSB.....	9	Changing Between Upper and Lower Sideband.....	16
Powering the Radio.....	10	Setting the Time.....	17
Setting the Sleep timer.....	10	Activate SSB Mode.....	17
Saving a Station to Memory.....	10	Changing Time Format.....	17
Changing AM/FM Bands.....	11	Weather, Shortwave, SSB, and Air Bands.....	17-19
Setting Weather Alert.....	11	Scanning Air Band Presets.....	19
Enter a Frequency Directly.....	11	Positioning the Whip Antenna.....	20
Changing Pages.....	11	Fast or Slow Tuning with Knob.....	20
Changing the Audio Tone.....	11	Setting the Squelch for Airband.....	20
How the Display light Works.....	12	Setting the Volume.....	21
Automatically Setup Presets.....	12	Listening with Earphones.....	21
Locking Radio Functions.....	13	Resetting the Radio.....	22
Changing Meter Bands in SW and SSB.....	13	Disable Beep Sound.....	23
Scanning Meter Bands.....	13	Designate Frequency or Clock While Listening.....	23
Setting Stereo or Mono Reception.....	13	Factory Reset all Settings.....	23
Listening with Speaker.....	13	Troubleshooting Guide.....	24
Activate 9 or 10 kHz AM Tuning.....	14	Specifications.....	26
Expanding the FM Band.....	14		

Getting Started

Installing the Batteries

1. Position the radio face down on a soft surface to protect it.
2. Remove the battery cover by applying pressure and sliding downwards towards the bottom of the radio.
3. Insert the two (2) "AA" alkaline or NiMH cell batteries into the compartment as indicated. Be sure the negative (-) end of the battery is against the spring.
4. Replace the battery cover. You are now ready to operate your radio.

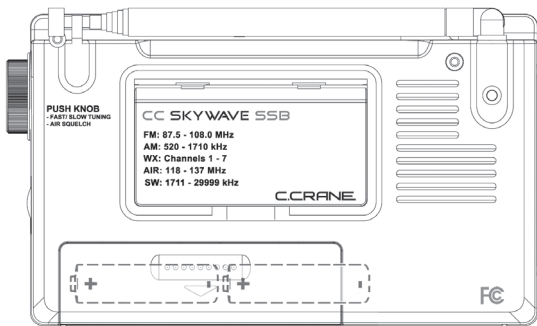

Two (2) "AA" alkaline or NiMH batteries.
DO NOT USE LITHIUM BATTERIES.
NOTE: You will have 30 seconds after batteries are removed before the clock and alarm settings are lost. We recommend having your new batteries ready to insert immediately after removing the old ones.

In our test, (going slowly) it took us about 15 seconds to add the new batteries after removing the old ones. The memory presets and other settings are stored in permanent memory so they will not be lost if the radio is unpowered for a duration of time.

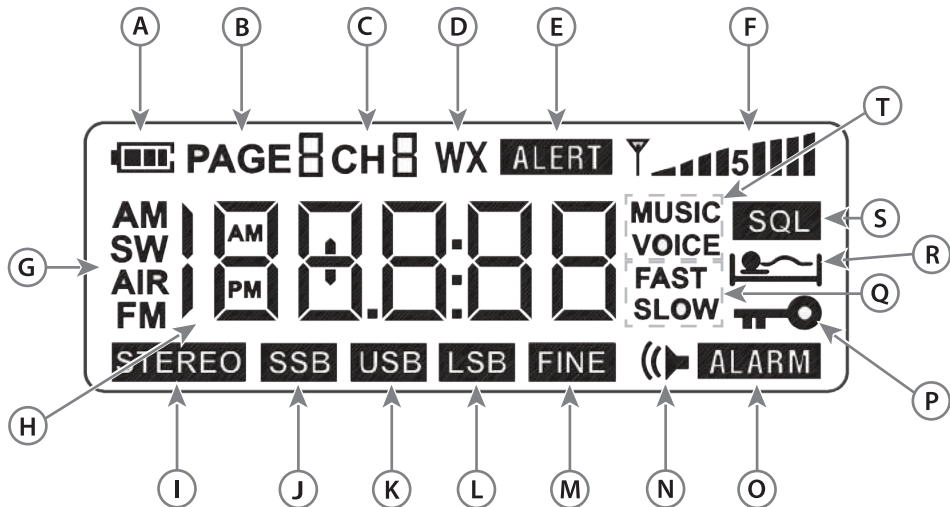

- A. Battery Icon / Charge Indicator
- B. Page Number (for station memories)
- C. Station Memories 0-9
- D. Weather Band Indicator
- E. Weather Alert is Activated
- F. Reception Signal Strength
- G. Band Indicators (AM, SW, AIR, FM)
- H. Frequency / Time
- I. Stereo FM Reception
- J. Single Sideband Activated
- K. Upper Sideband Activated
- L. Lower Sideband Activated
- M. Fine Tuning for SSB Activated
- N. Alarm Set for Radio Station
- O. Alarm is Activated
- P. Radio is Locked
- Q. Tuning Speed with Knob
- R. Sleep Timer is Activated
- S. Squelch
- T. Audio Filter for Music or Voice

Quick Start Guide for Single Sideband Users

Here are a few tips for those new to tuning Single Sideband (SSB) voice transmissions:

- A. Use the WX/SW/AIR button to switch to the SW (shortwave) bands. On the keypad press the FREQ button and enter the lower frequency of one of the ham bands like 7125. Press the SSB button. Make sure the display shows LSB (lower sideband), if it shows USB (upper sideband), then press the USB/LSB button to go to the LSB mode. LSB is the standard mode on 3600-4000kHz and 7125-7300kHz.
- B. It is recommended to fully extend the whip antenna.
- C. Go to the slow 1kHz tuning mode by pushing the main dial in and start tuning up the band. When you hear an odd sounding duck-like voice, use the main tuning dial to tune the signal until it sounds as good as possible, then press the FINE button and tune the main dial in the fine-tuning mode until the voice sounds normal.
- D. Listening suggestions:
 - a. Daytime – try: 7125-7300kHz (LSB), 14150-14325kHz (USB) or 21200-21450kHz (USB)
 - b. Nighttime – try: 3600-4000kHz (LSB) or 7125-7300kHz (LSB)

Note: Radio conditions on SW change every day like the weather. Sometimes you may hear many stations on the air, and sometimes just a few or even none. Evenings and weekends tend to be the best times to listen. There is more to learn by going to www.ccrane.com or searching the Web.

Radio Operation

1. Power button / Sleep Timer

To turn the radio "ON", press and release the red button. To use the Sleep Timer, press and hold the red button while the radio is off. The display will cycle through minutes 120, 90, 60, 45, 30, 15, and OFF. Release the power button to activate the sleep setting you desire. The radio will remember your last Sleep Timer setting for the next time you activate it. The Sleep Timer will automatically shut off the radio after the set amount of time expires.

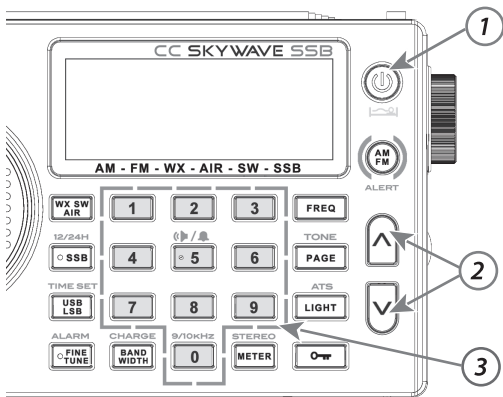

2. Up and Down Tuning Buttons

Press once quickly to tune to the next frequency increment. Press and hold for 2 seconds to automatically tune to the next strong station. Hold continuously to cycle through the whole band.

3. Memory Preset Buttons 0-9

Save your favorite stations to memory buttons. To save a station, press and hold any memory button for 2 seconds while the station is playing. To play a saved station, press the same button once quickly.

Note: The CC Skywave SSB is a "smart" radio and will remember current settings when a station is preset into memory. The current settings that will be saved with your station are: 1. Stereo or Mono selection on FM. 2. Bandwidth selection on AM, Shortwave, or Air bands. 3. Tone settings.

Radio Operation

4. AM/FM/NOAA Weather Alert

Press the AM/FM button once quickly to switch between AM and FM bands. For NOAA Weather Alert: Press and hold this button to activate the weather alert for 4, 8, or 16 hours. Release button to make selection. To disable alert, press and hold this button for 2 seconds. Note: While the radio is OFF with ALERT activated, it will continue to use the same amount of power as if the radio were fully ON. The light will continue to flash indicating alert is ON and working. Turning the alert OFF when not needed will help conserve batteries.

5. Frequency Button

When you are in your selected band, this button lets you directly enter the frequency number of your desired station using the number buttons. For example, to play 1480 kHz in the AM band, quickly press the **FREQ** button and then enter 1, 4, 8, 0 using the number buttons. NOTE: When manually entering SW frequencies 2300 to 2610, you must press the **FREQ** button after entry.

6. Page Button/Changing Tone

Each memory page allows you to save 10 additional stations per band. To change to a different page, press the **PAGE** button once quickly, then press any memory button 0-9 to select the Page that you desire. To change between Music and Voice tones, press and hold this button for two seconds. Display will switch between 'Music' and 'Voice'.

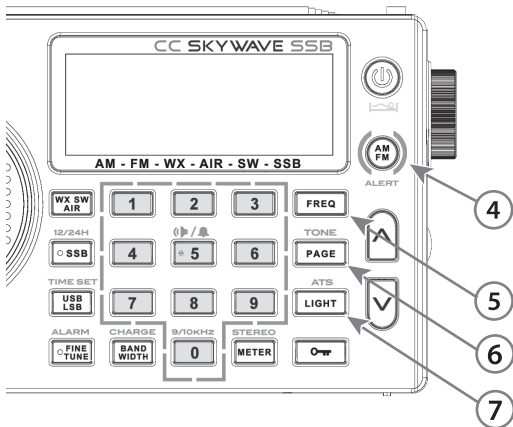

7. Light/ATS Button

When using batteries, if the LIGHT button is pressed, then the display light will turn on for 20 seconds. When using the AC Adapter (sold separately), if the LIGHT button is pressed with radio ON, then the display light will remain on all the time. Press the LIGHT button again to turn off the display light. If you press any button thereafter, the light will only turn on for 10 seconds. NOTE: It is not possible to keep the display light OFF all the time.

- **Automatic Tuning System (ATS).** This feature programs all receivable stations in the AM, FM, Air and Shortwave bands to memory buttons. To use ATS, select your desired band: AM, FM, Air or Shortwave, and press and hold the ATS button for two seconds. The CC Skywave SSB will scan the entire band and automatically set all available stations in sequence 1-10. If more than 10 stations are available then the remaining stations will be preset to the next memory page, and so on.

Radio Operation

8. Lock Button

The lock button will disable all buttons and controls, except the volume control. A Key icon will display on the screen when the radio is locked. To enable the lock, press and hold the lock button  for two seconds. To disable press and hold again for two seconds. If the lock button is pressed one time quickly then the display screen will toggle between frequency and clock for 10 seconds.

9. Meter / Stereo Button & Changing Meter Bands

In the Shortwave Band, the METER/STEREO button will change between popular Broadcast Meter Bands. In SSB mode, the METER/STEREO button will change between popular Amateur Radio Bands.

NOTE: Your last used frequency in each meter band will be automatically remembered for later access.

TIP: To scan only the current meter band for an active frequency, press and hold the METER/STEREO button for 3 seconds.

- Stereo or Mono Reception

In the FM band the METER/ STEREO button will cycle between stereo and mono FM reception. Typically, FM Mono will have better reception than FM Stereo.

NOTE: If a station does not broadcast in stereo or the radio cannot lock onto the stereo signal, the radio will only receive FM mono and the stereo symbol will not be displayed.

10. Speaker

The speaker will be disabled when headphones are plugged into the headphone jack.

Radio Operation

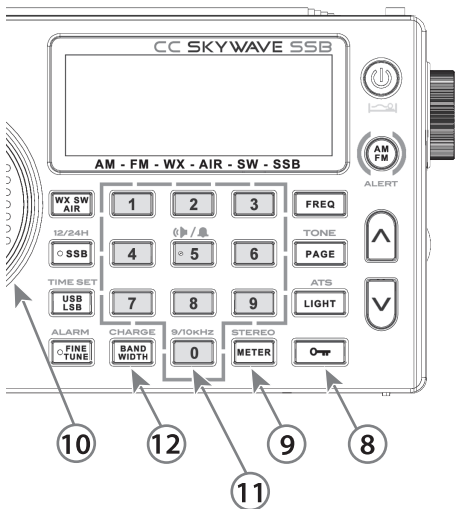

11. *Activate 9 or 10 kHz Tuning Button - Expand FM Band*

Many parts of the world, including Europe, use 9kHz tuning steps for the AM band. 10kHz tuning steps for AM are used in the USA and other regions. Switch tuning steps by holding the 9/10kHz button for two seconds with the radio turned off. When tuning, steps are set to 9 kHz the FM Band will also be expanded to cover 76-108 MHz (FM band in Japan).

12. *Bandwidth/Charge Button - Bandwidth Filters (for AM,*

SW / SSB, and Airband only) On AM, SW, and AIR bands there are five bandwidth settings that can be used to filter out unwanted noise or adjacent overlapping stations. On SSB there are six bandwidths available. Quickly press the BAND WIDTH button to view the current selection. Press it again to choose the setting that sounds best to you. A narrow bandwidth of 1 kHz may work best when receiving a weak or noisy signal. For strong local signals 6kHz is usually best, especially for music. If the station is changed then the radio will return to the default bandwidth setting. By default, the CC Skywave SSB is set to 3kHz

Radio Operation

bandwidth for good audio, noise filtering, and voice duality. The default bandwidth can be changed by holding down the bandwidth button for more than five seconds with the power OFF. Release the button to choose the displayed selection.

Tip - AM / SW: Scan tuning on AM and Shortwave works best when keeping the default bandwidth setting of 3KHz.



Tip - SSB: Best SSB reception is normally achieved with the BAND WIDTH set to 3KHz. When noise is low and there is no interference from nearby stations, a BAND WIDTH setting of 4kHz will provide higher fidelity audio.

- **Charging:** Use the CC Skywave SSB to recharge your NiMH type batteries. Supply power to the CC Skywave SSB from AC power adapter (not included). With the radio powered off, press the CHARGE button one time to begin charging. The battery icon  on the display will begin to cycle indicating that the batteries are charging. Charging will continue for 10 hours or until the batteries are full. If you turn the radio on during the charge cycle, (see page 21) the battery icon may indicate charging although it is not. Please be sure to keep radio turned off when charging.

WARNING - DO NOT ATTEMPT TO CHARGE ALKALINE OR OTHER NON-NiMH BATTERIES. SEE PAGE 6 FOR SAFETY INSTRUCTIONS.



13. Fine Tune/Alarm Button

Fine tune SSB with 10 Hz resolution for better audio/reception. While in SSB mode, press the FINE TUNE button once quickly, then rotate the tuning knob until the desired resolution is achieved. When finished, press the FINE TUNE button again to exit.

- **Setting the Alarm:** With the radio powered off, press and hold the ALARM button for two seconds. While the hour is flashing, press the  or  tuning buttons (or rotate knob) until the hour ALARM and AM/PM time is correct.

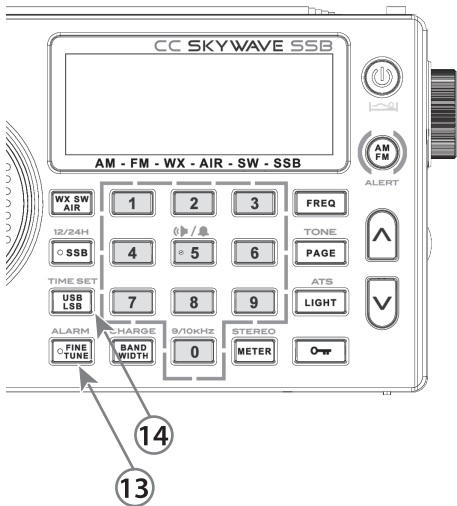
Radio Operation



Press the ALARM button again to adjust the minutes. When finished, press the ALARM button again to confirm. To disable alarm, press the ALARM  button for three seconds. By default, the alarm will wake you with a beep. To wake to a radio station, press the #5 button during alarm setup. A speaker icon  displays on the screen indicating that the alarm will wake to the previous radio station played. It is best to check the station frequency and adjust the volume level to your wake-up preference before going to sleep to ensure that is just how you want it. When the alarm sounds, press the power button to turn the alarm off, or press any other button to sleep for 10 more minutes.

14. USB / LSB / Time Set Button

Change between Upper (USB) and Lower (LSB) sideband while in SSB mode. Since there are two sidebands to each frequency you can choose which sideband you want. There may be two different broadcast on the same frequency with SSB so you must choose which to listen to with

Radio Operation

this button. Press the USB LSB button to cycle between Upper and Lower sidebands.

- **Setting the time:** With the power off, press and hold the TIME SET button for two seconds. While the hour is flashing, press the tuning buttons (or rotate knob) until the hour and AM/PM time is correct. Press the TIME SET button again to adjust the minutes. When finished, press the TIME SET button again.

15. SSB / 12-24 Hour Button

About SSB

If you have never tried to listen to Single Sideband, you are in the majority. On Single Sideband, you can listen to hams, long range aviation (commercial and military), maritime, space and even spy transmissions from all over the world. It is the most efficient and reliable way to communicate long range without the Internet or satellites. There is more to learn by going to ccrane.com and searching on your own.

- **To activate SSB mode:** Press the WX SW AIR button up to 3 times until the SW band is selected. Enter Single Sideband (SSB) mode by pressing the SSB button now. A red light will appear on the SSB button to indicate that SSB mode is active. To return to normal SW broadcast, press the SSB button again.
- **Switch between 12-hour time and 24-hour time:** With the radio OFF, press and hold the 12/24H button for two seconds to change this setting.

16. WX/SW/AIR

Weather, Shortwave, SSB, and Air bands

Quickly press the "WX/SW/AIR" button to cycle between Weather, Shortwave, and AIR bands.

Radio Operation

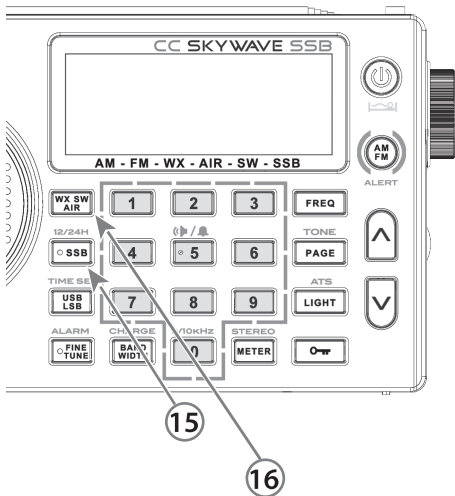

About the Weather Band

The CC Skywave SSB can receive all 7 NOAA weather band channels. NOAA is short for National Oceanic and Atmospheric Administration. It is a network of stations across the USA and territories that continuously broadcasts local weather and forecasts. Emergency Alerts are issued for serious weather conditions and public safety information. Enable the ALERT feature to be notified when a warning is issued in your area (See page 11). Fully extend the whip antenna for best reception.

About the Shortwave Band

With shortwave, you can listen to radio signals from around the world. Signals are usually received best at night and early morning when the earth's ionosphere does not cause interference with the bouncing signals. The CC Skywave SSB has several bandwidth filters to reduce interference. Select which one sounds best by pressing the "BANDWIDTH" button after a station is tuned in.

Radio Operation

About the Air Band

With air band, you can listen to communications between pilots and control towers. Basic instructions for moving the plane and updates for weather and possible delays can also be heard. Many airports broadcast continuous feed that updates frequently for this information. To find station frequencies that are used for your airport, we recommend searching the internet. One good site is: [*www.radioreference.com*](http://www.radioreference.com)

Scanning Air Band Presets

Tip: It is possible to scan 10 of your favorite aviation frequencies and monitor transmissions. Add each of the frequencies you want to scan to the first 10 memory presets on page 1, then press the UP and DOWN tuning arrows at the same time.

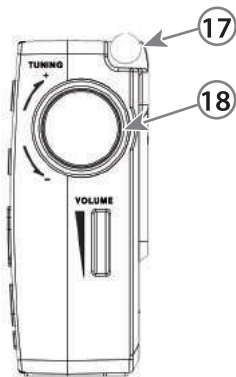

17. FM/WX/AIR/SW/Antenna

Flip up and fully extend the whip antenna. For most stations, reception is best when antenna is positioned vertically. Other stations may have better reception with the antenna positioned differently.

18. Tuning Knob

Rotate knob to tune to the next frequency increment. Press the knob "IN" towards the body of the radio (once quickly) to change between "FAST" and "SLOW" tuning increments when rotating the knob. "FAST" tuning will use larger incremental steps between frequencies. "SLOW" tuning can improve AM stations that are slightly off frequency on poor signals. Try tuning 1 kHz higher or lower than the actual station frequency to see if reception improves.

Squelch Mode

Squelch Mode only works on the Air band. Press and hold the tuning knob "IN" towards the body of the radio (for 2 seconds) to activate. "OFF" will appear on the display screen. Rotate the knob to adjust the level of squelch desired. The optimal level is usually the

Radio Operation

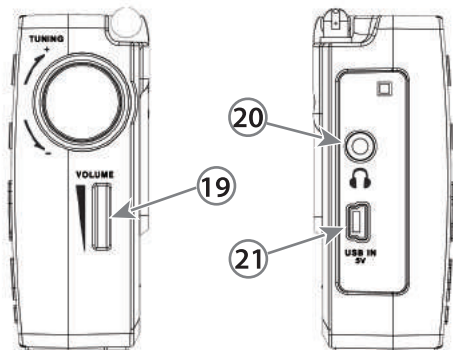

lowest number that does not have background noise. With squelch turned "OFF", you may be able to receive some very weak signals that do not register when the squelch is enabled. Press the tuning knob "IN" towards the body of the radio one time to save the current squelch setting.

19. Volume Control

Rotate the small wheel up for more volume and down for less volume.

20. Earphone Jack

For private listening, use headphones or earbuds. This jack can also be used as an audio output to another device.

21. USB Power/Charging Jack

You can power your radio or charge NiMH type batteries with the USB jack connected to a computer or USB power adapter (not included). (See page 15).

Radio Operation

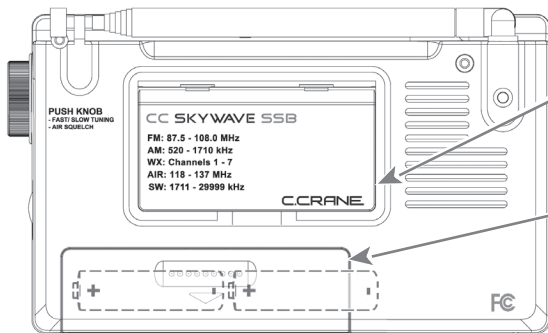

Back of Radio



Bottom of Radio

22. Back Stand

Flip this panel out to prop up your radio for easy use of the controls, best audio and for viewing positioning.

23. Battery Compartment

Requires two AA alkaline or NiMH batteries. DO NOT USE LITHIUM BATTERIES.

24. Reset Hole

Quickly press into the reset hole on the bottom of the radio to reset the microprocessor. It is recommended to use a toothpick or other soft device to reset the radio. Do not press too hard as you might damage the radio. See Page 23 for resetting all to factory settings.

Hidden Settings

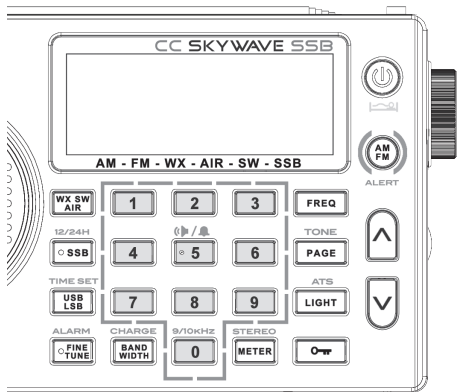

Disable Beep Sound

With the power OFF, press and hold memory button #3 **3** for two seconds. All beeps are disabled except ALARM and WX ALERT. Repeat sequence to enable beep again.

Designate Frequency or Clock while Listening to the Radio

With the power OFF, press and hold memory button #4 **4** for two seconds. A "C" will appear on the screen indicating that the clock will show while listening to radio. Repeat sequence to display Frequency instead. "F" will appear on the screen to indicate that the frequency will show when listening to the radio.

Reset All Settings

With the power OFF, press and hold memory buttons #4 **4** and #6 **6** for five seconds. The radio will beep four times indicating that all settings have been restored back to the factory defaults.

Troubleshooting Guide

The CC Skywave SSB will not turn on and none of the buttons work:

The Lock button: that is located on the front of the radio may be activated. When activated, a key icon will show on the display screen. Push lock button for 2 seconds to resume normal operation of the radio. (Please see "Lock Button" on page 8.

My radio shuts off after just a few seconds:

Low batteries can cause this situation. Replace them with a new set of batteries.

Stations won't hold in memory:

The memory button settings are being overwritten. When recalling a station from memory, if you hold the memory button down too long it will program the current station over your previously stored station. To recall a station that has been stored in memory, always press and release the button quickly. To program a new station into memory, tune to the desired station and then press and hold the memory button for two seconds until you hear a beep.

Poor reception on AM band:

Rotate the radio until the reception is best. Many buildings that use brick, metal, or stucco can absorb or reflect the AM signal. Computers and other electronic equipment, including fluorescent lights, can cause noise that interferes with your AM reception. Move the radio to a different place to see if that helps. Additional noise may affect a weak signal. There are several bandwidth filters which can help to reduce interference. Select which one sounds best by pressing the "BAND WIDTH" button. For even better reception use an external AM antenna available at www.crane.com

Troubleshooting Guide

Poor reception on Shortwave / SSB band:

Fully extend the whip antenna and adjust its orientation to obtain the strongest signal. There are several bandwidth filters which can help to reduce interference. Select which one sounds best by pressing the "BAND WIDTH" button. Also be sure to try the CC SW Reel Antenna included with the CC Skywave SSB.

Radio Noise Troubleshooting

If you hear an annoying buzz when listening to AM, Shortwave, or SSB radio, it's most likely radio noise. Here are some of the usual culprits:

- Any electronic device such as a computer, smartphone, tablet, TV, printer, etc.
- Any charger or AC adapter box that plugs into the wall outlet.

Possible Solutions:

- Identify the object or device that is creating the interference noise and power it completely off or unplug it from power.
- Use your radio in another location that is away from interfering electronics.

Battery Power Level indicator doesn't show full charge when using rechargeable batteries:

Rechargeable batteries will not show a full charge on your radio display. The CC Skywave SSB is calibrated to read the charge of your alkaline batteries, which is 1.5 volts at full charge. Rechargeable batteries, however, are fully charged at just 1.25 volts, so your radio will show a partial charge even if the rechargeable batteries have been fully charged.

Specifications

FM Band:

87.5 - 108 MHz (Regular Mode)

76 - 108 MHz (Expanded Mode -

See page 14)

AM Band:

520 - 1710 kHz (10kHz)

522 - 1620 kHz (9kHz)

Shortwave Band:

1711 - 29999 kHz

Air Band:

118 - 137 MHz

Weather Band:

Channel 1: 162.400 MHz

Channel 2: 162.425 MHz

Channel 3: 162.450 MHz

Channel 4: 162.475 MHz

Channel 5: 162.500 MHz

Channel 6: 162.525 MHz

Channel 7: 162.550 MHz

POWER SOURCE

Batteries: (2) "AA" size

POWER CONSUMPTION

30 - 100 mA DC (depending on
headphone or speaker usage)

AUDIO

Speaker: 1.5", 25 Ohm, 0.5 Watt

Stereo headphone jack

ANTENNA

FM, Weather, Shortwave / SSB and Air band:

21" Whip Antenna

AM Band: Built-in Ferrite Bar

DIMENSIONS

3" W x 4.75" H x 1.1" D

WEIGHT

Approximately 6.7 ounces without batteries

Note: Specifications are subject to change
without notice.

Model: CC Skywave SSB

FIRMWARE REVISIONS

To find out which firmware revision your model has, press and hold the #1 button for 2 seconds with the radio turned OFF. The display will then show the revision number.

SHORTWAVE BROADCAST METER BANDS

2300 - 2495	120 Meters
3200 - 3400	90 Meters
3900 - 4000	75 Meters
4750 - 5060	60 Meters
5730 - 6200	49 Meters
7100 - 7450	41 Meters
9250 - 9900	31 Meters
11500 - 12100	25 Meters
13570 - 13870	22 Meters
15030 - 15800	19 Meters
17480 - 17900	16 Meters
18900 - 19020	15 Meters
21450 - 21850	13 Meters
25670 - 26100	11 Meters

AMATEUR RADIO BANDS (SSB)

1800 - 2000	160 Meters
3500 - 4000	80 Meters
5330 - 5410	60 Meters
7000 - 7300	40 Meters
10100 - 10150	30 Meters
14000 - 14350	20 Meters
18068 - 18168	17 Meters
21000 - 21450	15 Meters
24890 - 24990	12 Meters
28000 - 29700	10 Meters

THIS DEVICE COMPLIES WITH PART 15 OF THE FCC RULES OPERATION IS SUBJECT TO THE FOLLOWING TWO CONDITIONS. 1) THIS DEVICE MAYNOT CAUSE HARMFUL INTERFERENCE AND 2) THIS DEVICE MUST ACCEPT ANY INTERFERENCE RECEIVED, INCLUDING INTERFERENCE THAT MAY CAUSE UNDESIRE OPERATION.

Notice: Any changes or modifications not expressly approved by the party responsible for compliance could void the user's authority to operate the equipment.

Copyright © 2017 by C. Crane Company, Inc., Fortuna, CA 95540 Phone: 1-800-522-8863 Web: ccrane.com
All rights reserved. No part of this booklet may be reproduced, in any form or means whatsoever, without permission in writing from C. Crane.

R14

Accessories for your CC SKYWAVE



AC Power Adapter



Rechargeable NiMH 'AA' Batteries

Available at ccrane.com or call: 1-800-522-8863