

SERVICE MANUAL

SCANNING MONITOR RECEIVER

VHF Band	26-57.995	MHz
	58-88	MHz
	108-180	MHz
UHF Band	380-514	MHz

MODEL: SX-200 (N)

GENERAL DESCRIPTION

This scanning monitor receiver utilizes a miniature computer-micro-processor with 16 channels in over 32,000 different frequencies such as Police, Ambulance, Rescue, Fire, Paramedic, Government Services, Taxis, etc. which can be monitored, searched, scanned, to memorize without adding expensive crystals. Unknown frequencies can be searched and locked-in. Frequencies can be easily selected by the keyboard operation. An accurate digital clock which displays time is built-in. Amateur bands in VHF and UHF range, T-Band can also be received.

SPECIFICATIONS

1. Type	FM & AM
2. Frequency Range	a) 26.000 ~ 57.995 MHz Freq. Space 5 KHz b) 58.000 ~ 88.000 MHz " " 12.5 KHz c) 108.000 ~ 180.000 MHz " " 5 KHz d) 380.000 ~ 514.000 MHz " " 12.5 KHz
3. Sensitivity	FM . . . a) 26.000 ~ 180.000 MHz 0.4uV S/N 12 db b) 380.000 ~ 514.000 MHz 1.0uV S/N 12 db AM . . . a) 26.000 ~ 180.000 MHz 1.0uV S/N 10 db b) 380.000 ~ 514.000 MHz 2.0uV S/N 10 db
4. Selectivity	FM . . . More than 60 db at ±25 KHz AM . . . More than 60 db at ±10 KHz
5. Audio Output	2 watts (8 ohm) Dev. 5 KHz
6. External Speaker Impedance	4 ~ 8 ohms
7. Power Supply	AC Adaptor (Output DC 12 V) or DC 12 V Power Supply
8. Antenna Impedance	50 ~ 75 ohms
9. Frequency Stability	FM . . . 150 Hz ~ 1.7 KHz (-6 db) AM . . . 300 Hz ~ 1.6 KHz (-6 db)
10. Clock Error	Within 10 sec./month
11. Memory Channel	16 Channels
12. Scan Rate	Fast 8 Channels/sec. Slow 4 Channels/sec.
13. Seek Rate	Fast 10 Channels/sec. Slow 5 Channels/sec.
14. Scan Delay Time	0/2/4 sec.
15. REC Output	0.4 V (MAX.) Output Impedance 8 ohms
16. Intermediate Frequency	FM . . . 455 KHz AM . . . 455 KHz
17. S/N	FM/AM More than 60 db at -30 db
18. Squelch Sensitivity	Less than 10 db
19. Distortion	Less than 2.5% at Dev. 5 KHz 0.5 W (8 ohm)
20. Scan Stop Sensitivity	15 db

CONTROLS AND FUNCTIONS

CONTROL PANEL (FRONT VIEW)

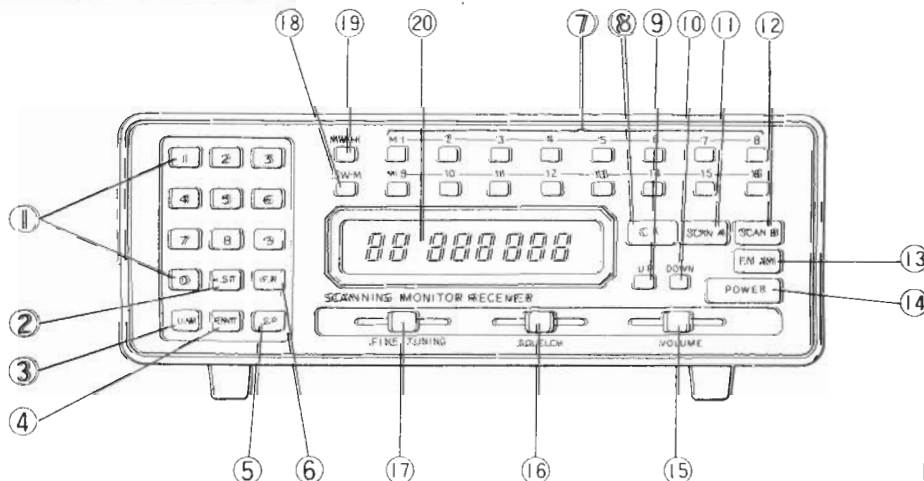

Fig. 1

1. **Keyboard Frequency Selector Buttons (1 – 0)**
Select any frequency in any of three bands – VHF Low, VHF High, or UHF (including the T-Band).
2. **Stop Button & Dot (·) ·ST**
Stops UP or DOWN Seek or Scan A or B function. Places decimal point in selected frequency.
3. **Limit Write Button LIM**
Sets upper and lower frequencies of search range.
4. **Frequency Entry Button ENT**
Is finally pushed to enter frequency.
5. **Speed Change Button SP**
Controls speed variation for UP or DOWN Seek Function.
6. **Frequency Display Button FR**
Interrupts constant time display to show frequency being received.
7. **Memory Read/Display Keys M1 – M16**
Programs your own most-listened to frequencies in any of the three bands. Retrieve any frequency desired when corresponding button is depressed.
8. **Clock Display and Adjustment Button CK**
Brilliant digital LED clock – accurate to the second. Retrieve and adjust time.
9. **Up Button UP**
Starts seeking upwards, moving through frequencies in increments of 5 KHz or 12.5 KHz and stopping on a transmitting channel.
10. **DOWN Button DOWN**
Starts seeking downwards, moving through frequencies in decrements of 5 KHz or 12.5 KHz and stopping on a transmitting channel.
11. **SCAN-A Button**
Scans the 16 memory channels (M1 – M16) stopping on a transmitting channel.
12. **SCAN-B Button**
Scans selected priority channels within the 16 memory channels, stopping on a transmitting channel.
13. **FM-AM Switch**
Selects modulation of frequency to receive, i.e., Amplitude (AM) or Frequency (FM). If desired AM typed modulation for receiving, push this button. If FM typed required, unlock it.
14. **Power ON/OFF Switch**
15. **Volume Control**
Adjusts sound level as desired.
16. **Squelch Control**
Adjusts to block out unwanted noise.
17. **Fine Tuning**
Small frequency adjustment such kind of figures as 5 KHz is made.
18. **Scan Write and Minute Adjustment Button SW·M**
Programs priority memory channels for SCAN-B function and minute.
19. **Memory Write and Hour Adjustment Button MW·H**
Programs desired frequencies into memory channels for SCAN-A function and hour.
20. **Digital Display Panel**
Shows 5-second readout of selected frequencies. Registers passing frequencies during SCAN or UP/DOWN SEEK modes. Shows constant time display (except during SCAN or SEEK modes). Shows time readout when CK button is depressed.

REAR VIEW

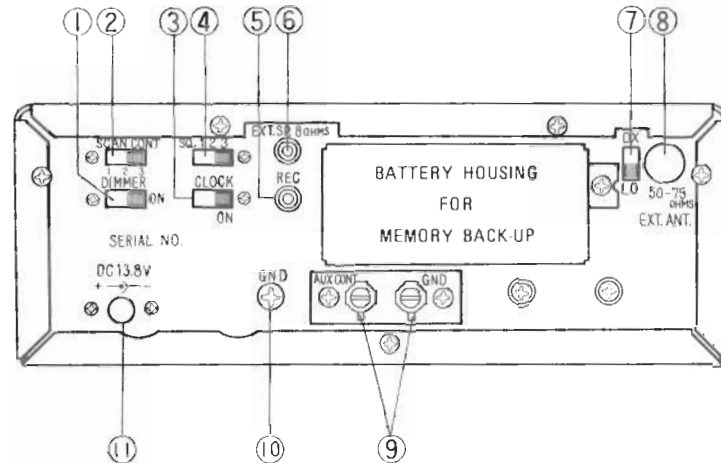

Fig. 2

1. Dimmer Control Switch

Changes light and darkness (ON) of display.

2. Scan Delay Control

Delays resumption of scanning during a pause in transmission. Moving the slide switch to the positions 1, 2 and 3 varies the holding time on a frequency for zero second (Position 1), 2 seconds (Position 2) and 4 seconds (Position 3) respectively.

3. Clock Switch

For only CLOCK (Time) display desired, slide this switch to ON. Under this condition that the POWER switch is off, time always displays. If this operation required, CLOCK switch shall be set to ON position before installation of this unit in a car.

4. Squelch Operation

The SX-200 uses some very unique squelch circuitry which allows THREE DIFFERENT MODES OF SQUELCH operation. These modes are selectable using the rear mounted slide switch marked "SQ".

POSITION 1. Allows for standard "CARRIER" operated squelch ie. Scanning is stopped and Audio is opened by the carrier of the signal received.

POSITION 2. Scanning is stopped by the received signals carrier but the AUDIO is SILENCED until modulation (voice) is put on the carrier (for monitoring telephone channels etc.)

POSITION 3. Scanning will not stop until a carrier with modulation signal (signal with voice) is received. (used when set is in the SEARCH mode.)

Notes: 1. For SQ 1, 2. & 3., in case that squelch volume control in the front panel is positioned at the rightside (FM noise comes out.), frequency will not move in seek or scan modes as far as noise is not blocked out.

2. The condition of AUX Control output will be changed by SQ switch's positions. For SQ 1. or 2., when received wave, AUX terminal will become open electrically. For SQ 3. position, AUX terminal will not become open without sound even though a wave received.

In the event FM noise coming out, AUX control terminal will become open for all the position, SQ 1. 2. 3.

5. Recording Output REC

Connect the input of open reel type or cassette tape deck to record.

6. Output for External Speaker (Optional).

7. Local/Distance Switch

This switch allows for optimum reception in both strong and weak signal areas. It is normally set in the DISTANCE (DX) position for maximum sensitivity. In strong signal areas, stations may interfere with each other. To minimize these interferences, move this switch to LO for LOCAL position.

8. Connection for External Antenna

9. AUX Control Output AUX

On/Off Control of auxiliary equipment (Tape Recorder) using relay. RATING of AUX Cont. terminal: Max. 15 V, Max. 200 mA. The relay satisfying the above rating should be used.

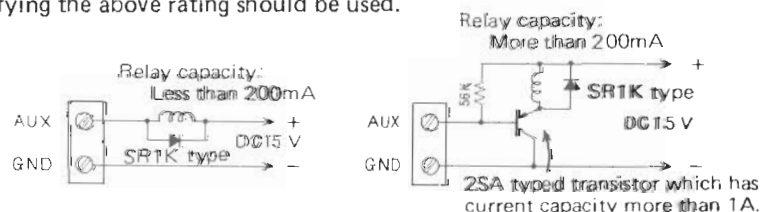

Relay will operate when scanning stops.

10. Ground Connection GND

11. Connection for Power Cord.

INSTALLATION

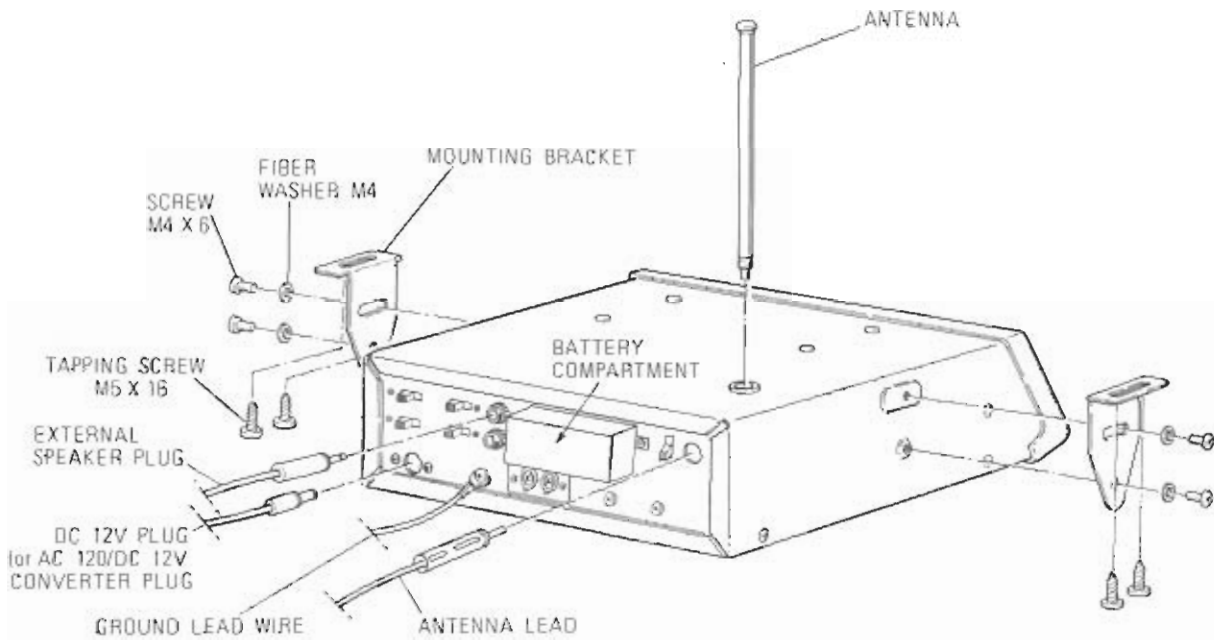

Fig. 3

NOTES: BATTERY INSTALLATION: Before turning your SX-200 on make certain that you install the two SIZE AA BATTERIES supplied in the battery housing on the rear panel being careful to put them in with the correct polarity (Polarity is marked on base of plastic holder.) The batteries are used for memory backup.

SETTING UP YOUR UNIT

1. Connect the power supply, using either AC cord, if the unit is to be used as a base station, or the DC connector for mobile operation. The AC cord includes a DC/AC power adaptor.
2. Turn on Power Switch (#14) by push button in. TIME readout A 0-00 will appear in the Display Panel (#20).
3. Install whip antenna by screwing in clockwise into the connecting hole on top of the unit. The 3-section telescoping antenna supplied with your unit extends from approximately 4 inches to approximately 22 inches for best reception in every band. (The lower the band, the longer the antenna should be extended, and vice versa.)
4. When the power switch (POWER) turns off once and then it turns on again, Time or frequency readout will appear. But if receiving is desired, be certain to push **FR** button.

OPERATION OF SCANNER

1. To select desired frequency

Depress button in the following sequence on the key board.

Examples: **7** → **B** → **-ST** → **B** → **B** → **7** → **ENT**

Display shows 78.887 (Programmed)

4 → **7** → **0** → **-ST** → **3** → **1** → **2** → **5** → **ENT**

Display shows 470.312 (Programmed)

Note: 4 digits after the point is available for display only. But when entry key **ENT** is pushed (actually MUST be pushed to enter the frequency), fourth digit after the point does not display as the above. This means frequency always comes to a very close one that you want to catch. In other words, CUT-OFF or RAISE of FRACTIONS has automatically and suitably been made by our peculiar computer design according to the frequency space, 12.5 KHz or 5 KHz. For 5 KHz space, third digit after the point displays always 5 when pushed **ENT** button. Therefore, further small adjustment required is made by FINE TUNING in the front panel for either 12.5 KHz or 5 KHz.

2. To search or seek (Up or Down) a station

After frequency is entered, depress UP or DOWN seek button to start search. Squelch control must be adjusted to just above noise level to activate search. Channels M1 through M16 can be searched by depressing individual channel buttons and then the UP or DOWN seek button accordingly. Frequencies will be searched in increments or decrements of 5 KHz or 12.5 KHz according to bands.

If exact frequency desired is unknown, enter a frequency a few KHz lower to begin search. For example, if the frequency desired is approximately 470.015, start the search frequency at 469.000 or lower.

To increase seek speed, depress **SP** key. To decrease speed, depress **SP** key again.

To stop seek or scan, depress **•ST** key.

3. To select or enter a frequency into memory bank

A) To enter a frequency being received while seeking, depress the each button according to the order of **•ST** → **ENT** → **MWH** → **M**.

B) If you want to enter a frequency which you have already known, depress button in the following sequence; For example, **4** → **7** → **0** → **•ST** → **0** → **2** → **5** → **ENT** → **MW** → **M**
470.025 (Programmed into memory bank)

If there is more than a 5-second delay in entering the frequency, time will be automatically displayed and you must re-program. If the frequency that was selected is not desired, to reprogram, simply enter new frequency as outlined above.

4. Recall

Once frequency has been programmed, for example, 156.175 is entered into channel M3, by depressing M3, the frequency will be recalled.

5. Scanning "SCAN-A"

To use "SCAN-A" mode, when this button is depressed, all channels from M1 through M16 will be scanned repeatedly until a signal is received. To stop scan, depress **•ST** key. The Scan Delay control located in the rear plate of the unit is used to delay resumption of scanning during a pause in transmission. Moving the slide switch to the positions 1, 2 and 3 varies the holding time on a frequency for zero second (Position 1), 2 seconds (Position 2) and 4 seconds (Position 3) respectively.

6. Scanning "SCAN-B"

"SCAN-B" is a programmable scan mode. It allows the SX-200 to scan any combination of its 16 memory channels. (i.e. you may scan e.g. ch. 3 and 5 or 2, 5 and 10 etc.) Programming of "SCAN-B" is quite simple, for example we wish to scan only channels 1, 2, 15 and 16. The following operation is performed:-

PUSH **•ST** TWICE → **SW M** → **1** → **2** → **15** → **16** → **SCAN B**

Be certain to push **•ST** twice and all other buttons once otherwise scan memory may not write correctly.

7. "FR" key

When TIME is being displayed and you want to see what frequency is being received, press **FR** key to activate display.

8. "CK", "H" & "M" keys

To enter time, for example: for 10.30 AM, the following keys must be depressed in sequence. If the display is showing A 6-15 (A: a.m. & P: p.m.), push **CK** key first, push **H** key 4 times and push **CK** key and push **M** key 15 times. For 10:30 PM, push also **CK** key, push **H** key 16 times (P and 10 will appear.) and push **CK** key, and push **M** key 15 times.

9. Limit Write Key, "LIM"

To enter upper and lower frequency of search range, the following keys must be depressed in sequence:

Upper frequency desired, for example: **470.000** → **ENT** → **LIM** →

→ Lower frequency desired, for example: **450.000** → **ENT**

Now, the search between 450.000 and 470.000 is limitedly made by depressing UP or DOWN key.

To retrieve this limiter, the following operation shall be made.

25.000 → **ENT** → **LIM** → **514.000** → **ENT**

CAUTION

1. When the frequency selection becomes inoperative by some entry mistakes during memory writing or scanning ("E" (ERROR) does not appear on the display), unplug the power supply cord once, leaving power switch on and then plug it again to clear.

2. If you attempt to program a frequency that is outside the tuning range of the receiver, an "E" (ERROR) appears on the display. If this happens, simply enter a new frequency.

3. Under the condition of:

	Clock switch → ON		→ Time displays continuously.
	Power switch → OFF		

But if the power supply cord is disconnected and then re-connected, 89APL-E will appear in the display as error. To retrieve this error, set the clock switch to "OFF" position and frequency readout will appear. Meanwhile if time readout is desired, set the clock switch to "ON" position.

BLOCK DIAGRAM Fig. 4

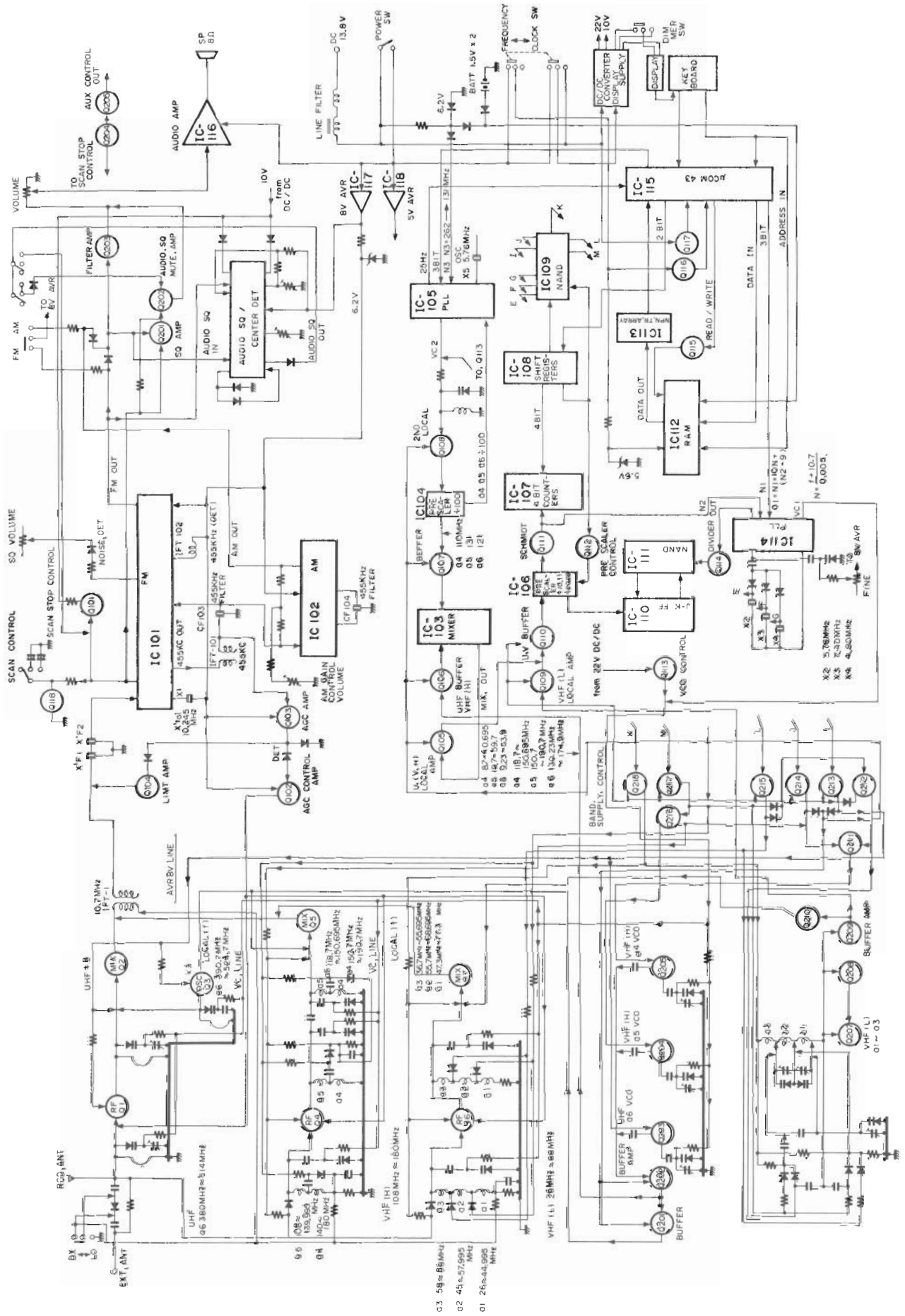

ALIGNMENT PROCEDURE

PLL ADJUSTMENT

1. Sub VCO Frequency Adjustment (110.000 MHz)

Receive 108.000 MHz. Connect the frequency counter with Pin No.13 of IC103 (SO42P) and adjust the trimmer (TC-102) for 110.000 MHz \pm 100 Hz.

2. VHF Local Frequency Adjustment

Set the Fine Tuning volume to the center position and connect the frequency counter with VC01 of Tuner P.C. Board.

Receive Freq.	IF	Local Freq.	Adjustment
26.000 MHz	+10.7	36.700	TC-103
44.995	+10.7	55.695	
45.000	+10.7	55.700	
57.995	+10.7	68.695	
58.000	-10.7	47.300	TC-104
88.000	-10.7	77.300	

3. VHF (High), UHF Local Frequency Adjustment

Connect the frequency counter with VC02 of Tuner P.C. Board.

Receive Freq.	IF	Local Freq.	Adjustment
108.000 MHz	+10.7	118.700	TC-105
139.995	+10.7	150.695	
140.000	+10.7	150.700	
180.000	+10.7	190.700	
380.000	$(380 + 10.7)/3$	130.233	
514.000	$(514 + 10.7)/3$	174.900	

VCO ADJUSTMENT

Apparatus used: Digital Multi-Tester (DC Range)

Connection Method: Connect with VC line of VCO P.C. Board.

1. 26.000 MHz ~ 44.995 MHz

Receive Freq.	Adjustment	Voltage adjusted & allowance
26.000 MHz	L204	0.65 V \pm 0.05 V
44.995 MHz	TC-204	12.1 \pm 0.1

2. 45.000 MHz ~ 57.995 MHz

45.000 MHz	L205	3.7 V \pm 0.1 V
57.995 MHz	TC-205	11.3 \pm 0.1

3. 58.000 MHz ~ 88.000 MHz

58.000 MHz	L206	0.6 V \pm 0.05 V
88.000 MHz	TC-206	12.0 \pm 0.1

4. 108.000 MHz ~ 139.995 MHz

108.000 MHz	L203	0.58 V \pm 0.1 V
139.995 MHz	TC-203	9.65 \pm 0.2

5. 140.000 MHz ~ 180.000 MHz

140.000 MHz	L202	1.3 V $+0.1/-0.05$ V
180.000 MHz	TC-202	13.0 \pm 0.1

6. 380.000 MHz ~ 514.000 MHz

380.000 MHz	L201	0.65 V \pm 0.05 V
514.000 MHz	TC-201	12.4 \pm 0.1

Remarks: Voltage of low frequency shall be adjusted at L-000 (Coils) first, then adjust voltage of high frequency by TC-000 (Trimmers).

If voltage of low frequency varies after voltage adjustment of high frequency, several time adjustment is required.

RECEIVER ADJUSTMENT

Apparatus used: SSG 26 MHz ~ 514 MHz (This should be available for both AM and FM modulation.)
SSG 10.7 MHz, IF GENE-SCOPE, OSCILLOSCOPE, MILLI VOLT METER.

1. Connection Diagram

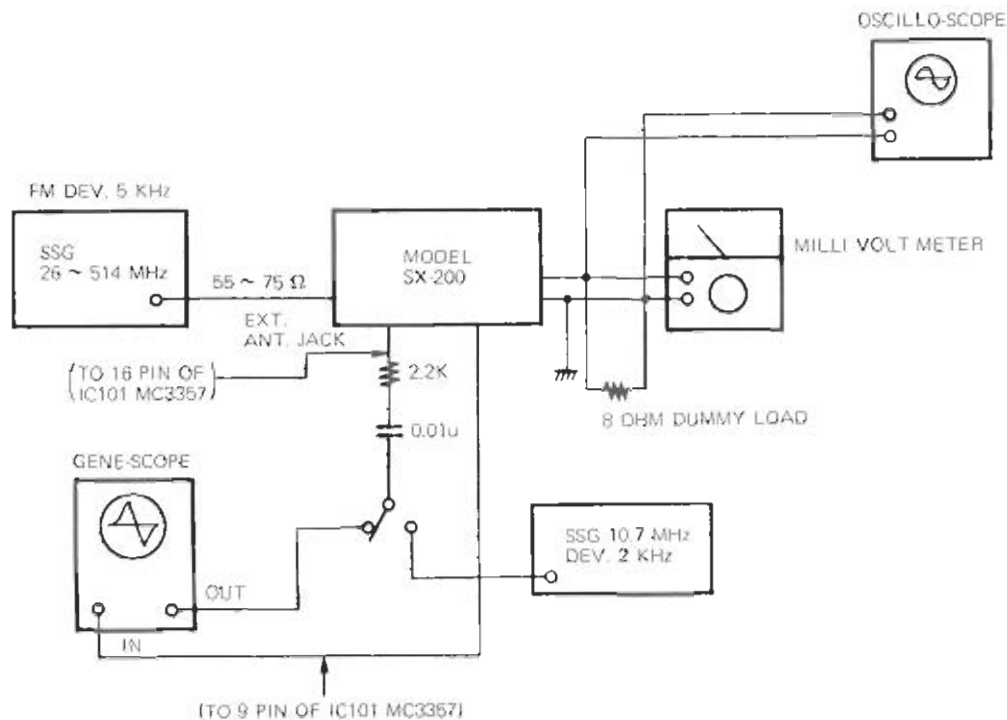

2. IF Adjustment

- Connect SSG (10.7 MHz) (Input 55 db) with Pin No.16 of IC101 (MC3357).
- Adjust IFT101 and TC101 to make the wave form of oscilloscope maximum.

3. "S" Curve Adjustment

- Connect "OUT" of Genescope with Pin No.9 of IC101 (MC3357).
- Adjust IFT102 to make the wave form symmetrical. (For both upper and lower sides.)

TUNER ADJUSTMENT

- Set LO/DX switch to DX position.
- Set Squelch volume to the right side.
- Set Fine Tuning to the center position.
- Set Volume control to the center position.
- Enter a frequency into memory bank which is going to adjust.
- Set SG for 5 KHz FM deviation.

Enter the following frequencies into memory bank **respectively**. To enter a frequency, depress the each button according to the order of, for example **2** → **6** → ***ST** → **0** → **0** → **0** → **ENT** → **MW** → **M1**

M1	26.000 MHz	M2	45.000 MHz	M3	58.000 MHz
M4	108.000 MHz	M5	140.000 MHz	M6	380.000 MHz
M9	44.995 MHz	M10	57.995 MHz	M11	88.000 MHz
M12	139.995 MHz	M13	180.000 MHz	M14	514.000 MHz

Hereafter, entered frequencies into memory bank will be called as M number respectively.

- Set SG for 58.000 MHz and push the memory button M3. Adjust L14 and L18 for the wave form to become maximum.
Set SG for 88.000 MHz and push the memory button M11 and make sure there's no sensitivity difference.
- Set SG for 45.000 MHz and push the memory button M2. Adjust L15 and L19 for the wave form to become maximum.
Set SG for 57.995 MHz and push the memory button M10 and make sure there's no sensitivity difference.
- Set SG for 26.000 MHz and push the memory button M1. Adjust L16 and L20 for the wave form to become maximum.
Set SG for 44.995 MHz and push the memory button M9 and make sure there's no sensitivity difference.
- Set SG for 140.000 MHz and push the memory button M5. Adjust L8, L9 and L11 for the wave form to become maximum.
Set SG for 180.000 MHz and push the memory button M13 and make sure there's no sensitivity difference.

- e) Set SG for 108.000 MHz and push the memory button M4. Adjust L7, L10 and L12 for the wave form to become maximum.
Set SG for 139.995 MHz and push the memory button M12 and make sure there's no sensitivity difference.
- f) Set SG for 380.000 MHz and push the memory button M6. Adjust TC-1, TC-2 and TC-3 for the wave to become maximum.
Set SG for 450.000 MHz and adjust L2.
Set SG for 514.000 MHz and push the memory button M14 and make sure there's no sensitivity difference.

Remarks: If there is sensitivity difference in 380.000 MHz and 514 MHz of UHF, re-adjust the below method.

a. Adjustment of L1 and TC-1

It is the important point to adjust L1 to make the trimmer's positions for 380 MHz and 514 MHz in the same position.

TRIMMER POSITIONS



Best position

Make L value (coil) small.

Make L value (coil) big.

- b. Adjustment of L3 and TC-2 combination.
Same as a.
- c. Adjustment of L4 and TC-3 combination.
Same as a.

3. AM Gain Adjustment

- a) Push **FM-AM** switch for AM position.
b) Receive **125 MHz**. (Set SG input for 125 MHz.)
c) Set SG input for -10 db and adjust VR102 to make signal noise maximum.

4. Fine Tuning

Receive 26.000 MHz and make sure of ± 5 KHz variation, moving the fine tuning control from left side to right side.

ACCESSORY CIRCUITS ADJUSTMENT

1. Center Detector Adjustment

- a. Set SG for 140.000 MHz (Input 60 db)
b. Receive 140.000 MHz
c. Connect Multi-Tester with Pin No.6 of IC201 (uPC324).
d. Adjust the middle voltage by VR202.
(BETWEEN the voltage that the wave form disappears when VR202 is rotated clockwise AND the voltage that the waveform disappears when rotated counterclockwise.)
e. Move the frequency of SG from 140.000 MHz to 140.005 MHz gradually and make sure that the waveform disappears. (140.005 MHz ± 2 KHz)
Then, move the frequency of SG from 140.005 MHz to 139.995 MHz as well and make sure that the waveform disappears. (139.995 MHz ± 2 KHz)

2. Squelch Sensitivity Adjustment

- a. "SQ" change switch in the rear panel shall be positioned to SQ1.
b. Receive 26.000 MHz.
c. Slide the squelch volume gradually to the left side, and stop sliding at the place where the noise disappeared.
d. Set SG for 26.000 MHz and put 10 db (Input) in and make sure that the squelch becomes open.
e. Make sure of all the channel.

3. Audio Squelch Adjustment

- a. Set "SQ" change switch in the rear panel to SQ2.
- b. Set SG for 26.000 MHz (Input: 60 db) and receive.
- c. Set FM deviation 0.5 KHz.
- d. Rotate the screw of VR105 (100 ohms) clockwise until the waveform disappears.
- e. Increasing deviation, make sure that the waveform appears at 1 KHz ~ 2 KHz.
- f. Set "SQ" change switch in the rear panel to SQ3.
- g. Slide the squelch volume to the left side.
- h. Set SG for 30.000 MHz, deviation 5 KHz (Input: 60 db)
- i. Set the frequency for 29.950 MHz on the SX-200 unit and push "UP" button.
- J. Make sure that the frequency stops at 30.000 MHz.
- k. Decreasing deviation, make sure that the waveform disappears at 0.5 KHz ~ 0 KHz and seeks.

Remarks: Dev. 0 KHz ~ 0.5 KHz Audio Squelch – ON
 Dev. 1 KHz ~ 2 KHz Audio Squelch – OFF

4. Scan Delay Time

- a. Connect Multi-Tester with the anode side of D101 (IS953) in the PLL P.C. Board and adjust VR105 (100K) for 0.65 V ±0.1/-0 V.
- b. Set "SCAN CONT" switch in the rear panel to 1 position.
- c. Seeking frequencies, stop at an optional frequency.
- d. When the frequency of SG is moved, make sure that the seeking is made within approximately 2 seconds.
- e. Set "SCAN CONT" switch to 2 position.
- f. As well as b. operation, make sure that the seeking is made within about 4 seconds.

5. LO/DX

- a. Receive 26.000 MHz and set LO/DX switch to DX position.
- b. Set SG input for 1 uV and output level for 1 V.
- c. Change LO/DX switch to LO position, and set for -6 ~ -7 db.

6. DIMMER

When the dimmer switch is ON, make sure that the display will be dark.

7. CLOCK

- a. When the clock switch is ON, make sure that the display will show the TIME.
- b. Even the power switch in the front panel is off, the TIME must be displayed.

8. AUX

- a. Connect the tester with AUX. (OHM range)
- b. Short at scanning or seeking (DC resistor: 0.5 Ω ±0.1)
- c. Must be open at stop condition of scan or seek.

9. REC

- a. Receive 26.000 MHz (Dev. 5 KHz)
- b. Connect Milli-Volt Meter (Load: 10 K ohm) with REC jack.
- c. Make the volume in the maximum position.
- d. Output voltage 0.4 V (±0.1 V)

10. Memory method

Example: 2 → 6 → ·ST → 0 → 0 → 0 → ENT → MW → M1

- a. Enter optional frequencies into memory bank from M1 to M16.
- b. Push the buttons from M1 to M16 again and make sure the said frequencies are the entered ones into memory.
- c. Put the batteries (1.5 V X 2) in the battery box in the rear panel.
- d. Disconnect the power supply (DC 13.8 V) and then connect it again, and make sure the memory entered.

11. SCAN A

- a. Enter optional frequencies into memory bank from M1 to M16.
- b. Close the squelch.
- c. Push SCAN A button.
- d. Make sure that the scanning operation will be repeated from M1 to M16.
- e. Set SG for optional frequency or enter a frequency into memory beforehand, make sure that the frequency will stop.
- f. When ·ST button is pushed, make sure the scanning will stop.

12. SCAN B

- a. Enter optional frequencies into memory bank from M1 to M16.
- b. Push ·ST → SW → M1 → M9 → M3 → M16 → SCAN B accordingly.
- c. Make sure that the scanning will be made from M1 to M9, M3 and M16 in order.
- d. Push ·ST button and make sure the scanning will stop.

13. LIM

a. Push the buttons according to the order of;

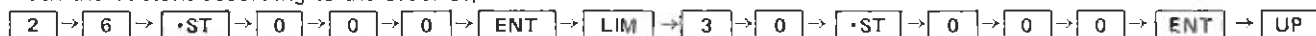

b. Make sure that the seeking will be made between 26.000 MHz and 30.000 MHz.

14. CK

a. Push **CK** button and then **MW H** button.

b. Make sure that HOUR figure will be increased, whenever pushing **MW H** button every one time.

c. Make sure that MINUTE figure will be increased whenever pushing **SW M** button every one time.

d. When **MW H** button or **SW H** button is kept pushing respectively, figure must be forwarded quickly.

e. When **MW H** button is pushed quickly, the display must be changed from AM to PM (or PM to AM).

15. SP

a. Set squelch volume all the way to the left side position.

b. Push UP or DOWN button for seeking.

c. Push **SP** button. Then make sure the seeking speed becomes fast.

d. Push **SP** button again and make sure that the speed returns to normal one.

VOLTAGES OF EACH IC & TRANSISTORS AND OTHERS

1. PLL P.C. BOARD

IC101	PIN, NO	1	2	3	4	5	6	7	8	9	10	11	12	13	14	15	16
MC3357	VOLTAGE	6.0	5.5	6.1	6.1	1.0	1.0	1.0	6.1	2.4	1.9	2.2	0.9	0	0	0	2.0

IC102	PIN, NO	1	2	3	4	5	6	7	8	9	10	11	12	13	14
LA1201	VOLTAGE	1.9	3.0	0.7	2.0	1.2	0.5	0	2.2	0.7	2.0	0	2.0	3.4	6.1

IC103	f (MHz)	PIN, NO	1	2	3	4	5	6	7	8	9	10	11	12	13	14
	26,000~88,000		VOLTAGE	0	0	0	0	0	0	0	0	0	0	0	0	0
SO429	108,000~514,000	VOLTAGE	0	4.8	4.7	0	5.0	0	2.8	2.8	0	0.7	1.4	0.9	1.4	0

IC104	f (MHz)	PIN, NO	1	2	3	4	5	6	7	8	
	26,000~44,995		VOLTAGE	5.0	0	0	0	0	2.9	2.8	5.0
	45,000~57,995			5.0	0	0	0	0	2.9	2.8	5.0
	58,000~88,000			5.0	0	0	0	0	2.9	2.9	5.0
	108,000~139,995			5.0	1.8	0	0	0	2.9	2.8	5.0
	140,000~180,000			5.0	1.8	0	0	0	2.9	2.8	5.0
380,000~514,000	5.0	1.8		0	0	0	2.9	2.8	5.0		

IC105	f (MHz)	PIN, NO	1	2	3	4	5	6	7	8	9	10	11	12	13	14	15	16	17	18	
	26,000~44,995		VOLTAGE	5.4	-	2.6	1.4	1.1	4.0	0	0	2.7	0.15	0	17.15	0	2.7	0	0	0	0
	45,000~57,995			5.4	-	2.6	1.4	1.1	4.0	0	0	2.7	0.15	0	17.15	0	2.7	0	0	0	0
	58,000~88,000			5.4	-	2.6	1.4	1.1	4.0	0	0	2.7	0.15	0	17.15	0	2.7	0	0	0	0
	108,000~139,995			5.4	-	2.6	1.4	1.1	4.0	5.5	2.4	2.7	0.15	1.9	2.0	0	2.6	0	0	0	0
	140,000~180,000			5.4	-	2.6	1.4	1.1	4.0	5.5	2.4	2.7	0.15	1.9	8.6	0	2.6	0	0	0	0
380,000~514,000	5.4	-		2.6	1.4	1.1	4.0	5.5	2.4	2.7	0.15	1.9	5.1	0	2.6	0	0	0	0		

IC106	f (MHz)	PIN, NO	1	2	3	4	5	6	7	8	
	26,000~44,995		VOLTAGE	5.0	3.0	0	0	2.2	0.2	5.0	5.0
	45,000~57,995			5.0	3.0	0	0	2.2	0.2	5.0	5.0
	58,000~88,000			5.0	3.0	0	0	2.2	0.2	5.0	0
	108,000~139,995			5.0	3.0	0	0	2.2	0.2	5.0	5.0
	140,000~180,000			5.0	3.0	0	0	2.2	0.2	5.0	5.0
380,000~514,000	5.0	3.0		0	0	2.2	0.2	5.0	5.0		

IC107 74LS162	f (MHz)	PIN, NO	1	2	DATA INPUTS				7	8	9	10	DATE OUTPUTS				15	16
					3	4	5	6					11	12	13	14		
					VOLTAGE													
	26,000		1.2	2.0	H	L	L	H	0.2	0	4.2	5.0					4.2	5.0
	44,995			1.9	L	L	L	L										
	45,000			1.9	H	L	L	H										
	57,995			1.9	L	L	L	L										
	58,000			2.1	H	L	H	L										
H 5V	88,000			2.0	H	L	H	L										
L 0V	108,000			2.4	H	L	L	H										
	139,995			2.0	L	L	L	L										
	140,000			2.2	H	L	L	H										
	180,000			1.9	H	L	L	H										
	380,000			2.4	H	H	L	L										
	514,000			1.9	H	H	L	L										

IC108 uPD4015	f (MHz)	PIN, NO	1	2	3	4	5	6	7	8	9	10	11	12	13	14	15	16																		
																			VOLTAGE																	
																				26,000		0	L	L	L	H	0	L	0	0	H	L	H	L	0	0
	44,995			L	L	L	L		L			L	L	H	L																					
	45,000			L	L	L	H		H			H	L	H	L																					
	57,995			L	L	L	L		L			L	L	H	L																					
	58,000			L	H	L	H		L			L	H	H	L																					
H 10V	88,000			L	H	L	H		L			L	H	H	L																					
L 0V	108,000			L	L	L	H		L			H	L	L	H																					
	139,995			L	L	L	L		L			L	L	L	H																					
	140,000			H	L	L	H		H			H	L	L	H																					
	180,000			H	L	L	H		H			H	L	L	H																					
	380,000			L	L	H	H		L			L	L	H	H																					
	514,000			L	L	H	H		L			L	L	H	H																					

IC109 uPD4011	f (MHz)	PIN, NO	1	2	3	4	5	6	7	8	9	10	11	12	13	14																
																	VOLTAGE															
																		26,000		L	L	H	H	L	L	0	H	H	L	H	H	L
	44,995		L	L	H	H	L	L		H	H	L	H	H	L																	
	45,000		H	H	L	H	L	L		H	H	L	H	H	L																	
	57,995		H	H	L	H	L	L		H	H	L	H	H	L																	
	58,000		L	L	H	L	H	H		L	H	H	H	H	L																	
H 10V	88,000		L	L	H	L	H	H		L	H	H	H	H	L																	
L 0V	108,000		L	L	H	H	L	L		H	H	L	H	L	H																	
	139,995		L	L	H	H	L	L		H	H	L	H	L	H																	
	140,000		H	H	L	H	L	L		H	H	L	H	L	H																	
	180,000		H	H	L	H	L	L		H	H	L	H	L	H																	
	380,000		L	L	H	H	L	L		H	L	H	L	L	H																	
	514,000		L	L	H	H	L	L		H	L	H	L	L	H																	

(f) MHz 26,000 ~ 514,000

IC110	PIN, NO	1	2	3	4	5	6	7	8	9	10	11	12	13	14
SN74LS107	VOLTAGE	0.22	4.2	0.18	4.2	0.18	4.1	0	0.18	2.5	5.0	4.0	2.6	5.0	5.0

(f) MHz 26,000 ~ 514,000

IC111	PIN, NO	1	2	3	4	5	6	7	8	9	10	11	12	13	14	H 5V
SN74LS00	VOLTAGE	H	H	L	H	L	H	0	H	L	L	L	H	H	5.0	L 0V

(f) MHz 26,000 ~ 514,000

IC112	PIN, NO	1	2	3	4	5	6	7	8	9	10	11	12	13	14	15	16	17	18	19	20	21	22
uPD5101LC	VOLTAGE	-	-	-	-	-	-	0	0	0.15	-	0.15	0	1.0	0	1.0	5.0	0	0	3.6	-	5.5	

(f) MHz 26,000 ~ 514,000

IC113	PIN, NO	1	2	3	4	5	6	7	8	9	10	11	12	13	14
uPA53C	VOLTAGE	0	0.27	0.2	1.0	1.0	0	7	0	0	5.8	5.5	6.5	6.5	0

IC114 uPD2819	f (MHz)	PIN, NO	1	2	3	4	5	6	7	8	9	10	11	12	13	14	15	16	17	18
	26,000	VOLTAGE	4.5	-	-	1.3	-	0.7	-	3.8	-	-	3.8	0.65	0	-	0	-	-	-
	44,995		-	-	-	-	-	-	-	1.6	-	-	1.6	12.1	-	-	-	-	-	-
	45,000		-	-	-	-	-	-	-	-	2.8	-	-	2.8	3.7	-	-	-	-	-
	57,995		-	-	-	-	-	-	-	-	1.4	-	-	1.4	11.3	-	-	-	-	-
	58,000		-	-	-	-	-	-	-	-	3.2	-	-	3.2	0.6	-	-	-	-	-
	88,000		-	-	-	-	-	-	-	-	1.4	-	-	1.4	12.0	-	-	-	-	-
	108,000		-	-	-	-	-	-	-	-	4.5	-	-	4.5	0.58	-	-	-	-	-
	139,995		-	-	-	-	-	-	-	-	2.3	-	-	2.3	9.65	-	-	-	-	-
	140,000		-	-	-	-	-	-	-	-	3.4	-	-	3.4	1.3	-	-	-	-	-
	180,000		-	-	-	-	-	-	-	-	1.9	-	-	1.9	13.0	-	-	-	-	-
	380,000		-	-	-	-	-	-	-	-	3.4	-	-	3.4	0.65	-	-	-	-	-
514,000	↓		↓	↓	↓	↓	↓	↓	↓	2.0	-	-	2.0	12.4	↓	↓	↓	↓	↓	

IC116	PIN, NO	1	2	3	4	5
uPC2002H	VOLTAGE	0.7	0.7	0	6.5	13.8

IC117	PIN, NO	1	2	3
78M08	VOLTAGE	13.8	0	8.0

IC118	PIN, NO	1	2	3
78M05	VOLTAGE	13.8	0	5.0

f (MHz)	TR, NO	Q101 2SC945			Q102 2SC945			Q103 2SC945			Q104 2SC945			Q105 2SC1674			Q106 2SC1674		
		E	C	B	E	C	B	E	C	B	E	C	B	E	C	B	E	C	B
26,000~44,995		0	7.0 (0.1)	0 (0.6)	0	0.8	0.6	0	2.0	0.63	0	0	0.08	0	0	0	0	0	0
45,000~57,995														0	0	0	0	0	0
58,000~88,000														0	0	0	0	0	0
108,000~139,995														0.13	4.2	0.9	0	3.0	0.77
140,000~180,000														0.13	4.2	0.9	0	3.0	0.77
380,000~514,000		↓	↓	↓	↓	↓	↓	↓	↓	↓	↓	↓	↓	0.13	4.2	0.9	0	3.0	0.77

f (MHz)	TR, NO	Q107 2SC1674			Q108 2SC1674		
		E	C	B	E	C	B
26,000~44,995		0	0	0	0	0	0
45,000~57,995		0	0	0	0	0	0
58,000~88,000		0	0	0	0	0	0
108,000~139,995		1.0	5.0	1.8	0	5.0	2.5
140,000~180,000		1.0	5.0	1.8	0	5.0	2.5
380,000~514,000		1.0	5.0	1.8	0	5.0	2.5

f (MHz)	TR, NO			Q109 2SC1674			Q110 2SC1674			Q111 2SC1674			Q112 2SA733			Q113 2SC945			Q114 2SC1674		
	E	C	B	E	C	B	E	C	B	E	C	B	E	C	B	E	C	B	E	C	B
26,000~44,995	0	3.0	0.6	0	4.3	0.47	0	2.0	1.7	4.9	4.9	4.3	17.0	21.7	17.0	0	4.8	0.09			
45,000~57,995	0	3.0	0.6	0	4.3	0.6	0	1.9	1.7	4.9	4.9	4.3	17.0	21.7	17.0	0	4.8	0.07			
58,000~88,000	0	3.0	0.6	0	4.3	0.6	0	2.1	1.6	0	4.9	7.6	17.0	21.7	17.0	0	4.6	0.17			
108,000~139,995	0	3.0	0.7	0	4.5	0.7	0	2.3	1.5	4.9	4.9	4.3	17.0	21.7	17.0	0	4.5	0.2			
140,000~180,000	0	3.0	0.7	0	4.3	0.76	0	2.1	1.6	4.9	4.9	4.3	17.0	21.7	17.0	0	4.7	0.1			
380,000~514,000	0	3.0	0.7	0	4.5	0.7	0	2.3	1.5	4.9	4.9	4.3	17.0	21.7	17.0	0	4.7	0.1			

f (MHz)	TR, NO			Q115 2SC945			Q116 2SC945			Q117 2SC945			Q118 2SA733		
	E	C	B	E	C	B	E	C	B	E	C	B	E	C	B
26,000~44,995	0	5.4	0	0.17	0.17	0.7 (0.4)	0.17	0.17	0.17	0	0	0 (1.5)	0	0	0 (1.9)
45,000~57,995	0	5.4	0												
58,000~88,000	0	5.4	0												
108,000~139,995	0	5.4	0												
140,000~180,000	0	5.4	0												
380,000~514,000	0	5.4	0	↓	↓	↓	↓	↓	↓	↓	↓	↓	↓	↓	↓

2. CONTROL P.C. BOARD

IC201	PIN, NO	1	2	3	4	5	6	7	8	9	10	11	12	13	14
uPC324C	VOLTAGE	{6.3} 0	0	0	7.6	{2.9} 2.6	2.3	8.0	8.0	2.6	3.0	0	3.8	3.8	3.8

TR, NO	E	C	B
Q201 2SC945	0	0	0 (0.6)
Q202 2SC945	0	0	0 (0.6)
Q203 2SC945	3.3	7.6	3.9
Q204 2SC945	0	0 (0.6)	0.6 (0)
Q205 2SC2001	0	0	0 (0.6)

3. TUNER P.C. BOARD

f (MHz)	Q1 2SC1070			Q2 2SC1730			Q3 2SC1730			Q4 3SK74				Q5 2SC1674			
	E	C	B	E	C	B	E	C	B	S	D	G ₁	G ₂	E	C	B	
26,000 ~ 88,000	0	0	0	0	8.0	0	0	0	0	0	0	0	0	0	8.0	0	
108,000 ~ 140,000	0	0	0	0	8.0	0	0	0	0	0.7	6.7	0	4.7	0.4	8.0	1.1	
380,000 ~ 514,000	0.8	6.0	1.6	0.3	8.0	0.96	0	3.0	0.6	0	0	0	0	0	8.0	0	

f (MHz)	Q6 3SK74				Q7 2SC1674		
	S	D	G ₁	G ₂	E	C	B
26,000 ~ 88,000	0.9	7.1	0	4.9	0.45	8.0	1.1
108,000 ~ 140,000	0	0	0	0	0	8.0	0
380,000 ~ 514,000	0	0	0	0	0	3.0	0

4. VCO. P.C. BOARD

TR, NO	Q201 2SC1674			Q202 2SC1674			Q203 2SC1674			Q204 2SC1674			Q205 2SC1674		
	E	C	B	E	C	B	E	C	B	E	C	B	E	C	B
f (MHz)															
26,000~44,995	0	0	0	0	0	0	0	0	0	0	0	0	0	0	0
45,000~57,995	0	0	0	0	0	0	0	0	0	0	0	0	0	0	0
58,000~88,000	0	0	0	0	0	0	0	0	0	0	0	0	0	0	0
108,000~139,995	0.5	3.6	1.0	0	3.4	0.7	0	0	0	0	0	0	2.8	4.8	3.2
140,000~180,000	0.5	3.6	1.0	0	3.4	0.7	0	0	0	3.0	6.2	2.4	0	0	0
380,000~514,000	0.5	3.6	1.0	0	3.4	0.7	3.0	7.0	3.4	0	0	0	0	0	0

TR, NO	Q207 2SC1674			Q208 2SC1674			Q209 2SC1674			Q210 2SC945			Q211 2SC945			Q212 2SA733		
	E	C	B	E	C	B	E	C	B	E	C	B	E	C	B	E	C	B
f (MHz)																		
26,000~44,995	3.4	7.6	4.0	2.8	6.4	3.0	0	3.2	0.8	0.6	4.2	1.2	0	0	0	7.0	7.0	6.4
45,000~57,995	3.4	7.6	4.0	2.8	6.4	3.0	0	3.2	0.8	0.6	4.2	1.2	0	0	0	7.0	0	7.0
58,000~88,000	3.4	7.6	4.0	2.8	6.4	3.0	0	3.2	0.8	0.6	4.2	1.2	0	0	0	7.0	0	7.0
108,000~139,995	0	0	0	0	0	0	0	0	0	0	0	0	5.8	7.0	5.8	7.0	6.8	6.2
140,000~180,000	0	0	0	0	0	0	0	0	0	0	0	0	0	7.0	0	7.0	0	6.8
380,000~514,000	0	0	0	0	0	0	0	0	0	0	0	0	0	0	0	7.0	6.6	6.2

TR, NO	Q213 2SA733			Q214 2SA733			Q215 2SC945			Q216 2SA733			Q217 2SC945			Q218 2SA733		
	E	C	B	E	C	B	E	C	B	E	C	B	E	C	B	E	C	B
f (MHz)																		
26,000~44,995	7.4	0	8.6	7.6	0.4	8.5	7.6	0	8.6	7.4	0	8.6	0	0	0	7.4	7.4	7.0
45,000~57,995	7.4	0	8.6	7.6	0.4	8.5	7.6	0	8.6	7.4	7.4	7.0	0	0	0	7.4	7.4	7.0
58,000~88,000	7.4	0	8.6	7.6	0.2	8.5	7.6	7.4	7.0	7.4	0	8.6	0	0	0	7.4	7.4	7.0
108,000~139,995	7.4	0	8.6	7.6	7.0	6.8	7.6	0	8.4	7.4	0	8.6	0	7.1	0	7.4	0	8.4
140,000~180,000	7.4	0	8.6	7.6	7.0	6.8	7.6	0	8.4	7.4	7.2	6.8	6.2	7.1	6.2	7.4	0	8.4
380,000~514,000	7.4	7.0	6.6	7.6	0.3	8.5	7.6	0	8.4	7.4	0	8.4	0	0	0	7.4	0	8.4

5. DC/DC CONVERTER P.C. BOARD

TR, NO	E	C	B
Q501 2SD773	10	12.8	11
Q502 2SD773	0	13.8	0.014
Q503 2SC945	0	0.015	0.6
Q504 2SD733	0	12.2	-1.7

SCHEMATIC DIAGRAM (PLL, TUNER, VCO, CONTROL) Fig. 5

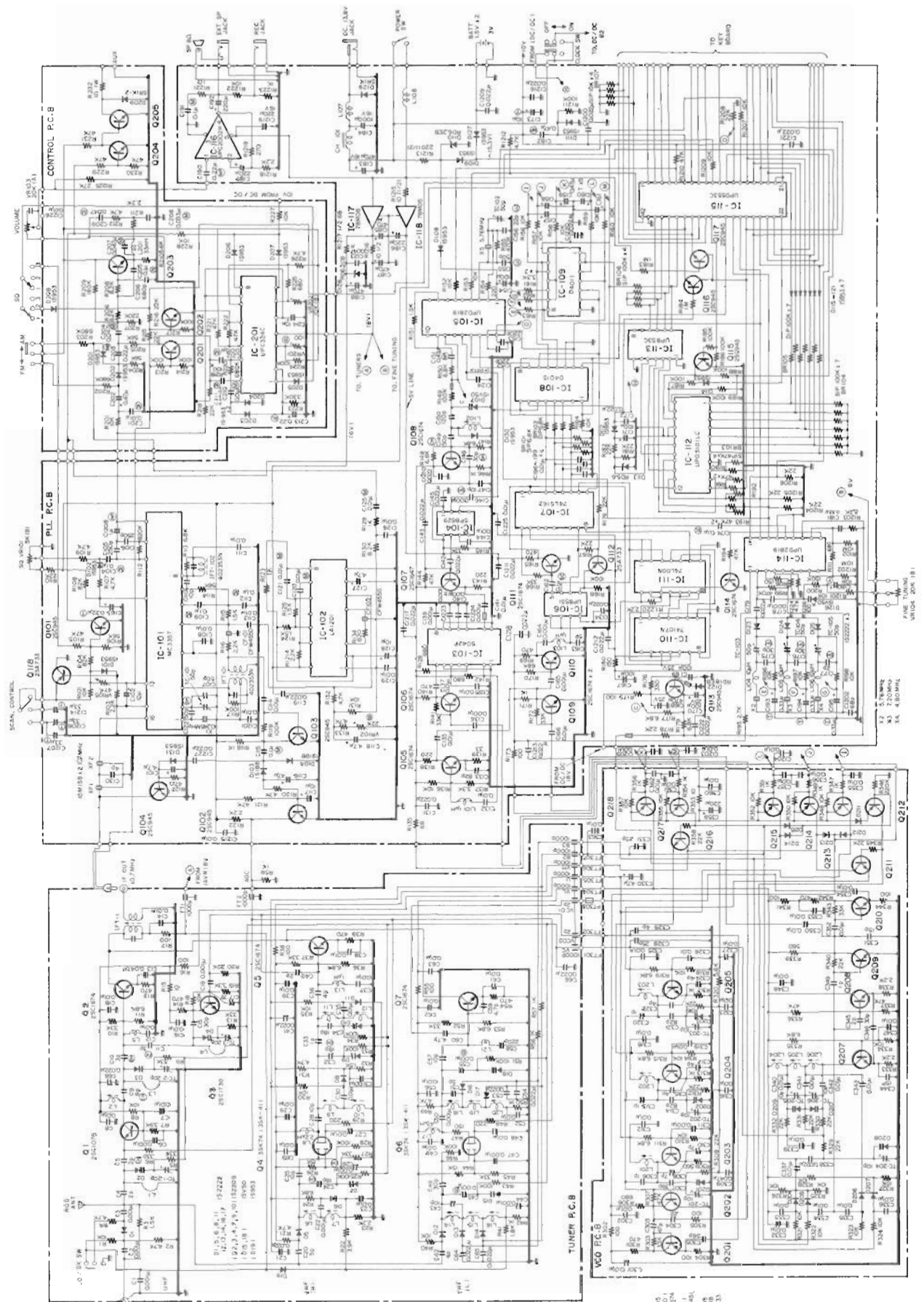

SCHEMATIC DIAGRAM (KEYBOARD & DC-DC CONVERTER) Fig. 6

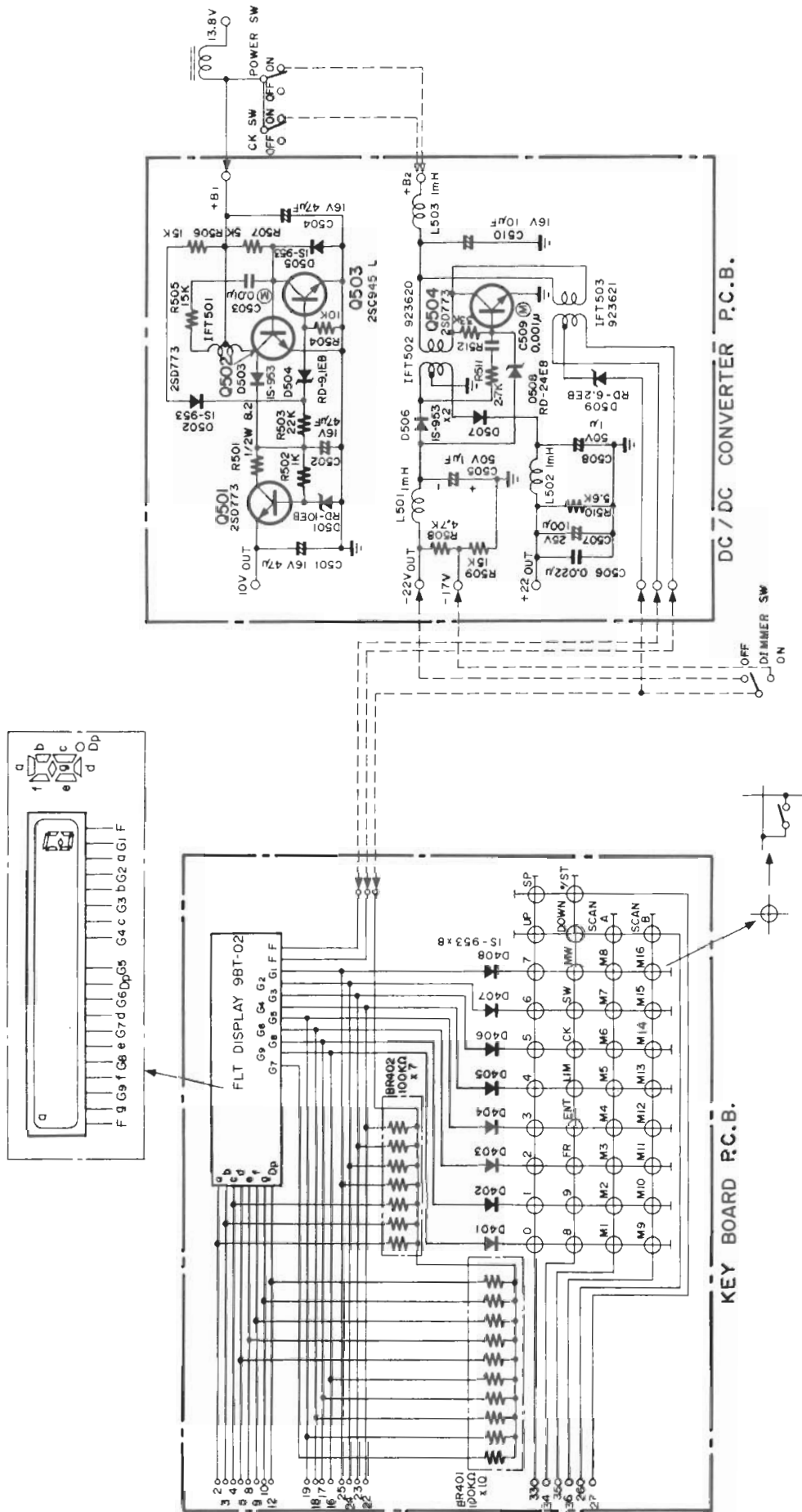

WIRING DIAGRAM Fig. 7

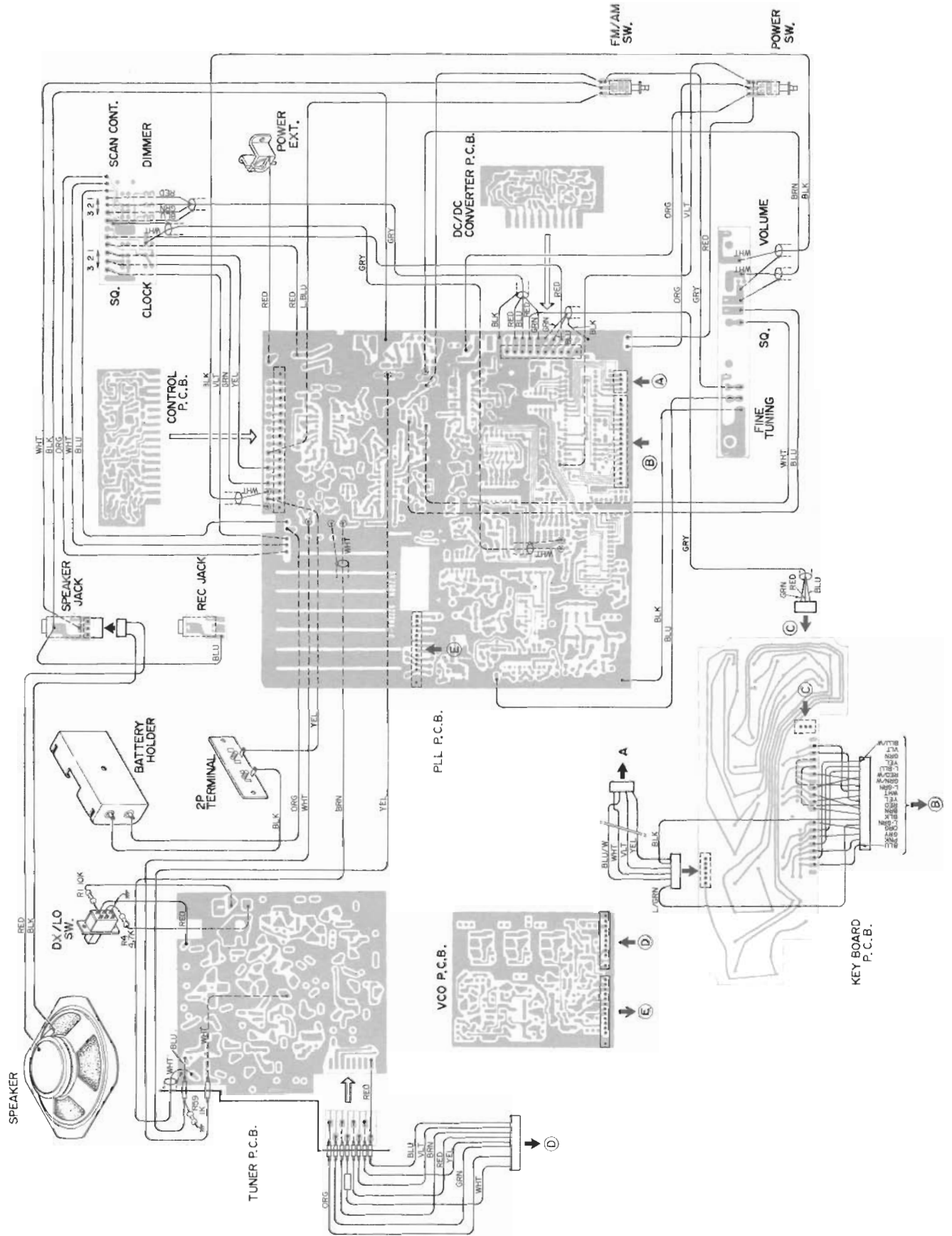

WIRING, PLL P.C. BOARD Fig. 8

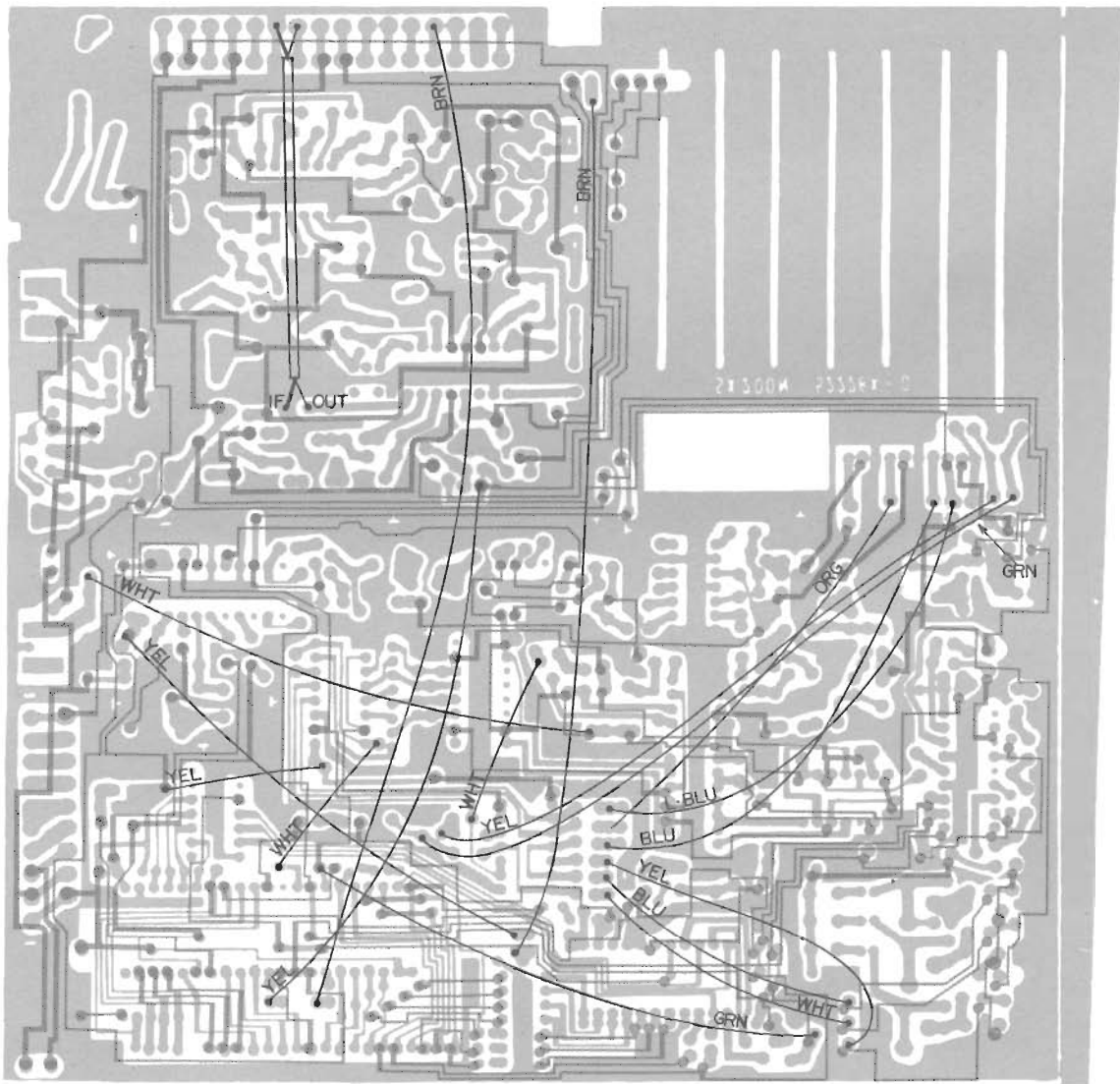

PART LOCATION

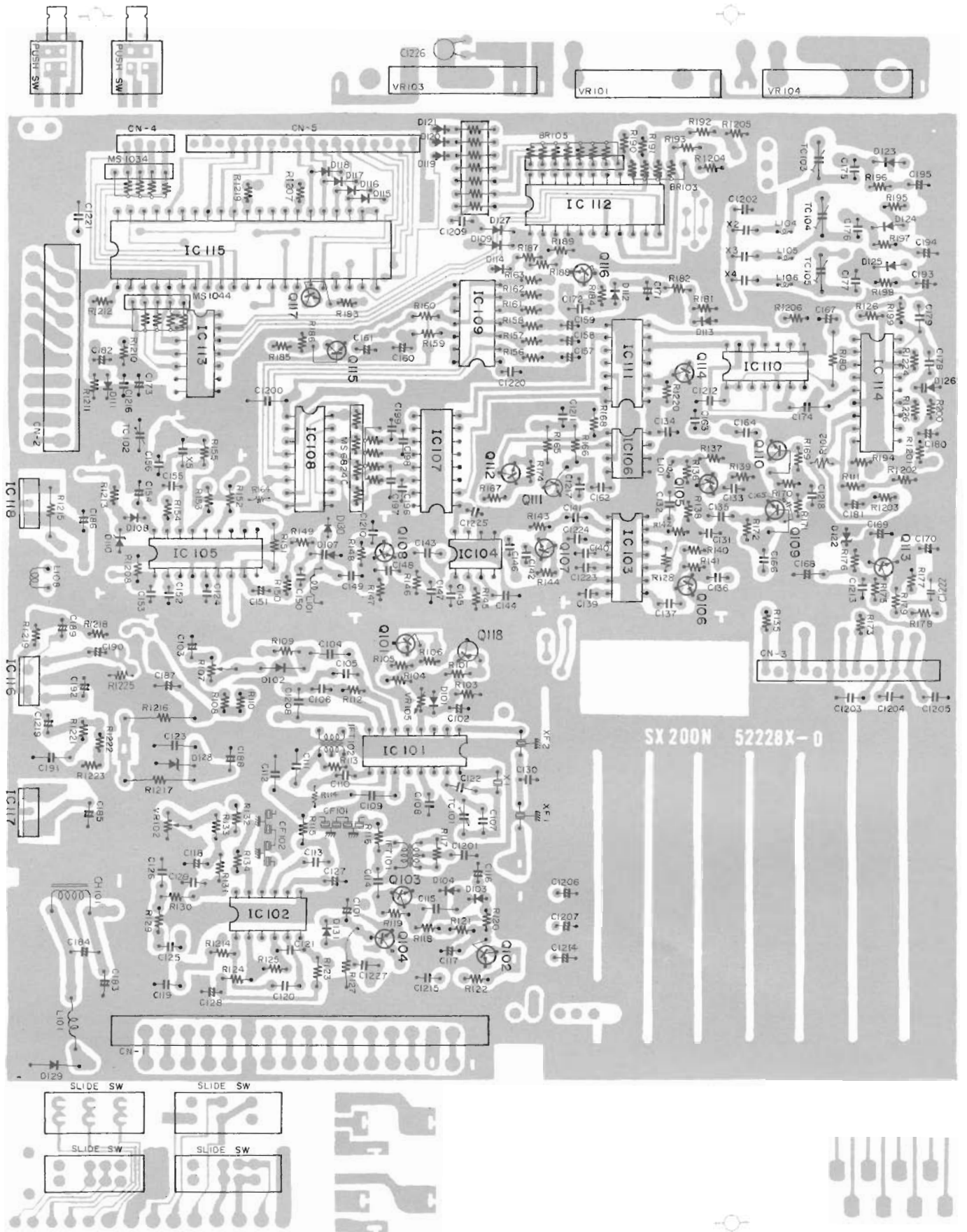

Fig. 9
PLL P.C. BOARD, WIRING SIDE

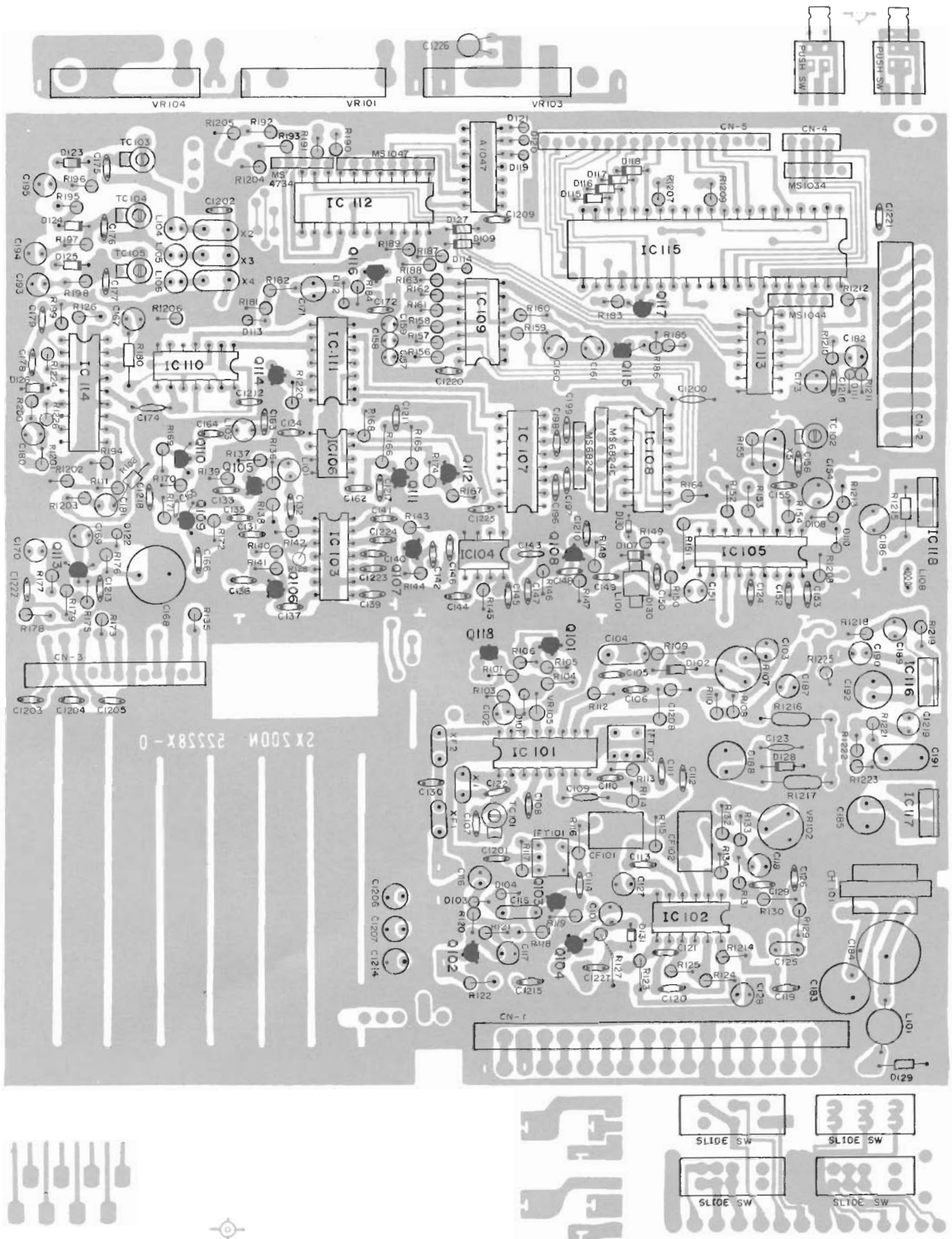

Fig. 10
PLL P.C. BOARD, COMPONENT SIDE

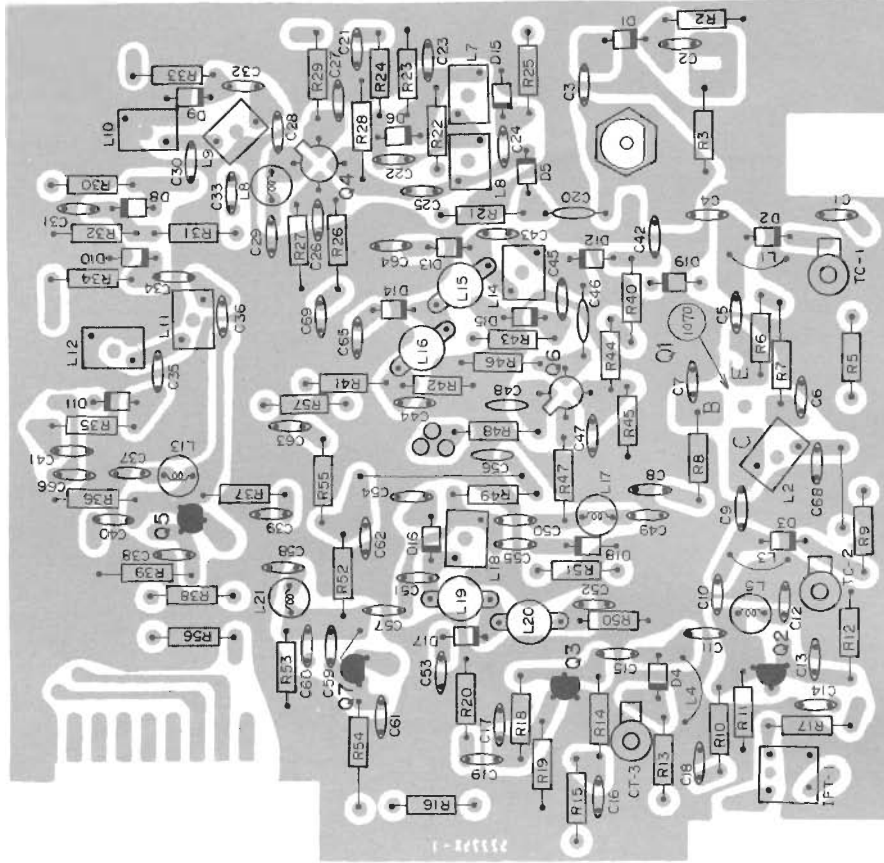
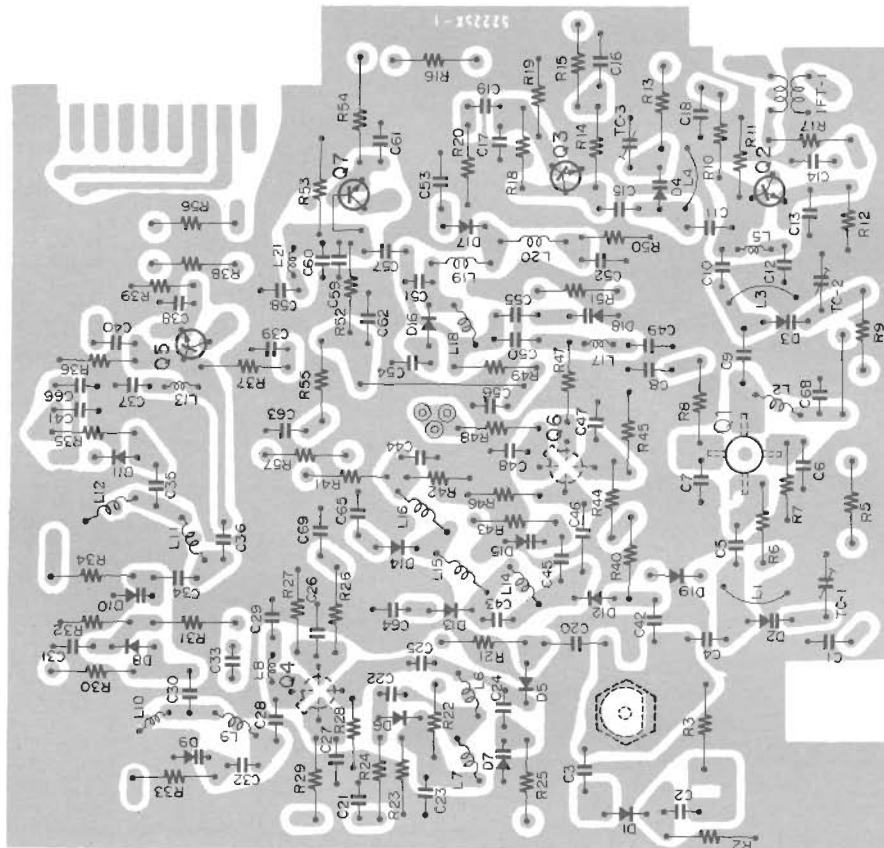

Fig. 11
TUNER P.C. BOARD, COMPONENT/WIRING SIDES

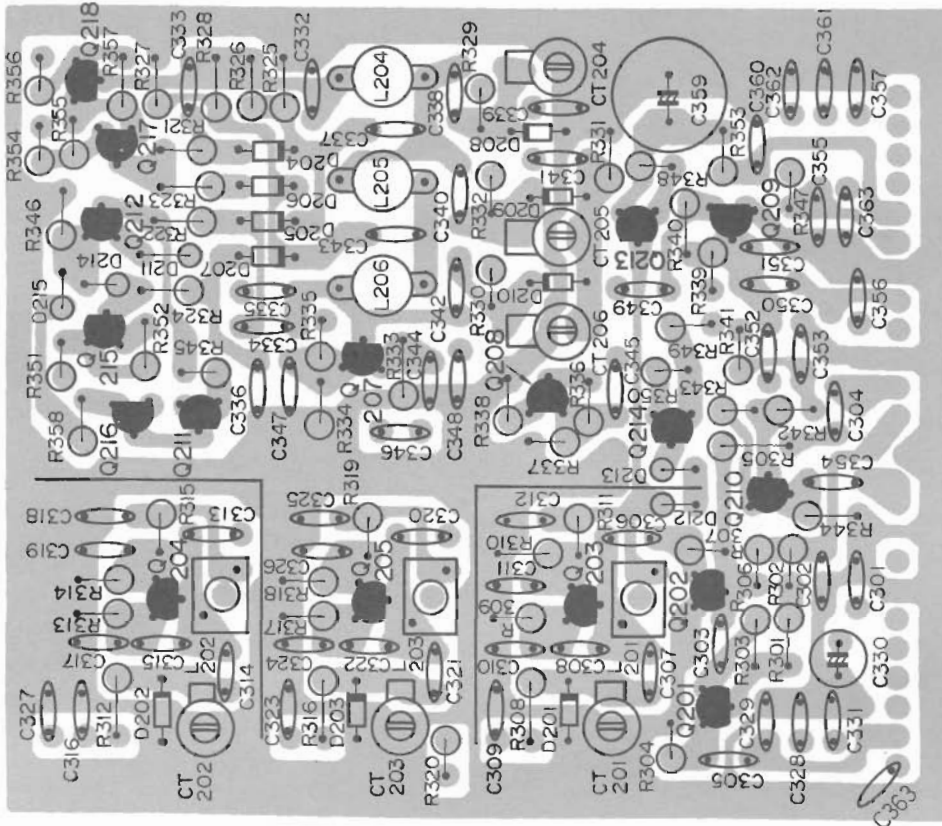
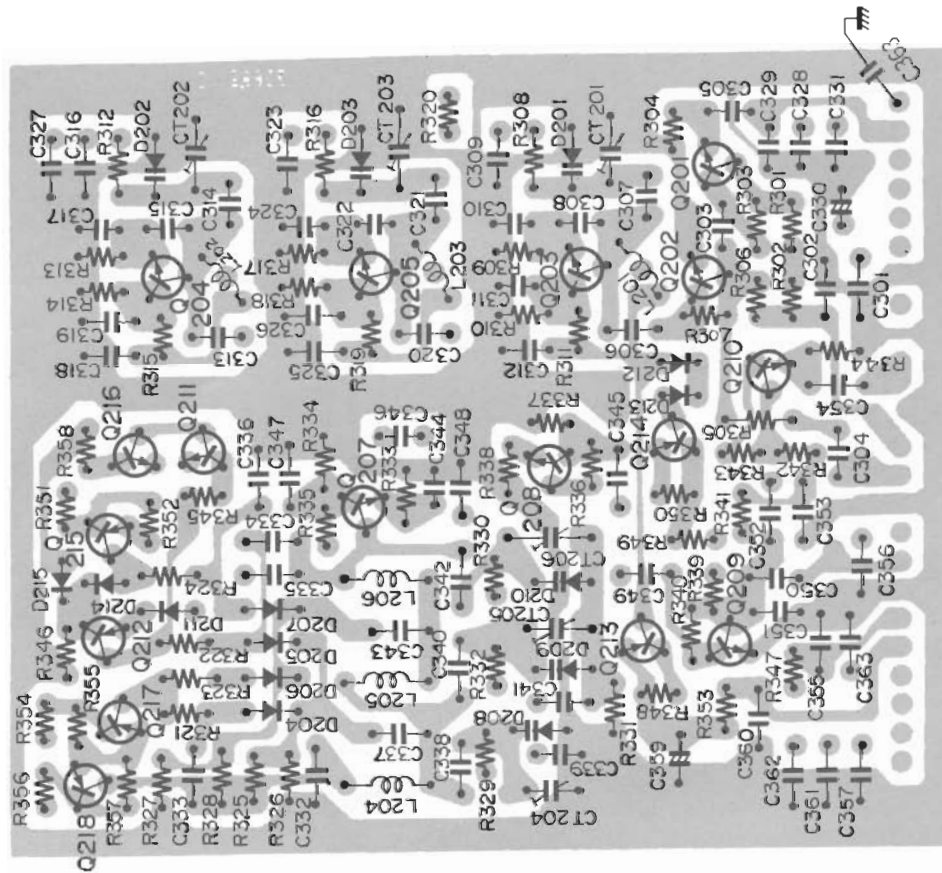

Fig. 12 VCO P.C. BOARD, COMPONENT/WIRING SIDES

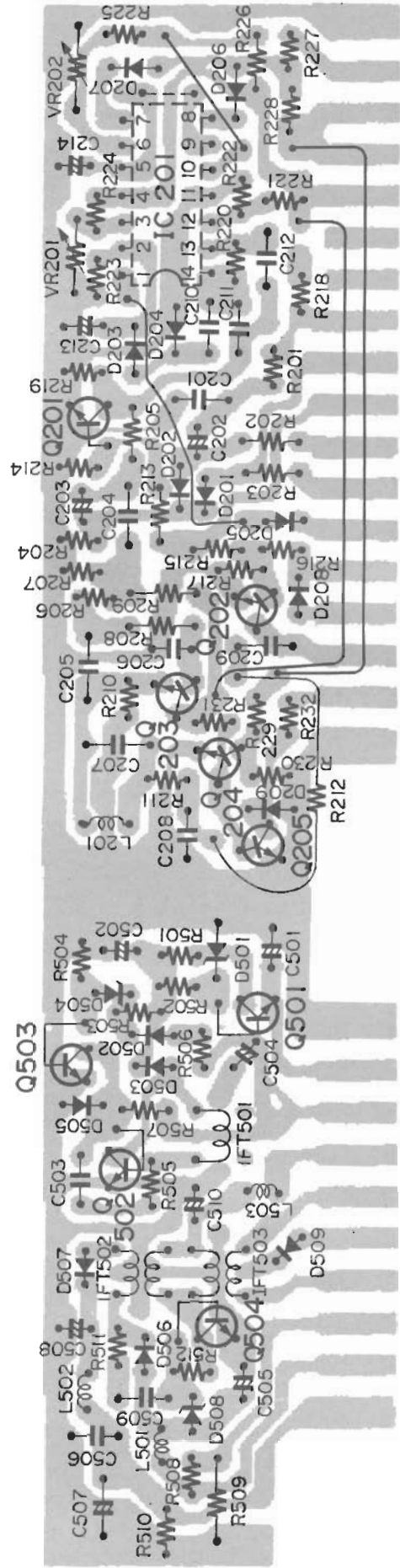
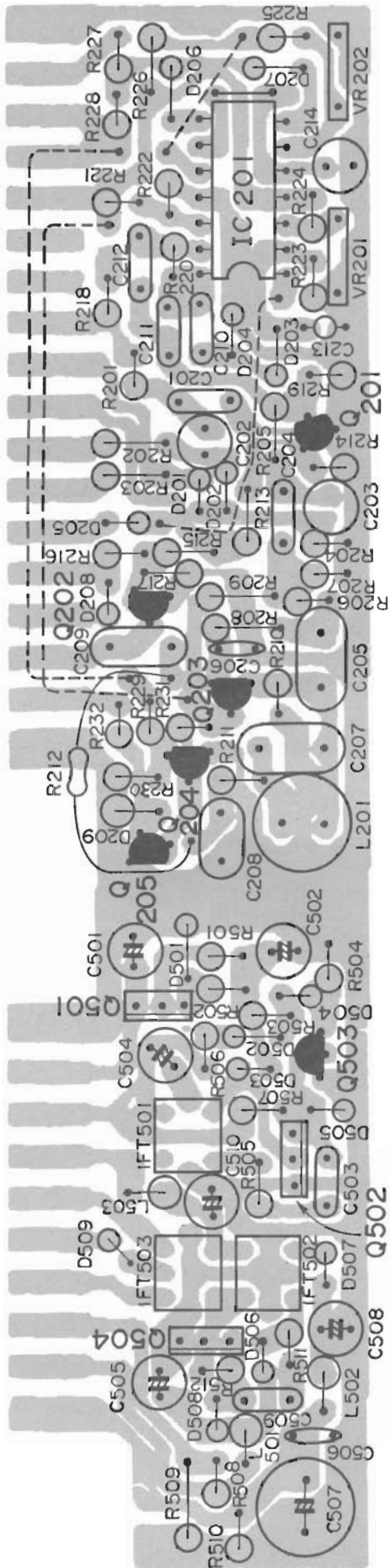

Fig. 13
 CONTROL P.C. BOARD, COMPONENT/WIRING SIDES
 DC-DC CONVERTER P.C. BOARD, COMPONENT/WIRING SIDES

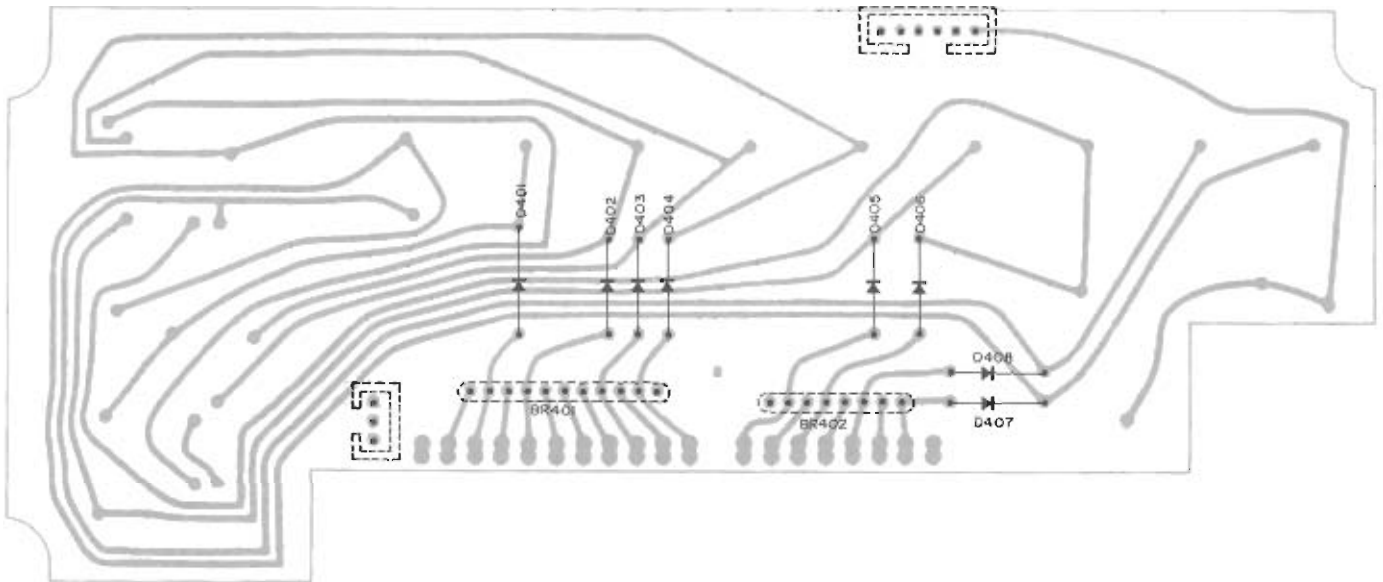
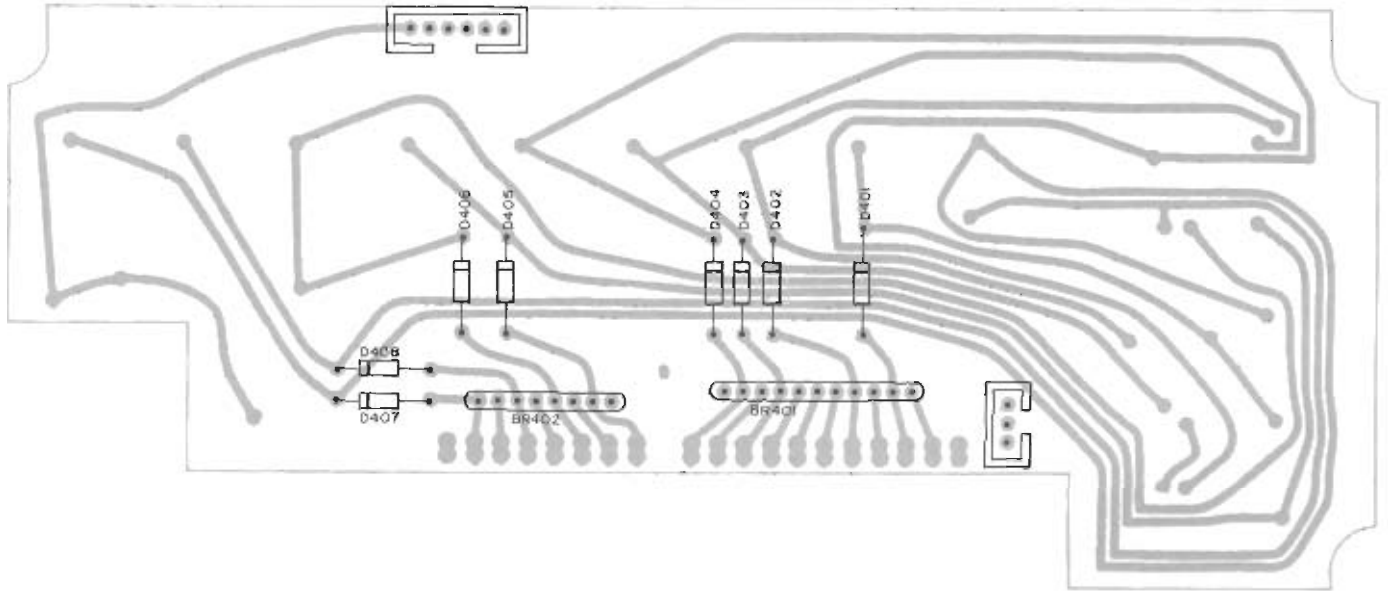

Fig. 14
KEYBOARD P.C. BOARD, COMPONENT/WIRING SIDES

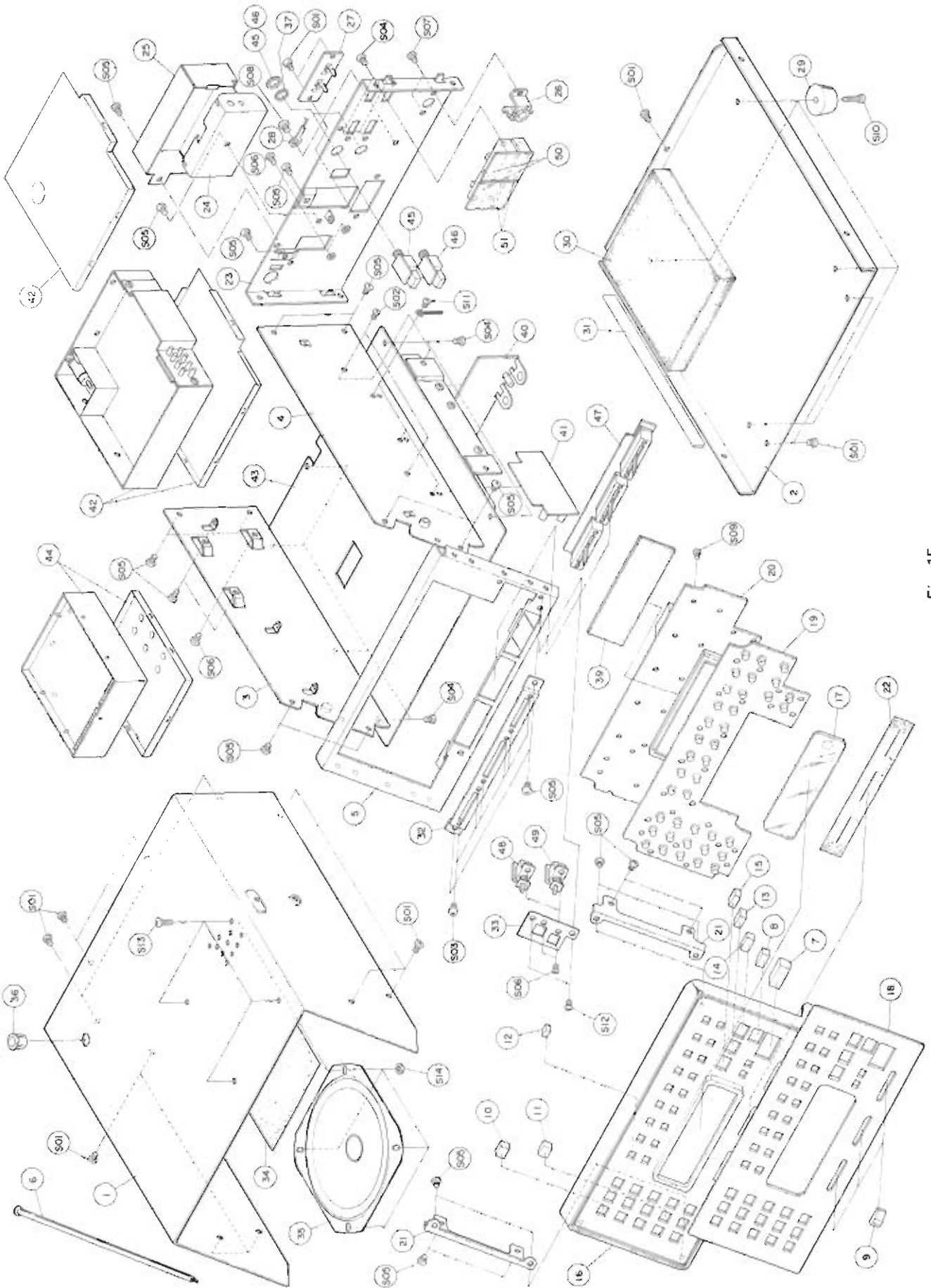

Fig. 15
ASSEMBLY LAYOUT (Final Assembling)

COMPONENT LIST (FINAL ASSEMBLING)

Ref. No.	Part No.	Description	Q'ty	Ref. No.	Part No.	Description	Q'ty
1	46588	Case, Top	1	34	46594	Dust Cover, Speaker	1
2	45897	Case, Bottom	1	35	924003	Speaker	1
3	46587	Side Plate, Left	1	36	923681	Bushing, Antenna	1
4	46586	Side Plate, Right	1	37	46595	Jack Spacer	2
5	46303	Case, Front	1	38		No component	
6	924029	Antenna	1	39	42239	Foam Rubber	1
7	45901	Knob, Push (POWER)	1	40	31589-1	Control P.C. Board Ass'y	1
8	46301	Knob, FM-AM	1	41	31589-2	DC/DC Converter P.C. Board Ass'y	1
9	45783	Knob, Slide (FINE TUNING/ SQUELCH/VOLUME)	3	42	31590	Tuner P.C. Board Ass'y	1
10	45920	Knob, Channel A, FIGURES 0 thru. 9	10	43	31591	PLL P.C. Board Ass'y	1
11	46534	Knob, Channel B, ST/FR/LIM/ENT/SP	5	44	31592	VCO P.C. Board Ass'y	1
12	45782	Knob, Memory/SW-W/MW-H/ UP-DOWN Seek	20	45	924004	External Speaker Jack	1
13	46601	Knob, SCAN A	1	46	924004	REC Jack	1
14	46602	Knob, SCAN B	1	47		Volume Board Ass'y	1
15	46300	Knob, CK	1			Consists of 915581 (Volume)	
16	45741	Escutcheon	1			915580 (Fine Tuning)	
17	45910	Window	1			915594 (Squelch)	
18	46302	Plate, Escutcheon	1	48	912122	Push Switch, FM-AM	1
19	45780	Rubber Contact	1	49	912122	Push Switch, POWER	1
20	32667	Print Board, Keyboard	1	50	912123	Slide Switch, SCAN CONT./SQ.	1
	923553	Digitron 9BT-02A	1	51	912124	Slide Switch, DIMMER/CLOCK	1
21	45903	Bracket, Escutcheon	2	S01	023154	Screw M3 x 4, BH	15
22	45911	VR Shield Plate	1	S02	023143	Screw 3 x 8, RH Tapping	2
23	46585	Rear Plate	1	S03	022027	Screw M2 x 4, BH	6
24	923907	Battery Holder	1	S04	022655	Screw M2.6 x 4, Truss	10
25	46589	Battery Cover	1	S05	023055	Screw M3 x 4, BH	22
26	923629	External Power Supply Jack	1	S06	022655	Screw M2.6 x 4, Truss	5
27	923908	2P Screw Terminal	1	S07	022046	Screw M2 x 4, RH	2
28	922439	Ground Lead Wire	1	S08	024021	Screw M4 x 4, BH	1
29	922163	Rubber Foot	4	S09	021702	Screw 1.7 x 4.6, BH	24
30	46600	Cushion Rubber	1	S10	023108	Screw M3 x 8, BH	4
31		Tape	2	S11	022602	Screw M2.6 x 4, RH	3
32	45902	Bracket, VR	1	S12	022678	Screw M2.6 x 3, Truss	2
33	46304	Bracket, Switch	1	S13	023145	Screw M3 x 6, BH	4
				S14	013003	Nut M3, Chrome	4

ELECTRICAL COMPONENT LIST

1. CONTROL P.C. BOARD

Ref. No.	Part No.	Description	Q'ty	Ref. No.	Part No.	Description	Q'ty
SEMI-CONDUCTORS & COIL							
IC201	916228	IC uPC324C	1	R212	915327	4.7K ohm	1
Q201, 202, 203	916158	Silicon Transistor 2SC945L	3	R213, 214	915039	100K "	2
Q204, 205	916162	Silicon Transistor 2SC2001	2	R215, 216	915342	22K "	2
D201 thru. 208	923147	Diode 1S953	8	R217	915039	100K "	1
D209	923817	Diode SR1K-2	1	R218	915342	22K "	1
L201	913622	Micro inductor 33mH	1	R219	915039	100K "	1
RESISTORS, all are 1/8 watt 10% tolerance unless otherwise specified.				R220	915483	680K "	1
R201	915015	10K ohm	1	R221, 222	915343	47K "	2
R202, 203	915483	680K "	2	R223	915443	330K "	1
R204, 205	915372	56K "	2	R224	915039	100K "	1
R206	915055	8.2K "	1	R225	915337	680 "	1
R207	915344	220K "	1	R226	915327	4.7K "	1
R208	915055	8.2K "	1	R227, 228	915015	10K "	2
R209	915450	180K "	1	R229, 230, 231	915343	47K "	3
R210	915409	5.6K "	1	R232	915106	1 " (J) 1/2 watt	1
R211	915007	2.2K "	1	CAPACITORS, all are in 50 working voltage unless otherwise specified.			
				C201	913020	Mylar 0.01uF	1
				C202	913110	Electrolytic 0.47uF	1
				C203	913583	Electrolytic 0.22uF (NP)	1

ELECTRICAL COMPONENT LIST (Cont'd)

1. CONTROL P.C. BOARD

Ref. No.	Part No.	Description	Q'ty
C204	913044	Mylar 0.047uF	1
C205	913021	Mylar 0.1uF	1
C206	913162	Ceramic 680pF	1
C207	913044	Mylar 0.047uF	1
C208	913550	Mylar 0.033uF	1
C209	913044	Mylar 0.047uF	1
C210	913020	Mylar 0.01uF	1
C211	913210	Mylar 0.0015uF	1

Ref. No.	Part No.	Description	Q'ty
C212	913220	Mylar 0.015uF	1
C213	913509	Aluminum 0.22uF	1
C214	913175	Electrolytic 10uF	1
VR201	915464	Semi-Fixed Volume 100 ohm (B)	1
VR202	915585	Semi-Fixed Volume 10K ohm (B)	1

2. DC-DC CONVERTER P.C. BOARD & KEYBOARD

Ref. No.	Part No.	Description	Q'ty
SEMI-CONDUCTORS & COILS			
Q501, 502	916234	Silicon Transistor 2SD773	2
Q503	916158	Silicon Transistor 2SC945	1
Q504	916234	Silicon Transistor 2SD773	1
D501	923687	Diode RD10EB	1
D502, 503	923147	Diode IS953	2
D504	923586	Diode RD9.1B	1
D505, 506, 507	923147	Diode IS953	3
D508	923587	Diode RD24EB	1
D509	923588	Diode RD6.2EB	1
D401 thru. 408	923147	Diode IS953 (Kyeboard)	8
L501, 502, 503	913623	Micro Inductor 1mH	3
IFT501	923952	Coil 7BR-4824N	1
IFT502	923620	Coil L-5K7H5	1
IFT503	923621	Coil L-5K7H5	1
RESISTORS, all are 1/8 watt 10% tolerance unless otherwise specified.			
R501	915322	8.2 ohm 1/2 watt	1
R502	915003	1K "	1
R503	915342	22K "	1
R504	915015	10K "	1

Ref. No.	Part No.	Description	Q'ty
R505	915335	390 ohm	1
R506, 507	915341	15K "	2
R508	915327	4.7K "	1
R509	915341	15K "	1
R510	915170	5.6K " 1/4 watt	1
R511	915053	2.7K "	1
R512	915052	33K "	1
CAPACITORS, all are in 50 working voltage unless otherwise specified.			
C501, 502	913180	Electrolytic 47uF 16V	2
C503	913020	Mylar 0.01uF	1
C504	913180	Electrolytic 47uF 16V	1
C505	913349	Electrolytic 1uF (NP)	1
C506	913125	Ceramic 0.022uF	1
C507	913174	Electrolytic 100uF 25V	1
C508	913349	Electrolytic 1uF (NP)	1
C509	913071	Mylar 0.001uF	1
C510	913175	Electrolytic 10uF 16V	1
BR401 (Keyboard)	915519	Block Resistor 100K ohm x 10 MS10410	1
BR402 (")	915518	Block Resistor 100K ohm x 7 MS1047	1

3. TUNER P.C. BOARD

Ref. No.	Part No.	Description	Q'ty
SEMI-CONDUCTORS & COILS			
Q1	916176	Silicon Transistor 2SC1070	1
Q2	916116	Silicon Transistor 2SC1674 or 2SC2786	1
Q3	916173	Silicon Transistor 2SC1730	1
Q4	916233	Silicon Transistor 3SK74 or 3SK41	1
Q5	916116	Silicon Transistor 2SC1674	1
Q6	916233	Silicon Transistor 3SK74 or 3SK41	1
Q7	916116	Silicon Transistor 2SC1674	1
D1	923395	Diode IS-2222	1
D2, 3, 4	923416	Diode IS-2209	3
D5, 6	923395	Diode IS-2222	2
D7	923416	Diode IS-2209	1
D8	923395	Diode IS-2222	1
D9, 10	923416	Diode IS-2209	2
D11 thru. 14	923395	Diode IS-2222	4
D15	923211	Diode ISV-50	1

Ref. No.	Part No.	Description	Q'ty
D16, 17	923395	Diode IS-2222	2
D18	923211	Diode ISV-50	1
D19	923147	Diode IS953	1
IFT1	922501	IFT 10741	1
L1	924020	Coil, UHF 1/2t	1
L2	923923	Coil, VHF MC108 5-1/2t	1
L3	924021	Coil, UHF 1/2t	1
L4	924022	Coil, UHF 1/2t	1
L5	913624	Micro Inductor 1uH	1
L6, 7	923922	Coil, VHF MC108 3-1/2t	2
L8	913216	Micro Inductor 2.2uH	1
L9	923922	Coil, VHF MC108 3-1/2t	1
L10	923923	Coil, VHF MC108 5-1/2t	1
L11	923922	Coil, VHF MC108 3-1/2t	1
L12	923923	Coil, VHF MC108 5-1/2t	1
L13	913624	Micro Inductor 1uH	1
L14	923923	Coil, VHF MC108 5-1/2t	1
L15	923926	Coil, VHF MC116 5-1/2t	1
L16	923929	Coil, VHF MC116 9-1/2t	1

ELECTRICAL COMPONENT LIST (Cont'd)

3. TUNER P.C. BOARD

Ref. No.	Part No.	Description	Q'ty
L17	913572	Micro Inductor 4.7uH	1
L18	923923	Coil, VHF MC108 5-1/2t	1
L19	923926	Coil, VHF MC116 5-1/2t	1
L20	923929	Coil, VHF MC116 9-1/2t	1
L21	913624	Micro Inductor 1uH	1
TC-1, 2, 3	913530	Trimmer Condenser 20pF 5p	3
RESISTORS, all are 1/8 watt 10% tolerance unless otherwise specified.			
R1	915015	10K ohm	1
R2	915327	4.7K "	1
R3	915001	1.5K "	1
R4	915327	4.7K "	1
R5	915052	33K "	1
R6	915351	330 "	1
R7	915325	3.9K "	1
R8	915015	10K "	1
R9, 10	915052	33K "	2
R11	915340	6.8K "	1
R12	915057(J)	470 "	1
R13	915052	33K "	1
R14	915057(J)	470 "	1
R15	915060	10 "	1
R16, 17	915009	100 "	2
R18	915015	10K "	1
R19	915004	3.3K "	1
R20	915342	22K "	1
R21	915327	4.7K "	1
R22	915325	3.9K "	1
R23	915007	2.2K "	1
R24	915340	6.8K "	1
R25	915039	100K "	1
R26	915341	15K "	1
R27	915052	33K "	1
R28	915039	100K "	1
R29	915336	220 "	1
R30	915015	10K "	1
R31	915327	4.7K "	1
R32	915001	1.5K "	1
R33, 34	915039	100K "	2
R35	915015	10K "	1
R36	915340	6.8K "	1
R37	915052	33K "	1
R38	915009	100 "	1
R39	915057(J)	470 "	1
R40	915015	10K "	1
R41	915339	1.8K "	1
R42	915003	1K "	1
R43	915039	100K "	1
R44	915341	15K "	1
R45	915052	33K "	1
R46	915039	100K "	1
R47	915354	150 "	1
R48	915336	220 "	1
R49	915327	4.7K "	1
R50	915003	1K "	1
R51	915039	100K "	1
R52	915052	33K "	1
R53	915340	6.8K "	1
R54	915057(J)	470 "	1
R55	915009	100 "	1
R56, 57	915003	1K "	2
R58		No component	

Ref. No.	Part No.	Description	Q'ty
R59	915003	1K ohm	1
CAPACITORS, all are in 50 working voltage unless otherwise specified.			
C1	913051	Ceramic 0.001uF	1
C2	913051	Ceramic 0.001uF	1
C3	913051	Ceramic 0.001uF	1
C4	913076	Ceramic 2pF	1
C5	913132	Ceramic 2pF (CH)	1
C6	913051	Ceramic 0.001uF	1
C7, 8	913060	Ceramic 0.01uF	2
C9	913330	Ceramic 6pF (CH)	1
C10	913294	Ceramic 3pF (CH)	1
C11	913629	Fixed 3pF	1
C12	913060	Ceramic 0.01uF	1
C13	913063	Ceramic 0.047uF	1
C14	913060	Ceramic 0.01uF	1
C15	913171	Ceramic 30pF	1
C16	913060	Ceramic 0.01uF	1
C17	913122	Ceramic 7pF	1
C18	913060	Ceramic 0.01uF	1
C19	913051	Ceramic 0.001uF	1
C20	913053	Ceramic 5pF	1
C21	913125	Ceramic 0.022uF	1
C22	913051	Ceramic 0.001uF	1
C23	913060	Ceramic 0.01uF	1
C24	913427	Ceramic 18pF (CH)	1
C25	913052	Ceramic 10pF	1
C26	913051	Ceramic 0.001uF	1
C27	913060	Ceramic 0.01uF	1
C28	913052	Ceramic 10pF	1
C29, 30, 31	913060	Ceramic 0.01uF	3
C32	913427	Ceramic 18pF (CH)	1
C33	913081	Ceramic 1pF	1
C34	913427	Ceramic 18pF (CH)	1
C35	913060	Ceramic 0.01uF	1
C36	913076	Ceramic 4pF	1
C37, 38, 39	923060	Ceramic 0.01uF	3
C40	913076	Ceramic 2pF	1
C41	913125	Ceramic 0.022uF	1
C42	923078	Ceramic 4pF	1
C43	913052	Ceramic 10pF	1
C44	913051	Ceramic 0.001uF	1
C45	913625	Ceramic 0.001uF (B)	1
C46	913171	Ceramic 30pF	1
C47	913053	Ceramic 0.001uF	1
C48, 49	913060	Ceramic 0.01uF	2
C50	913051	Ceramic 0.001uF	1
C51	913053	Ceramic 5pF	1
C52	913060	Ceramic 0.01uF	1
C53, 54	913125	Ceramic 0.022uF	2
C55	913625	Ceramic 0.001uF (B)	1
C56	913060	Ceramic 0.01uF	1
C57	913052	Ceramic 10pF	1
C58	913077	Ceramic 220pF	1
C59	913075	Ceramic 4.7pF	1
C60	913075	Ceramic 4.7pF	1
C61, 62, 63	913060	Ceramic 0.01uF	3
C64, 65, 66	913125	Ceramic 0.022uF	3
C67		No component	
C68	913125	Ceramic 0.022uF	1
C69	913060	Ceramic 0.01uF	1

ELECTRICAL COMPONENT LIST (Cont'd)

4. PLL P.C. BOARD

Ref. No.	Part No.	Description	Q'ty
SEMI-CONDUCTORS & COIL			
IC101	916218	IC MC3357P	1
IC102	916221	IC LA1201	1
IC103	916223	IC SO42P	1
IC104	916219	IC SP8629	1
IC105	916225	IC uPD2819C	1
IC106	916185	IC uPB551C	1
IC107	916182	IC SN74LS162N	1
IC108	916229	IC uPD4015C	1
IC109	916228	IC uPD4011C	1
IC110	916238	IC SN74LS107AN	1
IC111	916184	IC SN74LS00N	1
IC112	916227	IC uPD5101LC	1
IC113	916198	IC uPA53C	1
IC114	916225	IC uPD2819C	1
IC115	916224	IC uPD553C	1
IC116	916239	IC uPC2002	1
IC117	916241	IC 78M08 AVR	1
IC118	916240	IC 78M05 AVR	1
Q101 thru. 104	916158	Silicon Transistor 2SC945L	4
Q105 thru. 111	916116	Silicon Transistor 2SC1674	7
Q112	916194	Silicon Transistor 2SA733	1
Q113	916158	Silicon Transistor 2SC945L	1
Q114	916116	Silicon Transistor 2SC1674	1
Q115, 116, 117	916158	Silicon Transistor 2SC945L	3
Q118	916194	Silicon Transistor 2SA733	1
D101, 102	923147	Diode IS953	2
D103, 104	922604	Diode IS188	2
D105, 106		No component	
D107	923211	Diode ISV-50, Varactor	1
D108, 109	923147	Diode IS953	2
D110	923588	Diode RD6.2EB, Zener	1
D111, 112	923147	Diode IS953	2
D113	923793	Diode RD5.6EB, Zener	1
D114 thru. 121	923147	Diode IS953	8
D122	924009	Diode RD18EB, Zener	1
D123, 124, 125	923395	Diode IS2222	3
D126	923211	Diode ISV-50, Varactor	1
D127	923147	Diode IS953	1
D128	923588	Diode RD6.2EB, Zener	1
D129	923817	Diode SR1K-2	1
D130, 131	923147	Diode IS953	2
L101	913624	Micro Inductor 1uH	1
L102	913627	Coil L-IS6B R-12NNO419	1
L103	913624	Micro Inductor 1uH	1
L104, 105, 106	913630	Micro Inductor 10uH	3
L107, 108	914020	Filter Choke	2
CH101	914028	Choke Coil 4028	1
IFT101, 102	922838	IFT M402 353N	2
XF1, 2	924026	Crystal Filter 10.7MHZ	2
CF101	923555	Ceramic Filter CFW455D	1
CF102	924007	Ceramic Filter CFW455G	1
TC101 thru. 105	913519	Trimmer Condenser 50pF 7φ	5
BR101	915592	Block Resistor MS6824	1
BR102	915586	Block Resistor MS6824C	1
BR103	915590	Block Resistor MS4734	1
BR104	915518	Block Resistor MS1047	1
BR105	915588	Block Resistor DIP1047	1
BR106	915589	Block Resistor MS1044	1

Ref. No.	Part No.	Description	Q'ty
BR107	915591	Block Resistor MS1034	1
VR101	915594	Slide Volume 5K (B), SQ	1
VR102	915595	Solid Volume 22K (B)	1
VR103	915581	Slide Volume 20K (A), VOLUME	1
VR104	915580	Slide Volume 20K (B), Fine Tuning	1
VR105	915596	Solid Volume 47K	1
X1	923945	Crystal Unit 10.245 MHz	1
X2	923943	Crystal Unit 5.76 MHz	1
X3	923944	Crystal Unit 7.20 MHz	1
X4	923942	Crystal Unit 4.80 MHz	1
X5	923943	Crystal Unit 5.76 MHz	1
RESISTORS, all are 1/8 watt 10% tolerance unless otherwise specified.			
R101	915015	10K ohm	1
R102	915343	10M "	1
R103	915007	2.2K "	1
R104	915427	82K "	1
R105	915343	47K "	1
R106	915372	56K "	1
R107	915327	4.7K "	1
R108	915427	82K "	1
R109	915327	4.7K "	1
R110	915342	22K "	1
R111	915337	680 "	1
R112	915473	820K "	1
R113	915340	6.8K "	1
R114	915372	56K "	1
R115	915001	1.5K "	1
R116	915007	2.2K "	1
R117	915039	100K "	1
R118	915003	1K "	1
R119	915039	100K "	1
R120	915327	4.7K "	1
R121	915343	47K "	1
R122	915007	2.2K "	1
R123	915003	1K "	1
R124, 125	915001	1.5K "	2
R126	915354	150 "	1
R127	915198	47 "	1
R128	915337	680 "	1
R129	915003	1K "	1
R130	915055	8.2K "	1
R131	915015	10K "	1
R132, 133	915327	4.7K "	2
R134	915047	820 "	1
R135	915356	68 "	1
R136	915015	10K "	1
R137	915004	3.3K "	1
R138	915336	220 "	1
R139	915366	33 "	1
R140	915057	470 "	1
R141	915052	33K "	1
R142	915337	680 "	1
R143	915336	220 "	1
R144	915343	47K "	1
R145	915052	33K "	1
R146	915003	1K "	1
R147, 148	915340	6.8K "	2
R149	915039	100K "	1

ELECTRICAL COMPONENT LIST (Cont'd)

4. PLL P.C. BOARD

Ref. No.	Part No.	Description	Q'ty	Ref. No.	Part No.	Description	Q'ty
R150	915340	6.8K ohm	1	C105, 106	913107	Ceramic 250pF	2
R151	915001	1.5K "	1	C107	913452	Ceramic 50pF (SH)	1
R152, 153	915015	10K "	2	C108	913060	Ceramic 0.01uF	1
R154	915336	220 "	1	C109	913021	Mylar 0.1uF	1
R155	915367	470K "	1	C110	913151	Ceramic 10pF (SH)	1
R156 thru. 160	915015	10K "	5	C111	913060	Ceramic 0.01uF	1
R161, 162, 163	915004	3.3K "	3	C112	913021	Mylar 0.1uF	1
R164	915015	10K "	1	C113, 114	913060	Ceramic 0.01uF	2
R165	915057	470 "	1	C115	913021	Mylar 0.1uF	1
R166	915052	33K "	1	C116	913180	Electrolytic 47uF 16V	1
R167	915342	22K "	1	C117	913175	Electrolytic 10uF 16V	1
R168	915039	100K "	1	C118	913148	Electrolytic 4.7uF 16V	1
R169	915057	470 "	1	C119	913125	Ceramic 0.022uF	1
R170	915368	68K "	1	C120, 121	913020	Mylar 0.01uF	2
R171	915003	1K "	1	C122	913452	Ceramic 50pF (SH)	1
R172	915052	33K "	1	C123	913063	Ceramic 0.047uF	1
R173	915009	100 "	1	C124	913631	Ceramic 0.001uF	1
R174	915342	22K "	1	C125	913020	Mylar 0.01uF	1
R175	915009	100 "	1	C126	913060	Ceramic 0.01uF	1
R176	915351	330 "	1	C127	913148	Electrolytic 4.7uF 16V	1
R177	915340	6.8K "	1	C128	913175	Electrolytic 10uF 16V	1
R178	915007	2.2K "	1	C129	913060	Ceramic 0.01uF	1
R179	915340	6.8K "	1	C130	913078	Ceramic 4pF	1
R180	915354	150 "	1	C131	913125	Ceramic 0.022uF	1
R181, 182	915342	22K "	2	C132	913060	Ceramic 0.01uF	1
R183, 184	915386	1M "	2	C133	913266	Ceramic 82pF	1
R185 thru. 189	915039	100K "	5	C134	913125	Ceramic 0.022uF	1
R190 thru. 194	915343	47K "	5	C135	913060	Ceramic 0.01uF	1
R195	915053	2.7K "	1	C136	913051	Ceramic 0.001uF	1
R196, 197, 198	915015	10K "	3	C137	913060	Ceramic 0.01uF	1
R199	915367	470K "	1	C138		No component	
R200	915412	150K "	1	C139, 140	913051	Ceramic 0.001uF	2
R1201	915015	10K "	1	C141	913060	Ceramic 0.01uF	1
R1202	915573	10M "	1	C142, 143	913125	Ceramic 0.022uF	2
R1203	915055	8.2K "	1	C144	913060	Ceramic 0.01uF	1
R1204, 1205, 1206	915342	22K "	3	C145	913125	Ceramic 0.022uF	1
R1207	915015	10K "	1	C146	913051	Ceramic 0.001uF	1
R1208	915342	22K "	1	C147	913151	Ceramic 10pF (SH)	1
R1209	915015	10K "	1	C148	913482	Ceramic 30pF (SH)	1
R1210	915343	47K "	1	C149	913376	Ceramic 50pF (CH)	1
R1211	915039	100K "	1	C150	913115	Ceramic 120pF	1
R1212	915327	4.7K "	1	C151	913348	Electrolytic 0.47uF (NP)	1
R1213	915336	220 " 1/2 watt	1	C152, 153	913077	Ceramic 220pF	2
R1214	915007	2.2K "	1	C154	913097	Electrolytic 100uF 16V	1
R1215, 1216	915091	10 " 1/2 watt	2	C155	913082	Ceramic 50pF (UJ)	1
R1217	915051	68 " "	1	C156	913072	Ceramic 22pF (UJ)	1
R1218	915007	2.2K "	1	C157 thru. 161	913436	Tantalum 0.47uF 16V	5
R1219	915360	270 "	1	C162	913331	Semi-Con. 0.1uF (SC)	1
R1220	915007	2.2K "	1	C163	913276	Ceramic 5pF (CH)	1
R1221	915523	1 "	1	C164, 165	913051	Ceramic 0.001uF	2
R1222	915015	10K "	1	C166	913060	Ceramic 0.01uF	1
R1223	915003	1K "	1	C167	913097	Electrolytic 100uF 16V	1
R1224	915327	4.7K "	1	C168	913062	Electrolytic 470uF 25V	1
R1225	915395	27K "	1	C169, 170	913174	Electrolytic 100uF 25V	2
R1226	915039	100K "	1	C171	913097	Electrolytic 100uF 16V	1
C101	913148	Electrolytic 4.7uF 16V	1	C172	913125	Ceramic 0.022uF	1
C102	913175	Electrolytic 10uF 16V	1	C173	913626	Tantalum 10uF 16V	1
C103	913627	Tantalum 0.22uF 16V	1	C174	913331	Semi-Con. 0.1uF	1
C104	913021	Mylar 0.1uF	1	C175, 176	913482	Ceramic 30pF (SH)	2
				C177	913461	Ceramic 2pF	1
				C178	913051	Ceramic 0.001uF	1
				C179	913125	Ceramic 0.022uF	1
				C180	913626	Tantalum 10uF 16V	1
				C181		Film Con. 0.33uF	1

CAPACITORS, all are in 50 working voltage unless otherwise specified.

ELECTRICAL COMPONENT LIST (Cont'd)

4. PLL P.C. BOARD

Ref. No.	Part No.	Description	Q'ty
C182	913348	Electrolytic 0.47uF	1
C183	913030	Electrolytic 470uF 16V	1
C184	913061	Electrolytic 1000uF 16V	1
C185	913030	Electrolytic 470uF 16V	1
C186	913069	Electrolytic 220uF 16V	1
C187, 188	913030	Electrolytic 470uF 16V	2
C189	913069	Electrolytic 220uF 16V	1
C190	913592	Electrolytic 0.22uF (NP)	1
C191	913021	Mylar 0.1uF	1
C192	913069	Electrolytic 220uF 16V	1
C193, 194, 195	913435	Tantalum 0.33uF 16V	3
C196 thru. 199	913060	Ceramic 0.01uF	4
C1200	913125	Ceramic 0.022uF	1
C1201	913060	Ceramic 0.01uF	1
C1202	913183	Ceramic 68pF	1
C1203, 1204, 1205	913060	Ceramic 0.01uF	3

Ref. No.	Part No.	Description	Q'ty
C1206, 1207	923480	Tantalum 33uF 16V	2
C1208	913594	Electrolytic 1uF (NP)	1
C1209 thru. 1213	913125	Ceramic 0.022uF	5
C1214	913480	Tantalum 33uF 16V	1
C1215	913060	Ceramic 0.01uF	1
C1216, 1217, 1218	913125	Ceramic 0.022uF	3
C1219	913069	Electrolytic 220uF 16V	1
C1220, 1221, 1222	913125	Ceramic 0.022uF	3
C1223, 1224	913051	Ceramic 0.001uF	2
C1225, 1226	913060	Ceramic 0.01uF	2
C1227	913125	Ceramic 0.022uF	1

5. VCO P.C. BOARD

Ref. No.	Part No.	Description	Q'ty
SEMI-CONDUCTORS & COILS			
Q201 thru. 205	916116	Silicon Transistor 2SC1674	5
Q206		No component	
Q207 thru. 210	916116	Silicon Transistor 2SC1674	4
Q211	916158	Silicon Transistor 2SC945L	1
Q212 thru. 215	916194	Silicon Transistor 2SA733	4
Q216	916158	Silicon Transistor 2SC945L	1
Q217, 218	916194	Silicon Transistor 2SA733	2
D201	923211	Diode ISV-50, Varactor	1
D202, 203	923416	Diode IS-2209, "	2
D204 thru. 207	923395	Diode IS-2222	4
D208, 209, 210	923211	Diode ISV-50, Varactor	3
D211 thru. 215	923147	Diode IS953	5
L201, 202	923930	Coil MC108 2-1/2t	2
L203	923922	Coil " 3-1/2t	1
L204	923926	Coil MC116 5-1/2t	1
L205	923927	Coil " 6-1/2t	1
L206	923928	Coil " 8-1/2t	1
TC201 thru. 206	913529	Trimmer Condenser 10pF 5p	6
RESISTORS, all are 1/8 watt 10% tolerance unless otherwise specified.			
R301	915057(J)	470 ohm	1
R302	915009	100 "	1
R303	915052	33K "	1
R304, 305	915009	100 "	2
R306	915337	680 "	1
R307	915343	47K "	1
R308	915342	22K "	1
R309	915410	560 "	1

Ref. No.	Part No.	Description	Q'ty
R310	915015	10K ohm	1
R310	915340	6.8K "	1
R312	915342	22K "	1
R313	915003	1K "	1
R314	915015	10K "	1
R315	915340	6.8K "	1
R316	915342	22K "	1
R317	915003	1K "	1
R318	915015	10K "	1
R319	915340	6.8K "	1
R320	915409	5.6K "	1
R321 thru. 328	915015	10K "	8
R329 thru. 332	915342	22K "	4
R333	915007	2.2K "	1
R334	915015	10K "	1
R335	915340	6.8K "	1
R336, 337	915343	47K "	2
R338	915007	2.2K "	1
R339	915410	560 "	1
R340	915342	22K "	1
R341	915009	100 "	1
R342	915057(J)	470 "	1
R343	915052	33K "	1
R344	915009	100 "	1
R345	915342	22K "	1
R346	915344	220K "	1
R347	915003	1K "	1
R348	915015	10K "	1
R349	915003	10K "	1
R350	915015	10K "	1
R351	915003	1K "	1
R352	915015	10K "	1
R353	915010	10 " 1/4 watt	1
R354	915003	1K "	1
R355	915015	10K "	1
R356	915003	1K "	1
R357	915015	10K "	1
R358	915342	22K "	2

ELECTRICAL COMPONENT LIST (Cont'd)

5. VCO P.C. BOARD

Ref. No.	Part No.	Description	Q'ty
CAPACITORS, all are in 50 working voltage unless otherwise specified.			
C301, 302	913060	Ceramic 0.01uF	2
C303	913268	Ceramic 47pF	1
C304	913076	Ceramic 2pF	1
C305	913265	Ceramic 56pF	1
C306	913081	Ceramic 1pF	1
C307	913172	Ceramic 39pF	1
C308	913122	Ceramic 7pF	1
C309	913063	Ceramic 0.047uF	1
C310	913122	Ceramic 7pF	1
C311	913051	Ceramic 0.001uF	1
C312	913060	Ceramic 0.01uF	1
C313	913081	Ceramic 1pF	1
C314	913266	Ceramic 82pF	1
C315	913078	Ceramic 4pF	1
C316	913060	Ceramic 0.01uF	1
C317	913078	Ceramic 4pF	1
C318, 319	913060	Ceramic 0.01uF	2
C320	913081	Ceramic 1pF	1
C321	913266	Ceramic 82pF	1
C322	913078	Ceramic 4pF	1
C323	913060	Ceramic 0.01uF	1
C324	913078	Ceramic 4pF	1

Ref. No.	Part No.	Description	Q'ty
C325, 326, 327	913060	Ceramic 0.01uF	3
C328	913093	Ceramic 25pF	1
C329	913078	Ceramic 4pF	1
C330	913336	Electrolytic 4.7uF 25V	1
C331	913093	Ceramic 25pF	1
C332 thru. 337	913060	Ceramic 0.01uF	6
C338	913125	Ceramic 0.022uF	1
C339 thru. 343	913060	Ceramic 0.01uF	5
C344	913080	Ceramic 15pF	1
C345	913076	Ceramic 2pF	1
C346	913171	Ceramic 30pF	1
C347, 348	913060	Ceramic 0.01uF	2
C349	913081	Ceramic 1pF	1
C350	913060	Ceramic 0.01uF	1
C351	913080	Ceramic 15pF	1
C352 thru. 357	913060	Ceramic 0.01uF	6
C358		No component	
C359	913069	Electrolytic 220uF 16V	1
C360 thru. 363	913060	Ceramic 0.01uF	4

MEMO

A series of horizontal lines for writing, with a vertical margin line on the left side.