

HERSCHEL

USER MANUAL

HF-225 General Coverage Receiver.

User's Manual.

Contents

Introduction.	2
Getting started.	3
Controls and Connections.	10
Operating the HF-225.	13
Care of your Receiver.	17
General notes.	17
Optional Units.	18
Circuit description.	19
Circuit Diagrams.	20
Receiver specification.	24
Notes and Frequencies.	28
Index.	31
HF Band Plan.	32

Introduction.

The term "Communications Receiver" was originally used in its quite literal sense to describe a radio receiver which was part of a point to point communications link.

These radio links were normally manned by trained operators, and Morse Code was the usual method of transmitting information. Because of the specialist nature of the system and the fact that the operators were technically trained the communications receiver itself was quite often a complex piece of equipment.

Over the past twenty or so years, a marked change has taken place in HF spectrum occupancy and there has been a considerable increase in the use of short wave broadcasting, air traffic control, news agency transmissions and so on. The interest in listening generated by this spread of activity has led to a demand amongst the general public for receivers which will enable them to keep in touch with world affairs by short wave radio.

Clearly, these users of receivers are relatively unskilled in the handling of complicated equipment and this in turn has resulted in the introduction of simpler receivers. However, simplicity of operation has often been accomplished by a compromise in actual performance, and the results obtained from some of these simple receivers have been quite disappointing.

As our Chairman once remarked, "Some receivers are rather like a chocolate éclair; Wonderful to behold but containing little of substance."

The design and development of the HF-225 was based on straightforward objectives :-

- To obtain sufficient RF performance for the receiver to operate without problem in crowded bands with many strong signals.
- To combine complete control of a necessarily complex piece of equipment with easy operation for the user.
- To achieve both the previous objectives within a reasonable price range.

We believe that these stated goals have been reached, and that the HF-225 receiver represents a truly new approach to meeting the demands of the educated short wave listener.

Getting started.

Aerials and Earths.

Operating the HF-225 is described in the next two sections of this manual, but you may well ask "What is a suitable aerial?" The receiver has been designed to work well with a simple long wire aerial of about 10 to 30 metres in length. This will provide good results on most frequencies covered by the receiver, but if your interest is in a particular band, such as the 49 metre broadcast band, you may wish to consider a dipole aerial tuned to that frequency. As an extension to the dipole idea, you could make use of a "Fan", or multi-band, dipole. Details of these aerials are given below, together with formulae for working out their lengths.

Do not be dazzled by the idea of putting up the longest wire in the whole world. This will bring you to grief, because you will probably overload the input stages of the receiver with signals from strong broadcast transmitters, with resultant problems of cross modulation and intermodulation.

A decent RF ground system is always an advantage, and this can be made fairly simply by driving a metal post into the ground to a depth of about 1 metre. Whilst a single ground spike is acceptable, better results will be obtained using several spikes, all joined together by heavy copper wire above ground, and taken to the ground connection on the rear panel of the receiver. The mains ground is an alternative, but whilst it is good enough for safety purposes it often carries quite high levels of electrical noise.

The Long Wire Aerial.

This is the simplest type of aerial system, and consists of a single wire erected with a horizontal top section and a down lead from one end going to the receiver's 600 Ω aerial input terminal. The wire should be erected as high as possible, and as far as possible away from other structures or overhead power lines. Insulators should be used as shown, and the lead in wire should also be insulated. The drawing shows a long wire in the form of an "Inverted L", but many other configurations can be used, such as a slanting wire leading directly to the receiver.

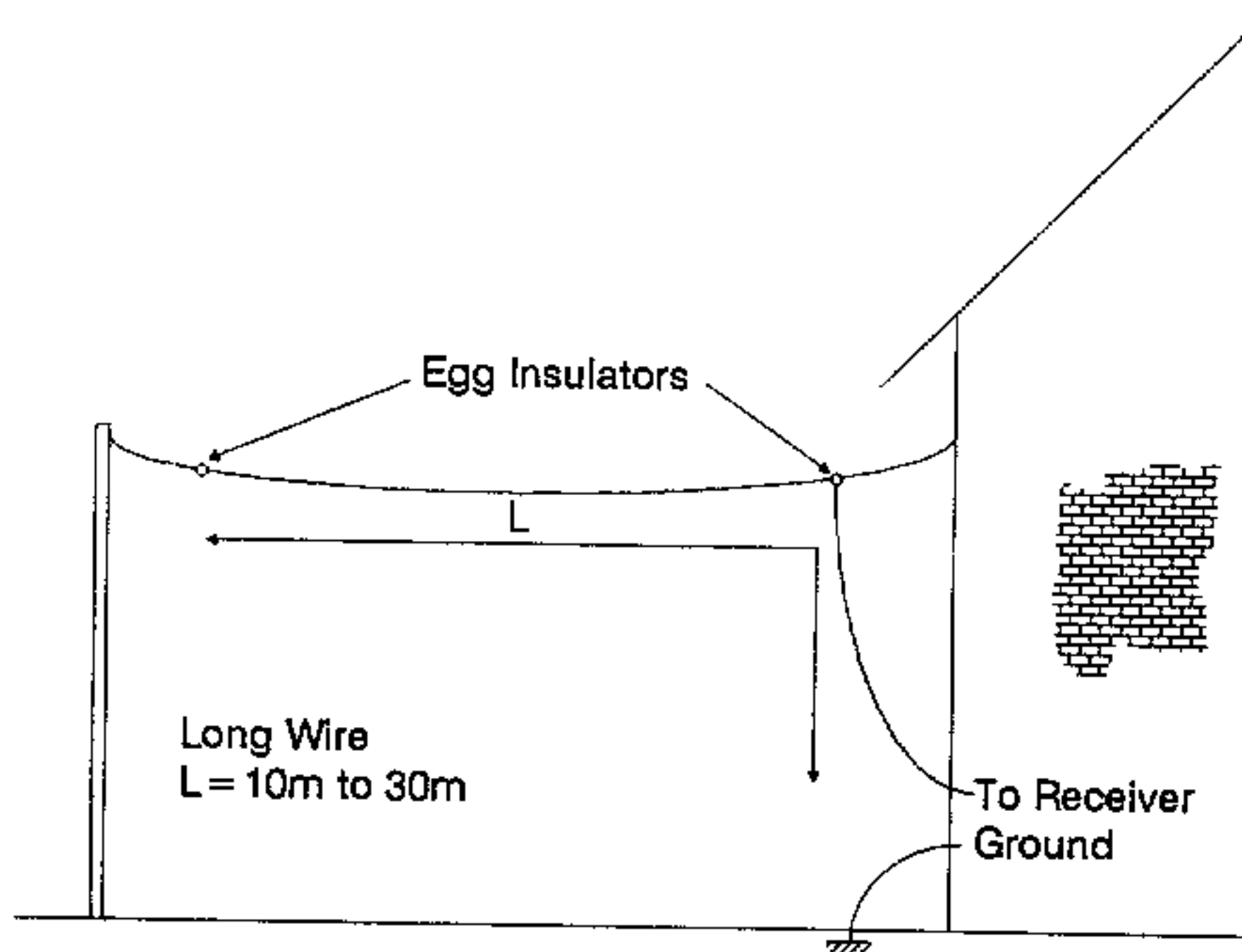

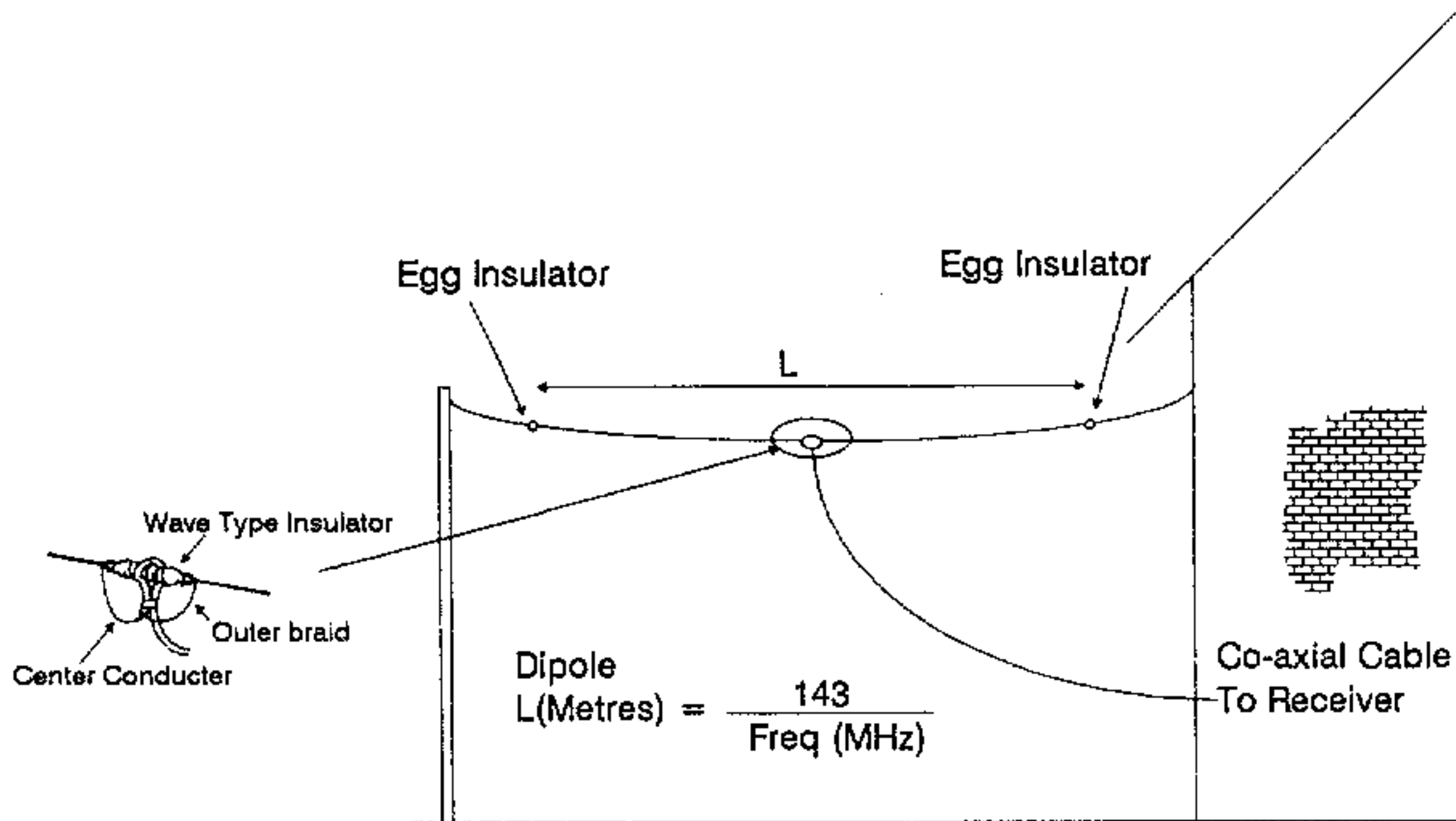

The Half-Wave Dipole Aerial.

This is normally constructed for a specific frequency, or band of frequencies, and the length of the aerial is therefore critical. The length in metres is given by dividing 143 by the operating frequency, or the centre frequency of the band (in Megahertz).

Remember that the dipole has directional properties, with maximum received signal at right-angles to the aerial and minimum signal along its length. It presents a low impedance at the centre feed point, and is best connected to the receiver by co-axial cable. At HF either 50 Ω or 75 Ω cable is satisfactory. The purist will point out that the dipole is a balanced device and the co-axial cable is unbalanced. A balanced to unbalanced transformer (Balun) may be used at the centre point to correct this, but for the general listener it is not often required. A balun will help to reduce electrical interference picked up in the down lead to the receiver.

The "Inverted V" aerial is a variant of the dipole in which the ends are dropped to terminate at points closer to the ground, and a single central support is used. It is very convenient when suitable dipole supports are not available. The effect of the ground modifies the length formula, and 148 should be substituted in place of 143.

The Fan Dipole Aerial.

The fan dipole is a series of dipole elements connected to a single feeder at a common central point. Clearly there is a limit to the number of elements which can be accommodated, and this is normally three or four. There is some interaction between the dipoles, but the single dipole basic formula can be used for calculating the length of each element.

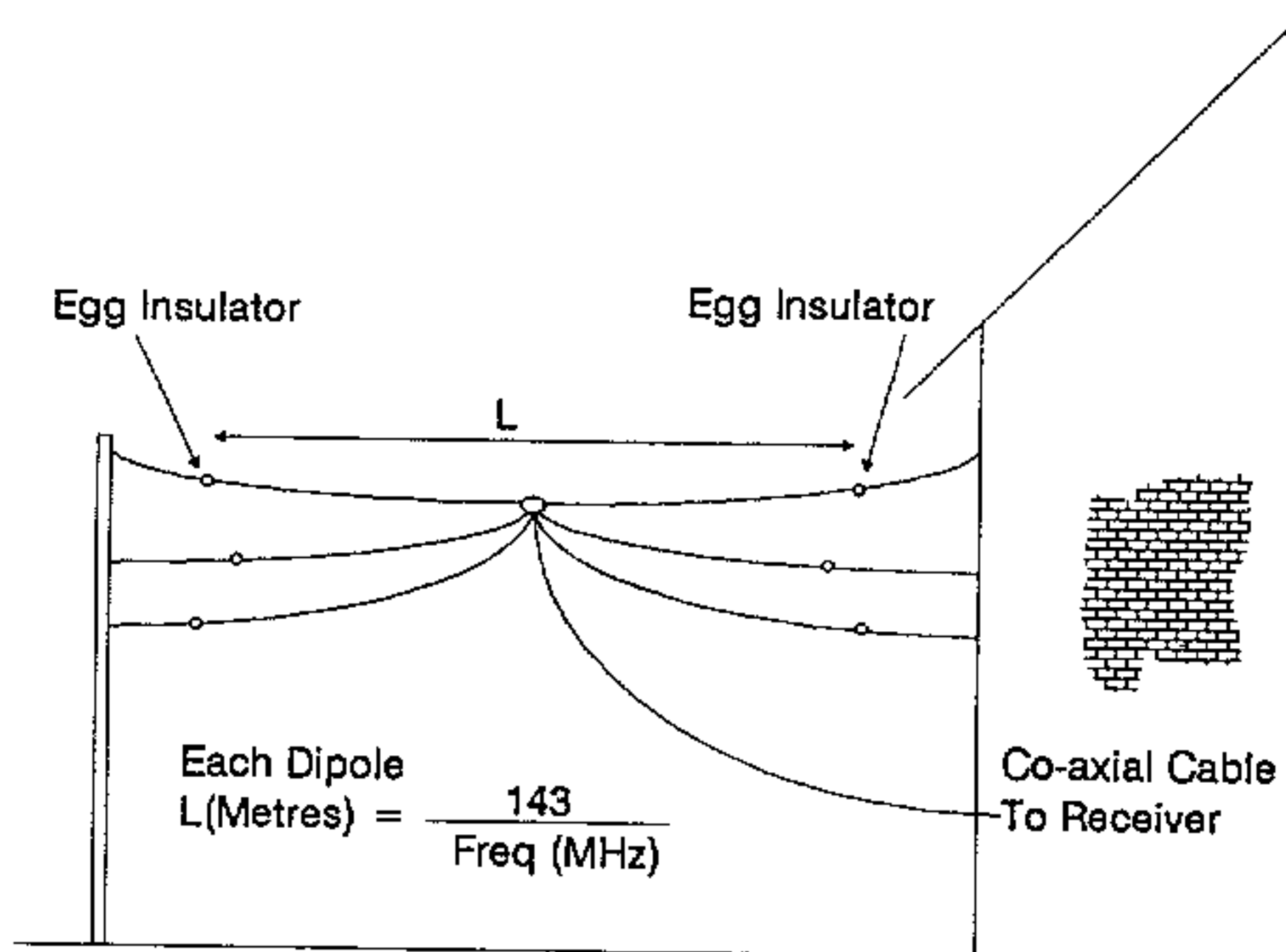

The Vertical Aerial.

There are several ready-made vertical aerial systems on the market, and they will provide an easy to erect system occupying very little ground area. These aerials are normally designed to work over quite a narrow frequency range (typically amateur radio bands), and for general listening a simple wire will often give better results.

Active Aerials.

When the length of an aerial is very much shorter than the wavelength of signals to be received its impedance is very high, and a direct connection to the receiver will not transfer signals efficiently. To overcome this, an active aerial system places a high-impedance amplifier between the aerial and the receiver. The amplifier must be near to the aerial, so often power is fed to it along the signal wire to the receiver. The active aerial is very compact, often little more than a metre long, but a poorly designed active aerial can badly compromise the receiver's performance due to the amplifier overloading in the presence of many strong broadcast signals.

Loop Aerials.

A true enthusiast's aerial, loops are usually home-constructed and can offer very good results at the low-frequency end of the HF band. Their selective tuning and directional properties make them ideal for receiving weak stations in the crowded medium wave band. Constructional details can usually be obtained from issues of radio magazines or from local DX clubs.

The Power Supply and other Connections.

The HF-225 requires an external DC supply of between 10 and 15 volts. The absolute maximum supply is 16 volts, and if this is exceeded damage may occur to the receiver. The supply polarity is negative ground only, and although reverse polarity protection is built in it is wise to ensure that any supply is correctly connected. Be sure that the receiver power switch is OFF before plugging in or unplugging the power connector.

In most countries, the HF-225 will be supplied with a small 12 volt regulated power unit which is designed to operate from the local mains power. Remember that this supply will be operating all the time that it is connected to the mains outlet, and it is a wise safety precaution to disconnect it when the receiver is not in use.

In the United Kingdom the power supply is fitted with a three-core mains lead, and the earth connection (yellow/green) is connected to the negative (ground) terminal of the receiver. This provides a reasonable earth connection for the receiver, but in some cases, where mains-borne interference is prominent, it will be necessary to provide the receiver with a good RF earth, either in addition to the mains earth or in some cases instead of it. If the receiver is used with any other mains power supply it should be able to comply with BSI standards relating to Class 2 insulation.

External Loudspeaker.

A small internal loudspeaker is provided in the HF-225 so that it is self contained, but although it can provide reasonable all round audio quality, clearly in the limited space available compromise has to be made. You will find that if the volume control is set to a high level there may be some audio feedback caused by vibration induced by the internal loudspeaker. If it is necessary to operate the receiver for long periods at high audio levels the use of an external loudspeaker is recommended.

Because the HF-225 is capable of giving a high quality audio signal, we suggest you use a good external loudspeaker, and a small bookshelf type Hi-Fi unit is satisfactory. We can provide a suitable unit as an optional accessory with the correct connecting lead for the HF-225. Any external loudspeaker should have an impedance of 4 Ω to 8 Ω .

Record Output.

Many keen listeners like to tape record any interesting stations they hear, and a low level audio output has been provided for this purpose. The record out socket accepts a 3.5mm mono jack plug and provides a level suitable for feeding into the line input of most tape recorders or amplifier systems. An attenuating resistor should be added in the lead if feeding directly into the microphone input of a cassette recorder. The output level at this socket is not affected by the Volume or Tone controls, so that the loudspeaker can be used to monitor whilst recording.

The record output can also be used for driving most types of receiver ancillary equipment such as RTTY, Facsimile or Morse Code decoders. The output level is about 350 mV from a source impedance of 5 k Ω .

Types of Signal.

The HF-225 is equipped to receive most types of transmission likely to be encountered within its tuning range, and although most users will be familiar with these, here is a short section on this topic that may be useful to the beginner.

AM (Amplitude Modulation).

This was the earliest method used of audio modulation of an RF carrier wave, and is still almost universally used for long, medium and short wave broadcasting. An AM signal is fairly easy to tune in, and given a reasonable signal strength, the receiver may not need to be spot on in frequency. However when conditions are poor, AM can be difficult to resolve - one particular problem is frequency selective fading and this is discussed later.

AM Selectivity.

A radio signal occupies a certain portion of the radio spectrum which is known as its bandwidth. The bandwidth of an AM signal is twice its highest modulation frequency, and because of this broadcasters are restricted to transmitting audio frequencies below 5 kHz so that they do not occupy too much spectrum. In the long and medium wave broadcast bands, station frequencies are separated by 9 kHz (10 kHz in the USA) so there is little or no overlap of adjacent signal bandwidths. In the short wave bands however, the stations use a nominal 5 kHz spacing, and some broadcasters do not abide by any rules at all, so there is considerable signal overlap.

The HF-225 is provided with four different filter bandwidths because of this very problem. If you are receiving a strong signal in a clear part of the radio spectrum then you can use the 10 kHz filter and obtain the best fidelity. The stronger and closer adjacent stations are, the narrower the filter you will need, and the more muffled the sound will be because high frequencies are removed. The 7 kHz filter provides a good compromise for most medium wave conditions, and the 4 kHz filter for short wave. The 2.2 kHz filter can be used under severe conditions, but it is really only suitable for speech reproduction.

When AM mode is selected on the HF-225, the 7 kHz filter is initially switched in. If you want to change to a different filter you can use the filter select function. You may find that reception of a station is improved by tuning the receiver slightly above or below its carrier frequency. This is quite a useful technique if there is a strong adjacent signal that you don't want. As long as the carrier signal is within the receiver's filter then all will be well, but if you tune too far or select a narrower filter then the signal will become distorted.

SSB (Single Sideband).

An AM signal can be considered as a carrier wave combined with two identical sidebands which contain the modulating audio signal. It is possible to remove one of the sidebands without losing any vital information, and immediately halve the bandwidth occupied by the signal. In practice the carrier wave is also removed (or partially suppressed) to improve transmission efficiency, and the result is a single sideband transmission.

SSB transmissions are used extensively for voice communication, particularly to aircraft and shipping, and also by radio amateurs. It is possible to use either of the two initial sidebands of a signal, so there are two distinct types of SSB transmission; Upper Sideband (USB) where the sideband frequency is above the carrier frequency, and Lower Sideband (LSB) where it is below. Nearly all commercial transmissions are USB, as are amateur transmissions at frequencies above 10 MHz. At frequencies below 10 MHz radio amateurs use LSB by convention.

To receive an SSB transmission, the receiver must re-insert the missing carrier signal. If this is not done the signal will sound just like Donald Duck, - try listening to an SSB signal in AM mode for this effect. For correct reception the receiver should be tuned exactly to the carrier frequency,

but for speech an error of 50 Hz either way will not be serious. The HF-225 has a very slow tune rate on its SSB mode to facilitate accurate tuning, but you will need a steady hand. The pitch of the received voice will change as you tune through the signal, but only at one tuning position will it sound like a natural voice.

A 2.2 kHz bandwidth filter will just accommodate the audio frequencies used for voice transmission, and this is the filter most commonly used for SSB reception. The HF-225 will automatically select this filter for LSB or USB modes, but under good signal conditions selecting the 4 kHz filter may offer improved clarity.

CW (Continuous Wave, ie Morse).

Morse code is usually transmitted by interrupting a single carrier wave, and it occupies a very narrow bandwidth. In terms of ability to get a message through under difficult propagation conditions Morse code is one of the most efficient methods, although modern error-correcting digital data systems are also very good. CW signals are received in the same way as SSB signals, with the carrier inserted in the receiver producing a beat note with the incoming signal. In the CW mode the HF-225 provides an 800 Hz offset between the display and the internal carrier, so that a note is heard at 800 Hz when the receiver is tuned exactly to the signal.

The HF-225 initially selects the 2.2 kHz filter in CW mode and this should be used for finding and tuning signals. As an alternative, a narrow 200 Hz filter is provided, and its use will greatly reduce the background noise, allowing the Morse to be more easily read. Careful tuning is needed to place the signal at the peak of this filter, which is centred on 800 Hz.

RTTY (Radio Teletype).

The method of sending teleprinter messages by HF radio link is to use two closely spaced signals, transmitting one or the other to send binary data. Each teleprinter character is encoded into a different sequence of tones which are transmitted in a bewildering combination of different speeds, tone shifts, and codes. RTTY signals are tuned in SSB mode on a receiver, but require a special terminal unit to decode and display the actual text.

FAX (Facsimile).

Pictorial information (often meteorological data) is transmitted over HF radio links for reception by shipping. As with RTTY, a special facsimile decoder and display or printer is required for its reception.

FM (Frequency Modulation).

When the D-225 detector option is fitted to the HF-225, the receiver will receive FM signals. In the context of an HF receiver this means narrow band FM, which occupies a bandwidth of around 12 kHz. This is not to be confused with broadcast FM transmissions which have bandwidths in excess of 150 kHz, and are normally transmitted at VHF or UHF where there is sufficient spectrum to accommodate them.

FM signals in the HF spectrum are usually found either in the 27 MHz Citizens Band or in the 28 MHz amateur band. It is typical of FM receivers that they produce a large amount of noise when there is no signal at the aerial. To overcome this a squelch system is employed to turn off the audio output unless a signal is detected. The HF-225 squelch system may be turned on or off manually by using the filter select control. The filter bandwidth is fixed at 12 kHz in FM mode.

AM Propagation and Fading.

During AM signal reception it is possible to experience severe fading problems, particularly after nightfall. This is mainly due to the signal reaching the receiver by several different paths from the transmitter, and it is most common after dark because this is when the ionosphere reflects most HF radio signals. Fading occurs when the signals arrive at the receiver in antiphase (having travelled different distances) and then cancel each other out. This will only occur at a few specific frequencies at any one instant, hence the term frequency selective fading.

If a selective fade reduces the carrier level of an AM signal, but leaves the sideband levels unaltered, a receiver with a conventional AM detector will not be able to correctly reproduce the signal, and the output will be distorted. There are two techniques that can be used to improve the situation; ECSS, and Synchronous (or Phase-Locked) AM detection.

ECSS (Exalted Carrier, Selectable Sideband).

The ECSS technique makes use of the fact that with a good, selective receiver, capable of resolving SSB, an AM signal can be passed through the SSB filter which is only wide enough to allow one sideband through. The filter must attenuate the carrier signal by at least 20dB for this technique to work with any success.

The receiver can be used in the SSB mode with the incoming AM carrier tuned to zero beat, and the accompanying sideband treated as a true SSB signal. Either the upper or lower sideband can be selected using either USB or LSB mode, so interfering stations can often be eliminated. The improvement in intelligibility is often dramatic, and it is well worth trying out ECSS and developing the ability to use it. The HF-225 when used with its 2.2 kHz filter is ideally suited to ECSS reception.

AMS (Synchronous AM).

The difficulty in receiving music signals with the ECSS method is that it is very difficult to match the receivers injected carrier exactly with the frequency of the incoming carrier. Any difference results in a frequency shift of the audio signal, and the consequent loss of harmonic relationships.

The synchronous AM detector in the D-225 option uses a narrow deviation phase-locked oscillator to replace the incoming AM carrier. When phase locked, this oscillator is at exactly the same frequency as the carrier signal, and does not have to rely on absolute receiver tuning accuracy. Incoming carrier level changes make no difference to the signal detection provided that there is some carrier for the oscillator to lock on to.

Controls and Connections.

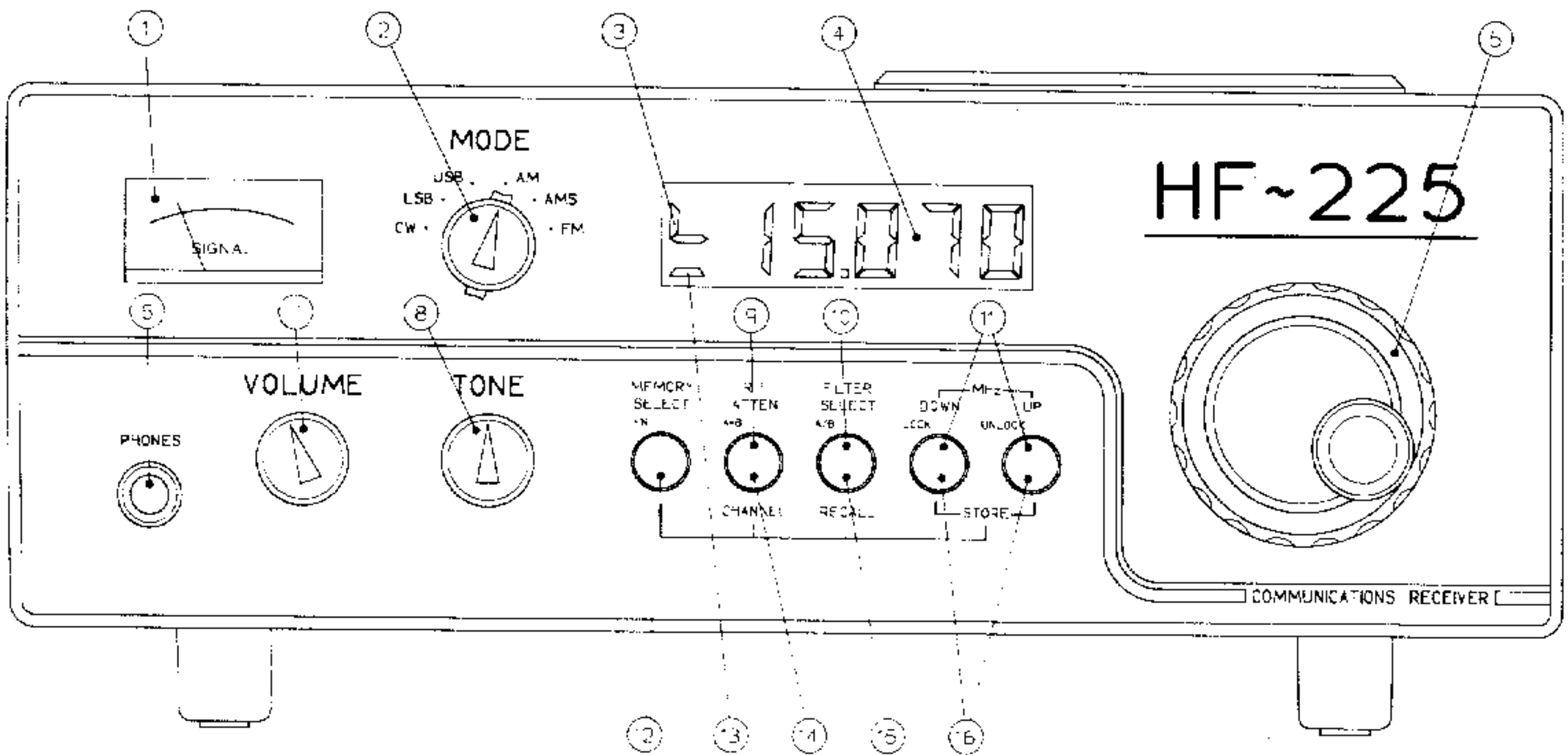

(1) Signal strength meter

Calibrated S1 to S9 and 10dB, 30dB and 50dB above S9. The S9 signal strength is set at 50 microvolts p.d. at the 50 Ω antenna socket.

(2) Mode Switch

Selects one of six available reception modes :-

- | | |
|-----|--|
| CW | For reception of CW (Morse) signals. |
| LSB | For single-sideband signals, (Lower sideband). |
| USB | For single-sideband signals, (Upper sideband). |
| AM | For reception of AM (broadcast) signals. |
| AMS | For AM reception using the synchronous detector. (D-225 option). |
| FM | For reception of narrow-band FM signals. (D-225 option). |

(3) AMS detector lock indicator

L is illuminated when the synchronous detector is correctly locked to the received signal.

(4) Frequency display

A 5-digit back-lit LCD showing the received frequency to the nearest kilohertz. Frequencies below 1700 kilohertz are shown directly and those above in megahertz, with a decimal point separating MHz and kHz.

(5) Main tuning knob

For tuning the receiver and selecting memories. The rate of tuning is adjusted according to the receiver's mode and the speed of rotation of the tuning knob.

(6) Headphone socket

A headphone output jack for a standard 1/4" plug. Mono or stereo headphones may be used (stereo phones operating in mono), and the internal loudspeaker is disconnected when the headphones are connected.

(7) Volume control and Power switch

Controls the volume in the loudspeaker and at the headphone output. When turned fully counter-clockwise to the click position, the receiver power is turned off, and if the internal rechargeable batteries are fitted (B-225 option) then these are switched into charge mode.

- (8) **Tone control** Varies the audio tonal quality in the loudspeaker and at the headphone output. The control provides either high frequency cut or low frequency cut, with a flat response in its central position.
- (9) **R F Attenuator button** Displays, and allows the user to change, the state of the attenuator. A fixed 20dB of attenuation may be switched in or out.
- (10) **Filter select button** Enables the receiver bandwidth to be displayed and changed. In LSB, USB, AM and AMS modes, four different filters are available :- 2.2, 4, 7 and 10kHz. In CW mode, two :- 2.2kHz and 200Hz. In FM mode this control turns the squelch facility on and off.
- (11) **Megahertz fast tuning buttons** Tunes the receiver in one-megahertz increments up or down the HF spectrum. The tuning will continue automatically if either of the buttons is held pressed, but will stop when the upper or lower frequency limit of the receiver would be exceeded.
- (12) **Memory mode select button** Switches the frequency display into memory mode and then selects memory preview. Turning the main tuning knob selects the memory displayed. Pressing the memory select button again returns the display to frequency mode.
- (13) **Memory mode flag** Is illuminated when the frequency display is showing memory information.
- (14) **Memory channel mode button** In memory mode, switches channel monitoring on and off.
- (15) **Memory recall button** In memory mode, transfers a frequency from the selected memory to the receiver tuning.
- (16) **Memory store buttons** In memory mode, transfers the current receiver frequency into the selected memory, over-writing any previous content. Both store buttons must be pressed simultaneously.

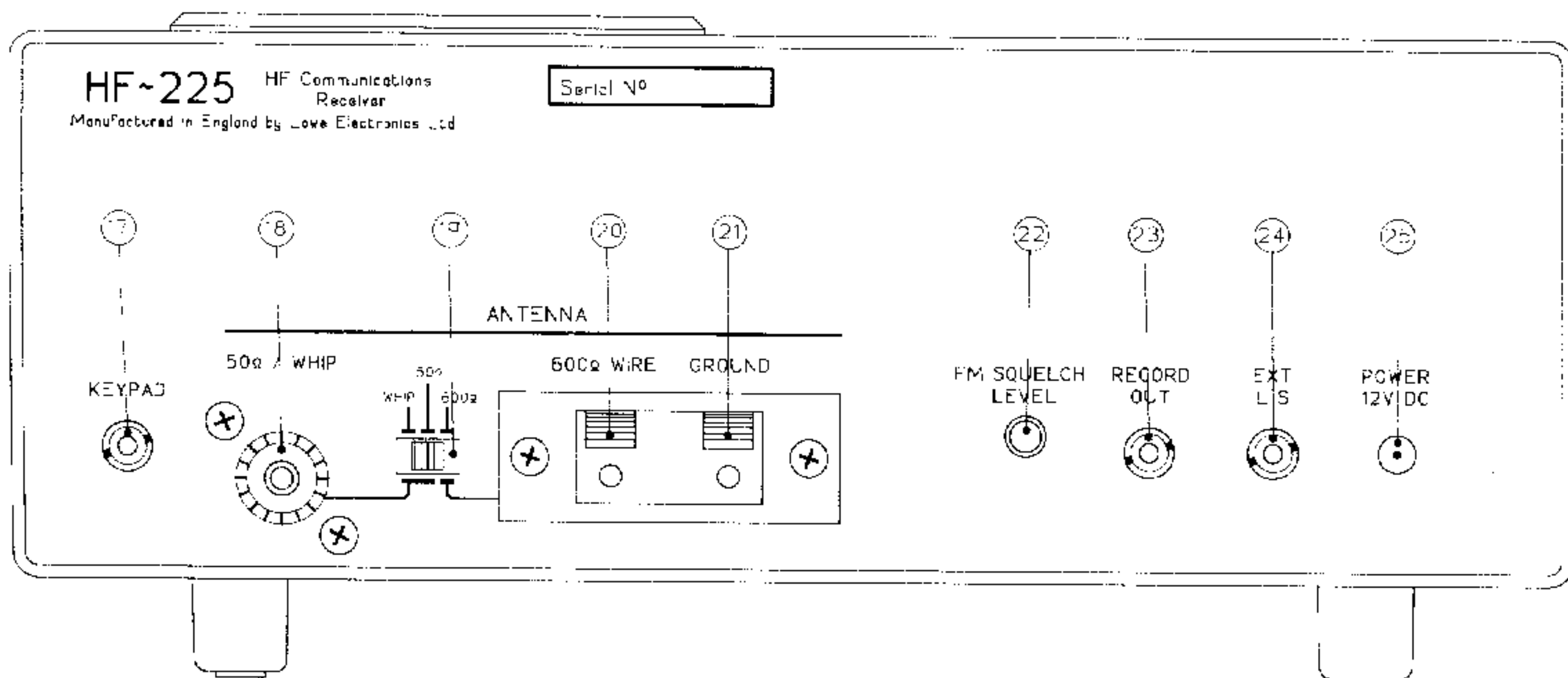

- (17) **Remote keypad jack socket** For connection of the K-225 keypad for direct frequency entry.
- (18) **50 Ω / Whip antenna socket** For connection of antennae terminated with 50 Ω or 75 Ω co-axial cable. The cable should be fitted with a PL-259 plug to match this socket. Also used for mounting the telescopic whip aerial when the W-225 option is used.
- (19) **Antenna select switch** Determines which antenna socket is connected to the receiver input. The Whip position will only operate if the internal W-225 amplifier is fitted to the receiver.
- (20) **600 Ω antenna terminal** For connection of wire antennae not terminated with co-axial cable.
- (21) **Ground terminal** Connected to the case of the receiver. A good earth connection will improve reception and reduce interference, particularly with a wire aerial.
- (22) **FM squelch level adjustment** Only present when the D-225 detector option is fitted, this sets the signal level at which the squelch circuit turns on the audio output.
- (23) **Record output jack socket** A fixed level signal is available here that is unaffected by the volume or tone control settings. The level is suitable for feeding into the line input of most tape recorders and for driving RTTY decoders.
- (24) **External loudspeaker jack socket** For connection of an external loudspeaker of 4 Ω or 8 Ω impedance. Inserting a plug into this socket will disconnect the internal loudspeaker.
- (25) **12V DC power input socket** For connection of a suitable power source. Ensure correct supply polarity (as marked on the panel) and that the voltage does not exceed 15V.

Operating the HF-225.

Volume and Tone Controls.

The volume and tone controls affect the level and quality of the sound from the loudspeaker or fed to the headphones. The signal from the record out socket on the rear of the receiver is not altered by these controls.

The tone control can provide quite comprehensive audio filtering facilities. When in its central position the response is flat, but when turned to the left high frequencies are reduced and this can be used to lessen the unpleasant whistles from interfering stations. When turned to the right low frequencies are reduced and the clarity of speech is often improved.

The volume control also functions as a power switch, and turning it fully counter-clockwise will turn the receiver off. If you are running the receiver from its mains adapter then the adapter will still be running even if the receiver is turned off, and you should switch off or unplug the adapter when not in use.

If internal rechargeable batteries are fitted to the HF-225 (the B-225 option) then the batteries will charge if power is supplied to the receiver when it is switched off. The batteries will fully charge in about 20 hours from a completely discharged condition. A limited amount of over-charging will not harm the batteries, but you should avoid charging for periods longer than 48 hours. When the receiver is switched on, a small trickle-charge is supplied to the batteries which will maintain a full charge against gradual leakage.

Receiver Tuning.

The HF-225 is tuned with a single rotary control (which drives a digital shaft encoder) giving continuous tuning over the whole of the receiver's range. There are no separate tuning bands on the HF-225, but for convenience two buttons, MHz Down and MHz Up, are provided to tune in one-megahertz steps to a frequency near the one of interest.

The frequency readout on the HF-225 is at the true carrier frequency in all modes of reception. It is at the centre of the filter passband in AM mode, and at the re-injected carrier frequency in USB and LSB modes. An 800 Hz offset from carrier is provided in CW mode. Although the frequency display changes in 1 kilohertz steps the receiver is actually tuned in much smaller steps. These are sufficiently small for tuning to appear to be continuous.

The rate at which the receiver tunes when the tuning knob is rotated depends on the mode selected and on the speed of rotation of the knob. All modes, with the exception of AMS, offer the facility of speed-up tuning - when the tuning knob is rotated rapidly the tuning rate increases. This allows a slow tuning rate for precise signal resolution coupled with the ability to reach the required frequency quickly.

You may find at first that the receiver apparently jumps in frequency when you are trying to tune a signal. This is because you have moved the tuning control quickly or in a jerky fashion and the receiver has increased its tuning rate. A smooth action will cure the problem, and will make tuning the HF-225, and any other receiver, much easier.

The tuning rates adopted by the HF-225 are shown in the table below :-

Receiver Mode	Normal tune rate		Fast tune rate
	Tuning step	kHz per rev	
LSB, USB & CW	8 Hz	1.6	12 times faster
AM	50 Hz	9	10 times faster
FM	125 Hz	25	4 times faster
AMS	8 Hz	1.6	Only normal rate

When the operating frequency limits of the HF-225 are reached, tuning will stop. There are no mechanical stops on the tuning knob, but you will notice that the frequency display stops changing. The lower tuning limit is 30 kHz and the upper limit 29.999 MHz on a standard model, but these are changed to 150 kHz and 26.1 MHz for the German market. Unlike some receivers, the HF-225 does not wrap-around between its highest and lowest frequencies.

Tuning in AMS mode.

In AMS mode (with the D-225 detector option fitted) the tuning control is used in a slightly different way. The synchronous AM detector is not suited to search tuning - ie tuning the bands to find stations - so this should be done with the receiver set in the normal AM mode. When a station has been tuned, the AMS mode can be selected, and the tuning control used to fine-tune the receiver until the detector locks to the signal and the L is shown in the top left corner of the frequency display.

When AMS mode is selected it is likely that you will hear the signal with a superimposed tone. Slowly turn the tuning knob so that the pitch of the tone falls, and continue until the tone stops. Finally tune for the best clarity of reception. During severe carrier fading it is possible for the detector to unlock from the signal, causing a tearing sound. This effect can often be minimised by some judicious fine tuning.

Keypad frequency entry.

If you plug the K-225 keypad option into the receiver, then you can tune the receiver by entering frequencies directly. This is very useful for quickly checking stations at known frequencies, or for setting the frequency in a particular band of interest and then searching for signals with the main tuning control.

The keypad unit is remote from the receiver so that it can be positioned in a convenient place. It is connected by a short cable which should be plugged into the keypad jack on the rear panel of the HF-225. The keypad has 12 keys - the digits [0] to [9], the [#] key (enter), and the [*] key (cancel). As keys are pressed they are shown on the receiver's frequency display.

Frequencies are entered in kilohertz. The receiver will only tune to the entered frequency when it is complete - either when sufficient digits have been keyed in or when the enter key [#] is pressed. Frequencies above 3000 kHz will enter automatically as soon as the last digit is keyed. Those below 3000 kHz should be followed by the enter key [#].

For example :-

[1]	[5]	[0]	[7]	[0]	tunes to 15.070 MHz
[1]	[9]	[8]	[#]		tunes to 198 kHz

Because frequencies entered by the keypad are to the nearest kilohertz, it may be necessary to re-tune the receiver slightly to correctly resolve single sideband signals or when using the receiver in AMS mode.

If you press an incorrect key on the keypad, the current digits can be cleared by pressing the cancel key [*], after which the frequency should be re-entered. Please note that once keypad frequency entry is started the other controls on the receiver will be inoperative until entry is completed or cancelled.

R F Attenuator.

The RF attenuator reduces the signal from the aerial that reaches the input stages of the receiver. There are two situations where its use is beneficial, firstly when a strong local signal exceeds the range of the automatic gain control in the receiver, and secondly when strong signals close to the one being received overload the receiver's input.

The first case is easy to see, because the signal strength meter will deflect well over to the right-hand end of its scale. The second effect can be recognised with experience, but is more subtle.

Either way, if switching the attenuator on results in better reception, then use it. Otherwise leave it switched off.

When you press the [**R F A T T E N**] button the frequency display will change to show the present condition of the attenuator. There are two possible messages, either **OFF** or **ATTN**. If the button is pressed again whilst either of these show, then the attenuator state will be changed, and the display changed accordingly. The display will revert to the receiver's frequency after about 3 seconds. The attenuator in the HF-225 applies a fixed 20 dB of attenuation when it is switched in, reducing the signal voltage by a factor of ten.

Filter Selection.

With the HF-225 receiver, it is possible to select different IF filter bandwidths to suit reception conditions. Wide filters can be used with strong signals to give good audio quality, and narrow filters can extract a signal from a crowded band. There are four IF bandwidths offered :- 2.2 kHz, 4 kHz, 7 kHz and 10 kHz, and additionally a 200 Hz wide audio filter for Morse Code reception.

Filters appropriate for normal conditions in each mode are selected when the receiver is first switched on :- 7 kHz for AM and AMS, and 2.2 kHz for USB, LSB and CW. The [**F I L T E R S E L E C T**] button allows this selection to be overridden. The filter last selected in each receiver mode is remembered, and then re-selected when the mode is changed. LSB and USB share the same filter setting, as do AM and AMS.

When you press the [**F I L T E R S E L E C T**] button the frequency display will change to show the current filter bandwidth (in kHz) and an **F** on the right-hand side indicating filter select mode. Each subsequent press of the button whilst the **F** is displayed will select a new filter in the order :-

2.2 ⇒ 4 ⇒ 7 ⇒ 10 ⇒ 2.2 etc.

The display will revert to frequency after about three seconds from the last press of the [**F I L T E R S E L E C T**] button.

In CW mode only two filters are available, 2.2 kHz and 0.2 kHz. If the 0.2 kHz filter is selected, the 2.2 kHz filter remains in the IF, and the audio peak filter is switched in.

In FM mode there is only one fixed filter bandwidth of 12 kHz. The [**F I L T E R S E L E C T**] button serves to turn the squelch facility on and off, with the display showing the messages **SQL** or **OFF** as appropriate.

Memory Operations.

The HF-225 has 30 memories which can store receiver frequency settings. Memory information is maintained by an internal battery independently of the main receiver supply. There are four memory functions - preview, recall, store and channel - controlled by buttons on the front of the receiver :-

Pressing [**M E M O R Y S E L E C T**] will show the memory mode flag in the display with a memory number (1 to 30). After about one second the display will change to the frequency stored in that particular memory. This is the memory preview function. Turning the main tuning knob will display the memory number again and select different memories to preview. The receiver's tuned frequency is not affected whilst previewing memories, and the memory mode flag in the display indicates that the main tuning knob selects memories rather than tuning the receiver.

After selecting and previewing a memory you can use the store or recall functions. Pressing [**R E C A L L**] re-tunes the receiver to the frequency in the selected memory and returns the display to received frequency. Remember that the receiver mode may need to be changed manually. If you tune the receiver now, the contents of the memory will not be affected.

Pressing the two **[STORE]** buttons simultaneously will save the current tuned frequency in the selected memory, over-writing its previous contents. A message **STO** appears briefly on the display to confirm the operation.

Pressing **[MEMORY SELECT]** will return the receiver to normal tuning mode, with the received frequency on the display.

The channel memory function is similar to the preview function, but instead of just displaying the frequency stored in a particular memory, the receiver is tuned to the memory immediately it is selected. Pressing the **[CHANNEL]** button switches between preview and channel functions.

The frequency that the receiver was tuned to before entering the channel function is not lost. To return to this frequency press **[MEMORY SELECT]**. If, however, you want to tune from the channel memory frequency, press **[RECALL]**.

If the K-225 keypad is fitted to your receiver, then the first 10 memories can be selected directly. After pressing **[MEMORY SELECT]**, keys **[1]** to **[9]** will select memories 1 to 9, and keys **[*]** and **[#]** will select memories 10 and 20 respectively. The **[0]** key changes between preview and channel modes.

Special Functions.

There are four special functions labelled in red on the front panel of the HF-225. To obtain these, the **[FN]** (memory select) button is pressed AND HELD whilst pressing one of the other buttons. The four functions are :-

- | | | |
|----|---|---|
| 1) | Set background (B) tuning store to the same frequency as the main tuning store (A). | Press [FN] and [A = B] . |
| 2) | Swap the frequencies in the background and main tuning stores. | Press [FN] and [A/B] . |
| 3) | Front panel control lock (disables tuning control and functions). | Press [FN] and [LOCK] . |
| 4) | Unlock (reverses above operation). | Press [FN] and [UNLOCK] . |

The front panel can also be unlocked by changing mode.

Use with the Whip Antenna.

The W-225 whip antenna option provides an active aerial pre-amplifier and a telescopic whip on a PL-259 plug which screws into the 50 Ω antenna socket on the rear of the HF-225. A slide switch by the side of the socket selects either the 50 Ω input (switch in the central position) or the whip aerial (switch to the left). The switch only operates in the **WHIP** position when the W-225 option is fitted.

You may find the active aerial pre-amplifier useful for improving reception from short wire aerials, but do not use it in conjunction with long wire or dipole aerials since it will probably be overloaded by the large signal levels that these aerials can produce.

FM Squelch level.

An FM squelch facility is offered on the D-225 detector option. The signal level at which the squelch gate opens and closes can be adjusted by turning the blue spindle on the rear panel labelled "FM Squelch Level". This control is normally adjusted to the point where the receiver just goes quiet with no signal present. Any signal received will then open the squelch. The squelch operation can be bypassed using the **[FILTER SELECT]** button in FM mode.

Care of your Receiver.

The HF-225 is a complex piece of electronic equipment, and it makes good sense to look after it. Install it in a well ventilated place, out of direct sunlight and as free from dust as possible. Cleaning the exterior of the receiver is very easy since the case is coated with a heavy duty epoxy paint finish, and the front panel is made from a polycarbonate material which is very scratch resistant. The panel legends are printed on the reverse side of the polycarbonate so they won't wear off in use. Obviously you should avoid spilling your coffee over the HF-225, and it won't last long if you leave it out in the rain. In other words keep the receiver dry. It is intended to work at normal domestic room temperatures, and hot or cold extremes of temperature may affect its proper function.

Please make sure that the various sockets on the HF-225 are used for the intended purpose. It is no use plugging the extension speaker into the keypad socket, or trying to connect the antenna input to the live side of the mains power. The likely result will be tears of distress and a big repair bill. The HF-225 is powered by 12 Volts DC, negative ground only. **BE CAREFUL** when applying power from any source other than the power unit provided with the receiver. Remember to disconnect the power supply from the mains when it is not in use.

If there is an electrical storm in the vicinity of your house it is sensible to switch off the receiver and disconnect any external aerial system from it, since potentially damaging voltages can be induced in a large aerial.

Finally, after unpacking your HF-225, please retain the carton and packing material. If you should ever need to transport the receiver it will survive the journey much better in the correct carton.

General notes.

If there is a momentary power failure, or if you plug in the power connector whilst the receiver is switched on, you may find that the receiver does not receive, or fails to respond to its controls. The problem is caused by the microprocessor controller having "crashed". The fault can be rectified by switching the receiver off, waiting a few seconds, and then switching it on again - all should be well, but occasionally the frequency information in the memories may be garbled.

In the same way that high volume levels from the internal loudspeaker may cause microphonic effects, external shock or vibration can cause frequency fluctuations. Of course it is not normal to bang the receiver around....

Strange effects can also occur if the receiver is placed in a strong alternating magnetic field, for example in close proximity to a large mains transformer in another piece of equipment.

When tuning the HF-225 you will notice that the output will be muted for about half a second as you tune through the local oscillator range switching frequencies at 5.000, 11.000 and 19.000 MHz. This is quite normal and should not be taken as a fault. Also one other effect that you may notice when tuning the receiver in some parts of the band is a whining noise as the tuning control is rotated. It is caused by the data transfers inside the receiver being picked-up by the input circuitry and it is normally not audible above the noise and signals coming from the aerial connected to the receiver.

As in any receiver there are a few spurious signals generated internally, mostly at or slightly above the background noise level of the receiver. Again these signals are usually masked by aerial noise and rarely cause any degradation to reception of radio signals.

Optional Units.

K-225 External Keypad.

The External keypad provides direct frequency entry and memory selection for the HF-225 receiver. It is a small, separate unit that can be positioned conveniently by the side of the receiver, and is attached by a short length of screened lead and a jack plug.

Numeric keys 0 to 9, an Enter key and a Cancel key are arranged in a 3x4 matrix similar to a telephone keypad. Frequencies can be keyed in directly in kilohertz and receiver memories 1 to 10 can be accessed with a single keypress.

D-225 Detector Unit.

The detector unit in fact combines two separate detectors in one unit, and provides narrow-band FM reception and synchronous AM detection for the HF-225.

Synchronous AM detection can offer improved audio quality compared with the normal envelope detection, especially under band conditions where selective frequency fading occurs. The FM detector will allow monitoring of FM communication channels, but it is for narrow band signals only and will not work with FM broadcast signals.

The detector unit is installed inside the HF-225, and dealer fitting is recommended.

B-225 Internal battery.

The internal battery option enables the HF-225 receiver to be used remotely from a power source. The Nickel-Cadmium batteries are charged from the receiver's normal power supply when the receiver is switched off, and they should give in excess of eight hours operation on a full charge.

W-225 Whip Antenna.

The whip antenna option includes a telescopic whip aerial and an internally fitted active aerial pre-amplifier. When combined with the internal battery then HF-225 can be used as a completely portable communications receiver.

Dealer fitting of the whip antenna option is recommended.

S-225 External Loudspeaker.

A high quality loudspeaker (in fact a small Hi-Fi speaker) to connect to the HF-225. Supplied with a lead and suitable plug.

Any, or all, of the above options may be fitted to your HF-225 receiver either when purchased or at a later date.

Circuit description.

The HF-225 is a dual conversion superheterodyne receiver, using up-conversion to a high frequency first IF of 45 MHz and a second IF of 455 kHz for the selective filters. This design gives good IF image rejection at all tuned frequencies in the HF band, coupled with good filter shape factors in the 455 kHz IF.

Signals from the aerial pass through one of six band selecting filters before the first mixer. These filters attenuate strong signals that are well separated from the frequency being received, and help to reduce interference from even order intermodulation distortion. Particular attention has been paid to separating strong medium wave signals from the rest of the HF spectrum, and to attenuating signals above 30 MHz which may be received as IF images.

There is no RF stage before the first mixer, and this, coupled with the use of a high performance transistor-tree mixer, gives the HF-225 a high dynamic range and good resistance to strong signal overload. A four-pole crystal filter with a 15 kHz bandwidth in the first IF (at 45 MHz) limits the signals fed to the second mixer and removes image responses from the second IF.

Most gain in the receiver is in the 455 kHz second IF stage, where amplifiers and filters are interspersed in a chain. The receiver uses ceramic multi-element filters in this IF, and switches in as many as possible for a selected bandwidth :-

2.2 kHz bandwidth	:	2.2, 4 and 10 kHz filters
4 kHz bandwidth	:	7, 4 and 10 kHz filters
7 kHz bandwidth	:	7 and 10 kHz filters
10 kHz bandwidth	:	10 kHz filter.

At the end of the second IF, a full-wave envelope detector serves as a low-distortion AM detector and an AGC source. When excessive levels of signal (noise spikes) are detected it fires a noise blanker monostable which in turn mutes the audio output. The IF signal also feeds a product detector which is used for detection in SSB and CW modes, when the IF is mixed with a carrier signal. Audio signal filtering is provided by a high Q peaked response filter centred on 800 Hz which is switched in for the 200 Hz CW filter. The tone control uses an R/C bridge circuit to give either LF or HF cut, with a central flat response position.

Receiver tuning is achieved by varying the frequency of both the local oscillator and the IF conversion (heterodyne) oscillator. The local oscillator covers 45.030 to 74.999 MHz in 1kHz steps, and fine tuning is provided by the heterodyne oscillator covering 44.544 to 44.545 MHz in 128 steps. The final carrier insertion frequency is determined by the mode selected so that the IF filter passband is in the correct position relative to the carrier for USB or LSB reception.

Only the local oscillator signal is produced by a phase-locked-loop frequency synthesiser, but all frequencies affecting the tuning of the receiver are crystal derived to ensure good frequency accuracy and low drift in operation.

All the switching and tuning functions in the receiver are under the control of a dedicated microprocessor system, which receives commands from the front panel controls and sends information to the receiver control register and the PLL system on serial data busses. The single-chip microprocessor is supported by a controller driving the liquid crystal display and a frequency memory chip with lithium battery supply backup. All these components are mounted separately from the main RF and IF circuits on a PCB behind the front panel. The control system is designed to use the "static idle" principle, whereby there are no signals (other than a basic clock oscillator) in the system until the operator requires a change in the receiver condition. The system then reacts to commands from the receiver's controls before returning to its static condition once again. This method of operation virtually eliminates spurious signals from the control system being picked up by the receiver's input stages.

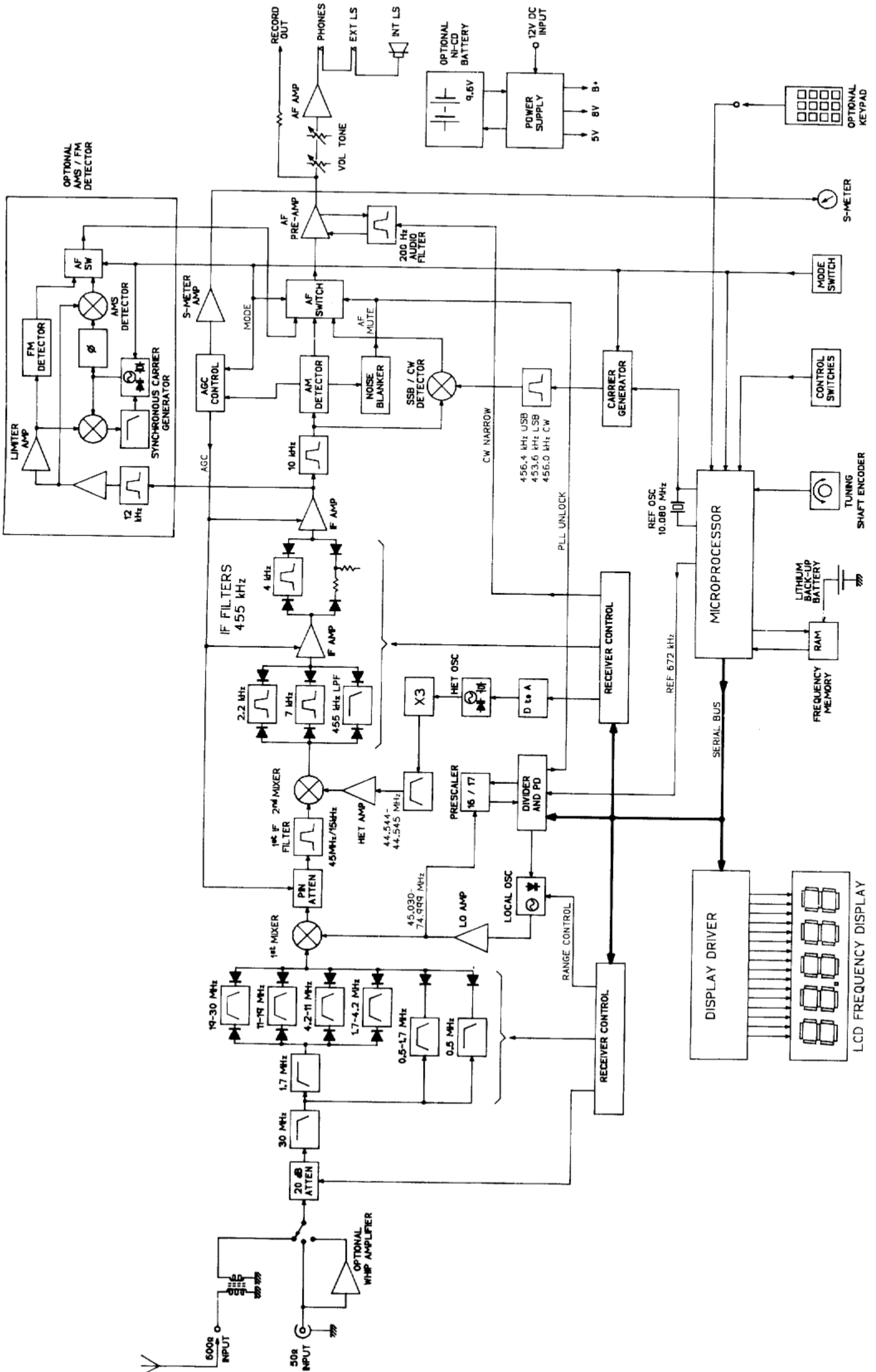

HF-225 BLOCK DIAGRAM

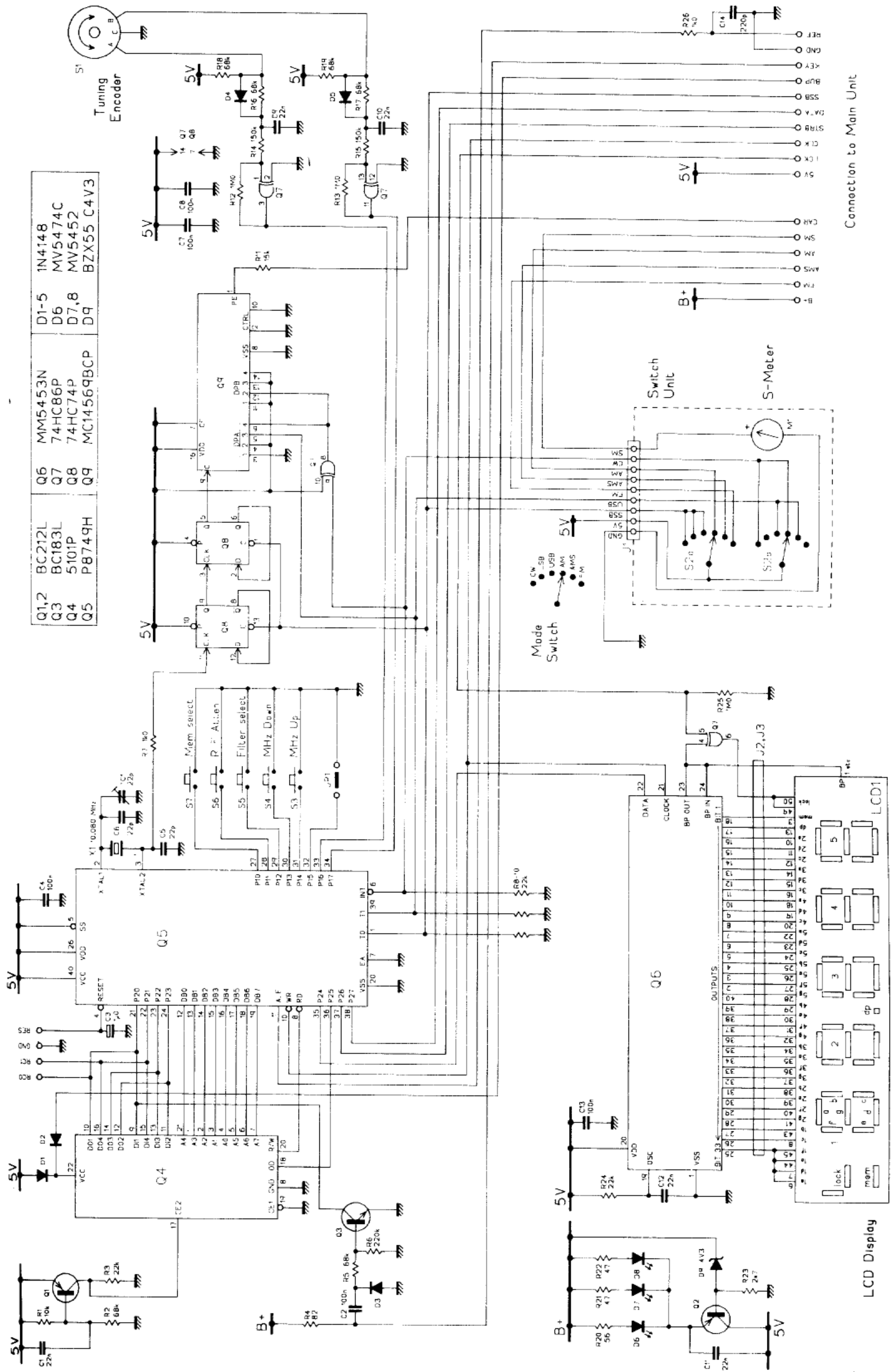

Q1,2	BC212L	Q6	MM5453N	D1-5	1N4148
Q3	BC183L	Q7	74HC86P	D6	MV5474C
Q4	5101P	Q8	74HC74P	D7,8	MV5452
Q5	P8749H	Q9	MC14569BCP	D9	BZX55 C4V3

Connection to Main Unit

HF-225 CONTROL UNIT

COMPONENT PREFIX 200.

LCD Display

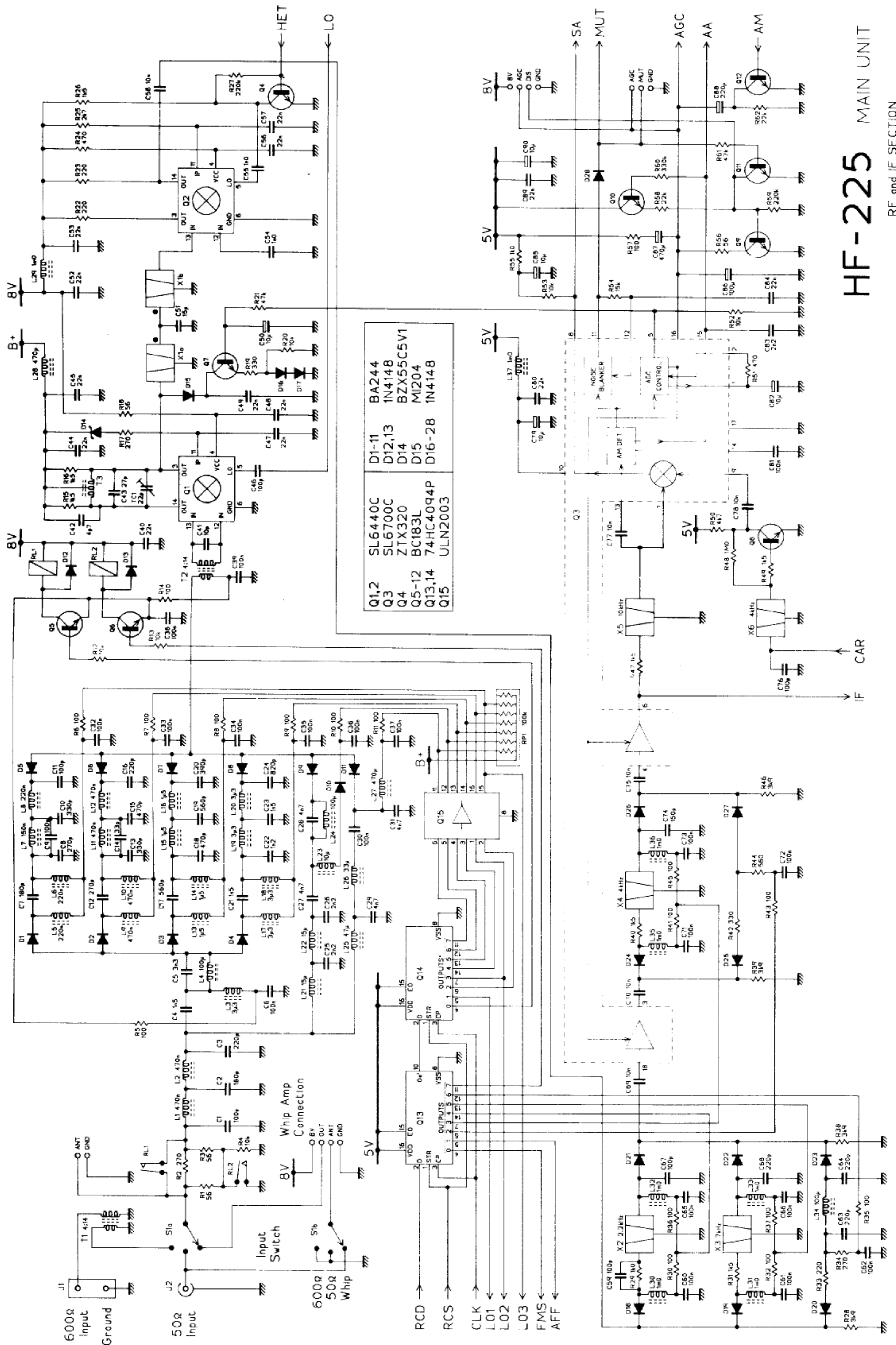

HF-225 MAIN UNIT

RF and IF SECTION

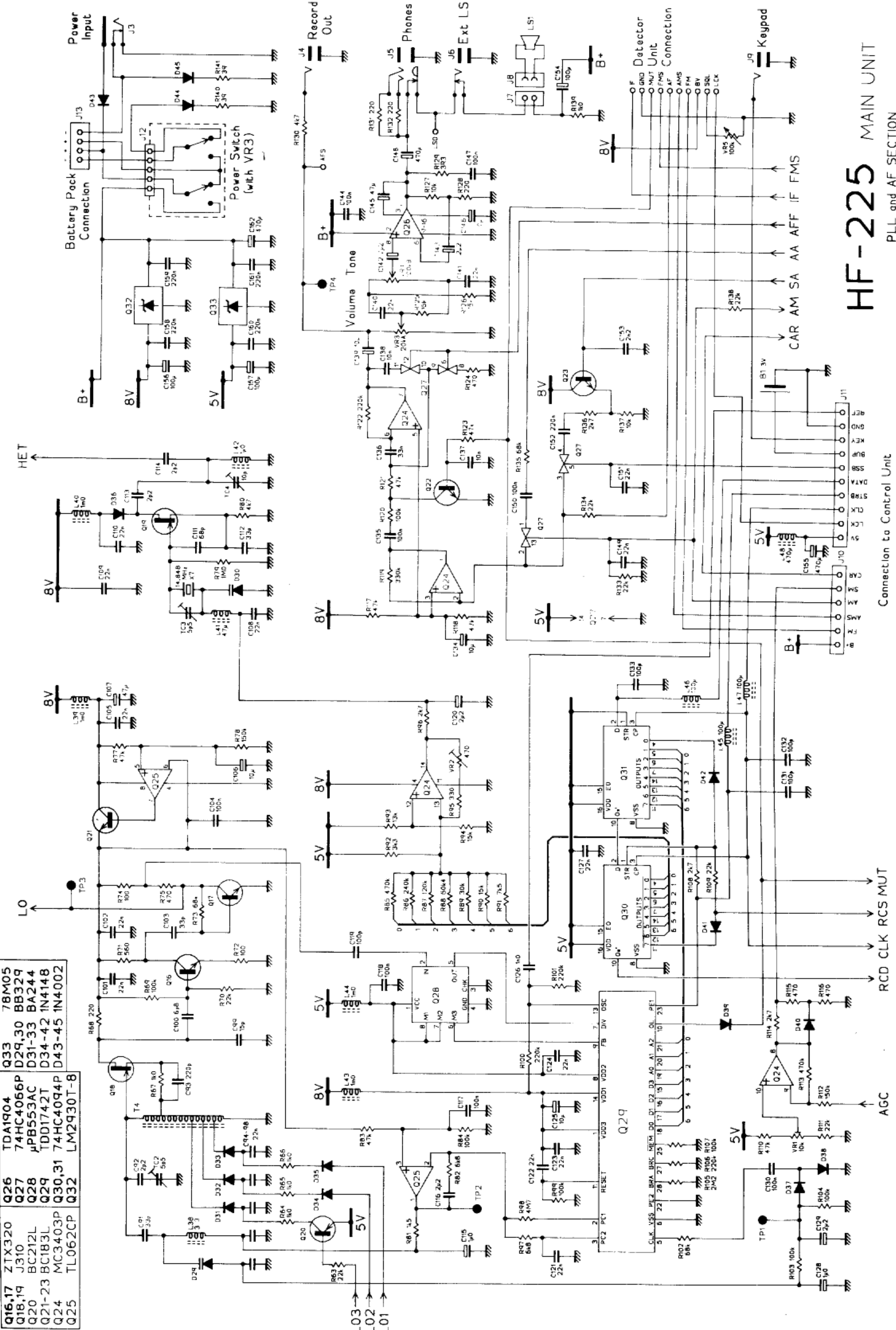

HF-225 MAIN UNIT

PLL and AF SECTION

Connection to Control Unit

AGC

RCD CLK RCS MUT

Q16,17	ZTX320	Q26	TDA1904	Q33	78M05
Q18,19	J310	Q27	74HC4066P	D29,30	BB329
Q20	BC212L	Q28	µPB553AC	D31-33	BA244
Q21-23	BC183L	Q29	TDD1742T	D34-42	1N4148
Q24	MC3403P	Q30,31	74HC4094P	D43-45	1N4002
Q25	TL062CP	Q32	LM2930T-8		

Receiver specification.

Frequency coverage	30 kHz to 30 MHz continuous coverage. 150 kHz to 26.1 MHz. ‡
Reception modes	AM, LSB, USB, CW, Narrow band FM ‡, Synchronous AM (AMS). ‡
Receiver system	Microprocessor controlled PLL tuning, dual conversion superheterodyne receiver. First intermediate frequency 44.999 MHz to 45.000 MHz. Second intermediate frequency 455 kHz. R F Input tuning in six bands :- <ol style="list-style-type: none"> 1. below 500 kHz 2. 500 kHz to 1.7 MHz 3. 1.7 MHz to 4.2 MHz 4. 4.2 MHz to 10 MHz 5. 10 MHz to 19 MHz 6. 19 MHz to 30 MHz
Displays	5-digit backlit LCD showing receiver frequency to the nearest kilohertz. Additional indicators show memory mode and AMS detector lock. Analogue signal strength meter, calibrated S1 to S9, +10dB, +30dB and +50dB.
Tuning	By Spin-wheel, MHz band buttons and Direct keypad frequency entry. ‡ Tuning rates : <ul style="list-style-type: none"> CW, SSB and AMS modes - 8 Hz steps, 1.6 kHz per revolution. AM mode - 50 Hz steps, 9 kHz per revolution. FM mode - 125 Hz steps, 25 kHz per revolution. Tuning step size increases with rapid spin-wheel rotation. Keypad frequency entry is to 1 kHz resolution.
Memories	30 frequency memories selected with tuning spin-wheel. Data held with lithium battery backup for > 5 years. Memories 1 to 10 can be selected from the keypad. ‡ Memory functions : Store, Recall, Preview and Channel. Two tunable frequency stores, A and B. Current tuned frequency is saved when the receiver is switched off.
I F filters	SSB and AM : Operator selectable 2.2, 4, 7 and 10 kHz. AMS : Operator selectable 2.2, 4, 7 and 12 kHz. CW : 2.2 kHz. FM : 12 kHz. (750 us audio de-emphasis).
Audio filters	200 Hz wide audio peak filter centered on 800Hz, selectable in CW mode.
R F attenuator	Operator selectable 20 dB attenuator.
Controls	Power on/off and Volume control. Tone control (high pass / low pass). Mode switch - CW, LSB, USB, AM, AMS, FM. Memory mode select button. RF attenuator / Memory CHANNEL button. Filter select / Memory RECALL button. MHz Down / Memory STORE button. MHz Up / Memory STORE button. Tuning / Memory select spin-wheel. Aerial select switch (on rear panel). FM squelch level (on rear panel). ‡

‡ Indicates facility available if appropriate option is fitted.

Aerial inputs	50 Ω input via SO-239 socket. 600 Ω input and Earth connection on spring terminals. High-impedance active aerial input for whip antenna via SO-239 socket. ‡
Audio outputs	Record output at approx 350 mV (3.5mm jack socket). External loudspeaker (3.5mm jack socket). Headphone output (mono or stereo headphones) (6mm jack). The internal loudspeaker is disconnected when headphones or an external loudspeaker are plugged in.
Power supply	External 12V DC supply (2.1mm power jack). 240V AC Mains power unit supplied as standard. Internal Ni-Cd rechargeable batteries with charging circuit. ‡
Dimensions	Size 253 x 109 x 204 mm (WxHxD, overall). Weight approx 1.9 kg (2.6 kg with internal batteries).

Receiver Performance.

Sensitivity	Signal levels are in micro-volts (μV) PD across the 50 Ω aerial input. AM and SSB sensitivity measured with 10 dB signal/noise ratio at the receiver output. FM sensitivity measured for 12dB SINAD. AM signal - modulated to 70% depth at 1 kHz. FM signal - deviated by 3 kHz at 1 kHz. SSB signal - unmodulated, resolved at 1 kHz.
--------------------	--

Receiver Frequency

60 kHz to 2 MHz	AM	< 1.2 μV	typically 0.8 μV
	FM	< 1.0 μV	typically 0.7 μV
	SSB	< 0.6 μV	typically 0.4 μV
2 MHz to 30 MHz	AM	< 0.9 μV	typically 0.6 μV
	FM	< 0.9 μV	typically 0.6 μV
	SSB	< 0.5 μV	typically 0.3 μV

Selectivity	I F Filter	Bandwidth (kHz)			(Shape factor 6:60 dB)
	2.2 kHz	2.3 at -6dB	3.4 at -60dB	5.5 at -80dB	SF 1:1.5
	4 kHz	5.9 at -6dB	9.8 at -60dB	10.7 at -80dB	SF 1:1.7
	7 kHz	8.8 at -6dB	12.9 at -60dB	14.6 at -80dB	SF 1:1.5
	10 kHz	10.5 at -6dB	21.5 at -60dB		SF 1:2

SSB carrier point attenuation (2.2 kHz filter) 20 dB.
CW mode filter position : (ref carrier frequency)
-6dB points at -0.8 kHz and +1.35 kHz
Resolved audio 800 Hz at carrier frequency.
200 Hz audio filter centered on 800 Hz,
Bandwidth 170 Hz at -6dB, 850 Hz at -20dB.

FM Adjacent channel selectivity :

12.5 kHz channels	40 dB (1.5 kHz deviation)
25 kHz channels	65 dB (3.0 kHz deviation)
FM Signal capture ratio	9 dB

‡ Indicates facility available if appropriate option is fitted.

Dynamic range	Reciprocal mixing effects : (2.2 kHz filter) > 80 dB at 5 kHz from wanted signal. > 90 dB at 10 kHz from wanted signal. > 105 dB at > 100 kHz from wanted signal.		
	Intermodulation effects : (2.2 kHz filter) At 10 kHz signal separation, 3rd order intercept point > +3 dBm Intermodulation-free dynamic range > 85 dB At > 50 kHz signal separation, 3rd order intercept point > +12 dBm Intermodulation-free dynamic range > 93 dB		
Spurious responses	Images :	At +90 MHz	> 75 dB rejection
		At +910 kHz	> 90 dB rejection
	Fixed responses :	At 45 MHz	> 85 dB rejection
		At 455 kHz	> 100 dB rejection
		At 22.5 MHz	> 75 dB rejection
Frequency stability	(Typical performance only - not guaranteed spec) At constant 20°C Drift < ±30 Hz in one hour, Frequency error < ±50 Hz. -15°C to +50°C Frequency error < ±200 Hz.		
AGC characteristics	Input signal level	Audio output level	
		(AM mode)	(SSB mode)
	No signal	-11 dB	-21 dB (noise only)
	0.5 μ V	-2 dB	-7 dB
	5 μ V	0 dB	-1 dB
	50 μ V	0 dB	0 dB (ref level)
	100 mV	+0.5 dB	+2 dB (AGC limit)
	AM mode :	Attack time	500 ms for 60 dB level change
		Release rate	30 dB per second
	SSB mode :	Attack time	< 10 ms for 60 dB level change
		Release rate	40 dB per second
Noise blanker	Audio blanking triggered by IF signal level. Permanently enabled, operates on all reception modes. Blanking period 500 ms. Threshold level 12 dB above normal carrier.		
Audio output	1.6 W into 8 Ω at 5% THD (With 12V power supply unit). 2.0 W into 4 Ω at 5% THD (With 12V power supply unit). External loudspeaker output is suitable for loudspeakers with impedances of 4 Ω or greater. Headphone output : up to 4 Volts from 220 Ω . Record output : 350 to 400 mV from 5 k Ω .		

Frequency response	(Tone control in central position)		
	SSB mode :	2.2 kHz filter	370 Hz to 2.5 kHz (-6dB)
	AM mode :	2.2 kHz filter	40 Hz to 1.1 kHz (-6dB)
		4 kHz filter	40 Hz to 3.1 kHz (-6dB)
		7 kHz filter	40 Hz to 4.3 kHz (-6dB)
		10 kHz filter	40 Hz to 5.2 kHz (-6dB)
	Tone control action (7 kHz filter, AM mode)		
	High pass (clockwise)	330 Hz to 4.4 kHz (-6dB)	
	Flat (central)	40 Hz to 4.3 kHz (-6dB)	
	Low pass (c/clockwise)	40 Hz to 1.4 kHz (-6dB)	
Distortion	AM mode : 1 kHz signal modulated at 70% depth.		
	With standard AM detector :	THD 1%	
	With synchronous detector :	THD 0.6%	
	SSB mode :	1kHz resolved signal THD 0.2%	
	Two-signal IM products > 35 dB below wanted signals, with signal separation > 180 Hz.		
AMS Detector	Lock range : ± 100 Hz.		
	Audio distortion under carrier-fade conditions :		
	Signal modulated to 70% depth at full carrier level.		
	6 dB carrier reduction :	2.8% THD	(23% with conventional AM detector).
	10 dB carrier reduction :	4.0% THD	(39% with conventional AM detector).
20 dB carrier reduction :	4.1% THD	(50% with conventional AM detector).	
Signal to Noise ratio	AM mode : 7 kHz filter, ref 70% modulation.		
		Input signal	S/N
		$5 \mu V$	29 dB
		$> 50 \mu V$	47 dB
	SSB mode :	$5 \mu V$	34 dB
		$> 50 \mu V$	50 dB
		Weighted S/N *	
		33 dB	
		52 dB	
		37 dB	
		54 dB	
	* Weighting to CCITT P.53A telephonic filter.		
Power supply	DC supply 10 to 15 V (12 V nominal).		
	Quiescent current 200 mA (no options, no audio output).		
	Typical power consumption 250 to 300 mA.		

Specification subject to change without notice.

Index.

Accessories	18	K-225	14, 18
Aerial Connection	12	Keypad	14, 16, 18
Aerials:		Lock	16
Active	5	Loudspeaker	6
Dipole	4	Mains Supply	6
Inverted L	3	Memories	15 - 16
Inverted V	4	Memory Functions:	
Long Wire	3	Channel	16
Loop	5	Preview	15
Vertical	5	Recall	16
Whip	12, 16	Store	16
AM	7	Modes	7, 10
AMS	9, 14, 18	Options	18
Attenuator	14	Overloading	5, 14
B-225	13, 18	Packing	17
Batteries	13, 18	Power Connection	6, 12, 17
Circuit	19 - 23	Power Supply	6, 17
Cleaning	17	Precautions	6, 17
Connections	12	Recall 16	
Controls:		Reception Modes	7, 10
Antenna	12	Record Output	6
Filter	15	RF Attenuator	14
Front Panel	10	RTTY	8
Memory	15 - 16	S-225	6, 18
Rear Panel	12	Selectivity	7, 15
Tone	13	Signal Strength Meter	10
Tuning	13	Signal Types	7
Volume	13	Special Functions	16
CW	8, 13, 15	Specification	24 - 27
D-225	18	Split VFOs	16
Earth Connection	3, 6, 12	Spurious Signals	17
ECSS	9	Squelch	16
External Loudspeaker	6	SSB	7
Facsimile	8	Store	16
Fading	9	Synchronous AM	9, 14, 18
Faults	17	Tape Recording	6
Filter Selection	15	Tuning	13 - 14
Filters	7, 19	Tuning Stores A & B	16
FM	8, 18	Unlock	16
FM Squelch	16	W-225	12, 16, 18
Ground Connection	3, 6, 12		

HF Band Plan.

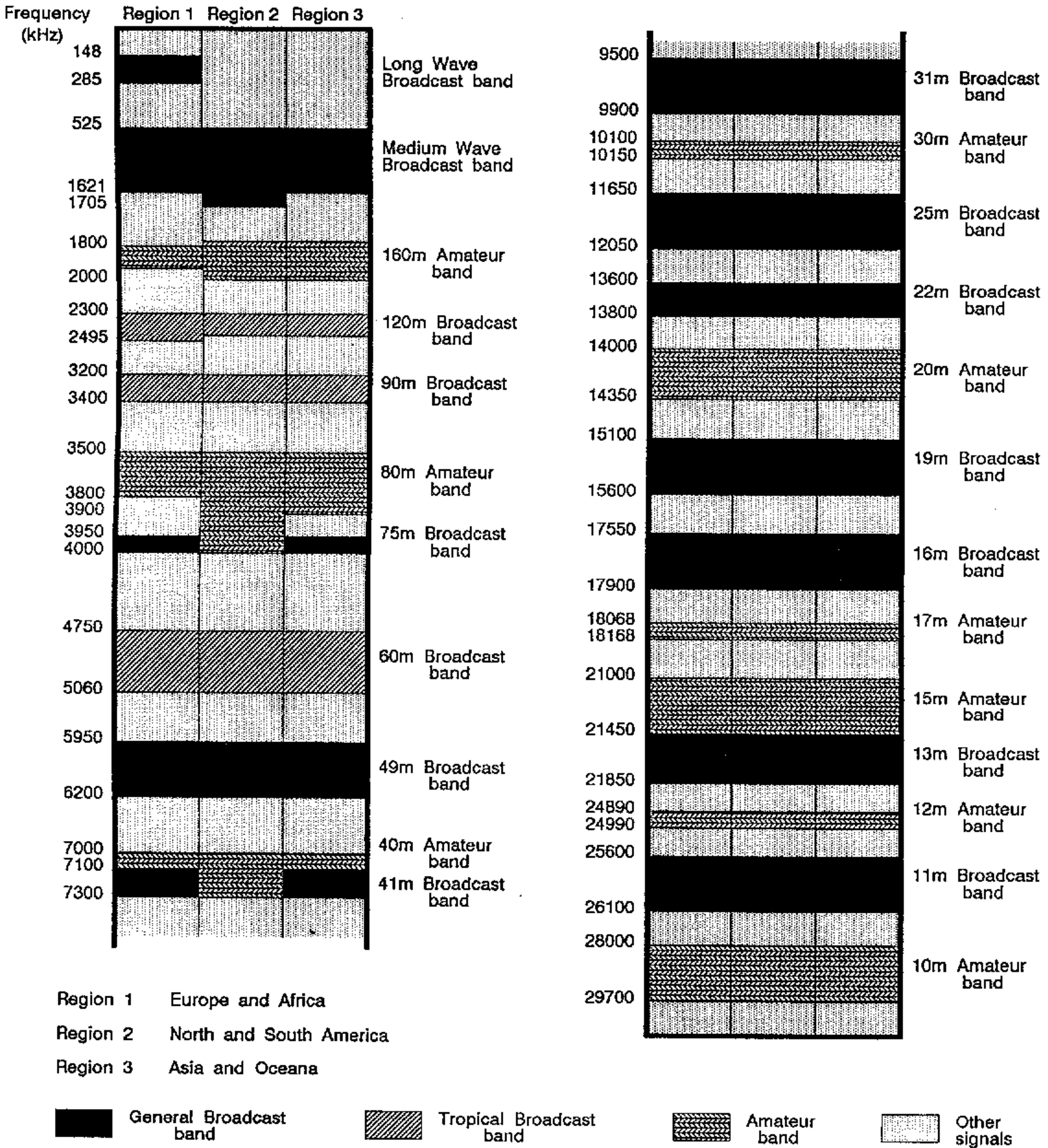

LOWE ELECTRONICS LIMITED

Chesterfield Road, Matlock, Derbyshire, DE4 5LE ENGLAND

Telephone: 0629 580800 Telex 377482 LOWLEC G

SUPPLEMENT TO "KEYPAD FREQUENCY ENTRY

(Page 18/19 in Manual)

The old faithful Lowe KEYPAD 1 is now being replaced with a re-designed internal configuration which employs a small micro-controller to decode the keys and output the data, while still keeping the very popular telephone type key layout. It has been possible to include some extra functions for the HF150/HF150E users while still keeping full compatibility with previous Lowe receivers i.e. HF125/HF225.

Frequency entry is unchanged, with frequencies 3000KHz and above entering automatically as the last digit is entered on the keypad and 2999 and below with the ENTER '#' key.

HF150 users may also access the 8 different modes in any order by holding down the '*' key and then using numbers 1-8 as indicated by the KEYPAD 2 overlay.

KEYPAD 2 OVERLAY

