

Operating Instructions

MODEL NO. **RF-4800**



Panasonic[®]

Read these instructions completely before operating this set.

Your new Panasonic radio receiver RF-4800 was manufactured and assembled under exacting quality control standards.

The incorporation of the latest advances in radio design and the use of the most modern components ensure outstanding performance with superb sensitivity and tone quality.

Just a few minutes of your time spent reading carefully through these instructions will assure your obtaining optimum performance that will bring you continued enjoyment for many years.

CONTENTS

LOCATION OF CONTROLS	3
POWER SUPPLY	3
ANTENNAS.....	4
CONTROLS AND FUNCTIONS	5
RECEIVER OPERATION	7
ABOUT SSB AND CW	8
ELECTROMAGNETIC-WAVE PROPAGATION	9
PRECAUTIONS	9
HELPFUL HINTS	9
SPECIFICATIONS	10

The serial number of this product may be found on the back of the unit. You should note the serial number of this unit in the space provided and retain this book as a permanent record of your purchase to aid in identification in the event of theft.

MODEL NUMBER: RF-4800 ,

SERIAL NUMBER: _____

**WARNING : TO PREVENT FIRE OR SHOCK HAZARD,
DO NOT EXPOSE THIS PRODUCT TO RAIN OR MOISTURE.**

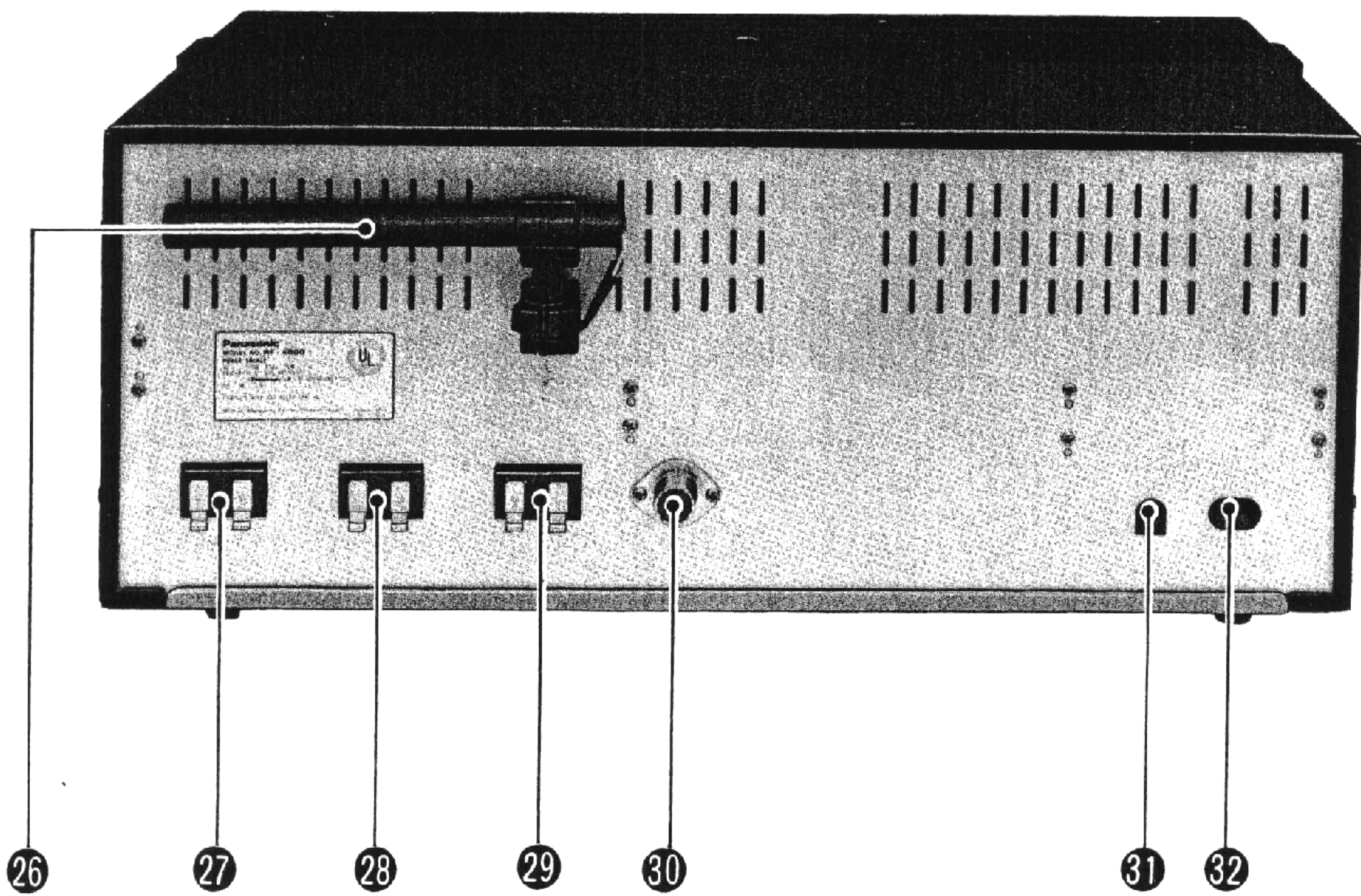
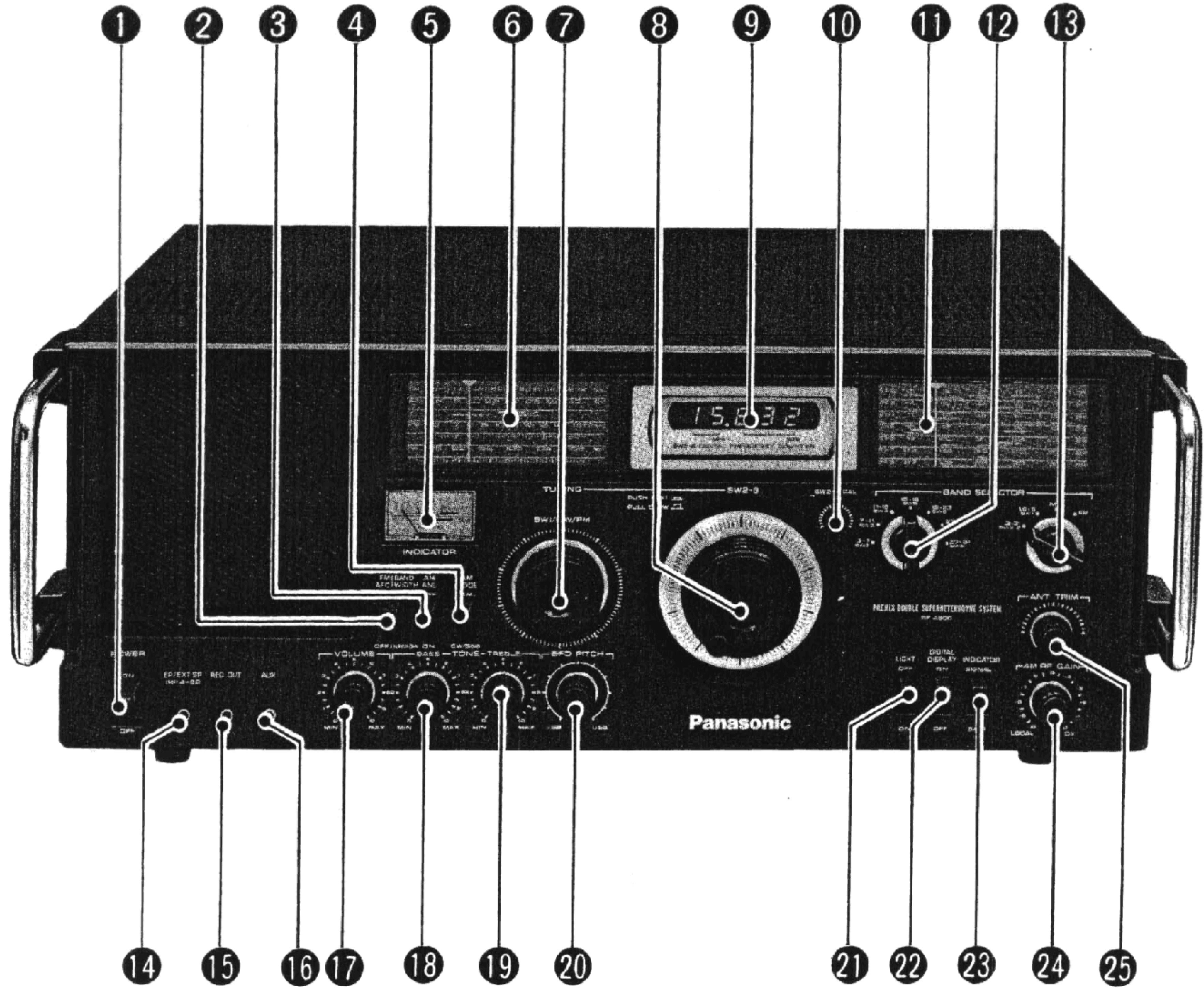

- ① Power Switch
- ② FM AFC/Band Width Switch
- ③ AM ANL (Automatic Noise Limiter) Switch
- ④ AM Mode Switch
- ⑤ Tuning/Battery Indicator
- ⑥ SW1/MW/FM Tuning Scale
- ⑦ SW1/MW/FM Tuning Control
- ⑧ SW2-8 Tuning Control
- ⑨ Digital Frequency Display
- ⑩ SW2-8 Calibrator
- ⑪ SW2-8 Tuning Scale
- ⑫ SW2-8 Band Selector
- ⑬ Main Band Selector
- ⑭ Earphone/External Speaker Jack
- ⑮ Recording Output Jack
- ⑯ Auxiliary Input Jack

- ⑰ Volume Control
- ⑱ Bass Control
- ⑲ Treble Control
- ⑳ BFO Pitch Control
- ㉑ Light Switch
- ㉒ Display Switch
- ㉓ Indicator Switch
- ㉔ AM RF Gain Control
- ㉕ Antenna Trimmer
- ㉖ MW Ferrite-Core Antenna
- ㉗ FM Antenna Terminals
- ㉘ MW/SW1 Antenna Terminals
- ㉙ SW2-8 Antenna Terminals
- ㉚ Coaxial-Cable Antenna Jack
- ㉛ DC Input Jack
- ㉜ AC Input Jack

POWER SUPPLY

Battery Operation:

- Open the battery compartment covers by pushing each latch as shown in Fig. 1.
- Insert 8 "D" size (Panasonic UM-1 or equivalent) batteries, observing the correct polarity, as shown in Fig. 2. Place the cloth bands under the batteries to facilitate easy removal.
- Replace the compartment covers.

Note: Make sure the DC Input ⑬ and AC Input ⑭ jacks are disconnected.

To check the battery condition:

Set the Indicator Switch ㉓ to "BATT" position with the power on. The Tuning/Battery Indicator ⑤ then shows the battery condition.

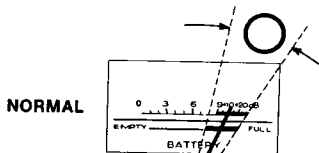

Fig. 3

When the indicator reads in the "O" range as shown above the batteries are good.

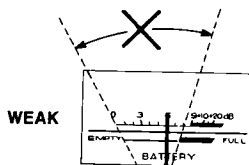

Fig. 4

When the indicator reads in the "X" range as shown above replace all the batteries with new ones.

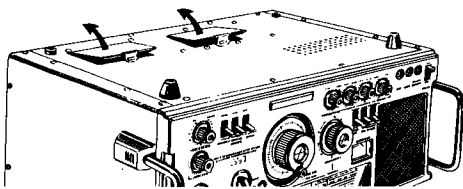

Fig. 1

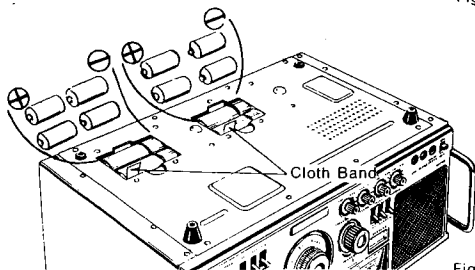

Fig. 2

AC Power Operation:

■ Connect the included AC power cord to the AC Input Jack ② and to your household AC electrical outlet.

On plugging the power cord into the AC Input Jack ②, operation changes from battery or external DC power to AC.

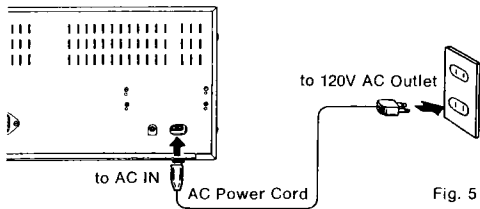

Fig. 5

Car/Boat Battery Operation:

■ Insert the plug of a car battery adaptor cord into the DC Input Jack ①.

■ Plug the other end into the cigarette lighter socket in your car or boat.

■ This automatically disconnects the internal batteries and the receiver operates on external DC power only.

Note: For the connection of an adaptor cord, follow the instructions provided with it.

ANTENNAS

FM:

Connect the accessory compact FM antenna to the FM Antenna Terminals ③, then extend and fix the antenna on the wall near a window by using three push-pins or adhesive tape as in Fig. 6. If the FM station is still weak, connect a suitable outdoor FM antenna (impedance: 75 ohms) to replace the compact antenna. (For installation, follow the instructions provided with the antenna.)

MW:

The rear ferrite core antenna will assure excellent MW reception in most areas. If the stations are distant or if the signals are very weak, connect a suitable length of the accessory antenna wire to the MW/SW1 Antenna Terminals ④, and extend. (See Fig. 7.)

SW:

External antenna and ground connections are required. Figs. 10-13 give examples of outdoor SW antenna installation. For SW1 reception, connect the antenna and ground wires to the MW/SW1 Antenna Terminals ④; for SW2-8 reception, connect them to the SW2-8 Antenna Terminals ⑤. The Coaxial Cable Antenna Jack ⑥ for SW2-8 reception may be used to connect an SW antenna with a coaxial cable. With this kind of antenna, solder the accessory metal plug to the end of the cable as in Fig. 9. Erecting the antenna as high and as far away from noise-generating equipment and high tension cables as possible improves the reception.

To avoid danger from lightning, it is strongly advisable to attach a safety device between the outdoor antenna and the receiver. Fix a knife switch (completed connections as indicated in Fig. 14) as near to the receiver entrance of the antenna lead as possible. During electrical storms, short-circuit the antenna to ground by reversing the switch to the ground side.

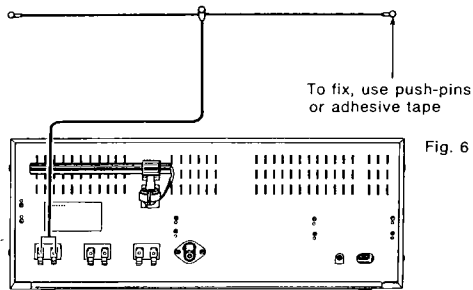

Fig. 6

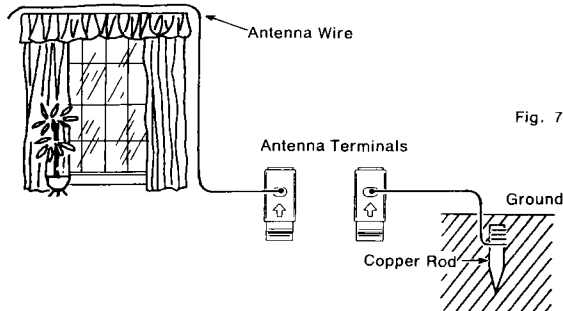

Fig. 7

How to Connect Antenna Wires to the Terminals

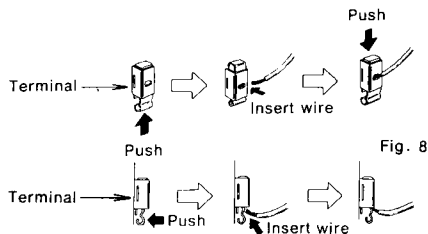

Fig. 8

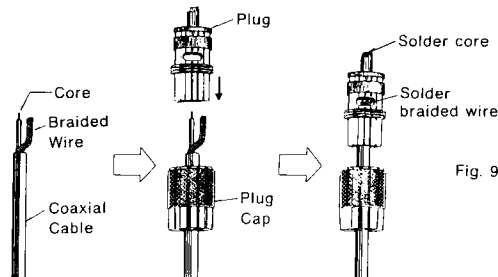
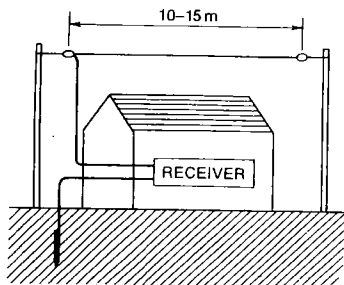
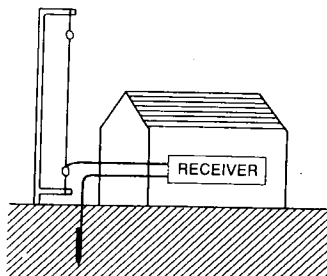

Fig. 9



Horizontal Antenna Fig. 10



Vertical Antenna Fig. 11

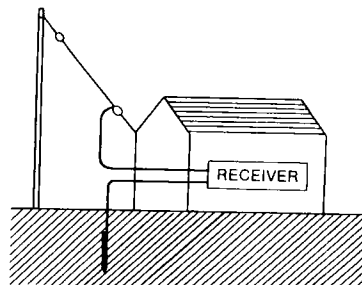

Slant Antenna Fig. 12

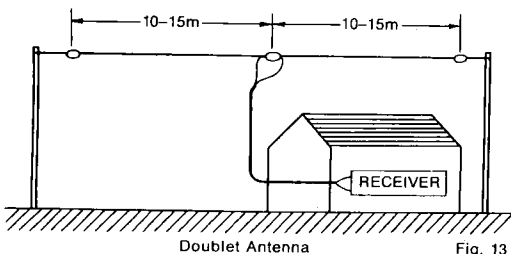

Doublet Antenna Fig. 13

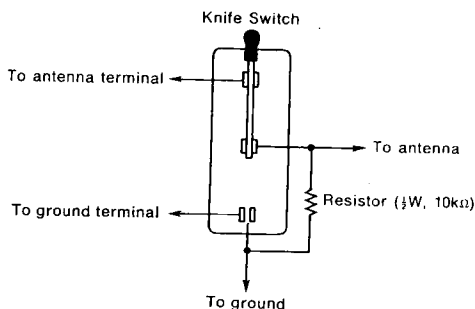

During electrical storms, make sure to reverse the switch to the ground side to connect the antenna directly to the ground.

Fig. 14

CONTROLS AND FUNCTIONS

1 Power Switch

Turn the power on and off.

2 FM AFC/Band Width Switch

Has a combined function as an AFC (Automatic Frequency Control) switch on FM, and a band-width switch on AM (MW and SW).

Normally leave it in the ON/WIDE (up) position.

- On FM, if you find it difficult to tune in a particular station because of a strong adjacent station, then switch it to OFF/NARROW (down).

- On MW and SW, if your received station is interfered by another adjacent station, then move the switch to OFF/NARROW (down).

3 AM ANL (Automatic Noise Limiter) Switch

Set this switch to ON to cut out impulsive noise such as lightning, or other sparks. Normally it should be positioned at OFF.

4 AM Mode Switch

For CW (Continuous Waves) or SSB (Single Sideband) reception, turn to the CW/SSB position. When listening to any other broadcast, the switch should be set in AM. This switch has no effect on FM.

5 Tuning/Battery Indicator

Acts as tuning and battery-checking meters.

Setting the Indicator Switch **2** to SIGNAL makes the indicator show the relative strength of signals tuned in (the stronger the signal, the greater the deflection to the right) and assist in obtaining the best reception. Setting the switch to BATT makes the indicator show the battery condition.

6 SW1/MW/FM Tuning Scale

SW1: 1.6-3 MHz
MW: 525-1605 kHz
FM: 88-108 MHz

7 SW1/MW/FM Tuning Control

Use for the SW1, MW, and FM reception.

8 SW2-8 Tuning Control

Use for the SW2-8 reception.

This control features two-speed tuning. To obtain precise tuning (particularly on SW), pull out the control to reduce the tuning speed. To restore the normal speed, push the control in.

9 Digital Frequency Display

Indicates the tuned frequency for the SW2-8 bands only, showing the main digit(s) and three decimal points in MHz.

Note: No display appears when the Main Band Selector 13 is set in any position other than "SW2-8" and/or when the Display Switch 22 is turned off.

10 SW2-8 Calibrator

Use only for SW2-8 reception.

If the digital frequency display does not agree with the frequency of a known station, correct the error by turning the calibrator with your finger tip until the best reception is obtained. (See page 7.)

11 SW2-8 Tuning Scale

SW2: 3-7 MHz
SW3: 7-11 MHz
SW4: 11-15 MHz
SW5: 15-19 MHz
SW6: 19-23 MHz
SW7: 23-27 MHz
SW8: 27-31 MHz

12 SW2-8 Band Selector

Choose the desired band, SW2-SW8. This selector has no effect unless the Main Band Selector 13 is set at "SW2-8".

13 Main Band Selector

Set to the desired band.

14 Earphone/External Speaker Jack

Connects the included earphone or optional extra external speaker (impedance: 4-8 ohms). When the plug is inserted, the built-in speaker is automatically disconnected.

Note: For connecting a headphone, use the supplied headphone adapter.

15 Recording Output Jack

Connects a tape deck for recording from the receiver.

Plug the cable to the tape deck into this jack. Radio programs can be recorded while listening at the desired volume level as the sound level at this jack is fixed. The recording level should be adjusted by using the control(s) on the tape deck.

16 Auxiliary Input Jack

Connecting another audio source (such as a tape deck, record player, etc.) to this jack makes the receiver work as an audio amplifier. Plug the cable from the output of your audio source into this jack. The sound from the receiver shuts off automatically.

Note: For record player operation, this jack allows only the type with a ceramic or crystal cartridge to be operated.

17 Volume Control

18 Bass Control

Regulates the low tone.

19 Treble Control

Regulates the high tone.

20 BFO Pitch Control

Used to obtain clear SSB and CW sounds.

Properly tune to SSB or CW signals, then carefully rotate this control until the signals are most suitable. (See page 8.)

21 Light Switch

When tuning in the dark, push to ON. The Tuning/Battery Indicator 9 and a tuning scale being used will be illuminated. Turn off when the illumination is unnecessary.

22 Display Switch

This turns the Digital Frequency Display 9 on and off.

For saving the battery power, this switch should be turned off except for tuning.

23 Indicator Switch

Setting this switch to "SIGNAL" makes the Tuning/Battery Indicator 9 show the tuning condition or relative strength of received signals. Switching to "BATT" indicates the battery condition on the indicator 9.

24 AM RF Gain Control

Adjusts the receiver sensitivity for MW, or SW (including SSB and CW) reception. Normally keep it in the full-clockwise (DX) position. If the station is sufficiently strong to cause overloading or distortion in the receiver, slowly rotate this control counterclockwise until clear sound is obtained. This control has no effect on FM.

25 Antenna Trimmer

Eliminates the difference between the external antenna and the receiver impedances so that incoming signals can without loss come through the antenna to the receiver.

Carefully rotate it for best reception. This trimmer is used for SW2-8 reception only.

26 MW Ferrite-Core Antenna

Effective on MW only.

For best reception, push the antenna holder down to the horizontal position (Fig. 15), and then position it in the direction which provides the best results (Fig. 16).

Note: Do not swing this antenna unless its holder is horizontal, nor swing further over a quarter rotation.

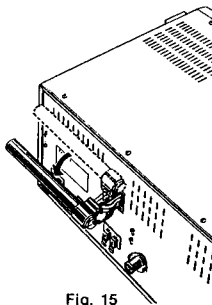

Fig. 15

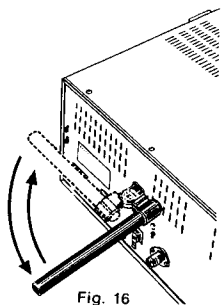

Fig. 16

27 FM Antenna Terminals

Connecting an external FM antenna to these terminals assures excellent FM reception.

28 MW/SW1 Antenna Terminals

An external antenna connected to these terminals will improve the quality of the MW and SW1 reception.

For SW1 reception, be sure to connect an appropriate external antenna (and ground system) to these terminals. On MW reception, the equipped ferrite core antenna will be enough. If the MW signals are very weak and the ferrite core antenna does not provide good enough reception, connect an external MW antenna (and a ground system) to these terminals.

29 SW2-8 Antenna Terminals

For SW2-8 reception, connect an external SW antenna (and a ground system) to these terminals. Unless this connection is performed, there will be no reception.

30 Coaxial-Cable Antenna Jack

Provided only for SW2-8 reception.

Connect the coaxial cable from an external SW antenna to the accessory plug, then insert the plug into this jack.

31 DC Input Jack

Connects to any external 12-volt, DC source. When the connection is made, the internal batteries are automatically disconnected.

Note: For the use of any external DC source, be sure to unplug the AC power cord from the receiver. (See page 4.)

32 AC Input Jack

To operate on AC, connect the accessory AC power cord between this jack and your household AC electrical outlet. When the plug is inserted in this jack, both the internal batteries and external DC source are automatically disconnected.

RECEIVER OPERATION

Your new Panasonic radio receiver RF-4800 should be operated as any standard radio. However, to obtain the best performance and take advantage of some of the high performance features of the set, we suggest you read the following operating hints.

MW/SW1 Reception:

Control	Position
Main Band Selector ①	MW, or SW1
AM Mode Switch ④	AM
Band Width Switch ②	WIDE (up)
AM RF Gain Control ③	DX
Indicator Switch ⑤	SIGNAL
Tuning Control ⑦	Desired Station
Volume Control ⑧	Desired Level

To reduce interferences:

- Set the Band Width Switch ② to NARROW (down), and retune.
- Turn the AM RF Gain Control ③ counterclockwise until the interfering station disappears.
- Reposition the back-equipped ferrite-core antenna so that the interference is minimal.

FM Reception

Control	Position
Main Band Selector ①	FM
Indicator Switch ⑤	SIGNAL
FM AFC Switch ②	ON (up)
Tuning Control ⑦	Desired Station
Volume Control ⑧	Desired Level

Note: If the desired station is closely adjacent to a stronger station, the AFC may tune the receiver to the strong station. At such times, tune in the desired station with the FM AFC Switch ② in the OFF (down) position.

SW2-8 Reception:

Control	Position
Main Band Selector ①	SW2-8
SW2-8 Band Selector ⑦	Desired Position
SW2-8 Calibrator ⑩	Center
AM Mode Switch ④	AM
AM RF Gain Control ③	DX
Band Width Switch ②	WIDE (up)
Display Switch ⑥	ON (only during tuning)
SW2-8 Tuning Control ⑧	Desired Station
Antenna Trimmer ⑨	Proper Position
Volume Control ⑧	Desired Level

To correct any frequency-display error:

1. Tune to any already-known frequency on SW2-8, and make sure the correct frequency is displayed.
2. Watch the Tuning Indicator ⑤ while slowly turning the SW2-8 Calibrator ⑩ with the Indicator Switch ⑤ at SIGNAL. When the meter pointer deflects to the extreme right, the best-tuned frequency strictly accords with the display.

Note: * At the "WWV" positions on the SW2-8 Tuning Scale ⑧, the 5,000, 10,000, and 15,000 MHz standard-frequency signals would be received, and those signals may helpfully be used for the error correction.

* If the Tuning Indicator ⑤ is difficult to read because of too strong signals, turn the AM RF Gain Control ③ counterclockwise to decrease the receiver sensitivity.

* Changing to another band may require readjusting of the SW2-8 Calibrator ⑩.

To reduce interferences:

- Set the Band Width Switch ② to NARROW (down), and retune.
- Rotate the AM RF Gain Control ③ counterclockwise until the interfering station disappears.

To decrease background noise:

- Adjust the Antenna Trimmer ⑨.
- Turn the Treble Control ⑥ counterclockwise.
- Make sure the antenna and ground are properly connected.
- Try the AM ANL Switch ③.

NOTE:

- * SW (including SSB and CW) reception is greatly affected by a connected antenna. Therefore, to obtain the best possible reception, proper antennas are required.
- * Some 30-minute passage after power application will provide essentially stable receiver-operation.
- * Turning the Display Switch ② on and off may slightly drift the displayed frequency.

SSB and CW Reception:

Set up the receiver in the same manner as SW2-8 reception, and then follow the procedure below.

- Set the AM Mode Switch ① to CW/SSB.
- Tune to the desired signal.
- Rotate the BFO Pitch Control ③ until the received signal becomes clear.

Note: * If received signals are too strong to clearly be heard, rotate the AM RF Gain Control ④ counterclockwise until distinct, pleasant sound is obtained.

- * In receiving two-way communication signals, a possible difference between the two frequencies may demand another BFO Pitch Control ③ adjustment.

ABOUT SSB AND CW

Single-Sideband (SSB):

In general, SSB corresponds to a modulated wave in the AM Double-Sideband (DSB) signal. It is used for professional purposes, amateur wireless, and it can be regarded as a special type of AM wave.

Features:

1. In case of transmitting: All informations are transmitted with a little energy and band width.
2. In case of receiving: Since there is no carrier, it is necessary to use a special detection method.

AM (DSB) waves can be illustrated in a spectrum as in Fig. 17. Electromagnetic wave (carrier) with two sidebands is transmitted as a single group in an AM form. High frequency waves are contained in the Upper-Sideband (USB) while the lower frequency waves are in the Lower-Sideband (LSB). Voice and other information are contained in the side bands but are not included in the carrier; thus the carrier is not always necessary, and other methods for transmitting the informations are considered.

One of these methods is SSB. Either the USB signal or the LSB signal is transmitted and it depends upon individual customs. Usually for amateur communication, LSB is used under 10 MHz. SSB waves are generated by passing the AM wave through a band-pass filter, then selecting either USB or LSB and sending the signal through the transmitting antenna. In receiving SSB (USB or LSB) waves on an ordinary AM receiver, it would not be possible to hear a transmitted voice unless a special alteration was made at the detection stage; either to construct the carrier

and detect the AM after adding the SSB or to use the switching method (product detection) on the frequency of the carrier for the SSB. The latter method has less distortion, and it is used in this receiver.

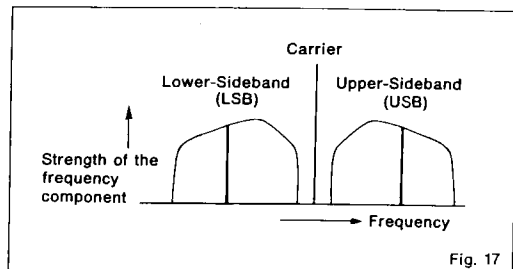
**Continuous Waves (CW):**

In practice, it is used to transmit Morse code signals by intermitting the carrier, but it is difficult to hear the sound even after AM detection. Using the detection circuit of the SSB, the intermitted sound can be heard by product-detecting the carrier and by varying the frequency slightly.

Electromagnetic waves of a SW broadcast are separated into surface waves which are propagated along the surface of the earth and space waves which are propagated upwards. Low frequency waves (LW and MW) are surface waves, while high frequency waves (SW) are bounced off the ionosphere which is located 100—300km above the earth surface. This layer is charged and acts like a mirror toward electromagnetic waves. That is why high frequency waves can be received over great distances. On the other hand, the electromagnetic waves of higher frequencies (VHF) protrude through the ionosphere and can only be used for short distances.

The ionosphere is thought to have been made by the ultra-violet rays of the sun, and consequently, the conditions of the ionosphere change from time to time due to the position of the sun. Seasonal variations also occur. Since it is multilayered, the path of propagation of electric waves is extremely complex. In particular, solar spots whose number changes every 11 years changes affects the shape of the propagation. In receiving SW broadcast,

one must keep all of the foregoing in mind. The best known SW stations take all of the factors into consideration and change the frequency from season to season or broadcast with two or more different frequencies at the same time, so that the most suitable reception can be achieved.

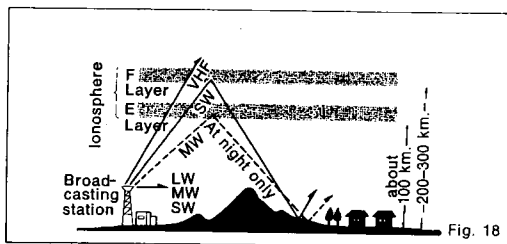

PRECAUTIONS

For your safety and to prevent damage to the set:

- Do not connect the set to any AC outlet other than the type supplying 120 volts.
- Avoid cuts, scratches, or poor connections in the AC power cord which may result in possible fire or electric shock hazard. Also, excessive bending, pulling, or slicing of the cord should be avoided.
- Do not unplug the AC power cord by pulling on the cord. To do so may cause permature failure or shock hazard.
- Do not operate the set on AC power in a bathroom as a potential shock hazard may result.

HELPFUL HINTS

- If the set is not used for a long time or is used only from an AC power source, remove all the batteries to prevent potential damage due to possible battery leakage.
- When the sound volume begins to lower, it is advisable to replace all the batteries with new ones before they are completely discharged.
- Do not subject the set to a temperature of over 60°C (140°F), because characteristics of the internal parts may be adversely affected by heat. Especially, never leave the set in a car exposed to direct sunlight for a long time with all the doors and windows closed. The cabinet may become deformed, and deterioration of the performance may result.
- Do not use benzine, thinner, or the like, or any abrasive powder to clean the cabinet. Wipe it with soft cloth moistened with a mild soap and water solution.

SPECIFICATIONS

Power Source:	AC 120V, 60 Hz DC 12V; eight 1.5V batteries (Panasonic UM-1 or equivalent), or any external 12V DC source (such as a car or boat battery through a car-battery adaptor)	SW2	S/N 10 dB 1.3 μ V S/N 26 dB 8.0 μ V
Power Consumption:	10W	SW3	S/N 10 dB 0.8 μ V S/N 26 dB 5.0 μ V
Receivable-Signal Types:	FM, AM, CW, and SSB	SW4	S/N 10 dB 1.2 μ V S/N 26 dB 7.0 μ V
Frequency Range:	FM 88-108 MHz MW 525-1605 kHz (571-187m) SW1 1.6-3.0 MHz (187-100m) SW2 3.0-7.0 MHz (100-42.9m) SW3 7.0-11.0 MHz (42.9-27.3m) SW4 11.0-15.0 MHz (27.3-20.0m) SW5 15.0-19.0 MHz (20.0-15.8m) SW6 19.0-23.0 MHz (15.8-14.7m) SW7 23.0-27.0 MHz (14.7-11.1m) SW8 27.0-31.0 MHz (11.1-9.7m)	SW5	S/N 10 dB 1.2 μ V S/N 26 dB 7.0 μ V
Reception Method:	FM Superheterodyne MW/SW1 Superheterodyne SW2-8 Double-Superheterodyne (variable oscillated-frequency up-converting, premixing system)	SW6	S/N 10 dB 1.2 μ V S/N 26 dB 7.0 μ V
Intermediate Frequency:	FM 10.7 MHz MW/SW1 455 kHz SW2-8 1st IF 2 MHz 2nd IF 455 kHz	SW7	S/N 10 dB 1.3 μ V S/N 26 dB 8.0 μ V
Frequency Display:	SW2-8 (3.0-31.0 MHz) 7-segment, red LED 5 digits Easy reading to three decimals in MHz (below 1 kHz to the closest round number)	SW8	S/N 10 dB 1.3 μ V S/N 26 dB 8.0 μ V
Antenna:	FM External antenna (75 Ω) MW Built-in ferrite-core antenna and external antenna (75 Ω) SW1 External antenna (75 Ω) SW2-8 External antenna (75 Ω), or M-type coaxial- cable antenna (75 Ω)	Image Ratio:	FM 30 dB (98 MHz) MW 40 dB (1000 kHz) SW1 30 dB (2.3 MHz) SW2 65 dB (5 MHz) SW3 60 dB (9 MHz) SW4 55 dB (13 MHz) SW5 50 dB (17 MHz) SW6 45 dB (21 MHz) SW7 35 dB (25 MHz) SW8 35 dB (29 MHz) (SW2-8 is 1st IF image ratio.)
Sensitivity:	FM 3 dB down limiter 1.6 μ V S/N 26 dB 3 μ V MW S/N 10 dB 60 μ V/m S/N 26 dB 400 μ V/m SW1 S/N 10 dB 1.0 μ V S/N 26 dB 6.0 μ V	Selectivity:	FM \pm 200 kHz (35 dB), \pm 400 kHz (70 dB) AM WIDE \pm 2.5 kHz (-6 dB), \pm 15 kHz (-60 dB) NARROW \pm 1.7 kHz (-6 dB), \pm 6 kHz (-60 dB)
		Frequency Stability:	Thirty minutes after power-on, fluctuation is less than 500 Hz.
		Input Jacks:	AUX mini-type...20mV, 300k Ω
		Output Jacks:	REC OUT mini-type...400mV, 4k Ω EP/EXT. SP 4-8 Ω
		SW2-8 Tuning Control:	Fast/Slow Ratio...12:1 Retardation Ratio...1:9.5 (Fast) 1:114 (Slow)
		Semiconductors:	5 IC's, 3 FET's, 34 Transistors
		Power Output:	RMS 2.0W
		Speaker:	10 cm, 4 Ω
		Dimensions:	482(W) x 200(H) x 354(D)mm
		Weight:	8 kg (without batteries)

Specifications subject to change without notice.

Block Diagram

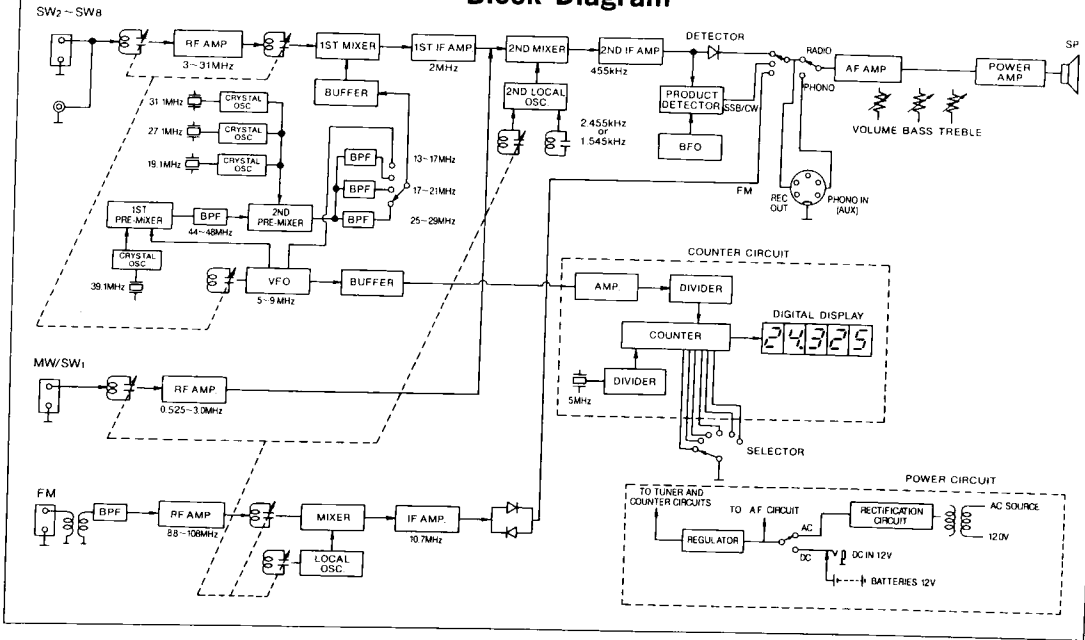

PRODUCT SERVICE

Should your Panasonic product ever require service, refer to an Authorized Panasonic Servicer listed in the enclosed Directory, or consult your authorized Panasonic dealer for detailed instructions.

SERIAL NUMBER: Located on the back of the unit.

Panasonic Company
Division of Matsushita Electric Corporation of America
 One Panasonic Way, Secaucus, New Jersey 07094
Matsushita Electric of Hawaii, Inc.
 320 Waiakamilo Road, Honolulu, Hawaii 96817