

# **SS-40 Receiver Assembly Manual for Printed Circuit Board V1.0H**

(Manual V1.1A4)

**Copyright - 2011**

**Jim Kortge, K8IQY  
&  
The 4 State QRP Group**

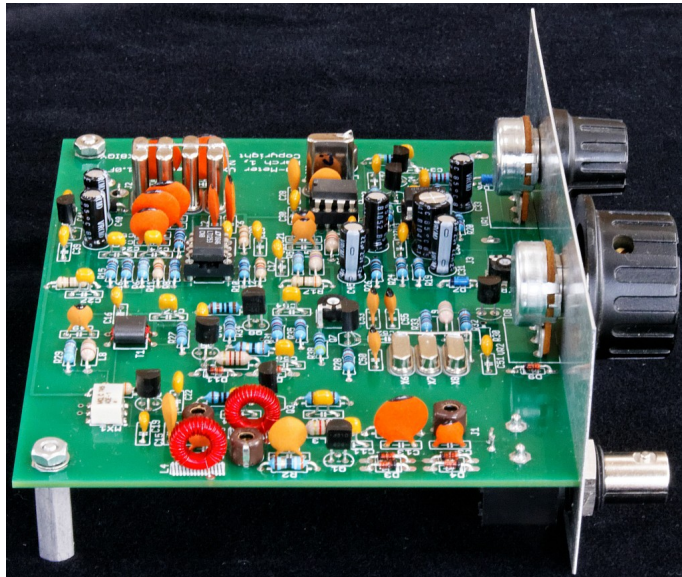

**Prototype SS-40 Receiver**

**Introduced at Ozarkcon 2011**

## **Introduction**

Thank you for purchasing a SS-40 Receiver. We hope you will enjoy building it and using it to listen to the 40-Meter band. This receiver was first conceived several years ago as part of a 2-Band SSB/CW transceiver. That transceiver is still a “work in progress”. In the meantime, it seemed like a good idea to create a stand alone receiver which could be used with the 4 State QRP group NS-40 Transmitter (or other 40-Meter transmitter) and a K8IQY MagicBox, (also available from 4 State) to assemble a complete station.

This receiver is a superhetrodyne design employing a very Stable VXO for frequency control. It has no perceptible drift, even from a cold start. It is also very Sensitive with an MDS of better than -130 dBm. Since it operates on 40-Meters, it was dubbed the SS-40 Receiver. Other features of the receiver include room filling volume when using a speaker, AGC to keep strong signals at bay, and a 4-pole, 500 Hz Butterworth crystal filter. It tunes 25-30 KHz of the band including the two QRP watering holes at 7030 and 7040 KHz.

Printed Circuit Board construction is used with wide part spacing. All of the parts have leads except for the mixer, which is a large footprint surface mount unit. Only 2 toroids with a single winding each are used, minimizing frustration for new builders. All controls and jacks are PCB mounted, eliminating control wiring. The receiver can be constructed by beginners as well as experienced builders. Construction time is approximately 20 hours, depending on experience level. Building follows the schematic diagram layout, allowing sections to be completed and tested when possible before moving on.

## **First Steps**

Before getting started with building the receiver, take some time to organize and familiarize yourself with the parts provided and check them against the Bill of Material. Building over a cookie sheet is recommended to minimize parts being lost. If parts are missing in your kit, send an email to Terry Fletcher, WA0ITP at wa0itp@wa0itp.com. He will promptly provide replacements.

Schematic files are provided as part of documentation package. It is highly recommended to print a couple of copies at 11 X 17 inch format at your local USP Store, Staples, etc. As you build, use a highlighter to mark off parts that have been soldered onto the PCB on one copy. When you think you are done, you can check that copy to verify that all of the parts have been installed. Build section schematics are also provided for convenience that match up with the build steps with their parts call outs.

When installing crystals, put insulators under them to space them off of the PCB. Kraft paper from a grocery bag or the envelope from this kit works well. To make a spacer, poke two holes at the width of the crystal leads through a 0.5 X 0.75 piece of paper with an awl. Slide the spacer on the leads and trim away the excess paper with scissors. Examples are shown in the photos below.

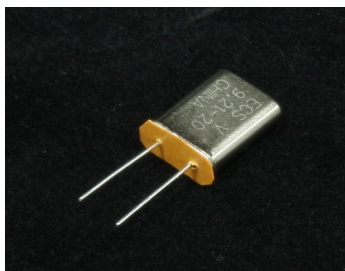
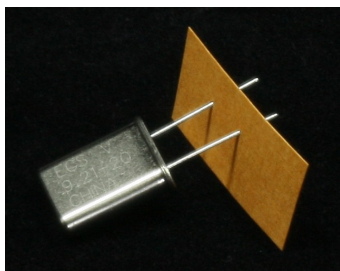

### Step 0 – VXO Tuning Pot VR2

This component is mounted on the top of the PCB first, as it requires some extra steps, since it is not designed for PCB mounting. The previous version of this potentiometer was designed for PCB mounting, but could only be obtained as an audio taper potentiometer, which made tuning the higher end of the VXO range more difficult than desired. VR2 is now a 10K linear taper potentiometer and is used with a shunting resistor to optimize the tuning range versus potentiometer rotation.

Select the two header pins shown in the photo below.

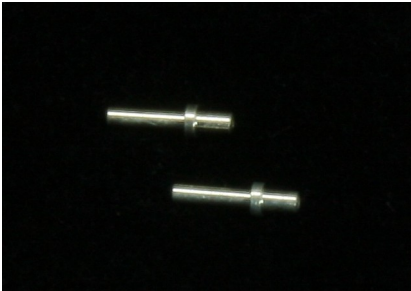

Unmodified Header Pins

Using a sharp pair of diagonal cutters, remove the short part of the pin above the collar area as show in the next photo.

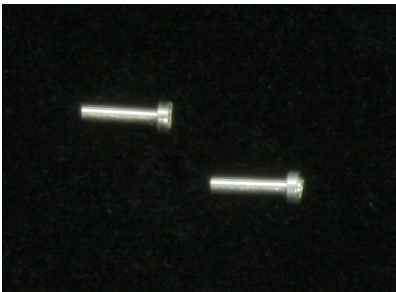

Modified Header Pins

Insert these pins into the outer holes of the PCB, from the bottom side, where the tuning potentiometer VR2 is mounted and carefully solder the pins to secure them. If you have liquid flux available, use a small amount of that at each pin location to make the solder flow better. The bottom of the PCB will look like the next photo.

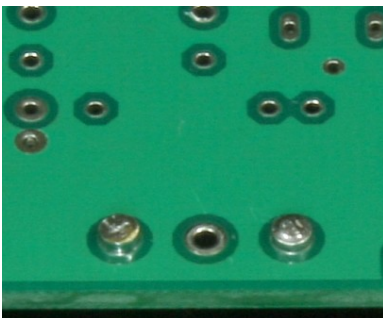

Modified Pins Soldered to PCB

Turn the PCB over and place the 10K linear potentiometer solder lugs **over** these pins with the shaft

pointing away from the board. If you have liquid flux available, use a small amount of that at each pin location to make the solder flow better. Carefully solder one of the potentiometer lugs to its corresponding pin while holding the potentiometer down against the PCB surface and pushed gently away from the edge of the PCB so that the potentiometer is aligned as far rearward as is will go. If you are happy with the alignment, solder the other lug, or reheat the first lug to more favorably realign the potentiometer. Once the outer potentiometer lugs are soldered, solder the center lug. When all of the potentiometer lugs are soldered, the PCB will look like the following photos.

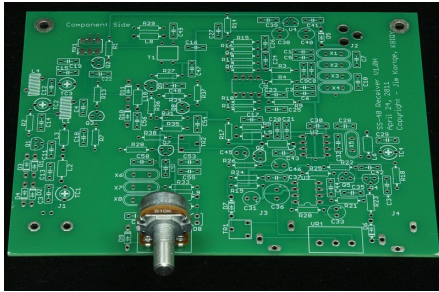

VR2 Mounted – Front View

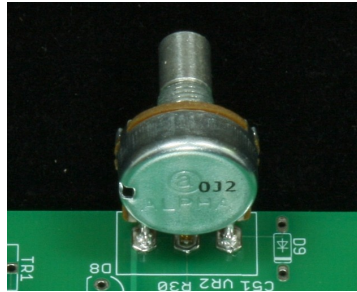

VR2 Mounted – Rear View

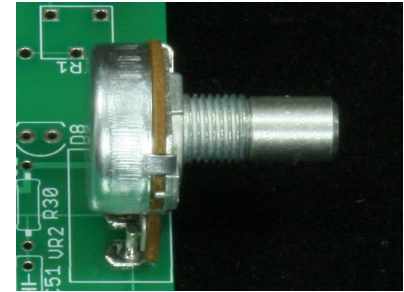

VR2 Mounted – Side View

## Testing

Confirm that the potentiometer is electrically connected to the PCB by measuring its resistance. Place one lead of an Ohm meter at the right mounting hole for resistor R30 and the other lead at the anode (arrow) of diode D9. You should get a reading of  $\sim 10\text{K}$  Ohms. Move the Ohm meter lead from D9 to the left mounting hole for resistor R32. Confirm that the resistance varies from  $\sim 0$  to  $\sim 10\text{K}$  Ohms as the shaft of the potentiometer is rotated over its range.

**Note: the photos shown in this version of the manual do not show VR2 installed until a later point in the construction. They will eventually be updated when another SS-40 is constructed by the author.**

## Step 1 – Connectors

Install connectors J1 through J4. They are all **mounted on the bottom** side of the PCB and soldered on the top or component side of the board. These are the only parts that mount on the underside of the PCB; everything else goes on the top. Highlight them on the schematic when you are done soldering. Your PCB will look like that in the photos below. (Note: As can be seen in these photos, a pair of standoff assemblies have been used to elevate the back edge of the PCB during the building process.)

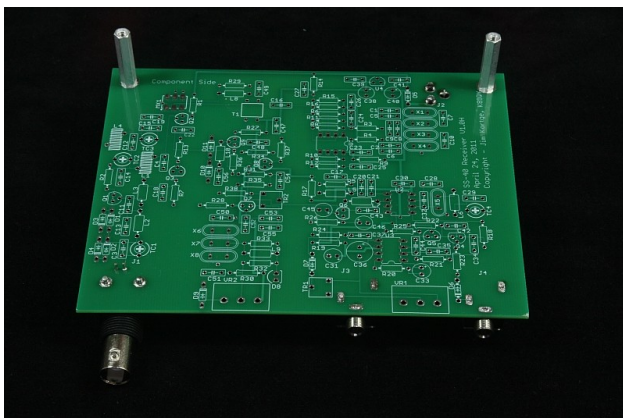

J1-J4 Connectors – Top

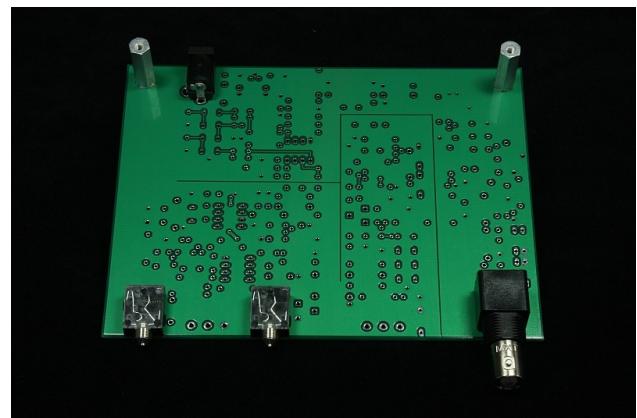

J1-J4 Connectors – Bottom

## Step 2 - Power Supply Components

Install these components in the order they are called out: D5-1N5817 diode, C41-0.1uF capacitor, C40-22 uF capacitor (make sure that the polarity is correct), U4-78L08 8 volt regulator, C39-0.1 uF capacitor, and C38-22 uF capacitor (make sure that the polarity is correct). As each part is solder into the PCB, mark it off on the schematic with a highlighter. When all of them have been installed, your PCB will look like the photos below.

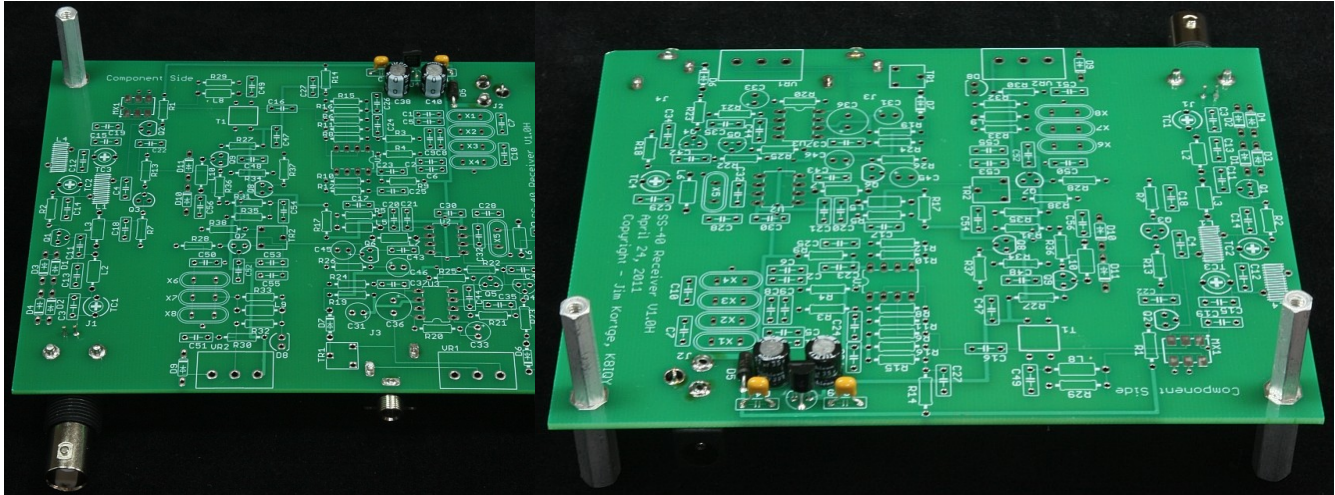

Power Supply Components - Front

Power Supply Components – Rear

## Testing

Apply 10-14 volts dc to power supply connector J2. Using a voltmeter, verify that there is approximately 9.5-13.5 volts at the right pad for resistor R9 and 8 volts at the rear pad for capacitor C47. Use one of the two rear mounting holes for the voltmeter ground lead. (*Note: the mating plug for J2 is a 5.5 mm barrel/2.5 mm pin.*)

## Step 3 - Audio Amplifier Components

Begin this build section by soldering in the 1 K volume control pot, VR1. Solder one lead, then make sure that the shaft is perpendicular to the surface of the PCB before soldering the remaining leads. Next, install an 8-pin IC socket at location U3. The notch in the socket should match the outline on the PCB. Solder one lead and verify that the orientation is correct before soldering the remaining leads. Sequentially solder in the following parts: C36-220uF capacitor (make sure that the polarity is correct), C37-0.1uF capacitor, R24-10 Ohm resistor, R20-2.2 K Ohm resistor, C33-22 uF capacitor (make sure that the polarity is correct), C31-22 uF capacitor (make sure that the polarity is correct), and R19-10 Ohm resistor. As each part is solder into the PCB, mark it off on the schematic with a highlighter. When all of them have been installed, your PCB will look like the photos below.

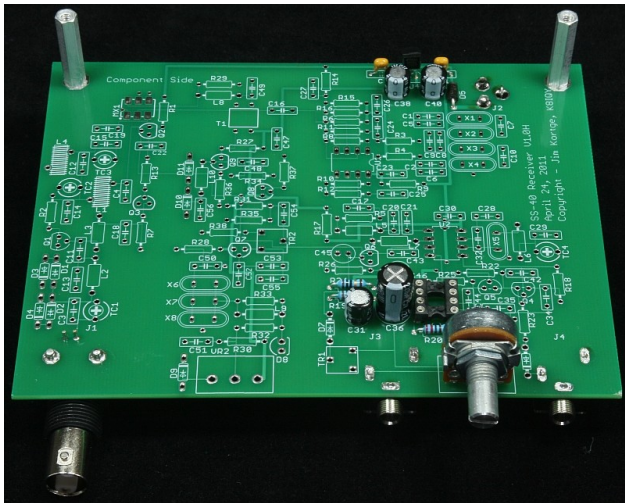

Audio Amplifier Components – Front

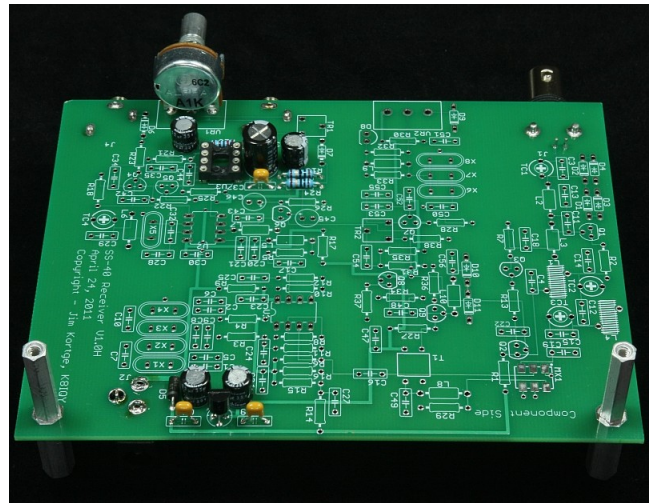

Audio Amplifier Components – Rear

## Testing

Carefully bend the leads of the LM386 chip so that the pairs of leads are parallel to each other and perpendicular to the chip body. Install the chip into the U3 socket; please don't force it and break a lead. Plug a speaker or earphones into audio jack J3. Apply 10-14 volts to connector J2. Set volume control VR1 fully clockwise for maximum volume. Touch either pad for resistor R21 with your finger. A 60 Hz signal should be heard. Rotate VR1 counterclockwise to verify that the volume of the signal can be lowered.

## Step 4 – Audio Mute Components

Continue installing the audio mute components consisting of R21-22 K Ohm resistor, C35-0.1 uF capacitor, D6-1N5711 diode, R23-22 K Ohm resistor, C34-0.1 uF capacitor, C42-0.01 uF capacitor, C44-0.1 uF capacitor, R18-1 M Ohm resistor, Q4-J310 transistor (*Note: J310 transistors are static sensitive, so touch the largest metal object near you before picking one up.*), R22-1 M Ohm resistor, Q5-J310 transistor, and R25-1 M Ohm resistor. As each part is solder into the PCB, mark it off on the schematic with a highlighter. When all of them have been installed, your PCB will look like the photos below.

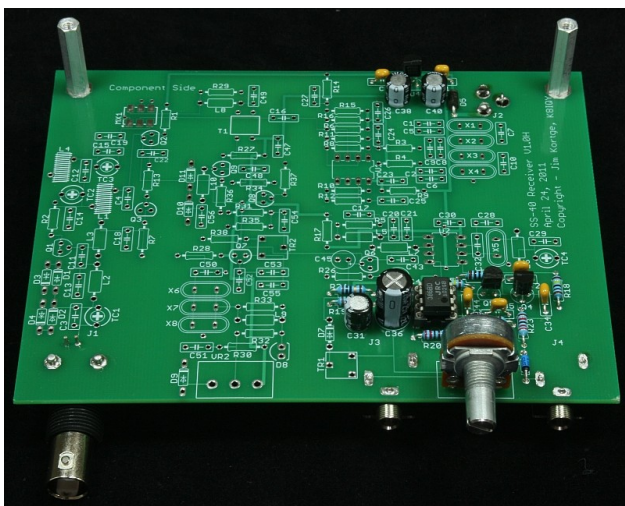

Audio Mute Components – Front

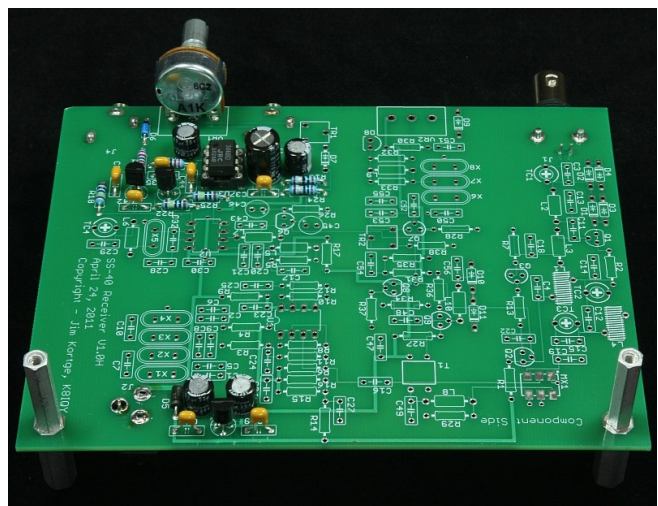

Audio Mute Components – Rear

## Testing

No testing of this stage can be done now because there is no dc bias on the J310 transistors. We'll test this stage after completing the next step.

## Step 5 – Product Detector Components

Install an 8-pin socket at the U2 position. The notch in the socket should match the outline on the PCB. Solder one lead and verify that the orientation is correct before soldering the remaining leads. Install the following components C29-15 pF capacitor, TC4-10-70 pF trimmer capacitor (remove the bends in the leads before inserting it into the PCB and orient it so that the rounded end is grounded), L6-5.6 uH inductor, X5-9.21 MHz crystal (marked “LO”, use an insulator under the crystal and ground the crystal case to the pad provided), C28-120 pF capacitor, C32-120 pF capacitor, R17-39 Ohm resistor, and C30-0.1 uF capacitor. As each part is solder into the PCB, mark it off on the schematic with a highlighter. When all of them have been installed, your PCB will look like the photos below.

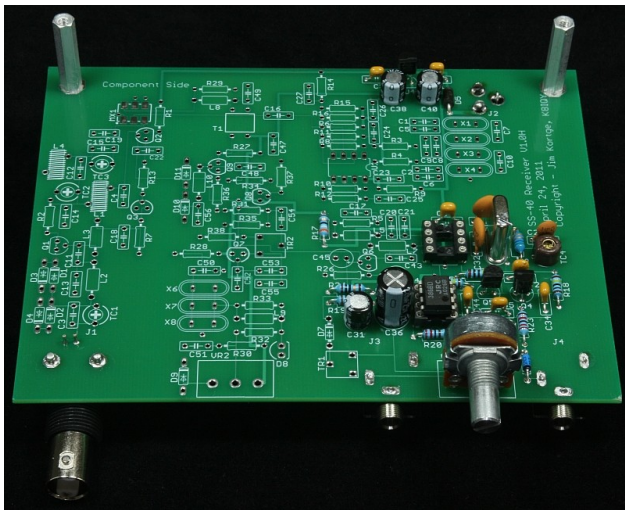

Product Detector Components – Front

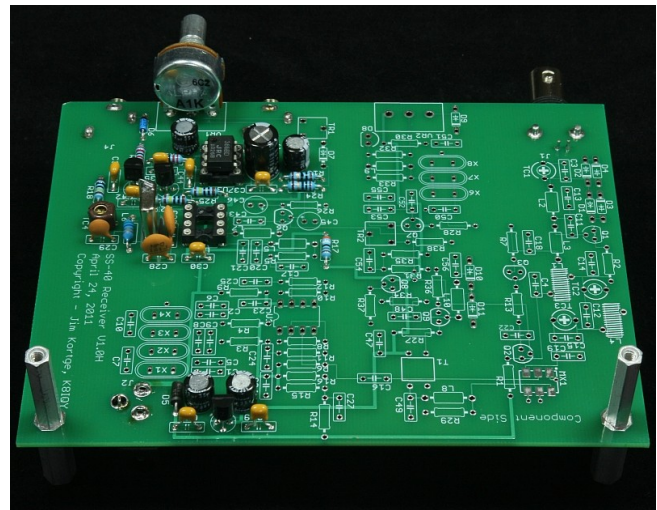

Product Detector Components – Rear

## Testing

Carefully bend the leads of the SA612 chip so that the pairs of leads are parallel to each other and perpendicular to the chip body. Install the chip into the U2 socket; please don't force it and break a lead. Plug a speaker or earphones into audio jack J3. Apply 10-14 volts to connector J2. Set volume control VR1 fully clockwise for maximum volume.

Product Detector – Touch the right pad of L7 with a 3 foot test lead. A hissing signal should be audible.

Audio Muting – With the test lead still connected to the L7 pad, ground the cathode end (bar) of D6 with another test lead. The hissing signal being heard should now be muted.

## Step 6 – Automatic Gain Control 1 Components

Install the first set of automatic gain control components consisting of TR1-10 K Ohm resistive trimmer, D7-1N5711 diode, C45-10 uF capacitor (make sure that the polarity is correct), Q6-PN2222A transistor, R26-1 K Ohm resistor, C46-22 uF capacitor (make sure that the polarity is correct), L7-1 mH inductor, and C43-0.01 uF capacitor. As each part is solder into the PCB, mark it off on the schematic with a highlighter.

When all of them have been installed, your PCB will look like the photos below.

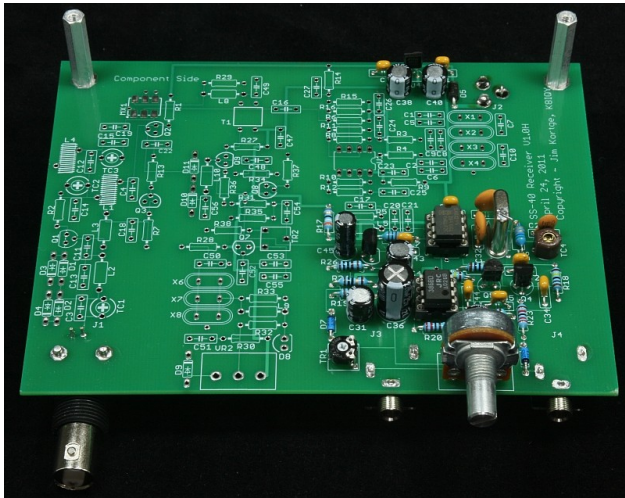

Automatic Gain Control 1 Components – Front

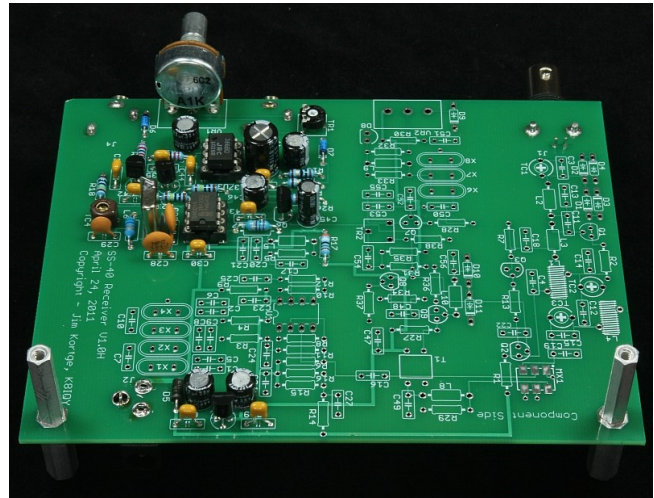

Automatic Gain Control 1 Components – Rear

### Testing

No testing of this stage can be done now.

### Step 7 – Crystal Filter Components

Install these components in the order they are called out: C2-150 pF capacitor, C6-270 pF capacitor, X4-9.21 MHz crystal, C10-270 pF capacitor, X3-9.21 MHz crystal, C9-270 pF capacitor, C8-150 pF capacitor, X2-9.21 MHz crystal, C7-270 pF capacitor, X1-9.21 MHz crystal, C1-150 pF capacitor, and C5-270 pF capacitor. Use an insulator under each crystal and ground the crystal cases to the pad provided, as shown in the photos. As each part is soldered into the PCB, mark it off on the schematic with a highlighter. When all of them have been installed, your PCB will look like the photos below.

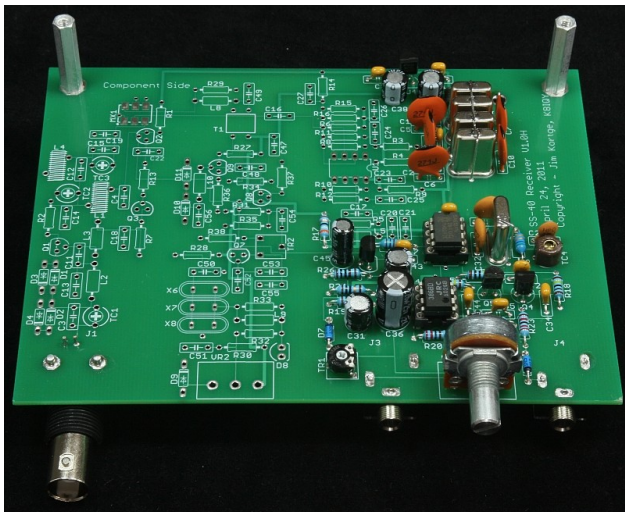

Crystal Filter – Front

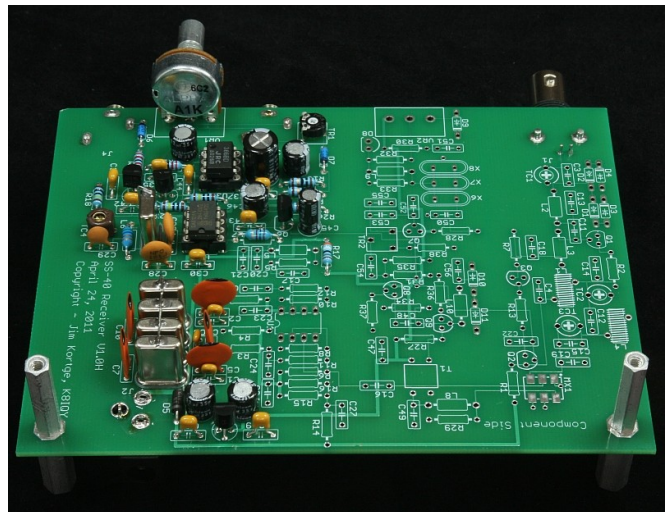

Crystal Filter – Rear

### Testing

No testing of this stage can be done now.



### Step 8 – IF Amplifier (U1B)

Install an 8-pin socket at the U1 position. The notch in the socket should match the outline on the PCB. Solder one lead and verify that the orientation is correct before soldering the remaining leads. Install the remaining components in this order: C21-15 pF capacitor, C20-47 pF capacitor, R4-100 Ohm resistor, L5-4.7 uH inductor, R5-49.9 Ohm resistor, C17-0.1 uF capacitor, R10-1.2 K Ohm resistor, R12-62 Ohm resistor, C25-0.1 uF capacitor, R9-39 Ohm resistor, and C23-0.1 uF capacitor. As each part is solder into the PCB, mark it off on the schematic with a highlighter. When all of them have been installed, your PCB will look like the photos below.

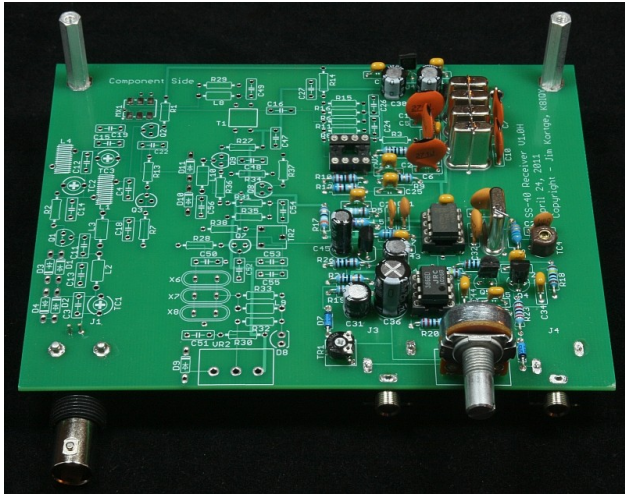

IF Amplifier\_U1B Components – Front

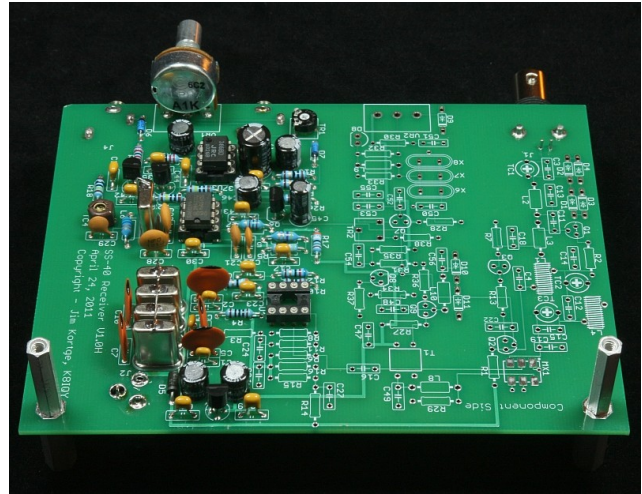

IF Amplifier\_U1B Components – Rear

### Testing

A number of tests will be performed after the U1A components are installed.

### Step 9 – Post Mixer Amplifier (U1A)

Install the U1A, Post Mixer Amplifier components in this order: R3-100 Ohm resistor, R8-1.2 K Ohm resistor, R11-62 Ohm resistor, C24-0.1 uF capacitor, R6-49.9 Ohm resistor, C16-0.1 uF capacitor, C26-0.1 uF capacitor, R16-1 K Ohm resistor, R15-1 K Ohm resistor, C27-0.1 uF capacitor, and R14-39 Ohm resistor. As each part is solder into the PCB, mark it off on the schematic with a highlighter. When all of them have been installed, your PCB will look like the photos below.

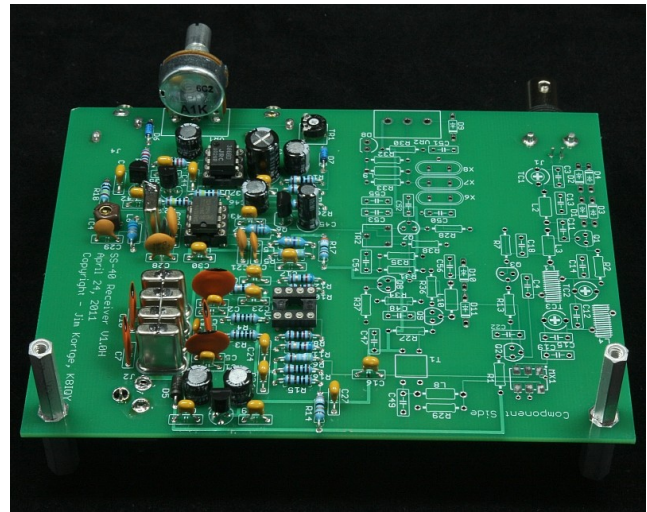
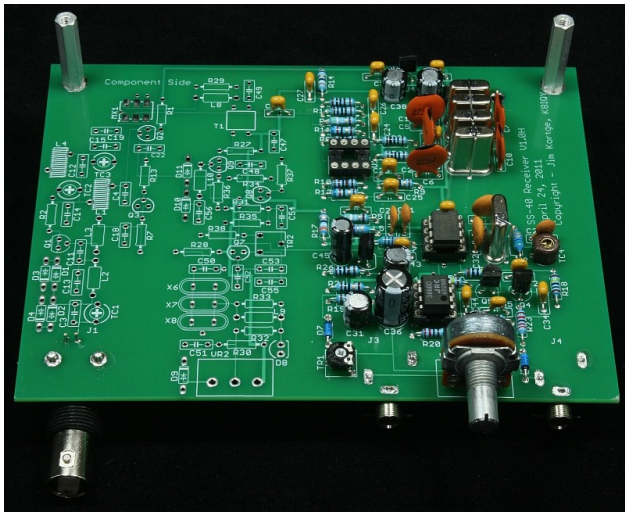

Post Mixer Amplifier\_U1A-Components – Front    Post Mixer Amplifier\_U1A\_Components - Rear

## Testing

Carefully bend the leads of the LT1253 chip so that the pairs of leads are parallel to each other and perpendicular to the chip body. Install the chip into the U1 socket; please don't force it and break a lead. Plug a speaker or earphones into audio jack J3. Apply 10-14 volts to connector J2. Set volume control VR1 fully counter clockwise for minimum volume. Now advance the volume control clockwise. At about 90% rotation, white noise should be heard and increase in volume as the control is advanced. When at full rotation, connect a 3 foot test lead to the mixer end of capacitor C16. More noise should be heard and possibly some static. The receiver is listening to 9.213 MHz, the nominal center frequency of the crystal filter. Rotate capacitive trimmer TC4 through 360 degrees. As that is done, a change in the audio tone of the noise should be noticed. We'll use TC4 to set the receiver to have a 600-750 Hz audio tone when listening to a CW signal centered in the pass band of the crystal filter.

## Step 10 – VXO Components

Install the following parts: D9-1N4148 diode, R30-15 K Ohm resistor, C51-0.1 uF capacitor, R32-100 K Ohm resistor, D8-MVAM109 tuning diode, L9-5.6 uH inductor, R33-22 K Ohm resistor, X6-16.257 MHz crystal, X7-16.257 MHz crystal, X8-16.257 MHz crystal (use an insulator under each crystal and ground the crystal cases to the pad provided), C50-47 pF capacitor, C52 is not used, R28-100 K Ohm resistor, C53-47 pF capacitor, C55-47 pF capacitor, Q7-PN2222A transistor, TR2-1 K Ohm resistive trimmer, and R38-470 Ohm resistor. As each part is solder into the PCB, mark it off on the schematic with a highlighter. When all of these parts have been installed, your PCB will look like the photos below, **including R30**, which is missing.

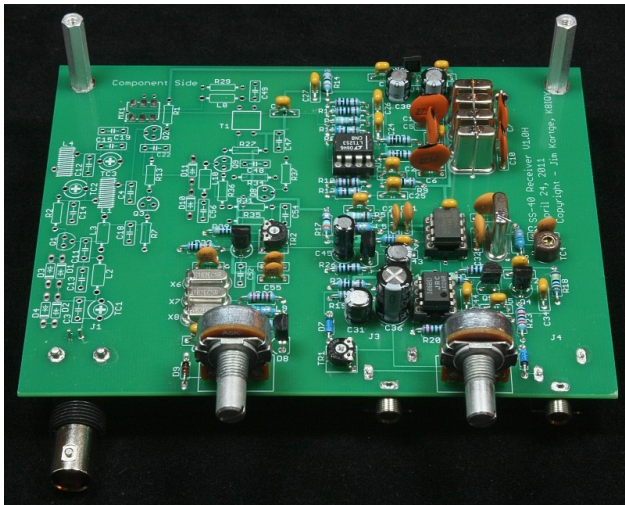

VXO Part 1 Components – Front

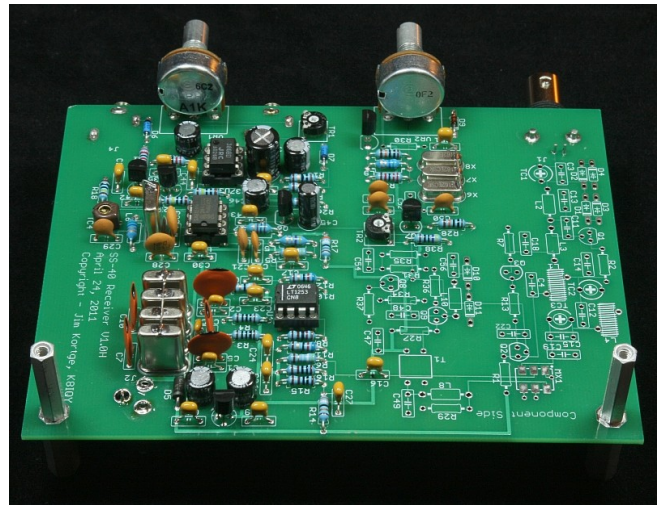

VXO Part 1 Components – Rear

### Testing

A number of tests can be performed on this section of the VXO depending on the test equipment at hand. Apply 10-14 volts to connector J2. Set TR2, the resistive trimmer to the center of its rotation. All measurements are taken at the lower pad of capacitor C54. Using an RF Probe with a DVM, a voltage of 0.8 to 1.0 volts should be seen. Using an oscilloscope, 2.5 volts p-p should be seen. If a counter is available, the VXO frequency can be measured. The VXO tunes 25 to 30 KHz, depending on the crystals and varies from receiver to receiver. On the unit in the photos, it tunes from 16.230 MHz to 16.258 MHz, which is quite typical. When finished, this receiver should nominally tune from 7.017 MHz to 7.045 MHz.

**Continuing the VXO build**, install these parts: C54-0.01 uF capacitor, R31-10 K Ohm resistor, R35-15 K Ohm resistor, Q8-PN2222A transistor, and R37-1 K Ohm resistor. As each part is solder into the PCB, mark it off on the schematic with a highlighter. When all of these parts have been installed, your PCB will look like the photos below.

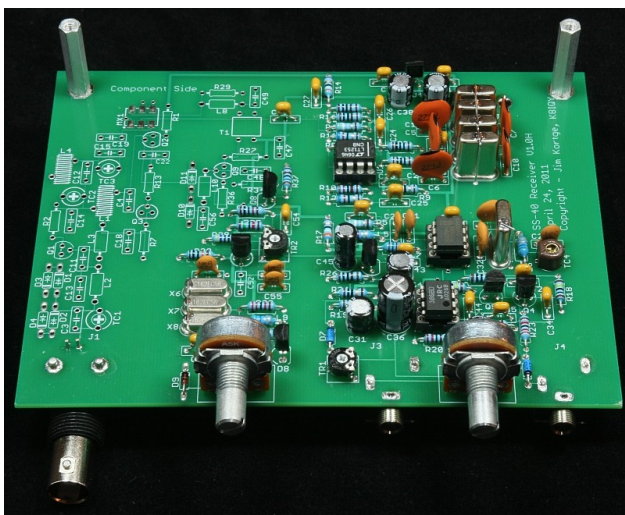

VXO Part 2 Components – Front

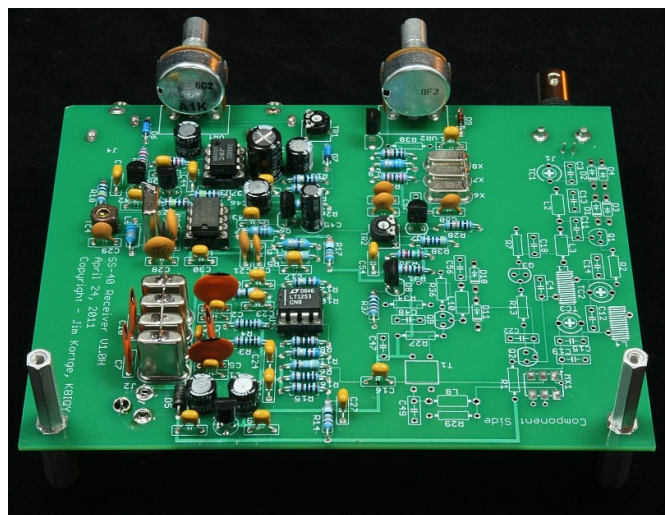

VXO Part 2 Components – Rear

### Testing

The same tests that were performed in the previous step can be repeated with the test point now being the right pad of C48. The results will be nominally the same, since this stage is a gain of 1 (well almost) buffer.

**Finishing the VXO build**, install these parts: C48-0.1 uF capacitor, R34-2.2 K Ohm resistor, L10-1 mH inductor, D10-1N4148 diode, D11-1N4148 diode, C56-0.1 uF capacitor, C47-0.1 uF capacitor, R27-820 Ohm resistor, Q9-PN2222A transistor, R36-39 Ohm resistor, T1-4T Pri/4T Sec transformer (use 6 inch lengths of #30 gauge wire for the windings – see T1 details page), C49-47 pF capacitor, L8-1.8 uH inductor, and finally R29-49.9 Ohm resistor. As each part is solder into the PCB, mark it off on the schematic with a highlighter. When all of these parts have been installed, your PCB will look like the photos below.

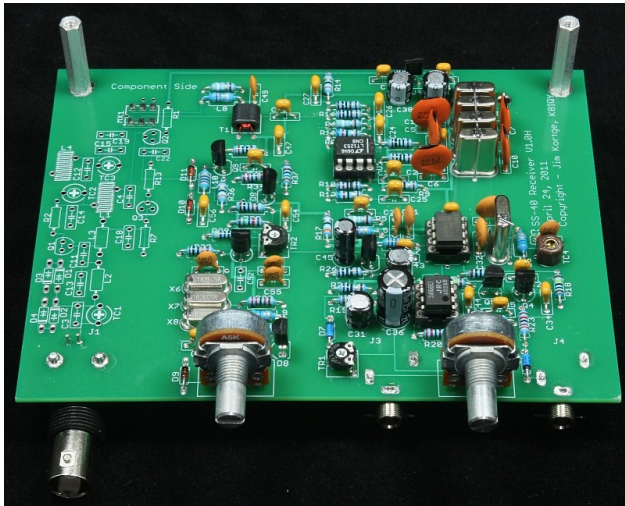

VXO Part 3 Components – Front

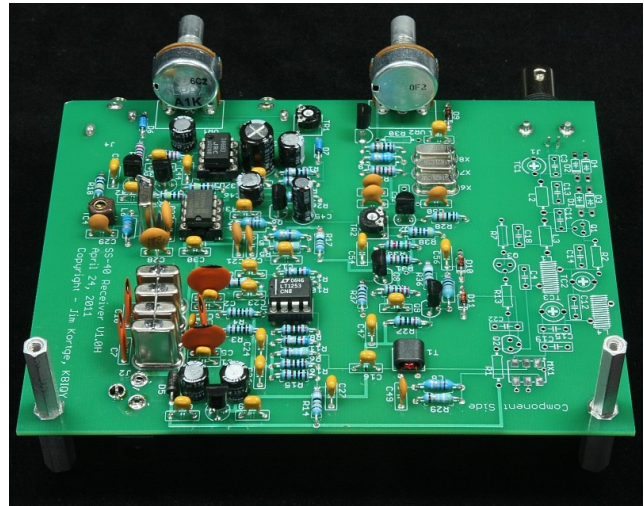

VXO Part 3 Components – Rear

## Testing

A number of tests can be performed on this section of the VXO depending on the test equipment at hand. At this stage of the build, it is the last time that the VXO levels output levels can be measured accurately. Once mixer MX1 is installed, loading of the VXO output precludes accurate measurements from being made. Apply 10-14 volts to connector J2. Set TR2, the resistive trimmer fully counterclockwise. Measuring at Mixer MX1-pad 6 and using an RF Probe with a DVM, a nominal level of 0.9 volts should be seen. As TR2 is rotated clockwise, the voltage should rise to a nominal level of 1.4 volts. Across the range of TR2, an oscilloscope will show 5 volts p-p at the low setting and 7 volt p-p at the high setting. On a spectrum analyzer, at the low setting, the power available is nominally 5.1 dBm and at the high setting, 8.2 dBm. At all settings of TR2, the 2<sup>nd</sup> harmonic of the 16.257 (nominal) LO drive from the VXO is 30 dB below the carrier level.

## Step 11 – Mixer Component

Notice that “component” is used as there is only one part to be installed in this step. However, it is probably the most difficult for most builders, especially those who are new. The key to soldering the MX1 Mixer is to use a tiny amount of liquid flux, if available, on each pad before setting the mixer on the PCB. If using liquid flux, let the part set for 15-20 minutes so that the flux “glues” the chip in place. The other key is to only solder one pin so that if the mixer moves position, that pin can be reheated and the chip pushed back into position. Also, use a small soldering tip for this part.

Something on the order of 1/16 inch +/- should work fine on a 25-40 watt soldering iron. Once one pin is soldered and the chip alignment is correct (make sure the dots align), solder the other 5 pins. **Note: The mixer must be installed correctly for the SS-40 receiver to work. This step must be done right!** After this part is soldered onto the PCB, mark it off on the schematic with a highlighter. When this step is done, your PCB will look like the photos below.

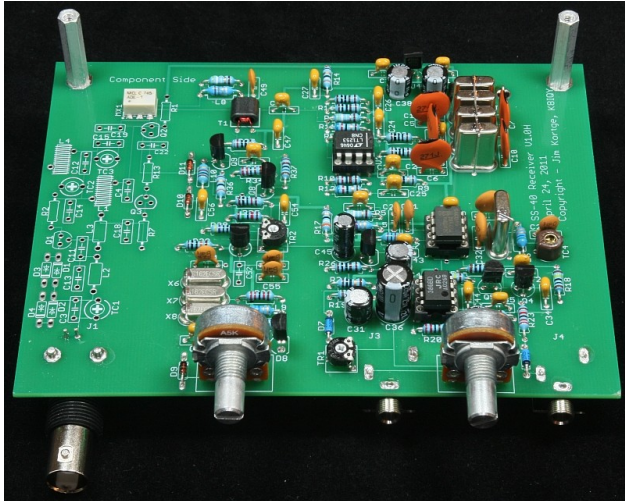

Mixer MX1 Component – Front

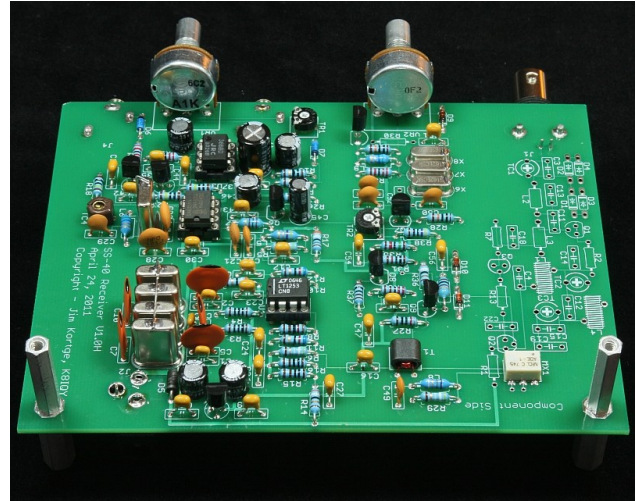

Mixer MX1 Component – Rear

### Testing

Fun time! Plug a speaker or earphones into audio jack J3. Set volume control VR1 for minimum volume. Apply 10-14 volts to connector J2. Attach an antenna to the right pad for capacitor C19. Advance the volume control until band noise is heard. Using the VXO VR2 tuning control, tune around to hopefully hear a CW signal on the lower end of 40 meters. Adjustment of TC4 may be required to set the CW tone you like when receiving. Since no front-end filtering is in place, signals that are much higher in frequency, i.e. those that are the mixing product of the VXO + IF, or nominally 25.458 MHz might also be heard. The receiver performance will improve significantly when the Front-End parts are installed, but for now, enjoy the sounds of a mostly working receiver!

### Step 12 – Automatic Gain Control 2 Components

Install the second set of automatic gain control components consisting of Q3-PN2222A transistor, R13-330 Ohm resistor, Q2-PN2222A transistor, and C22-0.01 uF capacitor. As each part is solder into the PCB, mark it off on the schematic with a highlighter. When all of these parts have been installed, your PCB will look like the photos below.

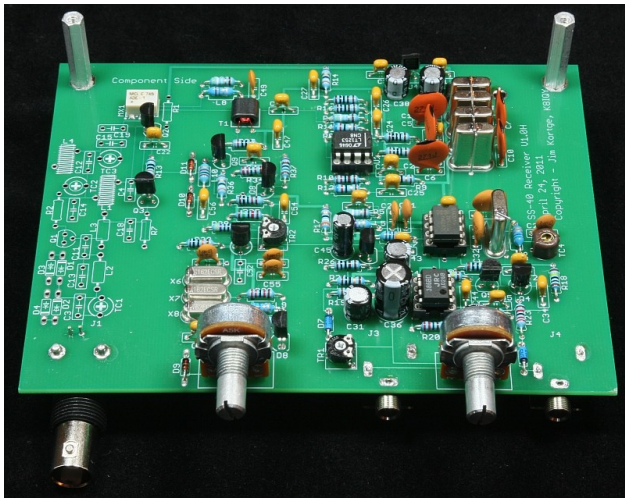

Automatic Gain Control 2 Components – Front

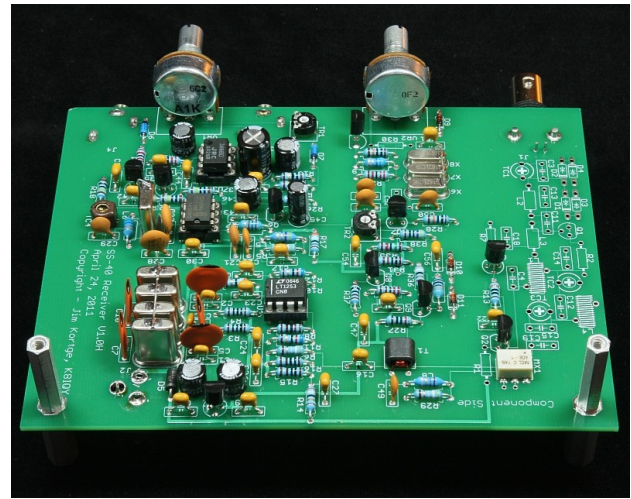

Automatic Gain Control 2 Components – Rear

### Testing

No testing of this stage can be done until the remainder of the receiver is completed.

### Step 13 – Front-End Components

This is the final set of components. When they have been installed, the SS-40 Receiver will be complete and ready for some simple alignment steps and then put into service. Install these components in the order they are called out: C3-27 pF capacitor, TC1-10-70 pF trimmer capacitor, *Remove the bends in the leads of any trimmer capacitor before inserting it into the PCB and orient it so that the rounded end is the lower impedance or grounded end.* D1-1N4148 diode, D2-1N4148 diode, D3-1N4148 diode, D4-1N4148 diode, L2-10 uH inductor, C13-270 pF capacitor, C11-0.01 uF capacitor, L3-1 mH inductor, C18-0.01 uF capacitor, R7-180 Ohm resistor, Q1-J310 transistor, R2-39 Ohm resistor, R1-39 Ohm resistor, C4-0.1 uF capacitor, L1-28T 30 gauge wire wound tightly on T37-2 toroid core, C14-120 pF capacitor, TC2-10-70 pF trimmer capacitor, C12-4.7 pF capacitor, L4-29T 30 gauge wire wound tightly on T37-2 toroid core, TC3-10-70 pF trimmer capacitor, C15-120 pF capacitor, and finally C19-1000 pF capacitor. As each part is solder into the PCB, mark it off on the schematic with a highlighter. When all of these parts have been installed, your PCB will look like the photos below.

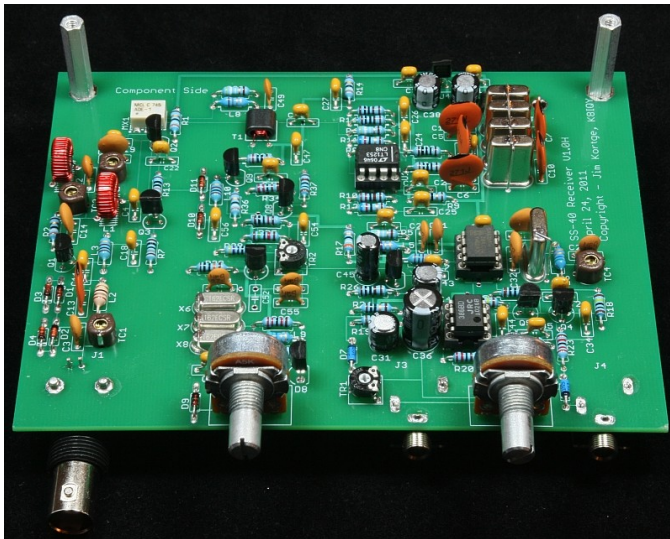

Front-End Components – Front

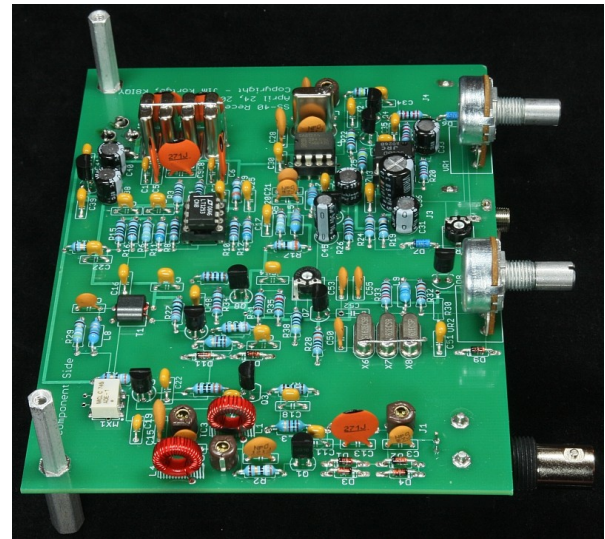

Front-End Components - Left

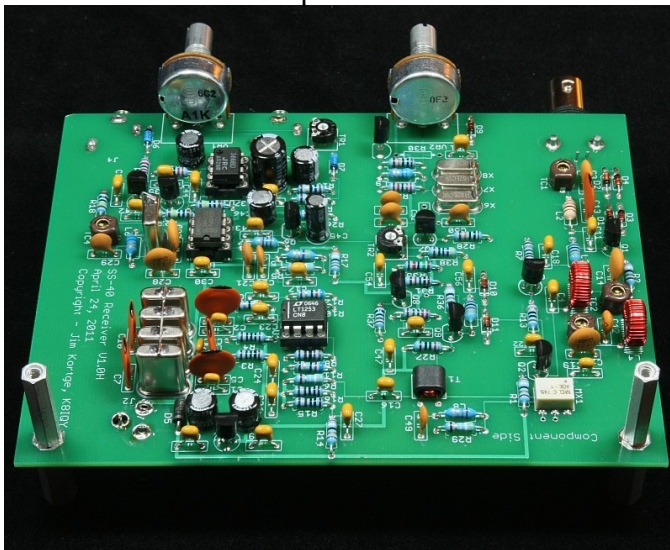

Front-End Components – Rear

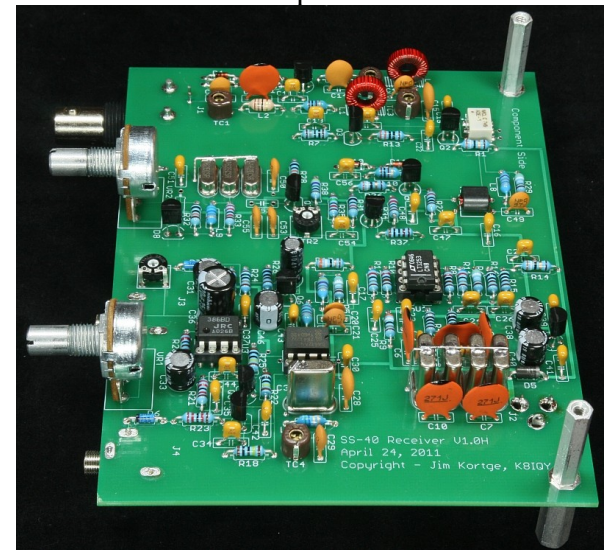

Front-End Components – Right

## Testing

A lot more fun! Plug a speaker or earphones into audio jack J3. Set volume control VR1 for minimum volume. Set the VXO mixer drive level by adjusting trimmer TR2 to the center of its range. At that setting, approximately 7 dBm of LO signal is being supplied to the mixer. Apply 10-14 volts to connector J2. Attach an antenna to the BNC antenna connector, J1. Advance the volume control until band noise is heard. Peak each of the trimmer capacitors beginning with TC3, then TC2, and finally, TC1. After the initial pass, go back and touch each of them up for the loudest band noise. Using the VXO VR2 tuning control, tune around to hopefully hear a CW signal on the lower end of 40 meters. Adjustment of TC4 may be required to set the CW tone you like when receiving. A better job of aligning the receiver can be performed using a signal generator set to 7.035 MHz with a signal level of 10-50 microvolts driving the input (J1) and an RMS voltmeter connected to the audio output connector J3. The three trimmers are adjusted for maximum signal.

To set the AGC level, turn the TR1 trimmer to the approximate center of its range and measure the DC voltage at the “hot” end of C43 with a DVM. With an antenna connected to J1 and the receiver tuned off of any signals, adjust TR1 until a voltage reading of 1.1 volts is measured. Then, while listening to

a moderately strong signal, tweak the adjustment of TR1 until the best audio is achieved without any “clicks” or “thumps”.

TC4 adjusts the frequency of the Local Oscillator by moving the frequency of the LO crystal around. TC4 can be adjusted by ear for the audio tone you prefer. Tune across a weak signal and stop when it is the loudest. That places the signal in the middle of the crystal filter pass band. Then adjust TC4 in the direction that makes the resulting audio tone optimal for your hearing. Many CW operators like the audio tone to be in the range of 600 to perhaps 800 Hz, but it can be adjusted above and below those frequencies.

That completes the assembly and setup of the SS-40 receiver. We hope building it has been a pleasant and rewarding experience.

### Other Useful Information

The SS-40 built and documented in this Assembly Manual uses the same set of parts that you received in your kit. The tuning pot is now a 10K linear unit; the receiver was retrofitted with this part to improve the tuning characteristics. All of the other parts are exactly the same.

Performance measurements for this SS-40 receiver:

Minimum Discernible Signal (MDS) = -133 dBm

Opposite Sideband Suppression = ~50 dB

IF Signal Rejection = ~90 dB

Image Frequency Rejection = ~95 dB

Select Spectrum Analyzer plots for this SS-40 receiver.

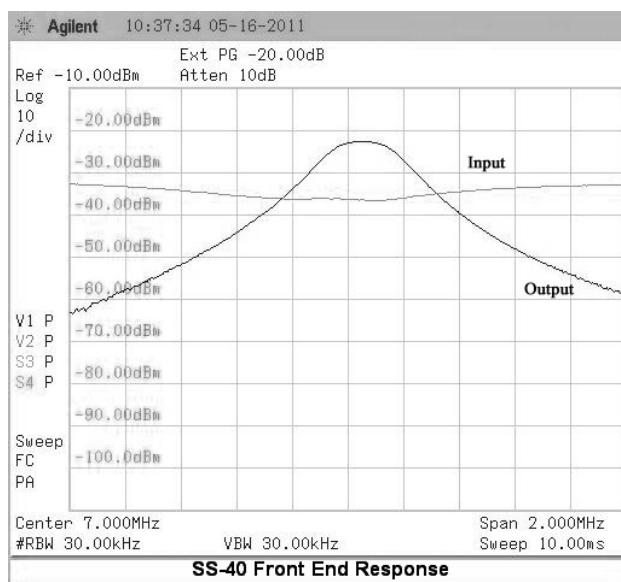
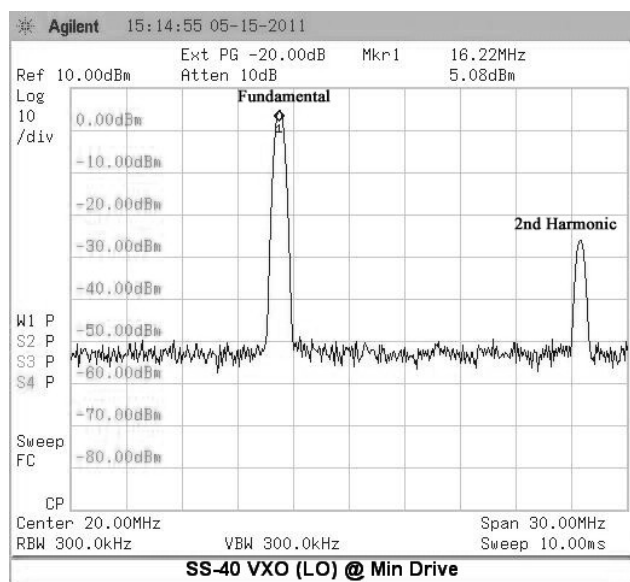



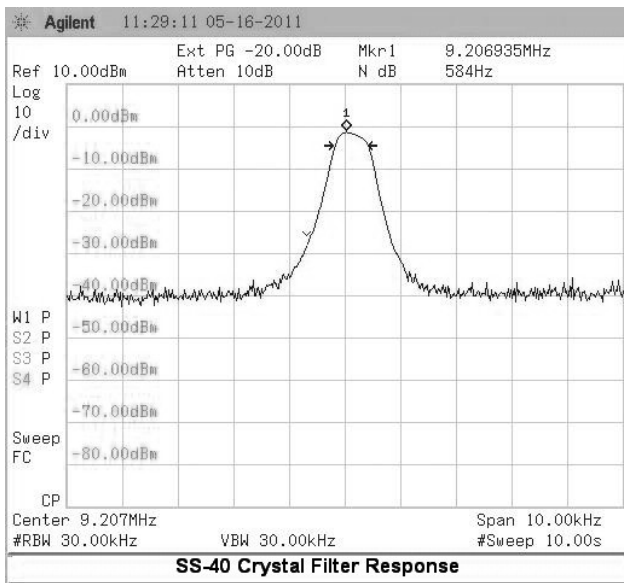

Not detailed is the ability to mute the audio on the receiver using the “key line” which comes out on connector J4. If the lead going to the tip of the mating connector for this jack is grounded, the muting circuitry is activated and the receiver audio will be greatly attenuated. This feature can be used to mute the receiver when it is used as part of a station and the user has implemented their own transmit/receive switching setup.

## SS-40 Specifications

The SS-40 is a 40-Meter, VXO tuned, high performance receiver

- Super sensitive; Minimum Discernible Signal less than -130 dBm
- Super quiet; receiver noise floor at least 40 dB below band noise
- 4-pole IF filter for nominally 50 dB of opposite sideband rejection
- IF Rejection greater than 90 dB
- Image Rejection greater than 95 dB
- 25-30 KHz of “no perceptible drift” band coverage (7.030 & 7.040 included)
- Audio derived AGC (it really does work well)
- “Key Line” audio muting
- Current consumption less than 60 ma.

PCB construction using leaded parts

All PCB parts supplied

Approximately 150 parts

All controls board mounted – no wiring

Construction time ~ 20 hours

5.25" X 4.0 " PCB, fits TenTec TP-41 case (Case supplied by builder)

It is a companion receiver for the 4 State QRP NS-40 transmitter and MagicBox control system

Targeted at Beginning/Intermediate builders; useable by everyone.

## SS-40 Bill of Material

Part	Value	Part	Value	Part	Value	Part	Value
C1	150pF	R1	39	D1	1N4148	U1	LT1253
C2	150pF	R2	39	D2	1N4148	U2	SA612
C3	27pF	R3	100	D3	1N4148	U3	LM386
C4	0.1uF	R4	100	D4	1N4148	U4	78L08
C5	270pF	R5	49.9	D5	1N5817		
C6	270pF	R6	49.9	D6	1N5711	MX1	ADE-1
C7	270pF	R7	180	D7	1N5711		
C8	150pF	R8	1.2K	D8	MVAM109	Q1	J310
C9	270pF	R9	39	D9	1N4148	Q2	PN2222A
C10	270pF	R10	1.2K	D10	1N4148	Q3	PN2222A
C11	0.01uF	R11	62	D11	1N4148	Q4	J310
C12	4.7pF	R12	62			Q5	J310
C13	270pF	R13	330	L1	3.1uH	Q6	PN2222A
C14	120p	R14	39	L2	10uH	Q7	PN2222A
C15	120p	R15	1K	L3	1mH	Q8	PN2222A
C16	0.1uF	R16	1K	L4	3.3uH	Q9	PN2222A
C17	0.1uF	R17	39	L5	4.7uH		
C18	0.01uF	R18	1M	L6	5.6uH	X1	9.215MHz-20
C19	1000pf	R19	10	L7	1mH	X2	9.215MHz-20
C20	47pF	R20	2.2K	L8	1.8uH	X3	9.215MHz-20
C21	15pF	R21	22K	L9	5.6uH	X4	9.215MHz-20
C22	0.01uF	R22	1M	L10	1mH	X5	9.215MHz-20
C23	0.1uF	R23	22K			X6	16.257Mhz-S
C24	0.1uF	R24	10			X7	16.257Mhz-S
C25	0.1uF	R25	1M	J1	Antenna	X8	16.257Mhz-S
C26	0.1uF	R26	1K	J2	Power		
C27	0.1uF	R27	820	J3	Audio Output		
C28	120pF	R28	100K	J4	Audio Mute		
C29	15pF	R29	49.9				
C30	0.1uF	R30	15K				
C31	22uF	R31	10K	T1	4TP-4TS/BN43-2402		
C32	120pF	R32	100K				
C33	22uF	R33	22K	TC1	10-70pF		
C34	0.1uF	R34	2.2K	TC2	10-70pF		
C35	0.1uF	R35	15K	TC3	10-70pF		
C36	220uF	R36	39	TC4	10-70pF		
C37	0.1uF	R37	1K	TR1	10K		
C38	22uF	R38	470	TR2	1K		
C39	0.1uF						
C40	22uF	VR1	1K		Miscellaneous		
C41	0.1uF	VR2	10K	3	8-pin DIP sockets		
C42	0.01uF			4 ft	#30 wire		
C43	0.01uF	C50	47pF	1	PC Board		
C44	0.1uF	C51	0.1uF	1	BN-43-2402 binoc core *		
C45	10uF	C52	TBD	2	T37-2 toroids**		
C46	22uF	C53	47pF				
C47	0.1uF	C54	0.01uF				
C48	0.1uF	C55	47pF				
C49	47pF	C56	0.1uF				

\* for T1

\*\* for L1 & L4

## T1 Winding Information

Here is a short tutorial on how to wind transformer T1

Begin with the BN2402-43 binocular core and two 6 inch lengths of #30 wire.

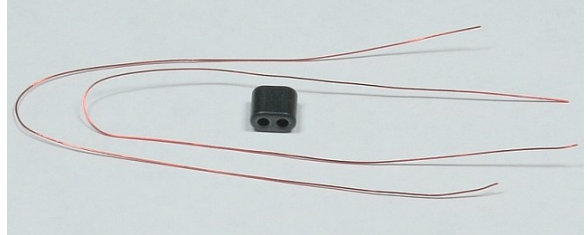

Bend a wire back on itself about 1.25 inches and insert into the core from one end. Snug this first turn up tightly, but not to the point of breaking the wire.

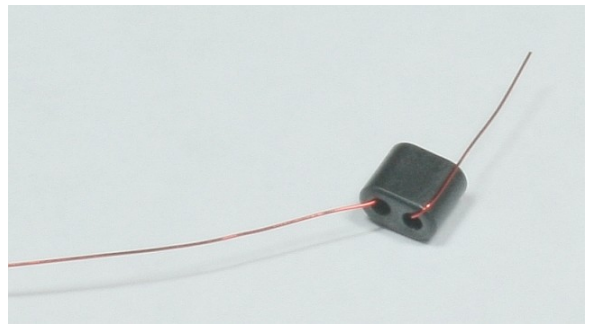

Wind on an additional 3-turns, keeping the turns tight and organized on the core. A turn is counted when the wire goes through a core hole and back through to the opposite side. When 4-turns have been wound on the core, the opposite end from where the wires exit will show 4-turns.

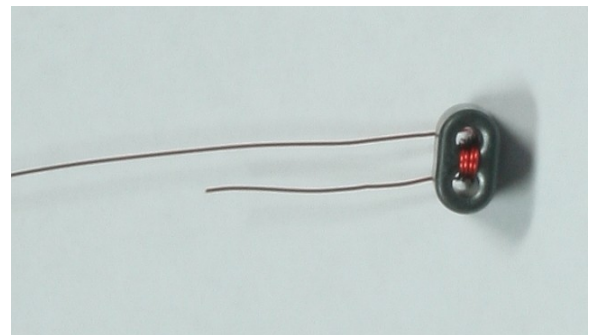

When 4-turns have been wound on, trim off the excess wire leaving about 1 inch long leads.

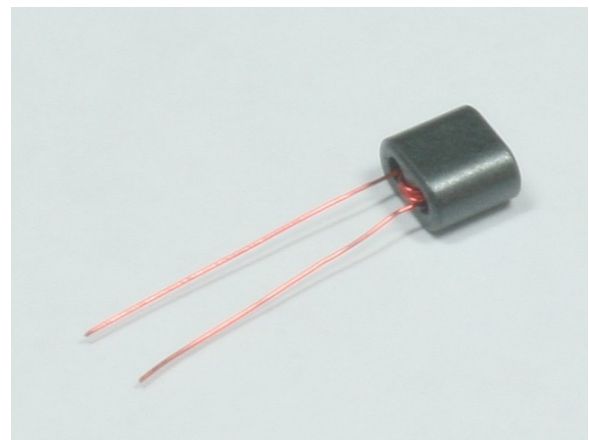

On the opposite end of the core, repeat the process of winding 4-turns on the core, keeping the turns tight and neat.

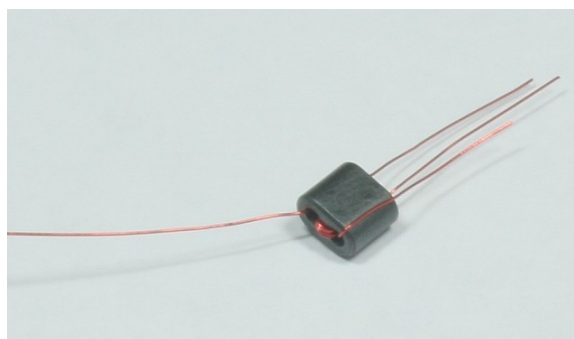

Trim all of the wires to approximately 1 inch, remove the insulation, then tin each lead as shown. T1 is now complete and ready to install into the PCB.

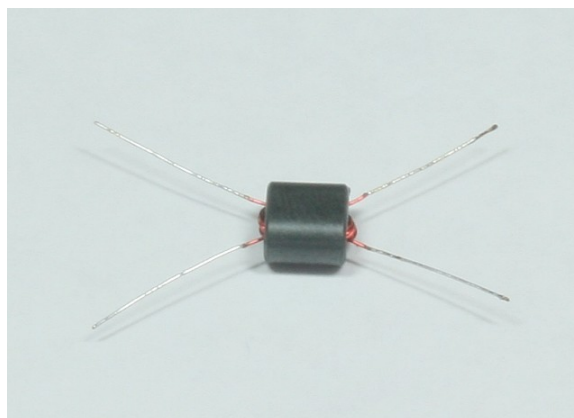

## Schematic Diagrams

The overall schematic diagram for this project can be downloaded from the [www.wa0itp.com/ss40.html](http://www.wa0itp.com/ss40.html) web site. It is a .pdf file and can be printed in large format if desired at a local office supply store. Build section schematics appear on this and the follow pages.

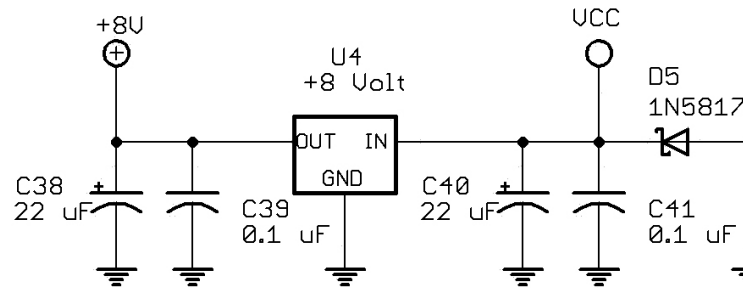

### Step 2 - Power Supply Components

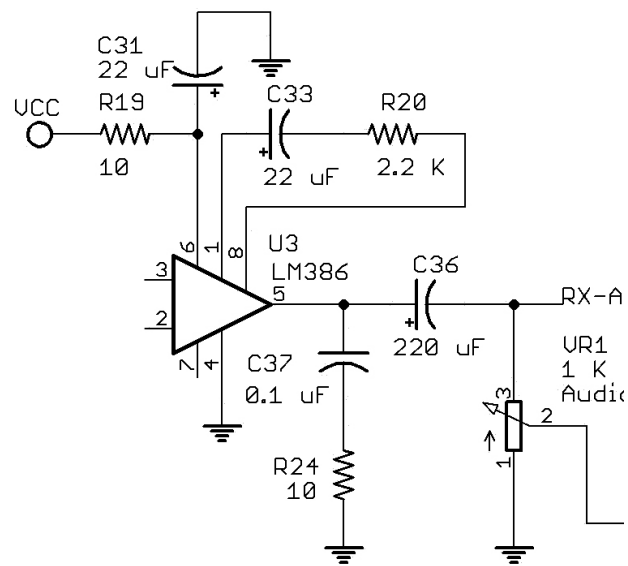

### Step 3 - Audio Amp Components

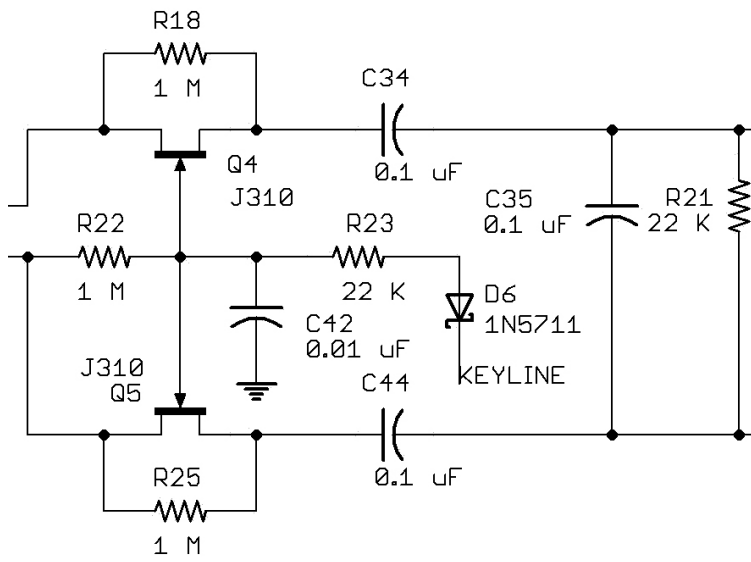

**Step 4 - Audio Mute Components**

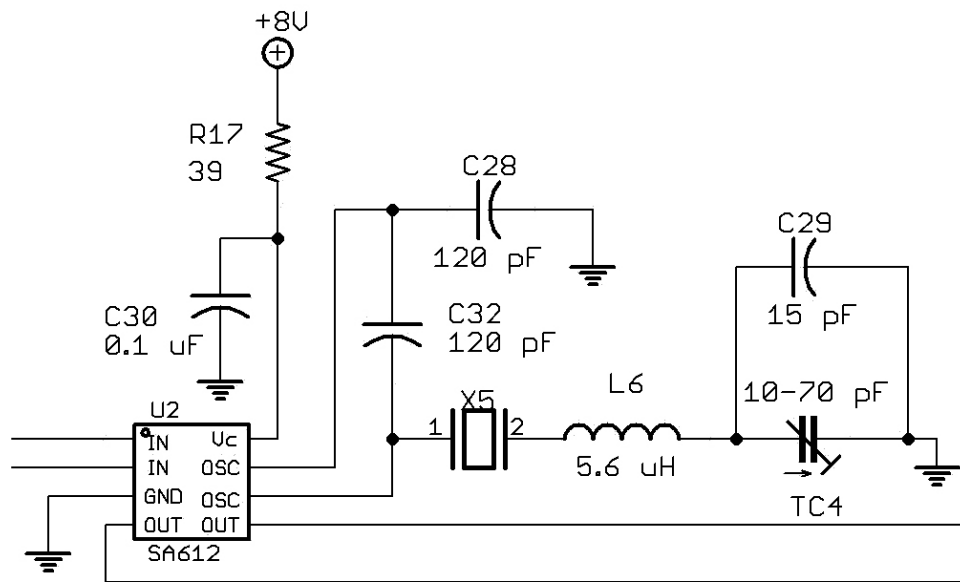

**Step 5 - Product Detector Components**

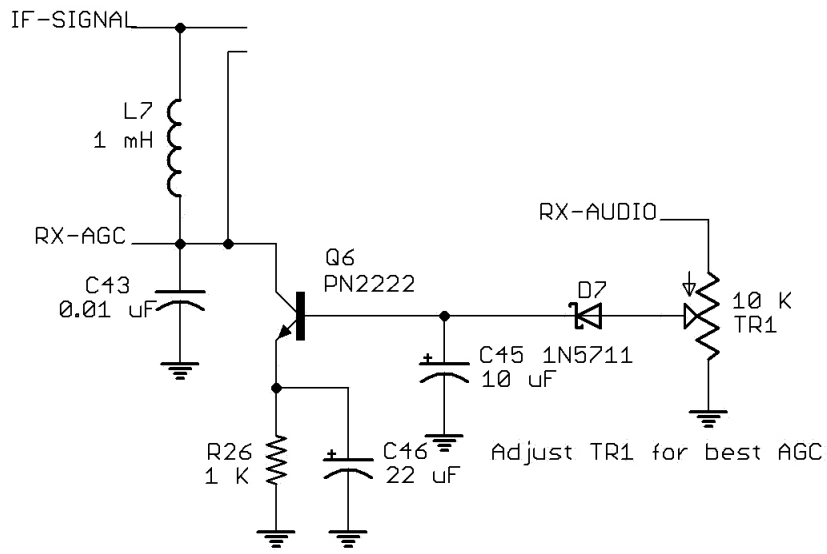

**Step 6 - AGC 1 Components**

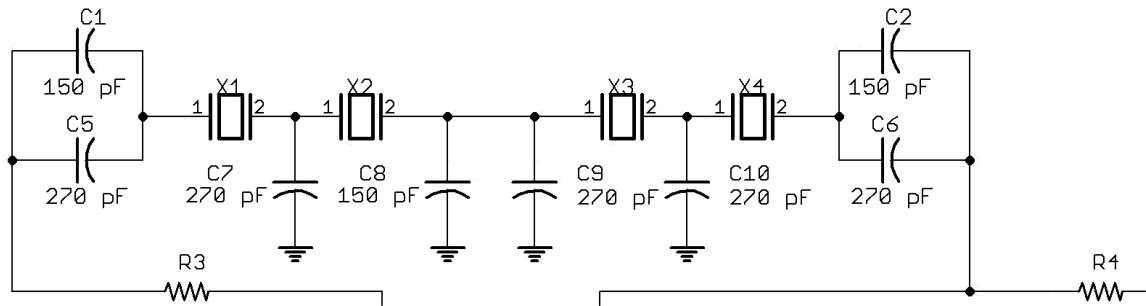

**Step 7 - Crystal Filter Components**



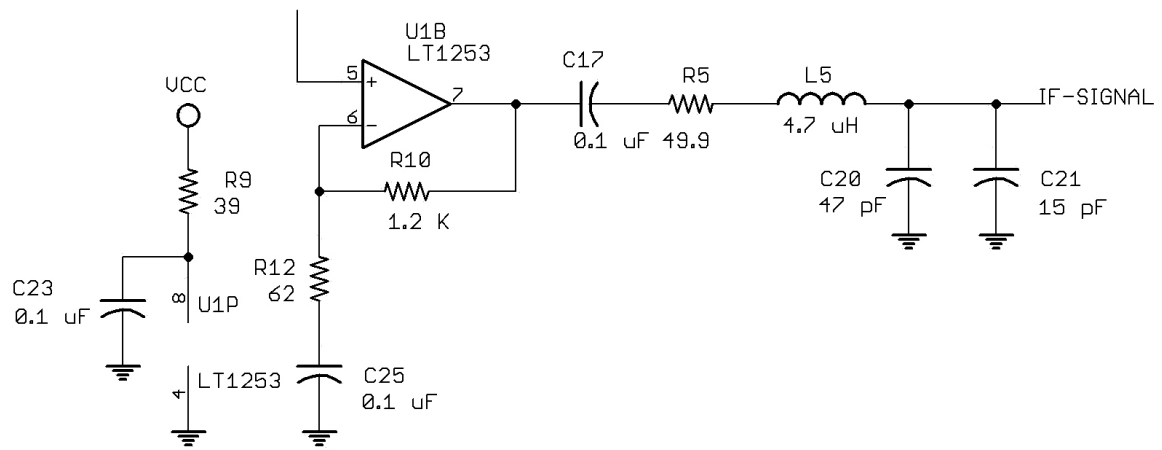

**Step 8 - IF Amplifier (U1B) Components**

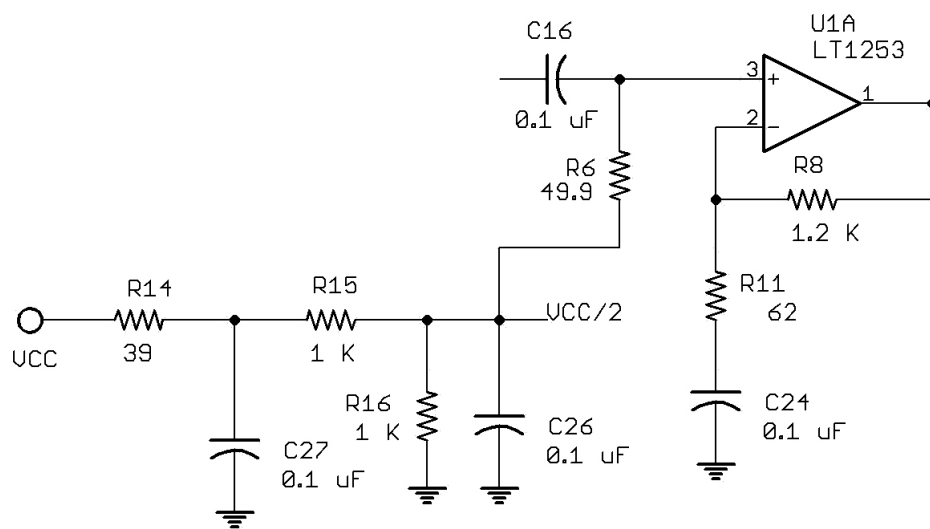

**Step 9 - Post Mixer Amplifier Components**

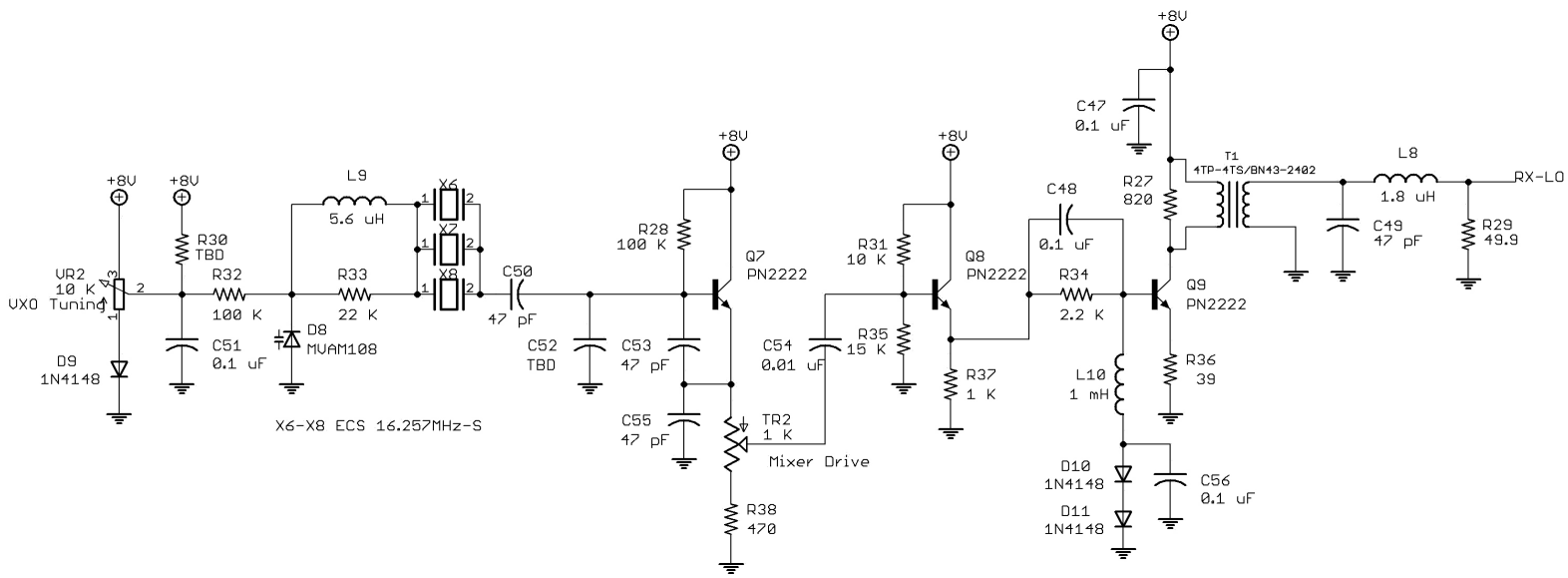

### Step 10 - V XO Components

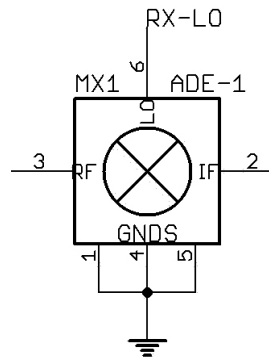

### Step 11 - Mixer Component

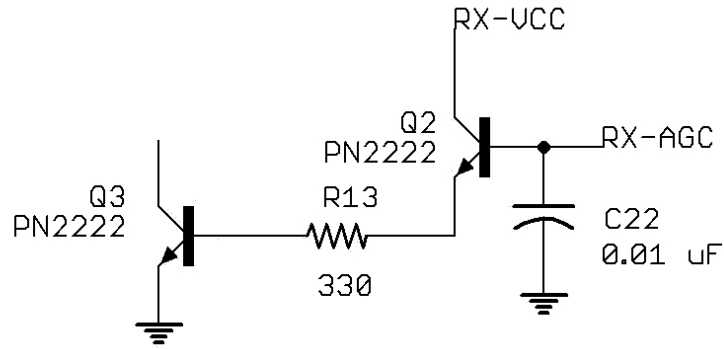

**Step 12 - AGC 2 Components**

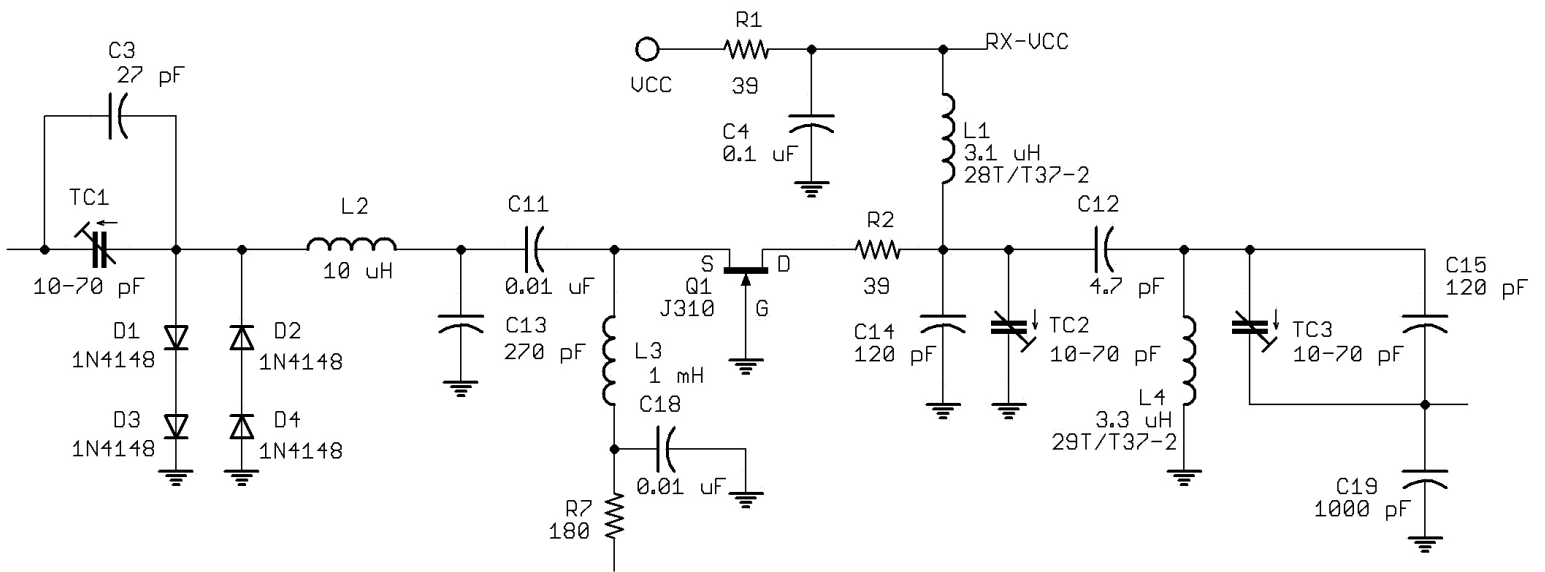

**Step 13 - Front-end Components**

# Parts Placement

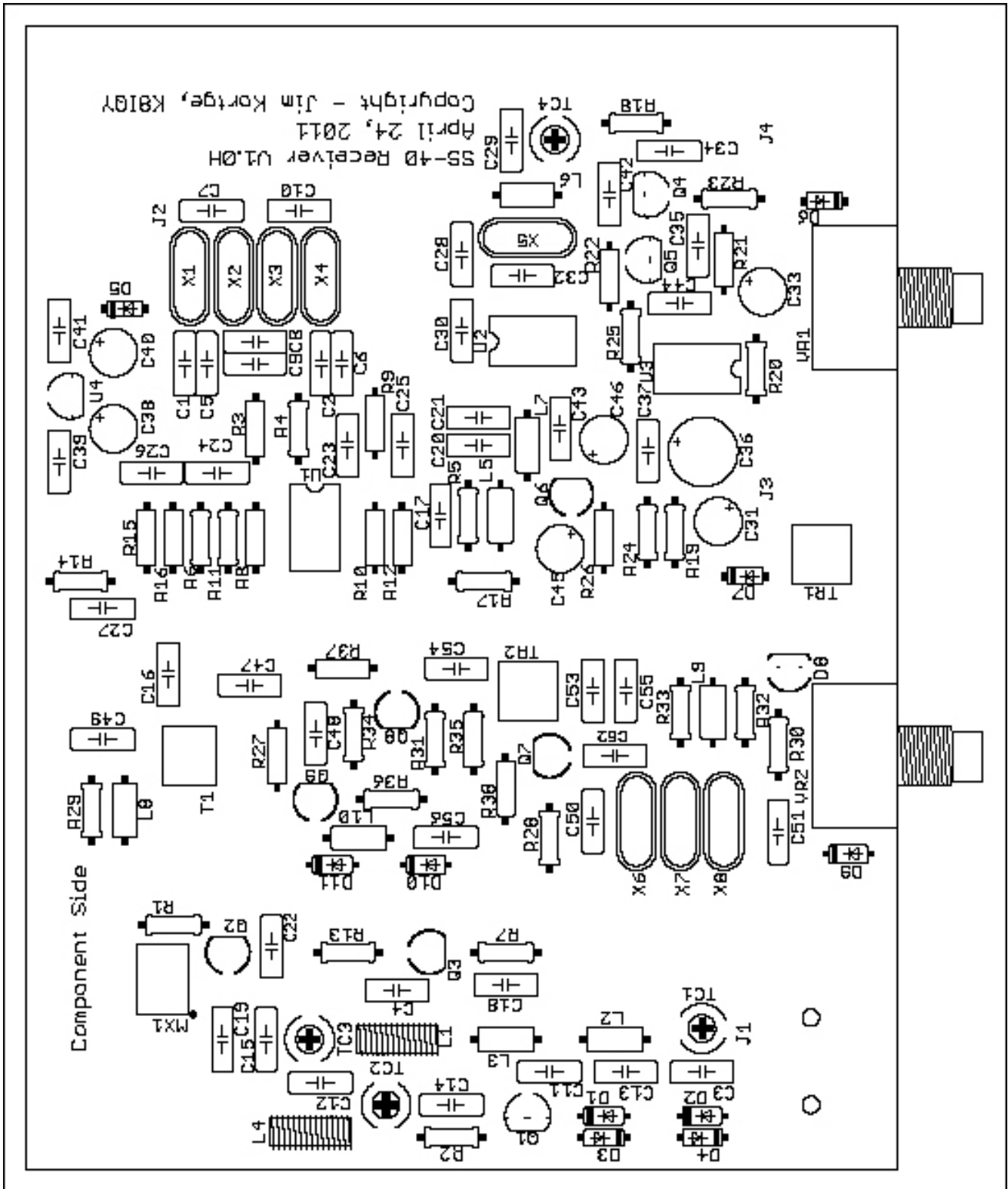

## Metal Film Resistor Color Codes

The resistors used in the SS-40 are metal film,  $\frac{1}{4}$  watt, and 1% tolerance devices. They were selected for their lower noise characteristics. They have a somewhat different color coding than is used with the more common carbon film 5% tolerance resistors. Below is a table for resistor values used in the SS-40 receiver and their color codes.

<b>Value (Ohms)</b>	<b>Color Code</b>
10	Brown Black Black Gold Brown
39	Orange White Black Gold Brown
49.9	Yellow White White Gold Brown
62	Blue Red Black Gold Brown
100	Brown Black Black Black Brown
180	Brown Gray Black Black Brown
330	Orange Orange Black Black Brown
470	Yellow Violet Black Black Brown
820	Gray Red Black Black Brown
1 K	Brown Black Black Brown Brown
1.2 K	Brown Red Black Brown Brown
2.2 K	Red Red Black Brown Brown
10 K	Brown Black Black Red Brown
15 K	Brown Green Black Red Brown
22 K	Red Red Black Red Brown
100 K	Brown Black Black Orange Brown
1 M	Brown Black Black Yellow Brown

If you can't reliably read the color code on the resistor, check its value with your Ohm meter.

### Molded Inductor Color Codes

The molded inductors used in the SS-40 are also color coded and shown in the table below.

<b>Value (uH)</b>	<b>Color Code</b>
1.8	Brown Gray Gold Silver
4.7	Yellow Violet Gold Gold
5.6	Green Blue Gold Gold
10	Brown Black Black Gold
1000 (1 mH)	Brown Black Red Gold

## SS-40 Inventory List

Quantity	Value	Parts list
6	0.01uf	C11,C18,C22,C42-43,C54
19	0.1uf	C4,C16,C17,C23-27,C30,C34-35, C37,C39,C41,C44,C47-48,C51,C56
1	4.7pf	C12
1	10uf	C45
2	15pf	C21,C29
5	22uf	C31,C33,C38,C40,C46
1	27pf	C3
5	47pf	C20,C49-50,C53,C55
4	120pf	C14,C15,C28,C32
3	150pf	C1,C2,C8
1	220uf	C36
6	270pf	C5,C6,C7,C9,C10,C13
1	1000pf	C19

Quantity	Value	Resistor Color Code	Parts list
2	10	Brown Black Black Gold Brown	R19,R24
6	39	Orange White Black Gold Brown	R1,R2,R9,R14,R17,R36
3	49.9	Yellow White White Gold Brown	R5,R6,R29
2	62	Blue Red Black Gold Brown	R11,R12
2	100	Brown Black Black Black Brown	R3, R4
1	180	Brown Gray Black Black Brown	R7
1	330	Orange Orange Black Black Brown	R13
1	470	Yellow Violet Black Black Brown	R38
1	820	Gray Red Black Black Brown	R27
4	1K	Brown Black Black Brown Brown	R15,R16,R26,R37
2	1.2K	Brown Red Black Brown Brown	R8,R10
2	2.2K	Red Red Black Black Brown	R20,R34
1	10K	Brown Black Black Red Brown	R31
1	15K	Brown Green Black Red Brown	R30,R35
3	22K	Red Red Black Red Brown	R21,R23,R33
2	100K	Brown Black Black Orange Brown	R28,R32
3	1M	Brown Black Black Yellow Brown	R18,R22,R25

Quantity	Value	Inductor Color Code	
1	3.1uh	(Self wound toroid)	L1
1	10uh	Brown Black Black Gold	L2
3	1mh	Brown Black Red Gold	L3,L7,L10
1	3.3uh	(Self wound toroid)	L4
1	4.7uh	Yellow Violet Gold Gold	L5
1	1.8uh	Brown Grey Gold Silver	L8
2	5.6uh	Green Blue Gold Gold	L9

## SS-40 Inventory List

### Misc. Components

7	1n4148	D1-4,D9-11	
1	1n5817	D5	
2	1n5711	D6,D7	
1	MVAM109	D8	
3	J310	Q1,Q4,Q5	
6	PN2222A	Q2,Q3,Q6-9	
1	LT1253	U1	
1	SA612	U2	
1	LM386	U3	
1	78L08	U4	
1	ADE	MX1	
5	9.215MHz	X1-X5	
3	16.257MHz	X6-8	
4	10-70pf	TC1-4	Trimmer Cap
1	10K	TR1	Trimmer Resistor
1	1K	TR2	Trimmer Resistor
1	1K	VR1	Pot
1	10K	VR2	Pot ****
3		8-pin DIP sockets	
4 ft		#30 wire	
1		PC Board	
1		BN-43-2402 binoc core	(T1)
2		T37-2 Toroids	(L1 & L4)
1		BNC Ant	J1
2		1/8" Jacks	J3 & J4
1		Power Jack	J2
2		Header Pin	****

Note: \*\*\*\* Parts added for 10K Pot Version of SS-40