CONTENTS

Precautions	1
BC895XLT Controls and Display	2
Introduction	3
Important Notice	4
About this Manual	4
Terminology	5
What is Scanning?	5
What is Searching?	5
What is CTCSS?	5
What is Trunk Tracking?	6
Feature Highlights	7
Where to Obtain More Information	8
Information on the Internet	8
Computer Control of Your BC895XLT	8
Included with Your Scanner	9
Installing Your BC895XLT	10
For Home Use (Desktop Installation)	10
Adapter Safety Feature	11
For Mobile Use (In-Car Installation)	12
Basic Operation	13
Setting the Squelch	13
Using the VFO Control	14
Programming	15
Programming using Manual Entry	15
Programming using the Rotary Tuner	16
Programming using AutoStore	17
Transferring a Programmed Frequency	18
Duplicate Frequency Alert	20
Deleting a Stored Frequency	20
Preventing Accidental Programming	20
Programming Tips	21
Scanning	22
Setting the Delay Mode	23
Channel Lockout	24
Lockout in Manual Mode	24
Lockout in Scanning Mode	24
Lockout Tips	25
Restoring a Locked Out Channel	25
Restoring All Locked-Out Channels	25
Priority Scan	26
Changing the Priority Channel	26
Tape Recording Channel Communication	27
Weather Channel Scanning	28
Weather Alert	28
Testing the Weather Alert Siren	29
Searching	30
Setting a Search Range	30
Search Hold Feature	30
Data Skip	31
Channel Skip	31
Storing Search Frequencies	32
CTCSS Operation	33
Searching for CTCSS Tones	34
Changing a CTCSS Tone	36

Erasing a CTCSS Tone	37
CTCSS Tone Frequencies (Hz)	37
Trunk Tracking	38
Types of Trunking Systems	38
Setting the Squelch	39
Programming Trunking Frequencies	39
Searching a Trunked Bank	40
ID Hold Mode	41
ID Lockout	42
Restoring a Single ID	42
Restoring all IDs	43
Searching Tips	43
Channel Activity Indicators	44
Scan Lists	45
Deleting a Stored ID	47
Fleet Map Programming	48
Selecting Trunking Programming Mode	48
Selecting a Preset Fleet Map	49
Programming a Fleet Map	49
Restoring Default Tracking	51
Programming a Hybrid System	51
Care and Maintenance	52
General Use	52
Location	52
Cleaning	52
Repairs	52
Birdies	52
Troubleshooting	53
Specifications	55
Optional Accessories	56
Appendix	57
Preset Fleet Maps	57
User Defined Fleet Maps	58
One Year Limited Warranty	60

Introduction

The **BC895XLT** is a brand new state-of-the-art radio with **TrunkTracking™** and automatic scanning capabilities. You can store frequencies such as police, fire/emergency, marine, air, amateur, and other communications into 10 banks of 30 channels each. Use it at home as a base unit, or install it in your vehicle as a mobile unit. The Rotary Tuner enables rapid and easy selection of channels and frequencies, and with **AutoStore**, you can automatically program channels in an available bank. In addition, your new scanner has **AutoSort**, which is an automatic frequency-sorting feature which provides faster scanning within each bank.

Use your new scanner to monitor:

- 800 MHz Trunked Public Safety Systems
- Police and Fire Departments (including rescue and paramedics)
- NOAA Weather Broadcasts
- Business/Industrial Radio
- Utilities
- Marine and amateur (ham radio) bands
- Air band

Frequency Range	Steps	Transmission
29.0-29.7 MHz	5 kHz	10 Meter Amateur Band
29.7-50.0 MHz	5 kHz	VHF Low Band
50.0-54.0 MHz	5 kHz	6 Meter Amateur Band
108-137 MHz	12.5 kHz	Aircraft Band
137-144 MHz	5 kHz	Military Land Mobile
144-148 MHz	5 kHz	2 Meter Amateur Band
148-174 MHz	5 kHz	VHF High Band
216-225 MHz	5 kHz	VHF High Band
225-400 MHz	12.5 kHz	UHF Air Band
406-420 MHz	12.5 kHz	Federal Land Mobile
420-450 MHz	12.5 kHz	70cm Amateur Band
450-470 MHz	12.5 kHz	UHF Standard Band
470-512 MHz	12.5 kHz	UHF "T" Band
806-956 MHz	12.5 kHz	Public Service "800" Band

Important Notice

- This scanning radio has been manufactured so that it will not tune to the radio frequencies assigned by the FCC for cellular telephone usage. The Electronic Communications Privacy Act of 1986, as amended, makes it a federal crime to intentionally intercept cellular or cordless telephone transmissions or to market this radio when altered to receive them.
- The installation, possession, or use of this scanning radio in a motor vehicle may be prohibited, regulated, or require a permit in certain states, cities, and/or local jurisdictions. Your local law enforcement officials should be able to provide you with information regarding the laws in your community.
- Changes or modifications to this product not expressly approved by Uniden, or operation of this product in any way other than as detailed by this Operating Guide, could void your authority to operate this product.

About this Manual

- The screen displays used in this manual are representations of what might appear when you use your scanner. Since the actual displays depend on the frequencies and user ID's for your area, as well as the settings you select, you may notice some differences between what is in this manual and what your scanner displays.

What is Scanning?

Unlike standard AM or FM radio stations, most two-way communications do not transmit continuously. The *BC895XLT* scans programmed channels until it finds an active frequency. Scanning stops on an active frequency and remains on that channel as long as the transmission continues. When the transmission ends, the scanning cycle resumes until another transmission is received.

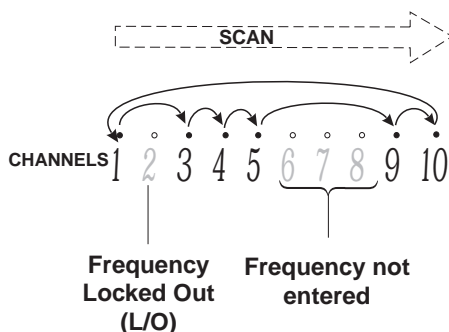

What is Searching?

The *BC895XLT* can search each of its 14 bands to find active frequencies. This is different from scanning because you are searching for frequencies that have not been programmed into your scanner. When you select a frequency band to search, the scanner searches for any active frequency within the lower and upper limits specified. When an active frequency is found, the scanner stops on that frequency as long as the transmission lasts. If the frequency is interesting, you can program it into one of the banks. If not, you can continue your search.

What is CTCSS?

Continuous Tone Coded Squelch System (CTCSS) is a subaudible tone signaling system sometimes referred to as *PL* (Motorola's trademark term standing for *Private Line*). CTCSS is usable only for FM signals and is usually associated with both amateur and commercial two-way repeaters. This system makes use of a special subaudible tone which accompanies a transmitted signal. A set of 38 standard tones has been established by the the Electronics Industry Association.

CTCSS is used for many purposes. In many cases, CTCSS is used to restrict access to a commercial repeater, so that only those units which transmit the correct tone along with their signal can "talk to the repeater." You may also need to have your scanner coded correctly to "hear" the repeater.

CTCSS is also used in areas of high interference where there are several stations with output frequencies in close proximity with one another. When this occurs, you may hear multiple communications at the same time. The stations could even interfere with each other to the point where it is impossible to clearly receive either one. When your receiver, in this case a scanner, is equipped for CTCSS, you can code each received frequency with a specific CTCSS frequency. Then, when multiple signals are broadcast, you will only hear the transmission with the CTCSS tone you have programmed. If you do not receive the correct tone with a signal, the squelch of your scanner remains closed and you will not hear anything.

Establishment of the CTCSS tone for each transmitter (or repeater) is usually done through the cooperative setting of standards by local frequency allocation groups.

What is Trunk Tracking?

Conventional scanning is a simple concept. You enter a radio frequency in your scanner's memory which is used by someone you want to monitor. For example, the police in your area may broadcast on 460.500 MHz, the fire department on 154.445 MHz, the highway department on 37.900 MHz, etc. So when your scanner stops on a frequency, you usually know who it is, and more importantly, you can stop on a channel and listen to an entire conversation. This type of scanning is easy and fun.

As the demand for public communications has increased, many public radio users don't have enough frequencies to meet their needs, and this has created a serious problem. Trunking radio systems solve this problem.

In a trunked radio system, which contains up to 29 different frequencies, radio users are divided into groups, often called talk groups, and these talk groups are assigned specific IDs. When someone in a talk group uses their radio, a brief burst of data is broadcast before each transmission. The trunking system computer uses this data to temporarily assign each radio in a talk group to an available frequency. If the group using a frequency stops broadcasting or pauses between replies for a few seconds, they are removed from the frequency so another talk group can use it.

Sharing of the available public service frequencies, or trunking, allows cities, counties, or other agencies to accommodate hundreds of users with relatively few frequencies. On the other hand, following a conversation on a trunked system is difficult, if not impossible, because when there's a short break during the conversation you're monitoring, it's possible that the talk group will be assigned to a completely different frequency in the trunked system. This type of scanning is difficult and frustrating.

TrunkTracker™ changes this! Not only does your new ***BC895XLT*** scan channels like a conventional scanner, it actually follows the users of a trunked radio system. Once you know a talk group's ID, you won't miss any of the action.

If you're a new scanner enthusiast, you may want to read the first part of this manual and use your scanner in conventional mode before you begin trunk tracking. Understanding scanning fundamentals and terminology will make trunk tracking much easier. If you're already a sophisticated scanner operator, you may want to go to *Trunk Tracking* on page 38 now.

Feature Highlights

- **Trunk Tracking** – Follow 800 MHz trunked public safety and public service systems just as if conventional two-way communications were used.
- **300 Channels** – Program one frequency into each channel. You must have at least one channel programmed to use the Scan mode.
- **10 Banks** – Each bank contains 30 channels, large enough for even the largest trunked systems or useful for storing similar frequencies to maintain faster scanning cycles.
- **Signal Strength Meter** – Your scanner has a signal strength meter, which displays the relative strength of an active transmission, using up to five separate indicators.

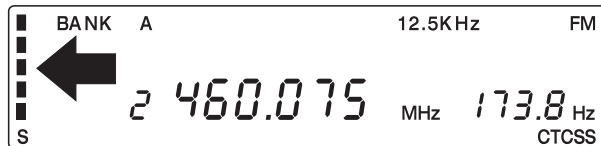

- **CTCSS** – (Continuous Tone Coded Squelch System) When activated, your scanner will only tune to a frequency if the associated CTCSS tone you have programmed is included with the transmission. You can also use this feature to search for a CTCSS tone when monitoring a transmission.
- **14 Bands** – Includes 14 bands, with Aircraft and 800 MHz.
- **29 MHz-956 MHz** – Your scanner covers an extensive frequency range so that you can monitor most of the transmissions in your area.
Note: The frequency coverage is not continuous and excludes the cellular band.
- **10 Priority Channels** – You can assign one priority channel in each bank. Assigning a priority channel allows you to keep track of activity on your most important channel(s) while monitoring other channels for transmissions.
- **VFO Control** – (Variable Frequency Oscillator) Turn the large Rotary Tuner to select a desired frequency or channel.
- **AutoStore** – Automatically stores all active frequencies within the specified bank(s).
- **Weather Alert** – Lets your scanner function as a severe weather warning radio.
- **AutoSort** – Programmed frequencies are automatically sorted within each bank for faster scanning.
- **Unique Data Skip** – Allows your scanner to skip unwanted data transmissions and reduces birdies.
- **Memory Backup** – If power is lost or disconnected, the frequencies programmed in your scanner are retained in memory.
- **LCD Back Light** – Use to select one of three different settings for the display backlight.
- **Auto Recording** – Automatically record channel activity during scanning onto a tape recorder.
- **Scan/Search Delay** – In the Scan or Search Modes, causes the scanner to remain on the frequency two seconds after the last transmission to wait for a possible reply.

Where to Obtain More Information

Before using your scanner, you must program frequencies into available channels. The *Betty Bearcat Frequency Guide* lists frequencies used around the U.S.A. and Canada that you may program into your new scanner.

To order a copy of the frequency guide, call the enclosed Mr. Scanner (800) Number. A Uniden representative should be able to order you a copy of Betty Bearcat for your area and provide you with sample frequencies. You can also use the enclosed order form to purchase a local frequency list.

The Bearcat Radio Club, and other similar hobby clubs, have publications, information on computer bulletin boards, and even contests for the radio enthusiast. Also, your local library has more information.

Information on the Internet

For more information about Uniden and our other products, visit www.uniden.com.

Computer Control of Your BC895XLT

Your scanner can be operated using a personal computer and specialized scanner-control software available through third-party vendors. Uniden America Corporation does not provide support for the software or cables offered through these third-party vendors.

Included with Your Scanner

If any of these items are missing or damaged, immediately contact your place of purchase or Uniden Customer Service at: (800) 297-1023, 8:00 a.m. to 5:00 p.m., Central, Monday through Friday.

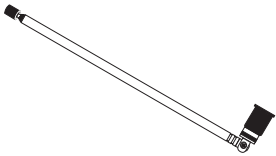
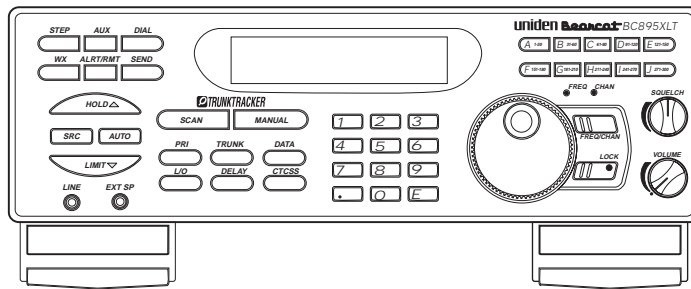

Telescoping Antenna

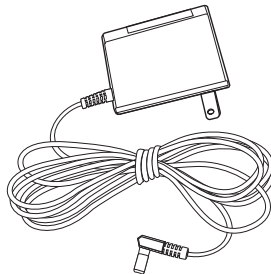

AC Adapter



Owner's Manual

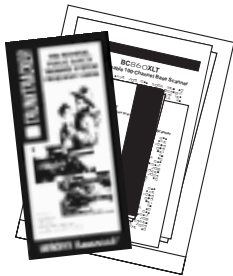

Trunking Frequency Guide and Other Printed Material



Starter Frequency Guide

Installing Your BC895XLT

These are helpful guidelines when using your new scanner:

- If your scanner receives interference or electrical noise, move the scanner or its antenna away from the source. You might also try changing the height or angle of the telescoping antenna.
- If you need to improve reception, use an optional antenna designed for multi-band coverage. (You can purchase this type of antenna at a local electronics store.) If the optional antenna has no cable, use 50-70 ohm coaxial cable for lead-in. A mating plug may be necessary for the optional antennas.
- Use the included earphone or an optional stereo headset with proper impedance for private listening. Read the precautions on the inside front cover of this Guide.
- Do not use the scanner in high-moisture environments such as the kitchen or bathroom.
- Avoid placing the unit in direct sunlight or near heating elements or vents.

For Home Use (Desktop Installation)

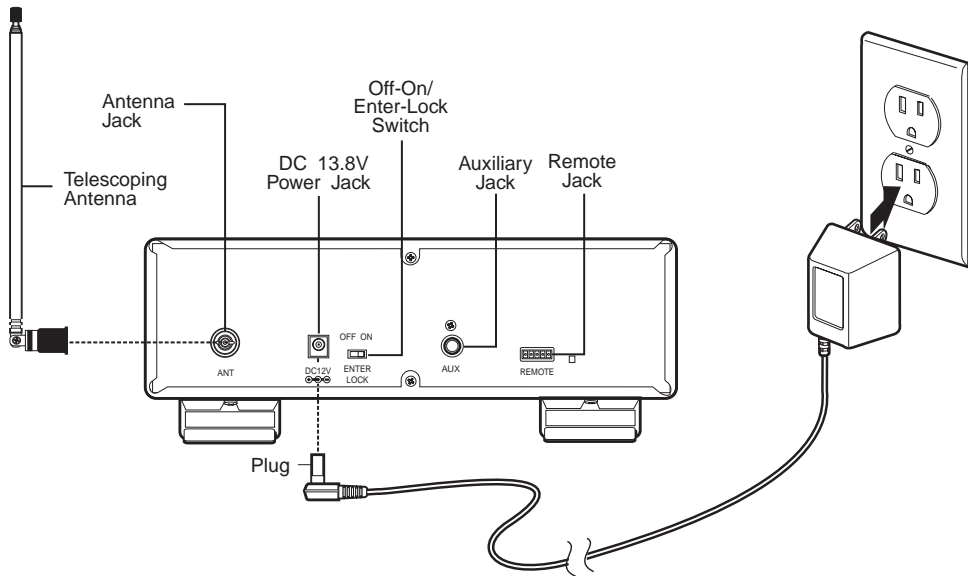

1. Insert the DC plug end of the AC Adapter into the DC 13.8V jack on the rear panel.
2. Plug the AC Adapter into a standard 120V AC wall outlet.
3. Plug the Telescoping Antenna into the ANT connector. Extend the antenna to its full height. For frequencies higher than 406 MHz, shortening the antenna may improve the reception.
4. Use the desktop stand for a better viewing and operating angle.

Adapter Safety Feature

The AC Adapter included with this scanner may be equipped with a polarized line plug — a plug with one blade wider than the other. This plug will fit into a power outlet only one way. If you are unable to insert the adapter's plug into an outlet, try reversing the plug.

For use with an optional external speaker:

Plug the external speaker into the **EXT SP** jack located on the front of the scanner.

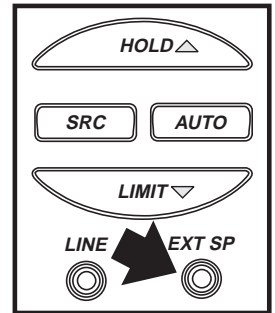

For use with an optional tape recorder:

Your tape recorder must have both a microphone and remote input jacks to work with your scanner. To connect the recorder to the scanner, follow these steps:

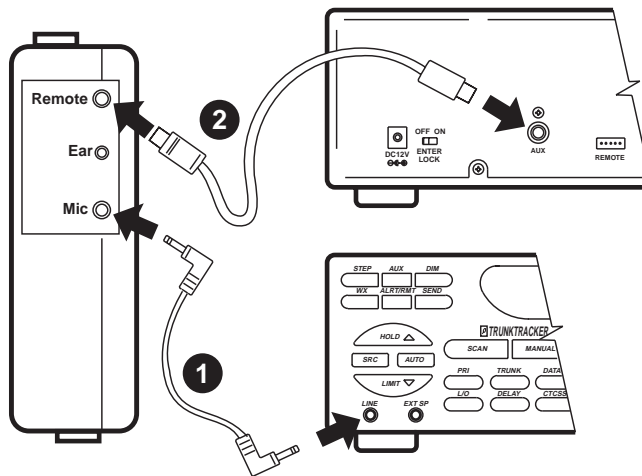

1. Connect a cable from the **LINE** jack on the front of your scanner to the microphone input of the tape recorder.
2. Connect a cable from the **RCA-type AUX** jack on the back of your scanner to the tape recorder's remote jack.

For use with optional computer controlled software:

Your scanner can be operated using a personal computer and specialized scanner-control software. To use the computer controlled feature, press and hold **TRUNKTRACKER** until you hear two short beeps, then refer to the information provided with your optional computer controlled software.

Press **TRUNKTRACKER** again to cancel the computer controlled feature.

For Mobile Use (In-Car Installation)

Mounting the Radio

1. Select a location in your vehicle to mount your *BC895XLT*. Avoid a location that could interfere with your driving. In a passenger car, the ideal location is underneath the dashboard on the passenger side.
2. Use the optional mounting bracket as a template for marking the location for the mounting screws.

Note: *If there are screws already holding the dashboard, you can use the same screw holes to mount the bracket.*

3. Drill the necessary holes and secure the mounting bracket in place using the screws provided with the bracket.
4. Mount the radio to the bracket only after the wiring has been connected to the rear panel.

Connecting the Antenna Plug

Connect the optional mobile antenna plug into the **ANT** connector on the rear panel. (For more information on antenna installation, please refer to the instruction guide that came with your antenna.)

Connecting the DC Power Cord

If you are not experienced in connecting accessories to the vehicle fuse box, please see your automotive dealer for advice on proper installation before completing the steps below.

Temporary Power Cord Installation:

Warning: *Do not use the cigarette lighter power cord in a positive ground vehicle.*

Use the optional Cigarette Lighter Power Cord for an easy, temporary installation.

Plug one end of the Cigarette Lighter Power Cord into the cigarette lighter jack, and the other end into the DC 13.8V jack on the back of the scanner.

Permanent Power Cord Installation:

1. Check the vehicle battery connections to determine which battery terminal (positive or negative) is grounded to the engine block or chassis. Most of today's vehicles use a negative ground. If your vehicle has a negative ground, follow the steps below. Otherwise, please see your automotive dealer for advice on installing negative ground accessories in your vehicle.
2. Connect the RED wire of the optional DC power cord to the accessory contact in your vehicle's +13.8 VDC fuse box.
3. Connect the BLACK wire of the DC power cord to the negative side of the vehicle (usually the chassis).
4. Insert the DC plug into the DC 13.8V jack on the back of the scanner.

Basic Operation

Note: You can fold out the Front Cover to see the Controls and Indicators while reading this Guide.

Setting the Squelch

To set the squelch, you must be in the Manual mode, and you should not be receiving a signal on your scanner.

1. Press **MANUAL** until you do not hear a signal.
2. Adjust **VOLUME** to a comfortable listening level.

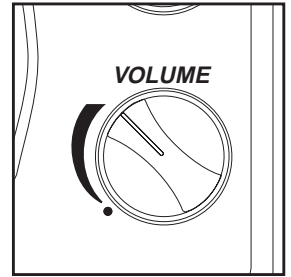

3. Think of the Squelch Control as a gate. Turn **SQUELCH** fully counter-clockwise. This raises the "Squelch Gate" so high that only very strong signals can get through.

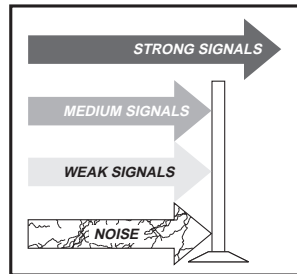
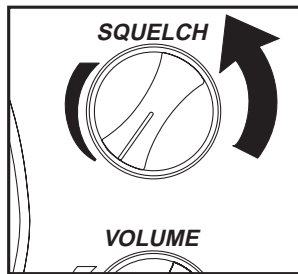

4. Turn **SQUELCH** fully clockwise until you hear a hiss. This lowers the "Squelch Gate" so that everything gets through—noise, weak signals, and strong signals.

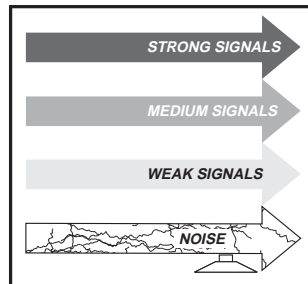
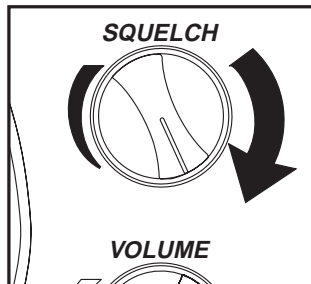

5. Turn **SQUELCH** back counter-clockwise just until the hiss stops. Now the “Squelch Gate” allows only clearer signals through.

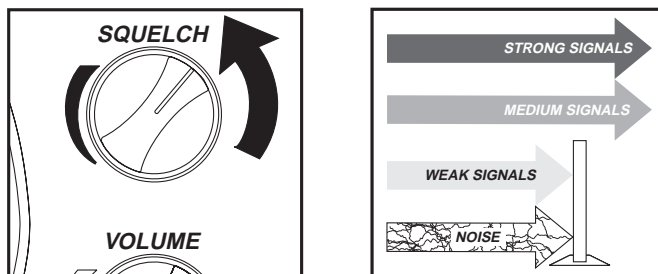

Using the VFO Control

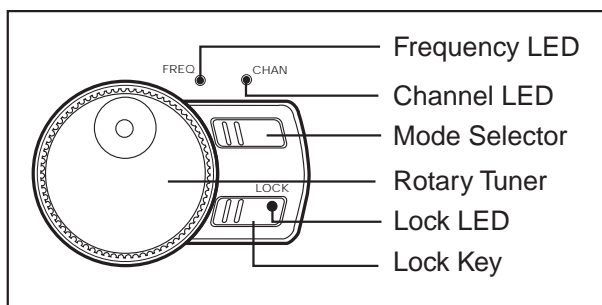

Rotary Tuner

Use the Rotary Tuner for the following:

- Rapidly and precisely selecting either frequencies or channels
- Selecting a CTCSS tone during CTCSS Programming
- Scrolling through Scan and Lockout Lists in the Trunking Mode.

Frequency/Channel Mode Selector

Press to switch between channel or frequency mode. When the **CHAN** LED is on, you can step rapidly through channels with the Rotary Tuner. When the **FREQ** LED is on, you can tune quickly and accurately through frequencies with the Rotary Tuner.

Lock Key/LED

Press the LOCK key to enable or disable the Rotary Tuner. When the LOCK LED is on, the Rotary Tuner is locked. This prevents accidentally changing the displayed channel and frequency when monitoring a broadcast.

Programming

The *BC895XLT* has 300 memory channels, each of which can be programmed to store one frequency. The channels are divided into ten 30-channel banks, useful for storing similar frequencies in order to maintain faster scanning cycles.

Each time you store a frequency, the list of scanning frequencies in the bank is automatically sorted by frequency number. This unique Auto Sort feature enables faster scanning. When you manually step through a bank, however, frequencies are sorted according to channel number.

Select one of the following ways to program your scanner:

- Manually select a channel and frequency, using your numeric keypad
- Use the Rotary Tuner to select a channel and frequency
- Use the Auto Store feature to automatically program the channels
- Transfer a programmed frequency from another channel

Programming using Manual Entry

1. Select frequencies from your starter guide.

LOCATION	BASE	MOBILE
PAYETTE	460.150	465.150
PINEHURST	155.490	***.***
POCATELLO	154.725	***.***

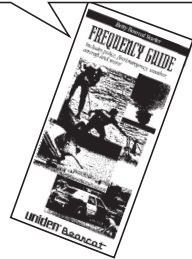

2. Press **MANUAL** to stop scanning.
3. Select a channel.
 - a. Enter the channel number.
 - b. Then press **MANUAL**.

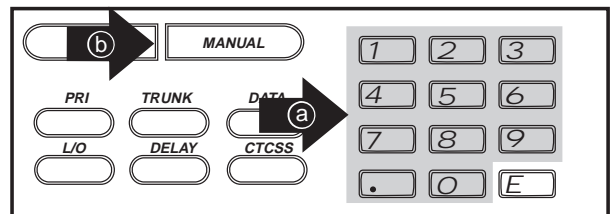

4. Enter the frequency.
 - a. Enter the frequency number.
 - b. Then press **E**.

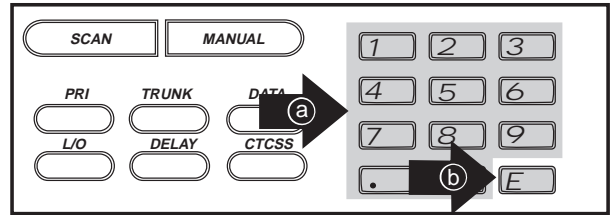

Note: To clear a mistake while entering the frequency, press **.** twice, and start over.

If you enter a frequency which is outside the scanner's frequency bands, a distinctive beep sounds.



The display will flash for a moment and then reset itself, or you can press **.** and go back to the previous step.

See the Table on page 3 for information concerning the frequency bands covered by your scanner.

Programming using the Rotary Tuner

1. Press **MANUAL** to stop scanning.

If the green **LOCK** LED is on, press **LOCK** to unlock the Rotary Tuner.

2. Press **FREQ/CHAN** until the green **CHAN** LED lights.
3. Use the Rotary Tuner to select the channel you want to program.



4. Press **FREQ/CHAN** until the red **FREQ** LED lights.
5. Use the Rotary Tuner to select the frequency you want to program

Note: You can also enter the frequency on your keypad.

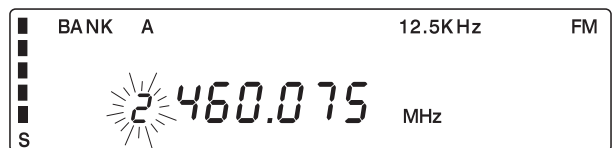

- Press **E** to program the frequency into the channel you selected.

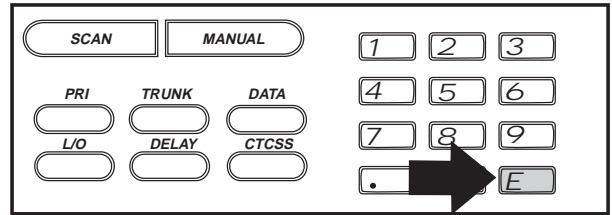

Programming using AutoStore

To use this feature, you must set up a search range. Once the search begins, *AutoStore* will automatically program active frequencies into the available channels of the bank(s) you select. For more information about your scanner's search feature, see *Searching* on page 30.

- Press **MANUAL** to stop scanning.
- Using your keypad, enter the lower frequency of your search range. For example, enter 155.000 MHz.



- Press **LIMIT**.
- Using your keypad, enter the higher frequency of your search range. For example, enter 157.000 MHz.



- Press **LIMIT**.
- Press **AUTO**.

All the banks begin flashing and AUTO displays.



- Select the bank(s) you want programmed during *AutoStore*.

The bank indicators selected will stop flashing.

If you select a bank with no available channels, FULL displays for two seconds before your scanner resets. You must either delete frequencies in the bank or select a different bank.



8. Press **SRC** to start *AutoStore*.

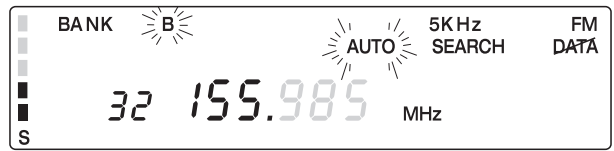

You can press **▲** to change the step increment during *AutoStore*.

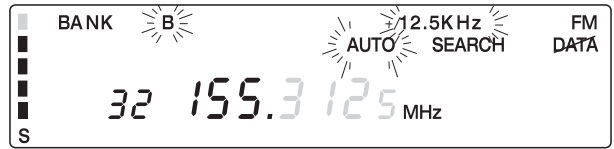

Press **▲** until you select the increment you want. If you select the default step increment for the frequency band you're searching, the indicator stops flashing.

AutoStore stops automatically when all available channels in the selected bank(s) have been programmed.



9. Press **MANUAL** to exit *AutoStore* and return to the manual mode.

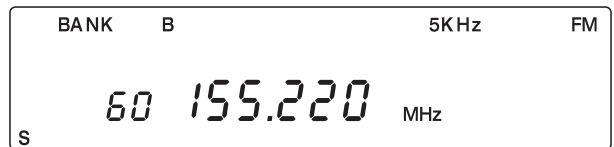

Note: If you want to exit *AutoStore* before all the available channels are programmed, you must press **MANUAL** twice.

Transferring a Programmed Frequency

Except for frequencies stored in priority channels, you can send any frequency to another channel by following these steps.

You cannot transfer a frequency which is stored in a priority channel. **Error** will flash for two seconds and then your scanner resets. If you want to transfer the frequency stored in a priority channel, you must designate another channel in the bank as the priority channel. For more information about Changing a Priority Channel, see page 26.



1. Select the channel with a frequency you want to assign to a different channel.

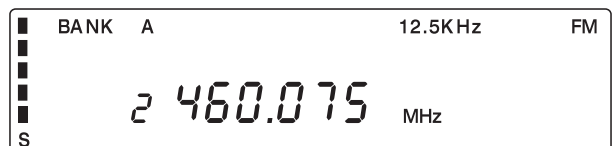

2. Press **SEND**.

All the bank indicators start flashing. If you have programmed CTCSS tones, they also display when you press **SEND**.



Use these steps to transfer to the first available channel in another bank:

3. Select the bank where you want to send the frequency.

For example, press **D**.

The bank's lowest available channel begins flashing, waiting to be programmed.



4. Press **E** to transfer the frequency to the new channel.

The old channel is now empty.



5. To cancel the transfer before it's complete, press either **SEND** or **MANUAL**.

Use these steps to transfer to a specific channel:

3. Using your keypad, enter the channel where you want to send the frequency.

For example, press **9** **4**.

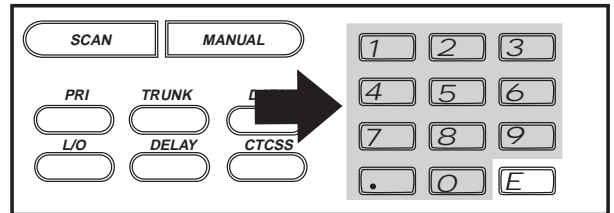

4. Press **HOLD**.

The display will alternate between the frequency you're transferring and the frequency in the new channel. If the channel you select is not programmed, then only the new channel number will flash.



AND

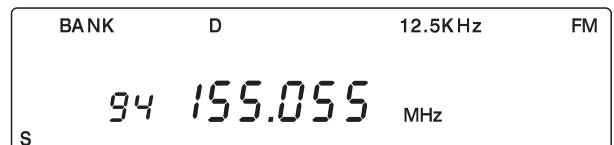

- Press **E** to complete the transfer.

The frequency is now stored in the new channel, and the old channel is empty.



- To cancel the transfer before it's complete, press either **SEND** or **MANUAL**.

Duplicate Frequency Alert

If you enter a frequency which is stored in another channel, you hear a beep and the other channel displays.

Press **.** to start again

— or —

Press **E** again to store the frequency in both channels.

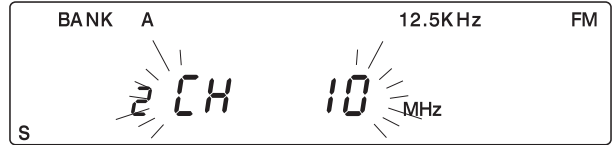

Deleting a Stored Frequency

To delete a stored frequency:

- Press **0**.
- Then press **E**.

Channels with no frequencies are automatically locked out.

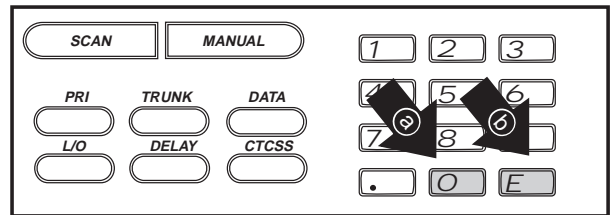

Preventing Accidental Programming

You can prevent the accidental programming of your scanner by setting the Lock feature. To prevent the programming of your scanner, follow these steps:

- Set the switch labeled **ENTER LOCK** on the rear panel of your scanner to the **ON** position.
- When lock is set, the **E** and **AUTO** keys are disabled. If these keys are pressed, an error message flashes for two seconds, and your scanner resets.

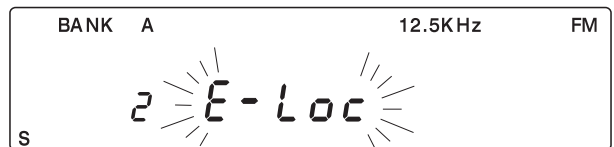

- To return to normal operation, set the switch to the **OFF** position.

Programming Tips

- Do not program a weather frequency into one of the channels, since weather channels transmit continuously.
Use **WX** to select the weather information band.
- Group similar frequencies into adjacent channels.
For example, program police frequencies in channels 1 through 10 and fire/emergency into channels 11 through 20, and so on.
- Put the frequency that you listen to the most or the most important frequency into a Priority channel.
- To quickly program a series of channels, start with the lowest number channel.
For example, when you are programming five new frequencies into Channels 4 through 8, start with Channel 4. After you finish programming a channel, press **MANUAL** or **HOLD** to go to the next higher channel.
- Record channels and frequencies in some convenient place in case the scanner memory is lost.

Scanning

- After programming frequencies, simply press **SCAN** to begin scanning.



- The bank indicators, A – J, selected for scanning appear in the display, while the bank being currently monitored flashes. You can deselect banks from active scanning by pressing their number on your keypad. The indicator for each deselected bank turns off, and the bank's channels are not scanned.

Note: One Bank must always be active. You cannot deactivate all ten banks at the same time. If you try to turn all the banks off, the first bank is automatically selected.

To restore a bank to active scanning, press the bank's number on your keypad. The bank's indicator will display again.

- During normal scanning the scanner skips unprogrammed or locked out channels.

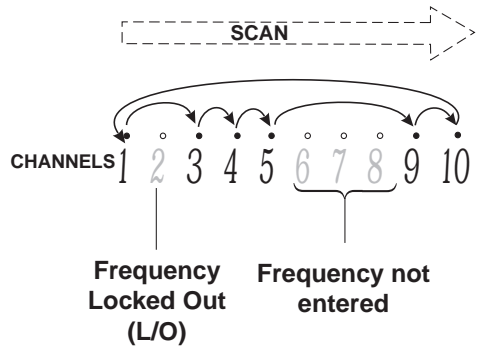

- When a transmission is received, the Scanner stops on that channel. When the transmission ends, scanning resumes automatically.



- Press **MANUAL** to stop on a channel during scanning.

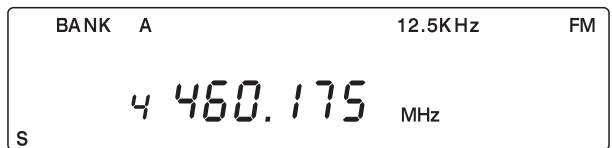

- Press **SCAN** to resume scanning.

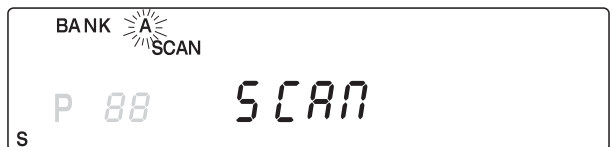

To directly access a specific channel:

1. Press **MANUAL**.
2. Use your keypad to enter the channel number you want.
3. Press **MANUAL** again.

Setting the Delay Mode

A delay can be set for each programmed channel so that when Scan or Search stops on a channel there is a brief pause before the scanning cycle resumes. Delay must be set for each programmed channel, and it can be set when your scanner pauses during a scan or when manual mode is selected.

To set Delay in Scan or Search Mode:

1. Press **SCAN** or set a search range and press **SRC**.



2. When your scanner stops on a channel, press **DELAY**.

DELAY displays and scanning will resume two seconds after the transmission ends.



To set Delay in Manual Mode:

1. Press **MANUAL**.

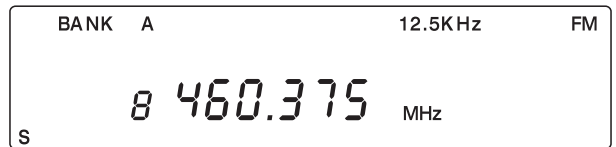

2. Select the channel you want using your keypad or Rotary Tuner.

3. Press **DELAY**.

DELAY displays indicating the scanner will pause on the channel when a transmission is received.



Channel Lockout

You can lockout any channel so it is not reviewed during normal scanning. You can restore the channel to scanning whenever you wish.

Lockout in Manual Mode

1. Press **MANUAL**.
2. Select a channel.
 - a. Enter the channel number.
 - b. Then press **MANUAL** again.

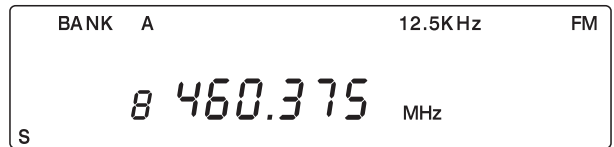
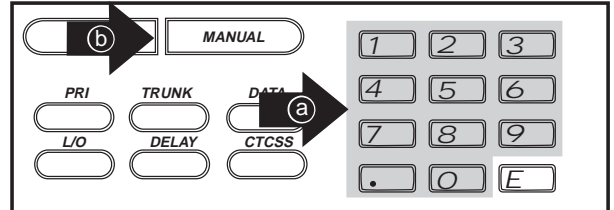

3. Press **L/O** to lockout the channel.

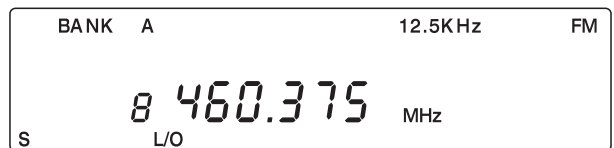

Lockout in Scanning Mode

If the scanner keeps stopping on a particular channel due to noise or too frequent transmissions, you may want to keep that channel from scanning.

1. Wait until the scanner stops at the channel.
2. Then press **L/O**.
3. The scanner immediately resumes scanning because the locked out channel is no longer in the scanning sequence.

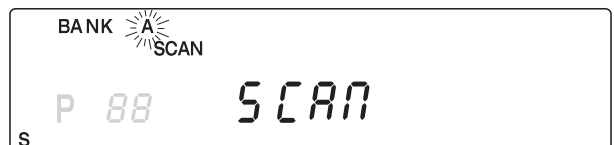
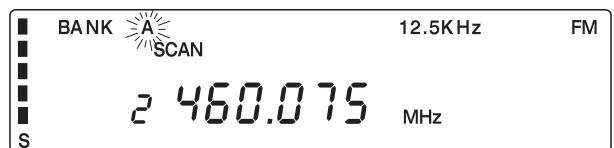

Lockout Tips

- To quickly lockout a series of channels, start with the lowest number channel.
For example, if you are locking out channels 4, 7, 8, 12, and 15, start with Channel 4. After selecting channel 4, press **L/O**. Then press **MANUAL** one or more times to step up to the next channel to be locked out.
- Record the locked-out channels in some convenient place so you can restore them.

Restoring a Locked Out Channel

1. Press **MANUAL**.
2. Select a locked out channel.
 - a. Enter the channel number.
 - b. Then press **MANUAL** again.

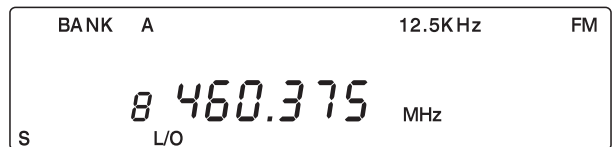
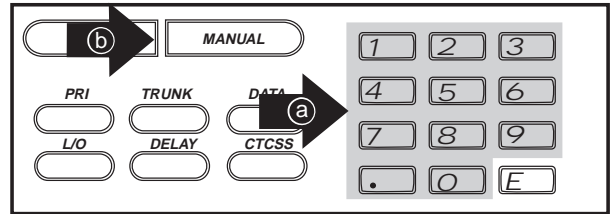

3. Press **L/O** to unlock the channel.

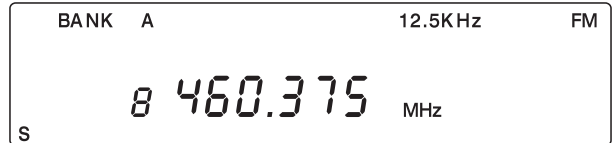

Restoring All Locked-Out Channels

You can restore all locked-out channels in a bank only when a bank is selected for scan. If you have deselected a bank and you want to restore all of its locked-out channels using the steps below, you must press **SCAN** and then press the number of the bank on your keypad.

1. Press **MANUAL**.

Note: You must be in Manual mode before restoring all locked-out channels.

2. Press and hold **L/O** for about two seconds.

You will hear two beeps when all the channels have been restored.

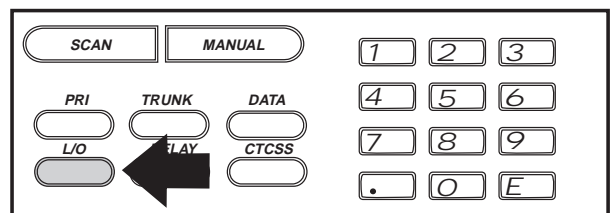

Priority Scan

When Priority Scan is turned on, your scanner checks the priority channel every two seconds for activity. If a signal is present on the priority channel, your scanner monitors the channel until the transmission ends, then resumes normal scanning. You can designate one channel in each bank as a Priority Channel.

To activate Priority Scan (in either the Manual or Scan Mode):

1. Press **PRI**.



Note: If you have locked out the priority channel, this message appears when you select Priority mode.



2. Press **PRI** again at anytime to deactivate Priority Scan.

Changing the Priority Channel

You cannot eliminate the Priority Channel, but you can change it to any of the 30 available channels in each bank.

1. Press **MANUAL**.
2. Select a new Priority Channel.
 - a. Enter the channel number.
 - b. Then press **MANUAL** again.

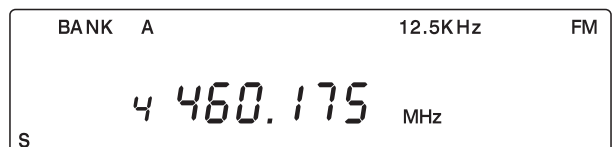
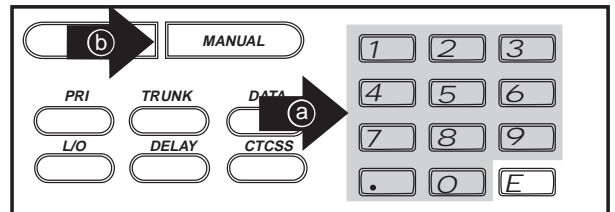

- Press and hold **PRI** for two seconds to designate this channel as your new Priority Channel.

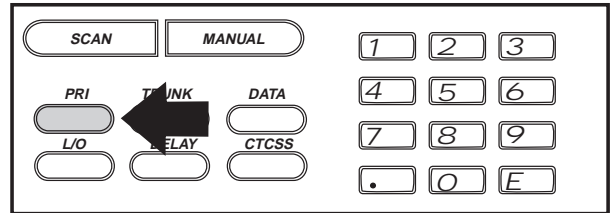

Two beeps indicate that the Priority Channel is changed.

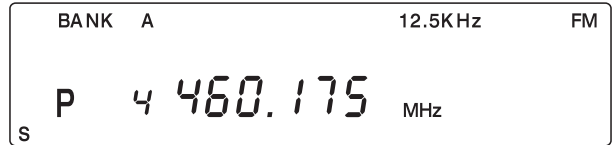

Tape Recording Channel Communication

You can set any channel for recording while scanning. Then, if your scanner stops on a channel you have designated for recording, the transmission and its time, as well as the channel number and frequency, are all recorded.

However, before you can use this feature, you must connect a tape recorder to your scanner. For information about attaching a recorder to your scanner, see *For use with an optional tape recorder* on page 11.

To program a channel for tape recording:

- Use your keypad or Rotary Tuner to select the channel you want recorded.
- Press **AUX**.

LINE displays indicating that the channel will be recorded if you've connected a tape recorder to your scanner.

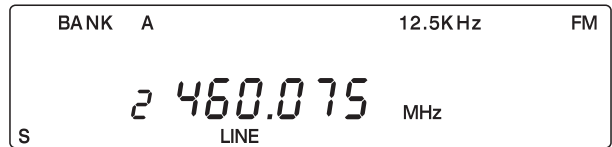

Repeat these steps to select other channels for recording.

To record a channel, press **SCAN**. When your scanner stops on a channel which displays **LINE**, the channel is recorded.

To turn the record feature off for a channel:

- Use your keypad or Rotary Tuner to select the channel you do not want to record anymore.
- Press **AUX**.

LINE turns off and the channel will not be recorded.

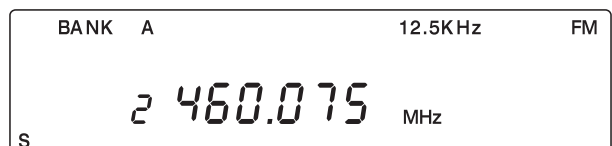

Weather Channel Scanning

The **BC895XLT** allows you to search for your local NOAA weather channel.

1. Press **WX** to find an active weather channel in your area.

WX displays.



2. Press **SCAN** or **MANUAL** to exit the Weather Mode.

WX turns off.



It is possible that you will receive more than one weather station in your area. When you press **WX**, your scanner finds the first active broadcast. If a broadcast seems weak or distant, press **WX** again to find another station which is clearer.

Note: *Weather scan does not resume automatically. You must press **WX** again to start the weather scan again. In some parts of the country, you may not be able to monitor weather broadcasts, such as in low-lying areas. Normally a higher location will improve the reception.*

Weather Alert

In Weather Alert Mode, your scanner functions as a severe weather warning radio. This is especially useful when your area is expecting severe weather conditions late at night. When you set the scanner to Weather Alert Mode, it emits a loud siren whenever your local NOAA weather station broadcasts a severe weather emergency tone.

To use Weather Alert:

1. Press **WX** to find your local weather broadcasting station.

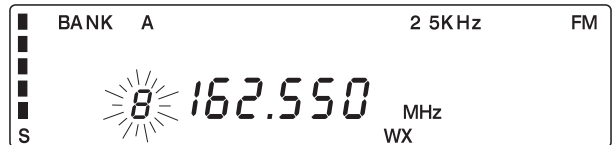

2. Press **ALRT/RMT**.

Your scanner's volume is muted until the warning tone sounds.

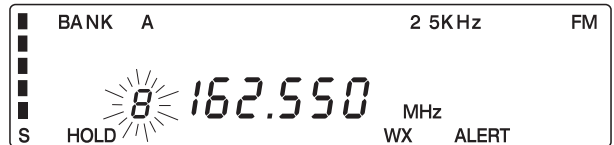

Your scanner now functions as a Weather Alert radio, waiting to receive a severe weather emergency tone. When your scanner receives the emergency tone from your local NOAA weather station, it responds with a loud siren at **maximum** volume (regardless of the volume control setting). The siren will continue until the emergency tone stops transmitting.

To cancel the siren, press either **ALRT/RMT** or **WX**.

Testing the Weather Alert Siren

To test the Weather Alert siren to ensure it's working or to hear how it sounds, follow these steps:

1. Press **WX**.

2. Press **ALRT/RMT**.

ALERT displays and your scanner's volume is muted.



3. Press and hold **PRI** for 2 seconds.

You will hear two short beeps, and then the test siren will begin to sound.

4. To cancel the siren, press either **ALRT/RMT** or **WX**.

ALERT turns off and you will hear the weather broadcast for your area.

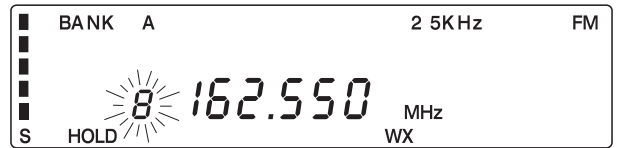

Note: If you use **WX** to cancel the siren, then **HOLD** does not display.

Searching

Setting a Search Range

The *BC895XLT* can search a specific frequency range to find frequencies if you don't have a frequency guide available or if new stations have been added since your guide was published.

1. Press **MANUAL** to stop scanning.
2. Using your keypad, enter the lower frequency of your search range. For example, enter 155.000 MHz.
3. Press **LIMIT**.
4. Using your keypad, enter the higher frequency of your search range. For example, enter 157.000 MHz.
5. Press **LIMIT**.
6. Press **SRC**.

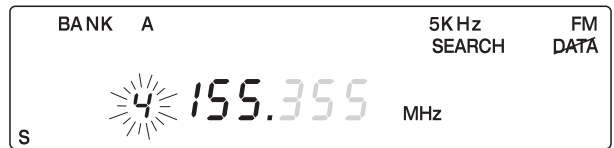

You can press **▲** to change the step increment during a Search.

*Press **▲** until you select the increment you want. If you select the default step increment for the frequency band you're searching, the indicator stops flashing.*

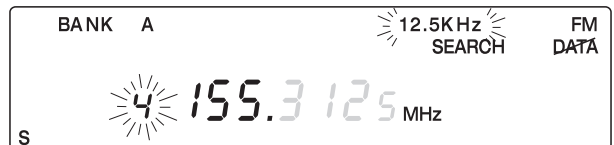

Search Hold Feature

1. Press **HOLD** at anytime to stop the search.

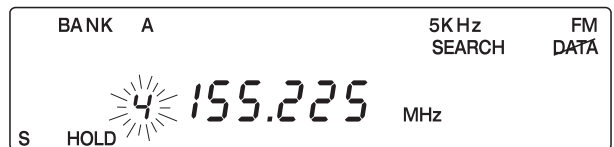

- Press **HOLD** to move to the next higher frequency

— or —

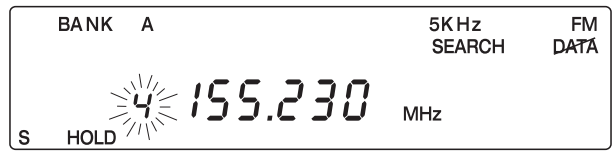

- Press **LIMIT** to move down to the previous frequency.

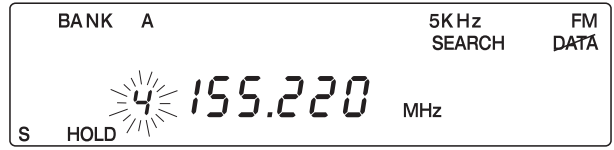

Note: You can also use the Rotary Tuner to move to other frequencies, just make sure that **FREQ** is selected before turning the dial.

- Press **SRC** to resume searching.

Data Skip

A scanner will normally stop on any transmission it receives. This means the **BC895XLT** will stop on data signals and unmodulated transmissions. You can automatically skip many of these types of transmissions during searches.

- Press **DATA** to activate the data skip feature.

The **DATA** indicator appears on the display.



- Press **DATA** again to cancel the data skip feature.

The **DATA** indicator disappears from the display.

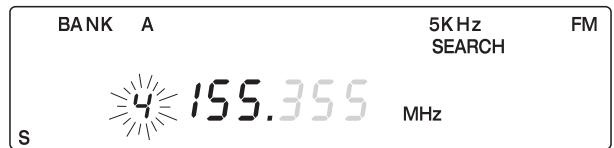

When data skip is active, your scanner may pause momentarily on an unwanted signal but will resume searching in 2 or 3 seconds.

Channel Skip

If a particular channel continues to interrupt search scanning, it is possible to set your scanner to skip the frequency.

To skip a frequency, press **L/O**.

Note: You can program up to 20 skip frequencies. The 21st skip frequency entered causes the first skipped frequency to unlock.

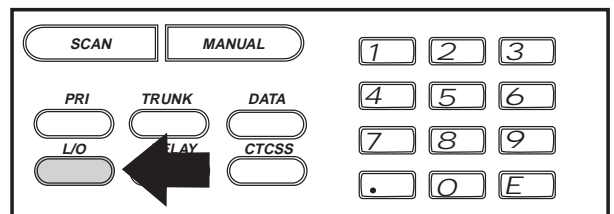

Storing Search Frequencies

You can quickly store any frequency you find during Search.

1. Press **MANUAL**.
2. Using your keypad, enter the lower frequency of your search range. For example, enter 155.000 MHz.



3. Press **LIMIT**.
4. Using your keypad, enter the higher frequency of your search range. For example, enter 157.000 MHz.



5. Press **LIMIT**.
6. Press **SRC**.

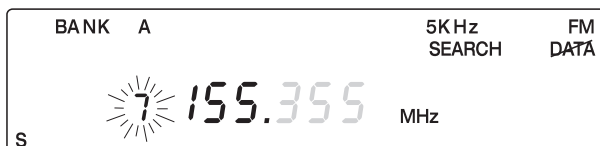

7. Press **HOLD** when the scanner stops at the frequency you want.



Note: You can press **HOLD** to step up a frequency, or press **LIMIT** to step down a frequency. Press and hold either key to rapidly step through the frequencies. You can also use the Rotary Tuner to step through frequencies, just make sure **FREQ** is selected before turning the dial.

8. Press **E** to store the frequency in the channel flashing on your display



— or —

Send the frequency to another channel.

For information about sending a frequency to another channel, see *Transferring a Programmed Frequency* on page 18.

9. Press **MANUAL** or **SCAN** to cancel Search.
10. Repeat steps 6 through 8 for all the Search frequencies you want to store.

CTCSS Operation

Your scanner is equipped with a Continuous Tone Control Squelch System (CTCSS) which allows squelch to open when the tone you have programmed with a specific frequency is received along with a transmission. When using CTCSS, consider the following:

- You do not have to use CTCSS tones while scanning.
- You cannot enter CTCSS tones in the AM Air Band.
- If you have more questions about CTCSS, see *What is CTCSS* on page 5.

Programming a Channel with a CTCSS Tone

1. Select a channel you want to program.



2. Enter a frequency.
 - a. Use your keypad to enter the frequency you want.
 - b. Then press **[E]**.

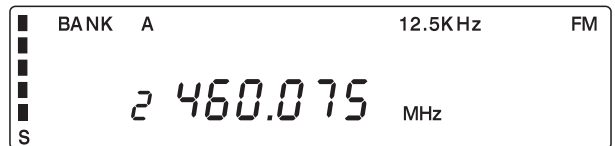
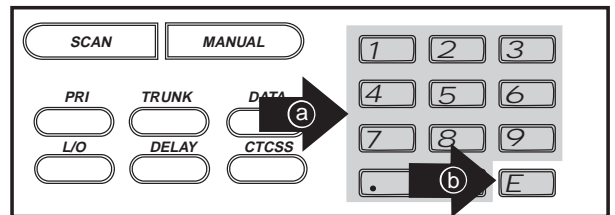

3. Press **[CTCSS]**, and then press **[E]**.

*If CTCSS Mode is already selected, then only press **[E]**.*

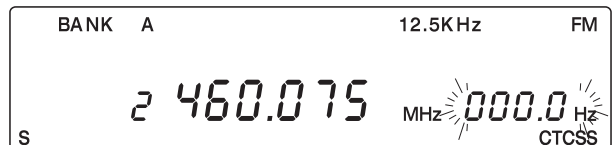

4. Enter a tone.
 - a. Use your keypad, Rotary Tuner, or **[HOLD]** and **[LIMIT]** to select the tone.
 - b. Then press **[E]**.

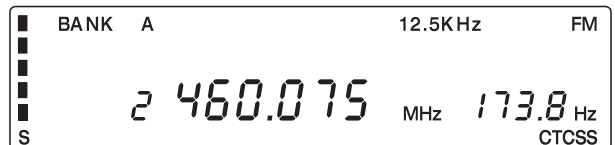

Note: *If you make a mistake while entering a tone with you keypad, press **[.]** twice and enter the tone again. If you're using the Rotary Tuner, make sure that **FREQ** is selected.*

5. Press **[CTCSS]** to cancel the CTCSS Mode.

The CTCSS indicator and displayed tones are turned off but not deleted.

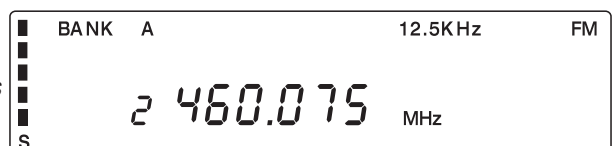

Searching for CTCSS Tones

You can use the CTCSS Tone Search Mode to determine if the frequencies in your area are broadcast with associated tones. You may find frequencies which do not have a tone associated with them. This may be because CTCSS tones are not being transmitted or because digital encoded tones, sometimes called DCS, are used and your scanner does not recognize these.

Using CTCSS Tone Search While Scanning

1. Press **[SCAN]**.



2. To determine if a stored frequency has an associated CTCSS tone, press **[MANUAL]** when your scanner stops on a channel.

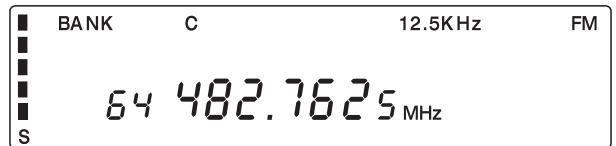

3. Press and hold **[CTCSS]** until you hear two short beeps.

CTCSS displays and begins flashing, and the scanner starts searching for an associated CTCSS tone. All 38 tones are checked if the transmission is long enough. If there is a break before a tone is identified, then your scanner starts searching where it left off when the transmission begins again.

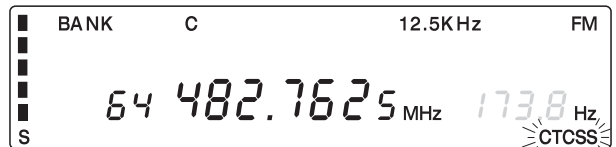
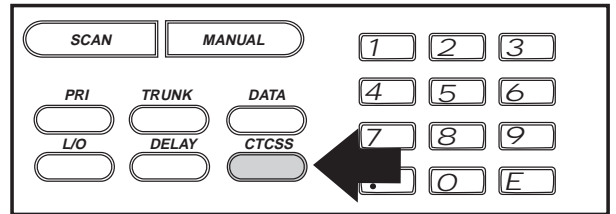

If a CTCSS tone is found, the tone begins flashing in the display.

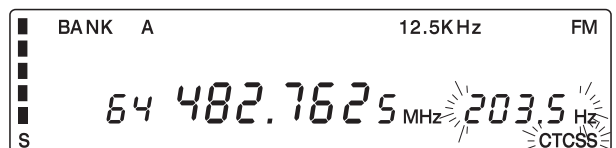

4. Press **[E]** to program the tone with the frequency stored in the channel.

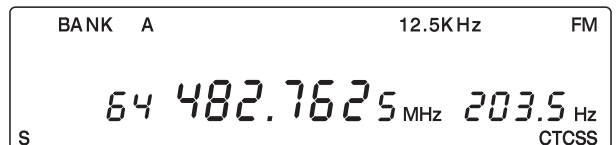

5. Repeat Steps 1 – 4 to search for tones associated with other stored frequencies.

If you want to program tones for several stored frequencies, follow these steps:

- After you program a CTCSS tone with a stored frequency, the CTCSS Tone Search Mode is canceled. The **CTCSS** indicator remains on but does not flash. To activate the CTCSS Tone Search Mode again, press and hold **(CTCSS)** until you hear two short beeps.

If you decide to cancel the CTCSS Tone Search Mode while scanning, press and hold **(CTCSS)** until you hear two short beeps and the **CTCSS** indicator turns off.

- You can select the CTCSS Search Mode before pressing **(SCAN)**. Simply, press and hold **(CTCSS)** until the **CTCSS** indicator begins flashing, and then press **(SCAN)**.

When your scanner stops, the CTCSS Tone Search begins immediately. If a tone is found before the transmission ends, press **(E)** to program the tone with the frequency stored in the channel.

Using CTCSS Tone Search While Searching

1. Set a Search Range.

For information about setting a search range, see Setting a Search Range on page 30.

2. Press **(SRC)**.

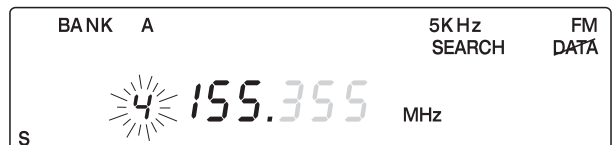

3. Press and hold **(CTCSS)** until you hear two short beeps.

CTCSS begins flashing in display.

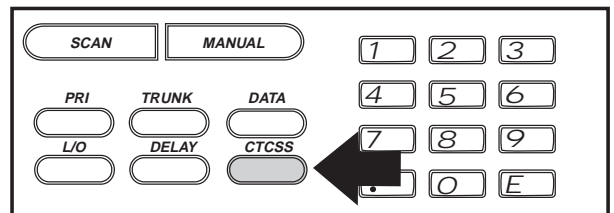

*The scanner starts searching for an associated CTCSS tone when it stops on a transmission. All 38 tones are checked if the transmission is long enough. However, if you press **(HOLD)**, and there is break before a tone is identified, the tone search starts where it left off when the transmission begins again.*

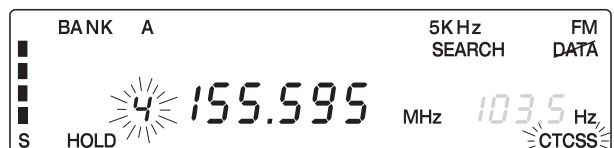

- If a CTCSS tone is found, the tone begins flashing in the display.

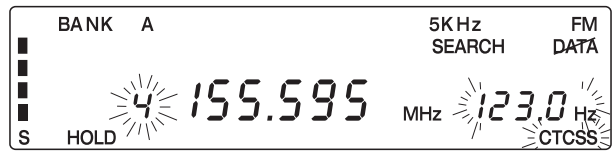

- Press **[E]** to program the tone with the frequency stored in the channel.

— or —

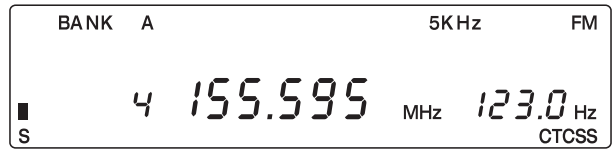

Send the frequency with its associated tone to another channel.

For information about sending a frequency to another channel, see Transferring a Programmed Frequency on page 18.

- Repeat Steps 2 – 4 to search for tones associated with other frequencies in the search range you set in Step 1.

If you want to program tones for several frequencies during your search, follow these steps:

- After you program a frequency and a CTCSS tone into a channel, the CTCSS Tone Search Mode is canceled. To activate the CTCSS Tone Search Mode again, press and hold **[CTCSS]** until you hear two short beeps.
- If you decide to cancel the CTCSS Tone Search Mode while you are searching for frequencies, press and hold **[CTCSS]** until you hear two short beeps and the **CTCSS** indicator turns off.

Changing a CTCSS Tone

- Press **[CTCSS]** to activate the CTCSS mode.
- Select the channel you want to change.

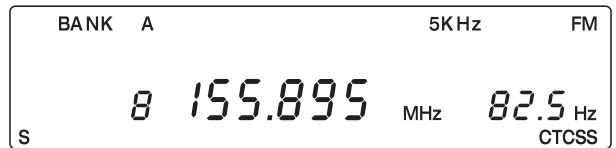

- Press **[E]**.

The CTCSS tone begins flashing.

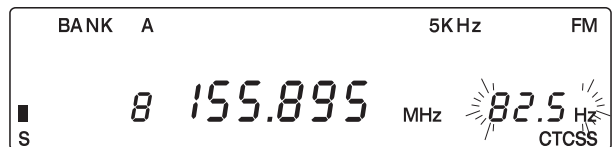

- Enter the new CTCSS tone using your keypad or the Rotary Tuner.

*If you make a mistake while using your keypad, press **[.]** twice and enter the tone again, or if you're using your Rotary Tuner, make sure **FREQ** is selected.*

- Press **[E]** to change the CTCSS tone.



Erasing a CTCSS Tone

- Press **[CTCSS]** to activate the CTCSS mode.
- Select the channel with the CTCSS tone you want to erase.

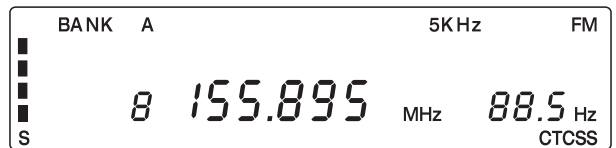

- Press **[E]**.

The CTCSS tone begins flashing.

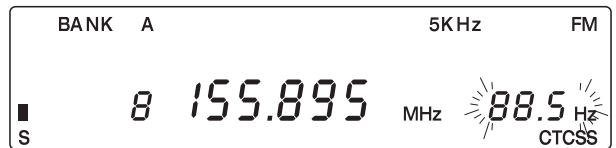

- Press **[0]** or use your Rotary Tuner to select **000.0**

*If you choose the wrong key, press **[.]** twice, or if you're using your Rotary Tuner, make sure **FREQ** is selected.*

- Press **[E]** to erase the CTCSS tone.

The CTCSS tone is removed, and the CTCSS icon remains on.

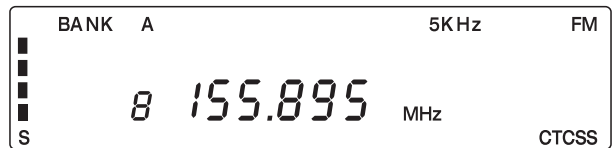

CTCSS Tone Frequencies (Hz)

000.0	⇒	67.0	71.9	74.4	77.0	79.7	82.5	85.4	88.5	91.5
94.8	97.4	100.0	103.5	107.2	110.9	114.8	118.8	123.0	127.3	131.8
136.5	141.3	146.2	151.4	156.7	162.2	167.9	173.8	179.9	186.2	192.8
203.5	210.7	218.1	225.7	233.6	241.8	250.3	←	000.0		

Trunk Tracking

Your **BC895XLT** is designed to track Motorola Type I, Type II, Type III, Hybrid, *SMARTNET™*, and *PRIVACY PLUS™* analog trunking systems*, which are extensively used in 800 MHz communication systems. When tracking these types of systems, you may want to remember these important points:

- Your scanner defaults to monitor Type II systems; however, you can change this if the system in your area is different. (The types of systems are discussed below.)
- Your scanner cannot track an 800 MHz trunked system and scan frequencies in conventional mode at the same time.
- The frequencies for many of the 800 MHz public safety systems are listed in the *TrunkTracker™: National Public Safety Trunked System Frequency Guide* included with your **BC895XLT** scanner.

* *Motorola*, *SMARTNET*, and *PRIVACY PLUS* are trademarks of Motorola Inc.

Types of Trunking Systems

Trunking systems divide a few frequencies among many different users, but the way that each system does this is slightly different. There are really two basic types which are important when using your *TrunkTracker™* scanner. These are usually referred to as Type I and Type II systems.

One important distinction between these two systems is the amount of data transmitted by each radio when its push-to-talk button (PTT) is pressed. Every radio in a trunked system is assigned a unique ID so the central site computer can identify it when it's used. Both Type I and Type II systems place radios (or radio users) into groups, called talk groups, and these talk groups are also assigned unique IDs. Some radios have access to only one talk group, while others have access to many talk groups. Which talk group(s) each radio can access is called the radio's affiliation(s).

In a Type II system, when someone uses their radio, only the radio ID is transmitted when PTT is pressed, whereas in a Type I system the radio ID and its current affiliation are both transmitted when PTT is pressed.

Why the difference? Type II systems are slightly more advanced because the central computer maintains a database which is used to determine each radio's affiliation(s). Changes to a Type II system are easier than Type I because the system manager only need update the database instead of reprogramming individual radios.

Another difference between the systems is that Type I systems are arranged in a Fleet-Subfleet hierarchy. For example, it's possible for a city using a Type I system to designate 4 Fleets, each with 8 Subfleets. Their fleets might be the Police Department, the Fire Department, Utilities, and Administration. The Police may decide to further divide their fleet into subfleets such as Dispatch, Tactical Operations, Detectives, North, South, East and West Side Patrols, and Supervisors. All the available police radios would then be assigned to one of the police subfleets. Determining the exact Fleet-Subfleet hierarchy for a particular area is referred to as Fleet Map Programming.

The disadvantage of a Type I system is that when PTT is pressed, the brief burst of data must contain the radio's ID and its Fleet and Subfleet. This is three times the amount of data a Type II system radio sends, and as a result Type I systems usually accommodate fewer users than Type II systems.

Even though there are many Type II systems, Type I systems are still in use. There are also Hybrid systems which are a combination of both Type I and Type II. Your scanner defaults to monitor Type II systems, but it's possible to select a Preprogrammed Fleet Map or create a Custom Fleet Map for your area.

Setting the Squelch

Since Squelch is automatically adjusted in trunking mode, it isn't necessary to manually adjust the squelch control while trunk tracking. However, the squelch setting you select before you begin trunk tracking can affect how fast your scanner acquires the data channel, and, in some instances, the squelch setting can prevent your scanner from acquiring the data channel at all.

Set **SQUELCH** in this position before selecting a trunking bank.

Note: You can change this recommended setting, if necessary, to provide better performance in your area.

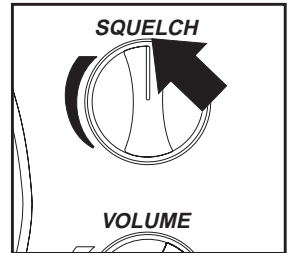

Programming Trunking Frequencies

Before you start programming your scanner to track a trunked system, consider the following:

- You can only program one trunking system in each bank of your scanner.
- Trunking frequencies must be entered while in the Trunking Programming mode.
- If you're in the Trunking Programming mode, you cannot select channels in other banks.

For example, if you are programming Bank D, you can only select channels 91-120 with the Rotary Tuner or using the **HOLD** or **LIMIT** keys.

The first step in tracking a trunked system is storing the frequencies in one of the 10 available banks in your scanner.

1. Press and hold **TRUNK**.

You will hear two beeps, and **BANK** and **TRUNK** will begin to flash in the display.

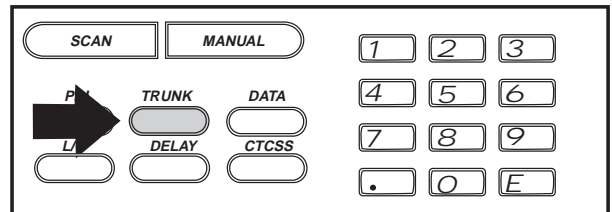

2. Choose the bank you want to trunk track. For example, press **B**.
3. Use the keypad to enter a frequency for the trunked system.

For example, enter *856.2625*, or enter a frequency of the system you're going to track.

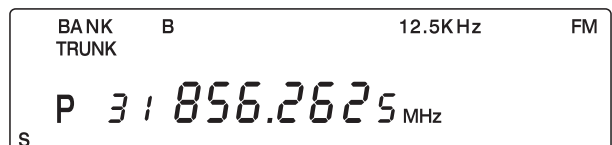

Then press **E**.

Note: To clear a mistake while entering a frequency, press ***** twice, and start over.

If you enter a non-800 MHz trunked repeater output frequency, an error message displays for two seconds and then the scanner resets.



4. Press either **MANUAL** or **HOLD** to select the next channel in the bank.



5. Repeat steps 3 and 4 until all frequencies have been entered.

6. Press **SRC** to begin searching the bank you've programmed.



Note: You will see the frequencies quickly displaying as your scanner looks for the data channel which controls the system.

Searching a Trunked Bank

Before you Search a Trunked Bank with your scanner, consider the following:

- You can only trunk track one bank at a time.
- Use **TRUNK** to toggle between the conventional and the trunk tracking modes.
- Press **DATA** while in the Trunk Tracking mode to review which bank is currently in use. The appropriate bank icon will flash at the top of the display for 5 seconds.

If you have programmed frequencies for a trunked system in one or more of the 10 available banks and you are in conventional mode, follow these steps to begin trunk searching:

1. Press **TRUNK**.

The bank indicators begin to flash.



2. Use the alpha keys to select the trunked bank you want.

For example press **B**.



Note: You will see the frequencies quickly displaying as your scanner looks for the data channel which controls the system.

Once the data channel is acquired, the scanner begins trunk tracking. Talk group ID's, which represent different service groups, begin to display.

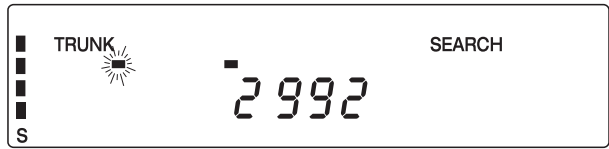

3. Press **TRUNK** again to return to conventional scanning mode.

While searching, you won't know exactly who the IDs are assigned to until you listen awhile or until ID lists are available in frequency guides or on internet sites. However, it usually only takes a few minutes to figure out police, fire, and emergency medical personnel. Other IDs may take some time, but determining who each ID represents is half the fun of **TrunkTracker™**.

ID Hold Mode

During Search mode, you can hold on an ID without entering it into memory.

1. Press **HOLD** while in Search mode.



2. Use the keypad to enter the ID you want.

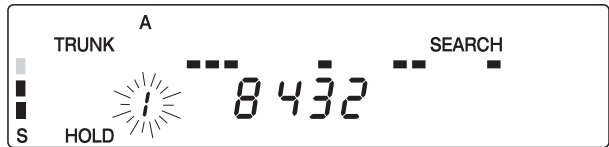

3. Press **HOLD** again.

HOLD flashes in the display.



4. Press **SRC** to return to Search mode.

Note: *The ID Hold mode works in Scan List mode, and the steps are the same; however, **SEARCH** doesn't appear in the display.*

ID Lockout

Like conventional scanning, it's possible to lockout unwanted traffic. This is particularly important in trunked systems because in many areas water meters, door alarms, traffic signals, and other mechanical devices are assigned IDs just like other users. Also some departments scramble or encrypt their communications, and you may want to lock out these unintelligible broadcasts.

To lockout an ID, press **L/O** when the ID displays.

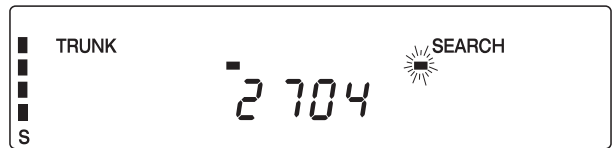

The ID is locked out, and the next active ID displays. You can lockout up to 100 IDs.

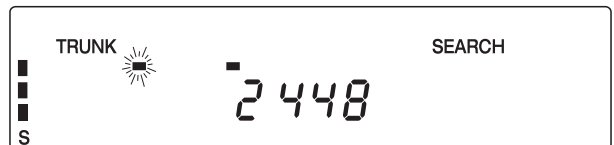

Note: If you lockout an ID in Search mode, it is also locked out in Scan List mode. Conversely, if you lockout an ID while in Scan List mode, it is locked out in Search mode. For information about Scan Lists, see page 45.

Restoring a Single ID

To unlock a single ID, follow these steps:

1. Press and hold **L/O** until you hear two short beeps.
2. Use either the Rotary Tuner or the **HOLD** or **LIMIT** to select the ID you want to unlock.
3. Press **L/O**.

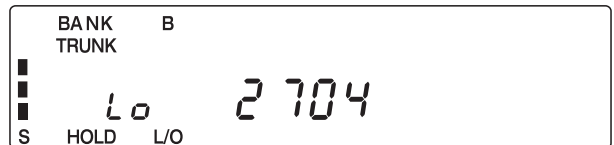

The ID is unlocked and the next locked ID displays.

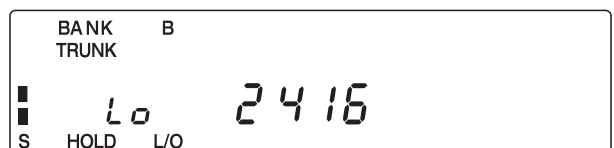

4. Press **SRC** to return to the Search mode.

Restoring all IDs

To unlock all locked out IDs at once, follow these steps:

1. Press and hold **[L/O]** until you hear two short beeps.
2. Press **[E]** to unlock all the IDs at once.

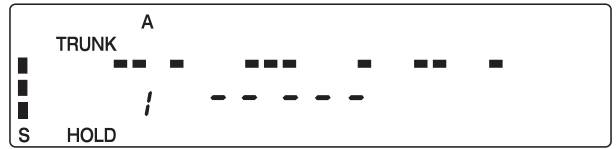

Note: If you unlock all the IDs, then the Scan List Memory mode displays. Press **[SCAN]** to scan the IDs stored in your Scan Lists or press **[SRC]** to return to the Search mode. For information about Scan Lists, see page 45.

3. Press **[SRC]** to return to the Search mode.

Searching Tips

ID Delay Mode

- Use the **[DELAY]** key to select the Delay mode if it's not active. This mode holds an ID for 5 seconds while you wait for a reply. Other groups may use the system, but your scanner will only look for the ID in the display.



Note: If you consistently miss responses while in ID Delay mode, you may need to change the default system type or change the fleet map you're using.

Hold Mode

- Press **[HOLD]** to hold on a particular ID in the display. This is where the trunk tracking effect is really noticeable. You can hold a specific talk group, such as fire department on-scene operations, no matter which frequency the group uses.



ID Monitor Mode

- If you press and hold **[SRC]** until you hear two short beeps, you will select the ID Monitor mode. **SEARCH** begins flashing in the display, and all active talk group IDs begin to display in succession. You won't hear conversations in this mode, but this is an excellent way to determine which talk groups are the most active.



Note: Locked out IDs display during ID Monitor mode with the L/0 icon turned on.

Channel Activity Indicators

The *BC895XLT* has 30 Channel Activity Indicators to visually display a trunked system's activity when you select delay, hold, scan etc. You'll always know which frequencies are in use and how much communication traffic is occurring.

Each frequency you program in a trunking bank corresponds to an activity indicator on your scanner's display. The way in which the Activity Indicators display provide you with information about the system you're tracking.

- The indicator which remains on, even when there is no traffic, represents the frequency being used as the data channel.
- If an indicator turns on and you don't hear a conversation, then the channel is probably being used for a telephone interconnect call or a private call. These calls are not monitored by your scanner.
- The indicator which flashes when an ID displays represents the frequency being used by the talk group.
- If you're holding on an ID which isn't active, the activity indicators will turn on and off as other groups use the system.

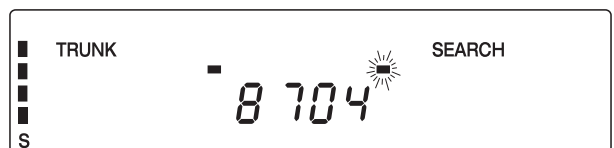
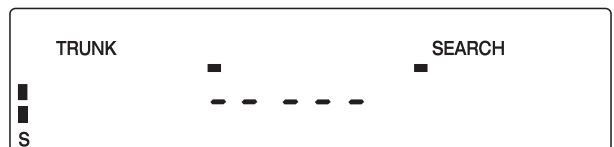
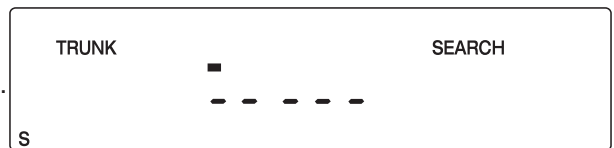

Scan Lists

Each bank of your *BC895XLT* can be a trunk tracking bank, or it can be a conventional scanning bank. When you designate a bank as a trunking bank, your scanner sets up 5 Scan Lists (A–E), which are simply lists used to store your favorite IDs. Each list can contain up to 10 IDs, so you can store a total of 50 IDs for each trunk tracking bank (500 if you use all banks as trunking banks!).

Scan Lists help you organize the trunking system users into categories. For example, you might use List A for police IDs, List B for fire department IDs, List C for emergency medical service IDs, etc. Once IDs are stored in lists, you can scan them like you scan conventional frequencies. You can program your scan lists either manually or during trunking search mode.

You can use the VFO Tuner to scroll through the IDs in your scan lists.

Programming Scan Lists Manually

1. Select the Trunking bank you want.



2. After the scanner begins trunk tracking, press **MANUAL**.

3. Use either the Rotary Tuner or the **HOLD** and **LIMIT** to select the Scan List location you want to program. For example, select the second memory location in the first scan list.

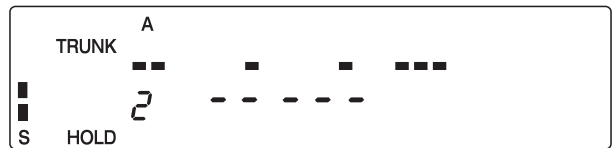

4. Enter the Type II ID you want to store, and press **E**.

—or—

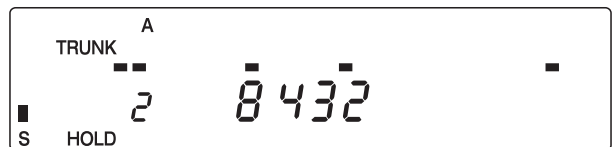

To enter a Type I ID:

- a. Enter the fleet number.
- b. Press **.**
- c. Enter the subfleet number, and press **E**.

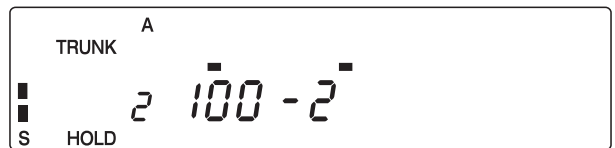

Note: If the trunking bank is set to monitor Type II systems, you cannot enter Type I IDs. To clear a mistake while entering an ID, press **.** twice, and start over.

5. Press **MANUAL** or **HOLD** to select the next Scan List location.

- Press **[SCAN]** to begin scanning the lists you have programmed.

*If you haven't programmed any IDs, **SCAN** displays but your scanner cannot stop on an active conversation.*



- To remove a Scan List from active scanning, press the number of the Scan List on your keypad.

The Scan List indicator turns off, and the IDs in that list are not scanned.

Note: One Scan List must always be active. If you try and deactivate all the Scan Lists, Scan List A will automatically be active.



- To restore a Scan List to active scanning, press its number again.



- Press **[SRC]** to return to Trunk Tracking Search mode.

Programming Scan Lists During Search

To select a Scan List location and store an ID during Search mode, follow these steps:

- When your scanner stops on an ID you want to store, press **[PRI]**.
- Use either the Rotary Tuner or the **[HOLD]** or **[LIMIT]** to select the Scan List memory location you want, then press **[E]**.
- Press **[SRC]** to return to Trunk Tracking Search mode.

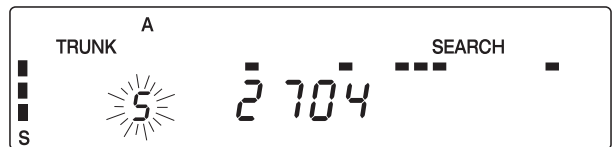

To let your scanner automatically store an ID in an available Scan List location, follow these steps:

1. Press **E** when your scanner stops on an ID you want to store.

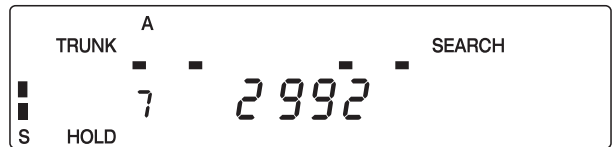

2. Press **SRC** to return to Trunk Tracking Search mode.

Deleting a Stored ID

To delete a stored ID:

- a. Press **O**.
- b. Then press **E**.

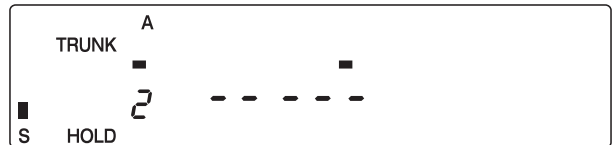

Fleet Map Programming

If you have programmed a trunk tracking bank and select **[SRC]**, you will see user IDs display on your screen. Since your scanner defaults to monitor Type II systems, most if not all IDs appear as even numbers. However, if you notice an even mix of odd and even user IDs, for example 6477, 2560, 6481, 6144, 1167, etc., then you are probably monitoring either a Type I or Hybrid system. See *Types of Trunking Systems* on page 38.

You may also notice that you're missing responses when you hold on an active ID. Unlike Type II systems, Type I/III systems require a Fleet Map that sets specific Fleet-Subfleet parameters. It's easy to select a Fleet Map for your scanner; what isn't always easy is selecting or programming a map that matches your particular area.

There are 16 preset Fleet Maps listed in the appendix that you can choose, and these are usually a good place to start when setting up a Type I/III trunk tracking bank. If you choose a preset map and still have difficulty following complete conversations, then you'll have to program your own Fleet Map.

Selecting Trunking Programming Mode

To change the system type which your scanner monitors, you must be in the Trunking Programming mode. To select this mode, follow these steps:

If you are in Conventional Scan mode:

1. Press and hold **[TRUNK]**.

*You'll hear two short beeps and **BANK** and **TRUNK** will begin to flash in the display.*



2. Select the trunking bank you want to program.

If you are in Trunking Scan mode:

1. Press **[TRUNK]** to return to conventional mode if you have been monitoring a trunking bank.

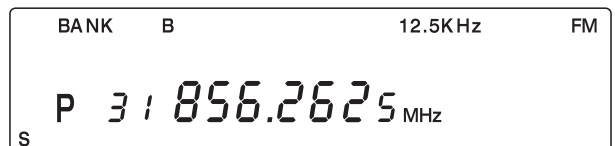

2. Press and hold **[TRUNK]** until you hear two short beeps.

*You'll hear two short beeps, and **BANK** and **TRUNK** will begin to flash in the display.*



3. Select the trunking bank you want to program.

Selecting a Preset Fleet Map

1. Select the Trunking Programming mode and the bank you want to change.

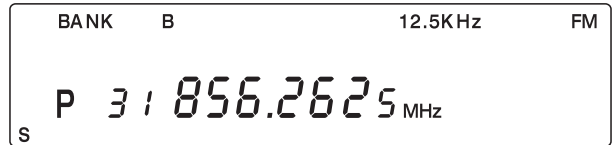

2. Press **DATA**.
3. Use **HOLD** or **LIMIT** to choose **E1**.

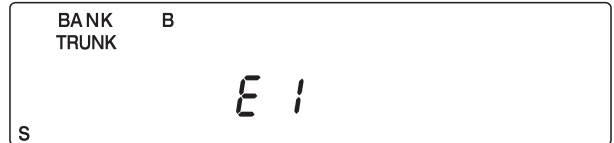

4. Press **DATA**.
5. Use **HOLD** or **LIMIT** to choose the map you want. For example, **E1P1**.

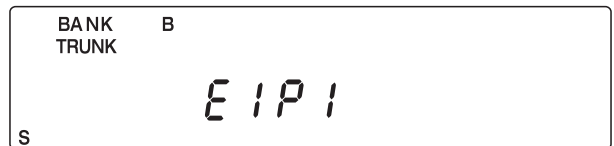

6. Press **E**.

The scanner exits the Trunking Programming mode, acquires the data channel, and begins searching using the preset map you chose.

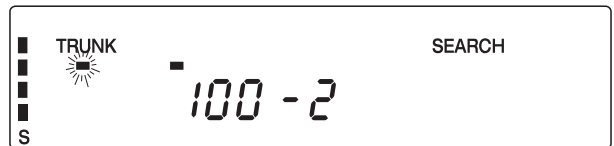

Note: You will now begin to see Type I Fleet-Subfleet IDs. For example, 100-12, 100-9, 000-12, 400-8, etc. See *User Defined Fleet Maps in the Appendix* for more information about Type I IDs.

How do you know if the preset map is correct? You'll have to listen to see if you're following complete conversations. If not, you should try another preset map.

Programming a Fleet Map

You may want to read *User Defined Fleet Maps in the Appendix* before programming a fleet map. It contains a detailed explanation of Scanner Fleet Map Programming, as well as a table listing the Fleet Map Size Codes.

1. Select the Trunking Programming mode and the bank you want to change.

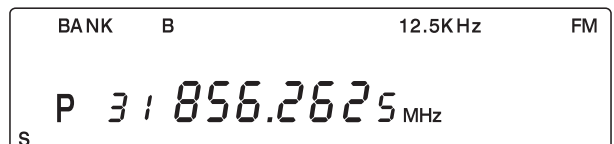

2. Press **DATA**.
3. Use **HOLD** or **LIMIT** to choose **E1**.

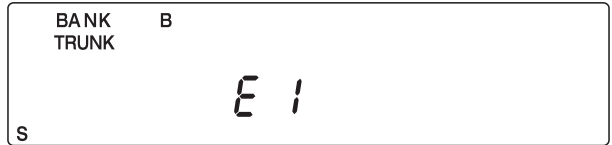

4. Press **DATA**.
5. Use **HOLD** or **LIMIT** to choose **USr**.

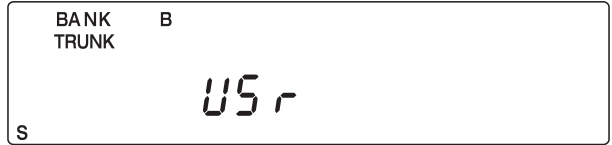

6. Press **DATA**.
7. Use **HOLD** or **LIMIT** to select the size code for the first block.

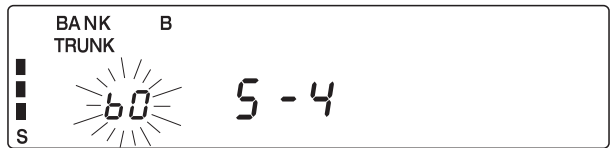

8. Press **E**.
- The next available block displays.*

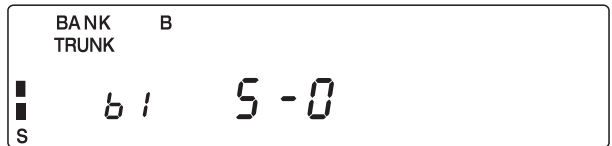

9. Repeat Steps 7 and 8 until you have selected a size code for each block.

For specifics about each size code, see Fleet Map Size Codes in the Appendix.

10. Press **SRC**.

The scanner exits the Trunking Programming mode, acquires the data channel, and begins searching using the map you've programmed.

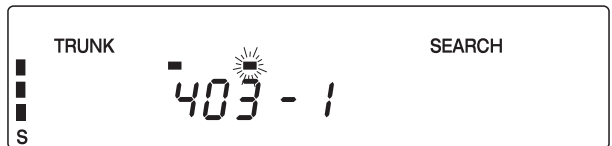

Restoring Default Tracking

Your scanner is set to monitor Type II systems as its default. However, if you select a preset fleet map or program your own fleet map, then you'll change the default setting. To reset the Type II default for a trunking bank, follow these steps:

1. Select the Trunking Programming mode and the bank you want to change.

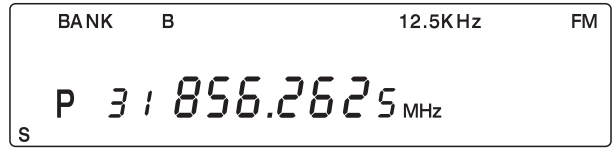

2. Press **DATA**.
3. Use **HOLD** or **LIMIT** to choose **E2**.

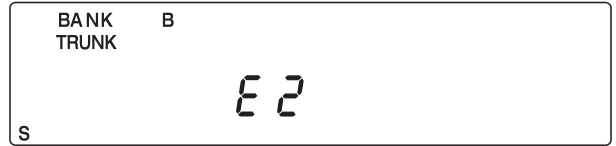

4. Press **E**.

The scanner exits the Trunking Programming mode, acquires the data channel, and begins searching.

Note: *Your scanner saves the setting for the preset map you selected or the Type I fleet map you programmed. If you decide to select **E1** for the bank again, the last settings used will display.*

Programming a Hybrid System

A Hybrid system is simply a Type I system with some blocks designated as Type II blocks. To program a Hybrid system, follow the steps listed in Programming a Fleet Map in the previous section. However, if you want a block to be Type II, select Size Code S-0.

When you begin searching a trunking bank with a Hybrid Fleet Map, you will see both types of system IDs. That is, Type II IDs usually appear as an even number without a dash; Type I IDs appear as a three or four digit number, followed by a hyphen, followed by a one or two digit number. See page 58 for more information.

General Use

- Turn the scanner off before disconnecting the power or replacing the batteries.
- Always write down the programmed frequencies in the event of memory loss.
- If memory is lost, simply reprogram each channel. The display shows 000.000 in all channels when there has been a memory loss.
- Always press each button firmly until you hear the entry tone for that key entry.

Location

- Do not use the scanner in high-moisture environments such as the kitchen or bathroom.
- Avoid placing the unit in direct sunlight or near heating elements or vents.
- If the scanner receives strong interference or electrical noise, move it or its antenna away from the source of the noise. If possible, a higher elevation may provide better reception. Also try changing the height or angle of the antenna.

Cleaning

- Disconnect the power to the unit before cleaning.
- Clean the outside of the scanner with a mild detergent. To prevent scratches, do not use abrasive cleaners or solvents. Be careful not to rub the LCD window.
- Do not use excessive amounts of water.

Repairs

- Do not attempt any repair. The scanner contains no user serviceable parts. Contact the Uniden Customer Service Center or take it to a qualified repair technician.

Birdies

- All radios can receive “birdies” (undesired signals). If your scanner stops during Scan mode and no sound is heard, it may be receiving a birdie. Birdies are internally generated signals inherent in the electronics of the receiver.

Press **L/O** to lockout the channel, and then press **SCAN** to resume scanning.

Troubleshooting

If your *BC895XLT* is not performing properly, try the following steps.

Problem	Suggestion
Scanner won't work.	<ol style="list-style-type: none">1. Check the connections at both ends of the AC Adapter.2. Turn on the wall switch of your room. You could be using an outlet controlled by the wall switch.3. Move the AC Adapter to another wall outlet or replace the battery pack.
Improper reception.	<ol style="list-style-type: none">1. Check the antenna connection or move and reposition the antenna.2. Move the scanner.3. You may be in a remote area which could require an optional multi-band antenna. Check with your dealer or local electronics store.
Scan won't stop.	<ol style="list-style-type: none">1. Adjust squelch threshold — refer to <i>Setting the Squelch</i> on page 13,2. Check the antenna connection.3. Check to see if many of the channels are locked out. If so, the scanner has less chance of finding an active channel.4. Review each channel's frequency to see if it is still stored in memory and is correct.5. It's possible that none of the programmed frequencies are currently active.
Scan won't start.	<ol style="list-style-type: none">1. Press the SCAN key again.2. Adjust the SQUELCH control.3. Check to see if all channels are locked out.
Weather Scan won't work.	<ol style="list-style-type: none">1. Adjust squelch threshold – refer to page 13, <i>Setting the Squelch</i>.2. Check the antenna.

If you experience difficulty while in **TrunkTracker™** mode, try the following steps.

Problem	Suggestion
Scanner won't track the trunked system.	<ol style="list-style-type: none"> 1. May not be a system which can be tracked by your scanner. 2. Missing the data frequency. 3. Change to a Type 1 Scanner setup. Review Fleet Map Programming on page 48.
Scanner won't stop during Scan List mode.	<ol style="list-style-type: none"> 1. No IDs have been programmed. 2. The IDs you have stored are not active.
Scanner will not acquire data channel.	<ol style="list-style-type: none"> 1. Adjust the squelch for trunking mode. See page 39. 2. Missing the frequency used for the data channel. Check your frequency list.
Missing replies to conversations.	<ol style="list-style-type: none"> 1. Change to a Type 1 Scanner setup. Review Fleet Map Programming on page 48. 2. Try another Preset Fleet Map or Program your own Fleet Map. 3. Check to see that all of the systems frequencies have been entered.
Channel Activity Indicators are flashing but no sound is heard.	<ol style="list-style-type: none"> 1. May be a private or telephone interconnect call, which are intentionally blocked by your scanner. 2. The ID in your display is not active.

If you still cannot get satisfactory results while using your scanner or if you want additional information, please call or write the Uniden Parts and Service Division. The address and phone number are listed in the Warranty at the end of this manual. If you would like immediate assistance, please call Customer Service at (800) 297-1023.

If you have internet access, you can visit www.uniden.com for additional information.

Specifications

Certified in accordance with FCC Rules and Regulations Part 15, Subpart C, as of date of manufacture.

Channels:	300
Banks:	10 (30 channels each)
Service Bands:	7 – preprogrammed search bands (including the NOAA Weather Service band)
Frequency Range:	29.0–29.7 MHz 10 Meter Amateur Band 29.7–50.0 MHz VHF Low Band 50.0–54.0 MHz 6 Meter Amateur Band 137–144 MHz Military Land Mobile 144–148 MHz 2 Meter Amateur Band 148–174 MHz VHF High Band 216–225 MHz VHF High Band Above bands in 5 kHz steps 108–137 MHz Aircraft Band 225–400 MHz UHF Air Band 400–420 MHz Federal Government 420–450 MHz 70 cm Amateur Band 450–470 MHz UHF Standard Band 470–512 MHz UHF “T” Band 806–956 MHz “800” Band Above bands in 12.5 kHz steps
Operating Temperature:	–20°C to +60°C
Scan Rate:	100 channels per second (conventional mode)
Search Rate:	300 steps per second
Scan Delay:	2 seconds
Audio Output:	1.8W nominal into 8Ω internal speaker
Power Requirements:	12 VDC 500mAh (internal battery or AD140U AC Adapter)
Antenna:	50 ohms (Impedance)
External Jacks:	Antenna Jack BNC Type Ext. Speaker Jack 3.5mm Line Out Jack 3.5mm AUX Jack RCA Type DC Power Jack 5.5mm Remote Jack 5 Pins
Size:	10 ¹ / ₂ in. (W) x 7 ³ / ₈ in. (D) x 3 ¹ / ₂ in. (H)
Weight:	3.8 lbs

Features, Specifications, and Availability of optional accessories are all subject to change without notice.

Optional Accessories

Contact your local Uniden Dealer or call the Uniden Parts Center at: (800) 554-3988, 8:00 AM to 5:00 PM EST, Monday through Friday, for information about ordering these optional accessories.

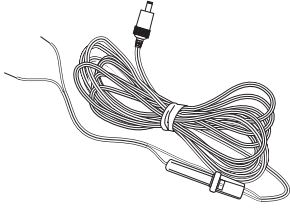

DC Power Cord

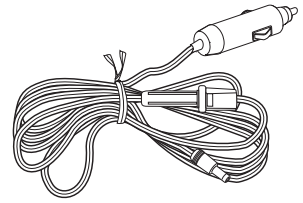

Cigarette Lighter Power Cord

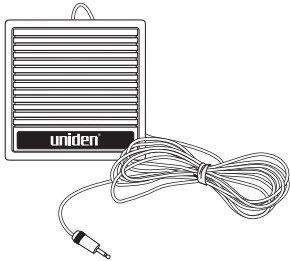

External Speaker

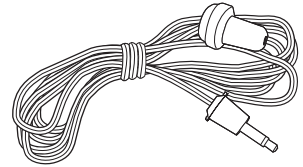

Earphone

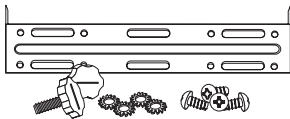

Mobile Mounting Bracket with Hardware (MB001)

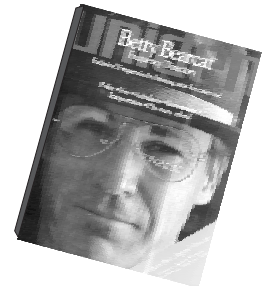

Betty Bearcat Frequency Directory/Local Directories

Appendix

Preset Fleet Maps

Preset Map E1P1

Block	Size Code
0	S11
1	S11
2	S11
3	S11
4	S11
5	S11
6	S11
7	S11

Preset Map E1P2

Block	Size Code
0	S4
1	S4
2	S4
3	S4
4	S4
5	S4
6	S4
7	S4

Preset Map E1P3

Block	Size Code
0	S4
1	S4
2	S4
3	S4
4	S4
5	S4
6	S12
7	--

Preset Map E1P4

Block	Size Code
0	S12
1	--
2	S4
3	S4
4	S4
5	S4
6	S4
7	S4

Preset Map E1P5

Block	Size Code
0	S4
1	S4
2	S12
3	--
4	S4
5	S4
6	S4
7	S4

Preset Map E1P6

Block	Size Code
0	S3
1	S10
2	S4
3	S4
4	S12
5	--
6	S12
7	--

Preset Map E1P7

Block	Size Code
0	S10
1	S10
2	S11
3	S4
4	S4
5	S4
6	S4
7	S4

Preset Map E1P8

Block	Size Code
0	S1
1	S1
2	S2
3	S2
4	S3
5	S3
6	S4
7	S4

Preset Map E1P9

Block	Size Code
0	S4
1	S4
2	S0
3	S0
4	S0
5	S0
6	S0
7	S0

Preset Map E1P10

Block	Size Code
0	S0
1	S0
2	S0
3	S0
4	S0
5	S0
6	S4
7	S4

Preset Map E1P11

Block	Size Code
0	S4
1	S0
2	S0
3	S0
4	S0
5	S0
6	S0
7	S0

Preset Map E1P12

Block	Size Code
0	S0
1	S0
2	S0
3	S0
4	S0
5	S0
6	S0
7	S4

Preset Map E1P13

Block	Size Code
0	S3
1	S3
2	S11
3	S4
4	S4
5	S0
6	S0
7	S0

Preset Map E1P14

Block	Size Code
0	S4
1	S3
2	S10
3	S4
4	S4
5	S4
6	S12
7	--

Preset Map E1P15

Block	Size Code
0	S4
1	S4
2	S4
3	S11
4	S11
5	S0
6	S12
7	--

Preset Map E1P16

Block	Size Code
0	S3
1	S10
2	S10
3	S11
4	S0
5	S0
6	S12
7	--

User Defined Fleet Maps

Type I Programming Information

When a Type I system is designed, the address information for all the IDs is divided into 8 equal sized blocks, numbered 0–7. When you program your scanner to track a Type I system, you must select a size code for each of these blocks. When you have assigned a size code to all 8 blocks, you'll have defined the Fleet Map for the system you're tracking. Each size code determines the number of Fleets, Subfleets, and IDs each block will have. For example, a size code of S-4 has one Fleet, which is divided into 16 separate Subfleets, and it has a total of 512 individual IDs.

When a block is assigned a size code, the Fleet or Fleets created within the block are assigned a Type I ID. The way these IDs display on your scanner depend on the block number and the block's size code. When a Type I ID displays, the leftmost digit represents the block which contains the ID. The next two digits identify which Fleet is active, and the last digit(s) identifies the Subfleet.

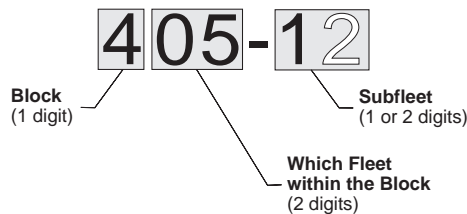

The details concerning how the size codes are selected by a Type I System designer are highly dependent on the specific needs of the system's users. Some organizations may want many subfleets with only a few radios each, while another organization may want only a few subfleets with many radios each. Your task is to program your fleet map with the same size code assignments as the trunked system. If you do this accurately, you'll track all the Fleet-Subfleet combinations used by the system. In other words, you'll hear complete communications while monitoring a trunked system.

If you don't already know the size codes used, you'll have to guess at them. But since you don't have to figure out all the blocks at once, this isn't as hard as it seems. Select a size code for a block, and then press **[SRC]**. Now listen to the communications. If you decide you are receiving most of the replies to the conversations with IDs assigned to the block you just programmed, then you've probably selected the right size code and can work on the next block of the map.

Finally, for most public safety systems there are some size codes which are more common. S-3 and S-4 are probably the most common, followed by S-10, S-11, and S-12.

Fleet Map Size Codes

Size	Fleets	Subfleets	IDs	Blocks Used
S-0	<i>Reserves block for Type II IDs</i>			
S-1	128	4	16	1
S-2	16	8	64	1
S-3	8	8	128	1
S-4	1	16	512	1
S-5	64	4	32	1
S-6	32	8	32	1
S-7	32	4	64	1
S-8	16	4	128	1
S-9	8	4	256	1
S-10	4	8	256	1
S-11	2	16	256	1
S-12	1	16	1024	2
S-13	1	16	2048	4
S-14	1	16	4096	8

Size Code Restrictions

If you select size code S-12, S-13, or S-14, there are some restrictions as to which blocks can be used for these codes.

- S-12 can only be assigned to Blocks 0, 2, 4, or 6.
- S-13 can only be assigned to Blocks 0 and 4.
- S-14 can only be assigned to Block 0.

Since these size codes require multiple blocks, you will be prompted for the next available block when programming a Fleet Map. For example, if you assign Block 0 as an S-12, you will be prompted for b2, the next block available, instead of b1. And if you assign Block 0 as an S-14, you would not see another prompt because it uses all available blocks.

Precautions

Before you use this scanner, please read and observe the following:

IMPORTANT!

The installation, possession, or use of this scanning radio in a motor vehicle may be prohibited, regulated, or require a permit in certain states, cities, and/or local jurisdiction. Your local law enforcement officials should be able to provide you with information regarding the laws in your community.

EARPHONE WARNING!

Be sure to use only the recommended optional monaural earphone (EP009). You may also use a 32 Ω stereo headset. Use of an incorrect earphone or stereo headset may be potentially hazardous to your hearing. The output of the phone jack is monaural, but you will hear it in both headphones of a stereo headset.

Set the volume to a comfortable audio level coming from the speaker before plugging in the monaural earphone or a stereo headset of the proper impedance (32 Ω). Otherwise, you might experience some discomfort or possible hearing damage if the volume suddenly becomes too loud because of the Volume Control or Squelch Control setting. This may be particularly true of the type of earphone that is placed in the ear canal.

WARNING!

Uniden **does not** represent this unit to be waterproof. To reduce the risk of fire or electrical shock, **do not** expose this unit to rain or moisture.

Uniden[®] and Bearcat[®] are registered trademarks of Uniden America Corporation.

BC895XLT Controls and Display

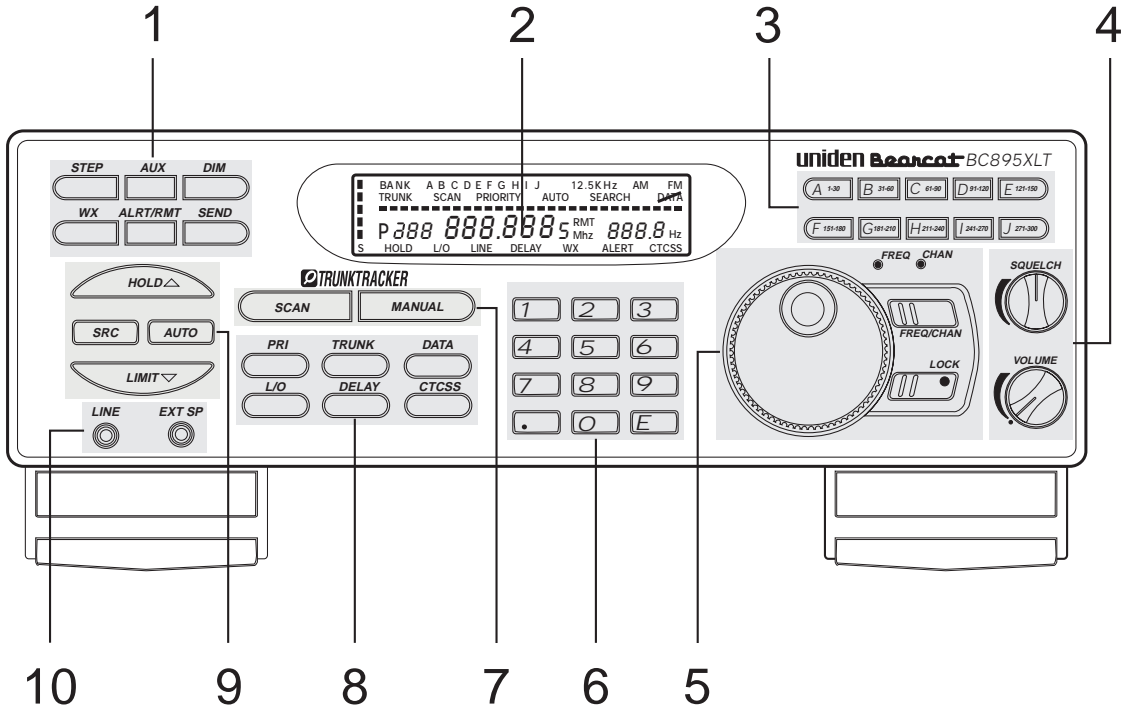

- | | |
|--------------------------------|---------------------------------|
| 1. Programming and Status Keys | 6. Numeric Keypad |
| 2. Display | 7. Scan/Manual Keys |
| 3. Bank Keys | 8. Mode Keys |
| 4. Squelch/Volume Controls | 9. Search Keys |
| 5. Rotary Tuning Control | 10. External Speaker/Line Jacks |

One Year Limited Warranty

Important: Evidence of original purchase is required for warranty service.

WARRANTOR: UNIDEN AMERICA CORPORATION (“Uniden”)

ELEMENTS OF WARRANTY: Uniden warrants, for one year, to the original retail owner, this Uniden Product to be free from defects in materials and craftsmanship with only the limitations or exclusions set out below.

WARRANTY DURATION: This warranty to the original user shall terminate and be of no further effect 12 months after the date of original retail sale. The warranty is invalid if the Product is (A) damaged or not maintained as reasonable or necessary, (B) modified, altered, or used as part of any conversion kits, subassemblies, or any configurations not sold by Uniden, (C) improperly installed, (D) serviced or repaired by someone other than an authorized Uniden service center for a defect or malfunction covered by this warranty, (E) used in any conjunction with equipment or parts or as part of any system not manufactured by Uniden, or (F) installed or programmed by anyone other than as detailed by the Operating Guide for this product.

STATEMENT OF REMEDY: In the event that the product does not conform to this warranty at any time while this warranty is in effect, warrantor will repair the defect and return it to you without charge for parts, service, or any other cost (except shipping and handling) incurred by warrantor or its representatives in connection with the performance of this warranty. **THE LIMITED WARRANTY SET FORTH ABOVE IS THE SOLE AND ENTIRE WARRANTY PERTAINING TO THE PRODUCT AND IS IN LIEU OF AND EXCLUDES ALL OTHER WARRANTIES OF ANY NATURE WHATSOEVER, WHETHER EXPRESS, IMPLIED OR ARISING BY OPERATION OF LAW, INCLUDING, BUT NOT LIMITED TO ANY IMPLIED WARRANTIES OF MERCHANTABILITY OR FITNESS FOR A PARTICULAR PURPOSE. THIS WARRANTY DOES NOT COVER OR PROVIDE FOR THE REIMBURSEMENT OR PAYMENT OF INCIDENTAL OR CONSEQUENTIAL DAMAGES.** Some states do not allow this exclusion or limitation of incidental or consequential damages so the above limitation or exclusion may not apply to you.

LEGAL REMEDIES: This warranty gives you specific legal rights, and you may also have other rights which vary from state to state. This warranty is void outside the United States of America.

PROCEDURE FOR OBTAINING PERFORMANCE OF WARRANTY: If, after following the instructions in this Operating Guide you are certain that the Product is defective, pack the Product carefully (preferably in its original packaging). Include evidence of original purchase and a note describing the defect that has caused you to return it. The Product should be shipped freight prepaid, by traceable means, or delivered, to warrantor at:

Uniden America Corporation
Parts and Service Division
4700 Amon Carter Boulevard
Fort Worth, TX 76155
(800) 297-1023, 8:00 a.m. to 5:00 p.m., Central, Monday through Friday

Covered under one or more of the following U.S. patents:

RE31,523 4,057,760 4,092,594 4,100,497 4,114,103
4,156,193 4,157,505 4,179,662 4,219,821 4,270,217
4,398,304 4,409,688 4,455,679 4,461,036 4,521,915
4,597,104 4,627,100 4,841,302 4,888,815 4,932,074
4,947,456 5,014,348 5,199,109 5,408,692 5,428,826
5,438,688 5,448,256 5,465,402 5,471,660 5,483,684
5,548,832 5,551,071

and other patents pending.

uniden®

Beancat®

©1997 Uniden America Corporation. All rights reserved.
Printed in the Philippines