

Uniden®

UBC800XLT
OWNER'S MANUAL

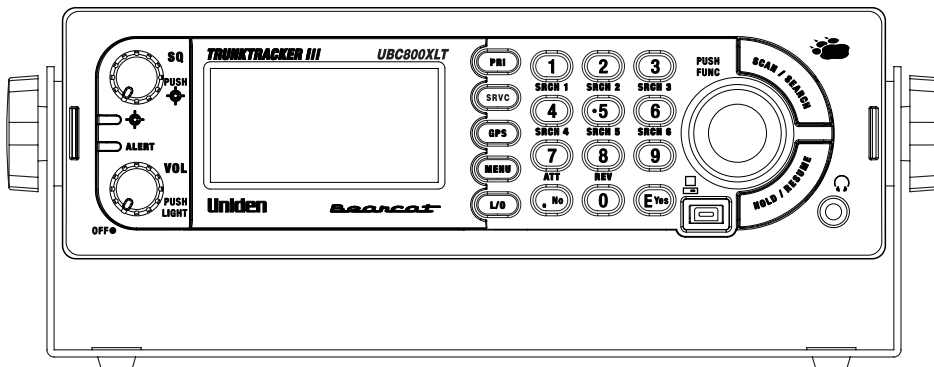

OWNER'S MANUAL

Precautions

Before use this scanner, please read and observe the following.

EARPHONE WARNING!

Be sure to use only a mono earphone with this scanner. You can also use an optional 32 ohms stereo headset. Use of an incorrect earphone or stereo headset might be potentially hazardous to your hearing. The output of the phone jack is monaural, but you will hear it in both headphones of a stereo headset.

Set the volume to a comfortable audio level coming from the speaker before plugging in the mono earphone or a stereo headset of the proper impedance (32 ohms). Otherwise, you might experience some discomfort or possible hearing damage if the volume suddenly becomes too loud because of the volume control or squelch control setting. This might be particularly true of the type of earphone that is placed in the ear canal.

WARNING!

Uniden **does not** represent this unit to be waterproof. To reduce the risk of fire or electrical shock, **do not** expose this unit to rain or moisture.

DPL[®], Digital Private Line[®], Motorola[®], PL[®], PRIVACY PLUS[®], Private Line[®], SMARTNET[®], and SMARTZONE[®] are registered trademarks of Motorola, Inc.

LTR[®] is a registered trademark of E.F. Johnson Co.

EDACS[®] is a registered trademark of M/A-COM Private Radio Systems Inc.

Uniden[®] and Bearcat[®] are registered trademarks of Uniden America Corporation.

Trunk Tracker[™], Trunk Tracking[™], and Close Call[™] are proprietary trademarks of Uniden America Corporation.

Other trademarks used throughout this manual are the property of their respective holders.

Power Related Issues

Important: To prevent memory from being corrupted, do not unplug the AC adapter during the time the memory is accessed for programming or auto store.

Notes:

- If when you connect the AC adapter the **[VOL] /Power Switch** is **ON**, the scanner may not power on. Should this occur, simply turn the control **OFF**, then **ON** again.
- If the scanner loses power (as when you turn off your car's ignition with the scanner's power switch on), it can lose some system settings such as display color and backlight. To ensure that such settings persist, either change the setting using the scanner's menu or power the scanner off then back on using the power switch after making such setting changes. When you turn off the scanner using the power switch, the scanner remembers the last settings and mode. When you turn power back on, it resumes the previous mode.

Precautions

3

Table of Contents

| | |
|---|-----------|
| Precautions | 2 |
| Power Related Issues | 3 |
| Table of Contents | 4 |
| Introduction | 9 |
| FEATURE SUMMARY | 10 |
| BAND COVERAGE | 10 |
| Feature Highlights..... | 13 |
| General | 13 |
| GPS..... | 15 |
| Search..... | 15 |
| Auto Store | 16 |
| Priority | 16 |
| PC Control and Cloning | 16 |
| Memory Storage Limits..... | 17 |
| Search Lockout Limits | 17 |
| About This Manual..... | 17 |
| Using the Scroll Control | 17 |
| How the Scanner's Controls Are Represented in This Manual | 18 |
| Entering Text Within A Menu Option..... | 18 |
| Understanding Scanning and the UBC800XL | 19 |
| Understanding the Scanner's Memory | 19 |
| Understanding Quick Keys | 19 |
| What is Scanning?..... | 20 |
| What is Searching?..... | 20 |
| What is CTCSS/DCS? | 20 |
| Conventional Scanning..... | 21 |
| Simplex Operation | 21 |
| Repeater Operation | 22 |
| What is Trunk Tracking?..... | 22 |
| Trunked Scanning..... | 23 |
| Types of Trunking Systems | 23 |
| Motorola Trunking | 23 |
| EDACS Trunking..... | 24 |
| LTR Trunking | 25 |
| Startup Configuration..... | 26 |
| Setup/Operation | 26 |
| Multi-Site Trunking..... | 26 |
| I-Call (Motorola/EDACS)..... | 26 |
| Where To Get More Information | 27 |
| Information On The Internet..... | 27 |

| | |
|--|-----------|
| Included With Your Scanner | 28 |
| Setting Up Your Scanner | 29 |
| Base Station | 29 |
| Setting Up an Audio Recording Device or Computer Recording | 31 |
| Vehicle Installation..... | 31 |
| Mounting Using the Bracket..... | 31 |
| Mounting Using the DIN-E Sleeve (Optional hardware)..... | 32 |
| Removing the Scanner from the DIN-E Sleeve..... | 34 |
| Mounting Using ISO Technique | 34 |
| Removing the Display Sticker | 35 |
| Connecting an Optional Antenna..... | 35 |
| Connecting an Earphone/Headphone | 35 |
| Connecting an Extension Speaker | 36 |
| Controls, Keys, and Functions | 37 |
| A Look At The Display | 42 |
| Operation | 43 |
| Turning On the Scanner and Setting the Squelch | 43 |
| Startup Key Operation | 43 |
| Conventional | 43 |
| Trunked | 43 |
| Search Range | 43 |
| Scanning Systems..... | 44 |
| Selecting Systems to Scan..... | 45 |
| Selecting System Channel Groups..... | 45 |
| Locking/Unlocking Systems..... | 45 |
| Locking/Unlocking Channels | 46 |
| ID Scan/ID Search Mode..... | 46 |
| Holding On a System..... | 46 |
| Holding On a Channel | 47 |
| Quickly Storing an ID During ID Search | 47 |
| Quick-Storing Channels or Talk Group ID's (TGID) | 47 |
| Trunking Activity Indicators..... | 48 |
| Toggling the Display Mode | 49 |
| Using the Menu | 50 |
| Programming General Settings | 51 |
| Setting and Using the Backlight..... | 51 |
| Setting the Dimmer | 51 |
| Adjusting the Key Beep | 52 |
| Setting the Audio AGC | 52 |
| Setting the Display Orientation | 52 |
| Adjusting the Display Contrast | 52 |
| Setting the GPS Format | 53 |
| Setting the Position Format..... | 53 |
| Setting the Time Format..... | 53 |
| Setting the Time Zone..... | 53 |
| Setting the Distance Units..... | 54 |
| Setting the Serial Port Speed | 54 |

Table of Contents

| | |
|---|-----------|
| Displaying Scanner Information | 55 |
| Viewing Memory Used | 55 |
| Viewing the Firmware Version | 55 |
| Initializing the Scanner's Memory | 55 |
| Connecting Your Scanner to a Personal Computer..... | 55 |
| Volume/Squelch with PC Control | 56 |
| Wired Cloning | 56 |
| Programming Your Scanner..... | 58 |
| System Settings | 59 |
| System Options..... | 59 |
| Site Settings | 61 |
| Channel Settings..... | 62 |
| Programming Conventional Systems | 62 |
| Programming Trunked Radio Systems | 63 |
| Programming System Settings | 63 |
| Editing the System Name..... | 63 |
| Specifying the Correct System Type..... | 64 |
| Programming System Options | 64 |
| Programming Sites | 71 |
| Programming Channel Groups | 77 |
| Setting Up a Channel Group | 77 |
| Editing a Channel Group Name | 77 |
| Setting the Group Quick Key..... | 78 |
| Editing Channels | 78 |
| Locking Out Channel Groups..... | 78 |
| Deleting Channel Groups..... | 79 |
| Programming Channels | 79 |
| Creating a Channel | 79 |
| Editing the Channel Name (Alpha Tag) | 79 |
| Editing Frequencies | 80 |
| Editing the Talk Group ID..... | 80 |
| Selecting CTCSS/DCS Tones..... | 81 |
| Quick CTCSS/DCS Save | 81 |
| Setting Channel Modulation Method | 82 |
| Setting Channel Attenuation | 82 |
| Setting Channel Priority | 83 |
| Setting Channel Alert | 83 |
| Setting Channel Record | 84 |
| Searching and Storing | 86 |
| Service Search | 86 |
| Quick Search | 87 |
| Custom Search | 87 |
| Editing a Custom Search Range | 88 |
| Search With Scan | 90 |
| Set Delay Time | 91 |
| Set Attenuator..... | 91 |
| Set Record..... | 91 |
| Assigning a Search Range to a Search Key..... | 91 |

| | |
|---|------------|
| Saving a Found Channel (Quick Save) | 92 |
| Auto Search and Store | 92 |
| Selecting a System to use for Storing | 92 |
| Conventional Search and Store | 92 |
| Trunked Search and Store | 93 |
| Using the Close Call Feature | 94 |
| Setting Close Call Options | 94 |
| Close Call Hits | 96 |
| Close Call Hits with Scan | 97 |
| Search and Close Call Options | 98 |
| Managing Locked-Out Frequencies | 98 |
| Unlocking All Frequencies | 99 |
| Reviewing Locked-Out Frequencies | 99 |
| Searching for Subaudible Tones | 99 |
| Screening Out Broadcast Sources | 99 |
| Setting the Maximum Auto Store Value | 100 |
| Setting the Modulation Type | 101 |
| Setting Attenuation | 101 |
| Setting Data Skip | 101 |
| Setting the Delay Time | 102 |
| Setting the Search Frequency Step | 102 |
| Setting Air Band Step | 103 |
| Setting Record | 103 |
| Priority Scan | 103 |
| Fire Tone-Out | 105 |
| Setting Tone-Out Standby | 105 |
| Setting Up Tone-Out | 105 |
| Tone-Out Multi-Channel Monitoring | 107 |
| Set Record | 107 |
| Using the UBC800XLT with a GPS | 108 |
| Device Compatibility | 108 |
| Connecting Your Scanner to a GPS Device | 108 |
| Initial Scanner/GPS Operation | 108 |
| Location-Based (GPS) Scanning | 109 |
| Non-Radio Location Based GPS Features | 109 |
| Setting the Options | 111 |
| Deleting a Location | 111 |
| For POI Only | 112 |
| For Dangerous Xing, and Dangerous Road Only | 112 |
| GPS Review Location Mode | 113 |
| Care and Maintenance | 115 |
| General Use | 115 |
| Location | 115 |
| Cleaning | 115 |
| Birdies | 115 |

Table of Contents

| | |
|--|------------|
| Troubleshooting | 116 |
| Other Specifications | 119 |
| Reference | 120 |
| Preset Fleet Maps | 120 |
| User Defined Fleet Maps | 122 |
| Type I Programming Information | 122 |
| Size Code Restrictions | 123 |
| CTCSS Frequencies | 124 |
| DCS Codes | 124 |
| Appendix | 125 |
| SERVICE SEARCH RANGES | 125 |
| Air | 125 |
| Marine | 125 |
| CB AM Radio | 126 |
| CB FM Radio | 132 |
| PMR | 137 |
| LPD | 138 |
| Index | 139 |
| Declaration of Conformity | 143 |

Introduction

Your UBC800XLT scanner is a state-of-the-art scanner radio with Trunk Tracker III™ and automatic scanning capabilities. You can store in the dynamic memory conventional frequencies such as police, fire/emergency, marine, air, amateur, and other communications. You can store and scan services that use Trunked Radio Systems and so much more. You can use the scanner's Scroll Control to quickly select channels and frequencies, and you can automatically program channels in a system using the Auto Store feature. Use your scanner to monitor:

- Analog trunked systems (unencrypted only)
- Police and fire departments (including rescue and paramedics)
- Business/Industrial radio and utilities
- Marine and amateur (ham radio) bands
- Air band
- Railroad

These table list the frequency ranges, default frequency step and default mode (AM or FM).

To select a band plan from 1,2 and 3;

1. Make sure the power is turned off.
2. While holding down 1,2 or 3 (corresponding number of the band plan) and Function knob, turn on the scanner.

FEATURE SUMMARY

BAND COVERAGE

< Band Plan 1 >

| Frequency (MHz) | | Modulation | Step (kHz) | Remark |
|-----------------|------------|------------|------------|----------|
| Lower Edge | Upper Edge | | | |
| 25.0000 | 29.9950 | FM | 5 | |
| 30.0000 | 79.9875 | FM | 12.5 | |
| 80.0000 | 82.9900 | FM | 10 | |
| 83.0000 | 87.2875 | FM | 12.5 | |
| 87.3000 | 107.9500 | FMB | 50 | |
| 108.0000 | 136.9875 | AM | 12.5 | AIR BAND |
| 108.0000 | 136.9916 | | / 8.33 | |
| 137.0000 | 137.9950 | FM | 5 | |
| 138.0000 | 157.9875 | FM | 12.5 | |
| 158.0000 | 160.5900 | FM | 10 | |
| 160.6000 | 162.5875 | FM | 12.5 | |
| 162.6000 | 173.9900 | FM | 10 | |
| 174.0000 | 215.9500 | WFM | 50 | |
| 216.0000 | 224.9950 | FM | 5 | |
| 225.0000 | 399.9750 | AM | 25 | |
| 400.0000 | 405.9875 | FM | 12.5 | |
| 406.0000 | 439.9937 | FM | 6.25 | |
| 440.0000 | 465.9950 | FM | 5 | |
| 466.0000 | 469.9900 | FM | 10 | |
| 470.0000 | 512.0000 | FM | 6.25 | |
| 806.0000 | 960.0000 | FM | 12.5 | |
| 1240.0000 | 1300.0000 | FM | 12.5 | |

< Band Plan 2 >

| Frequency (MHz) | | Modulation | Step (kHz) | Remark |
|-----------------|------------|------------|-------------------------|----------|
| Lower Edge | Upper Edge | | | |
| 25.0000 | 49.9950 | FM | 5 | |
| 50.0000 | 84.0100 | FM | 5 | |
| 84.0150 | 87.2950 | FM | 20 with 15kHz Offset | |
| 87.3000 | 107.9500 | FMB | 50 | |
| 108.0000 | 136.9875 | AM | 12.5 / 8.33 | AIR BAND |
| 108.0000 | 136.9916 | | | |
| 137.0000 | 143.9950 | FM | 5 | |
| 144.0000 | 145.9875 | FM | 12.5 | |
| 146.0000 | 155.9900 | FM | 10 | |
| 156.0000 | 157.4250 | FM | 12.5 | |
| 157.4375 | 160.5875 | FM | 12.5 | |
| 160.6000 | 162.0250 | FM | 12.5 | |
| 162.0300 | 173.9900 | FM | 10 | |
| 174.0000 | 215.9500 | WFM | 50 | |
| 216.0000 | 224.9950 | FM | 5 | |
| 225.0000 | 399.9750 | AM | 25 | |
| 400.0000 | 405.9875 | FM | 12.5 | |
| 406.0000 | 439.9937 | FM | 6.25 | |
| 440.0000 | 449.9937 | FM | 6.25 | |
| 450.0000 | 469.9900 | FM | 10 | |
| 470.0000 | 512.0000 | FM | 6.25 | |
| 806.0000 | 960.0000 | FM | 12.5 | |
| 1240.0000 | 1300.0000 | FM | 12.5 | |

FEATURE SUMMARY

< Band Plan 3 >

| Frequency (MHz) | | Modulation | Step (kHz) | Remark |
|-----------------|------------|------------|------------|----------|
| Lower Edge | Upper Edge | | | |
| 25.0000 | 29.9950 | FM | 5 | |
| 30.0000 | 79.9937 | FM | 6.25 | |
| 80.0000 | 82.9937 | FM | 6.25 | |
| 83.0000 | 87.2937 | FM | 6.25 | |
| 87.3000 | 107.9500 | FMB | 50 | |
| 108.0000 | 136.9875 | AM | 12.5 | AIR BAND |
| 108.0000 | 136.9916 | | / 8.33 | |
| 137.0000 | 137.9950 | FM | 5 | |
| 138.0000 | 157.9937 | FM | 6.25 | |
| 158.0000 | 160.5937 | FM | 6.25 | |
| 160.6000 | 162.5937 | FM | 6.25 | |
| 162.6000 | 173.9937 | FM | 6.25 | |
| 174.0000 | 215.9500 | WFM | 50 | |
| 216.0000 | 224.9950 | FM | 5 | |
| 225.0000 | 399.9750 | AM | 25 | |
| 400.0000 | 405.9875 | FM | 12.5 | |
| 406.0000 | 439.9937 | FM | 6.25 | |
| 440.0000 | 465.9937 | FM | 6.25 | |
| 466.0000 | 469.9937 | FM | 6.25 | |
| 470.0000 | 512.0000 | FM | 6.25 | |
| 806.0000 | 960.0000 | FM | 12.5 | |
| 1240.0000 | 1300.0000 | FM | 12.5 | |

- These Frequency Ranges suit to initial step setting. Step setting will change them.
- These Modulations are initial settings. They can be selected from AM / FM / NFM / WFM / FMB / AUTO.
- These Steps are initial settings.
Steps can be selected from 5 / 6.25 / 8.33 / 10 / 12.5 / 15 / 20 / 25 / 50 / 100 / AUTO (kHz).
- If "AUTO" is selected for Modulation or Step, the scanner works with the modulation or step of this table.
- If the Step is set to 15 kHz, inputable frequencies are xxx.x000, xxx.x150, xxx.x300, xxx.x450, xxx.x600, xxx.x750, and xxx.x900. For example, the next frequency of 400.0900 MHz is 400.1000 MHz.
- If the Step is set to 8.33kHz, inputable frequencies are xxx.x000, xxx.x083, xxx.x166, xxx.x250, xxx.x333, xxx.x416, xxx.x500, xxx.x583, xxx.x666, xxx.x750, xxx.x833, and xxx.x916.
For example, the next frequency of 100.0916 MHz is 100.1000 MHz.

Feature Highlights

General

DIN-E and ISO Vehicle Mountable — using an included DIN-E sleeve or a standard ISO technique, the scanner can be easily mounted in most vehicles.

Close Call™ RF Capture Technology — Instantly detects and tunes to nearby transmissions with no additional programming. See “Using the Close Call Feature” on Page 94 for more information.

Close Call Do-Not-Disturb — Checks for Close Call activity in between channel reception so active channels are not interrupted.

Close Call Temporary Store — Temporarily stores and scans the last 10 Close Call hits so that you can continue to monitor activity on those frequencies, even after you are out of Close Call detection range.

Dynamically Allocated Channel Memory — Your scanner’s 6,000 channels are organized so that it more closely matches how radio systems actually work, making it easier to program and use your scanner and determine how much memory you have used and how much you have left.

100 Quick Keys — You can set the scanner so you can quickly select systems and groups by using the keypad. This makes it easy to listen to or quickly lock out those systems or groups you don’t want to scan.

6 Service Searches — Frequencies are preset in separate Air, Marine, CB AM Radio, CB FM Radio, PMR and LPD, to make it easy to search for specific transmissions.

“Soft” Search Keys — Lets you quickly search specified ranges.

Channel Lockout — You can lock out any system, group, frequency, or channel while scanning. If you lock out a system or group, any channels belonging to that system or group are also locked out.

Frequency Lockout — You can lock out up to 500 frequencies (250 permanently locked out + 250 temporarily locked out). The scanner skips locked-out frequencies while using the Close Call™ feature or while searching.

CTCSS and DCS Squelch Modes — Prevent interference from stations not using the tone code you select.

Audio AGC — Helps automatically balance the volume level between different radio systems.

FEATURE SUMMARY

Fire Tone-Out Standby — Lets you set the scanner to alert you if a two-tone sequential page is transmitted. You can set up to 10 settings (transmit frequency, tone frequencies) then select one for standby monitoring. Up to ten tone-outs on the same RF setting can be scanned at one time.

Broadcast Screen — Lets you input up to 10 frequency ranges that the scanner will ignore during Close Call™ or search operation.

Scan/Search Delay — The scanner pauses at the end of a transmission to wait for a reply. You can set the delay time for each system you scan, and while searching and using the Close Call™ feature.

Attenuator — Reduces the input strength of strong signals by about 20 dB.

Channel Alert — Alerts you when there is activity on any channel you specify using your choice of nine unique alert tones.

Memory Check — Lets you see at a glance how much total memory is left.

Search with Scan Operation — Lets you include selected service searches or custom search ranges during normal scan operation.

Custom Alerts — For each alert in the scanner (such as channel alert, Close Call alert, emergency alert), you can select from 9 different tone patterns and also set the alert volume level independently from the main volume level.

Automatic Channel Step — Accepts frequencies on any valid channel step, even if it does not fall within the band plan's default step.

Frequency Step — Lets you select a frequency step (5, 6.25, 8.33, 10, 12.5, 15, 20, 25, 50 or 100 kHz) for manual mode and search mode.

Text Tagging — You can name each system, group, channel, talk group ID and custom search range using up to 16 characters per name.

Data Skip — Allows your scanner to skip unwanted data transmissions and reduces the effect of birdies.

Duplicate Frequency Alert — Alerts you if you try to enter a duplicate name or frequency already stored in a system.

Memory Backup — If power is lost or disconnected, the scanner retains the frequencies you programmed in its memory.

Temporary Lockout — Makes it easy to temporarily lock out a system, channel, or frequency. The lockout is cleared when you turn power off, then back on so you don't have to remember to unlock the channels later.

Startup Configuration — Lets you easily manage multiple configurations for your scanner.

Single-Handed Function Control Operation — You can tap the Function/Scroll Control to enable the Function mode. It reverts to normal mode in about 3 seconds from your last press if no other action occurs.

Record Output Jack — Using the appropriate cable and audio recording device with signal control, you can record live audio of designated channels.

Display and Keypad Backlight — Makes the display and keypad easy to see in dim light using three levels plus off.

Vehicle Power Connection (Orange Wire) — Lets you connect to your vehicle's dimmer circuit to also dim the scanner's display with the vehicle's dimmer control.

Trunk Tracker III™ Operation — Follows unencrypted conversations on analog Motorola, EDACS, EDACS SCAT, and LTR trunked radio systems, including systems in VHF, UHF, 800 MHz, and 900 MHz bands. The scanner can scan both conventional and trunked systems at the same time.

Multi-Site Trunking — Lets you share system channels across multiple sites to more efficiently use the scanner's memory and more easily select sites to monitor.

Control Channel Only Scanning — If the scanner is set to scan a Motorola system, you can set it so it scans using only control channel data. You do not have to program voice channel frequencies into memory in this mode as long as all possible control channels are programmed.

GPS

Location Based Scanning — If you connect a GPS unit to the scanner it can automatically enable and disable systems based on the Location Information (longitude, latitude, Range) that you provide.

GPS Non-Radio Based Features — The scanner alerts you to Dangerous Intersections, Speed Alerts, and Points of Interest that you program into the scanner.

GPS Display Mode — Lets you display extended GPS information such as Distance to a POI, Direction to a POI, Time to a POI, Speed, Position, and more.

Search

Service Search — Lets you quickly select and search the scanner's preprogrammed frequencies.

FEATURE SUMMARY

Custom Search — Lets you program up to 10 custom search ranges. You can search any of these ranges simultaneously.

CTCSS/DCS Search — Lets the scanner search for CTCSS or DCS tones or codes on any channel or during a search. The scanner can identify up to 50 CTCSS tones and 104 DCS codes.

Quick Search — Lets you search from the currently-tuned frequency if you are searching a conventional system.

Auto Store

Frequency AutoStore — Automatically stores all active frequencies into the selected conventional system.

Talk Group ID AutoStore — Automatically stores all new talk group ID's into a channel group you select.

Priority

Priority Scan — Priority channels let you keep track of activity on your most important conventional channel(s) while monitoring transmissions on other channels.

Priority Plus — You can set the scanner so it scans only the priority channels.

PC Control and Cloning

PC Control — You can transfer programming data to and from your scanner and your personal computer, and control the scanner using a computer. This helps you find frequencies listed on the Internet and load them into the scanner. PC control and programming software will be available at <http://www.butelsoftware.com/>.

Clone Mode — You can clone all programmed data, including the contents of the scanner's memory, menu settings, and other parameters from one UBC800XLT scanner to another UBC800XLT scanner.

Memory Storage Limits

| Systems | Sites | Sites per Systems | Groups per System | Total Channels |
|---------|-------|-------------------|-------------------|----------------|
| 500 | 1000 | 256 | 20 | 6000 |

| Channels per Conventional Systems | Channels per Trunked Systems | Trunked Frequencies per Site* |
|-----------------------------------|------------------------------|-------------------------------|
| 1000 | 250 | 750-1000 |

* depending on the number of TGID in the system.

Search Lockout Limits

| Frequencies | Temporary L/O Frequencies | Permanent L/O Frequencies | Skipped | Review |
|-------------|---------------------------|---------------------------|--------------------------------|-----------|
| 500 | 250 | 250 | Search Mode Close Call Mode | Menu Mode |

About This Manual

The screen displays used in this manual are representations of what might appear when you use your scanner. Since what you see depends on the frequencies and user IDs for your area and the settings you select, you might notice some differences between what is in this manual and what appears on your scanner.





To get the most from this manual, review the contents to become familiar with the basic functions available. If you are new to scanning or trunk tracking, start with the following short introduction to scanning and follow-up with the enclosed reprinted article on Programming provided with the courtesy of *Popular Communications* magazine.

Using the Scroll Control

The **Scroll Control** is a dual purpose control. It also lets you switch to secondary function operations. When used in this manner, you see  in this manual. Located prominently on the right of the UBC800XLT's front panel, the knob/switch lets you easily control channel selection, plus Normal and Function Modes, as well as how most of the information appears on the display.

To adjust menu settings, change channels in Hold mode, and resume scanning: Simply turn the **Scroll Control**.



FEATURE SUMMARY

To use  tap the **Scroll Control**. This action is written in shorthand as  which is fully explained in the next section. When you tap the control  appears and remains in the upper left corner of the display for 3 seconds. During this time, press any button to access the button's second function. Or, press and hold the Scroll Control for 2 seconds. The scanner beeps, and the function is "latched" so that it does not return to normal mode until you tap the Scroll Control again.  flashes at approximately 1 second intervals.



If you select Function while scanning, the UBC800XLT continues to scan, but holds on the current system until the function operation is cancelled.

How the Scanner's Controls Are Represented in This Manual

To help navigate the scanner's menus, the steps shown in this manual show the displays you see and the keys you press or control you operate to get a desired result. We use a form of shorthand symbols to save space.

The following example shows you how to use the scanner's menu to edit an existing system name. It shows you the key to press in brackets **[MENU]** to select a menu option and the option you see on the LCD in Boldface Courier type (**Program System**) when you press **[MENU]**. It also instructs you to turn the **Scroll Control** (shown as ) to view a series of choices then *press or tap* the **Scroll Control** (the shorthand action shown as ) to *enter* a choice such as **Edit Name**.

[MENU] → **Program System** → 

 Select the system → 

Edit Name →  Then, edit the system name.

Entering Text Within A Menu Option

To enter a letter, turn the **Scroll Control** () until the letter, numeral or other character you want appears. To move the cursor to the left, press **[4]**. To move the cursor to the right, press **[6]**.

To clear a character, press **[.No]** twice. To clear all characters, press **[.No]** three times.

To accept an entry, press  or press **[EYES]**.

To cancel an entry, press **[MENU]**.

Understanding Scanning and the UBC800XLT

This section provides you with additional background on how scanning works and how your scanner provides that feature. You don't really need to know all of this to use your scanner, but some further background knowledge will help you get the most from your UBC800XLT.

Understanding the Scanner's Memory

Your scanner's memory is organized in an architecture called *Dynamic Allocated Channel* memory. This type of memory is organized differently and more efficiently than the bank/channel architecture used by traditional scanners. Dynamic Allocated design matches how radio systems actually work much more closely, making it easier to program and use your scanner and determine how much memory you have used and how much you have left.

Instead of being organized into separate banks and channels, your scanner's memory is contained in a *pool*. You simply use as much memory as you need in the pool to store as many frequencies, and talk group ID's as desired. No memory space is wasted, and you can tell at a glance how much memory you have used and how much remains.

With a traditional scanner, when you program it to track a trunked system, you must first program the frequencies. Since you can only program one trunking system per bank in a traditional scanner, if there were (for example) 30 frequencies, the remaining channels in the bank are not used and therefore wasted. Also, since some trunked systems might have hundreds of talk groups, you would have had to enter those types of systems into multiple banks in order to monitor and track all the ID's.

Understanding Quick Keys

Traditional "Banked" scanners let you select and deselect banks by pressing a single digit on the keypad. The UBC800XLT uses a similar method to turn on and off scanning sites and systems. When you program a system or site, you assign a quick key (System/Site Quick Key, or SQK) from 0 to 99. You can use the same quick key for multiple systems, so that the systems are turned on and off together. To turn a system/site on or off, just press the digit corresponding to the assigned SQK. For two-digit SQK's, first press **[.No]**, then enter the two-digit SQK.

The UBC800XLT lets you assign another quick key to a group of channels within a system. This group quick key (GQK) can be from 0-9. To turn on and off channel groups, you press **⏏** while the scanner is scanning the system containing the

channels, then press the GQK within 2 seconds. Systems can have up to 20 channel groups, and multiple channel groups can be assigned to the same GQK.

What is Scanning?

Unlike standard AM or FM radio stations, most two-way communications do not transmit continuously. Your UBC800XLT scans programmed channels until it finds an active frequency, then stops on that frequency and remains on that channel as long as the transmission continues. When the transmission ends, the scanning cycle resumes until the scanner receives another transmission.

What is Searching?

The UBC800XLT can search each of its 6 service search ranges and up to 10 custom search ranges to find active frequencies. This is different from scanning because you are searching for frequencies that have not been programmed into the scanner's channels. You set the upper and the lower values of the range and then the scanner searches for any active frequency within the limits you specify. When the scanner finds an active frequency, it stops on that frequency as long as the transmission lasts. If you think the frequency is interesting, you can program it into the scanner's memory. If not, you can continue to search.



What is CTCSS/DCS?



Your scanner can monitor systems using a Continuous Tone Coded Squelch System (CTCSS) and Digital Coded Squelch (DCS) system, which allow squelch to open only when the tone you have programmed with a specific frequency is received along with a transmission.

CTCSS and DCS are sub-audible tone signaling systems sometimes referred to as PL or DPL (Motorola's trademarked terms for Private Line and Digital Private Line respectively). CTCSS and DCS are used only for FM signals and are usually associated with both amateur and commercial two-way frequencies. These systems make use of a special sub-audible tone that accompanies a transmitted signal.

CTCSS and DCS are used for many purposes. In many cases, CTCSS and DCS are used to restrict access to a commercial repeater, so that only those units which transmit the correct tone along with their signal can "talk" to the repeater.

CTCSS and DCS are also used in areas that receive interference where there are several stations with output frequencies close to each other. When this occurs, you might hear multiple communications on the same frequency. The stations might

even interfere with each other to the point where it is impossible to clearly receive any of the stations. A scanner, such as your UBC800XLT, equipped with CTCSS and DCS, can code each received frequency with a specific sub-audible CTCSS or DCS frequency or code. Then, when you receive multiple signals, you only hear the transmission with the CTCSS or DCS tone you programmed. If you do not receive the correct tone with a signal, the scanner's squelch remains closed and you hear nothing.

The tables showing the available CTCSS frequencies and DCS codes are found in the Reference Section of this manual.

Conventional Scanning

Conventional scanning is a relatively simple concept. Each group of users in a conventional system is assigned a single frequency (for simplex systems) or two frequencies (for repeater systems). Any time one of them transmits, their transmission always goes out on the same frequency. Up until the late 1980s, this was the primary way that radio systems operated.

Even today, there are many 2-way radio users who operate using a conventional system:

- Aircraft
- Amateur radio
- LPD/PMR users
- Broadcast AM/FM/TV stations
- Many business radio users

When you want to store a conventional system, all you need to know are the frequencies they operate on. When you are scanning a conventional system, the scanner stops very briefly on each channel to see if there is activity. If there isn't, the scanner quickly moves to the next channel. If there is, then the scanner pauses on the transmission until it is over.

Simplex Operation

Simplex systems use a single frequency for both transmit and receive. Most radios using this type of operation are limited to line-of-sight operation. This type of radio is frequently used at construction job sites, and with inexpensive consumer radios such as LPD/PMR radios. The range is typically 1-15 miles, depending upon the terrain and many other factors.

Repeater Operation

Repeater systems use two frequencies: one transmits from the radio to a central repeater; the other transmits from the repeater to other radios in the system. With a repeater-based system, the repeater is located on top of a tall building or on a radio tower that provides great visibility to the area of operation. When a user transmits (on an input frequency), the signal is picked up by the repeater and retransmitted (on an output frequency). The user's radios always listen for activity on the output frequency and transmit on the input frequency. Since the repeater is located very high, there is a very large line of sight.

Typical repeater systems provide coverage out to about a 25-mile radius from the repeater location.

What is Trunk Tracking?

Your UBC800XLT is designed to track the following types of trunking systems.

- Motorola Type I, Type II, Type III hybrid, SMARTNET, and PRIVACYPLUS analog trunking systems, which are extensively used in 800 MHz communication systems.
- LTR trunking systems
- EDACS SCAT trunking systems
- EDACS trunking systems

When tracking these types of systems, you might want to remember that your scanner can track more than one trunking system at a time and scan conventional and trunked systems at the same time.

Conventional scanning is a simple concept. You enter a frequency used by someone you want to monitor into your scanner's memory. For example, the police in your area might transmit on 460.500 MHz, the fire department on 154.445 MHz, the highway department on 37.900 MHz, etc. So when your scanner stops on a frequency, you usually know who it is, and more importantly, you can stop on a channel and listen to an entire conversation. This type of scanning is easy and fun.

However, as the demand for public communications has increased, many public radio users do not have enough frequencies to meet their needs, creating a serious problem. Trunking radio systems help solve this problem.

Trunked Scanning

While conventional scanning worked great while there were only a few groups wanting to use the frequencies, with the advent of smaller, lower-cost radios more and more agencies and businesses wanted to take advantage of the utility of 2-way radio. As a result, the bands that were used most became full, so new users were not able to take advantage of the technology as quickly as they wanted.

Trunking solved this frequency shortage by allowing multiple groups to use the same set of frequencies in a very efficient way. While each type of trunking system operates a little differently (see the next few sections), they all work on the same basic premise: even in a system with a lot of users, only a few users are ever transmitting at any one time.

Instead of being assigned a frequency, as with conventional systems, each group is assigned a talk group ID. A central computer controls the frequency each group operates on. This frequency selection is made each time a user transmits. So, while on a conventional system queries, replies, and follow-ups are all on a single frequency, they could each be on completely different frequencies on a trunked system. This semi-random frequency assignment made monitoring such a system impossible prior to Uniden's invention of the TrunkTracker scanner.

Not only does your UBC800XLT scan channels like a conventional scanner, it actually follows the users of a trunked radio system. Once you know and program a talk group's ID (TGID), you won't miss any of the action.

If you are a new scanner enthusiast, you might want to read the first part of this manual and use your scanner in conventional mode before you begin trunk tracking. Understanding scanning fundamentals and terminology will make trunk tracking much easier. If you are already an experienced scanner operator, you can review the programming worksheets and their associated pages on the Uniden website.

Types of Trunking Systems

Trunking systems divide a few frequencies among many different users, but the way that each system does this is slightly different. This section describes some of the technical data behind Motorola, EDACS, and LTR trunked radio systems.

Motorola Trunking

While there are different types of Motorola trunking systems, they all use the same basic trunking method. The system consists of one control channel (or as many as 4 per system but only one is active at any one time), plus one or more voice

channels (typically 10, 20, or 28 total channels). When a user presses Push To Talk (PTT) to transmit, their radio first sends the person's talk group information to the control channel. The computer then assigns that talk group to a specific voice channel and transmits that data over the control channel. All radios in that talk group switch over to the assigned voice channel and the user can begin speaking. This all typically takes place in about a second. The person transmitting hears a beep from their radio when the channel is assigned. Then it is OK to start talking.

The systems in use are:

Motorola Type I — the radios send the radio ID, the fleet and subfleet talk group ID to the control channel each time they transmit. To program a Type I system, you need to know the system's *fleet map*. The most common fleet maps are included in the Reference section in this manual. You can also find fleet map resources on the web such as at <http://www.radioreference.com>.

Motorola Type II — the radios only send the radio ID and radio channel code to the control channel. The central computer keeps a database of radio ID's and which talk group is assigned to which channel code for each radio, so with this system the user's radio sends only about $\frac{1}{3}$ the data as a Type I system with each transmission. Type II systems do not use Fleet-subfleet talk groups; instead they use a 5-digit ID for each talk group.

Type III Hybrid — these systems support a mix of both Type I and Type II users. Like Type I systems, you must know the system's fleet map to ensure proper tracking.

EDACS Trunking

EDACS trunking works in much the same way as Motorola trunking with a couple of major differences. In an EDACS system, each frequency used by the system is assigned a Logical Channel Number (LCN) so that less data needs to be transmitted by the control channel. Talk groups are assigned in an Agency-Fleet-Subfleet (AFS) hierarchy. There is one variation of EDACS called SCAT that your UBC800XLT can monitor.

Logical Channel Numbers — each frequency used by the system is assigned an LCN. This information is programmed into each user radio. When a user presses PTT, their radio sends their AFS information to the control channel. The computer then assigns that talk group to a channel and sends the LCN so that all other radios in that talk group will switch to the correct channel. To program an EDACS system in your scanner, you will need to know both the frequencies used by the system and the LCN for each frequency.

Agency-Fleet-Subfleet — talk group ID's for EDACS systems are assigned in a way that makes it easy to see at a glance the affiliation of the user. Each radio is assigned a 2-digit agency identifier from 00 — 15. For example, 01 might be used by the police, 02 by the ambulance service, 03 by the fire department, and so on. Each agency is then subdivided up to 16 times to provide fleet identification, and then 8 more times to identify subfleets.

For example, the complete AFS for the Police Department West District's dispatch channel might be 01-062. 01 identifies the agency as the police department, 06 identifies the fleet as the West district, and 2 identifies the subfleet as the dispatch channel. While these assignments are somewhat arbitrary and vary from system to system, there are many resources on the web for finding the assignments for most systems. Because of the logical hierarchy of the AFS system, your UBC800XLT lets you assign wildcard ID's that let you, for example, use only one ID memory to identify all units in either an agency or a fleet.

EDACS SCAT — (Single Channel Autonomous Trunking) systems operate on a single channel and alternate control data with analog voice traffic. While your UBC800XLT cannot track ID's in this system, it can eliminate the control data so that all you hear is the voice transmissions when you monitor this type of system.

LTR Trunking

LTR (Logic Trunked Radio) systems are trunking systems used primarily by business or private communications service providers, such as taxicabs, delivery trucks, and repair services. These systems encode all control information as digital sub audible data that accompanies each transmission, so there is no separate control channel. Users on an LTR system are assigned to specific talk groups, which are identified by the radio as six digit numbers.

These numbers are in the form AHHUUU, where:

- A = Area code (0 or 1)
- H = Home repeater (01 through 20)
- U = User ID (000 through 254)

When the scanner receives a transmission on a channel set to the LTR mode, it first decodes the LTR data included with the transmission. In the ID search mode, the scanner stops on the transmission and displays the talk group ID on the display. In the ID scan mode, the scanner only stops on the transmission if the LTR data matches a talk group ID that you have stored in the talk group ID list and have not locked out. LTR systems are frequently programmed so that each radio has a unique user ID.

Startup Configuration

Setup/Operation

The Startup Configuration option lets you quickly and automatically lock and unlock systems based on your desired configuration. Simply hold down a number button while powering on the scanner or while the opening screens are displayed. Systems assigned to that number are automatically unlocked and systems assigned to other numbers are automatically locked. Systems that are not assigned to any startup configuration are left unchanged.

You could use this feature to give you quick, single-press Quick Key access to your favorite systems even when you travel to other locations. For example, if you program your scanner as follows:

| System/Site Quick Key | Configuration 1 | Configuration 2 |
|-----------------------|-----------------|-----------------|
| 1 | Fort Worth | Phoenix |
| 2 | Tarrant County | Mesa |
| 3 | Arlington | Mariposa Cnty |



When you are in the Fort Worth area, press **[1]** while turning on the scanner. System Quick Keys **[1]**, **[2]**, and **[3]** then allow you to select between the local systems. When you travel to the Phoenix area, hold **[2]** while turning on the scanner. Now, the Fort Worth systems are locked out and System Quick Keys **[1]**, **[2]**, and **[3]** allow selection between the Phoenix-area systems.

Multi-Site Trunking

Some systems covering a very large geographic area use multiple antenna sites that each operate on different frequencies, but that use the same Talk Group ID's for traffic. When programming such a system, you program each site's frequencies and other settings into the system, then program the channels into channel groups within that system. Each site can have its own quick key, so you can turn each individual site on or off while you scan. Since all sites share all the channels within the system, multi-site trunking is much more efficient than programming each site as a separate system.

I-Call (Motorola/EDACS)

I-calls are direct unit-to-unit transmissions that are not heard by other system users. Your UBC800XLT can receive I-call transmissions. See "Setting I-Call



(Motorola and EDACS Systems Only)” on Page 68 for more information about monitoring I-call transmissions.

Where To Get More Information

By itself, this manual only provides part of what you need to know to have fun scanning — how to program and use the scanner. Other sources provide additional information.

Information On The Internet

The Internet is a great source for current frequencies and information about scanning. Many web sites have lists of frequencies for your area. You can use a search engine to find and use them.

Make a list of the agencies you want to listen to, then look up the frequencies and systems used by those agencies.

www.butelsoftware.com — Programming software.

Included With Your Scanner



UBC800XLT
Scanner



AC Adapter
(P/N AD-968)



Cigarette Lighter
Adapter Power Cord



Three Wire DC (with Orange Wire –
See Step6 on Page 33) Power Cord

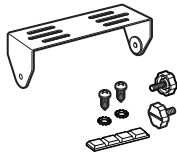

Mounting Bracket
and Hardware



Push-on type
Telescopic Antenna



Remote PC to Scanner
Cable (scanner plug to
Front PC Connector)

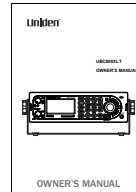

Owner's Manual and
Other Printed Material

Setting Up Your Scanner

These guidelines will help you install and set up your new scanner:

The UBC800XLT can be placed on a convenient surface in your home as a base station, and connected to a standard outlet. You must use either the supplied antenna or an electrically correct outdoor antenna, properly and safely mounted at your chosen site.

The scanner is also designed to accommodate the DIN-E and ISO-DIN automotive mounting configurations. A DIN-E sleeve is not supplied (optional hardware).

The unit can also be placed above or beneath the dash of your vehicle using the supplied bracket and mounting hardware.

- If your scanner receives interference or electrical noise, move the scanner or its antenna away from the source.
- To improve the scanner's reception, use an optional external antenna designed for multi-band coverage. (You can purchase this type of antenna at a local electronics store). If the optional antenna has no cable, use 50-75 ohms coaxial cable for lead-in. A mating plug might be necessary for the optional antennas.
- Use an optional mono earphone or mono headset with proper impedance (32 ohms) for private listening. Read the precautions on the inside front cover of this Owners Manual.
- Do not use the scanner in high-moisture environments such as the kitchen or bathroom.
- Avoid placing the scanner in direct sunlight or near heating elements or vents.

Base Station

This is the simplest approach to let you get started quickly. Decide on a location that is convenient to a nearby wall outlet, has desk space to let you complete your programming worksheets, will safely allow the indoor antenna to be extended, or near a window to use an outdoor antenna.

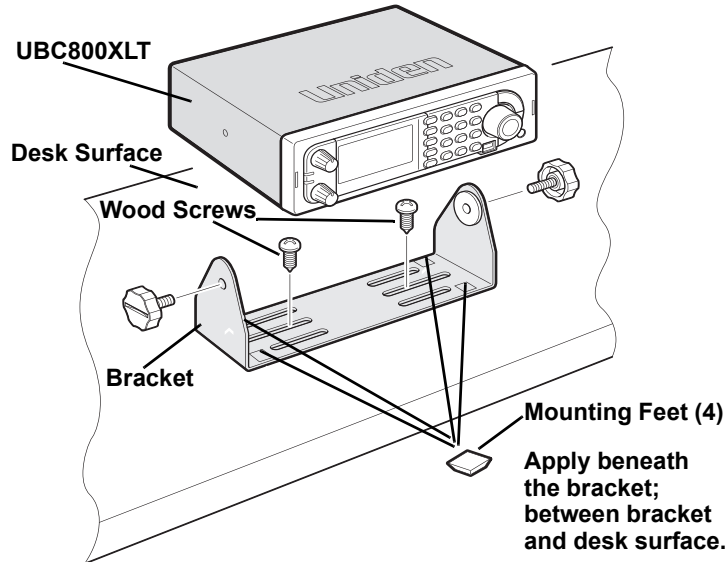

To secure the radio, by means of the mounting bracket, to a surface, follow the steps below:

1. Attach the four protective rubber feet to the mounting bracket when you casually use the scanner on a flat surface. Should you desire to permanently mount the scanner, remove the feet and use wood screws through the bracket as described in Steps 2 and 3.
2. Use the bracket as a template to mark positions for the two mounting screws.
3. At the marked positions, drill holes slightly smaller than the screws.
4. Align the bracket with the threaded holes on the sides of the radio case so the bracket is beneath the radio. Secure the bracket using the two threaded knobs. Never overtighten the knobs.

Once the radio is positioned, connect it to a source of AC power using the supplied **13.8V, 750 mA** AC adapter. Insert the barrel of the AC adapter to the jack on the rear, upper right side of the radio marked $\text{DC } 13.8\text{V}$.

WARNING!

Use only the Uniden-supplied AC adapter with this scanner.

Insert the connector of the supplied indoor telescoping antenna to the **BNC Antenna Connector** and apply moderate pressure to secure it.

Setting Up an Audio Recording Device or Computer Recording

It is best if you plan ahead when you initiate the basic setup of the scanner if you include the components to record incoming reception. You need only an audio recording device which can be controlled by a Voice Operated module (VOX) either externally or from within the unit and the correct connecting cable.

The **REC** jack on the rear apron provides a constant-level audio output which is not affected by the setting of the volume control. Use a mono or stereo cable that ends in a 3.5mm plug for the scanner. The recorder might have its own requirements as to the proper plug. Check the recorder's instructions to be sure.

Connect the cable to an external or internal VOX control so that the recorder activates when audio is present.

You can also connect the cable to the appropriate input jack on your PC so that with controlling software, you can record to your hard disc.

In order for the function to operate, you must set the channel to record. You must also set the system's record option to either **All Channel**, which will record all channels regardless of any channel's setting, or **Marked Channel** which only lets recording occur if you have selected record for that channel. Which you choose will depend on various factors.

Vehicle Installation

You can mount your scanner in your vehicle, using either the supplied bracket or the DIN-E sleeve (optional hardware).

Mounting Using the Bracket

With the bracket removed from the radio, use the holes in the bracket as a template to initially mark the location you plan to use in your vehicle. Be absolutely certain of what might be behind the mounting surface before making any holes, be it above, or below, or in front of your dash, armrest console, or other location. If you drill carelessly, expensive damage can result. If in doubt, consult your vehicle dealer's service department or a qualified professional installer.

Important: AVOID AIRBAG DEPLOYMENT ZONES. Ignoring this installation concern may result in bodily harm and the inability of the airbag to perform properly.

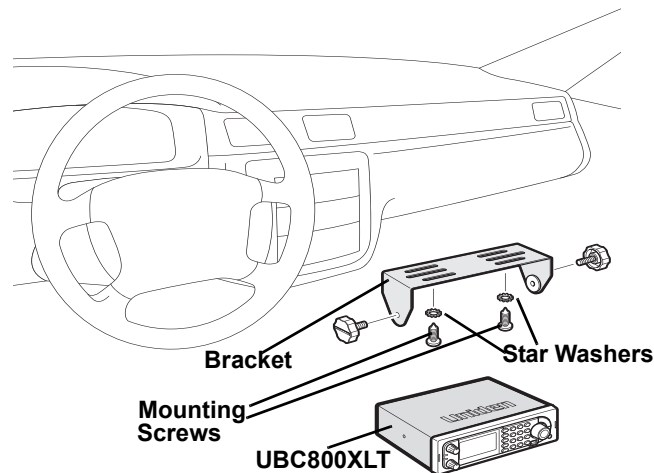

1. Using appropriate screws or other hardware, secure the bracket.
2. Insert the scanner and insert the bracket knobs to lock the scanner in position.
3. Attach the Cigarette Lighter Power Cord to the rear of the scanner and plug the adapter end into a dash mounted 12V DC socket.
4. Attach a suitable mounted mobile antenna to the antenna jack on the back of the scanner.

Mounting Using the DIN-E Sleeve (Optional hardware)

If you are unsure about how to install your scanner in your vehicle using the DIN-E sleeve, consult your automobile manufacturer, dealer, or a qualified installer. Before installing, confirm that your scanner fits in the desired mounting area and you have all the necessary materials to complete the task. Your scanner requires a 2 x 7-1/8 x 5-5/16 inch (50 x 180 x 135 mm) mounting area. Allow an additional 2-3/8 inch (60 mm) space behind the unit for connectors and wires.

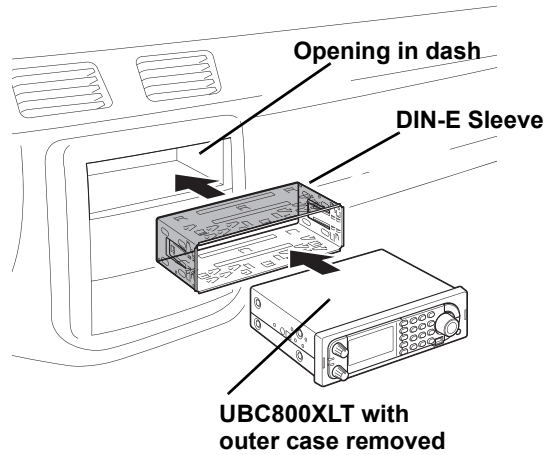

1. Remove the bracket if previously attached.
2. Remove the four Philips screws on the rear that secure the outer metal case and pull off the case with care.
3. Install the DIN sleeve into the opening in your dashboard, lip facing out.
4. Push out the top and bottom tabs to hold the sleeve firmly in place.
5. Before inserting the scanner in the sleeve, attach the cable from the previously mounted antenna. Attach the DC Power leads. RED goes to a positive (+) connection on your fuse block while BLACK connects to the vehicle's chassis ground (-).
6. Connect the ORANGE lead to one side of the headlamp switch so that when you activate the headlights, the scanner's LCD backlight dimmer level changes intensity. Be sure all the connections are routed away from any potentially pinching or slicing sheet metal.
7. Slowly slide the scanner into the sleeve until it locks in place.
8. To remove the unit, see "Removing the Scanner from the DIN-E Sleeve" on Page 34.

Note: if you plan to connect a GPS unit or external speaker at a later time, expect to remove the unit for ease of making those connections.

Setting Up Your Scanner

Removing the Scanner from the DIN-E Sleeve

If you plan to connect other devices or wires to the radio, such as a GPS unit, at a later time, you should plan to remove the scanner from the DIN-E sleeve. This is easily done using the Removal Keys.

Fully insert both Removal Keys into the slots on the left and the right edges of the radio's dress panel. You cannot remove the radio if only one key is available. Press in fully and the radio will unlock from the sleeve making withdrawal from the sleeve possible. Store the keys in a safe place for future use.

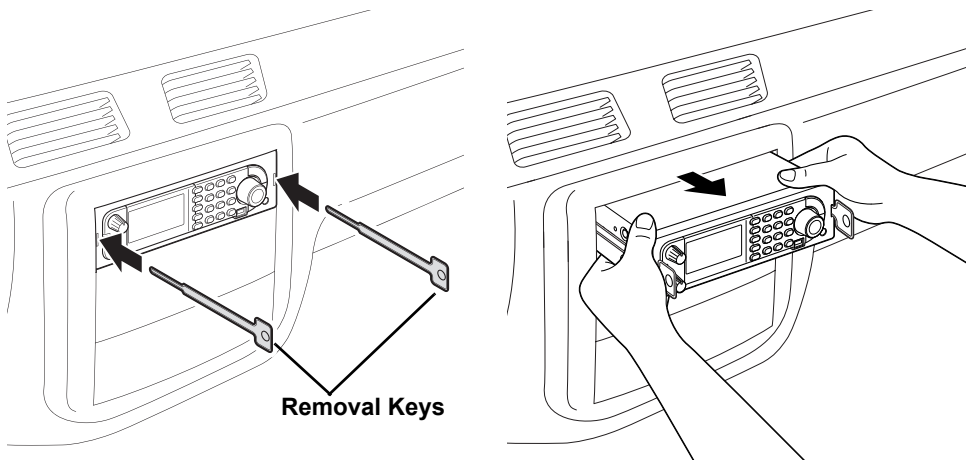

Mounting Using ISO Technique

Some vehicles can take advantage of another approach to mounting a radio in a vehicle, called the ISO technique. However, this technique requires a very detailed and thorough knowledge of the technique. Therefore, we strongly suggest that if you have any doubt about your experience and abilities, please consult with a professional installer who is familiar with the ISO approach to radio installation.

To begin the process, it is first necessary to remove the scanner's outer metal sleeve from the inner chassis. Unthread the four screws in the rear of the unit. Slide the cover toward the rear and off. Once the sleeve is removed, you will see threaded, metric machine screw holes on either side of the chassis cabinet. Uniden does not supply these screws. Their diameter, length, and screw type should be chosen by a qualified installer based on the internal vehicle bracket which will be used in securing the scanner chassis.

Once the original radio is removed from the vehicle dash and the fit of the scanner is correct, be sure to connect all the power, audio, antenna, and any other cables or wires, to the scanner before the scanner is secured.

The following illustration is a typical example of the ISO technique and the general side mounting screw holes often encountered. It does not actually represent your vehicle or your vehicle's mounting bracket. Only a professional installer will be able to determine the best and correct approach.

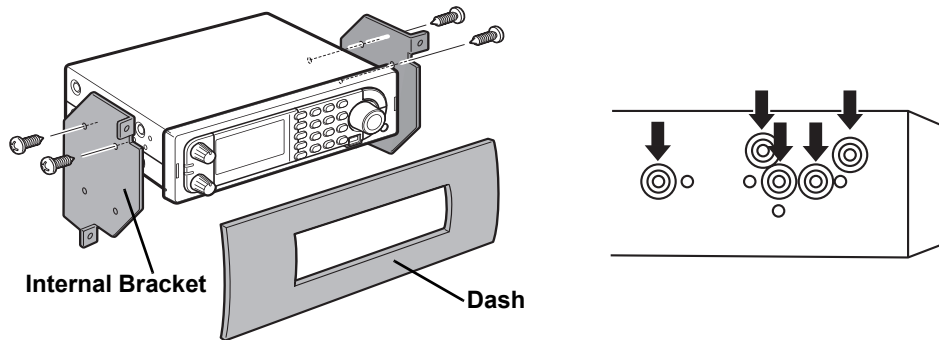

Removing the Display Sticker

Before you use the scanner for the first time, remove the protective plastic film over the display.

Connecting an Optional Antenna

The scanner's BNC connector makes it easy to connect a variety of optional antennas, including an external mobile antenna or outdoor base station antenna.

Note: Always use 50- or 75-ohm, RG-58, or RG-8, BNC terminated coaxial cable to connect an outdoor antenna. If the antenna is over 50 feet from the scanner, use RG-8 low-loss dielectric coaxial cable. Cable loss increases with higher frequency.

Connecting an Earphone/Headphone

For private listening, you can plug a 1/8-inch (3.5 mm) mini-plug earphone or headphones (not supplied) into the headphone jack on the front of your scanner. This automatically disconnects the internal speaker. See "Earphone Warning" at the front of the manual for important information about using an earphone/headphone.

Setting Up Your Scanner

WARNING!

Never connect anything other than the recommended amplified extension speaker to the scanner's headphone jack. Damage to the scanner might occur.

Connecting an Extension Speaker

In a noisy area, an optional amplified extension speaker, positioned in the right place, might provide more comfortable listening. Plug the speaker cable's $\frac{1}{8}$ -inch (3.5-mm) mini-plug into your scanner's back-panel **Ext. Sp. Jack**.

WARNING!

Never connect any part of the headphone jack to the antenna jack or connect the radio to an installation where the antenna and audio connection are grounded. This might also damage the scanner.

Controls, Keys, and Functions

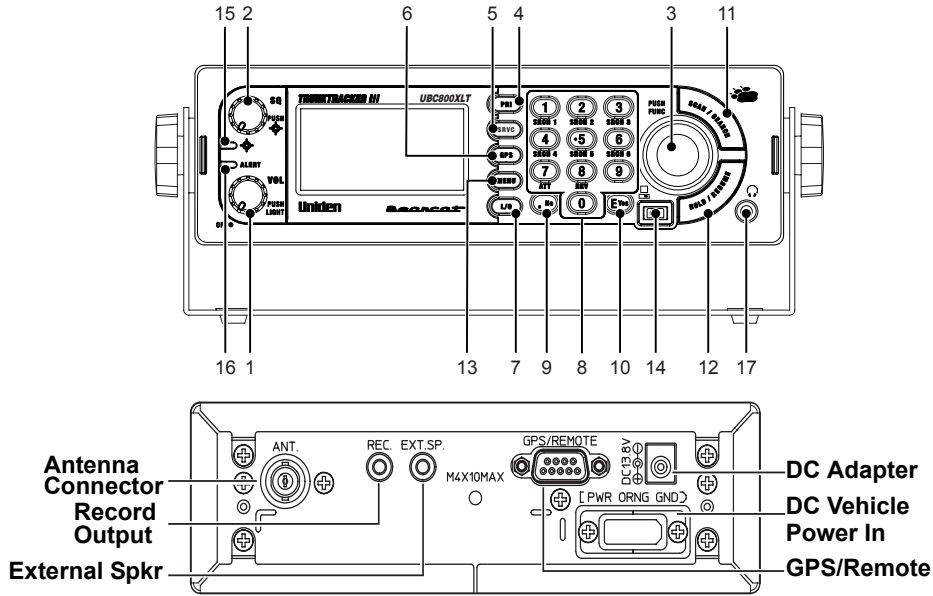





The knobs and keys on the UBC800XLT produce several different actions. You can, for example, rotate the knobs as well as press them to achieve a different result. Pressing a key briefly can produce one result while pressing and holding, gives a different result.

Many controls and keys behave differently depending on the mode your radio is in when you use them. Carefully examine the following table to separate those actions.

Note: “Press” means press and release briefly. “Press and hold” means press and hold down for at least 2-seconds. **●** means **Tap or Press the Scroll Control** to put the scanner into Function mode then press the key under discussion.

| Control/Key | Label | Mode | Action | Result |
|-------------|-------|------|--------|---|
| [Power/VOL] | 1 | All | Rotate | Power ON — Volume Increase or decrease |
| | | All | Press | Backlight enabled and intensity changes: Low - Medium-High -Off |

| Control/Key | Label | Mode | Action | Result |
|---|-----------|---|--|---|
| Squelch | 2 | All | Rotate | Sets the Squelch Level to permit strong signals to be heard with no background noise or lower strength signals with some background noise |
| | | | Press | Toggle: Close Call DND-CC Pri-OFF |
| | | | Press & Hold | Turns on Close Call Only Mode |
| | | |  + Press | Toggles to Tone-Out stand by mode |
| Scroll Control and Function  | 3 | All | Rotate | Turn to change scanning or searching direction. |
| | | Scan or Custom Search | Scroll Control + Rotate | Turn to select System or Search Range |
| | | Hold | Rotate | Turn to Select channel or frequency |
| | | Menu | Rotate | Turn to scroll to menu item-Tap to select current option |
| | | | Press | Use as the <Enter> key for menu choices |
| | | Name Edit | Rotate | Turn to select alpha/numeric entry for names |
| | | Monitor | Rotate | Turn to resume scanning or searching |
| | | GPS |  + Rotate | Turn to operate alphabet skip |
| Function | Press/Tap | Switches to Function Mode; To latch Function Mode, press and hold [Func] | | |
| [PRI] | 4 | Scan | Press | Toggle Priority Mode (On-Plus On-Off) |
| [SRVC] | 5 | All | Press | Open Service Search Select menu |
| [GPS] | 6 | All | Press | Changes to GPS Mode |
| | | GPS | Press & Hold | Stores current GPS data |
| | | |  + Press | Change GPS Display |

| Control/Key | Label | Mode | Action | Result |
|-------------|-------|---|----------------------|--|
| [L/O] | 7 | Scan Search Hold | Press | Temporarily locks out a system channel, a search frequency, or location data. Cancelled when Power is turned off. |
| | | | Press 2X | Permanently locks out system channel, a search frequency, or location data. Remains locked after power cycle. |
| | | Menu | Press | Exit the menu. |
| | | Scan/ Scan Hold | Press & Hold | Enables System Quick Key and Group Quick Key in the current system. Unlocks System, Group and Channel in the current system. |
| | | | ☐ + Press & Hold | Enables all System quick Keys and group Quick Keys and unlocks all systems, groups, channels, and search ranges. |
| | | Search Search Hold Close Call Only Close Call Hold | Press & Hold | Unlocks all frequencies of Global Lockout List. |
| [0] to [9] | 8 | Scan | Press | Enable/Disable selected System/Site Quick Keys |
| | | Custom Search | Press | Turn on and off each custom search number |
| | | All Hold Close Call Tone-Out | Press | Directly enter frequencies or Talk Group IDs |
| | | Scan | ☐ + Press | Enable/Disable Group Quick Key |
| | | Other than Scan or GPS | ☐ + Press [1] to [6] | [1] to [6] to start check of set search range |
| | | Other than Scan or GPS | ☐ + Press [7] | [7/ATT] to toggle attenuator setting |
| | | All | ☐ + [0] | Switches to Display Mode- Mode 1 default |
| | | Scan/Scan Hold | ☐ + [.No] | Enables Trunking activity Indicators |
| | | [4] move left [6] move right | Editing Name | Press |

Controls, Keys, and Functions

| Control/Key | Label | Mode | Action | Result |
|---------------|-------|---|-----------|--|
| [.No] | 9 | All | Press | Cancel error or warning messages |
| | | Hold Close Call Only Tone-Out | Press | Enter [.No] For frequency |
| | | | Press | Enter "." or "I" for TGID |
| | | | Press 2X | Delete current character in name edit |
| | | | Press 3X | Clear all letters in name edit |
| | | | Press | Enter "." or "I" for Direct Entry |
| | | Scan Scan Hold | ☐ + Press | Toggle Active Channel Display On or Off |
| Scan | Press | Starts two-digit of (SQK) System/Site Quick Key | | |
| [Eyes] | 10 | MENU | Press | Use as the <Enter> key for menu choices |
| | | Scan Scan Hold | Press | Edit the channel data for active channel |
| | | Search Search Hold Close Call Close Call Hold | Press | Saves the active frequency |
| | | Tone-Out Standby | Press | Switches to Tone Out edit Menu to change Tone Out Settings |
| [SCAN/SEARCH] | 11 | Scan Hold | Press | Start Scanning |
| | | Other than Scan or Scan Hold or GPS | Press | Instant switch to Scan Mode |
| | | Search Hold | ☐ + Press | Toggle to resume searching |
| | | GPS | Press | Toggle to scanner LCD |
| | | Trunking Scan | ☐ + Press | Toggle ID Search and ID Scan. |
| [HOLD/RESUME] | 12 | Scan Search Close Call Only | Press | Toggles HOLD on or off; In Close Call mode, error tone sounds if no frequency is detected. |

| Control/Key | Label | Mode | Action | Result |
|----------------------|-------|--------------------------|------------------------|---|
| [MENU] | 13 | Scan Scan Hold GPS | ☐ + Press | Initiates edit menu for current system, current search range, or current location data |
| | | Menu | Press | Back up one level in the menu. |
| | | All | Press | Use with Scroll Control to select menu settings |
| Front Serial Port | 14 | Clone & PC connector | Connect Supplied Cable | Connect supplied serial cable to use wired clone mode or create/edit settings with the optional software. |
| Close Call Indicator | 15 | | Lights | Lights to indicate a Close Call hit. |
| Alert Indicator | 16 | | Lights | Lights for various alerts like Non-Radio Location Based GPS Features. |
| Headphone Jack | 17 | All | Insert | Use 1/8-inch audio plug to listen privately. |

A Look At The Display

The display has indicators that show the scanner's current operating status. The display information helps you understand how your scanner operates.

The LCD screens shown here are only a few of many that you will see while in different modes. The ones we show here are more common and will assist you to get started.

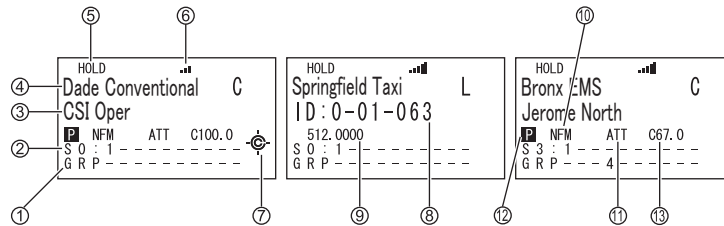

1. Group Quick Key
2. System + Site Quick key
3. Channel Name
4. System Name/
Channel Group Name
5. Hold indicator
6. Signal Strength indicator
7. Close Call enabled
8. Talk group ID Number
9. Talk group Frequency
10. Modulation Type (Narrowband FM shown)
11. Attenuation enabled
12. Priority ON
13. CTCSS or DCS Indicator

Operation

Turning On the Scanner and Setting the Squelch

To turn the scanner on, rotate **[VOL]** clockwise. Turn the knob to a comfortable sound level.

Rotate the squelch control **[SQ]** clockwise until you either hear a broadcast or noise just stops. The control is now set for strong signals. If you desire to hear a weaker signal, turn it counter clockwise from that point until you hear background noise once more.

Startup Key Operation

You can setup a Startup Key Configuration so that the scanner can change the lockout for each system or each site by pressing an assigned key while you power up the scanner or an opening screen is displayed. Navigate to Set Startup Key there are differences in the menu structure for Trunked and Conventional systems.

Conventional

[MENU] → ⤴ Program System → ●
 Select the conventional system → ●
 ⤴ Edit Sys Option → ●
 ⤴ Set Startup Key → ● for each system.









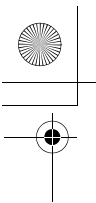

Trunked

[MENU] → ⤴ Program System → ●
 Select the trunked system → ●
 ⤴ Edit Site → ●
 ⤴ Select the site → ●
 ⤴ Set Startup Key → ● for each system or site.

Search Range

[MENU] → ⤴ Search for... → ●
 ⤴ Edit Service → ●
 ⤴ Select a Service Range → ●
 ⤴ Search with Scan → ●
 ⤴ Set Startup Key → ●

OR

[MENU] →  **Search for...** → 
 **Edit Custom** → 
 **Select a Custom Range** → 
 **Search with Scan** → 
 **Set Startup Key** → 

Assign all the systems/sites that you want to scan at the same time to the same startup key [0] to [9]. You can only assign a site/system to one startup key. To leave a system unassigned, press [.No].

Scanning Systems

To begin scanning preprogrammed or programmed systems, press **[SCAN/SEARCH]**. The UBC800XLT scans all unlocked systems in all programmed and activated quick-key groups and any searches unlocked for search with scan.

To enable or disable systems or sites for scanning, press the site/system's System/Site Quick Key while scanning.

Notes:

- If no systems are programmed, or all systems are locked out, **Nothing to Scan** appears. Program a system or select a system to scan.
- When scanning multiple systems, the UBC800XLT scans systems according to the assigned quick key. Systems assigned to quick key 1 are scanned first, then 2, 3, 4, etc. Systems not assigned to a quick key are scanned last, then unlocked searches. Within a quick key, systems are scanned in the order they were assigned.
- Within a system, channels are scanned according to the assigned channel group, with the same priority as described above for systems.
- The UBC800XLT scans a system for the duration you set using the System Hold Time option (see "Setting the System Hold Time" on Page 65). For trunked systems, the scanner moves to the next system after the hold time expires, the current transmission ends, and the channel delay expires. Conventional systems operate similarly, but all unlocked channels are scanned at least one time regardless of the hold time setting.
- Each search range is searched for the amount of time you set using the "Set Hold Time" option. See "Setting the System Hold Time" on Page 65 for more information.

Selecting Systems to Scan

To select systems to scan, press **Scan** then press the quick key assigned to the system or systems you want to scan. For quick keys **[0] - [9]**, press the quick key's number. For quick keys 10-99, press **[.No]** then press the quick key's 2-digit number. To stop scanning the system(s), press **[.No]** (if the quick key is a 2-digit quick key) then the number button or buttons again.



The Sx: (system) indicators on the display show the systems that are currently selected.

To select or lock out a system that is not assigned to a key, press  then rotate the Scroll Control until the desired system is selected. Then, press **[L/O]** within 2 seconds to either lock out or unlock the system.

Selecting System Channel Groups

Within a system, you can assign groups of channels to a group quick key (see "Setting the Group Quick Key" on Page 78).

Follow these steps to activate or deactivate a channel group within a system while scanning.

1. Tap  then turn the **Scroll Control** to switch to the Function Mode. Then  to select the system that has the channel group you want to enable or disable.
2. While **F** still appears on the display, press the number key corresponding to the channel group you want to activate or deactivate.

Locking/Unlocking Systems





Follow these steps to lock out a system so that it does not scan even if its quick key is selected.

1. Tap  to switch to the Function Mode then rotate the control to select the desired system.
2. Press **[L/O]** to temporarily lock out the system. **Temporary L/O** appears. Or, quickly press **[L/O]** twice to permanently lockout the system. **Locked Out** appears.
3. To unlock temporarily locked out systems, turn power off and then back on. To unlock permanently locked out systems, repeat Steps 1 and 2. **System Unlocked** appears.

Locking/Unlocking Channels

If the scanner has stopped on a channel press **[L/O]** once to temporarily lock it out or quickly press **[L/O]** twice to permanently lock it out. Cycling power off/on automatically unlocks temporarily locked-out channels.

To lockout a channel when the scanner has not stopped on the channel, or to unlock a permanently locked-out channel.

1. Press **[HOLD/RESUME]** to hold on a channel.
2. Tap  to switch to the Function Mode, then rotate the control  to select the system where the channel is stored.
3. Tap  or wait 2 seconds, then rotate the **Scroll Control**  to select the channel you want to lock or unlock.
4. Press **[L/O]** to temporarily lock or unlock the current the channel. Double-tap L/O to permanently lockout the current channel.

ID Scan/ID Search Mode



While you are scanning a trunked system, the scanner can be in either ID Scan or ID Search mode:

- ID Scan — the scanner only stops on talk group ID's (TGID) that you have programmed into the system that are unlocked.
- ID Search — the scanner stops on any unlocked talk group that becomes active.

To toggle between ID Scan and ID Search, press  then press **[SCAN/SEARCH]** while the scanner is scanning the system.

If the scanner does not scan the system long enough for you to easily do this, press  and rotate the **Scroll Control** to select the changed system. Then, press **[SCAN/SEARCH]** within 2 seconds.

Holding On a System

To temporarily hold on a system, tap . To hold on a different system, tap  then rotate the control to select the system. Normal scanning resumes 2 seconds after your last selection.

To permanently hold on a site or system, press and hold the **Scroll Control** for 2 seconds. **F** flashes in the display's upper left corner. The scanner continues to

scan only the current system. To hold on a different site or system, rotate the **Scroll Control**  to select the new site or system then press **[EYES]**.

Holding On a Channel

To hold on a channel, press **[HOLD/RESUME]** while the channel is active. To select a different channel, turn the **Scroll Control**. If you scroll past the beginning or end of the current system, the scanner selects channels in the previous or next system. To resume scanning, press **[SCAN/SEARCH]**.

Quickly Storing an ID During ID Search

To quickly store an active talk group ID during ID search, press **[EYES]**. You see: **Quick TGID Save?**

To save the ID into a channel, press **[EYES]**. Otherwise, press **[.No]**. If you press **[EYES]**, the scanner stores the ID into a channel group called **Qck Save Grp** in the current system.

Quick-Storing Channels or Talk Group ID's (TGID)

1. Hold on an existing channel in any system.
2. Enter the frequency or talk group ID you want to store (press **[.No]** twice to enter hyphens in talk group ID's).
3. To quick-store the channel or talk group ID, press **[EYES]**. Otherwise, press **[.No]**.

If you enter a frequency then press **[EYES]**, the scanner stores it in the **Qck Save Grp** group in a system called **Qck Save Cnv Sys**. These groups are created if they do not exist. Then, the scanner prompts you to save other channel settings.

If you enter a talk group ID then press **[EYES]**, the scanner stores it into a channel group named **Qck Save Grp** in the current system. If the talk group ID's format is not the type used by the current system, the scanner displays an error message and does not save the talk group ID.

If you pressed **[.No]** in Step 3, the scanner prompts you to select the system and the group where you want to store the frequency or talk group ID.

Note: The scanner will warn you if you try to store two channels in the same system that have the same frequency or Talk Group ID or if you try to store two systems with the same name.

Trunking Activity Indicators

To get a visual indication of the activity on trunking systems, press **[HOLD/RESUME]** to hold on any channel. Then tap  and then press **[.No]** The scanner replaces the third line on the display with trunking activity indicators. When the scanner is monitoring on EDACS or Motorola system, the activity indicators will show which system frequencies have activity.

Note: For Motorola systems you must program all system frequencies (control and voice frequencies) for this feature to work.

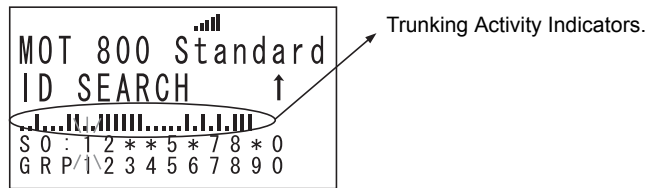

Toggling the Display Mode

To change the display so the channel and frequency or Talk Group ID appear instead of extended channel information, hold on any channel then press **[M] + [0]**. The scanner displays **Display Mode 2**. To return to Mode 1, press **[M] + [0]**

Mode1 indicates the **channel data** under the Channel Name.

Mode2 indicates the **frequencies** under the Channel Name for Conventional systems or the TGID number for Trunked systems.

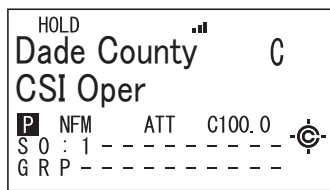

Channel Name Display Mode 1

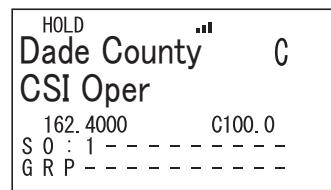

Channel Name Display Mode 2

Using the Menu

The UBC800XLT incorporates an effective menu system that lets you make all the necessary setting options required to program the scanner and effectively use the many features. To use the menu, press **[MENU]**.

You immediately see the screen display the menu title at the top and three of ten menu options beneath. Using the Multifunction Scroll Control, you can rotate the control left or right to quickly review all ten listings.

The depth of each menu selection is extensive. For the purpose of this manual, the following chart indicates the primary menu selection, the purpose of that selection, and a reference to the page or pages that provide the details associated with the option.

| Menu Item | Let's You... | For Detail, See... |
|------------------|---|--|
| Program System | Select options related to setting up a new system or editing one already programmed. | See "Scanner Programming" reprint. |
| Program Location | Choose GPS related locations for data to alert, confirm location, and provide you with an audible warning if desired. | |
| Srch/CloCall Opt | Lets you adjust settings that affect the scanner during search and Close Call operation | See "Search and Close Call Options" on Page 98 |
| Search for... | Choose and search programmed ranges of desired services | See "Searching and Storing" on Page 86 |
| Close Call | Setup the radio to receive, and let you hear, nearby strong stations. | See "Using the Close Call Feature" on Page 94 |
| Set Priority | Lets you scan a conventional system and check for designated priority channels. | See "Priority Scan" on Page 103 |
| Tone-Out for... | Select up to 10 Tone-Out settings or Standby | See "Fire Tone-Out" on Page 105 |
| Wired Clone | Copy data directly from one UBC800XLT to another UBC800XLT. | See "Wired Cloning" on Page 56 |
| Settings | Choose settings for miscellaneous but convenient options. | See the respective pages for each option: |

Programming General Settings

This section covers your scanners general settings.

Setting and Using the Backlight

The LCD has a backlight that can be set with three levels of intensity plus **OFF**.

To make your selection, press **[VOL]**. Each time you press the control, the backlight cycles in the following order.

OFF — Low Intensity — Medium Intensity — High Intensity





When you stop at the desired level, the scanner remembers your setting the next time you turn on the scanner.

You can also set the backlight using the menu.

Setting the Dimmer

If you connect the orange wire to a wire in your car that changes state when you turn on the headlights, the scanner can automatically dim the display when you turn on the headlights.

Tapping **[VOL]** overrides the menu setting and cycles through all backlight settings.

[MENU] →  **Settings** → 
 **Set Backlight** → 



Auto — Use this setting if you have connected the scanner to your vehicle's headlights using the orange wire. If you have connected the wire, the scanner automatically dims the backlight when you turn on the headlights. After selecting this option, select either:

+ **Polarity** — If the headlight wire is connected to +12V when the headlights are on.

- **Polarity** — If the headlight wire is connected to vehicle ground when the headlights are on.

Manual — Use this setting to manually set the dimmer level to **High**, **Middle**, **Low**, or **Off**. To guide you in your selection, at each setting the display shows what you can expect to see.

Adjusting the Key Beep



[MENU] → ⤴ Settings → 
⤴ Adjust Key Beep → 

Auto — the scanner automatically sets the key beep to match the master volume setting level you select.

Level 1 - 15 — the scanner lets you manually select one of fifteen key beep levels. As you turn the **Scroll Control**, the beep gets louder. Press  when you reach the desired level.

off — the scanner turns the key beep off.

Setting the Audio AGC

[MENU] → ⤴ Settings → 
⤴ Set Audio AGC → 

This setting helps balance the audio level you hear as you listen to different radio sources so you can hear them at a similar volume. Use this setting if you listen to an audio source that has natural changes in audio level for which you want to compensate.



You can set the mode to be on or off.

⤴ to select either **on** or **off**.

on — AGC is enable.

off — AGC is disable.



Setting the Display Orientation

[MENU] → ⤴ Settings → 
⤴ Set Upside-down → 



This setting controls the orientation of the display. If you set Upside-down to **on**, the scanner inverts the display text and graphics.

Adjusting the Display Contrast

There are 15 contrast levels. As you scroll from level 1 to 15 you see the contrast change. Press the **Scroll Control** to lock the desired level until the time you desire to change it.



[MENU] → ⤷ Settings → 
Adjust Contrast → 
⤷ Select a level Level 1 to Level 15 → 

Setting the GPS Format

[MENU] → ⤷ Settings → 
⤷ Set GPS Format → 

These settings control how the scanner handles GPS input when you are using the location-based functions.

Setting the Position Format



[MENU] → ⤷ Settings → 
⤷ Set GPS Format → 
⤷ Set Pos Format → 

This setting controls the format used for entering GPS coordinates into the scanner.

DMS: DDD° MM' SS.ss — Enter the location in Degree, Minute, Second format.

DEG: DDD.dddddd — Enter the location in Degree and fraction format.

Setting the Time Format



[MENU] → ⤷ Settings → 
⤷ Set GPS Format → 
⤷ Set Time Format → 

This setting controls the format used for displaying the time on the GPS data screens.

12H — the scanner displays time in 12-hour format using am for mornings and pm for evening times.

24H — the scanner displays time in 24-hour format using 0 for midnight and 23 for 11 pm.

Setting the Time Zone

[MENU] → ⤷ Settings → 
⤷ Set GPS Format → 
⤷ Set Time Zone → 

This setting controls the format used for adjusting Universal time to local time. Set your local time's offset from UTC (formally known as GMT).

Setting the Distance Units

[MENU] → ⤴ Settings →
⤴ Set GPS Format →
⤴ Set Unit →

This setting controls the distance units shown in the GPS data screens and used for entering distance for POI's

mile — The scanner uses miles.

km — The scanner uses kilometers.

The selection items of the location range and the speed also changes by this selection.

Setting the Serial Port Speed

[MENU] → ⤴ Settings →
⤴ Set Serial Port →
⤴ Set Baud Rate →
⤴ Set Front Port Or Set Rear Port →



Use this setting to control the data rate used for the front and back panel serial ports. You typically set the front port to match the speed used to communicate with your PC (default 115200 bps) and the back port to the speed used to communicate with an attached GPS (default 4800 bps). Note that the back port is male. You may need a gender changer and a null modem adapter to use a typical DB9 serial cable from the rear port.

For Serial Port Speed (Baud Rate), select from

- 4800 bps
- 9600 bps
- 19200 bps
- 38400 bps
- 57600 bps
- 115200 bps
- OFF

Displaying Scanner Information



Viewing Memory Used

[MENU] → ⤷ Settings → 
 ⤷ See Scanner Info → 
 ⤷ % Memory Used → 

The scanner displays the percent of memory that is used and the number and the percent of systems, sites and channels that are created.

Press any key to return to the previous menu, then press any key to exit the menu.

Viewing the Firmware Version

[MENU] → ⤷ Settings → 
 ⤷ See Scanner Info → 
 ⤷ Firmware Version → 

Press any key to return to the previous menu, then press any key.

Initializing the Scanner's Memory

Warning: This clears data **you** have entered. You cannot restore user programmed data that has been deleted. You can, at a last step, restore only the original factory data.

1. To initialize the scanner's memory, turn off the scanner.
2. While pressing [2], [9], and [HOLD] at the same time, turn on power.

At that point anything you have programmed is gone.

Connecting Your Scanner to a Personal Computer

You can connect your scanner, by means of the supplied cable, to a personal computer to download data from the computer to the memory of the scanner. Before you proceed, you must first set the scanner's communications speed as described in the previous section.

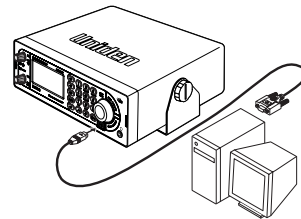

Programming General Settings

Important: Start with a high baud rate setting. If, during transfer, you get an error message, reduce the setting and start again until you get reliable, complete transfer of data.

Volume/Squelch with PC Control

If you use a PC to control the scanner, and you change the scanner's volume or squelch setting using the PC, the scanner ignores the front-panel control's current setting. However, if you later change the volume or squelch setting using the front-panel control, the scanner uses the control's setting (i.e. the scanner pays attention to the last method used).

Wired Cloning

Using the scanner in a cloning setup lets you transfer programmed data directly from a *source* or **master** UBC800XLT to a *target* or **slave** UBC800XLT. Wired cloning between other models to the UBC800XLT is not possible.

[MENU] → **Wired Clone** → **Master** or **Slave** (select one as the master and one as the slave)

To clone (transfer) data directly from one UBC800XLT scanner to another UBC800XLT scanner, you must first connect the scanners to each other using the included connection cables and a DB9 null modem adapter and for the rear port, a DB9 gender changer (neither included), available at most computer stores. Then you must set one scanner as the source and the other as the target.

Connected as shown, and with both ports correctly selected, no other hardware is needed.

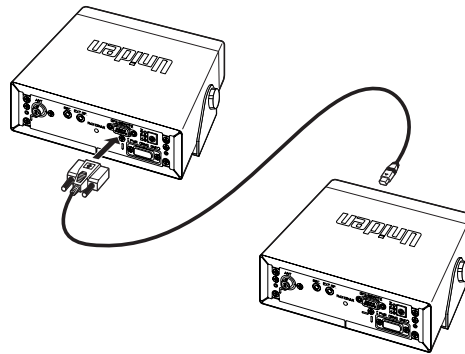

1. Select the Front Port for the Master. Select the Rear Port for the Slave or vice versa.
2. Plug the 9-pin serial connector into the unit designated as the Rear Port.
3. Plug the smaller connector into the front port of the unit designated as Front Port.

4. When you are ready to clone the scanner, press **[SCAN/SEARCH]** on the slave scanner **first**, then **[SCAN/SEARCH]** on the master scanner. The master scanner checks the connection between the two scanners, then transfers its data to the slave scanner.

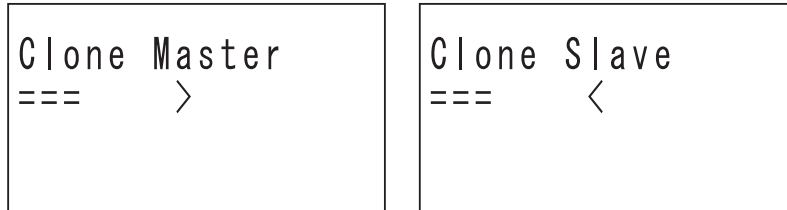

5. When the transfer is complete, **Complete** appears on both scanners. If the transfer did not work, **Error** appears on the master scanner. Readjust the baud rate to a lower setting and try again.

Programming Your Scanner

1. Plan the system.
2. Program the system into your scanner according to the plan you prepared in Step 1.

General Notes

You can store up to 6000 channels in up to 500 systems.

Each trunking system can have up to 256 sites and up to 250 trunked channels (TGID). Each conventional system can have up to 1000 channels.

Your scanner can have up to a total of 1000 sites. Each system can have up to 20 channel groups.

The following table provides you the information to successfully perform various steps connected with programming each of the systems: Conventional, Motorola, EDACS, and LTR. Some operations are common to all of the systems while some are specific to a given system. Use the following table to quickly locate the step you want or need to perform (where required), the reference page for that step, and to which system or systems it applies.

System Settings

| System Settings | CNV | MOTOROLA | | EDACS | | LTR | See Pages |
|-----------------|-----|----------|---------|--------------|------|-----|-----------|
| | | TYPE I | TYPE II | Wide /Narrow | SCAT | | |
| Edit Name | • | • | • | • | • | • | P. 63 |
| Edit Sys Option | • | • | • | • | • | • | P. 64 |
| Edit Site | | • | • | • | • | • | P. 71 |
| Edit Group | • | • | • | • | | • | P. 77 |
| Copy System | • | • | • | • | • | • | P. 71 |
| Delete System | • | • | • | • | • | • | P. 71 |

System Options

| System Option Settings | CNV | MOTOROLA | | EDACS | | LTR | See Pages |
|------------------------|-----|----------|---------|--------------|------|-----|-----------|
| | | TYPE I | TYPE II | WIDE/ NARROW | SCAT | | |
| Set Quick Key | • | | | | | | P. 64 |
| Set Startup Key | • | | | | | | P. 65 |
| Set Lockout | • | | | | | | P. 65 |
| Set Hold Time | • | | | | | | P. 65 |
| ID Scan/Search | | • | • | • | | • | P. 66 |
| Set Delay Time | • | • | • | • | • | • | P. 66 |
| Set Data Skip | • | | | | | | P. 66 |
| Set LocationInfo | • | | | | | | P. 66 |
| Edit Fleet Map | | • | | | | | P. 67 |
| Set Status Bit | | • | • | | | | P. 67 |
| Set End Code | | • | • | | | | P. 68 |

| System Option Settings | CNV | MOTOROLA | | EDACS | | LTR | See Pages |
|------------------------|-----|----------|---------|-----------------|------|-----|-----------|
| | | TYPE I | TYPE II | WIDE/ NARROW | SCAT | | |
| Set I-Call | | • | • | • | | | P. 68 |
| Emergency Alert | | • | • | • | | | P. 68 |
| EDCS ID Format | | | | • | | | P. 69 |
| Set Record | • | • | • | • | • | • | P. 69 |
| Rvw ID:Srch L/O | | • | • | • | | • | P. 70 |
| Clr All L/O IDs | | • | • | • | | • | P. 70 |

Site Settings

| Site Setting | MOTOROLA TYPE I | | MOTOROLA TYPE II | | | | | EDACS | | | L T R |
|------------------|-----------------|-----------------|------------------|-----------------|-------------|----------|----------|-------|--------|------|-------------|
| | 800MHz Standard | 800MHz Splinter | 800MHz Standard | 800MHz Splinter | 900MHz Band | VHF Band | UHF Band | WIDE | NARROW | SCAT | |
| Edit Name | • | • | • | • | • | • | • | • | • | | |
| Set Quick Key | • | • | • | • | • | • | • | • | • | • | • |
| Set Startup Key | • | • | • | • | • | • | • | • | • | • | • |
| Set Frequencies | • | • | • | • | • | • | • | • | • | • | • |
| Set Modulation | • | • | • | • | • | • | • | | | | • |
| Set Attenuator | • | • | • | • | • | • | • | • | • | • | • |
| Set Lockout | • | • | • | • | • | • | • | • | • | • | • |
| Set Hold Time | • | • | • | • | • | • | • | • | • | • | • |
| Edit Band Plan | | | | | | • | • | | | | |
| Set C-Ch Only | • | • | • | • | • | • | • | | | | |
| Set LocationInfo | • | • | • | • | • | • | • | • | • | • | • |
| Delete Site | • | • | • | • | • | • | • | • | • | | |
| New Site | • | • | • | • | • | • | • | • | • | | |

Channel Settings

| Channel Setting | CNV | MOT TYPE I | MOT TYPE II | EDACS | LTR |
|-----------------|-----|------------|-------------|-------|-----|
| Edit Name | • | • | • | • | • |
| Edit Frequency | • | | | | |
| Edit TGID | | • | • | • | • |
| Set CTCSS/DCS | • | | | | |
| Set Modulation | • | | | | |
| Set Attenuator | • | | | | |
| Set Priority | • | | | | |
| Set Alert | • | • | • | • | • |
| Set Record | • | • | • | • | • |
| Set Lockout | • | • | • | • | • |
| Copy Channel | • | • | • | • | • |
| Delete Channel | • | • | • | • | • |
| New Channel | • | • | • | • | • |

Programming Conventional Systems

[MENU] → Program System →

New System →

Conventional →

Confirm? Yes="E" / No="."

The scanner creates an empty conventional system with a default name of **System n C**. Note that "n" is a number that increments as you add new systems. The c on the right side of the display indicates that this is a conventional system. After creating the system:

1. Set system-level settings that apply to conventional systems in "Programming System Settings."
2. Create one or more channel groups with channels as described in "Programming Channel Groups."

Programming Trunked Radio Systems

[MENU] → Program System → 
 New System → 

Then, select the system type:

MOT TYPE 1 — Motorola Type I systems

MOT TYPE 2 — Motorola Type II systems

EDCS WIDE/NARROW — EDACS Wide and Narrow systems

EDCS SCAT — EDACS SCAT systems

LT — LTR Systems

The scanner creates an empty system with a default name of **System n x**. Note that “n” is a number that increments as you add new systems. The “x” on the right side of the display is M for Motorola system, E for EDACS systems, and L for LTR systems. After creating the system:

1. Set the system-level settings in “Programming System Settings” that apply to the type of system you selected.
2. Set up at least one site for the system as described in “Programming Sites” on “Programming Sites” on Page 71.
3. To scan specific channels, create one or more channel groups with channels as described in “Programming Channel Groups.”

Programming System Settings

Throughout the following sections, you will notice a heading on the right, such as **MECLS** in the next section. This helps designate the system types to which the section applies. In this section, the instructions apply to **M** (Motorola), **E** (EDACS Wide/Narrow), **C** (Conventional), **L** (LTR), and **S** (EDACS SCAT).

Editing the System Name

MECLS

Each system name can be up to 16 characters. Abbreviate as necessary to fit. For Motorola and EDACS Wide/Narrow systems, the system name only appears in the scanner menu’s Program System listings. It is not shown during scanning. For other systems, the system name alternates with the Channel group when the scanner stops on a channel.

The default system names include the following letter in the 16th position to indicate the system type: **M** = Motorola; **E** = EDACS; **L** = LTR; **c** = Conventional;





Programming Your Scanner

Specifying the Correct System Type

In order for trunk tracking to work properly, you have to specify the correct system type when you create the system. Here are some tips for selecting the correct type:

- Use online resources, such as the *www.radioreference.com* database, to identify the system type.
- EDACS Wide is the same as EDAC Standard.
- EDACS Networked sites are EDACS Narrow

Following these steps to change the system name.

[MENU] → Program System → 
 Select the system → 
 Edit Name → 

To enter a letter, turn the **Scroll Control** until the character you want appears. To enter a decimal point, press [.No]. To move the cursor to the left, press [4]. To move the cursor to the right, press [6].

To clear a character, press [.No] twice. To clear all characters, press [.No] 3 times.







To accept an entry, press [EYES] or 

Programming System Options

MELCS

Editing the System Quick Key

C

[MENU] → Program System → 
 Select a conventional system → 
 Edit Sys Option → 
 Set Quick Key → 

After selecting this option, select any number from 0-99 to assign the system to a quick key or press [.No] to assign the system to no quick key, then press 

Notes:

- Access single-digit system/site Quick Keys by pressing the single digit on the keypad during scanning. Access two-digit system Quick Keys by pressing [.No] then both digits.
- You can assign as many systems to the same quick key as you want.
- To be scanned, a system's Quick Key must be activated and the system must be unlocked.

Setting the Startup Key C

- [MENU] → Program System →
- ↻ Select a conventional system →
- ↻ Edit Sys Option →
- ↻ Set Startup Key →

Select a startup key from 0-9 or select **[.No]** for no startup key.

Notes:

- To unlock the system at startup, press and hold the selected startup key while you apply power. If you do not press the startup key at the time you turn on power, you can still act while the opening screens are displayed.
- The system Quick Key is also enabled.
- If you press a different key at startup, the system is locked out.
- If you do not assign the system a startup key, the system is not affected by any key press during startup.

Setting the System Lockout C

- [MENU] → Program System →
- ↻ Select a conventional system →
- ↻ Edit Sys Option →
- ↻ Set Lockout →

Unlocked — The system is scanned when its quick key is enabled.

Temporary L/O — The system is not scanned, even if its quick key is enabled. Cycling power removes the lockout.

Lockout — The system is not scanned, even if its quick key is enabled. You must manually unlock the system.

Setting the System Hold Time C

- [MENU] → Program System →
- ↻ Select a conventional system →
- ↻ Edit Sys Option →
- ↻ Set Hold Time →

Set how long the scanner will remain scanning on this system before moving to the next system (up to 255 seconds). Note that the scanner will scan all unlocked channels at least one time, regardless of the system hold time setting.

Programming Your Scanner

Setting ID Scan/ID Search

MEL

- [MENU] → Program System →
- ↻ Select a system →
- ↻ Edit Sys Option →
- ↻ ID Scan/Search →

Sets whether the scanner only stops on talk groups you have programmed in (ID Scan) or whether the scanner stops on any unlocked channel (ID Search).

Setting Channel Delay Time

MELCS

- [MENU] → Program System →
- ↻ Select a system →
- ↻ Edit Sys Option →
- ↻ Set Delay Time →

This setting controls how many seconds the scanner waits after a transmission ends before resuming scanning. Enter a value from [1] to [5] or off, then press.

Notes:

- The default setting is 2 seconds for each system.
- This setting applies to all channels within the system.

Setting Data Skip

C

- [MENU] → Program System →
- ↻ Select a Conventional system →
- ↻ Edit Sys Option →
- ↻ Set Data Skip →

This setting controls whether the scanner automatically skips channels it identifies as data. This includes channels with either no audio or a constant-level audio source. If turned on, the scanner resumes scanning as soon as it detects the data signal.

Setting Location Information

C

- [MENU] → Program System →
- ↻ Select a Conventional system →
- ↻ Edit Sys Option →
- ↻ Set LocationInfo →

This setting control whether the system is automatically enabled and disabled when you connect a GPS to the scanner.

Set Latitude — Enter the system's latitude using the format you selected in the system settings.

Set Longitude — Enter the system's longitude using the format you selected in the system settings.

Set Range — Set the system's range using the units you selected in the system settings.

Set GPS Enable — L/O status is automatically controlled by receiving data from GPS.

Setting the Fleet Map

M (Type I Only)

- [MENU] → Program System →
- ↻ Select a Motorola Type I system →
- ↻ Edit Sys Option →
- ↻ Edit Fleet Map →

Preset — select from the 16 most common fleet maps

Custom — allows you to enter a custom fleet map. Enter the size code (0 to 14) for each block. Press to select.

For Motorola Type I and Type III Hybrid systems, you must enter a system fleet map in order for the scanner to properly track and display talk group ID's. The fleet map is usually included in the same resource that provided system frequencies and talk group ID lists.

Note: If you don't know the fleet map for your Motorola Type I system, check the Internet such as www.radioreference.com or the other websites we reference.

Setting the Status Bit

M

- [MENU] → Program System →
- ↻ Select a Motorola Type I or II system →
- ↻ Edit Sys Option →
- ↻ Set Status Bit →

Ignore — the scanner rounds all received ID's down to the next interval of 16. The default setting is **Ignore**.





Yes — the scanner treats all received ID's as unique ID's.

Programming Your Scanner

Note: Motorola analog systems use talk group ID's in multiples of 16. ID numbers that fall between these ID's indicate special status flags for the system. This setting determines how the scanner will handle ID's that are not multiples of 16. Select your setting then press .

Setting End Code Operation

M

[MENU] → Program System → 
 ↻ Select a Motorola Type I or II system → 
 ↻ Edit Sys Option → 
 ↻ Set End Code → 

This setting determines how the scanner handles the transmission end code sent by most Motorola systems. Select your setting then press .





Yes — the scanner immediately returns to the control channel when it detects the end code.

Ignore — the scanner does not return to the control channel until the carrier drops.

Note: The default setting is **Yes**.

Setting I-Call Operation

ME

[MENU] → Program System → 
 ↻ Select a Motorola Type I, II or EDACS Wide/Narrow system → 
 ↻ Edit Sys Option → 
 ↻ Set I-Call → 

This setting determines how your scanner treats I-calls while ID Searching.

on — the scanner tracks I-calls.



off — the scanner ignores I-calls. The default setting is **off**.

only — the scanner only tracks I-calls and ignores other radio traffic on the system. Press  to select.

Note: To set the I-Call to a wildcard receive condition, press [.No] + [0].

Setting the Emergency Alert Option

ME

[MENU] → Program System → 
 ↻ Select a Motorola Type I, II or EDACS Wide/Narrow system → 

- ↻ **Edit Sys Option** →
- ↻ **Emergency Alert** →

off — the scanner does not alert you to emergency transmissions.

Alert 1 - 9 — the scanner sounds an alert beep to notify you of the emergency transmission. The default alert is **off**. You can choose any of 9 different beep types. Once you choose an alert tone, next:

- ↻ → **Set Level** →

Auto — the scanner automatically sets the emergency alert beep to the master volume level.

Level 1 - 15 — the scanner adjusts the volume you hear to the level you select.

Setting the EDACS ID Format

E

- [MENU] → **Program System** →
- ↻ **Select an EDACS Wide/Narrow system** →
- ↻ **Edit Sys Option** →
- ↻ **EDCS ID Format** →

EDACS Talk Group ID's are commonly provided in one of two formats: **AFS** and **Decimal**. This setting determines how you enter EDACS ID's and how the scanner displays them.

AFS Format — the scanner uses AFS format for Talk Group ID's

Decimal Format — the scanner uses decimal format for Talk Group ID's

Note: The scanner defaults to AFS (agency, fleet, subfleet) format - the format used in most EDACS systems.

Setting the System Record Option

MELCS

- [MENU] → **Program System** →
- ↻ **Select a system** →
- ↻ **Edit Sys Option** →
- ↻ **Set Record** →

This setting controls how the scanner handles the record option for channels in the system.

All Channel — The scanner sends the audio for all channels in the system to the **REC** jack, regardless of the channel's record option setting.

Marked Channel — The scanner only sends the audio for channels that have the Record option turned on to the **REC** jack.

off — The scanner does not send any audio from any channel in the system to the **REC** jack, even if the record option is turned on for a channel.

Note: In order for the function to work, you must set the channel to record. You must also set the system's record option to either **All Channel** (which will record all channels regardless of the channel's record setting) or **Marked Channel** (which only records the channels you've set to record).

Reviewing ID Search Lockouts

MEL

- [MENU] → Program System →
- ↻ Select a trunked system →
- ↻ Edit Sys Option →
- ↻ Rvw ID: Srch L/O →

The scanner displays each ID you have locked out in ID Search mode and gives you the option to unlock the ID. To unlock an ID, rotate the scroll to select the locked out ID, then press [EYES]. If no ID's are locked out, the scanner displays "Nothing Locked / Press Any Key."

Clearing All Locked Out ID's

MEL

- [MENU] → Program System →
- ↻ Select a trunked system →
- ↻ Edit Sys Option →
- ↻ Clr All L/O IDs →

To quickly unlock all IDs in the system, answer "Y" to "Confirm? Unlock All (Y/N)."

Editing Sites

MESL

Use this option to enter and edit site information for the current system. See "Programming Sites" on Page 71 for instructions for each site option. Note that you must program at least one site for each trunked system in order for your scanner to scan the system.

Editing Channel Groups

MECL

Use this option to enter and edit channel groups and channel information. See "Programming Channel Groups" for instructions for each channel group and channel option. Note that you must program at least one channel group and one channel for each conventional system in your scanner. You do not have to enter

channel group information for trunked systems, but doing so makes it easier to follow specific talk groups.

Copying Systems

MECSL

Occasionally you might want to copy and rename a system to highlight one group over another.

One system might be called City - Fire and the same system City - PD with adjustments to data within.

This lets you quickly locate the desired set of data.

To copy a system including all settings, groups, and channels:

[MENU] → Program System →

↻ Select the existing system →

↻ Copy System →

New Sys Name?

Enter your new name using the **Scroll Control** and [4] and [6] to traverse the display and enter characters. Press **Enter** when finished.

Deleting Systems

MECSL

[MENU] → Program System →

↻ Select the existing system →

↻ Delete System →

Confirm Delete?

Yes="E" / No= "."

Important: Deleted systems cannot be restored. You must re-enter them.

Programming Sites

MESL

This section covers settings that apply to trunked radio site. You must program at least one site for each trunked radio system. When you program multiple sites, all sites share the same channel groups and channels within the system.

Note: You can only program one site in an EDACS SCAT and LTR system.

Setting the Site Name

ME

Each site name can be up to 16 characters. Abbreviate as necessary to fit. The site name alternates with the Channel group when the scanner stops on a channel.

The default site names include the following letter in the 16th position to indicate the system type:

- MS1: Motorola 800 MHz Type I Standard**
- MS2: Motorola 800 MHz Type II Standard**
- MP1: Motorola 800 MHz Type I Splinter**
- MP2: Motorola 800 MHz Type II Splinter**
- M92: Motorola 900 MHz**
- MV2: Motorola VHF**
- MU2: Motorola UHF**
- EDW: EDACS Wide**
- EDN: EDACS Narrow**

Follow these steps to change the system name.

- [MENU] → Program System →**
- ↻ Select a trunked system →**
- ↻ Edit Site →**
- ↻ Select a Site →**
- ↻ Edit Name →**

To enter a letter, turn the **Scroll Control** until the character you want appears. To enter a decimal point, press **[.No]**. To move the cursor to the left, press **[4]**. To move the cursor to the right, press **[6]**.

To clear a character, press **[.No]** twice. To clear all characters, press **[.No]** 3 times.

To accept an entry, press **[YES]** or **[OK]**.

Setting the Site Quick Key

MESL

- [MENU] → Program System →**
- ↻ Select a trunked system →**
- ↻ Edit Site →**
- ↻ Select a Site →**
- ↻ Set Quick Key →**

After selecting this option, select any number from 0-99 to assign the system to a quick key or press **[.No]** to assign the system to no quick key, then press **[OK]**.

Notes:

- Access single-digit system/site Quick Keys by pressing the single digit on the keypad during scanning. Access two-digit system Quick Keys by pressing **[.No]** then both digits.
- You can assign as many systems to the same quick key as you want.
- To be scanned, a system/site's Quick Key must be activated and the system must be unlocked.

Setting the Site Startup Key

MESL

- [MENU] → Program System →
- ↪ Select a trunked system →
- ↪ Edit Site →
- ↪ Select a Site →
- ↪ Set Startup Key →

Select a startup key from **[0]** to **[9]** or select **[.No]** for no startup key.

Notes:

- To unlock the system at startup, press and hold the selected startup key while you turn on the scanner.
- The system/site's Quick Key is enabled when it is unlocked.
- If you press a different key at startup, the system is locked out.
- If you do not assign the system a startup key, the system is not affected by any key press during startup.

Setting Site Frequencies

MESL

- [MENU] → Program System →
- ↪ Select a trunked system →
- ↪ Edit Site →
- ↪ Select the site →
- ↪ Set Frequencies →
- ↪ New Frequency (or select an existing frequency) →

Input a system frequency using the number keys and **[.No]** key, then press . If you are entering frequencies for an LTR or EDACS system, the scanner also prompts you to enter the LCN for the frequency you just entered. Obtain LCN's (logical channel numbers) from the same source as the other system information. To enter additional frequencies, press **[MENU]**, then ↪ to select **New Frequency**. Then repeat the above.

Note: If you select Control Channel Only mode (see “Setting Control-Channel Only (Motorola Systems Only)” on Page 76), you only need to enter the frequency(s) that can be assigned as the control channel. Most frequency lists usually indicate which of the frequencies are the control channel frequencies. Otherwise, you must enter all of the frequencies.

Setting Site Modulation

ML

- [MENU] → Program System →
- ↻ Select a trunked system →
- ↻ Edit Site →
- ↻ Select a Site →
- ↻ Set Modulation →

Auto — the scanner uses the default modulation for the frequency band.

NFM — the scanner uses narrowband FM for the frequency band.

FM — the scanner uses FM (frequency modulation) for the frequency band.

Note: The default setting is **Auto**.

This setting controls the modulation method used for the frequency band. In most cases, if you leave this set to **Auto**, the scanner automatically selects the correct modulation type for the system you are programming.

Setting Site Attenuation

MESL

Enable Attenuation if you are near strong signal sources. Attenuation can help reduce interference and desensitization that strong signals create. You can also turn this setting on or off by holding on a trunked system, then pressing + [7].

- [MENU] → Program System →
- ↻ Select a trunked system →
- ↻ Edit Site →
- ↻ Select a Site →
- ↻ Set Attenuator →

off — the attenuator is off.

on — site frequencies are attenuated by about 20 dB.

Setting Site Lockout

MESL

- [MENU] → Program System →
- ↻ Select a trunked system →

- ↻ **Edit Site** →
- ↻ **Select a site** →
- ↻ **Set Lockout** →
- ↻ **Select from the following choices then press**

Unlocked — the system is scanned when its quick key is enabled.

Temporary L/O — the system is locked for this session.

Lockout — the system is not scanned.

Setting Site Hold Time

MESL

- [MENU] → **Program System** →
- ↻ **Select a trunked system** →
- ↻ **Edit Site** →
- ↻ **Select a site** →
- ↻ **Set Hold Time** →

This setting controls how many seconds the scanner looks at a site before moving to the next unlocked site or system. Using the number keypad, enter a value from 0-255, then press to save the setting.

Notes:

- If the scanner cannot detect a control channel on an EDACS or Motorola system, it immediately moves to the next site or system. The scanner always scans LTR or SCAT systems for at least 1 second to check for current activity.
- If you select 0 and the control channel is received, the scanner stays on the system for a minimal time (only long enough to check current system activity).
- The default setting is 2 seconds for each system.
- The scanner moves to the next system after the hold time expires, any current transmission ends, and the channel delay time expires.

Editing the Band Plan

M (VHF and UHF only)

In order for the scanner to scan Motorola VHF and UHF sites, you must enter parameters that allow the scanner to determine the frequencies in use by the system. This information is normally available at the same source where the other system information is found.

- [MENU] → **Program System** →
- ↻ **Select a trunked system** →
- ↻ **Edit Site** →

Programming Your Scanner

- ↻ Select a site →
- ↻ Edit Band Plan →

You can enter up to 3 band plans. Select the plan to enter or edit, then follow the prompts to enter the Base Frequency, Channel Step, and Channel Offset for the site.

Setting Control-Channel Only Mode

M

- [MENU] → Program System →
- ↻ Select a trunked system →
- ↻ Edit Site (current) →
- ↻ Select site →
- ↻ Set C-Ch Only →

This setting determines the frequencies you need to enter for Motorola systems. Select your setting, then press .

on — You only need to enter control channel frequencies.

off — You must enter all voice and control channel frequencies.

Note: The scanner defaults to **on**.

Setting Site Location Information

MESL

- [MENU] → Program System →
- ↻ Select a trunked system →
- ↻ Edit Site (current) →
- ↻ Select a site →
- ↻ Set LocationInfo →

This setting control whether the system is automatically enabled and disabled when you connect a GPS to the scanner.

Set Latitude — Enter the system's latitude using the format you selected in the system settings.





Set Longitude — Enter the system's longitude using the format you selected in the system settings.

Set Range — Set the system's range using the units you selected in the system settings.

Set GPS Enable — Depending on the data received from the GPS, the L/O status of the site is automatically controlled.

Deleting Sites

ME

[MENU] → Program System → 
 ↻ Select a trunked system → 
 ↻ Edit Site → 
 ↻ Select a site → 
 ↻ Delete Site → 
 Confirm Delete?
 Yes="E" / No= ". "





Important: Deleted sites cannot be restored. You must re-enter them.

Programming Channel Groups

MECL

Setting Up a Channel Group





MECL

[MENU] → Program System → 
 ↻ Select a system → 
 ↻ Edit Group → 
 ↻ New Group → 

The scanner creates a group with a default name of **Group n**. **n** increments by one for each new group you create within a system.

Editing a Channel Group Name

MECL

[MENU] → Program System → 
 ↻ Select a system → 
 ↻ Edit Group → 
 ↻ Select a New Group → 
 ↻ Edit Name → 

Follow these steps to enter/edit the group name.

1. The current name displays with the first character of the name highlighted.
2. Rotate the **Scroll Control** to select a new first letter. Press **[6]** to move one character to the right. Repeat the **Scroll Control** action to change the character. To move one character to the left, press **[4]**.
3. Repeat Step 2 until you have entered the system name. Then press  to accept the setting.

Notes:

- Each group name can be up to 16 characters. Abbreviate as necessary to fit.

- The group and system (for conventional, SCAT, and LTR systems) or site (for Motorola and EDACS systems) name alternate in the top line of the display when the scanner stops on a channel.
- Press **[.No]** twice to delete the current character.
- Press **[.No]** three times to clear the entire alpha tag.

Setting the Group Quick Key

To assign a Quick Key to a Group, follow these steps.

- [MENU]** → **Program System** →
- ↻ **Select a system** →
- ↻ **Edit Group** →
- ↻ **Select the Group** →
- ↻ **Set Quick Key** →

Select a desired quick key for this Group.

Editing Channels

MECL

Once you create a channel group, store channels in that group. See “Programming Channels” on Page 79 for specific channel options.

Locking Out Channel Groups

MECL

- [MENU]** → **Program System** →
- ↻ **Select an existing system** →
- ↻ **Edit Group** →
- ↻ **Select an existing group** →
- ↻ **Set Lockout** →

This setting determines whether the scanner will scan this group of channels. Select your setting, then press .

Lockout — the group is not scanned.

Temporary L/O — the group is not scanned for this session. The L/O is cancelled when you cycle power.

Unlocked — the group is scanned. The default setting is **Unlocked**.

Deleting Channel Groups

MECL

[MENU] → Program System →
 ↻ Select a system →
 ↻ Edit Group →
 ↻ Select a channel group →
 ↻ Delete Group →
 Confirm Delete?
 Yes="E" / No= ". "

Important: Deleted channel groups cannot be restored. You must re-enter them.

Programming Channels

MECL

Creating a Channel

MECL

[MENU] → Program System →
 ↻ Select a system →
 ↻ Edit Group →
 ↻ Select a channel group →
 ↻ Edit Channel →

Select an existing channel to edit or "New Channel" to create a new channel. When you create a new channel you are prompted to enter the frequency (for conventional systems) or Talk Group ID (for Trunked systems). Enter the information for the channel, then press to proceed to setting additional channel options.

Editing the Channel Name (Alpha Tag)

MECL

[MENU] → Program System →
 ↻ Select a system →
 ↻ Edit Group →
 ↻ Select the channel group →
 ↻ Edit Channel →
 ↻ Select the channel →
 ↻ Edit Name →

Follow these steps to enter/edit the channel name.

1. The current name displays with the first character of the name highlighted.
2. Rotate the **Scroll Control** to select a new first letter.
3. Press **[6]** to move one character to the right.

4. Repeat the **Scroll Control** action to change the character. To move one character to the left, press **[4]**. Press **[.No]** twice to delete the current character. Press **[.No]** three times to clear the entire alpha tag.
5. Repeat Step 2 until you have entered the desired name. Then press **[OK]** to accept the setting.

Notes:

- Each channel name can be up to 16 characters. Abbreviate as necessary to fit.
- The channel name appears on the second line of the display when the radio scans or stops on a channel.
- If you do not enter a channel name, the scanner displays the frequency (for conventional systems) or the talk group ID (for trunked systems) when it stops on a channel.

Editing Frequencies

C

- [MENU]** → **Program System** → **[OK]**
- ↻ **Select a conventional system** → **[OK]**
- ↻ **Edit Group** → **[OK]**
- ↻ **Select a channel group** → **[OK]**
- ↻ **Edit Channel** → **[OK]**
- ↻ **Select the channel** → **[OK]**
- Edit Frequency** → **[OK]**

Use the **[0]** to **[9]** and **[.No]** keys to enter or modify a frequency. When you press the first place key, the cursor automatically moves one character to the right. You can also ↻, clockwise or counter-clockwise to highlight any digit.

Editing the Talk Group ID

MEL

- [MENU]** → **Program System** → **[OK]**
- ↻ **Select a trunked system** → **[OK]**
- ↻ **Edit Group** → **[OK]**
- ↻ **Select a channel group** → **[OK]**
- ↻ **Edit Channel** → **[OK]**
- ↻ **Select the channel** → **[OK]**
- ↻ **Edit TGID** → **[OK]**

To edit the Talk Group ID, enter the Talk Group ID you want using the number keys. Then press **[OK]**.

Selecting CTCSS/DCS Tones

C

To program a channel with a CTCSS or DCS setting, your conventional system audio must be set to Analog Only first.

- [MENU] → Program System →
- ↻ Select the system →
- ↻ Edit Group →
- ↻ Select the channel group →
- ↻ Edit Channel →
- ↻ Select the channel →
- ↻ set CTCSS/DCS →

At this point you can scroll to CTCSS or DCS and select the subaudible frequency in the CTCSS range or the DCS code.

- ↻ CTCSS or DCS →

This setting controls how a sub audible CTCSS or DCS is used for the channel. Select your setting, then press .

off — any signal opens squelch. The default setting is **off**.

Search — the scanner searches for and displays any CTCSS or DCS tone that accompanies the transmission.

CTCSS — the scanner only opens squelch if the CTCSS tone you select is also present with the signal. The scanner then prompts you to enter or scroll to the desired tone.

DCS — the scanner only opens squelch if the DCS tone you select is also present with the signal. The scanner then prompts you to enter or scroll to the desired tone.

Set Lockout — the scanner does not stop on the channel if the tone you select is present. The scanner prompts you to select a CTCSS or DCS tone.

Quick CTCSS/DCS Save

If you set a channel to CTCSS/DCS Search and the scanner detects a tone, when you press [EYES], the first option is **Save found CTCSS/DCS?**

Setting Channel Modulation Method

C

- [MENU] → Program System →
- ↻ Select the conventional system →
- ↻ Edit Group →
- ↻ Select a channel group →
- ↻ Edit Channel →
- ↻ Select the Channel →
- ↻ Set Modulation →

Auto — the scanner uses the default modulation for the channel. The default setting is **Auto**.

AM — the scanner uses AM (amplitude modulation) for the channel.

NFM — the scanner uses narrowband FM for the channel.

FM — the scanner uses FM (frequency modulation) for the channel.

WFM — the scanner uses wideband FM for the channel.

WFM (Broadcast) — the scanner uses FM Broadcast for the channel.

This setting controls the modulation method used for the channel. In most cases, if you leave this set to **Auto**, the scanner automatically selects the correct modulation type for the channel you are programming.

Setting Channel Attenuation

C

- [MENU] → Program System →
- ↻ Select a conventional system →
- ↻ Edit Group (existing site) →
- ↻ Select a channel group →
- ↻ Edit Channel →
- ↻ Select a channel →
- ↻ Set Attenuator →

This setting controls whether the scanner attenuates signals on this channel. Select your setting, then press .

on — the channel is attenuated by about 20 dB.

off — the channel is not attenuated. The default setting is **off**.

You can also toggle this setting by holding on the channel and pressing then **[7]** within 2 seconds.

Setting Channel Priority

- [MENU] → Program System →
- ↻ Select a conventional system →
- ↻ Edit Group →
- ↻ Select a channel group →
- ↻ Edit Channel →
- ↻ Select the channel →
- ↻ Set Priority →

This setting controls whether the scanner treats the channel as a priority channel while scanning. Select **on** or **off**, then press .

on — when you turn on the Priority feature, the channel will be scanned every 2 seconds.

off — the channel will not be treated with priority. The default setting is **off**.

Setting Channel Alert

MECL

- [MENU] → Program System →
- ↻ Select a system →
- ↻ Edit Group →
- ↻ Select a channel group →
- ↻ Edit Channel →
- ↻ Select the channel →
- ↻ Set Alert →

off — the scanner does not alert you when the channel becomes active.

Alert 1 - 9 — the scanner sounds an alert beep to notify you that the channel has become active. You can choose any of 9 different beep types. Once you choose an alert tone, then:

- ↻ → Set Level →

Auto — the scanner automatically sets the channel alert beep to match the master volume level.

Level 1 - 15 — the scanner adjusts the volume of the beep to the level you select.

Setting Channel Record

MECL

- [MENU] → Program System →
- ↻ Select a system →
- ↻ Edit Group →
- ↻ Select a channel group →
- ↻ Edit Channel →
- ↻ Select a channel →
- ↻ Set Record →

on — the scanner outputs the signal.

off — the scanner does not output any audio.

Note: In order for the function to work, you must set the channel to record. You must also set the system's record option to either **All Channel** (which will record all channels regardless of the channel's record setting) or **Marked Channel** (which only records the channels you've set to record).

Setting Lockout

MECL

- [MENU] → Program System →
- ↻ Select a system →
- ↻ Edit Group →
- ↻ Select a channel group →
- ↻ Edit Channel →
- ↻ Select a channel →
- ↻ Set Lockout →

Unlocked — the channel is scanned when its quick key is enabled.

Temporary L/O — the channel is locked for this session.

Lockout — the channel is not scanned.

Copying a Channel

MECL

- [MENU] → Program System →
- ↻ Select a system →
- ↻ Edit Group →
- ↻ Select a channel group →
- ↻ Edit Channel →

- ↻ Select a channel →
- ↻ Copy Channel →

You see **Copy Channel Copied to Buffer.**

Press **[MENU]** to return to one level before You see **Paste Channel** as the last list item. At this point you can paste that channel information to another group or compatible system.

Deleting a Channel

MECL

- [MENU]** → Program System →
- ↻ Select a system →
- ↻ Edit Group →
- ↻ Select a channel group →
- ↻ Edit Channel →
- ↻ Select a channel →
- ↻ Delete Channel →

You see **Confirm Delete? Yes= "E" / No= "."**

Select one to delete the channel or to cancel.

Searching and Storing

Service Search

Service Search lets you select and search the scanner's preprogrammed search ranges. During service search, the scanner searches starting with the lowest frequency in the search range you select to the highest frequency in the range. There are three ways to do this.

[SRVC]

↻ → Select the service search range → 

or

[MENU] → ↻ Search for ... → 

↻ Service Search → 

↻ Select the service search range → 

The other approach is:

 + [SCAN/SEARCH] →

Quick Search? Yes="E" / No="."

Press [No] then to select **Service Search** → 

The following search ranges appear as you scroll ↻

Air
 Marine
 CB AM Radio
 CB FM Radio
 PMR
 LPD

The scanner searches the service you selected, stopping on any transmission it finds and displaying the frequency. Turn the Scroll Control to change the search direction. An arrow appears, showing the current search direction.

To pause searching, press [HOLD/RESUME]. To resume searching, press  + [SCAN/SEARCH]. Or, press [HOLD/RESUME].

To lock out a frequency found while searching, press [L/O] one time to temporarily lock it out (**Temporary L/O** appears) or twice to permanently lock it out (**Locked Out** appears).

See the Appendix pages for all Service Search Frequencies.

Notes:

- If all frequencies in the search range you selected are locked out, **All Locked!** appears and the scanner does not search the range.
- If the service range you select uses channels (such as CB Radio or Marine), the scanner displays the service channel number.

Quick Search

Quick Search lets you search from the currently-tuned frequency if you are scanning a conventional system or sets the system to ID search if you are scanning a trunked system.

If you are on a conventional system or channel, press **[M] + [SCAN/SEARCH]** to start quick search. **Quick Search? Yes = "Y" / No = "."** appears. Press **[HOLD/RESUME]** to go to quick search hold.

Press **[EYES]** to start quick search or **[.No]** to go to the search menu.

Custom Search

Custom Search lets you program and search 10 custom search ranges. You can search any of these ranges simultaneously and select each custom search range you set. During custom search, the scanner searches starting with the lowest frequency in the search range you select to the highest frequency in the range. There are two methods to begin a custom search.

Default Search Range

- Custom 1 : 25.0000 - 87.2875 MHz (Plan 1)
: 25.0000 - 87.2950 MHz (Plan 2)
: 25.0000 - 87.2937 MHz (Plan 3)
- Custom 2 : 87.3000 - 107.9500 MHz
- Custom 3 : 108.0000 - 136.9875 MHz
- Custom 4 : 137.0000 - 173.9900 MHz (Plan 1,2)
: 137.0000 - 173.9937 MHz (Plan3)
- Custom 5 : 174.0000 - 215.9500 MHz
- Custom 6 : 216.0000 - 224.9950 MHz
- Custom 7 : 225.000 - 399.9750 MHz
- Custom 8 : 400.0000 - 512.0000 MHz
- Custom 9 : 806.0000 - 960.0000 MHz
- Custom 10 : 1240.0000 - 1300.0000 MHz

Searching and Storing

Notes:

- Search ranges are preset. These ranges can be edited. See “Editing a Custom Search Range” on Page 88 to change the range.
- You cannot turn off all custom search ranges.

[MENU] → ⤴ Search for ... → ⏻
 ⤴ Custom Search ... → ⏻

The other approach is:

⏻ + [SCAN/SEARCH] →

Quick Search? Yes="E" / No="."

Press [.No] then ⤴ to Custom Search → ⏻

The scanner starts custom search of the custom search range you selected, stopping on any transmission it finds and displaying the frequency. Turn the Scroll Control to change the search direction. An arrow appears, showing the current search direction.

To turn search ranges on or off, press [0] and [1] - [9]. To hold searching, press [HOLD/RESUME]. To resume searching, press [HOLD/RESUME].

To lock out a frequency found while searching, press [L/O]. There are two different results based on the number of times you press [L/O].

Press [L/O] 1 time: **Temporary L/O** appears

Press [L/O] 2 times: **Locked Out** appears and the scanner resumes custom search.

If you turn off the active custom search range, the scanner skips to the next custom search range and continues searching.

Note: If all frequencies in all active custom search ranges are locked out, **All Locked!** appears and the scanner does not stop.

Editing a Custom Search Range

You can edit up to 10 custom search ranges. The names of the custom search ranges appear on the display. The default custom search range names appear as **Custom 1**, **Custom 2**, and so on.

[MENU] → ⤴ Search for ... → ⏻
 ⤴ Edit Custom → ⏻
 ⤴ Custom 1, Custom 2 to Custom 10. → ⏻

Another approach is

☐ + **[SCAN/SEARCH]** →

Quick Search? Yes="E" / No="."

Press **[.No]** then **↶** to **Edit Custom** → **☐**

At this point you can edit each of the settings that comprise a custom search.

Edit Name — lets you edit the custom search range's name.

Edit Srch Limit — lets you view and select the frequency ranges to search. The scanner prompts you to enter the upper and lower search limits.

Set Delay Time — lets you set the amount of time the scanner will delay before continuing to search after a transmission ends.

Set Modulation — lets you set the custom search range's modulation type.

Set Attenuator — lets you set whether the scanner will attenuate reception by 20 dB during search.

Set Data Skip — lets you set whether the scanner will skip data transmissions during search.

Set Step — lets you set the custom search range's step (the gap between frequencies).

Set C-Ch Only — lets you search for a Motorola control channel. If it finds one, the scanner scans the system.

Set Record — if during your listening to the selected service, if a transmission is received, choosing **on** will send an audio signal to the connected audio recording device.

Search with Scan — sets whether the scanner includes the custom search during scanning. If unlocked, the scanner first scans all selected systems, then searches the selected service searches for the selected hold time (0-255 seconds).

Within this menu item are the following settable options

Set Quick Key — lets you assign a Quick Key for the custom search range.

Set Startup Key — lets you decide which custom search range should be unlocked and scanned at power up

Searching and Storing



Set Lockout — lets you lock the custom search range for this session or permanently as with any other L/O action.

Set Hold Time — sets how long (seconds) the custom search range is checked before the scanner moves to the next programmed entry.

Search With Scan

When you press **[SCAN/SEARCH]** the UBC800XLT starts a scan of those sites, channels, etc you have manually programmed or the Uniden preprogrammed data for your metropolitan area that are unlocked and have their System Quick key enabled.

In addition to this scan you can search any of the preprogrammed service or custom search ranges.



While scanning, press . Rotate the **Scroll Control** until you reach the desired service or custom search range. Press **[L/O]** to unlock it. You can also assign a System Quick Key to the search to make it easy to quickly enable/disable the search range for search and scan. The Search with Scan Hold time determines how long the scanner stays on a search before moving on. The default is 2 seconds.  to set the Search with Scan settings.

Editing a Service Search

You can change the way service search works for each service. There are also two methods to reach the point of editing.

Method One

[MENU] →  **Search for ...** → 

 **Edit Service** → 



 Select a service range:

Air, Marine, CB AM Radio, CB FM Radio, PMR, LPD → 

Method Two

 + **[SCAN/SEARCH]** →

Quick Search? Yes="E" / No="."

Press **[.No]** then  to **Edit Service** → 

At this point you can edit each of the settings that comprise each custom search range.

The following show you how to set the various option settings associated with a Service. For each, your starting operation is

[MENU] → ↻ Search for ... → ●
 ↻ Edit Service → ●
 ↻ Select a service range:

Set Delay Time

Choose a delay time to set how long the scanner stays on a transmission after it ends.

↻ to select a value from **1 sec**, **2 sec**, **3 sec**, **4 sec**, **5 sec**, and **Off**. → ●

Set Attenuator

Choose to attenuate all frequencies by about 20 dB.

↻ to select to choose an attenuation for all frequencies in the range. → ●

on — the frequencies are attenuated.

off — the frequencies are not attenuated.

Set Record

↻ to enable real time audio output from **REC** to an audio recording device.

on — the scanner outputs the signal. Then press ● to select.

off — the scanner does not output any audio. Then press ● to select.

Assigning a Search Range to a Search Key

You can assign any of the Service or Custom Searches to the six Search keys for quick access to your favorite searches.

[MENU] → ↻ Search for ... → ●
 ↻ Set Search Key → ●
 ↻ Select the key to assign → ●
 ↻ Select a search range → ●

Now, to access that search, hold on any channel, then press ● and the number key **[1]** to **[6]** corresponding to the search range.

The default settings are:

- SRCH 1: 25.000~87.2875MHz (Plan1)
25.000~87.2950MHz (Plan2)
25.000~87.2937MHz (Plan3)
- SRCH 2: 87.3000~107.950MHz
- SRCH 3: 108.000~136.9875MHz
- SRCH 4: 137.000~173.9900MHz (Plan1,2)
137.000~173.9937MHz (Plan3)
- SRCH 5: 174.000~215.9500MHz
- SRCH 6: 216.000~224.995MHz

Saving a Found Channel (Quick Save)

If you hold on a channel or receive a desired channel, you can save it by pressing **[EYES]** instead of using Direct Entry. The alpha data is also stored.

If a GPS unit is attached, the longitude and latitude data is saved and becomes the name of that channel. For example, if the position is **32°57'33.60 N** latitude and **97°05'34.18 W** longitude, the name saved is **3257.33-09705.34**.

Auto Search and Store

Your scanner's Auto Store feature lets you search for new frequencies in custom search ranges or within a service search range on a conventional system, or new talk group ID's on a trunked system.

Selecting a System to use for Storing

To store frequencies or talk group ID's you find during Auto Store, you must first select a system where the frequencies or talk group ID's will be stored.

- [MENU]** → **↻ Search for ...** → **Ⓚ**
- ↻ Search and Store** → **Ⓚ**
- ↻ Select the system for storing the frequencies or talk group IDs** → **Ⓚ**

If no system is selected, **No System Stored** appears. If you have already stored too many channels or channel groups, **Over Limit** appears.

Conventional Search and Store

You can store frequencies into the system you selected in "Selecting a System" above. Otherwise, the scanner stores frequencies in a new group it creates.

Follow the steps in the preceding section but be sure to select a Conventional System. A search option appears that lets you choose from a **Custom Search** to the other service search ranges previously mentioned (Air, Marine...etc).

Turn the **Scroll Control** until the search range you want appears, then press  to select it. One of the search ranges appears.

If frequencies in your selected search range are all locked out, **All Locked!** appears and the scanner does not store any frequencies.

When you select a search range, the scanner looks for active frequencies within that range. The top line of the display alternates between the system name and the search range name while **SEARCH AND STORE** appears beneath it. The second line changes to **Memory Check** when the scanner detects a transmission while it is checking to see if the frequency has already been stored.

When the scanner finds an active transmission, it checks to see if the frequency has already been stored in the system. If it has already been stored, the scanner continues to search. If the frequency has not been stored, it stores the frequency into a group named **Found Channels**, then resumes searching. The scanner creates this group if it doesn't already exist.

Trunked Search and Store

You can store talk group ID's into the system you selected in "Selecting a System". Otherwise, the scanner stores talk group ID's in a new group it creates.

Note: Trunked system search and store does not work if an EDACS SCAT system is selected, a system with no frequency is selected, the quick key to which the system belongs is turned off, and the group you selected to store found talk group ID's contains more talk group ID's than the maximum set in Max Auto Store.

To store a trunked system, follow the beginning steps in Selecting A System above. When you select a Trunked System and press  the scanner enters TGID Search and Store mode.

When you select a trunked system, the scanner looks for active talk group ID's within that range and **ID SEARCH AND STORE** appears and scrolls across the display's lower line while the system/site name appears on the display's upper line. When the scanner finds an active talk group ID, it checks if the talk group ID has already been stored in the site. If it has, the scanner continues to search. If the talk group ID has not been stored, it stores the talk group ID into a group named **Found Channels**, then resumes searching. The scanner creates this group if it does not already exist.

Searching and Storing

Using the Close Call Feature

Your scanner's Close Call™ feature lets you set the scanner so it detects, displays the frequency and lets you hear a nearby strong radio transmission. You can set the scanner so the Close Call feature works “in the background” while you are scanning other frequencies, turn off normal scanning while the Close Call feature is working, or turn off the Close Call feature and use the scanner normally. You can set the scanner so it alerts you when the Close Call feature finds a frequency. You can also set the frequency band where you want the scanner to look for transmissions.

To toggle Close Call mode, press **[SQ/☉]**. When the feature is on, **CC DND(☉)** or **CC Pri(☉)** and their indicating icons appear on the display. Using CC Priority, normal operation is briefly interrupted about every 2 seconds.

Notes:

- The Close Call feature works well for locating the source of strong local transmissions such as mobile and handheld two-way radios in areas with no other strong transmission sources. Several factors affect Close Call performance, however. Performance is increased with higher transmit power, receive antenna tuned to the target band, and a low background RF level. Other than the antenna, you have no control over these factors, but they explain why performance might vary by both location and time.
- The Close Call feature cannot detect satellite dishes or any transmitter with a frequency above or below the frequency ranges listed under the Set CC Bands: option on Page 96.
- The Close Call feature works better with some types of transmissions than others. It might not correctly display frequency information for transmitters using a highly directional antenna (such as an amateur radio beam antenna) or if there are many transmitters operating at the same time in the same area.
- The “Close Call” mode can detect frequencies on the default band step only.



Setting Close Call Options

[MENU] → **☰** **Close Call** → **☑**

Next, turn the Scroll Control **☰** to select an option.

Close Call Only — Lets you set the scanner only for Close Call searching. The scanner does not scan frequencies or channels when this option is turned on. To select this option, press **☑**.

CC Auto Store — Lets you select whether the scanner automatically stores Close Call hits into channels. If you turn this option on, the scanner starts Close Call mode and stores any Close Call hits, up to the maximum you specified in the **Max Auto Store** setting. If the scanner stores more hits than this setting, it stops auto store operation.

Turn the Scroll Control  to display an option, then press .

Set CC Mode — Lets you select the Close Call mode. If you set **CC Pri**, then every 2 seconds the scanner switches the filter settings to the ones set by the **CC Bands** option. This does not occur with **CC DND**.

off — Close Call is turned off for all modes.

CC DND (Do Not Disturb) — The scanner checks for a Close Call hit every 2 seconds only if the scanner is not currently stopped on a transmission. If the scanner is on a transmission the scanner waits until the signal ends to perform a Close Call check. This prevents breaks in audio during Close Call checks.

CC Pri (Priority) — Checks for a Close Call hit every 2 seconds.

Set CC Override — Lets you select how the Close Call feature works with other scanning activities. If you turn this option off, when the scanner detects a Close Call signal, **CC Found! Press Func Key** appear for the time you set in **Set CC Pause**. Press  when this appears to jump to and hold on the frequency.

If this option is turned on, the scanner overrides the current channel and goes to the Close Call hit. The scanner displays **CC Found! Press Any Key**. When you press a key, the frequency appears.

Set CC Alert — Lets you select how the scanner alerts you when it receives a Close Call signal. You can select from these options.

Select Beep — The scanner beeps when it receives a Close Call signal. You can set the beep alert in the following manner.

off — the scanner does not beep

Alert 1-9 — The scanner sounds a specialized beep to notify you of a Close Call hit. When you select an alert type, the scanner automatically enters the setting of the Alert volume level. Each alert has a unique one or sound pattern.

Set CC Pause — Lets you select how long the scanner waits after a hit before it returns to the previous operation. Your options are:

3/5/10/15/30/45/60 sec.

Using the Close Call Feature

Infinite — The scanner stops and requires you to manually select another operation to enable its return.

Set CC Bands — Lets you select the Close Call band settings. You can turn the following bands on or off.

VHF Low 1 : On/Off: 25.0000 - 53.9875 MHz Plan1
 : 25.0000 - 53.9950 MHz Plan2
 : 25.0000 - 53.9937 MHz Plan3

VHF Low 2 : On/Off: 54.0000 - 107.9500 MHz



Air Band : On/Off : 108.0000 - 136.9875 MHz Air 12.5k
 : 108.0000 - 136.9916 MHz Air 8.33k

VHF High 1 : On/Off : 137.0000 - 224.9950 MHz

VHF High 2 : On/Off : 225.0000 - 319.9750 MHz

UHF : On/Off : 320.0000 - 512.0000 MHz

800MHz+ : On/Off : 806.0000 - 1300.0000 MHz

Use the **Scroll Control**  to select a band, press , then use the **Scroll Control** to select **on** or **off** and press . Turning off undesired bands speeds up Close Call operation (works for all frequencies listed above).

Close Call Hits

When the scanner detects a Close Call hit, it alerts you according to the Override and Alert settings in the previous section.



While listening to a Close Call hit, you can press **[HOLD/RESUME]** to hold on the hit frequency, press **[EYES]** to quickly save the frequency into memory, press **[L/O]** to lock out the frequency from Close Call and Search operation, or wait for the transmission to end. If you are in Close Call Only or Close Call Override mode, and you do not press any key, the scanner returns to its previous operation after the transmission ends and the set delay time expires.



If you are holding on the frequency, press **[HOLD/RESUME]** again to resume the previous operation.

Close Call Hits are just the last 10 hits received in Close Call mode. The hits go away when you cycle power (if you want to store it “permanently” press **[EYES]** when the scanner is on the frequency; the scanner then stores the frequency into the “Close Call” system which does show up in the systems list).

Close Call Hits with Scan

The scanner automatically stores and scans the last 10 Close Call hits received. You can assign a Quick Key to this special scan. This lets you continue to hear transmissions detected with the Close Call feature, even after you are no longer close enough to receive it as a Close Call hit. Follow these steps to set up the option.

[MENU] →  Close Call → 

 Hits with Scan → 

 Set Quick Key or Set Lockout or Set Hold Time → 

Set the available option as you would for other menu items.

This special channel group is automatically cleared whenever you cycle the scanner's power. To permanently save one of the channels, press [EYES] when the scanner is stopped on one of the frequencies. To keep the scanner from repeatedly stopping on an annoyance hit, press [L/O] when the scanner stops on the frequency.

Using the Close Call Feature

Search and Close Call Options

The settings in this section affect custom searches, service searches, and Close Call operation. The following table shows what options are available for various search modes.

| Setting | Service Search ¹ | Custom Search ¹ | Quick Search | Search and Store | Close Call | CC Auto Store | CC Hits System |
|------------------|-----------------------------|----------------------------|--------------|------------------|------------|---------------|----------------|
| Freq. Lockouts | • | • | • | • | • | • | |
| Broadcast Screen | | • | • | • ² | • | • | |
| CTCSS/DCS Search | • | • | • | • | • | • | |
| Max Auto Store | | | | • | | • | |
| Set Delay Time | | | • | | • | | • |
| Set Modulation | | | • | | • | • | |
| Set Attenuator | | | • | | • | • | |
| Set Data Skip | • | | • | • ³ | • | • | • |
| Set Step | | | • | | | | |
| Air Band Step | • | • | • | • | • | • | |
| Set Record | | | • | | • | | • |

1 — Valid only for searching a range using Search with Scan.



2 — Valid only for storing a frequency from Search and Store.

3 — Valid only for storing a frequency from Service Search.

Managing Locked-Out Frequencies



While searching or during Close Call operation, if you press **[L/O]** while the scanner is stopped on a frequency, that frequency is locked out of these modes. The temporary L/O frequency limit is 250. The permanent L/O frequency number limit is up to 250.

Unlocking All Frequencies

[MENU] → ⤴ Srch/CloCall Opt → 
 ⤴ Freq Lockouts → 
 ⤴ Unlock All → 

The scanner prompts you to confirm the change in lockout status. To confirm the change of all locked-out frequencies, press . If no frequencies are locked, you see **Nothing Locked Press Any Key**. Otherwise, to cancel, press [MENU].

Reviewing Locked-Out Frequencies

[MENU] → ⤴ Srch/CloCall Opt → 
 ⤴ Freq Lockouts → 
 ⤴ Rvw Search L/O → 

The scanner displays the first locked-out frequency and prompts you to unlock the frequency. Press  to unlock the frequency. Or, rotate the Scroll Control or press to select a different frequency. If there are no frequencies to review, you see **Nothing Locked Press Any Key**. Otherwise, to cancel, press [MENU] to backstep.

Searching for Subaudible Tones

[MENU] → ⤴ Srch/CloCall Opt → 
 ⤴ CTCSS/DCS Search → 
 ⤴ On or Off → 



This setting controls whether the scanner will search for a subaudible tone when it stops on a transmission during search or Close Call operation.

on — The scanner searches for and displays any subaudible tone found.

off — The scanner does not search for subaudible tones.

Note: This feature does not operate when the scanner is in AM/WFM/FMB modulation mode.

Screening Out Broadcast Sources

[MENU] → ⤴ Srch/CloCall Opt → 
 ⤴ Broadcast Screen → 

Search and Close Call Options

This setting determines whether the scanner automatically ignores transmissions found during Custom Search, Quick Search, or Close Call operation that are on common broadcasts, paging systems, and other annoyance radio sources.

Note: Broadcast screening does not work in All service search ranges.

Set All Band On — turns on broadcast screen on each band.

Set All Band Off — turns off broadcast screen on each band.

Set Each Band — lets you set broadcast screen only on **specific** bands you select. **On** or **Off** appears next to each option. Turn the **Scroll Control** to select an option then press  to change the setting.

Band 1-10 — select the custom band where you want to screen out broadcast sources.

Program Band — brings you to a menu setting to let you program a custom frequency range for broadcast screen. Turn the **Scroll Control** to select an option then press  to change the following setting.

To set the custom range of a band, select one and press  to set the limit.



Band 1-10 — select the group where you want to screen out broadcast sources.

Set Lower Limit— enter the lower limit of the frequency range, then press  to set it.

Set Upper Limit — enter the upper limit of the frequency range, then press  to set it.

To set the custom range of a band, select one and press  to set the limit.

Setting the Maximum Auto Store Value

[MENU] →  Srch/CloCall Opt → 

 Max Auto Store → 

This value sets how many hits the scanner will automatically store when it is in either Search and Store or Close Call Auto Store mode. Use the number keys to enter a value from 1 - 256, then press . The default value is 100.

When the scanner exceeds the maximum number of hits you set, it stops the auto-store operation.

Setting the Modulation Type

This setting controls the modulation method used to receive frequencies during Quick Search and Close Call operations. In most cases, if you leave this set to **Auto**, the scanner automatically selects the correct modulation type for the system you are programming.

[MENU] → ⤴ Srch/CloCall Opt →

⤴ Set Modulation →

Auto — the scanner uses the default modulation for the frequency band. The default setting is **Auto**.

AM — the scanner uses AM (amplitude modulation) for the frequency band.

NFM — the scanner uses narrowband FM for the frequency band.

FM — the scanner uses FM (frequency modulation) for the frequency band.

WFM — the scanner uses wideband FM for the frequency band.

WFM (Broadcast) — the scanner uses FM Broadcast for the frequency band.

Setting Attenuation

Turn on this setting if you are near other strong signal sources. Attenuation sometimes helps to reduce interference and desensitization that strong signals create.

[MENU] → ⤴ Srch/CloCall Opt →

⤴ Set Attenuator →

This setting controls the attenuator for Quick Search and Close Call operation. Select your setting, then press .

on — Reception is attenuated by about 20 dB.

off — Attenuation is off.

Setting Data Skip

[MENU] → ⤴ Srch/CloCall Opt →

⤴ Set Data Skip →

This setting controls how the scanner behaves when it stops on a channel that has a data signal.

Search and Close Call Options





On — the scanner stops briefly on the channel, but then immediately resumes scanning automatically.

off — the scanner remains on the channel until the transmission stops. The default setting is **off**.

Note: If you are trying to test the Close Call feature with a nearby transmitter (such as a CB) and you do not talk into the transmitter, the scanner detects this unmodulated carrier as data and skips the frequency when Data Skip is on. Turn the feature off or talk into the transmitter to modulate the carrier.

This setting is ignored for AM/WFM/FMB channels.

Setting the Delay Time

[MENU] →  Srch/CloCall Opt → 
 Set Delay Time → 

This setting determines how long the scanner waits after a transmission ends before resuming Quick Search or Close Call operation.

1-5 sec — The scanner waits the set amount of time after the transmission ends before resuming. The default setting is 2 sec.

off — The scanner resumes immediately when the transmission ends.

Setting the Search Frequency Step

[MENU] →  Srch/CloCall Opt → 
 Set Step → 





This setting lets you select the frequency step used during Quick Search.

Auto — The step is based on the band (see the table at the front of the manual). This is also the default setting.

5.0 kHz, 6.25kHz,
8.33kHz, 10.0 kHz,
12.5 kHz, 15.0 kHz,
20.0 kHz, 25.0 kHz,
50.0 kHz, 100.0 kHz

The scanner uses the selected step.

Setting Air Band Step





[MENU] →  Srch/CloCall Opt → 
 Air Band Step → 

Select Air Band Step

8.33kHz
 12.5kHz

Setting Record

You can set the **REC** jack to provide an audio signal to a sound recording device (tape, PC, flash memory) for live recording of transmissions. This also lets you record Quick Search and Close Call transmissions.

[MENU] →  Srch/CloCall Opt → 
 Set Record → 

on — enables an output to an audio recorder at the **REC** (record output) jack.

off — disables an audio signal at the output jack.

Priority Scan

If you activate a Priority Scan while scanning, the radio interrupts its scan every two seconds to check the priority channel (P-Ch). **PRI** appears on the screen.

There are two ways to set Priority Scan.

1. Press [**PRI**] to set one of the following Priority Scan levels in Scan / Scan Hold mode.

off — Normal scanning. The scanner provides no special treatment for Priority Channels.

on — The scanner scans all unlocked channels and also checks those designated as Priority. While scanning the scanner interrupts every 2 seconds and checks the priority channels in each unlocked conventional system. Priority channels in lower priority key numbered systems (starting from 1) have highest priority. **PRI** appears when you select this mode.

Search and Close Call Options

Plus On — The scanner only scans priority channels in unlocked conventional systems. **PRI** flashes when you select this mode.

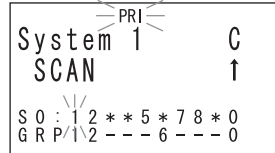

2. You can choose how the scanner treats Priority Channels using the Menu options.





[MENU] → **U** set Priority → **Q**
U Choose Off, On, or Plus On → **Q**



Fire Tone-Out

Your scanner can be set to respond to fire tone-outs, a system comprised of standardized two-tone sequential paging, short one-tone paging, and long group tone paging. You can save up to 10 settings. When you select a setting in standby mode, the scanner also monitors for any other setting that uses the same transmit frequency, modulation, and attenuation settings. To quickly switch to Fire Tone-Out mode, press  and then **[SQ]**.

You need tone-out setup information from the agency you wish to monitor. Check with your local agency or on-line resources.

Setting Tone-Out Standby





[MENU] →  **Tone-Out for...** → 
 **Tone-Out Standby** → 



Turn the **Scroll Control**  to select which of the ten tone-outs to monitor. Or, press  then **[SQ]** to quickly switch to Tone-Out Standby, then rotate scroll to select the settings to monitor. All tone-outs that have the same frequency, modulation, and attenuation setting as the one you select, are also monitored.

In standby mode, the display cycles through all monitored tone-out settings. Regardless of the current display, the scanner always alerts on any received tone-out that matches a stored setting.

If you press **[HOLD/RESUME]** while in standby mode, the scanner temporarily exits the mode and you hear all transmissions on that frequency. No alerts sound, even if a tone-out matches one you have stored. Press **[HOLD/RESUME]** again to return to standby mode.

Setting Up Tone-Out

[MENU] →  **Tone-Out for...** → 
 **Tone-Out Setup** → 

Scroll to select the tone-out (1 - 10) you want to program, then press . Then you can scroll to any of the following settings and press  to select and modify the selected settings:

Edit Name — Sets the name for the selected tone-out setting.

Set Frequency — Sets the tone-out's RF frequency parameters. Then select:

Fire Tone-Out

105

- **Edit Frequency** — Enter the desired frequency that the scanner should monitor for the tone-out.
- **Set Modulation** — Set the modulation type for the paging signal. Next choose the modulation setting:
 - **Auto** — The scanner uses the default modulation for the frequency band. If the default modulation is AM, WFM, or FMB, the modulation operates as FM.
 - **NFM** — The scanner uses NFM modulation.
 - **FM** — The scanner uses FM for the frequency band. This is the default setting.
- **Set Attenuator** — Press  then turn the **Scroll Control** to select **On** or **Off**.

Set Tone — Sets the audio tone frequency for the page. Then choose the Tone setting.

- **Edit Tone A** — Set the audio frequency for Tone A
- **Edit Tone B** — Set the audio frequency for Tone B

Notes:

- For two-tone pages, enter a value for A and B.
- For one-tone pages using short tones of less than 3.75 seconds, enter the tone value for A, and 0 (zero) for B.
- For long-tone pages, such as group pages of more than 3.75 seconds, enter 0 (zero) for A and the tone value for B.

Set Delay Time — Sets the time the scanner remains in monitor mode after the scanner receives a page and the carrier drops.

- **1-5 sec** — the scanner resumes standby mode after the carrier drops and the selected time expires.
- **Infinite** — you must press **[HOLD/RESUME]** after a page to resume standby mode.
- **off** — the scanner resumes standby as soon as the carrier drops after a page.

Set Alert — Sets the alert the scanner uses when it receives an alert.

- **Alert 1 - 9** — scroll to select the alert tone pattern, The scanner sounds each alert as you scroll to its numbered value.
- **off** — the scanner does not sound an alert.

After you select an alert pattern, the scanner prompts for the alert level for a received alert. Level options 1 to 15 sets a fixed audio level independent of the main volume setting. **AUTO** uses the main volume setting for the alerts.

Tone-Out Multi-Channel Monitoring

The scanner can check multiple tone combination pages for channels whose settings are the same. To achieve this, set the channel to the same frequency, modulation, and attenuator. For example, the scanner checks tone combinations for channel 1 to channel 4 for the following settings.

| | Frequency (MHz) | Modulation | Attenuator | Tone A (Hz) | Tone B (Hz) |
|------|-----------------|------------|------------|-------------|-------------|
| Ch 1 | 137.0000 | Auto (FM) | Off | 1000.0 | 2000.0 |
| Ch 2 | 137.0000 | Auto (FM) | Off | 2200.0 | 3200.0 |
| Ch 3 | 137.0000 | Auto (FM) | Off | 1500.0 | 2500.0 |
| Ch 4 | 137.0000 | FM | Off | 1800.0 | 2800.0 |
| Ch 5 | 137.0000 | NFM | Off | 2000.0 | 3000.0 |
| Ch 6 | 138.0000 | Auto (FM) | Off | 1000.0 | 2000.0 |

Although set to Auto, if the band default is anything other than FM or NFM, modulation will always be FM.

If you switch to Tone-Out Standby Mode for Multi-Channel Monitoring, the display switches every 2 seconds to show the FM frequency it is checking. However, it is, at the same time, checking all frequencies for Tones. If one is detected, it switches to Tone-Out Hold mode.

Set Record

U to enable real time audio output from **REC** to an audio recording device.

on — the scanner outputs the signal to **REC**. Press **OK** to select.

off — the scanner does not output any audio. Press **OK** to select this option.

Fire Tone-Out

Using the UBC800XLT with a GPS

The scanner lets you connect a compatible GPS device to it to provide two very convenient operation features:

- automatically locks and unlocks systems and sites based on data you input. This fine-tunes the scanning operation and makes it that much enjoyable.
- provides you with valuable displayed information and audio alerts for Points of Interest, Dangerous Roads, and Dangerous Crossings. The GPS works in close coordination with your scanner.

Device Compatibility

The GPS must have serial output, and capable of outputting standard NMEA sentences GGA and RMC. (See "NMEA-0183 ver.3.01" which can be found on the web.)

Connecting Your Scanner to a GPS Device

To use the location-based features of the scanner, you must connect a GPS to the unit. Use the cable provided by the GPS manufacturer. Make sure that their cable terminates in a female, 9-pin serial connector. Insert that plug into the male, 9-pin socket on the back of the scanner labeled **REMOTE/GPS**. Once the GPS is connected, refer to the following sections dealing with inputting selections to enable location based feature operation.

Initial Scanner/GPS Operation

When the scanner first starts receiving a signal from the GPS, it briefly displays **GPS CONNECTED** and silently locks and unlocks all radio system and sites whose quick key is enabled according to your current location. If you have a lot of data programmed, it might take the scanner a couple of minutes to complete the process. Once the scanner completes the initial GPS review, if you move into or out of an area covered by a radio site, the scanner beeps and displays the name of the system and whether it is being locked or unlocked.

Note: The GPS function temporarily locks out sites and systems when you move out of their range. If you cycle power, all systems are unlocked until the scanner reacquires the GPS signal and completes the initial GPS review.

Location-Based (GPS) Scanning

The UBC800XLT can make use of data transmitted from an attached GPS unit that lets the radio automatically enable and disable systems based on the geographic information you provide such as:

Latitude (the center of the range)

Longitude (the center of the range)

Range (the radius of a circle around the latitude and longitude coordinates selected from 0.5, 1.0, 2.0, 3.0, 5.0, 10.0, 20.0, 25.0, 50.0, 75.0 and 100.0 km (0.5, 1.0, 2.0, 3.0, 5.0, 10.0, 20.0, 30.0, 50.0, 75.0 and 100.0 miles)

You set the longitude and latitude to approximate the center of a geographic entity such as your local city and set the range to encircle that center point. By doing so you set aside reception of an adjacent city that otherwise might be undesirably received from one extremity of your city.

In addition, all geopolitical areas are not perfect circles. Therefore you can accommodate these variations by entering multiple sites for the system, even though the system actually has one site, and use different location settings for each of those additional sites.

See the programming section for specific steps required to apply location data to a radio system.

Non-Radio Location Based GPS Features

When connected to a GPS, you can program specific location information which will trigger an alert from the scanner. The following geographically based values are typical of the use you might find valuable while traveling. Use the menu to input the necessary data to enable each.

- **Dangerous Xing** — Stores location, and direction of travel. If you are in range, traveling in a direction that will take you to that Point, the radio sounds an alert at 1.0km, 0.5km and 0.1km or (1.0mile, 0.50mile and 0.10mile) from the point.
- **Dangerous Road** — Stores location, direction of travel, and speed. If you are traveling at a speed greater than that specified and if you are within range of the set location, the scanner sounds an alert at 1.0km, 0.5km, and 0.1km or (1.0mile, 0.50mile and 0.10mile) from the point.
- **Points of Interest (POI)** — Stores location and range. If you approach the set location, the radio sounds an alert.

In general, an alert based on location is comprised of the following data:

- Latitude
- Longitude
- Speed (optional setting)
- Name (optional setting)
- Alert Type and Sound level (optional setting)
- Direction (optional setting)

There are four setting conditions that can be set to result in alerts:

- A speed setting greater than zero with no direction entered. This results in an alert based only on speed in any direction.
- A speed setting greater than zero with a specific direction entered. This triggers an alert when the speed is exceeded but only in the specified direction.
- Speed is equal to zero and a direction is entered along with a location. This setting is used for a dangerous intersection alert.
- Speed is set to zero and no direction is entered but only location. This is a point of interest alert.

By pressing & holding **[GPS]**, you can select a location type and store current location data.

The following table shows the attributes available for each category. Note that some options are different for a specific location type. Refer to the information that follows to set those specific attributes.

| Menu Option | POI | Dangerous Xing | Dangerous Road |
|-------------------|-----|----------------|----------------|
| New Location | • | • | • |
| Edit Name | • | • | • |
| Set Type (edit) | • | • | • |
| Set Alert Beep | • | | |
| Set Alert Volume | | • | • |
| Set Location Info | • | • | • |
| Set Heading | | • | • |

| Menu Option | POI | Dangerous Xing | Dangerous Road |
|-----------------|-----|----------------|----------------|
| Set Range | • | | |
| Set Speed Limit | | • | • |
| Set Lockout | • | • | • |
| Delete Location | • | • | • |

Setting the Options

[MENU] → ⤷ Program Location → ●
 ⤷ Select a location type (POI, Dangerous Xing, or Dangerous Road). → ●
 ⤷ New Location → ●

The scanner assigns a sequentially created number to the location.

⤷ Edit Name → ●

Use the Scroll Control and ● to give the New Location a name. You could, for example, enter the name of the place or the Route Number.

⤷ Set Type → ● At this level you have an opportunity to reassign or edit the location type you first selected and set the location to either one of the other types or change the data in an existing location.

This option also lets you associate a new Alert Tone to POI. Dangerous Xing and Dangerous Road each have unique Alert Tones that cannot be changed. You can still set a different volume level with the new Alert Tone for all three types.

⤷ Set LocationInfo → ● Input the latitude and then longitude.

⤷ Set Lockout → ● As you near your target location, an alert sounds at 1.0km, 0.5km, and 0.1km or (1.0mile, 0.50mile and 0.10mile). If you hear the first and prefer to not hear any others that occasion, simply press [L/O] to disable the operation while keeping all the data for another time. You can use the menu Lockout option as well. When you set the location system to **Temporary L/O** and move away more than four miles and then come back again, **L/O** status is automatically canceled. If you turn off the switch, the scanner is unlocked.

Deleting a Location

If you have programmed a location that you no longer want, you can delete it as follows.

[MENU] → Program Location →

↪ Select a location such as **Dangerous Xing** →

↪ Select Location to be deleted →

↪ Delete Location →

↪ Confirm Delete? Yes="E" / No="." →

Make your choice to either delete the location or to cancel your action.

For POI Only

↪ Set Alert Beep → Choose **off** so no tone sounds or one of the alert melodies **Alert 1 to Alert 4**.

Once you make a Tone selection you are then asked to assign a volume level to that selection.

Set Alert Volume → Select from 15 sound levels, plus Auto. As you rotate the **Scroll Control** the Alert tone you set is played louder and louder. Press to select a volume level. You can also select **Auto**, a level that is the same setting as your master volume control.

↪ Set Range → Input how far away the alert sounds for the site (only available for POI's)

For Dangerous Xing, and Dangerous Road Only

The Alert Tone is fixed.

↪ Set Alert Volume → Select from 15 sound levels, plus Auto and Off. As you rotate the **Scroll Control** the Alert tone is played louder and louder. Press to select a volume level. You can also select no sound (Off) or Auto, a level that is the same setting as your master volume control setting.

For Dangerous Xing and Dangerous Road sites there are two additional settings:

↪ Set Heading → You can input the compass direction to the site from your present location or, you can select **All Range**.

For example: If the **Dangerous Road** location is toward the Northeast and you are driving in that direction, then choose **NE (45°)**

If you know you will be driving a course which is not a fairly straight line to that site, choose **All Range** which will trigger the alert regardless of direction as long as the other requirements (range, speed) are met.

If you travel in a Northeast direction and do not travel either side of a northeast line by up to 22 degrees, the alert system will function.

↪ Set Speed Limit → Choose from 0 ~ 160km/h in 10km/h steps or 0 ~ 80mile/h in 5mile/h steps.

GPS Display Mode

If you press **[GPS]**, the scanner switches to a GPS display mode. In this mode, you can see location information as well as information about your position relative to the selected POI. The third line of the screen shows **OFF** if no POI is selected.

Rotate the **Scroll Control** to select different POI's.

Press **[OK]** + **[GPS]** to toggle the Display mode in order.

| |
|------------------|
| SW 01:23P |
| 39 mph 544 ft |
| OFF |
| SCAN ↑ |

GPS DATA Display

| |
|------------------|
| SW 1h 10m |
| 15.03 mi |
| HOME |
| SCAN ↑ |

ETA Display

| |
|-----------------|
| SW 13:23 |
| 15.03 mi |
| HOME |
| SCAN ↑ |

Clock Display

| |
|-----------------|
| SW 166 m |
| 24.19 km |
| HOME |
| SCAN ↑ |

Elevation Display

| |
|------------------|
| SW 62 kmh |
| 24.19 km |
| HOME |
| SCAN ↑ |

Speed Display

| |
|----------------|
| N 32°57' 33.60 |
| W 97°05' 34.18 |
| HOME |
| SCAN ↑ |

Location Display

GPS Review Location Mode

If you have programmed data for a Point of Interest, Dangerous Crossing, and a Dangerous Road, you can review each set on a screen dedicated to showing just that data.

Press **[EYES]** in GPS Mode.

Important: While you are in normal GPS mode or Scan Mode and you press and hold **[GPS]** for 2 seconds, location data at that point is stored. The scanner opens a dialog to store your current location. The default name is T YYMMDD hhmms that indicates the date and time you stored the location point.

The data is put into memory and you are given the opportunity to designate the location as POI, Dangerous Xing, or Dangerous Road.

However, if you are in Review Mode and press and hold **[GPS]**, the data of the new point will overwrite the currently displayed data.

The some of the following keys have a somewhat different function while in GPS Review Mode.

Using the UBC800XLT with a GPS

[GPS] — Press and Hold: overwrites and stores current location data.

[MENU] — returns to GPS Mode.

[L/O] — changes the status of the currently displayed location data.

[L/O] — press and hold to unlock all locations of the current type (POI, DXG, or DRD)

Unlocked All TTTs? and **Yes="E" / No="."** is displayed. **TTT** shows the location type as POI, DXG or DRD.

[L/O] — press and hold in Function Mode unlocks all locations of all types.

Unlocked All Location? and **Yes="E" / No="."** is displayed.

[.No] — returns to GPS Mode.

[EYES] — lets you edit a location details.

[SCAN/SEARCH] — enter scan mode.

[HOLD/RESUME] — enter Scan Hold mode.

☐ — enter Function Mode.

↻ — select a programmed location from all stored locations. The location data is stored in the order POI, Dangerous Xing, and Dangerous Road. Then, within each category, the data is stored by the programmed name.

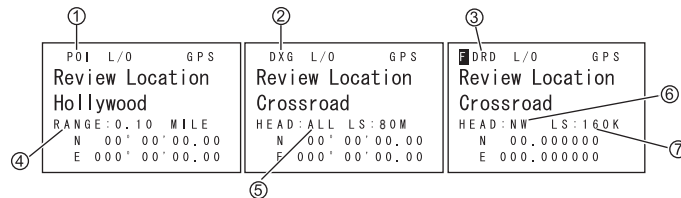

1. POI — Indicates a Point of Interest location.
2. DXG — Indicates a Dangerous Crossing location.
3. DRD — Indicates a Dangerous Road location.
4. Range — Indicates the programmed distance to your POI.
5. Head — Indicates the selected heading to the designated Dangerous Crossing from **any** direction.
6. Head — Indicates the selected heading to the designated Dangerous Road from a set direction.
7. LS — Indicates the maximum Speed Limit you set.

Care and Maintenance

General Use

Turn the scanner off before disconnecting the power.
If memory is lost, simply reprogram each channel.
Always press each button firmly until you hear the entry tone for that key entry.

Location

Do not use the scanner in high-moisture environments such as the kitchen or bathroom.

Avoid placing the unit in direct sunlight or near heating elements or vents.

If the scanner receives strong interference or electrical noise, move it or its antenna away from the source of the noise. If possible, a higher elevation might provide better reception.

Also try changing the height or angle of the antenna.

Cleaning

Disconnect the power to the unit before cleaning.

Clean the outside of the scanner with a mild detergent.

To prevent scratches, do not use abrasive cleaners or solvents. Be careful not to rub the LCD window.

Do not use excessive amounts of water.

Repairs

Do not attempt any repair. The scanner contains no user serviceable parts. Contact the Uniden Customer Service Center or take it to a qualified repair technician.

Birdies

All radios can receive "birdies" or undesired signals. If your scanner stops during Scan mode and no sound is heard, it might be receiving a birdie. Birdies are internally generated signals inherent in the electronics of the scanner.

Press **[L/O]** to lock out the channel.

Troubleshooting

If your UBC800XLT is not performing properly, try these steps.

| Problem | Possible Cause | Suggestion |
|---------------------------|--|--|
| The scanner doesn't work. | The scanner might not be receiving any power. | Make sure the AC adapter is connected to an AC outlet and the scanner. The display should light and cycle if you repeatedly press [VOL] |
| | | If there is a wall switch that controls power to the AC outlet where you connected the AC adapter, make sure it is on. |
| Improper reception. | The antenna might need to be adjusted. | Check the antenna connection or move or reposition the antenna. |
| | | Move the scanner. |
| | | You might be in a remote area that could require an optional multi-band antenna. Check with your dealer or local electronics store. |
| Scan won't stop. | The squelch might need to be adjusted. | Adjust the squelch threshold. See "Turning On the Scanner and Setting the Squelch" on Page 43. |
| | The antenna might need to be adjusted. | Check the antenna connection. |
| | One or more channels might be locked out. | Make sure the channels you want to scan are not locked out. |
| | The channel's frequency might not be stored in memory. | Make sure the channel's frequency is stored in the scanner's memory. |
| | The channel might not be active. | Wait for a transmission on the channel. |

| Problem | Possible Cause | Suggestion |
|-------------------|--|--|
| Scan won't start. | You must press [SCAN/SEARCH] to scan. | Press [SCAN/SEARCH] . |
| | The squelch might need to be adjusted. | Adjust the squelch threshold. See "Turning On the Scanner and Setting the Squelch" on Page 43. |
| | One or more channels might be locked out. | Make sure the channels you want to scan are not locked out. |
| | The antenna might need to be adjusted. | Check the antenna connection. |

If you experience difficulty while in TrunkTracker™ mode, try the following steps.

| Problem | Possible Cause | Suggestion |
|---|---|---|
| Scanner won't track a trunked system. | The system might not be one your scanner can scan. | Change to another system and try scanning that system. |
| | The data frequency might be missing. | Enter the data frequency. |
| | The scanner might need to be changed to a Type 1 scanner setup. | Change to a Type 1 scanner setup. See the programming instructions on the web at www.butelsoftware.com . |
| | The system you are trying to scan might be LTR or EDACS. | Set the scanner to scan LTR or EDACS systems. See the programming instructions on the web at www.butelsoftware.com . |
| | No ID's have been programmed. | Program one or more ID's or use the ID Search mode. |
| | The ID's you have stored are not active. | Wait for the ID's to become active or scan another system. |
| Scanner won't acquire the data channel. | The squelch might need to be adjusted. | Adjust the squelch threshold. See "Turning On the Scanner and Setting the Squelch" on Page 43. |
| | The frequency used for the data channel might be missing. | Check your frequency list for the data channel. |

| Problem | Possible Cause | Suggestion |
|-----------------------------------|---|---|
| Missing replies to conversations. | The scanner might need to be changed to a Type 1 scanner setup. | Change to a Type 1 scanner setup. See the programming instructions on the web at www.butelsoftware.com . |
| | The fleet map might be incorrect. | Try another preset fleet map or program your own fleet map. |
| | One or more of the system's frequencies might not be entered. | Make sure all the system's frequencies have been entered. |
| | The system you are trying to scan might be LTR or EDACS. | Set the scanner to scan LTR or EDACS systems. See the programming instructions on the web at www.butelsoftware.com . |

Other Specifications

| | |
|---------------------------------|---|
| ANT. Jack | BNC Type |
| Phone Jack | 3.5mm (Stereo Type) |
| Ext. SP Jack | 3.5mm (mono Type) |
| REC. Output Jack | 3.5mm (Stereo Type) |
| DC Power Jack | 5.5mm (Center Positive) |
| Remote Interface Jack | 4pin Mini Type |
| GPS Interface Jack | D-sub 9 pin (Male Wire) |
| Ext. DC Power and ORG Wire Jack | 3 pin (Center Orange Wire) |
| Internal Speaker | 8 ohm, 5 W Max. (77 Φ) |
| Power Requirements | DC 11.0V ~ 16.6V (Ext. DC Power Jack or DC Power Jack) |
| Operating Temperature | -20°C ~ +60°C |
| Storage Temperature | -30°C ~ +70°C |
| Size (mm) | (W)184 x (D) 151 x (H) 56 |
| Weight | 1.57kg |

Other Specifications

Reference

Preset Fleet Maps

Note: Size Codes in parenthesis indicates that the Size Code spans more than one block.

Preset Map 1

| Block | Size Code |
|-------|--------------|
| 0 | Size Code 11 |
| 1 | Size Code 11 |
| 2 | Size Code 11 |
| 3 | Size Code 11 |
| 4 | Size Code 11 |
| 5 | Size Code 11 |
| 6 | Size Code 11 |
| 7 | Size Code 11 |

Preset Map 2

| Block | Size Code |
|-------|-------------|
| 0 | Size Code 4 |
| 1 | Size Code 4 |
| 2 | Size Code 4 |
| 3 | Size Code 4 |
| 4 | Size Code 4 |
| 5 | Size Code 4 |
| 6 | Size Code 4 |
| 7 | Size Code 4 |

Preset Map 3

| Block | Size Code |
|-------|----------------|
| 0 | Size Code 4 |
| 1 | Size Code 4 |
| 2 | Size Code 4 |
| 3 | Size Code 4 |
| 4 | Size Code 4 |
| 5 | Size Code 4 |
| 6 | Size Code 12 |
| 7 | (Size Code 12) |

Preset Map 4

| Block | Size Code |
|-------|----------------|
| 0 | Size Code 12 |
| 1 | (Size Code 12) |
| 2 | Size Code 4 |
| 3 | Size Code 4 |
| 4 | Size Code 4 |
| 5 | Size Code 4 |
| 6 | Size Code 4 |
| 7 | Size Code 4 |

Preset Map 5

| Block | Size Code |
|-------|----------------|
| 0 | Size Code 4 |
| 1 | Size Code 4 |
| 2 | Size Code 12 |
| 3 | (Size Code 12) |
| 4 | Size Code 4 |
| 5 | Size Code 4 |
| 6 | Size Code 4 |
| 7 | Size Code 4 |

Preset Map 6

| Block | Size Code |
|-------|----------------|
| 0 | Size Code 3 |
| 1 | Size Code 10 |
| 2 | Size Code 4 |
| 3 | Size Code 4 |
| 4 | Size Code 12 |
| 5 | (Size Code 12) |
| 6 | Size Code 12 |
| 7 | (Size Code 12) |

Preset Map 7

| Block | Size Code |
|-------|--------------|
| 0 | Size Code 10 |
| 1 | Size Code 10 |
| 2 | Size Code 11 |
| 3 | Size Code 4 |
| 4 | Size Code 4 |
| 5 | Size Code 4 |
| 6 | Size Code 4 |
| 7 | Size Code 4 |

Preset Map 8

| Block | Size Code |
|-------|-------------|
| 0 | Size Code 1 |
| 1 | Size Code 1 |
| 2 | Size Code 2 |
| 3 | Size Code 2 |
| 4 | Size Code 3 |
| 5 | Size Code 3 |
| 6 | Size Code 4 |
| 7 | Size Code 4 |

Preset Map 9

| Block | Size Code |
|-------|-------------|
| 0 | Size Code 4 |
| 1 | Size Code 4 |
| 2 | Size Code 0 |
| 3 | Size Code 0 |
| 4 | Size Code 0 |
| 5 | Size Code 0 |
| 6 | Size Code 0 |
| 7 | Size Code 0 |

Preset Map 10

| Block | Size Code |
|-------|-------------|
| 0 | Size Code 0 |
| 1 | Size Code 0 |
| 2 | Size Code 0 |
| 3 | Size Code 0 |
| 4 | Size Code 0 |
| 5 | Size Code 0 |
| 6 | Size Code 4 |
| 7 | Size Code 4 |

Preset Map 11

| Block | Size Code |
|-------|-------------|
| 0 | Size Code 4 |
| 1 | Size Code 0 |
| 2 | Size Code 0 |
| 3 | Size Code 0 |
| 4 | Size Code 0 |
| 5 | Size Code 0 |
| 6 | Size Code 0 |
| 7 | Size Code 0 |

Preset Map 12

| Block | Size Code |
|-------|-------------|
| 0 | Size Code 0 |
| 1 | Size Code 0 |
| 2 | Size Code 0 |
| 3 | Size Code 0 |
| 4 | Size Code 0 |
| 5 | Size Code 0 |
| 6 | Size Code 0 |
| 7 | Size Code 4 |

Preset Map 13

| Block | Size Code |
|-------|--------------|
| 0 | Size Code 3 |
| 1 | Size Code 3 |
| 2 | Size Code 11 |
| 3 | Size Code 4 |
| 4 | Size Code 4 |
| 5 | Size Code 0 |
| 6 | Size Code 0 |
| 7 | Size Code 0 |

Preset Map 14

| Block | Size Code |
|-------|----------------|
| 0 | Size Code 4 |
| 1 | Size Code 3 |
| 2 | Size Code 10 |
| 3 | Size Code 4 |
| 4 | Size Code 4 |
| 5 | Size Code 4 |
| 6 | Size Code 12 |
| 7 | (Size Code 12) |

Reference

Preset Map 15

| Block | Size Code |
|-------|----------------|
| 0 | Size Code 4 |
| 1 | Size Code 4 |
| 2 | Size Code 4 |
| 3 | Size Code 11 |
| 4 | Size Code 11 |
| 5 | Size Code 0 |
| 6 | Size Code 12 |
| 7 | (Size Code 12) |

Preset Map 16

| Block | Size Code |
|-------|----------------|
| 0 | Size Code 3 |
| 1 | Size Code 10 |
| 2 | Size Code 10 |
| 3 | Size Code 11 |
| 4 | Size Code 0 |
| 5 | Size Code 0 |
| 6 | Size Code 12 |
| 7 | (Size Code 12) |

User Defined Fleet Maps

Type I Programming Information

When a Type I system is designed, the address information for all the ID's is divided into 8 equal sized blocks, numbered 0–7. When you program your scanner to track a Type I system, you must select a size code for each of these blocks. When you have assigned a size code to all 8 blocks, you'll have defined the fleet map for the system you are tracking. Each size code determines the number of fleets, subfleets, and ID's each block will have. For example, a size code of S-4 has one fleet, which is divided into 16 separate subfleets, and it has a total of 512 individual ID's.

When a block is assigned a size code, the fleet or fleets created within the block are assigned a Type I ID. The way these ID's display on your scanner depend on the block number and the block's size code. When a Type I ID appears, the leftmost digit represents the block which contains the ID.

The next 2-3 digits identify which fleet is active, and the last digit(s) identifies the subfleet.

The details concerning how the size codes are selected by a Type I System designer are highly dependent on the specific needs of the system's users. Some organizations might want many subfleets with only a few radios each, while another organization might want only a few subfleets with many radios each. Your task is to program your fleet map with the same size code assignments as the trunked system. If you do this accurately, you'll track all the Fleet-Subfleet combinations used by the system. In other words, you'll hear complete communications while monitoring a trunked system.

If you don't already know the size codes used, you'll have to guess at them. But since you don't have to figure out all the blocks at once, this isn't as hard as it

seems. Select a size code for a block, and then press **Scan**. Now listen to the communications. If you decide you are receiving most of the replies to the conversations with ID's assigned to the block you just programmed, then you've probably selected the right size code and can work on the next block of the map.

Finally, for most public safety systems there are some size codes which are more common. S-3 and S-4 are probably the most common, followed by S-10, S-11, and S-12.

Size Code Restrictions

If you select size code S-12, S-13, or S-14, there are some restrictions as to which blocks can be used for these codes.

- S-12 can only be assigned to Blocks 0, 2, 4, or 6.
- S-13 can only be assigned to Blocks 0 and 4.
- S-14 can only be assigned to Block 0.

Since these size codes require multiple blocks, you will be prompted for the next available block when programming a fleet map. For example, if you assign Block 0 as an S-12, you will be prompted for b2, the next block available, instead of b1. And if you assign Block 0 as an S-14, you would not see another prompt because it uses all available blocks.

Reference

123

CTCSS Frequencies

| | | | | | |
|-------|-------|-------|-------|-------|-------|
| 67.0 | 69.3 | 71.9 | 74.4 | 77.0 | 79.7 |
| 82.5 | 85.4 | 88.5 | 91.5 | 94.8 | 97.4 |
| 100.0 | 103.5 | 107.2 | 110.9 | 114.8 | 118.8 |
| 123.0 | 127.3 | 131.8 | 136.5 | 141.3 | 146.2 |
| 151.4 | 156.7 | 159.8 | 162.2 | 165.5 | 167.9 |
| 171.3 | 173.8 | 177.3 | 179.9 | 183.5 | 186.2 |
| 189.9 | 192.8 | 196.6 | 199.5 | 203.5 | 206.5 |
| 210.7 | 218.1 | 225.7 | 229.1 | 233.6 | 241.8 |
| 250.3 | 254.1 | | | | |

DCS Codes

| | | | | | | | |
|-----|-----|-----|-----|-----|-----|-----|-----|
| 023 | 025 | 026 | 031 | 032 | 036 | 043 | 047 |
| 051 | 053 | 054 | 065 | 071 | 072 | 073 | 074 |
| 114 | 115 | 116 | 122 | 125 | 131 | 132 | 134 |
| 143 | 145 | 152 | 155 | 156 | 162 | 165 | 172 |
| 174 | 205 | 212 | 223 | 225 | 226 | 243 | 244 |
| 245 | 246 | 251 | 252 | 255 | 261 | 263 | 265 |
| 266 | 271 | 274 | 306 | 311 | 315 | 325 | 331 |
| 332 | 343 | 346 | 351 | 356 | 364 | 365 | 371 |
| 411 | 412 | 413 | 423 | 431 | 432 | 445 | 446 |
| 452 | 454 | 455 | 462 | 464 | 465 | 466 | 503 |
| 506 | 516 | 523 | 526 | 532 | 546 | 565 | 606 |
| 612 | 624 | 627 | 631 | 632 | 654 | 662 | 664 |
| 703 | 712 | 723 | 731 | 732 | 734 | 743 | 754 |

Appendix

SERVICE SEARCH RANGES

The modulation for the service search frequencies depends on selected band plan except for the CB FM Radio and CB AM Radio service search.

Air

108.000 MHz to 136.9875 MHz (12.5 KHz STEP)

or

108.000 MHz to 136.9916 MHz (8.33 KHz STEP)

Marine

90 frequencies. The unit of frequencies is MHz.

The "CH No." shows Marine channel numbers.

| No. | CH No. | Frequency |
|-----|--------|-----------|
| 1 | 1T | 156.0500 |
| 2 | 1R | 160.6500 |
| 3 | 2T | 156.1000 |
| 4 | 2R | 160.7000 |
| 5 | 3T | 156.1500 |
| 6 | 3R | 160.7500 |
| 7 | 4T | 156.2000 |
| 8 | 4R | 160.8000 |
| 9 | 5T | 156.2500 |
| 10 | 5R | 160.8500 |
| 11 | 6 | 156.3000 |
| 12 | 7T | 156.3500 |
| 13 | 7R | 160.9500 |
| 14 | 8 | 156.4000 |
| 15 | 9 | 156.4500 |
| 16 | 10 | 156.5000 |
| 17 | 11 | 156.5500 |
| 18 | 12 | 156.6000 |

| | | |
|----|-----|----------|
| 19 | 13 | 156.6500 |
| 20 | 14 | 156.7000 |
| 21 | 15 | 156.7500 |
| 22 | 16 | 156.8000 |
| 23 | 17 | 156.8500 |
| 24 | 18T | 156.9000 |
| 25 | 18R | 161.5000 |
| 26 | 19T | 156.9500 |
| 27 | 19R | 161.5500 |
| 28 | 20T | 157.0000 |
| 29 | 20R | 161.6000 |
| 30 | 21T | 157.0500 |
| 31 | 21R | 161.6500 |
| 32 | 22T | 157.1000 |
| 33 | 22R | 161.7000 |
| 34 | 23T | 157.1500 |
| 35 | 23R | 161.7500 |
| 36 | 24T | 157.2000 |
| 37 | 24R | 161.8000 |

| | | |
|----|-----|----------|
| 38 | 25T | 157.2500 |
| 39 | 25R | 161.8500 |
| 40 | 26T | 157.3000 |
| 41 | 26R | 161.9000 |
| 42 | 27T | 157.3500 |
| 43 | 27R | 161.9500 |
| 44 | 28T | 157.4000 |
| 45 | 28R | 162.0000 |
| 46 | 60T | 156.0250 |
| 47 | 60R | 160.6250 |
| 48 | 61T | 156.0750 |
| 49 | 61R | 160.6750 |
| 50 | 62T | 156.1250 |
| 51 | 62R | 160.7250 |
| 52 | 63T | 156.1750 |
| 53 | 63R | 160.7750 |
| 54 | 64T | 156.2250 |
| 55 | 64R | 160.8250 |
| 56 | 65T | 156.2750 |

| | | |
|----|-----|----------|
| 57 | 65R | 160.8750 |
| 58 | 66T | 156.3250 |
| 59 | 66R | 160.9250 |
| 60 | 67 | 156.3750 |
| 61 | 68 | 156.4250 |
| 62 | 69 | 156.4750 |
| 63 | 70 | 156.5250 |
| 64 | 71 | 156.5750 |
| 65 | 72 | 156.6250 |
| 66 | 73 | 156.6750 |
| 67 | 74 | 156.7250 |
| 68 | 75 | 156.7750 |

| | | |
|----|-----|----------|
| 69 | 76 | 156.8250 |
| 70 | 77 | 156.8750 |
| 71 | 78T | 156.9250 |
| 72 | 78R | 161.5250 |
| 73 | 79T | 156.9750 |
| 74 | 79R | 161.5750 |
| 75 | 80T | 157.0250 |
| 76 | 80R | 161.6250 |
| 77 | 81T | 157.0750 |
| 78 | 81R | 161.6750 |
| 79 | 82T | 157.1250 |
| 80 | 82R | 161.7250 |

| | | |
|----|-----|----------|
| 81 | 83T | 157.1750 |
| 82 | 83R | 161.7750 |
| 83 | 84T | 157.2250 |
| 84 | 84R | 161.8250 |
| 85 | 85T | 157.2750 |
| 86 | 85R | 161.8750 |
| 87 | 86T | 157.3250 |
| 88 | 86R | 161.9250 |
| 89 | 87 | 157.3750 |
| 90 | 88 | 157.4250 |

CB AM Radio

520 frequencies. The unit of frequencies is MHz.

The "CH No." shows CB AM Radio channel numbers.

Band A

| CH No. | Frequency |
|--------|-----------|
| 1a | 26.9650 |
| 2a | 26.9750 |
| 3a | 26.9850 |
| 4a | 27.0050 |
| 5a | 27.0150 |
| 6a | 27.0250 |
| 7a | 27.0350 |
| 8a | 27.0550 |
| 9a | 27.0650 |
| 10a | 27.0750 |
| 11a | 27.0850 |
| 12a | 27.1050 |
| 13a | 27.1150 |
| 14a | 27.1250 |
| 15a | 27.1350 |

| | |
|-----|---------|
| 16a | 27.1550 |
| 17a | 27.1650 |
| 18a | 27.1750 |
| 19a | 27.1850 |
| 20a | 27.2050 |
| 21a | 27.2150 |
| 22a | 27.2250 |
| 23a | 27.2550 |
| 24a | 27.2350 |
| 25a | 27.2450 |
| 26a | 27.2650 |
| 27a | 27.2750 |
| 28a | 27.2850 |
| 29a | 27.2950 |
| 30a | 27.3050 |
| 31a | 27.3150 |

| | |
|-----|---------|
| 32a | 27.3250 |
| 33a | 27.3350 |
| 34a | 27.3450 |
| 35a | 27.3550 |
| 36a | 27.3650 |
| 37a | 27.3750 |
| 38a | 27.3850 |
| 39a | 27.3950 |
| 40a | 27.4050 |

Band B

| CH No. | Frequency |
|--------|-----------|
| 1b | 27.4150 |
| 2b | 27.4250 |
| 3b | 27.4350 |
| 4b | 27.4550 |
| 5b | 27.4650 |

| | |
|-----|---------|
| 6b | 27.4750 |
| 7b | 27.4850 |
| 8b | 27.5050 |
| 9b | 27.5150 |
| 10b | 27.5250 |
| 11b | 27.5350 |
| 12b | 27.5550 |
| 13b | 27.5650 |
| 14b | 27.5750 |
| 15b | 27.5850 |
| 16b | 27.6050 |
| 17b | 27.6150 |
| 18b | 27.6250 |
| 19b | 27.6350 |
| 20b | 27.6550 |
| 21b | 27.6650 |
| 22b | 27.6750 |
| 23b | 27.7050 |
| 24b | 27.6850 |
| 25b | 27.6950 |
| 26b | 27.7150 |
| 27b | 27.7250 |
| 28b | 27.7350 |
| 29b | 27.7450 |
| 30b | 27.7550 |
| 31b | 27.7650 |
| 32b | 27.7750 |
| 33b | 27.7850 |
| 34b | 27.7950 |
| 35b | 27.8050 |
| 36b | 27.8150 |
| 37b | 27.8250 |
| 38b | 27.8350 |
| 39b | 27.8450 |
| 40b | 27.8550 |

Band C

| CH No. | Frequency |
|--------|-----------|
| 1c | 26.5150 |
| 2c | 26.5250 |
| 3c | 26.5350 |
| 4c | 26.5550 |
| 5c | 26.5650 |
| 6c | 26.5750 |
| 7c | 26.5850 |
| 8c | 26.6050 |
| 9c | 26.6150 |
| 10c | 26.6250 |
| 11c | 26.6350 |
| 12c | 26.6550 |
| 13c | 26.6650 |
| 14c | 26.6750 |
| 15c | 26.6850 |
| 16c | 26.7050 |
| 17c | 26.7150 |
| 18c | 26.7250 |
| 19c | 26.7350 |
| 20c | 26.7550 |
| 21c | 26.7650 |
| 22c | 26.7750 |
| 23c | 26.8050 |
| 24c | 26.7850 |
| 25c | 26.7950 |
| 26c | 26.8150 |
| 27c | 26.8250 |
| 28c | 26.8350 |
| 29c | 26.8450 |
| 30c | 26.8550 |
| 31c | 26.8650 |
| 32c | 26.8750 |
| 33c | 26.8850 |

| | |
|-----|---------|
| 34c | 26.8950 |
| 35c | 26.9050 |
| 36c | 26.9150 |
| 37c | 26.9250 |
| 38c | 26.9350 |
| 39c | 26.9450 |
| 40c | 26.9550 |

Band D

| CH No. | Frequency |
|--------|-----------|
| 1d | 27.8650 |
| 2d | 27.8750 |
| 3d | 27.8850 |
| 4d | 27.9050 |
| 5d | 27.9150 |
| 6d | 27.9250 |
| 7d | 27.9350 |
| 8d | 27.9550 |
| 9d | 27.9650 |
| 10d | 27.9750 |
| 11d | 27.9850 |
| 12d | 28.0050 |
| 13d | 28.0150 |
| 14d | 28.0250 |
| 15d | 28.0350 |
| 16d | 28.0550 |
| 17d | 28.0650 |
| 18d | 28.0750 |
| 19d | 28.0850 |
| 20d | 28.1050 |
| 21d | 28.1150 |
| 22d | 28.1250 |
| 23d | 28.1550 |
| 24d | 28.1350 |
| 25d | 28.1450 |
| 26d | 28.1650 |

Appendix

| | |
|-----|---------|
| 27d | 28.1750 |
| 28d | 28.1850 |
| 29d | 28.1950 |
| 30d | 28.2050 |
| 31d | 28.2150 |
| 32d | 28.2250 |
| 33d | 28.2350 |
| 34d | 28.2450 |
| 35d | 28.2550 |
| 36d | 28.2650 |
| 37d | 28.2750 |
| 38d | 28.2850 |
| 39d | 28.2950 |
| 40d | 28.3050 |

Band E

| CH No. | Frequency |
|--------|-----------|
| 1e | 26.0650 |
| 2e | 26.0750 |
| 3e | 26.0850 |
| 4e | 26.1050 |
| 5e | 26.1150 |
| 6e | 26.1250 |
| 7e | 26.1350 |
| 8e | 26.1550 |
| 9e | 26.1650 |
| 10e | 26.1750 |
| 11e | 26.1850 |
| 12e | 26.2050 |
| 13e | 26.2150 |
| 14e | 26.2250 |
| 15e | 26.2350 |
| 16e | 26.2550 |
| 17e | 26.2650 |
| 18e | 26.2750 |
| 19e | 26.2850 |

| | |
|-----|---------|
| 20e | 26.3050 |
| 21e | 26.3150 |
| 22e | 26.3250 |
| 23e | 26.3550 |
| 24e | 26.3350 |
| 25e | 26.3450 |
| 26e | 26.3650 |
| 27e | 26.3750 |
| 28e | 26.3850 |
| 29e | 26.3950 |
| 30e | 26.4050 |
| 31e | 26.4150 |
| 32e | 26.4250 |
| 33e | 26.4350 |
| 34e | 26.4450 |
| 35e | 26.4550 |
| 36e | 26.4650 |
| 37e | 26.4750 |
| 38e | 26.4850 |
| 39e | 26.4950 |
| 40e | 26.5050 |

Band F

| CH No. | Frequency |
|--------|-----------|
| 1f | 28.3150 |
| 2f | 28.3250 |
| 3f | 28.3350 |
| 4f | 28.3550 |
| 5f | 28.3650 |
| 6f | 28.3750 |
| 7f | 28.3850 |
| 8f | 28.4050 |
| 9f | 28.4150 |
| 10f | 28.4250 |
| 11f | 28.4350 |
| 12f | 28.4550 |

| | |
|-----|---------|
| 13f | 28.4650 |
| 14f | 28.4750 |
| 15f | 28.4850 |
| 16f | 28.5050 |
| 17f | 28.5150 |
| 18f | 28.5250 |
| 19f | 28.5350 |
| 20f | 28.5550 |
| 21f | 28.5650 |
| 22f | 28.5750 |
| 23f | 28.6050 |
| 24f | 28.5850 |
| 25f | 28.5950 |
| 26f | 28.6150 |
| 27f | 28.6250 |
| 28f | 28.6350 |
| 29f | 28.6450 |
| 30f | 28.6550 |
| 31f | 28.6650 |
| 32f | 28.6750 |
| 33f | 28.6850 |
| 34f | 28.6950 |
| 35f | 28.7050 |
| 36f | 28.7150 |
| 37f | 28.7250 |
| 38f | 28.7350 |
| 39f | 28.7450 |
| 40f | 28.7550 |

Band G

| CH No. | Frequency |
|--------|-----------|
| 1g | 25.6150 |
| 2g | 25.6250 |
| 3g | 25.6350 |
| 4g | 25.6550 |
| 5g | 25.6650 |

| | |
|-----|---------|
| 6g | 25.6750 |
| 7g | 25.6850 |
| 8g | 25.7050 |
| 9g | 25.7150 |
| 10g | 25.7250 |
| 11g | 25.7350 |
| 12g | 25.7550 |
| 13g | 25.7650 |
| 14g | 25.7750 |
| 15g | 25.7850 |
| 16g | 25.8050 |
| 17g | 25.8150 |
| 18g | 25.8250 |
| 19g | 25.8350 |
| 20g | 25.8550 |
| 21g | 25.8650 |
| 22g | 25.8750 |
| 23g | 25.9050 |
| 24g | 25.8850 |
| 25g | 25.8950 |
| 26g | 25.9150 |
| 27g | 25.9250 |
| 28g | 25.9350 |
| 29g | 25.9450 |
| 30g | 25.9550 |
| 31g | 25.9650 |
| 32g | 25.9750 |
| 33g | 25.9850 |
| 34g | 25.9950 |
| 35g | 26.0050 |
| 36g | 26.0150 |
| 37g | 26.0250 |
| 38g | 26.0350 |
| 39g | 26.0450 |
| 40g | 26.0550 |

Band H

| CH No. | Frequency |
|--------|-----------|
| 1h | 28.7650 |
| 2h | 28.7750 |
| 3h | 28.7850 |
| 4h | 28.8050 |
| 5h | 28.8150 |
| 6h | 28.8250 |
| 7h | 28.8350 |
| 8h | 28.8550 |
| 9h | 28.8650 |
| 10h | 28.8750 |
| 11h | 28.8850 |
| 12h | 28.9050 |
| 13h | 28.9150 |
| 14h | 28.9250 |
| 15h | 28.9350 |
| 16h | 28.9550 |
| 17h | 28.9650 |
| 18h | 28.9750 |
| 19h | 28.9850 |
| 20h | 29.0050 |
| 21h | 29.0150 |
| 22h | 29.0250 |
| 23h | 29.0550 |
| 24h | 29.0350 |
| 25h | 29.0450 |
| 26h | 29.0650 |
| 27h | 29.0750 |
| 28h | 29.0850 |
| 29h | 29.0950 |
| 30h | 29.1050 |
| 31h | 29.1150 |
| 32h | 29.1250 |
| 33h | 29.1350 |

| | |
|-----|---------|
| 34h | 29.1450 |
| 35h | 29.1550 |
| 36h | 29.1650 |
| 37h | 29.1750 |
| 38h | 29.1850 |
| 39h | 29.1950 |
| 40h | 29.2050 |

Band I

| CH No. | Frequency |
|--------|-----------|
| 1i | 29.2150 |
| 2i | 29.2250 |
| 3i | 29.2350 |
| 4i | 29.2550 |
| 5i | 29.2650 |
| 6i | 29.2750 |
| 7i | 29.2850 |
| 8i | 29.3050 |
| 9i | 29.3150 |
| 10i | 29.3250 |
| 11i | 29.3350 |
| 12i | 29.3550 |
| 13i | 29.3650 |
| 14i | 29.3750 |
| 15i | 29.3850 |
| 16i | 29.4050 |
| 17i | 29.4150 |
| 18i | 29.4250 |
| 19i | 29.4350 |
| 20i | 29.4550 |
| 21i | 29.4650 |
| 22i | 29.4750 |
| 23i | 29.5050 |
| 24i | 29.4850 |
| 25i | 29.4950 |
| 26i | 29.5150 |

Appendix

| | |
|-----|---------|
| 27i | 29.5250 |
| 28i | 29.5350 |
| 29i | 29.5450 |
| 30i | 29.5550 |
| 31i | 29.5650 |
| 32i | 29.5750 |
| 33i | 29.5850 |
| 34i | 29.5950 |
| 35i | 29.6050 |
| 36i | 29.6150 |
| 37i | 29.6250 |
| 38i | 29.6350 |
| 39i | 29.6450 |
| 40i | 29.6550 |

Band J

| CH No. | Frequency |
|--------|-----------|
| 1j | 29.6650 |
| 2j | 29.6750 |
| 3j | 29.6850 |
| 4j | 29.7050 |
| 5j | 29.7150 |
| 6j | 29.7250 |
| 7j | 29.7350 |
| 8j | 29.7550 |
| 9j | 29.7650 |
| 10j | 29.7750 |
| 11j | 29.7850 |
| 12j | 29.8050 |
| 13j | 29.8150 |
| 14j | 29.8250 |
| 15j | 29.8350 |
| 16j | 29.8550 |
| 17j | 29.8650 |
| 18j | 29.8750 |
| 19j | 29.8850 |

| | |
|-----|---------|
| 20j | 29.9050 |
| 21j | 29.9150 |
| 22j | 29.9250 |
| 23j | 29.9550 |
| 24j | 29.9350 |
| 25j | 29.9450 |
| 26j | 29.9650 |
| 27j | 29.9750 |
| 28j | 29.9850 |
| 29j | 29.9950 |
| 30j | 30.0050 |
| 31j | 30.0150 |
| 32j | 30.0250 |
| 33j | 30.0350 |
| 34j | 30.0450 |
| 35j | 30.0550 |
| 36j | 30.0650 |
| 37j | 30.0750 |
| 38j | 30.0850 |
| 39j | 30.0950 |
| 40j | 30.1050 |

GERMANY

| CH No. | Frequency |
|--------|-----------|
| 41G | 26.5650 |
| 42G | 26.5750 |
| 43G | 26.5850 |
| 44G | 26.5950 |
| 45G | 26.6050 |
| 46G | 26.6150 |
| 47G | 26.6250 |
| 48G | 26.6350 |
| 49G | 26.6450 |
| 50G | 26.6550 |
| 51G | 26.6650 |
| 52G | 26.6750 |

| | |
|-----|---------|
| 53G | 26.6850 |
| 54G | 26.6950 |
| 55G | 26.7050 |
| 56G | 26.7150 |
| 57G | 26.7250 |
| 58G | 26.7350 |
| 59G | 26.7450 |
| 60G | 26.7550 |
| 61G | 26.7650 |
| 62G | 26.7750 |
| 63G | 26.7850 |
| 64G | 26.7950 |
| 65G | 26.8050 |
| 66G | 26.8150 |
| 67G | 26.8250 |
| 68G | 26.8350 |
| 69G | 26.8450 |
| 70G | 26.8550 |
| 71G | 26.8650 |
| 72G | 26.8750 |
| 73G | 26.8850 |
| 74G | 26.8950 |
| 75G | 26.9050 |
| 76G | 26.9150 |
| 77G | 26.9250 |
| 78G | 26.9350 |
| 79G | 26.9450 |
| 80G | 26.9550 |

ENGLAND

| CH No. | Frequency |
|--------|-----------|
| 1E | 27.60125 |
| 2E | 27.61125 |
| 3E | 27.62125 |
| 4E | 27.63125 |
| 5E | 27.64125 |

| | |
|-----|----------|
| 6E | 27.65125 |
| 7E | 27.66125 |
| 8E | 27.67125 |
| 9E | 27.68125 |
| 10E | 27.69125 |
| 11E | 27.70125 |
| 12E | 27.71125 |
| 13E | 27.72125 |
| 14E | 27.73125 |
| 15E | 27.74125 |
| 16E | 27.75125 |
| 17E | 27.76125 |
| 18E | 27.77125 |
| 19E | 27.78125 |
| 20E | 27.79125 |
| 21E | 27.80125 |
| 22E | 27.81125 |
| 23E | 27.82125 |
| 24E | 27.83125 |
| 25E | 27.84125 |
| 26E | 27.85125 |
| 27E | 27.86125 |
| 28E | 27.87125 |
| 29E | 27.88125 |
| 30E | 27.89125 |
| 31E | 27.90125 |
| 32E | 27.91125 |
| 33E | 27.92125 |
| 34E | 27.93125 |
| 35E | 27.94125 |
| 36E | 27.95125 |
| 37E | 27.96125 |
| 38E | 27.97125 |
| 39E | 27.98125 |
| 40E | 27.99125 |

POLAND

| CH No. | Frequency |
|--------|-----------|
| 1P | 26.9600 |
| 2P | 26.9700 |
| 3P | 26.9800 |
| 4P | 27.0000 |
| 5P | 27.0100 |
| 6P | 27.0200 |
| 7P | 27.0300 |
| 8P | 27.0500 |
| 9P | 27.0600 |
| 10P | 27.0700 |
| 11P | 27.0800 |
| 12P | 27.1000 |
| 13P | 27.1100 |
| 14P | 27.1200 |
| 15P | 27.1300 |
| 16P | 27.1500 |
| 17P | 27.1600 |
| 18P | 27.1700 |
| 19P | 27.1800 |
| 20P | 27.2000 |
| 21P | 27.2100 |
| 22P | 27.2200 |
| 23P | 27.2500 |
| 24P | 27.2300 |
| 25P | 27.2400 |
| 26P | 27.2600 |
| 27P | 27.2700 |
| 28P | 27.2800 |
| 29P | 27.2900 |
| 30P | 27.3000 |
| 31P | 27.3100 |
| 32P | 27.3200 |
| 33P | 27.3300 |

| | |
|-----|---------|
| 34P | 27.3400 |
| 35P | 27.3500 |
| 36P | 27.3600 |
| 37P | 27.3700 |
| 38P | 27.3800 |
| 39P | 27.3900 |
| 40P | 27.4000 |

Appendix

CB FM Radio

520 frequencies. The unit of frequencies is MHz.

The "CH No." shows CB FM Radio channel numbers.

Band A

| CH No. | Frequency |
|--------|-----------|
| 1a | 26.9650 |
| 2a | 26.9750 |
| 3a | 26.9850 |
| 4a | 27.0050 |
| 5a | 27.0150 |
| 6a | 27.0250 |
| 7a | 27.0350 |
| 8a | 27.0550 |
| 9a | 27.0650 |
| 10a | 27.0750 |
| 11a | 27.0850 |
| 12a | 27.1050 |
| 13a | 27.1150 |
| 14a | 27.1250 |
| 15a | 27.1350 |
| 16a | 27.1550 |
| 17a | 27.1650 |
| 18a | 27.1750 |
| 19a | 27.1850 |
| 20a | 27.2050 |
| 21a | 27.2150 |
| 22a | 27.2250 |
| 23a | 27.2550 |
| 24a | 27.2350 |
| 25a | 27.2450 |
| 26a | 27.2650 |
| 27a | 27.2750 |
| 28a | 27.2850 |
| 29a | 27.2950 |

| | |
|-----|---------|
| 30a | 27.3050 |
| 31a | 27.3150 |
| 32a | 27.3250 |
| 33a | 27.3350 |
| 34a | 27.3450 |
| 35a | 27.3550 |
| 36a | 27.3650 |
| 37a | 27.3750 |
| 38a | 27.3850 |
| 39a | 27.3950 |
| 40a | 27.4050 |

Band B

| CH No. | Frequency |
|--------|-----------|
| 1b | 27.4150 |
| 2b | 27.4250 |
| 3b | 27.4350 |
| 4b | 27.4550 |
| 5b | 27.4650 |
| 6b | 27.4750 |
| 7b | 27.4850 |
| 8b | 27.5050 |
| 9b | 27.5150 |
| 10b | 27.5250 |
| 11b | 27.5350 |
| 12b | 27.5550 |
| 13b | 27.5650 |
| 14b | 27.5750 |
| 15b | 27.5850 |
| 16b | 27.6050 |
| 17b | 27.6150 |

| | |
|-----|---------|
| 18b | 27.6250 |
| 19b | 27.6350 |
| 20b | 27.6550 |
| 21b | 27.6650 |
| 22b | 27.6750 |
| 23b | 27.7050 |
| 24b | 27.6850 |
| 25b | 27.6950 |
| 26b | 27.7150 |
| 27b | 27.7250 |
| 28b | 27.7350 |
| 29b | 27.7450 |
| 30b | 27.7550 |
| 31b | 27.7650 |
| 32b | 27.7750 |
| 33b | 27.7850 |
| 34b | 27.7950 |
| 35b | 27.8050 |
| 36b | 27.8150 |
| 37b | 27.8250 |
| 38b | 27.8350 |
| 39b | 27.8450 |
| 40b | 27.8550 |

Band C

| CH No. | Frequency |
|--------|-----------|
| 1c | 26.5150 |
| 2c | 26.5250 |
| 3c | 26.5350 |
| 4c | 26.5550 |
| 5c | 26.5650 |

| | |
|-----|---------|
| 6c | 26.5750 |
| 7c | 26.5850 |
| 8c | 26.6050 |
| 9c | 26.6150 |
| 10c | 26.6250 |
| 11c | 26.6350 |
| 12c | 26.6550 |
| 13c | 26.6650 |
| 14c | 26.6750 |
| 15c | 26.6850 |
| 16c | 26.7050 |
| 17c | 26.7150 |
| 18c | 26.7250 |
| 19c | 26.7350 |
| 20c | 26.7550 |
| 21c | 26.7650 |
| 22c | 26.7750 |
| 23c | 26.8050 |
| 24c | 26.7850 |
| 25c | 26.7950 |
| 26c | 26.8150 |
| 27c | 26.8250 |
| 28c | 26.8350 |
| 29c | 26.8450 |
| 30c | 26.8550 |
| 31c | 26.8650 |
| 32c | 26.8750 |
| 33c | 26.8850 |
| 34c | 26.8950 |
| 35c | 26.9050 |
| 36c | 26.9150 |
| 37c | 26.9250 |
| 38c | 26.9350 |
| 39c | 26.9450 |
| 40c | 26.9550 |

Band D

| CH No. | Frequency |
|--------|-----------|
| 1d | 27.8650 |
| 2d | 27.8750 |
| 3d | 27.8850 |
| 4d | 27.9050 |
| 5d | 27.9150 |
| 6d | 27.9250 |
| 7d | 27.9350 |
| 8d | 27.9550 |
| 9d | 27.9650 |
| 10d | 27.9750 |
| 11d | 27.9850 |
| 12d | 28.0050 |
| 13d | 28.0150 |
| 14d | 28.0250 |
| 15d | 28.0350 |
| 16d | 28.0550 |
| 17d | 28.0650 |
| 18d | 28.0750 |
| 19d | 28.0850 |
| 20d | 28.1050 |
| 21d | 28.1150 |
| 22d | 28.1250 |
| 23d | 28.1550 |
| 24d | 28.1350 |
| 25d | 28.1450 |
| 26d | 28.1650 |
| 27d | 28.1750 |
| 28d | 28.1850 |
| 29d | 28.1950 |
| 30d | 28.2050 |
| 31d | 28.2150 |
| 32d | 28.2250 |
| 33d | 28.2350 |

| | |
|-----|---------|
| 34d | 28.2450 |
| 35d | 28.2550 |
| 36d | 28.2650 |
| 37d | 28.2750 |
| 38d | 28.2850 |
| 39d | 28.2950 |
| 40d | 28.3050 |

Band E

| CH No. | Frequency |
|--------|-----------|
| 1e | 26.0650 |
| 2e | 26.0750 |
| 3e | 26.0850 |
| 4e | 26.1050 |
| 5e | 26.1150 |
| 6e | 26.1250 |
| 7e | 26.1350 |
| 8e | 26.1550 |
| 9e | 26.1650 |
| 10e | 26.1750 |
| 11e | 26.1850 |
| 12e | 26.2050 |
| 13e | 26.2150 |
| 14e | 26.2250 |
| 15e | 26.2350 |
| 16e | 26.2550 |
| 17e | 26.2650 |
| 18e | 26.2750 |
| 19e | 26.2850 |
| 20e | 26.3050 |
| 21e | 26.3150 |
| 22e | 26.3250 |
| 23e | 26.3550 |
| 24e | 26.3350 |
| 25e | 26.3450 |
| 26e | 26.3650 |

Appendix

| | |
|-----|---------|
| 27e | 26.3750 |
| 28e | 26.3850 |
| 29e | 26.3950 |
| 30e | 26.4050 |
| 31e | 26.4150 |
| 32e | 26.4250 |
| 33e | 26.4350 |
| 34e | 26.4450 |
| 35e | 26.4550 |
| 36e | 26.4650 |
| 37e | 26.4750 |
| 38e | 26.4850 |
| 39e | 26.4950 |
| 40e | 26.5050 |

Band F

| CH No. | Frequency |
|--------|-----------|
| 1f | 28.3150 |
| 2f | 28.3250 |
| 3f | 28.3350 |
| 4f | 28.3550 |
| 5f | 28.3650 |
| 6f | 28.3750 |
| 7f | 28.3850 |
| 8f | 28.4050 |
| 9f | 28.4150 |
| 10f | 28.4250 |
| 11f | 28.4350 |
| 12f | 28.4550 |
| 13f | 28.4650 |
| 14f | 28.4750 |
| 15f | 28.4850 |
| 16f | 28.5050 |
| 17f | 28.5150 |
| 18f | 28.5250 |
| 19f | 28.5350 |

| | |
|-----|---------|
| 20f | 28.5550 |
| 21f | 28.5650 |
| 22f | 28.5750 |
| 23f | 28.6050 |
| 24f | 28.5850 |
| 25f | 28.5950 |
| 26f | 28.6150 |
| 27f | 28.6250 |
| 28f | 28.6350 |
| 29f | 28.6450 |
| 30f | 28.6550 |
| 31f | 28.6650 |
| 32f | 28.6750 |
| 33f | 28.6850 |
| 34f | 28.6950 |
| 35f | 28.7050 |
| 36f | 28.7150 |
| 37f | 28.7250 |
| 38f | 28.7350 |
| 39f | 28.7450 |
| 40f | 28.7550 |

Band G

| CH No. | Frequency |
|--------|-----------|
| 1g | 25.6150 |
| 2g | 25.6250 |
| 3g | 25.6350 |
| 4g | 25.6550 |
| 5g | 25.6650 |
| 6g | 25.6750 |
| 7g | 25.6850 |
| 8g | 25.7050 |
| 9g | 25.7150 |
| 10g | 25.7250 |
| 11g | 25.7350 |
| 12g | 25.7550 |

| | |
|-----|---------|
| 13g | 25.7650 |
| 14g | 25.7750 |
| 15g | 25.7850 |
| 16g | 25.8050 |
| 17g | 25.8150 |
| 18g | 25.8250 |
| 19g | 25.8350 |
| 20g | 25.8550 |
| 21g | 25.8650 |
| 22g | 25.8750 |
| 23g | 25.9050 |
| 24g | 25.8850 |
| 25g | 25.8950 |
| 26g | 25.9150 |
| 27g | 25.9250 |
| 28g | 25.9350 |
| 29g | 25.9450 |
| 30g | 25.9550 |
| 31g | 25.9650 |
| 32g | 25.9750 |
| 33g | 25.9850 |
| 34g | 25.9950 |
| 35g | 26.0050 |
| 36g | 26.0150 |
| 37g | 26.0250 |
| 38g | 26.0350 |
| 39g | 26.0450 |
| 40g | 26.0550 |

Band H

| CH No. | Frequency |
|--------|-----------|
| 1h | 28.7650 |
| 2h | 28.7750 |
| 3h | 28.7850 |
| 4h | 28.8050 |
| 5h | 28.8150 |

| | |
|-----|---------|
| 6h | 28.8250 |
| 7h | 28.8350 |
| 8h | 28.8550 |
| 9h | 28.8650 |
| 10h | 28.8750 |
| 11h | 28.8850 |
| 12h | 28.9050 |
| 13h | 28.9150 |
| 14h | 28.9250 |
| 15h | 28.9350 |
| 16h | 28.9550 |
| 17h | 28.9650 |
| 18h | 28.9750 |
| 19h | 28.9850 |
| 20h | 29.0050 |
| 21h | 29.0150 |
| 22h | 29.0250 |
| 23h | 29.0550 |
| 24h | 29.0350 |
| 25h | 29.0450 |
| 26h | 29.0650 |
| 27h | 29.0750 |
| 28h | 29.0850 |
| 29h | 29.0950 |
| 30h | 29.1050 |
| 31h | 29.1150 |
| 32h | 29.1250 |
| 33h | 29.1350 |
| 34h | 29.1450 |
| 35h | 29.1550 |
| 36h | 29.1650 |
| 37h | 29.1750 |
| 38h | 29.1850 |
| 39h | 29.1950 |
| 40h | 29.2050 |

Band I

| CH No. | Frequency |
|--------|-----------|
| 1i | 29.2150 |
| 2i | 29.2250 |
| 3i | 29.2350 |
| 4i | 29.2550 |
| 5i | 29.2650 |
| 6i | 29.2750 |
| 7i | 29.2850 |
| 8i | 29.3050 |
| 9i | 29.3150 |
| 10i | 29.3250 |
| 11i | 29.3350 |
| 12i | 29.3550 |
| 13i | 29.3650 |
| 14i | 29.3750 |
| 15i | 29.3850 |
| 16i | 29.4050 |
| 17i | 29.4150 |
| 18i | 29.4250 |
| 19i | 29.4350 |
| 20i | 29.4550 |
| 21i | 29.4650 |
| 22i | 29.4750 |
| 23i | 29.5050 |
| 24i | 29.4850 |
| 25i | 29.4950 |
| 26i | 29.5150 |
| 27i | 29.5250 |
| 28i | 29.5350 |
| 29i | 29.5450 |
| 30i | 29.5550 |
| 31i | 29.5650 |
| 32i | 29.5750 |
| 33i | 29.5850 |

| | |
|-----|---------|
| 34i | 29.5950 |
| 35i | 29.6050 |
| 36i | 29.6150 |
| 37i | 29.6250 |
| 38i | 29.6350 |
| 39i | 29.6450 |
| 40i | 29.6550 |

Band J

| CH No. | Frequency |
|--------|-----------|
| 1j | 29.6650 |
| 2j | 29.6750 |
| 3j | 29.6850 |
| 4j | 29.7050 |
| 5j | 29.7150 |
| 6j | 29.7250 |
| 7j | 29.7350 |
| 8j | 29.7550 |
| 9j | 29.7650 |
| 10j | 29.7750 |
| 11j | 29.7850 |
| 12j | 29.8050 |
| 13j | 29.8150 |
| 14j | 29.8250 |
| 15j | 29.8350 |
| 16j | 29.8550 |
| 17j | 29.8650 |
| 18j | 29.8750 |
| 19j | 29.8850 |
| 20j | 29.9050 |
| 21j | 29.9150 |
| 22j | 29.9250 |
| 23j | 29.9550 |
| 24j | 29.9350 |
| 25j | 29.9450 |
| 26j | 29.9650 |

Appendix

| | |
|-----|---------|
| 27j | 29.9750 |
| 28j | 29.9850 |
| 29j | 29.9950 |
| 30j | 30.0050 |
| 31j | 30.0150 |
| 32j | 30.0250 |
| 33j | 30.0350 |
| 34j | 30.0450 |
| 35j | 30.0550 |
| 36j | 30.0650 |
| 37j | 30.0750 |
| 38j | 30.0850 |
| 39j | 30.0950 |
| 40j | 30.1050 |

GERMANY

| CH No. | Frequency |
|--------|-----------|
| 41G | 26.5650 |
| 42G | 26.5750 |
| 43G | 26.5850 |
| 44G | 26.5950 |
| 45G | 26.6050 |
| 46G | 26.6150 |
| 47G | 26.6250 |
| 48G | 26.6350 |
| 49G | 26.6450 |
| 50G | 26.6550 |
| 51G | 26.6650 |
| 52G | 26.6750 |
| 53G | 26.6850 |
| 54G | 26.6950 |
| 55G | 26.7050 |
| 56G | 26.7150 |
| 57G | 26.7250 |
| 58G | 26.7350 |
| 59G | 26.7450 |

| | |
|-----|---------|
| 60G | 26.7550 |
| 61G | 26.7650 |
| 62G | 26.7750 |
| 63G | 26.7850 |
| 64G | 26.7950 |
| 65G | 26.8050 |
| 66G | 26.8150 |
| 67G | 26.8250 |
| 68G | 26.8350 |
| 69G | 26.8450 |
| 70G | 26.8550 |
| 71G | 26.8650 |
| 72G | 26.8750 |
| 73G | 26.8850 |
| 74G | 26.8950 |
| 75G | 26.9050 |
| 76G | 26.9150 |
| 77G | 26.9250 |
| 78G | 26.9350 |
| 79G | 26.9450 |
| 80G | 26.9550 |

ENGLAND

| CH No. | Frequency |
|--------|-----------|
| 1E | 27.60125 |
| 2E | 27.61125 |
| 3E | 27.62125 |
| 4E | 27.63125 |
| 5E | 27.64125 |
| 6E | 27.65125 |
| 7E | 27.66125 |
| 8E | 27.67125 |
| 9E | 27.68125 |
| 10E | 27.69125 |
| 11E | 27.70125 |
| 12E | 27.71125 |

| | |
|-----|----------|
| 13E | 27.72125 |
| 14E | 27.73125 |
| 15E | 27.74125 |
| 16E | 27.75125 |
| 17E | 27.76125 |
| 18E | 27.77125 |
| 19E | 27.78125 |
| 20E | 27.79125 |
| 21E | 27.80125 |
| 22E | 27.81125 |
| 23E | 27.82125 |
| 24E | 27.83125 |
| 25E | 27.84125 |
| 26E | 27.85125 |
| 27E | 27.86125 |
| 28E | 27.87125 |
| 29E | 27.88125 |
| 30E | 27.89125 |
| 31E | 27.90125 |
| 32E | 27.91125 |
| 33E | 27.92125 |
| 34E | 27.93125 |
| 35E | 27.94125 |
| 36E | 27.95125 |
| 37E | 27.96125 |
| 38E | 27.97125 |
| 39E | 27.98125 |
| 40E | 27.99125 |

POLAND

| CH No. | Frequency |
|--------|-----------|
| 1P | 26.9600 |
| 2P | 26.9700 |
| 3P | 26.9800 |
| 4P | 27.0000 |
| 5P | 27.0100 |

| | |
|-----|---------|
| 6P | 27.0200 |
| 7P | 27.0300 |
| 8P | 27.0500 |
| 9P | 27.0600 |
| 10P | 27.0700 |
| 11P | 27.0800 |
| 12P | 27.1000 |
| 13P | 27.1100 |
| 14P | 27.1200 |
| 15P | 27.1300 |
| 16P | 27.1500 |
| 17P | 27.1600 |

| | |
|-----|---------|
| 18P | 27.1700 |
| 19P | 27.1800 |
| 20P | 27.2000 |
| 21P | 27.2100 |
| 22P | 27.2200 |
| 23P | 27.2500 |
| 24P | 27.2300 |
| 25P | 27.2400 |
| 26P | 27.2600 |
| 27P | 27.2700 |
| 28P | 27.2800 |
| 29P | 27.2900 |

| | |
|-----|---------|
| 30P | 27.3000 |
| 31P | 27.3100 |
| 32P | 27.3200 |
| 33P | 27.3300 |
| 34P | 27.3400 |
| 35P | 27.3500 |
| 36P | 27.3600 |
| 37P | 27.3700 |
| 38P | 27.3800 |
| 39P | 27.3900 |
| 40P | 27.4000 |

PMR

8 frequencies. The unit of frequencies is MHz.

The "CH No" shows PMR channel numbers.

| CH No. | Frequency |
|--------|-----------|
| 1 | 446.00625 |
| 2 | 446.01875 |
| 3 | 446.03125 |
| 4 | 446.04375 |
| 5 | 446.05625 |
| 6 | 446.06875 |
| 7 | 446.08125 |
| 8 | 446.09375 |

Appendix

LPD

69 frequencies. The unit of frequencies is MHz.

The "CH No." shows LPD channel numbers.

| CH No. | Frequency | | | | |
|--------|-----------|----|---------|----|---------|
| 1 | 433.075 | 31 | 433.825 | 62 | 434.600 |
| 2 | 433.100 | 32 | 433.850 | 63 | 434.625 |
| 3 | 433.125 | 33 | 433.875 | 64 | 434.650 |
| 4 | 433.150 | 34 | 433.900 | 65 | 434.675 |
| 5 | 433.175 | 35 | 433.925 | 66 | 434.700 |
| 6 | 433.200 | 36 | 433.950 | 67 | 434.725 |
| 7 | 433.225 | 37 | 433.975 | 68 | 434.750 |
| 8 | 433.250 | 38 | 434.000 | 69 | 434.775 |
| 9 | 433.275 | 39 | 434.025 | | |
| 10 | 433.300 | 40 | 434.050 | | |
| 11 | 433.325 | 41 | 434.075 | | |
| 12 | 433.350 | 42 | 434.100 | | |
| 13 | 433.375 | 43 | 434.125 | | |
| 14 | 433.400 | 44 | 434.150 | | |
| 15 | 433.425 | 45 | 434.175 | | |
| 16 | 433.450 | 46 | 434.200 | | |
| 17 | 433.475 | 47 | 434.225 | | |
| 18 | 433.500 | 48 | 434.250 | | |
| 19 | 433.525 | 49 | 434.275 | | |
| 20 | 433.550 | 50 | 434.300 | | |
| 21 | 433.575 | 51 | 434.325 | | |
| 22 | 433.600 | 52 | 434.350 | | |
| 23 | 433.625 | 53 | 434.375 | | |
| 24 | 433.650 | 54 | 434.400 | | |
| 25 | 433.675 | 55 | 434.425 | | |
| 26 | 433.700 | 56 | 434.450 | | |
| 27 | 433.725 | 57 | 434.475 | | |
| 28 | 433.750 | 58 | 434.500 | | |
| 29 | 433.775 | 59 | 434.525 | | |
| 30 | 433.800 | 60 | 434.550 | | |
| | | 61 | 434.575 | | |

Index

A

Alert 68
 Channel 14
 Custom 14
 Dangerous Xing-Road 112
 Duplicate Frequency 14
 Emergency 68
 GPS 15
 Setting Channel 83
Antenna 29, 31, 35
Attenuation 42, 74, 82, 101
Attenuator 14, 91
Auto Store 16, 92, 95, 100

B

Backlight 15, 51
backlight 33
Band Plan 75
Beep 24
 Alert 69, 112
 Close Call 95
 Key 52
Birdies 14, 115
Broadcast Screen 99

C

Channel
 Add CTCSS/DCS 81
 Alert 14
 All 31
 Attenuation 82
 Control 15, 23, 24
 Control Mode 76
 Copying 84
 Creating 79
 CTCSS/DCS 16
 Delay 66
 Delete 79
 Deleting 85

 Display Mode 49
 Editing 70
 Found, Saving 92
 Group 16, 19
 Group Name 42
 Holding 47
 Lock/Unlock 46, 78
 Lockout 13
 Logical Number 24
 Logical Numbers 24
 Marked 31
 Memory 13
 Modulation 82
 Priority 83
 Programming 77
 Single Autonomous 25
 Step 14
 System 45
 Tone-Out 107
Close Call
 DND 95
 Feature 13
 Hits 96
 Hits with Scan 97
 Options 98
 Setting 94
 Using 94
Contrast 52
Conventional
 Auto Store 16
 Feature 15
 Programming 62
 Scanning 21
 Search and Store 92
 Startup Options 43
Copy
 Channels 85
 Systems 71
CTCSS

Display Indicator 42
Frequencies 124
Quick Save 81
Selecting 81
What is 20

D

Dangerous

Deleting Location 112
Option Setting 111
Review Mode 113
Road 109
Screens 114
Xing 109

**Dangerous Xing, Road
Settings 112**

Data

Alpha 92
Channel 49
Download 55
GPS 54
LCN 24
Programming 16
SCAT 25
Setting Skip 101
Skip 14, 66
Talk Group 24
Transfer 56

Dimmer 15, 33, 51
DIN-E 13, 29, 32, 34

E

Edit

Channel Data 40
Menu 41
System Name 63
Tone Out 40

Editing

Band Plan 75
Channel Groups 70
Channel Name 79
Channels 78

Custom Search Range 88
Frequencies 80
Service Search 90
Sites 70
System Quick Key 64
Talk Group ID 80

End Code 68

F

Fleet 24, 25, 67, 120, 122

G

GPS

Compatible 108
Connecting 108
Distance Units 54
Features 15
Initial Operation 108
Location Based Scanning 109
Location Information 67
Non-Location Based 109
Position Format 53
Saving Longitude/Latitude 92
Setting Format 53
Time Format 53
Time Zone 53
Using the Scanner 108

I

I-Call

Feature 26
Operations 68

ID Scan 46, 66

Indicators 45, 48

indicators 42

ISO 13, 29, 34, 35

L

Lockout

Channel Groups 78
Custom Search Range 90
Search Limits 17

Setting 84
Sites 74, 109
Systems 65

LTR

Display 78
ID 25
LCN 73
Scan Time 75
Site Limit 71
Trunking 25

M

Menu 17

Entering Text 18
To Use 18
Using 50

Motorola

Band Plan 75
Control Channel 76
Edit System Names 63
Emergency Alert Options 68
End Code 68
Fleet Maps 67
I-Call 26
Status Bit 67
Trunking 23
Types 24

Multi-Site 15, 26

P

POI

Display 114
Distance 54
Location, Range 109
Lock, Unlock 114
Only For 112
Setting 111

Port 54

port 56

preprogrammed 15, 86

Preset

Edit Maps 67

Fleet Maps 120
Search Ranges 88

R

Range

All 112
Display 114
Edit 88
GPS 15
Search 20, 43, 87, 91
Set 67

S

Scan

Close Call Hits 97
Control Channel Only 15
Conventional 21
Function 18
ID 46
Priority 16, 103
Search Delay 14
Search With 14, 90
Selecting Systems 45
Systems 44
Trunked 23
Understanding 19
What is 20

SCAT 15, 24, 25, 71, 75, 78, 93

Search

Assigning a Range to Search Key
91
Auto and Store 92
Close Call Options 98
Conventional 92
Custom 87
Edit a Service 90
Edit Custom Range 88
Feature 13, 15
Frequency Step 102
ID 46
Lockout Limits 17
Quick 87

Index

Range 43
Reviewing ID Lockouts 70
Scan Delay 14
Service 86
Store ID 47
Trunked and Store 93
What Is 20
Squelch 13, 20, 43, 56
Subfleet 24, 25
subfleet 24, 122

Declaration of Conformity

Uniden Corporation
2-12-7 Hatchobori
Chuo-Ku, Tokyo 104-8512
Japan

declare, under our sole responsibility, that this equipment "Uniden Bearcat model UBC800XLT" is in compliance with the essential requirements and other relevant provisions of the EMC, R&TTE and LVD Council Directives of the EU.

Declaration of Conformity

143

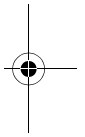
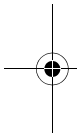
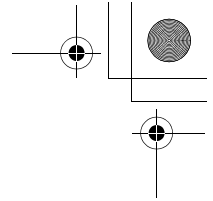
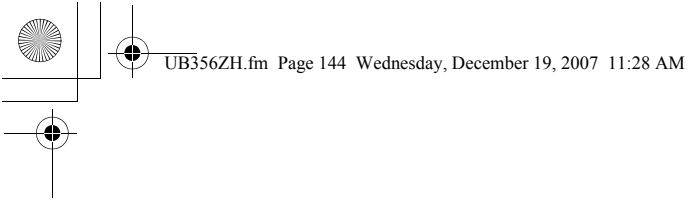

Uniden®

© 2008 Uniden Corporation.
UBZZ01356ZZ(0)

All rights reserved.
Printed in P.R.C. 