

ICF-SW35

SERVICE MANUAL

Ver 1.0 2000.03



*US Model
Canadian Model
AEP Model
E Model*

SPECIFICATIONS

Circuit system

FM: Super heterodyne
LW/MW/SW: Dual conversion super heterodyne

Frequency range

FM: 76.00 - 108.00 MHz
87.50 - 108.00 MHz*1
SW: 2250 - 26100 kHz*2
3850 - 26100 kHz*3
MW: 530 - 1710 kHz
530 - 1620 kHz
LW: 150 - 285 kHz

Speaker

Approx. 66 mm (2 1/8 in.) diameter, 8 Ohms

Maximum output

240 mW (at 10 % harmonic distortion)

Output

⌀ (headphones) jack (ø3.5 mm stereo mini jack)
16 Ohms

Power requirements

DC 4.5 V, three R6 (size AA) batteries

External power source

DC IN 4.5 V

Battery Life (approximate hours)

	Sony R6 (size AA)	Sony LR6 alkaline (size AA)
FM reception	17	46
SW reception	12	33
LW/MW reception	12	33

Dimensions

Approx. 168 × 106 × 35 mm (W × H × D)
(6 5/8 × 4 1/4 × 1 7/16 in.) incl. projecting parts

Mass

Approx. 405 g (14.3 oz) incl. batteries

Supplied Accessories

Carrying case (1)
Short wave guide (1)

Design and specifications are subject to change without notice.

The AC power adaptor's operating voltage varies depending upon the country in which it is sold.

Buy the AC power adaptor in the country you intend to use it.

Your Sony dealer may not handle all of the above listed optional accessories. Please ask your dealer for detailed information on the optional accessories available in your country.

*1 Italy, Saudi Arabia and Malaysia

*2 Countries except for Italy

*3 Italy only

FM STEREO/SW/MW/LW
PLL SYNTHESIZED RECEIVER

SONY®

Notes on Chip Component Replacement

- Never reuse a disconnected chip component.
- Notice that the minus side of a tantalum capacitor may be damaged by heat.

TABLE OF CONTENTS

1. GENERAL	
Operating the Radio	3
Setting the Standby Time	5
Setting the Sleep Timer	5
Using Other Functions	5
2. DISASSEMBLY	
2-1. Cabinet (Rear)	6
2-2. Main Board	6
2-3. Micon Board	7
3. ELECTRICAL ADJUSTMENTS	
FM Section	8
SW/MW/LW Section	8
FM VCO Adjustment	9
4. DIAGRAMS	
4-1. IC Pin Description	10
4-2. Block Diagram	11
4-3. Printed Wiring Board – Main Section –	13
4-4. Schematic Diagram – Main Section –	15
4-5. Printed Wiring Board – Micon Section –	17
4-6. Schematic Diagram – Micon Section –	19
5. EXPLODED VIEW	
5-1. Cabinet Section	22
6. ELECTRICAL PARTS LIST	23

SECTION 1 GENERAL

This section is extracted from instruction manual.

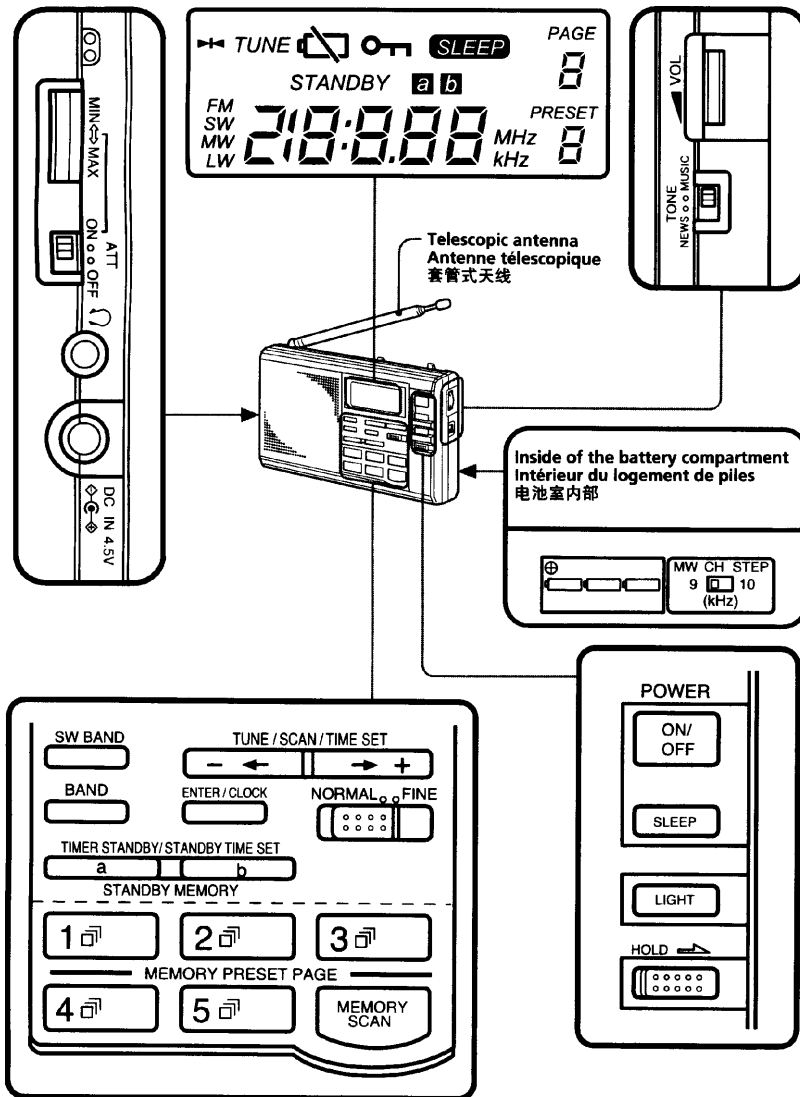

English

Operating the Radio

Before operating the radio, make sure of your location. In some countries, the MW channel step must be changed. (For details, see "Changing the MW channel step".)

Manual Tuning

- 1 Press ON/OFF to turn on the radio.
- 2 Press BAND to select the band. Each press changes the display as follows:

→LW→MW→SW→FM→

A double-beep sounds when you select LW. (The last frequency selected in each band appears on the display.)

- 3 When you select SW: press ← or → under TUNE/SCAN/TIME SET while pressing SW BAND to select a meter band. See "Scan Tuning" for details on the meter band.

When you select LW, MW and FM, follow the step 4.

- 4 Tune into the desired station by pressing ← or →.

A double-beep sounds when the minimum frequency of each band is received during tuning. When a broadcast is received, "TUNE" is displayed on the display.

- 5 Turn the VOL (volume) to adjust the volume.

About frequency step

The frequency step used by pressing ← or → under TUNE/SCAN/TIME SET can be changed with the NORMAL/FINE.

Band	NORMAL	FINE
LW	9 kHz	1 kHz
MW	9 kHz/10 kHz*	1 kHz
SW	5 kHz	1 kHz
FM	0.05 MHz	0.05 MHz

* See "Changing the MW channel step" for details on the MW channel step.

- Scan tuning is started by keeping ← or → + hold down while NORMAL is selected. (See "Scan tuning".)
- The frequency changes continuously by keeping ← or → + hold down while FINE is selected. If you stop pressing ← or → +, the frequency stops changing.

To turn off the radio

Press ON/OFF.

To enjoy FM stereo reception

Plug the stereo headphones (not supplied) into the (headphones) jack.

When listening to news

Set the TONE selector to NEWS for optimum results. Vocal output will be sharper and clearer. When listening to music, set the TONE selector to MUSIC for optimum results.

Changing the MW channel step

This radio's frequency channel step in the MW band is set to 9 kHz/10 kHz before the radio is shipped from the factory. The default setting varies depending on the country where the radio is sold. Change the MW channel step when listening in countries in these regions.

Area	channel step
North/South America	10 kHz
Other countries	9 kHz

- 1 Press ON/OFF to turn off the radio.
- 2 Remove the batteries from the unit.
- 3 Change the position of the MW CH STEP in the battery compartment to the desired channel step.
- 4 Install the batteries and press ON/OFF.

Notes

- Completely perform steps 2 to 4 within 60 seconds. If you do not perform the operations in 60 seconds, the clock setting will be erased.
- Reception of around 10250 kHz and 20500 kHz may be difficult because of spurious internal signals generated by the built-in oscillators.

B

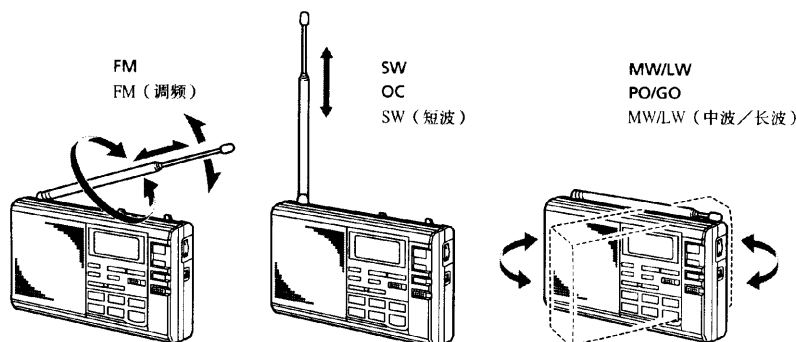

Scan Tuning

Use scan tuning to automatically scan the stations in the frequency range of a broadcast band.

- 1 Press ON/OFF to turn on the radio.
- 2 Press BAND to select the band.
If you select SW, select the meter band too.
- 3 Set NORMAL/FINE to NORMAL.
- 4 Press and hold ← or → + under TUNE/SCAN/TIME SET. Release the button when the frequency indication starts changing.
Scan tuning will begin within the frequency range table in the "Frequency range", and pause automatically for about three seconds when a station is received.
- 5 When the radio tunes into the desired station, press ← or → + again to stop scanning.

Until you press ← or → +, scan tuning will continue. If necessary, tune the station more precisely by pressing either ← or → +.

- The unit scans the frequencies in descending order when you hold down ← for two seconds or more, and in ascending order when you hold down → + for two seconds or more.
- To change the scanning direction, hold down either ← or → + opposite to the current direction for two seconds or more. This is convenient when, for example, you want to return to the previous reception after the unit has resumed scanning.
- When scanning MW broadcasts at night when reception is intense, or when scanning under prevailing interference, the scanning will pause frequently. If it occurs, switch the ATT switch to ON and adjust sensitivity with the ATT control (see "Controlling scan pauses", below). Under normal conditions, set the ATT switch to OFF.

Controlling scan pauses—using the ATT switch and the ATT control

Use the ATT (attenuator) switch and the ATT control to control reception sensitivity when the scanning pauses frequently or scanning under prevailing interference. Under normal conditions, set the ATT switch to OFF (i.e., with maximum sensitivity). The ATT control is activated when the ATT switch is switched to ON. Turn the ATT control toward MAX to reduce sensitivity. The radio will skip weak signals and stop at only strong ones.

Note

If the ATT control is turned too far toward MAX, the radio will not stop at any weak signals at all. Set the ATT switch to OFF if you do not need to use the attenuator.

English

Frequency range (LW, MW, SW: kHz, FM: MHz)

Band	Frequency range*1	Scan tuning range	Meter band	
LW	150-285	153-279		
MW	530-1710*2	531-1710*4		
		530-1710*5		
		531-1620*4		
SW	2250-26100*7	530-1620*4		
		2250-2550*6		120 m
		3150-3450*6		90 m
		3850-4050		75 m
		4700-5100		60 m
		5900-6250		49 m
		7100-7400		41 m
		9400-10000		31 m
		11500-12150		25 m
		13500-13900		22 m
		15000-15900		19 m
		17450-18000		16 m
		18850-19100		15 m
		21450-21950		13 m
		25600-26100		11 m
FM	76.00-108.00*2	76.00-108.00		
	87.50-108.00*3	87.50-108.00		

*1 The LW and MW frequency ranges are the same as the scan tuning range when NORMAL/FINE is set to NORMAL.

*2 Countries except for Italy, Saudi Arabia and Malaysia

*3 Italy, Saudi Arabia and Malaysia

*4 9 kHz channel step

*5 10 kHz channel step

*6 Countries except for Italy

*7 Italy only

Preset Tuning

You can preset up to 10 stations on each MEMORY PRESET PAGE (50 stations in total.) Once you preset a station to memory, you can receive the broadcast merely by pressing MEMORY PRESET PAGE. The page number is displayed as 1-5, the preset number is displayed as 1-0. (0 indicates 10.)

To preset stations

- 1 Tune into the station you want to preset.
Refer to "Manual Tuning" or "Scan Tuning" for more details.
- 2 Press and hold ENTER/CLOCK down until you hear a beep.
Page number 1 and preset number 1 flash when you are presetting a station for the first time or when you have preset 50 stations. In other cases, the number flashes as follows:
Page number: the smallest page number among the pages that have a free preset number
Preset number: the smallest preset number that has not been preset in the page displayed above



- 3 Press the desired page number of MEMORY PRESET PAGE.
For example, press page number 3. The display changes as illustrated below.



- 4 Press the number under the MEMORY PRESET PAGE you have selected repeatedly to display the desired preset number.
The preset number changes as follows:
→ 1 → 2 → 3 → 4 → 5 → 6 → 7 → 8 → 9 → 0

A double-beep sounds when the display returns to "1".
For example, select preset number 7. The display changes as illustrated below.

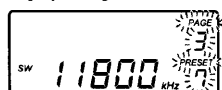

- 5 Press ENTER/CLOCK until a double-beep sounds.
The page number and the preset number stop flashing.



Note

If you leave the radio for 30 seconds with no operation while the page number and preset number are flashing, the unit returns to the previous mode.

To change the preset station

Follow the same procedure to store a new station to the selected preset number. The previous preset station is overwritten by the new preset station.

To interrupt and cancel presetting

Press ON/OFF to turn off the radio, and then press it again to turn the unit on. The unit returns to the previous mode.

Tuning into a preset station

- 1 Press ON/OFF to turn on the radio.
- 2 Press MEMORY PRESET PAGE repeatedly to display the desired preset number. Numbers that have not been preset cannot be displayed. A double-beep sounds if the smallest preset number is selected.
- 3 Turn VOL (volume) to adjust the volume.

Note

A double-beep sounds and the display changes as illustrated below for about three seconds when you select a page number that has no preset station, and then returns to the previous mode.

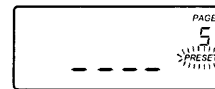

Deleting a preset station

Preset tuning works faster if you delete unnecessary preset stations as deleted preset stations are not selected during tuning.

- 1 Press ON/OFF to turn on the radio.
- 2 Press MEMORY PRESET PAGE repeatedly to display the preset number you want to delete.

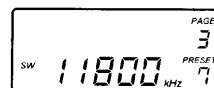

- 3 Press and hold ENTER/CLOCK down until "dEL" flashes.
"dEL" flashes on the display by keeping ENTER/CLOCK held down longer while the page number and preset number are flashing. While these numbers are flashing, the radio stands by for presetting the station.

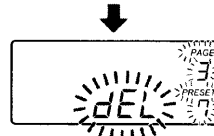
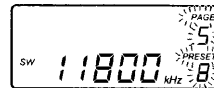

- 4 Press ENTER/CLOCK again until a double-beep sounds.
The page number and preset number disappear from the display.

Note

If you leave the radio for 30 seconds with no operation while the page number, preset number and "dEL" are flashing, the unit returns to the previous mode.

To interrupt and cancel deleting

Press ON/OFF to turn off the radio, and then press it again to turn the unit on. The unit returns to the previous mode.

Memory Scan Tuning

Use memory scan tuning to scan the preset stations automatically in one page.

- 1 Press ON/OFF to turn on the radio.
- 2 Press the page number of MEMORY PRESET PAGE you want to scan.
- 3 Press MEMORY SCAN.

Scanning stops when the radio receives a preset station in the page. If you want to select other preset stations, press MEMORY SCAN again. The preset numbers have not been preset will be skipped.

- Scanning works faster if you preset frequencies in descending or ascending order in preset number orders.

To interrupt and cancel memory scan tuning

Press MEMORY SCAN during memory scan tuning.

When preset stations cannot be received by memory scan tuning

A double-beep sounds and scanning stops when the first preset number you start scanning is returned to.

For example: you scan page 1 that has stations preset to preset numbers 2, 4, 6 and 8, and start scanning from preset number 6. A double-beep sounds when 6 is returned to.

- When scanning MW broadcasts at night when reception is intense, or scanning under prevailing interference, scanning will pause frequently. If it occurs, switch the ATT switch to ON and adjust sensitivity with the ATT control (see "Controlling scan pauses"). Under normal conditions, use the radio with the ATT switch set to OFF.

Improving Reception

(See fig. B)

Adjusting the antenna

FM : Extend the telescopic antenna and adjust the direction and angle for the best reception.

SW : Extend the telescopic antenna to its full length and set it vertically.

MW, LW : Rotate the unit horizontally for optimum reception. A ferrite bar antenna is built in the unit.

Using an external antenna

Use the wide-range antenna AN-1, AN-102 or the SW active antenna AN-LP1 (not supplied). For details, refer to the operating instructions of the each antenna.

Notes

- Keep the unit and antenna away from fluorescent lights, TVs, computers, and other equipment which may generate noise.
- Retract the telescopic antenna when using an external antenna.
- Set up the external antenna as far away from the street as possible.
- Note that the SW active antenna AN-LP1 may not function as usual when it is connected to this radio and memory scan tuning is in use. This is because AN-LP1 selects frequencies by the antenna controller.

Setting the Standby Time

Standby function

You can turn on the radio and tune into your favorite station at the desired time.

- Before you set standby, make sure that the radio's clock setting is correct.
- Two standby times can be stored to STANDBY MEMORY a and b.
- Before you set the standby time, adjust VOL (volume) to set the volume when the radio is turned on.

- 1 Receive the desired broadcast station.
- 2 Press ENTER/CLOCK until you hear a beep.
The page number and preset number start flashing.

- 3 Press STANDBY MEMORY a or b.
For example, when you press STANDBY MEMORY a, "PRESET" and "a" start flashing.



- 4 Press ENTER/CLOCK until you hear a double-beep.
"PRESET" and "a" or "b" light.
- 5 Press ON/OFF to turn off the radio.
- 6 Press STANDBY MEMORY a or b until you hear a beep.
For example, when you press STANDBY MEMORY a:
The display returns to the clock setting display, "STANDBY", "a" and the hour indication start flashing.



- 7 Press - ← or → + under TUNE/SCAN/TIME SET to set the hour.
- 8 Press STANDBY MEMORY a or b you selected in step 6 until you hear a beep.
The hour is set, and the minute starts flashing.
- 9 Press - ← or → + to set the minute.
- 10 Press STANDBY MEMORY a or b you selected in step 6 until you hear a double-beep.
The minute is set, and "STANDBY" and "a" or "b" light.

When the standby time is reached

The radio turns on and "SLEEP" is displayed. The unit will turn off automatically after about 60 minutes.

When you have set STANDBY MEMORY a and b

If the second preset standby time is reached while the first standby time is operating, the most recent standby time will have priority over the other and the radio will tune into the appropriate station. If you have set STANDBY MEMORY a and b to the same time, STANDBY MEMORY a will have priority.

To cancel the standby function

Press STANDBY MEMORY a or b with the radio turned off so that "STANDBY" and "a" or "b" are cleared from the display.

Be sure to release the button within one second. If the button is pressed continuously, the radio enters the standby setting mode.

To cancel temporarily the standby function

Slide HOLD in the direction of the arrow with the radio turned off to make "o" appear. When the hold is canceled and "o" disappears, the standby function is operational. (see "Using Other Functions")

Notes

- Once a standby time is set, the radio turns on at the preset standby time everyday unless the standby setting is canceled.
- The standby function activates even while you are listening to other stations.

Activating the Alarm

To activate the alarm instead of the radio at the desired time, delete the station assigned to either STANDBY MEMORY a or b as necessary.

- 1 Press ON/OFF to turn on the radio.
- 2 Press STANDBY MEMORY a or b.
The radio receives the preset station. If there is no preset station, a double-beep sounds and the display changes as illustrated below. In this case, perform the step 5.

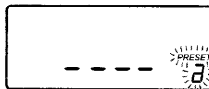

- 3 Press and hold ENTER/CLOCK down until "dEL" flashes.

- 4 Press ENTER/CLOCK again until a double-beep sounds.
The display "PRESET" and "a" or "b" will disappear. (See "Preset tuning-Deleting a preset station".)
- 5 Perform steps 5 to 10 of the procedure described in "Setting the Standby Time".
When the standby time is reached and the standby is activated, the alarm sounds. The unit then turns off automatically after 60 seconds.

To stop the alarm

Press any button except LIGHT.

Notes

- The alarm volume is not adjustable.
- When the standby time is reached while you are listening to the radio, the radio turns off and the alarm sounds.

Setting the Sleep Timer

Sleep Timer Function

Enjoy falling asleep to the radio using sleep timer. The radio turns off automatically after the sleep timer setting (60, 45, 30 or 15 minutes) is reached.

- 1 Press SLEEP.

The sleep timer setting of "60" minutes is displayed and "SLEEP" flashes. The radio turns on if it was turned off.



- 2 Press SLEEP repeatedly to select the desired sleep timer setting while "SLEEP" is flashing.

Each press changes the display as follows:

→60→45→30→15

A double-beep sounds when the display returns to "60". "SLEEP" lights three seconds after you select the sleep timer setting while "SLEEP" is flashing. After the sleep timer indication disappears and the frequency indication appears, the sleep timer activates.

- 3 Tune into the desired station, and adjust the VOL (volume).

The radio will turn off automatically after the sleep timer setting is reached.

To turn off the radio before the sleep timer setting is reached

Press ON/OFF.

To reset or extend the sleep timer setting

Press SLEEP again and select the desired sleep timer setting.

Using Other Functions

Hold Function

When the hold function is used, the buttons are not operational. Use the hold function to prevent accidental operation.

The hold function can also be used to temporarily cancel the standby function.

To use the hold function

Slide HOLD in the direction of the arrow. "o" appears on the display and all buttons are no longer operational.

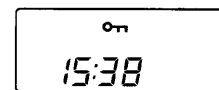

To cancel the hold function

Slide HOLD in the opposite direction of the arrow. "o" disappears from the display.

Light Function

Press LIGHT to turn on the light for about 20 to 30 seconds to view the display in the dark.

SECTION 2 DISASSEMBLY

Note : Follow the disassembly procedure in the numerical order given.

2-1. CABINET (REAR)

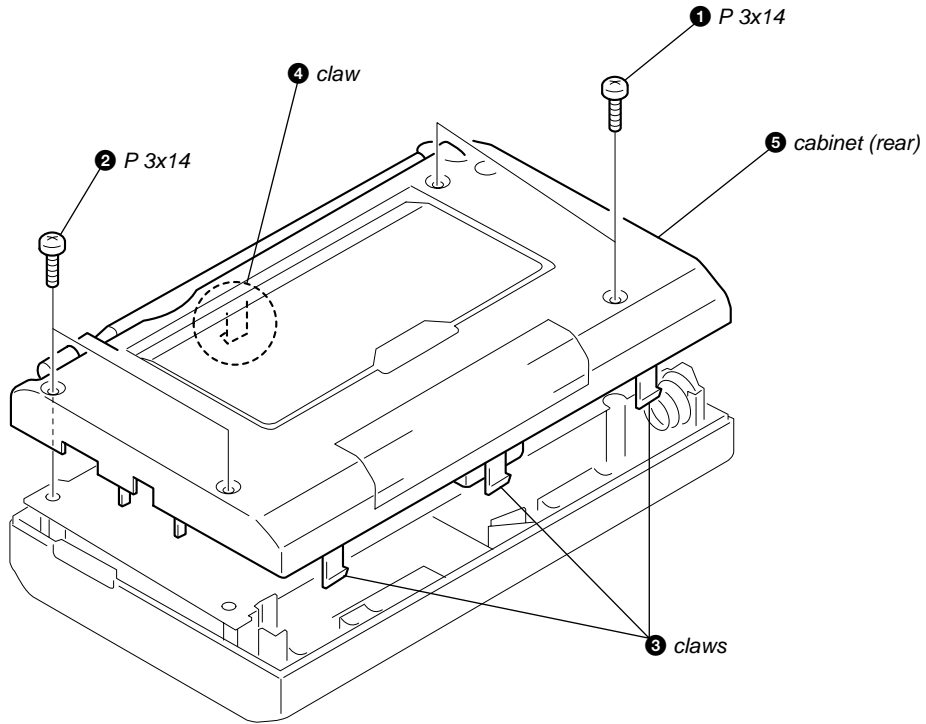

2-2. MAIN BOARD

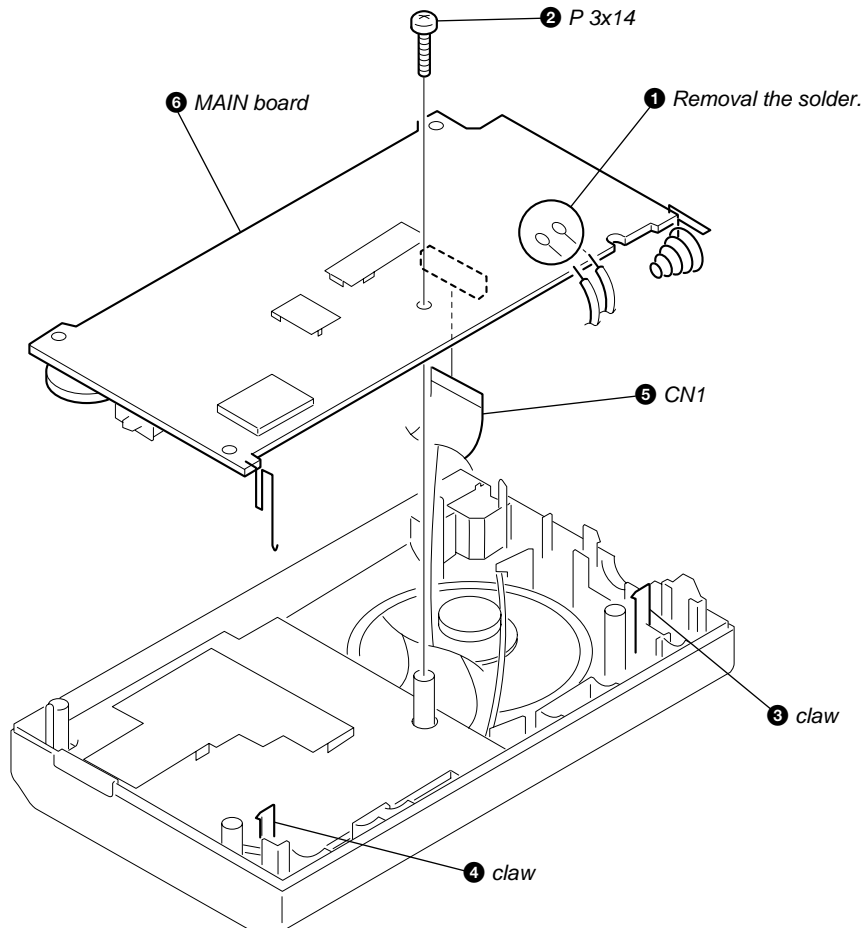

2-3. MICON BOARD

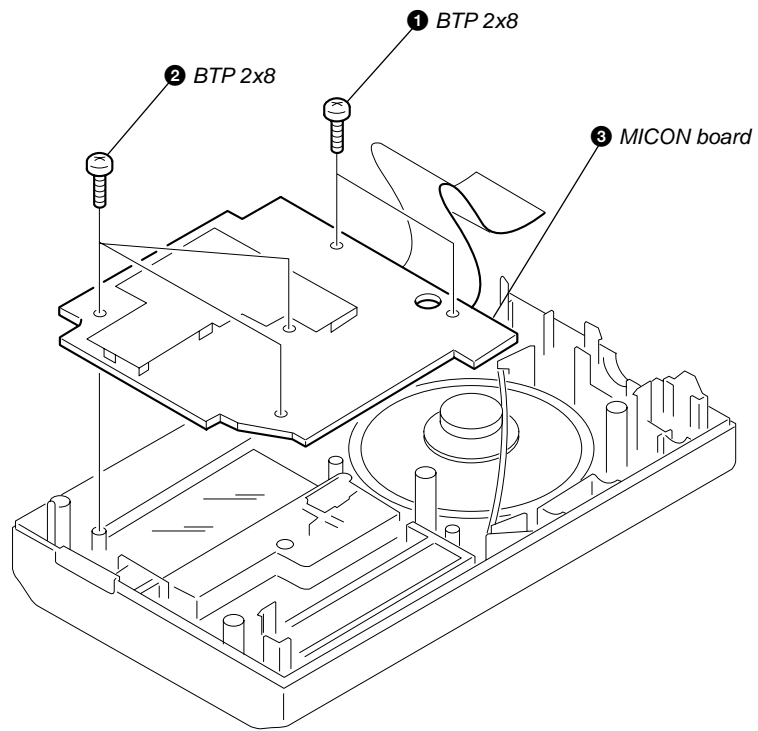

SECTION 3 ELECTRICAL ADJUSTMENTS

FM SECTION 0 dB = 1 μ V

Setting:

BAND switch: FM
VOLUME: MAX
ATT: OFF
TONE: MUSIC

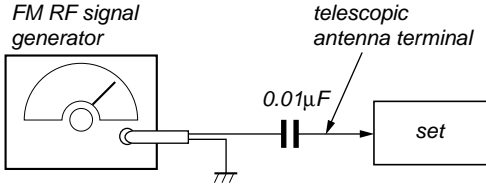

400Hz, 30% FM modulation
frequency deviation ± 22.5 kHz
Output level: as low as possible

SW/MW/LW SECTION

Setting:

BAND switch: SW or MW or LW
VOLUME: MAX
ATT: OFF
TONE: MUSIC

(SW)

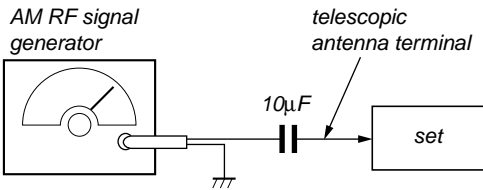

400Hz, 30%
AM modulation
Output level: as low as possible

(MW/LW)

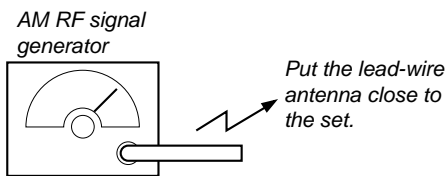

400Hz, 30%
AM modulation
Output level: as low as possible

• Connecting Digital Voltmeter (FM, SW, MW and LW)

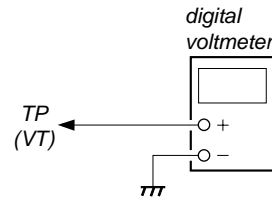

- Repeat the procedures in each adjustment several times, and the frequency coverage and tracking adjustments should be finally done by the trimmer capacitors.

AM IF ADJUSTMENT

Adjust for a maximum reading on level meter.

Frequency Display	11,800 kHz
Adjustment Part	T1, T4

LW FREQUENCY COVERAGE CHECK

Frequency Display	150 kHz
Reading on Digital voltmeter	1.0 - 1.3 V
Adjustment Part	<confirmation>

SW FREQUENCY COVERAGE CHECK

Frequency Display	26,100 kHz
Reading on Digital voltmeter	8.0 - 9.0 V
Adjustment Part	<confirmation>

FM FREQUENCY COVERAGE CHECK

Frequency Display	76 MHz	108 MHz
Reading on Digital voltmeter	2.8 - 4.0 V	9.5 - 11.0 V
Adjustment Part	<confirmation>	<confirmation>

FM TRACKING ADJUSTMENT

Adjust for a maximum reading on level meter.

Frequency Display	76 MHz	108 MHz
Adjustment Part	L11	CT1

Adjustment Location: See page 9.

• Connecting Level Meter (FM, SW, MW and LW)

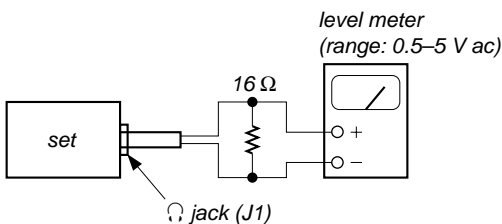

FM VCO ADJUSTMENT

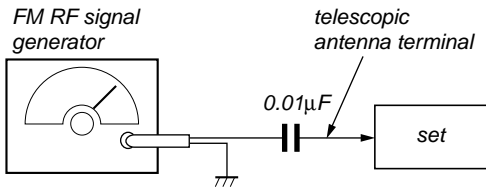

98MHz, non-modulation
Output level: 0.1v(100dB)

• Connecting Frequency counter

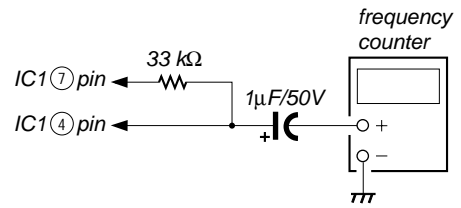

FM VCO ADJUSTMENT	
Reading on Frequency counter	76 kHz ± 200 Hz
Adjustment Part	RV2

Adjustment Location:

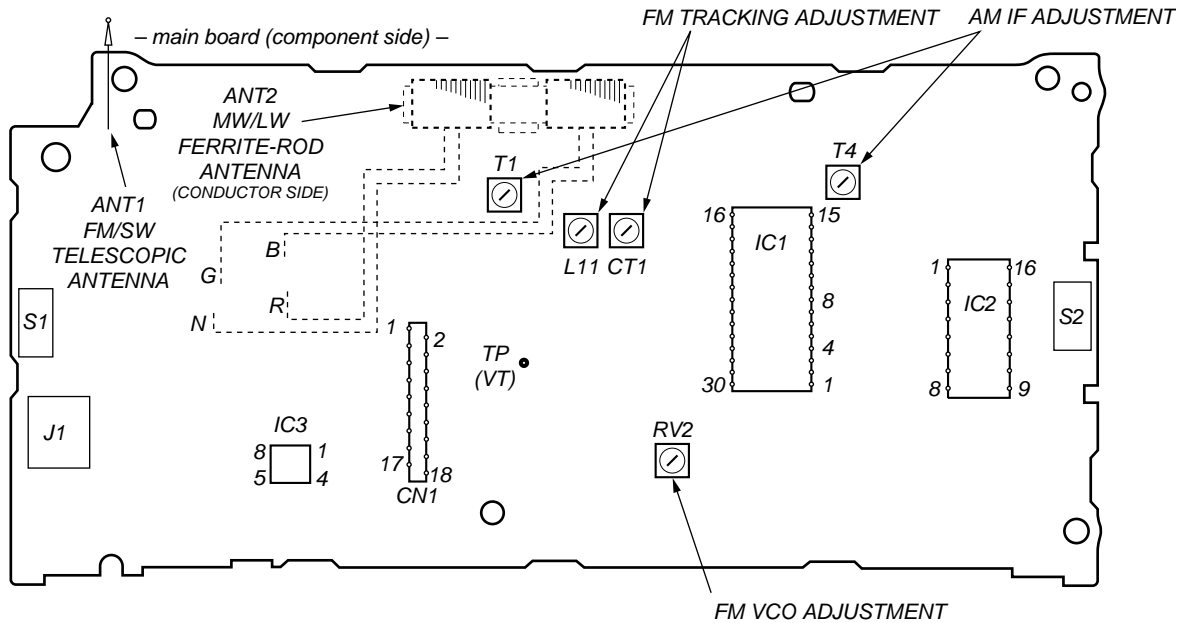

– main board (conductor side) –

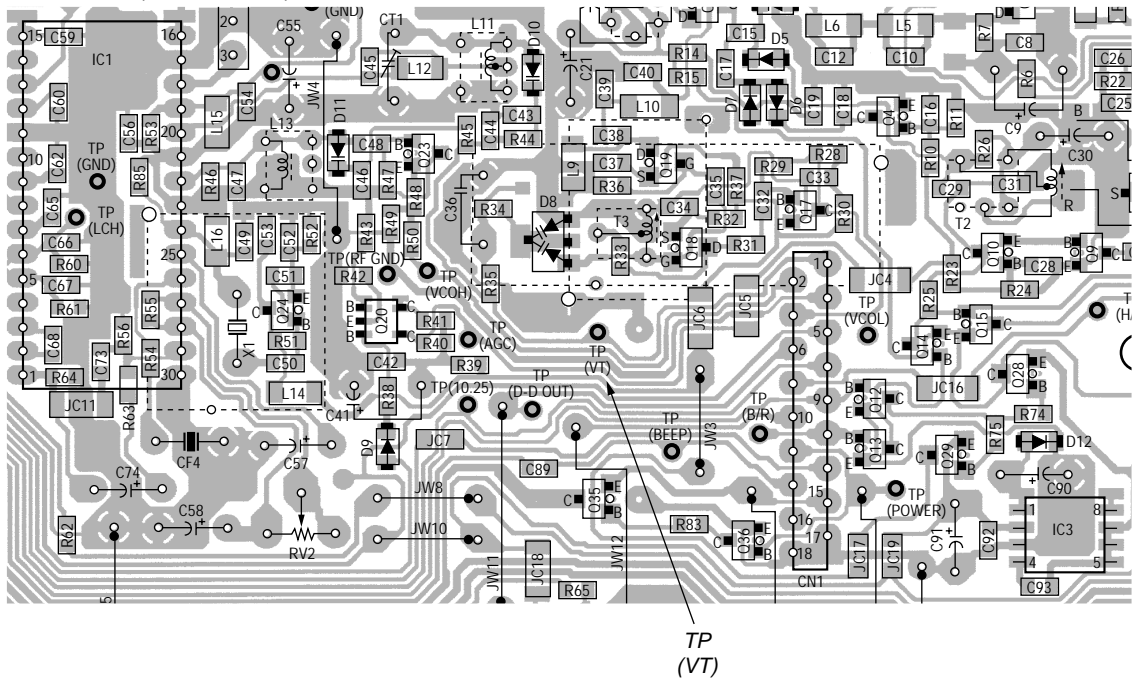

SECTION 4 DIAGRAMS

4-1. IC PIN DESCRIPTION

• IC201 uPD17072GB-017-1A7 (SYSTEM CONTROL, LCD DRIVER)

Pin No.	Pin Name	I/O	Pin Description
1	CS	O	EEPROM CS control output
2	POWER	O	Power supply (for signal) start output H: Radio ON L: Radio OFF
3	BAR/ROD	O	Antenna switch output H: BAR ANTENNA L: ROD ANTENNA
4	MUTE	O	MUTE output H: MUTE OFF L: MUTE ON
5	AM/FM	O	Band switch signal output H: SW, MW, LW L: FM
6 – 9	KS0 – 3	O	Key source output
10 – 13	KR0 – 3	I	Key return input
14	INITIAL	O	9K/10K read output
15	NORMAL/FINE	I	Frequency step switch input H: FINE L: NORMAL
16	H/L	O	SW filter switch signal output H: SW L: FM, MW, LW
17	10.25	O	Attenuator output
18	GND	—	GND
19	EO	O	Tuner PLL error output
20	VCOL (LW/MW/SW)	I	VCO (SW/MW/LW band) input
21	VCOH (FM)	I	VCO (FM band) input
22	REG0	—	Capacitor terminal (regulator circuit)
23	VDD	—	Power supply terminal (+2.7 V)
24	XOUT	O	Oscillation output (75 kHz)
25	XIN	I	Oscillation input (75 kHz)
26	REG1	—	Capacitor terminal (regulator circuit)
27	REGLCD0	—	LCD driving power supply terminal
28, 29	CAPLCD0, 1	—	LCD driving power supply terminal
30	REGLCD1	—	LCD driving power supply terminal
31 – 34	COM0 – 3	O	LCD drive common output
35 – 49	LCD0 – 14	O	LCD drive segment output
50, 51	VDET1, 2	I	Reducing voltage information input
52	BEEP	O	Beep output
53	TUNE	I	Receive information input
54	HOLD	I	Hold input
55	SCK	O	Serial clock output
56	DI/DO	I/O	Serial data input/output

4-2. BLOCK DIAGRAM

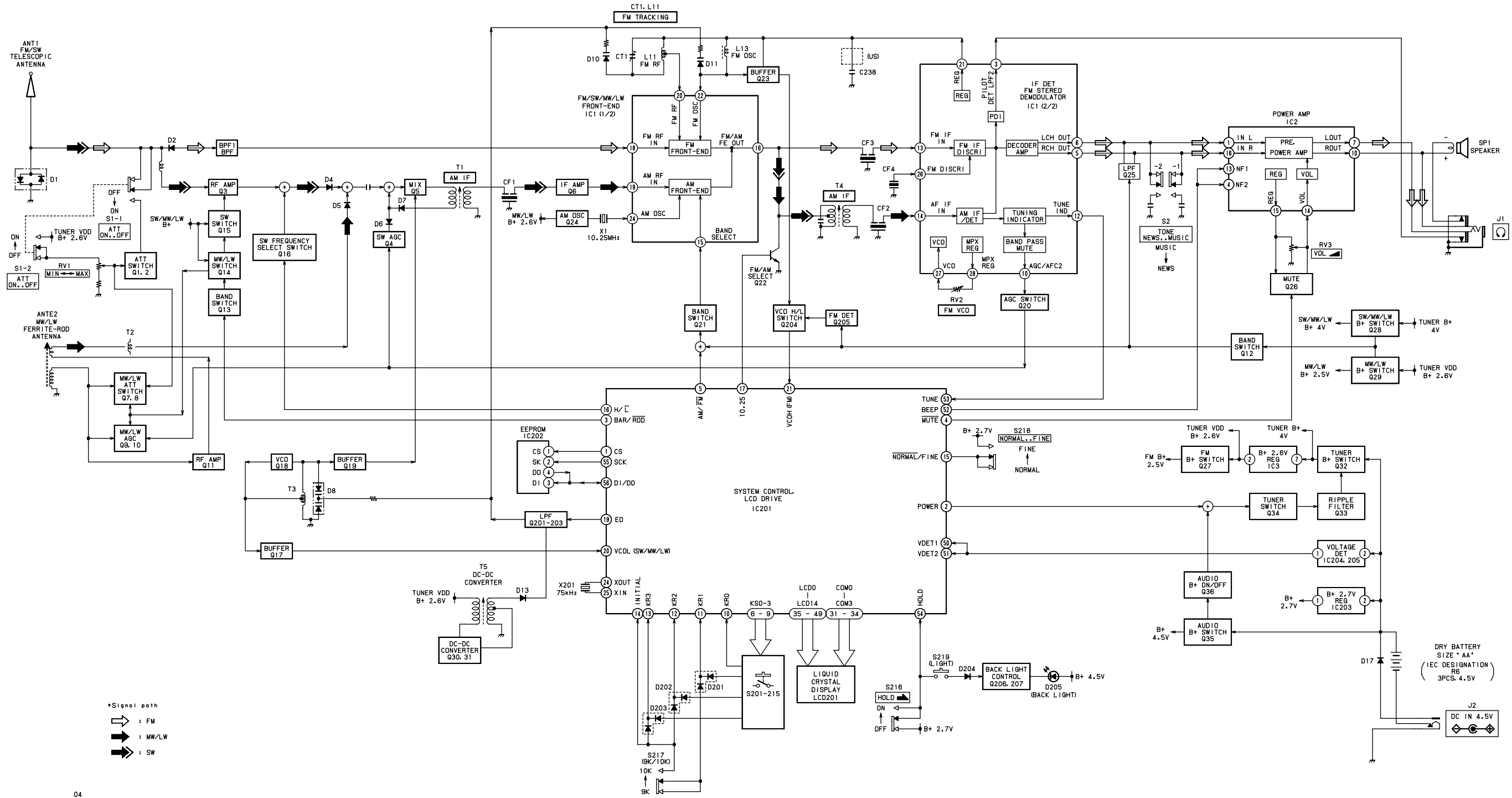

04

4-3. PRINTED WIRING BOARD — MAIN SECTION —

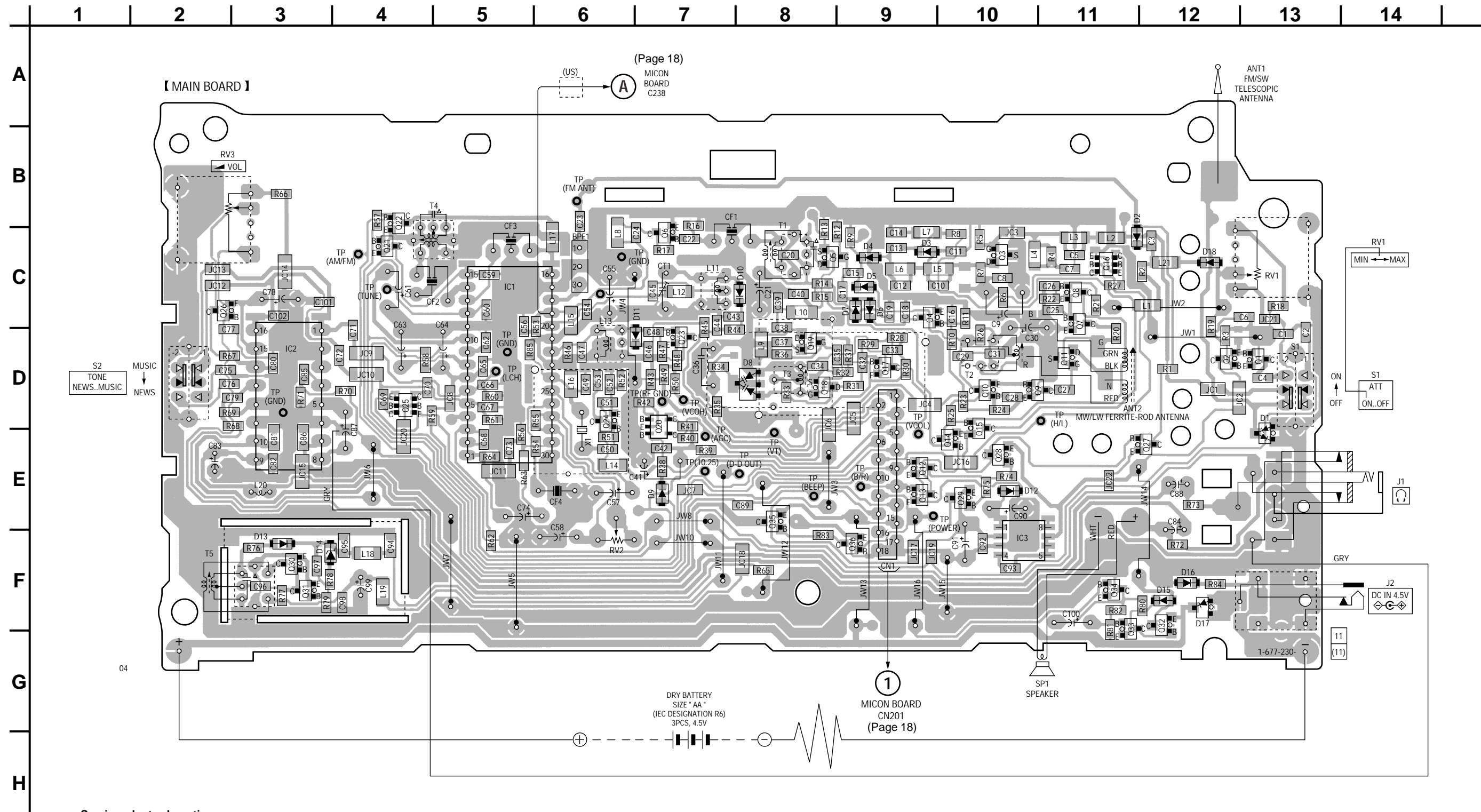

• Semiconductor Location

Ref. No.	Location	Ref. No.	Location	Ref. No.	Location	Ref. No.	Location	Ref. No.	Location
D1	D-13	D13	F-3	Q2	D-12	Q14	E-10	Q26	C-2
D2	B-12	D14	F-3	Q3	C-10	Q15	E-10	Q27	E-12
D3	C-9	D15	F-12	Q4	C-9	Q16	C-11	Q28	E-10
D4	C-9	D16	F-12	Q5	C-9	Q17	D-9	Q29	E-10
D5	C-9	D17	F-12	Q6	C-7	Q18	D-8	Q30	F-3
D6	C-9	D18	C-12	Q7	D-11	Q19	D-8	Q31	F-3
D7	C-9			Q8	C-11	Q20	D-7	Q32	F-12
D8	D-8	IC1	C-5	Q9	D-11	Q21	C-4	Q33	F-12
D9	E-7	IC2	D-3	Q10	D-10	Q22	B-4	Q34	F-11
D10	C-8	IC3	F-10	Q11	D-11	Q23	D-7	Q35	E-8
D11	C-7			Q12	E-9	Q24	D-6	Q36	F-9
D12	E-10	Q1	D-13	Q13	E-9	Q25	D-4		

Note on Printed Wiring Boards:

- : parts extracted from the component side.
- : parts extracted from the conductor side.
- △ : internal component.
- ▨ : Pattern from the side which enables seeing.

Note on Schematic Diagram:

- All capacitors are in μF unless otherwise noted. pF : μpF
- 50 WV or less are not indicated except for electrolytics and tantalums.
- All resistors are in Ω and $1/4$ W or less unless otherwise specified.

- △ : internal component.
- ▭ : panel designation.
- B+ : B+ Line.
- ▭ : adjustment for repair.

- Power voltage is dc 4.5 V and fed with regulated dc power supply from battery terminal.
- Voltage is dc with respect to ground under no-signal (detuned) condition.
- no mark : FM
- () : MW/LW
- < > : SW
- Signal path.
- ↔ : FM
- ↔ : MW/LW
- ↔ : SW

4-4. SCHEMATIC DIAGRAM — MAIN SECTION — • Refer to page 21 for IC Block Diagrams.

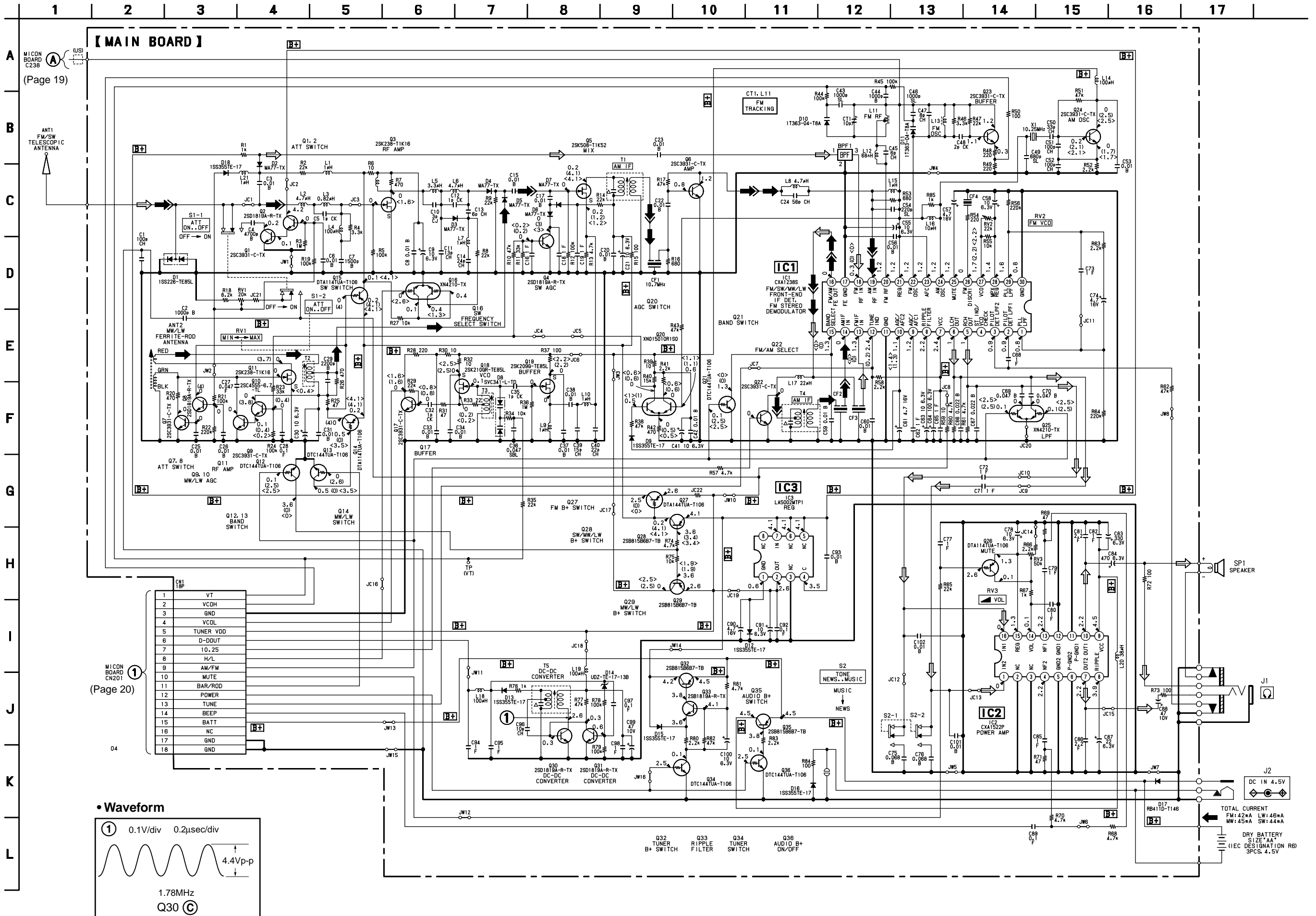

4-5. PRINTED WIRING BOARD — MICON SECTION —

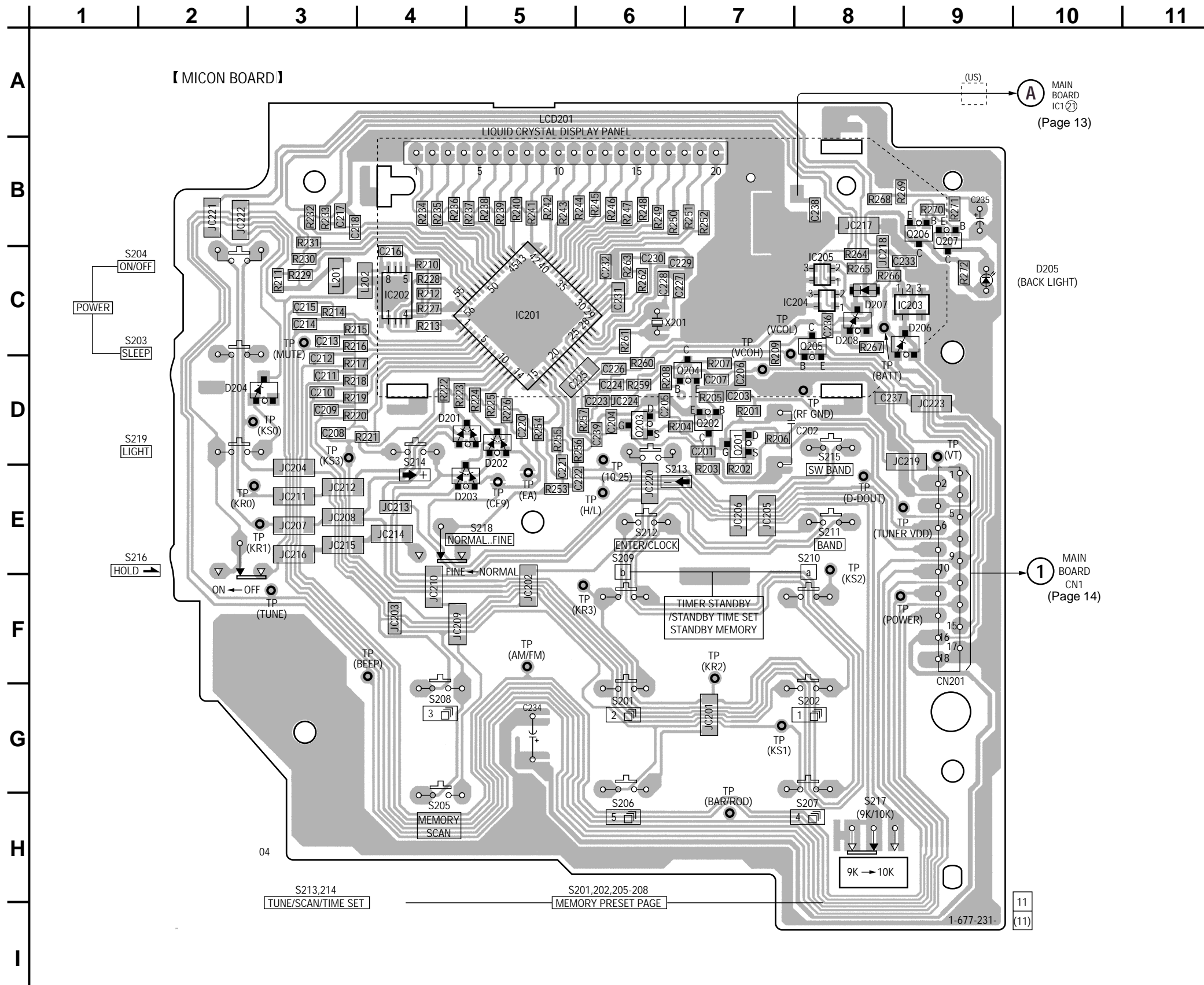

• Semiconductor Location

Ref. No.	Location
D201	D-4
D202	D-5
D203	D-5
D204	D-2
D205	C-10
D206	C-9
D207	C-8
D208	C-8
IC201	C-5
IC202	C-4
IC203	C-9
IC204	C-8
IC205	C-8
Q201	D-7
Q202	D-7
Q203	D-6
Q204	D-7
Q205	C-8
Q206	B-9
Q207	B-9

Note on Printed Wiring Boards:

- ○ : parts extracted from the component side.
- — : parts extracted from the conductor side.
- △ : internal component.
- [Pattern] : Pattern from the side which enables seeing.

4-6. SCHEMATIC DIAGRAM — MICON SECTION — • Refer to page 21 for IC Block Diagrams.

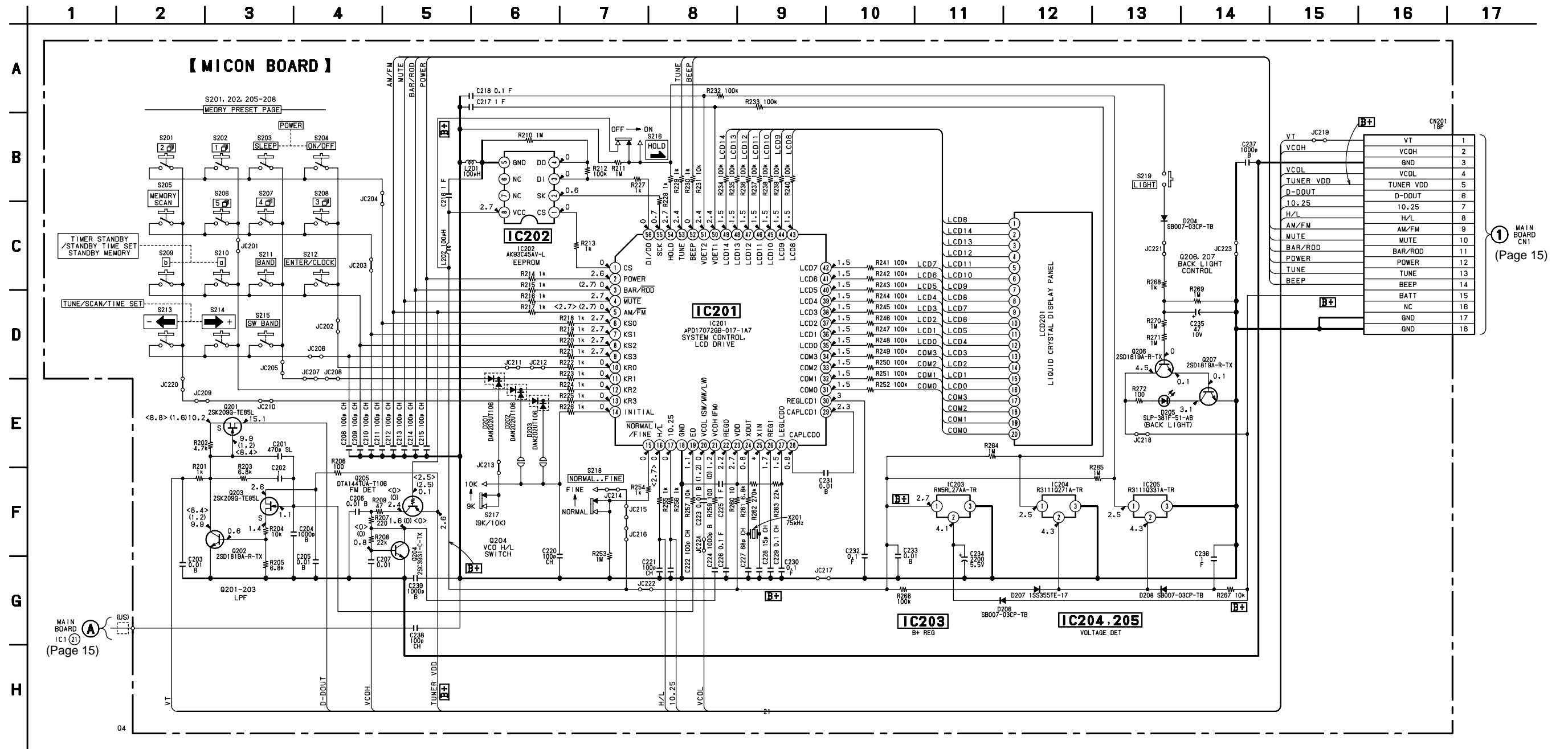

Note on Schematic Diagram:

- All capacitors are in μF unless otherwise noted. pF: μF
50 WV or less are not indicated except for electrolytics and tantalums.
- All resistors are in Ω and $1/4\text{ W}$ or less unless otherwise specified.
- Δ : internal component.
- : panel designation.
- B+ : B+ Line.
- : adjustment for repair.
- Power voltage is dc 4.5 V and fed with regulated dc power supply from battery terminal.
- Voltage is dc with respect to ground under no-signal (detuned) condition.
no mark : FM
() : MW/LW
< > : SW

SECTION 5 EXPLODED VIEW

• IC Block Diagrams

IC1 CXA1238S

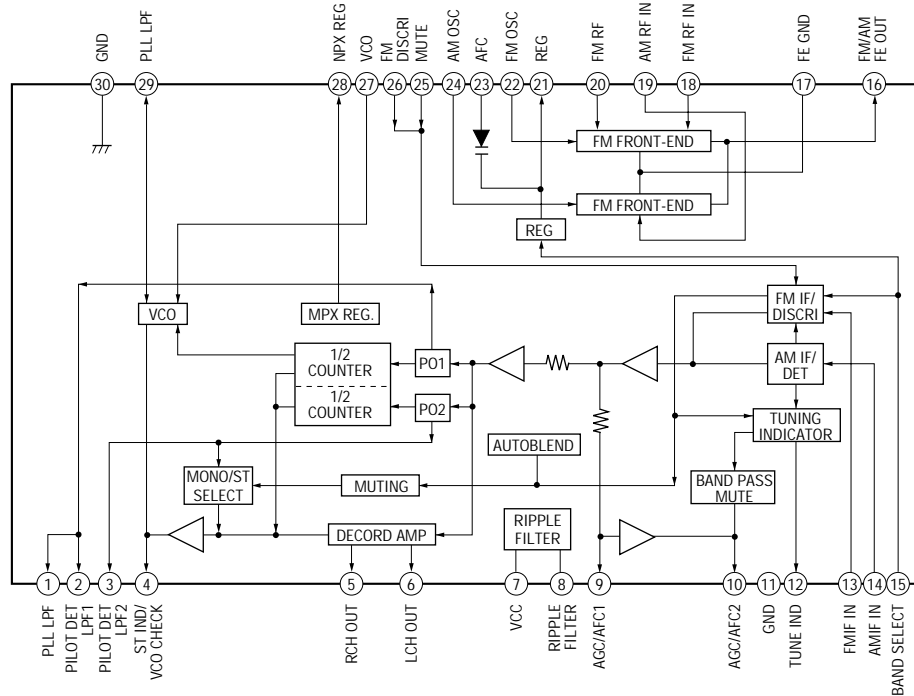

IC2 CXA1522P

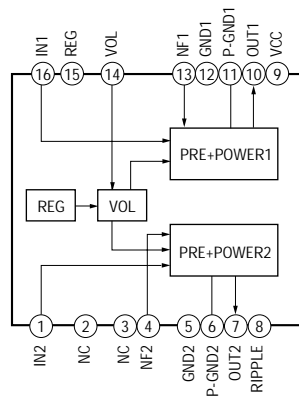

IC3 LA5002MTP1

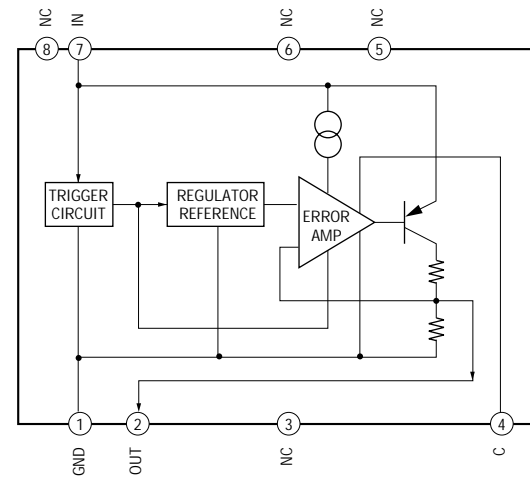

IC203 RN5RL27AA-TR

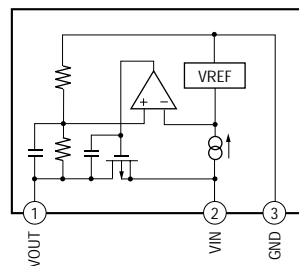

**IC204 R3111Q271A-TR
IC205 R3111Q331A-TR**

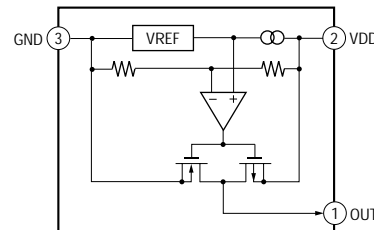

NOTE:

- The mechanical parts with no reference number in the exploded views are not supplied.
- Items marked "*" are not stocked since they are seldom required for routine service. Some delay should be anticipated when ordering these items.

• Color Indication of Appearance Parts

Example :
KNOB, BALANCE (WHITE) ... (RED)
Parts Color Cabinet's Color

- Accessories and packing materials are given in the last of this parts list.

5-1. CABINET SECTION

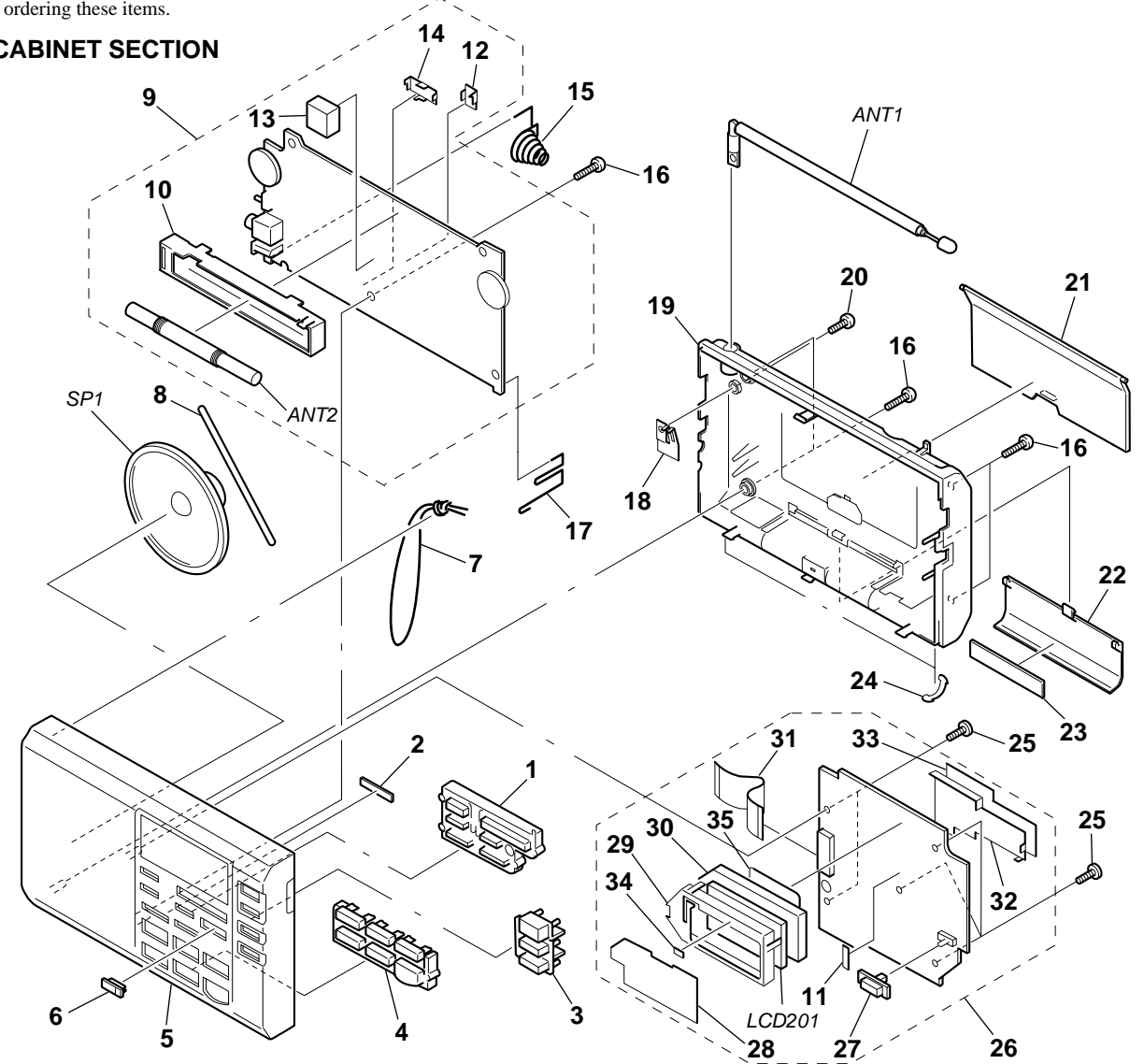

Ref. No.	Part No.	Description	Remark	Ref. No.	Part No.	Description	Remark
1	3-042-909-01	BUTTON (+/-)		21	3-893-839-21	STAND	
2	3-044-852-01	CUSHION (B)		22	3-042-903-01	LID, BATTERY CASE	
3	3-042-907-01	BUTTON (POWER)		23	3-312-059-11	CUSHION, BATTERY	
4	3-042-910-01	BUTTON (PAGE)		24	3-042-916-01	FOOT, RUBBER	
5	X-3378-376-1	CABINET (FRONT) ASSY		25	3-371-765-21	SCREW (2X8), +BTP	
6	3-042-911-01	KNOB (N/F)		*	26	A-3663-471-A	MICON BOARD, COMPLETE
7	3-385-660-11	STRAP, HAND		27	3-042-908-01	KNOB (HOLD)	
8	3-389-575-01	SPRING (SPEAKER), WIRE		28	3-042-913-01	SHEET (LCD)	
*	9	A-3683-159-A	MAIN BOARD, COMPLETE	*	29	3-042-894-01	CASE (LCD)
10	3-042-904-01	HOLDER (ANTENNA)		30	3-042-906-01	HOLDER (LCD)	
11	3-047-311-01	SPACER (T)		31	1-792-459-11	CABLE, FLAT (FFC) 18P	
*	12	3-042-898-01	CASE (2ND B)	*	32	3-042-895-01	CASE (MICROCOMPUTER)
*	13	3-042-896-01	CASE (1ST A)	33	3-045-127-01	LEAF (MICRO COMPUTER), COPPER	
*	14	3-042-897-01	CASE (1ST B)	34	3-044-853-01	SHEET (4 X 15)	
15	3-042-900-01	TERMINAL (-), BATTERY		35	3-045-971-01	LEAF (LCD), COPPER	
16	7-685-649-79	SCREW +P 3X14 TYPE2 NON-SLIT		ANT1	1-501-222-81	ANTENNA, TELESCOPIC (FM/SW)	
17	3-042-899-01	TERMINAL (+), BATTERY		ANT2	1-501-793-21	ANTENNA, FERRITE-ROD (MW/LW)	
18	3-383-877-01	PLATE (ANT), CONTACT		LCD201	1-803-943-11	DISPLAY PANEL, LIQUID CRYSTAL	
19	3-042-902-01	CABINET (REAR)		SP1	1-529-645-11	SPEAKER (6.6cm)	
20	7-682-546-09	SCREW +P 3X5					

SECTION 6 ELECTRICAL PARTS LIST

MAIN

NOTE:

- Due to standardization, replacements in the parts list may be different from the parts specified in the diagrams or the components used on the set.
- RESISTORS
All resistors are in ohms.
METAL: Metal-film resistor.
METAL OXIDE: Metal oxide-film resistor.
F: nonflammable

- Items marked “*” are not stocked since they are seldom required for routine service. Some delay should be anticipated when ordering these items.
- SEMICONDUCTORS
In each case, u : μ , for example:
uA.. : μ A.. uPA.. : μ PA..
uPB.. : μ PB.. uPC.. : μ PC.. uPD.. : μ PD..
- CAPACITORS
uF : μ F
- COILS
uH : μ H

When indicating parts by reference number, please include the board.

- Abbreviation
CND : Canadian model
EE : East European model
EA : Saudi Arabia model
SE : Country of origin is show in E model
IT : Italian model

Ref. No.	Part No.	Description	Remark	Ref. No.	Part No.	Description	Remark
*	A-3683-159-A	MAIN BOARD, COMPLETE *****		C31	1-162-970-11	CERAMIC CHIP 0.01uF 10%	25V
				C32	1-162-905-11	CERAMIC CHIP 1PF 0.25PF	50V
*	3-042-896-01	CASE (1ST A)		C33	1-162-970-11	CERAMIC CHIP 0.01uF 10%	25V
*	3-042-897-01	CASE (1ST B)		C34	1-162-970-11	CERAMIC CHIP 0.01uF 10%	25V
*	3-042-898-01	CASE (2ND B)		C35	1-162-905-11	CERAMIC CHIP 1PF 0.25PF	50V
	3-042-904-01	HOLDER (ANTENNA)					
		< ANTENNA >		C36	1-162-847-11	CERAMIC 0.047uF 10%	16V
ANT2	1-501-793-21	ANTENNA, FERRITE-ROD (MW/LW)		C37	1-162-970-11	CERAMIC CHIP 0.01uF 10%	25V
		< FILTER >		C38	1-162-970-11	CERAMIC CHIP 0.01uF 10%	25V
BPF1	1-234-024-11	FILTER, BAND PASS		C39	1-162-917-11	CERAMIC CHIP 15PF 5%	50V
		< CAPACITOR >		C40	1-162-919-11	CERAMIC CHIP 22PF 5%	50V
C1	1-162-927-11	CERAMIC CHIP 100PF 5%	50V	C41	1-126-157-11	ELECT 10uF 20%	16V
C2	1-162-964-11	CERAMIC CHIP 0.001uF 10%	50V	C42	1-162-970-11	CERAMIC CHIP 0.01uF 10%	25V
C3	1-162-970-11	CERAMIC CHIP 0.01uF 10%	25V	C43	1-164-357-11	CERAMIC CHIP 1000PF 5%	50V
C4	1-162-968-11	CERAMIC CHIP 0.0047uF 10%	50V	C44	1-162-964-11	CERAMIC CHIP 0.001uF 10%	50V
C5	1-162-905-11	CERAMIC CHIP 1PF 0.25PF	50V	C45	1-162-911-11	CERAMIC CHIP 6PF 0.5PF	50V
C6	1-162-970-11	CERAMIC CHIP 0.01uF 10%	25V	C46	1-164-357-11	CERAMIC CHIP 1000PF 5%	50V
C7	1-162-965-11	CERAMIC CHIP 0.0015uF 10%	50V	C47	1-162-913-11	CERAMIC CHIP 8PF 0.5PF	50V
C8	1-162-970-11	CERAMIC CHIP 0.01uF 10%	25V	C48	1-162-907-11	CERAMIC CHIP 2PF 0.25PF	50V
C9	1-126-157-11	ELECT 10uF 20%	16V	C49	1-164-471-11	CERAMIC CHIP 680PF 5%	50V
C10	1-162-908-11	CERAMIC CHIP 3PF 0.25PF	50V	C50	1-162-921-11	CERAMIC CHIP 33PF 5%	50V
C11	1-164-185-11	CERAMIC CHIP 13PF 5%	50V	C51	1-162-927-11	CERAMIC CHIP 100PF 5%	50V
C12	1-162-905-11	CERAMIC CHIP 1PF 0.25PF	50V	C52	1-162-927-11	CERAMIC CHIP 100PF 5%	50V
C13	1-162-911-11	CERAMIC CHIP 6PF 0.5PF	50V	C53	1-162-970-11	CERAMIC CHIP 0.01uF 10%	25V
C14	1-162-975-11	CERAMIC CHIP 24PF 5%	50V	C54	1-162-957-11	CERAMIC CHIP 220PF 5%	50V
C15	1-162-970-11	CERAMIC CHIP 0.01uF 10%	25V	C55	1-126-157-11	ELECT 10uF 20%	16V
C16	1-115-156-11	CERAMIC CHIP 1uF	10V	C56	1-162-970-11	CERAMIC CHIP 0.01uF 10%	25V
C17	1-162-970-11	CERAMIC CHIP 0.01uF 10%	25V	C57	1-124-259-11	ELECT 4.7uF 20%	16V
C18	1-115-156-11	CERAMIC CHIP 1uF	10V	C58	1-126-157-11	ELECT 10uF 20%	16V
C19	1-115-156-11	CERAMIC CHIP 1uF	10V	C59	1-162-970-11	CERAMIC CHIP 0.01uF 10%	25V
C20	1-162-970-11	CERAMIC CHIP 0.01uF 10%	25V	C60	1-162-970-11	CERAMIC CHIP 0.01uF 10%	25V
C21	1-126-157-11	ELECT 10uF 20%	16V	C61	1-124-259-11	ELECT 4.7uF 20%	16V
C22	1-162-970-11	CERAMIC CHIP 0.01uF 10%	25V	C62	1-115-156-11	CERAMIC CHIP 1uF	10V
C23	1-162-970-11	CERAMIC CHIP 0.01uF 10%	25V	C63	1-126-157-11	ELECT 10uF 20%	16V
C24	1-162-924-11	CERAMIC CHIP 56PF 5%	50V	C64	1-124-584-00	ELECT 100uF 20%	10V
C25	1-162-970-11	CERAMIC CHIP 0.01uF 10%	25V	C65	1-115-156-11	CERAMIC CHIP 1uF	10V
C26	1-162-970-11	CERAMIC CHIP 0.01uF 10%	25V	C66	1-164-227-11	CERAMIC CHIP 0.022uF 10%	25V
C27	1-164-361-11	CERAMIC CHIP 0.047uF	16V	C67	1-164-227-11	CERAMIC CHIP 0.022uF 10%	25V
C28	1-164-156-11	CERAMIC CHIP 0.1uF	25V	C68	1-115-156-11	CERAMIC CHIP 1uF	10V
C29	1-162-966-11	CERAMIC CHIP 0.0022uF 10%	50V	C69	1-165-176-11	CERAMIC CHIP 0.047uF 10%	16V
C30	1-126-157-11	ELECT 10uF 20%	16V	C70	1-165-176-11	CERAMIC CHIP 0.047uF 10%	16V
				C71	1-115-156-11	CERAMIC CHIP 1uF	10V
				C72	1-115-156-11	CERAMIC CHIP 1uF	10V
				C73	1-115-156-11	CERAMIC CHIP 1uF	10V
				C74	1-124-259-11	ELECT 4.7uF 20%	16V
				C75	1-110-563-11	CERAMIC CHIP 0.068uF 10%	16V

MAIN

Ref. No.	Part No.	Description	Remark	Ref. No.	Part No.	Description	Remark
C76	1-110-563-11	CERAMIC CHIP	0.068uF 10% 16V	D12	8-719-988-61	DIODE 1SS355TE-17	
C77	1-115-156-11	CERAMIC CHIP	1uF 10V	D13	8-719-988-61	DIODE 1SS355TE-17	
C78	1-126-157-11	ELECT	10uF 20% 16V	D14	8-719-977-40	DIODE UDZ-TE-17-13B	
C79	1-115-156-11	CERAMIC CHIP	1uF 10V	D15	8-719-988-61	DIODE 1SS355TE-17	
C80	1-115-156-11	CERAMIC CHIP	1uF 10V	D16	8-719-988-61	DIODE 1SS355TE-17	
C81	1-164-505-11	CERAMIC CHIP	2.2uF 16V	D17	8-719-975-40	DIODE RB411D	
C82	1-115-156-11	CERAMIC CHIP	1uF 10V	D18	8-719-988-61	DIODE 1SS355TE-17	
C83	1-128-057-11	ELECT	330uF 20% 6.3V			< IC >	
C84	1-126-935-11	ELECT	470uF 20% 6.3V	IC1	8-752-050-20	IC CXA1238S	
C85	1-115-156-11	CERAMIC CHIP	1uF 10V	IC2	8-752-059-51	IC CXA1522P	
C86	1-164-505-11	CERAMIC CHIP	2.2uF 16V	IC3	8-759-804-76	IC LA5002M	
C87	1-126-153-11	ELECT	22uF 20% 6.3V			< JACK >	
C88	1-104-664-11	ELECT	47uF 20% 10V	J1	1-566-891-11	JACK (♁)	
C89	1-164-156-11	CERAMIC CHIP	0.1uF 25V	J2	1-580-681-21	JACK, DC (POLARITY UNIFIED TYPE)	(DC IN 4.5V)
C90	1-124-259-11	ELECT	4.7uF 20% 16V			< JUMPER RESISTOR >	
C91	1-126-157-11	ELECT	10uF 20% 16V	JC1	1-216-295-00	SHORT	0
C92	1-164-156-11	CERAMIC CHIP	0.1uF 25V	JC2	1-216-296-00	SHORT	0
C93	1-162-970-11	CERAMIC CHIP	0.01uF 10% 25V	JC3	1-216-295-00	SHORT	0
C94	1-164-346-11	CERAMIC CHIP	1uF 16V	JC4	1-216-296-00	SHORT	0
C95	1-164-346-11	CERAMIC CHIP	1uF 16V	JC5	1-216-296-00	SHORT	0
C96	1-162-915-11	CERAMIC CHIP	10PF 0.5PF 50V	JC6	1-216-296-00	SHORT	0
C97	1-164-156-11	CERAMIC CHIP	0.1uF 25V	JC7	1-216-295-00	SHORT	0
C98	1-115-156-11	CERAMIC CHIP	1uF 10V	JC8	1-216-295-00	SHORT	0
C99	1-124-589-11	ELECT	47uF 20% 16V	JC9	1-216-296-00	SHORT	0
C100	1-126-157-11	ELECT	10uF 20% 16V	JC10	1-216-296-00	SHORT	0
C101	1-162-970-11	CERAMIC CHIP	0.01uF 10% 25V	JC11	1-216-296-00	SHORT	0
C102	1-162-970-11	CERAMIC CHIP	0.01uF 10% 25V	JC12	1-216-295-00	SHORT	0
		< FILTER >		JC13	1-216-295-00	SHORT	0
CF1	1-577-687-11	FILTER, CERAMIC (10.7MHz)		JC14	1-216-296-00	SHORT	0
CF2	1-577-601-11	FILTER, CERAMIC		JC15	1-216-296-00	SHORT	0
CF3	1-760-238-11	FILTER, CERAMIC		JC16	1-216-296-00	SHORT	0
CF4	1-760-238-11	FILTER, CERAMIC		JC17	1-216-295-00	SHORT	0
		< CONNECTOR >		JC18	1-216-296-00	SHORT	0
CN1	1-691-050-21	HOUSING, CONNECTOR 18P		JC19	1-216-295-00	SHORT	0
		< TRIMMER >		JC20	1-216-296-00	SHORT	0
CT1	1-141-304-21	CAP, TRIMMER 10PF		JC21	1-216-864-11	METAL CHIP	0 5% 1/16W
		< DIODE >		JC22	1-216-864-11	METAL CHIP	0 5% 1/16W
D1	8-719-800-76	DIODE 1SS226				< COIL >	
D2	8-719-421-40	DIODE MA77		L1	1-412-939-11	INDUCTOR	1uH
D3	8-719-421-40	DIODE MA77		L2	1-412-947-11	INDUCTOR	4.7uH
D4	8-719-421-40	DIODE MA77		L3	1-412-938-11	INDUCTOR	0.82uH
D5	8-719-421-40	DIODE MA77		L4	1-412-963-11	INDUCTOR	100uH
D6	8-719-421-40	DIODE MA77		L5	1-412-945-11	INDUCTOR	3.3uH
D7	8-719-421-40	DIODE MA77		L6	1-412-947-11	INDUCTOR	4.7uH
D8	8-719-945-31	DIODE SVC341-L		L7	1-412-939-11	INDUCTOR	1uH
D9	8-719-988-61	DIODE 1SS355TE-17		L8	1-412-947-11	INDUCTOR	4.7uH
D10	8-719-002-81	DIODE 1T363		L9	1-412-939-11	INDUCTOR	1uH
D11	8-719-002-81	DIODE 1T363		L10	1-412-939-11	INDUCTOR	1uH

Ref. No.	Part No.	Description	Remark	Ref. No.	Part No.	Description	Remark
L11	1-402-815-11	COIL (WITH CORE) (FM RF)		R2	1-216-837-11	METAL CHIP 22K	5% 1/16W
L12	1-412-925-11	INDUCTOR 68nH		R3	1-216-857-11	METAL CHIP 1M	5% 1/16W
L13	1-406-786-11	COIL, FM (OSC)		R4	1-216-827-11	METAL CHIP 3.3K	5% 1/16W
L14	1-412-963-11	INDUCTOR 100uH		R5	1-216-845-11	METAL CHIP 100K	5% 1/16W
L15	1-412-939-11	INDUCTOR 1uH		R6	1-216-797-11	METAL CHIP 10	5% 1/16W
L16	1-412-951-11	INDUCTOR 10uH		R7	1-216-817-11	METAL CHIP 470	5% 1/16W
L17	1-412-955-11	INDUCTOR 22uH		R8	1-216-837-11	METAL CHIP 22K	5% 1/16W
L18	1-412-963-11	INDUCTOR 100uH		R9	1-216-837-11	METAL CHIP 22K	5% 1/16W
L19	1-412-963-11	INDUCTOR 100uH		R10	1-216-841-11	METAL CHIP 47K	5% 1/16W
L20	1-410-294-11	INDUCTOR 38uH		R11	1-216-839-11	METAL CHIP 33K	5% 1/16W
L21	1-412-939-11	INDUCTOR 1uH		R12	1-216-845-11	METAL CHIP 100K	5% 1/16W
		< TRANSISTOR >		R13	1-216-829-11	METAL CHIP 4.7K	5% 1/16W
Q1	8-729-423-52	TRANSISTOR 2SC3931-C		R14	1-216-837-11	METAL CHIP 22K	5% 1/16W
Q2	8-729-402-32	TRANSISTOR 2SD1819A-R		R15	1-216-809-11	METAL CHIP 100	5% 1/16W
Q3	8-729-123-86	FET 2SK238-K16		R16	1-216-819-11	METAL CHIP 680	5% 1/16W
Q4	8-729-402-32	TRANSISTOR 2SD1819A-R		R17	1-216-841-11	METAL CHIP 47K	5% 1/16W
Q5	8-729-116-64	FET 2SK508-K51		R18	1-216-832-11	METAL CHIP 8.2K	5% 1/16W
Q6	8-729-423-52	TRANSISTOR 2SC3931-C		R19	1-216-845-11	METAL CHIP 100K	5% 1/16W
Q7	8-729-423-52	TRANSISTOR 2SC3931-C		R20	1-216-817-11	METAL CHIP 470	5% 1/16W
Q8	8-729-402-32	TRANSISTOR 2SD1819A-R		R21	1-216-845-11	METAL CHIP 100K	5% 1/16W
Q9	8-729-423-52	TRANSISTOR 2SC3931-C		R22	1-216-849-11	METAL CHIP 220K	5% 1/16W
Q10	8-729-034-58	TRANSISTOR 2SC4555-6.7-TL		R23	1-216-839-11	METAL CHIP 33K	5% 1/16W
Q11	8-729-123-86	FET 2SK238-K16		R24	1-216-845-11	METAL CHIP 100K	5% 1/16W
Q12	8-729-029-15	TRANSISTOR DTC144TUA-T106		R25	1-216-805-11	METAL CHIP 47	5% 1/16W
Q13	8-729-029-15	TRANSISTOR DTC144TUA-T106		R26	1-216-817-11	METAL CHIP 470	5% 1/16W
Q14	8-729-028-74	TRANSISTOR DTA114TUA-T106		R27	1-216-833-11	RES-CHIP 10K	5% 1/16W
Q15	8-729-028-74	TRANSISTOR DTA114TUA-T106		R28	1-216-813-11	METAL CHIP 220	5% 1/16W
Q16	8-729-403-24	TRANSISTOR XN4210		R29	1-216-837-11	METAL CHIP 22K	5% 1/16W
Q17	8-729-423-52	TRANSISTOR 2SC3931-C		R30	1-216-797-11	METAL CHIP 10	5% 1/16W
Q18	8-729-208-47	FET 2SK210-GR		R31	1-216-805-11	METAL CHIP 47	5% 1/16W
Q19	8-729-220-93	FET 2SK209-G		R32	1-216-797-11	METAL CHIP 10	5% 1/16W
Q20	8-729-051-84	TRANSISTOR XN015010R1SO		R33	1-216-801-11	METAL CHIP 22	5% 1/16W
Q21	8-729-029-15	TRANSISTOR DTC144TUA-T106		R34	1-216-833-11	RES-CHIP 10K	5% 1/16W
Q22	8-729-423-52	TRANSISTOR 2SC3931-C		R35	1-216-837-11	METAL CHIP 22K	5% 1/16W
Q23	8-729-423-52	TRANSISTOR 2SC3931-C		R36	1-216-857-11	METAL CHIP 1M	5% 1/16W
Q24	8-729-423-52	TRANSISTOR 2SC3931-C		R37	1-216-809-11	METAL CHIP 100	5% 1/16W
Q25	8-729-403-24	TRANSISTOR XN4210		R38	1-216-841-11	METAL CHIP 47K	5% 1/16W
Q26	8-729-028-74	TRANSISTOR DTA114TUA-T106		R39	1-216-797-11	METAL CHIP 10	5% 1/16W
Q27	8-729-028-92	TRANSISTOR DTA144TUA-T106		R40	1-216-835-11	METAL CHIP 15K	5% 1/16W
Q28	8-729-800-71	TRANSISTOR 2SB815B7-TB		R41	1-216-825-11	METAL CHIP 2.2K	5% 1/16W
Q29	8-729-800-71	TRANSISTOR 2SB815B7-TB		R42	1-216-817-11	METAL CHIP 470	5% 1/16W
Q30	8-729-402-32	TRANSISTOR 2SD1819A-R		R43	1-216-841-11	METAL CHIP 47K	5% 1/16W
Q31	8-729-402-32	TRANSISTOR 2SD1819A-R		R44	1-216-845-11	METAL CHIP 100K	5% 1/16W
Q32	8-729-800-71	TRANSISTOR 2SB815B7-TB		R45	1-216-845-11	METAL CHIP 100K	5% 1/16W
Q33	8-729-402-32	TRANSISTOR 2SD1819A-R		R46	1-216-827-11	METAL CHIP 3.3K	5% 1/16W
Q34	8-729-029-15	TRANSISTOR DTC144TUA-T106		R47	1-216-837-11	METAL CHIP 22K	5% 1/16W
Q35	8-729-800-71	TRANSISTOR 2SB815B7-TB		R48	1-216-813-11	METAL CHIP 220	5% 1/16W
Q36	8-729-029-15	TRANSISTOR DTC144TUA-T106		R49	1-216-813-11	METAL CHIP 220	5% 1/16W
		< RESISTOR >		R50	1-216-809-11	METAL CHIP 100	5% 1/16W
R1	1-216-821-11	METAL CHIP 1K	5% 1/16W	R51	1-216-841-11	METAL CHIP 47K	5% 1/16W
				R52	1-216-825-11	METAL CHIP 2.2K	5% 1/16W
				R53	1-216-819-11	METAL CHIP 680	5% 1/16W
				R54	1-216-813-11	METAL CHIP 220	5% 1/16W

MAIN











MICON

Ref. No.	Part No.	Description	Remark
R55	1-216-833-11	RES-CHIP 10K	5% 1/16W
R56	1-216-849-11	METAL CHIP 220K	5% 1/16W
R57	1-216-829-11	METAL CHIP 4.7K	5% 1/16W
R58	1-216-057-00	METAL CHIP 2.2K	5% 1/10W
R59	1-216-797-11	METAL CHIP 10	5% 1/16W
R60	1-216-829-11	METAL CHIP 4.7K	5% 1/16W
R61	1-216-829-11	METAL CHIP 4.7K	5% 1/16W
R62	1-216-841-11	METAL CHIP 47K	5% 1/16W
R63	1-216-825-11	METAL CHIP 2.2K	5% 1/16W
R64	1-216-849-11	METAL CHIP 220K	5% 1/16W
R65	1-216-837-11	METAL CHIP 22K	5% 1/16W
R66	1-216-825-11	METAL CHIP 2.2K	5% 1/16W
R67	1-216-821-11	METAL CHIP 1K	5% 1/16W
R68	1-216-829-11	METAL CHIP 4.7K	5% 1/16W
R69	1-216-805-11	METAL CHIP 47	5% 1/16W
R70	1-216-829-11	METAL CHIP 4.7K	5% 1/16W
R71	1-216-805-11	METAL CHIP 47	5% 1/16W
R72	1-216-809-11	METAL CHIP 100	5% 1/16W
R73	1-216-809-11	METAL CHIP 100	5% 1/16W
R74	1-216-829-11	METAL CHIP 4.7K	5% 1/16W
R75	1-216-833-11	RES-CHIP 10K	5% 1/16W
R76	1-216-821-11	METAL CHIP 1K	5% 1/16W
R77	1-216-841-11	METAL CHIP 47K	5% 1/16W
R78	1-216-845-11	METAL CHIP 100K	5% 1/16W
R79	1-216-845-11	METAL CHIP 100K	5% 1/16W
R80	1-216-825-11	METAL CHIP 2.2K	5% 1/16W
R81	1-216-829-11	METAL CHIP 4.7K	5% 1/16W
R82	1-216-841-11	METAL CHIP 47K	5% 1/16W
R83	1-216-825-11	METAL CHIP 2.2K	5% 1/16W
R84	1-216-809-11	METAL CHIP 100	5% 1/16W
R85	1-216-821-11	METAL CHIP 1K	5% 1/16W
		< VARIABLE RESISTOR >	
RV1	1-227-175-11	RES, VAR, CARBON 20K	(MIN↔MAX (ATT ON))
RV2	1-241-765-11	RES, ADJ, CARBON 22K	
RV3	1-227-174-11	RES, VAR, CARBON 50K	(▲ VOL)
		< SWITCH >	
S1	1-572-552-11	SWITCH, SLIDE (ATT ON...OFF)	
S2	1-572-552-11	SWITCH, SLIDE (TONE NEWS...MUSIC)	
		< TRANSFORMER >	
T1	1-404-764-11	TRANSFORMER, IF	
T2	1-411-760-11	COIL (MW/LW RF)	
T3	1-419-539-11	COIL, OSCILLATION	
T4	1-404-444-31	TRANSFORMER, IF	
T5	1-435-410-11	TRANSFORMER, DC-DC CONVERTER	
		< VIBRATOR >	
X1	1-760-018-21	VIBRATOR, CRYSTAL (10.25MHz)	

Ref. No.	Part No.	Description	Remark
*	A-3663-471-A	MICON BOARD, COMPLETE	*****
	1-792-459-11	CABLE, FLAT (FFC) 18P	
*	3-042-894-01	CASE (LCD)	
*	3-042-895-01	CASE (MICROCOMPUTER)	
	3-042-906-01	HOLDER (LCD)	
	3-042-908-01	KNOB (HOLD)	
	3-042-913-01	SHEET (LCD)	
	3-044-853-01	SHEET (4 X 15)	
	3-045-127-01	LEAF (MICRO COMPUTER), COPPER	
	3-045-971-01	LEAF (LCD), COPPER	
	3-047-311-01	SPACER (T)	
		< CAPACITOR >	
C201	1-164-362-11	CERAMIC CHIP 470PF	5% 50V
C202	1-136-177-00	MYLAR 1uF	5% 50V
C203	1-162-970-11	CERAMIC CHIP 0.01uF	10% 25V
C204	1-162-964-11	CERAMIC CHIP 0.001uF	10% 50V
C205	1-162-970-11	CERAMIC CHIP 0.01uF	10% 25V
C206	1-162-970-11	CERAMIC CHIP 0.01uF	10% 25V
C207	1-162-970-11	CERAMIC CHIP 0.01uF	10% 25V
C208	1-162-927-11	CERAMIC CHIP 100PF	5% 50V
C209	1-162-927-11	CERAMIC CHIP 100PF	5% 50V
C210	1-162-927-11	CERAMIC CHIP 100PF	5% 50V
C211	1-162-927-11	CERAMIC CHIP 100PF	5% 50V
C212	1-162-927-11	CERAMIC CHIP 100PF	5% 50V
C213	1-162-927-11	CERAMIC CHIP 100PF	5% 50V
C214	1-162-927-11	CERAMIC CHIP 100PF	5% 50V
C215	1-162-927-11	CERAMIC CHIP 100PF	5% 50V
C216	1-115-156-11	CERAMIC CHIP 1uF	10V
C217	1-115-156-11	CERAMIC CHIP 1uF	10V
C218	1-164-156-11	CERAMIC CHIP 0.1uF	25V
C220	1-162-927-11	CERAMIC CHIP 100PF	5% 50V
C221	1-162-927-11	CERAMIC CHIP 100PF	5% 50V
C222	1-162-927-11	CERAMIC CHIP 100PF	5% 50V
C223	1-162-970-11	CERAMIC CHIP 0.01uF	10% 25V
C224	1-162-964-11	CERAMIC CHIP 0.001uF	10% 50V
C225	1-162-638-11	CERAMIC CHIP 1uF	16V
C226	1-164-156-11	CERAMIC CHIP 0.1uF	25V
C227	1-162-925-11	CERAMIC CHIP 68PF	5% 50V
C228	1-162-917-11	CERAMIC CHIP 15PF	5% 50V
C229	1-164-156-11	CERAMIC CHIP 0.1uF	25V
C230	1-164-156-11	CERAMIC CHIP 0.1uF	25V
C231	1-163-021-11	CERAMIC CHIP 0.01uF	10% 50V
C232	1-164-156-11	CERAMIC CHIP 0.1uF	25V
C233	1-162-970-11	CERAMIC CHIP 0.01uF	10% 25V
C234	1-126-166-11	ELECT 2200uF	5.5V
C235	1-124-589-11	ELECT 47uF	20% 16V
C236	1-115-156-11	CERAMIC CHIP 1uF	10V
C237	1-163-009-11	CERAMIC CHIP 0.001uF	10% 50V
C238	1-162-927-11	CERAMIC CHIP 100PF	5% 50V
C239	1-162-964-11	CERAMIC CHIP 0.001uF	10% 50V

Ref. No.	Part No.	Description	Remark	Ref. No.	Part No.	Description	Remark
		< CONNECTOR >				< TRANSISTOR >	
* CN201	1-691-077-21	HOUSING, CONNECTOR 18P		Q201	8-729-220-93	FET 2SK209-G	
		< DIODE >		Q202	8-729-402-32	TRANSISTOR 2SD1819A-R	
D201	8-719-941-86	DIODE DAN202U		Q203	8-729-220-93	FET 2SK209-G	
D202	8-719-941-86	DIODE DAN202U		Q204	8-729-423-52	TRANSISTOR 2SC3931-C	
D203	8-719-941-86	DIODE DAN202U		Q205	8-729-028-92	TRANSISTOR DTA144TUA-T106	
D204	8-719-941-04	DIODE SB007-03CP		Q206	8-729-402-32	TRANSISTOR 2SD1819A-R	
D205	8-719-980-90	LED SLP381F-51-AB (BACK LIGHT)		Q207	8-729-402-32	TRANSISTOR 2SD1819A-R	
		< IC >				< RESISTOR >	
D206	8-719-941-04	DIODE SB007-03CP		R201	1-216-821-11	METAL CHIP 1K	5% 1/16W
D207	8-719-988-61	DIODE 1SS355TE-17		R202	1-216-829-11	METAL CHIP 4.7K	5% 1/16W
D208	8-719-941-04	DIODE SB007-03CP		R203	1-216-831-11	METAL CHIP 6.8K	5% 1/16W
IC201	8-759-665-46	IC uPD17072GB-017-1A7		R204	1-216-833-11	RES-CHIP 10K	5% 1/16W
IC202	8-759-457-68	IC AK93C45AV-L		R205	1-216-831-11	METAL CHIP 6.8K	5% 1/16W
IC203	8-759-662-77	IC RN5RL27AA-TR		R206	1-216-809-11	METAL CHIP 100	5% 1/16W
IC204	8-759-662-79	IC R3111Q271A-TR		R207	1-216-813-11	METAL CHIP 220	5% 1/16W
IC205	8-759-662-78	IC R3111Q331A-TR		R208	1-216-837-11	METAL CHIP 22K	5% 1/16W
		< JUMPER RESISTOR >		R209	1-216-805-11	METAL CHIP 47	5% 1/16W
JC201	1-216-296-00	SHORT 0		R210	1-216-857-11	METAL CHIP 1M	5% 1/16W
JC202	1-216-296-00	SHORT 0		R211	1-216-857-11	METAL CHIP 1M	5% 1/16W
JC203	1-216-295-00	SHORT 0		R212	1-216-845-11	METAL CHIP 100K	5% 1/16W
JC204	1-216-296-00	SHORT 0		R213	1-216-821-11	METAL CHIP 1K	5% 1/16W
JC205	1-216-296-00	SHORT 0		R214	1-216-821-11	METAL CHIP 1K	5% 1/16W
JC206	1-216-296-00	SHORT 0		R215	1-216-821-11	METAL CHIP 1K	5% 1/16W
JC207	1-216-296-00	SHORT 0		R216	1-216-821-11	METAL CHIP 1K	5% 1/16W
JC208	1-216-296-00	SHORT 0		R217	1-216-821-11	METAL CHIP 1K	5% 1/16W
JC209	1-216-296-00	SHORT 0		R218	1-216-821-11	METAL CHIP 1K	5% 1/16W
JC210	1-216-296-00	SHORT 0		R219	1-216-821-11	METAL CHIP 1K	5% 1/16W
JC211	1-216-296-00	SHORT 0		R220	1-216-821-11	METAL CHIP 1K	5% 1/16W
JC212	1-216-296-00	SHORT 0		R221	1-216-821-11	METAL CHIP 1K	5% 1/16W
JC213	1-216-295-00	SHORT 0		R222	1-216-821-11	METAL CHIP 1K	5% 1/16W
JC214	1-216-296-00	SHORT 0		R223	1-216-821-11	METAL CHIP 1K	5% 1/16W
JC215	1-216-296-00	SHORT 0		R224	1-216-821-11	METAL CHIP 1K	5% 1/16W
JC216	1-216-296-00	SHORT 0		R225	1-216-821-11	METAL CHIP 1K	5% 1/16W
JC217	1-216-296-00	SHORT 0		R226	1-216-821-11	METAL CHIP 1K	5% 1/16W
JC218	1-216-295-00	SHORT 0		R227	1-216-821-11	METAL CHIP 1K	5% 1/16W
JC219	1-216-296-00	SHORT 0		R228	1-216-821-11	METAL CHIP 1K	5% 1/16W
JC220	1-216-296-00	SHORT 0		R229	1-216-821-11	METAL CHIP 1K	5% 1/16W
JC221	1-216-296-00	SHORT 0		R230	1-216-821-11	METAL CHIP 1K	5% 1/16W
JC222	1-216-296-00	SHORT 0		R231	1-216-833-11	RES-CHIP 10K	5% 1/16W
JC223	1-216-296-00	SHORT 0		R232	1-216-845-11	METAL CHIP 100K	5% 1/16W
JC224	1-216-864-11	METAL CHIP 0	5% 1/16W	R233	1-216-845-11	METAL CHIP 100K	5% 1/16W
		< COIL >		R234	1-216-845-11	METAL CHIP 100K	5% 1/16W
L201	1-412-963-11	INDUCTOR 100uH		R235	1-216-845-11	METAL CHIP 100K	5% 1/16W
L202	1-412-963-11	INDUCTOR 100uH		R236	1-216-845-11	METAL CHIP 100K	5% 1/16W
		< LIQUID CRYSTAL DISPLAY >		R237	1-216-845-11	METAL CHIP 100K	5% 1/16W
LCD201	1-803-943-11	DISPLAY PANEL, LIQUID CRYSTAL		R238	1-216-845-11	METAL CHIP 100K	5% 1/16W
				R239	1-216-845-11	METAL CHIP 100K	5% 1/16W
				R240	1-216-845-11	METAL CHIP 100K	5% 1/16W
				R241	1-216-845-11	METAL CHIP 100K	5% 1/16W
				R242	1-216-845-11	METAL CHIP 100K	5% 1/16W

MICON

Ref. No.	Part No.	Description	Remark	Ref. No.	Part No.	Description	Remark
R243	1-216-845-11	METAL CHIP	100K 5%	1/16W	S215	1-692-444-11	SWITCH, KEY BOARD (SW BAND)
R244	1-216-845-11	METAL CHIP	100K 5%	1/16W	S216	1-553-977-00	SWITCH, SLIDE (HOLD )
R245	1-216-845-11	METAL CHIP	100K 5%	1/16W	S217	1-553-510-11	SWITCH, SLIDE (9K/10K)
R246	1-216-845-11	METAL CHIP	100K 5%	1/16W	S218	1-553-977-00	SWITCH, SLIDE (NORMAL..FINE)
R247	1-216-845-11	METAL CHIP	100K 5%	1/16W	S219	1-692-444-11	SWITCH, KEY BOARD (LIGHT)
R248	1-216-845-11	METAL CHIP	100K 5%	1/16W			< VIBRATOR >
R249	1-216-845-11	METAL CHIP	100K 5%	1/16W	X201	1-767-517-11	VIBRATOR, CRYSTAL (75kHz)
R250	1-216-845-11	METAL CHIP	100K 5%	1/16W			*****
R251	1-216-845-11	METAL CHIP	100K 5%	1/16W			MISCELLANEOUS
R252	1-216-845-11	METAL CHIP	100K 5%	1/16W			*****
R253	1-216-857-11	METAL CHIP	1M 5%	1/16W	31	1-792-459-11	CABLE, FLAT (FFC) 18P
R254	1-216-821-11	METAL CHIP	1K 5%	1/16W	ANT1	1-501-222-81	ANTENNA, TELESCOPIC (FM/SW)
R255	1-216-821-11	METAL CHIP	1K 5%	1/16W	SP1	1-529-645-11	SPEAKER (6.6cm)
R256	1-216-821-11	METAL CHIP	1K 5%	1/16W			*****
R257	1-216-833-11	RES-CHIP	10K 5%	1/16W			ACCESSORIES & PACKING MATERIALS
R259	1-216-809-11	METAL CHIP	100 5%	1/16W			*****
R260	1-216-797-11	METAL CHIP	10 5%	1/16W	3-042-774-01	MANUAL, INSTRUCTION (JAPANESE, ITALIAN, ARABIC) (IT, EA)	
R261	1-216-831-11	METAL CHIP	6.8K 5%	1/16W	3-042-774-11	MANUAL, INSTRUCTION (ENGLISH, FRENCH, GERMAN) (AEP)	
R262	1-216-850-11	METAL CHIP	270K 5%	1/16W	3-042-774-21	MANUAL, INSTRUCTION (SPANISH, PORTUGUESE, DUTCH) (AEP, E, 5E)	
R263	1-216-837-11	METAL CHIP	22K 5%	1/16W	3-042-774-31	MANUAL, INSTRUCTION (SWEDISH, DANISH, FINNISH) (AEP)	
R264	1-216-857-11	METAL CHIP	1M 5%	1/16W	3-042-774-41	MANUAL, INSTRUCTION (ENGLISH, FRENCH, SIMPLIFIED CHINESE) (US, CND, E, 5E, EA)	
R265	1-216-857-11	METAL CHIP	1M 5%	1/16W	3-042-774-51	MANUAL, INSTRUCTION (ENGLISH, RUSSIAN, HUNGARIAN) (EE)	
R266	1-216-845-11	METAL CHIP	100K 5%	1/16W	3-043-151-01	CASE, CARRYING	
R267	1-216-833-11	RES-CHIP	10K 5%	1/16W	3-912-863-06	GUIDE, SHORT WAVE	
R268	1-216-821-11	METAL CHIP	1K 5%	1/16W			
R269	1-216-857-11	METAL CHIP	1M 5%	1/16W			
R270	1-216-857-11	METAL CHIP	1M 5%	1/16W			
R271	1-216-857-11	METAL CHIP	1M 5%	1/16W			
R272	1-216-809-11	METAL CHIP	100 5%	1/16W			
		< SWITCH >					
S201	1-692-444-11	SWITCH, KEY BOARD (2  (MEMORY PRESET PAGE))					
S202	1-692-444-11	SWITCH, KEY BOARD (1  (MEMORY PRESET PAGE))					
S203	1-692-444-11	SWITCH, KEY BOARD (SLEEP (POWER))					
S204	1-692-444-11	SWITCH, KEY BOARD (ON/OFF (POWER))					
S205	1-692-444-11	SWITCH, KEY BOARD (MEMORY SCAN (MEMORY PRESET PAGE))					
S206	1-692-444-11	SWITCH, KEY BOARD (5  (MEMORY PRESET PAGE))					
S207	1-692-444-11	SWITCH, KEY BOARD (4  (MEMORY PRESET PAGE))					
S208	1-692-444-11	SWITCH, KEY BOARD (3  (MEMORY PRESET PAGE))					
S209	1-692-444-11	SWITCH, KEY BOARD (b  (TIMER STANDBY /STANDBY TIME SET STANDBY MEMORY))					
S210	1-692-444-11	SWITCH, KEY BOARD (a  (TIMER STANDBY /STANDBY TIME SET STANDBY MEMORY))					
S211	1-692-444-11	SWITCH, KEY BOARD (BAND)					
S212	1-692-444-11	SWITCH, KEY BOARD (ENTER/CLOCK)					
S213	1-692-444-11	SWITCH, KEY BOARD (-  (TUNE/SCAN/TIME SET))					
S214	1-692-444-11	SWITCH, KEY BOARD ( + (TUNE/SCAN/TIME SET))					